



**HAL**  
open science

# Storage Proteins Accumulation and Aggregation in Developing Wheat Grains

Aussenac Thierry, L Rhazi

► **To cite this version:**

Aussenac Thierry, L Rhazi. Storage Proteins Accumulation and Aggregation in Developing Wheat Grains. Wheat global production, 2018, 978-1-78923-337-7. 10.5772/intechopen.75182 . hal-04295711

**HAL Id: hal-04295711**

**<https://hal.science/hal-04295711v1>**

Submitted on 20 Nov 2023

**HAL** is a multi-disciplinary open access archive for the deposit and dissemination of scientific research documents, whether they are published or not. The documents may come from teaching and research institutions in France or abroad, or from public or private research centers.

L'archive ouverte pluridisciplinaire **HAL**, est destinée au dépôt et à la diffusion de documents scientifiques de niveau recherche, publiés ou non, émanant des établissements d'enseignement et de recherche français ou étrangers, des laboratoires publics ou privés.

Public Domain

# We are IntechOpen, the world's leading publisher of Open Access books Built by scientists, for scientists

3,500

Open access books available

108,000

International authors and editors

1.7 M

Downloads

Our authors are among the

151

Countries delivered to

TOP 1%

most cited scientists

12.2%

Contributors from top 500 universities



WEB OF SCIENCE™

Selection of our books indexed in the Book Citation Index  
in Web of Science™ Core Collection (BKCI)

Interested in publishing with us?  
Contact [book.department@intechopen.com](mailto:book.department@intechopen.com)

Numbers displayed above are based on latest data collected.  
For more information visit [www.intechopen.com](http://www.intechopen.com)



---

# Storage Proteins Accumulation and Aggregation in Developing Wheat Grains

---

Aussenac Thierry and Rhazi Larbi

Additional information is available at the end of the chapter

<http://dx.doi.org/10.5772/intechopen.75182>

---

## Abstract

The aggregative properties of wheat grain prolamins are largely responsible for the technological functionalities of the flours and doughs. The ability of wheat prolamins to form a plastic three-dimensional network during the mixing depends to a large extent on their ability to interact. These aggregative properties, which can be evaluated by measuring their molecular weight distribution, are dependent on the polymorphism of the protein subunits present but also on the environmental conditions that are applied during grain development. Much progress has been made in the last 30 years at a genetic level to better understand and/or to favour the interaction properties of the storage proteins. However, these improvements can be strongly limited by environmental conditions. Any modification of the redox status of the grain cells in response to an oxidative stress can lead to a decrease in the degree of association of the prolamins by limiting the protein-protein interactions during the grain desiccation. Considering the current and projected environmental impacts (i.e. climate change with increasing heat stress), it is essential to better understand these phenomena to implement new breeding strategies for a sustainable quality.

**Keywords:** wheat, storage proteins, aggregation, breadmaking quality

---

## 1. Introduction

During the last 60 years, in the field of cereal chemistry, the scientific community has been working to determine in an ever more precise way, the nature of the constituents responsible for the acquisition of technological properties (i.e. breadmaking properties for common wheat doughs and/or pasta properties in the case of durum wheat). Particular emphasis has been placed on those whose (quantitative and/or qualitative) variations account for observed and measured changes in processing ability.

As early as the 1950s, thanks to very good recombination experiments with flour constituents, Finney [1] confirms that the baking capacity is essentially conferred by gluten. Gluten, which can be defined as a viscoelastic protein complex formed after hydration and the addition of flour, consists of a heterogeneous mixture of prolamins (i.e. gliadins and glutenins) associated with covalent (S-S) and non-covalent bonds (hydrogen, hydrophobic and ionic). The specific role of certain protein fractions (monomer to polymeric proteins ratio) in the different properties of wheat doughs was also highlighted.

During the period 1970–1990, it became clear that the variation of the baking capacity of a flour is based on the ability of its storage proteins (i.e. prolamins) to form, during mixing, a three-dimensional plastic structure (**Figure 1A and B**). This remarkable structure creates a cohesive and viscoelastic network, insoluble in water, ensuring the retention of carbon dioxide, ethanol and aromas, during the fermentation of the dough and unlike other cereals for which these properties are non-existent (**Figure 2**). Thus, a common wheat is all the more breadmaking that its storage proteins have a strong tendency to aggregate into a three-dimensional viscoelastic network during mixing. Thus, gluten is considered a transient network whose mechanical properties depend on the density of the junction zones between the elements that compose it [2].

Since the 1990s, thanks to the integration of many complementary scientific approaches (i.e. molecular biology, biochemistry, analytical chemistry, rheology, etc.), a clearer vision of the transformation processes and the role of the main protein constituents within them have begun to take shape [3]. Thus, attention has been focused on the (polymeric) glutenin fraction because a strong relationship has been established between breadmaking properties, such as mixing time, extensibility and loaf volume and the molecular weight distribution (MWD) of the polymeric protein components [4].

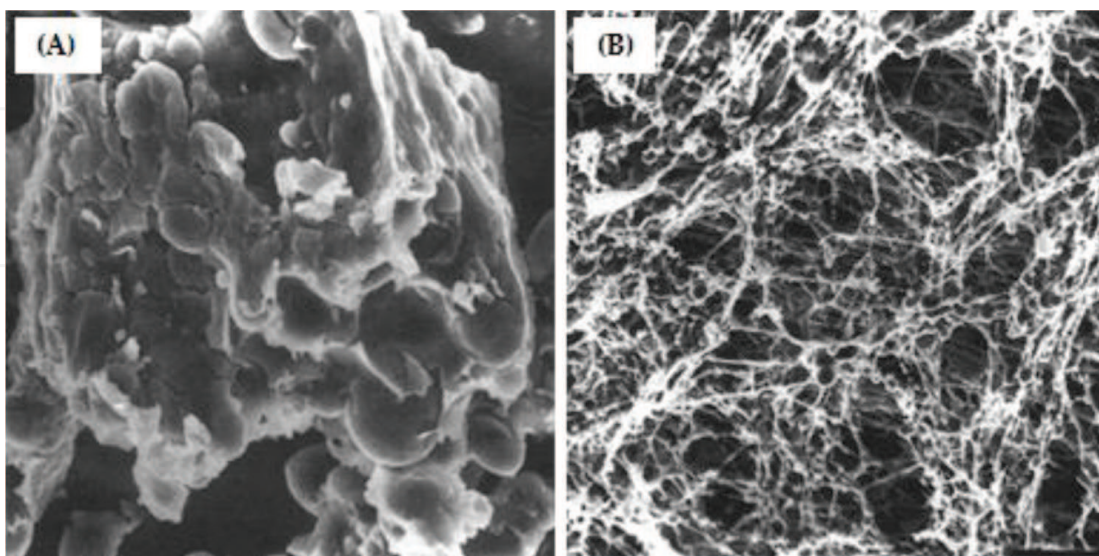

**Figure 1.** Scanning electron micrographs of durum wheat (A) flour and (B) dough particles (From Hoseney and Rogers [3]).

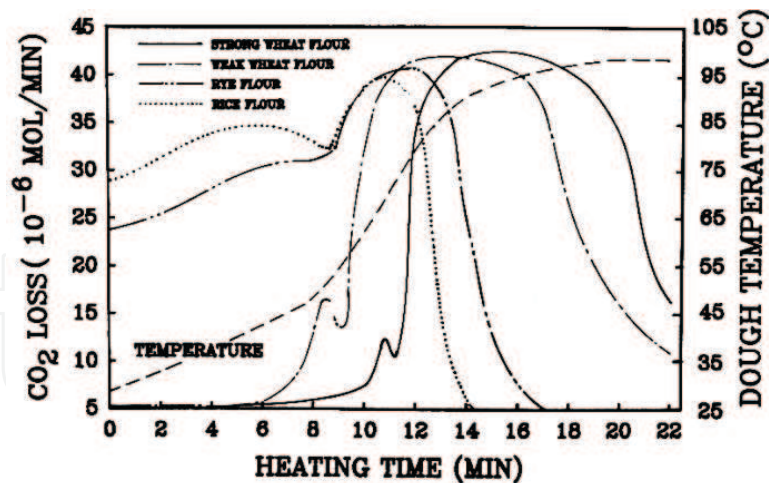

Figure 2. Loss of carbon dioxide and increase in temperature in relation to the heating time for different doughs of different cereal grains (From Hosney and Rogers [3]).

To the extent that any changes (genetically and/or environmentally controlled) in the molecular size and/or aggregation status of these polymeric proteins can potentially result in very significant changes in the technological properties of the products concerned, it is important to understand how they are synthesized and accumulated in grains of wheat during their development. This knowledge is essential if we are to manipulate wheat quality in the future for traditional or new end users.

This chapter reviews the definition of the molecular weight distribution of wheat storage proteins, their changes during grain development and the impacts of environmental factors.

## 2. Molecular weight distribution (MWD) of wheat storage proteins

### 2.1. Classification and polymorphism of wheat grain proteins

Like all grain seeds, wheat grain contains a large number of proteins classified as structural proteins, functional proteins and reserve proteins. They are unequally distributed within the different cell of the grain. A natural gradient of distribution can be highlighted. As a result, the starch to protein ratio significantly increases from the peripheral to the central regions of the grain. Given the relative weight of these different cells, 70–80% (w/w) of the proteins are in the albumen.

The classification system for cereal proteins is mainly based on Osborne's historical work, in 1907 [5], based on their differences in solubility later used in sequential extractions (Table 1). As a result, four major protein fractions have been defined: albumins (soluble in water), globulins (soluble in dilute salt solutions), gliadins (soluble in diluted alcohols, 70% ethanol) and finally, glutenins (residual proteins, partially soluble in diluted acids and bases). Other authors have enriched these classifications based on structural and/or functional properties [6, 7]. Within the large family of the storage proteins (prolamins), two main classes can be



Osborne [5] classification		Shewry et al. [6] classification			Singh and Shepherd [7] classification	
Protein fraction	Solubility	MW (kDa)	Composition	Structure	Gene localization*	Function
Albumins and globulins	Water neutral salts	5–90				Structural and functional proteins
Gliadins	Diluted alcohols	25–75		Monomers		Storage proteins (prolamins)
- $\omega$			Poor in S		<i>Gli-1(1A,1B,1D)S</i>	
- $\alpha$			Reach in S		<i>Gli-2(6A,6B,6D)S</i>	
- $\beta$					<i>Gli-2(6A,6B,6D)S</i>	
- $\gamma$					<i>Gli-1(1A,1B,1D)S</i>	
Glutenins	Acids, bases, reductants, detergents	100 to several millions	Reach in S	Polymers		
- LMW					<i>Glu-3(1A,1B,1D)S</i>	
- HMW					<i>Glu-1(1A,1B,1D)L</i>	

\**Allelic blocks*, wheat homologous chromosomes (noted 1–6), wheat genomes (A, B and D) and chromosome position: (S) short arm, (L) long arm.

**Table 1.** Classification of wheat grain proteins.

differentiated due, to their degree of aggregation/polymerization. Thus, on the one hand, gliadins (soluble monomeric proteins in aqueous alcohols), which represent approximately 30–40% (w/w) of flour proteins and on the other hand, glutenins representing, 40–45% (w/w) of the total flour proteins. The latter are polymeric and aggregated proteins, forming a much more complex material than the gliadins.

Gliadins correspond to a mixture of monomeric proteins of molecular weight between 25 and 75 kDa and are characterized by their richness in glutamine and proline. They represent 45% (w/w) of the total prolamins. There are four classes based on their electrophoretic behaviour (i.e. increasing mobility in acid medium):  $\alpha/\beta$ ,  $\gamma$  and  $\omega$ -gliadins (which, respectively, represent 44–60%, 30–46% and 6–20% of total gliadins) [8].

Glutenins, for their part, represent 40–50% (w/w) of total proteins; they are rich in proline and glutamic acid and their content in basic amino acids is higher than that of gliadins. They constitute a much more complex material formed of an assembly of polypeptide chains, commonly called subunits, linked together mainly by intermolecular disulphide bridges. These subunits have been grouped into two different subgroups: low molecular weight subunits (LMW-GS) and high molecular weight subunits (HMW-GS).

LMW-GS account for an average of two-thirds of total glutenins. They are very polymorphic and have molar masses between 30 and 50 kDa. Given their similarity to some gliadins, these have sometimes been difficult to quantify. HMW-GS, as their name indicates, have higher molecular weights ranging from 95 to 130 kDa. According to their SDS-PAGE migration, they fall into two groups: HMW-GS $\gamma$  (67–74 kDa) and HMW-GS $x$  (83–88 kDa).

Gliadins have a large genetic polymorphism, it has been possible to detect between 20 and 40 different constituents for a wheat variety [9]. Within a class of gliadins, it is possible to find several sub-families depending on the composition and richness of certain amino acids (the  $\omega$ 1 and  $\omega$ 5 gliadins differ in basic amino acids, glutamine and proline, than that  $\gamma$ 1,  $\gamma$ 2 and  $\gamma$ 3 differ in their richness in tyrosine, lysine and methionine). Thus, the polymorphism of gliadins is very important that it serves as a basis for the varietal identification of wheat [10].

The polymorphism of low molecular weight glutenic subunits (LMW-GS) is less important than that of gliadins. For a given variety, there are 7–6 LMW-GS. But 40 different LMW-GS were found in 222 varieties of soft wheat [11]. Finally, high molecular weight glutenic subunits (HMW-GS) are the prolamins that have the lowest polymorphism. The association of two genes at each Glu-A1, Glu-B1 and Glu-D1 locus was noted. The  $x$ -type genes express subunits of masses greater than those encoded by  $y$ -type genes in SDS-PAGE [12]. However, some  $y$ -type HMW-GS (notably subunit 12) have been shown to have important immunochemical similarities with  $\alpha/\beta$  and  $\gamma$ -gliadins [13]. In all cases, recombination between these genes is very rare. The different wheat varieties contain between 3 and 5 HMW-GS. Indeed, 1Ay genes are never expressed, and 1By and 1Ax genes are only expressed in some varieties [14].

The primary structure of the storage proteins is well understood. They comprise three distinct domains (**Figure 3**): a central domain made up of repeated sequences and two domains formed of non-repeated sequences at the ends (i.e. C- and N-terminal). The understanding of these sequences has made it possible to locate particularly important cysteine residues because of their ability to form disulphide bonds (intra and/or intermolecular).  $\alpha$ -,  $\beta$ - and  $\gamma$ -gliadins are provided with cysteines at their C-terminal domains; these all being involved in the formation of intramolecular disulphide bridges. HMW-GS have unpaired cysteine in their C-terminal domain and several others in their N-terminal domain; LMW-GS carrying seven C-terminal cysteines and one N-terminal cysteine. Thanks to these unpaired cysteines, unlike gliadins, HMW-GS and LMW-GS are able to form intermolecular disulphide bridges. Some authors report a globular type structure for the N- and C-terminal and a spiral structure for the repetitive domain (**Figure 3**).

## 2.2. Gliadin to glutenin ratio

Generally, it is accepted that the functional properties of gluten proteins are related to their ability to form a network during technological processes [17, 18]. However, gliadins and glutenins do not have the same effect on the rheological properties of doughs or glutes. Consequently, gliadins explain the viscous nature, while glutenins determine elasticity. In fact, the small quantity of cysteine residues in these storage proteins makes it possible to establish an important structural and functional distribution between gliadins and glutenins (**Figure 4**). For the former, all cysteine residues are involved in the establishment of intramolecular disulphide bridges while for both high and low molecular weight glutenins, a number of cysteines not involved in intramolecular bonds are therefore available to establish intermolecular links with other subunits. Glutenins are therefore likely to constitute polymers with a real consistency, thanks to the formation of intermolecular disulphide bridges, while gliadins remain in the monomeric state. The latter may, however, be aggregated by weak bonds

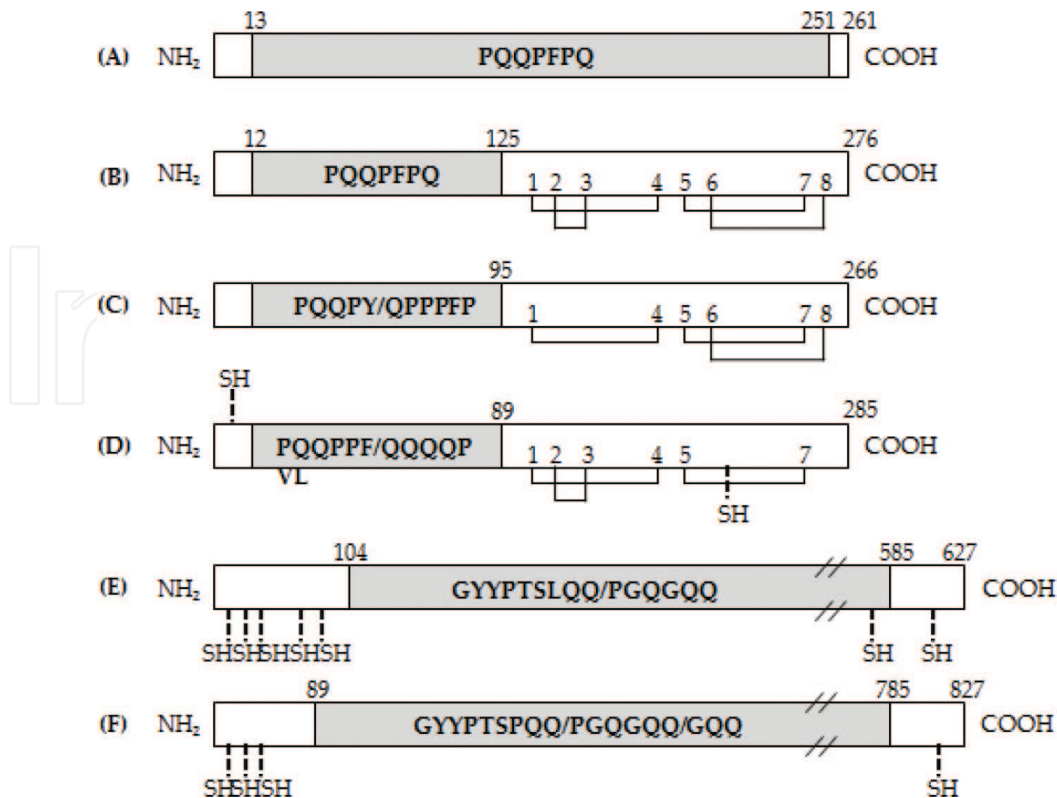

**Figure 3.** Schematic structures of typical primary structures of (A)  $\omega$ -gliadin, (B)  $\alpha$ -gliadin, (C)  $\gamma$ -gliadin, (D) LMW-GS, (E) HMW-GS $\gamma$  and (F) HMW-GS $x$  [15, 16]. Repetitive sequences are shaded and disulphide bonds between conserved cysteine residues (1–8) in the  $\gamma$ -gliadin are shown as lines. SH denotes the positions of cysteine residues in the HMW prolamins. Single letter abbreviations for amino acids: F = phenylalanine; G = glycine; L = leucine; P = proline; Q = glutamine; S = serine; V = valine and Y = tyrosine.

(hydrogen and hydrophobic). The viscoelasticity of gluten depends on its state of polymerization and the interactions between polymers [2].

A large number of conventional fractionation and reconstitution tests have been conducted based on the differential physical properties observed in purified gliadins and glutenins. The aim of these studies was to link variations in molecular weight distribution (i.e. monomer to polymer ratio) with the rheological characteristics of the glutes obtained. In the majority of cases, the results obtained during these different reconstitution studies have demonstrated that the rheological properties of the restructured flours generated are strongly influenced by the ratio of these two protein fractions [20, 21]. With a constant amount of prolamins, the strength of the reconstituted flour, measured at the time of the dough making with a mixer (i.e. peak time value mix (MPT)), is related to the proportion of polymeric proteins.

The development of the original analytical approaches (i.e. high performance liquid chromatography of size exclusion, SEC-HPLC) during the 1980s confirmed the vast majority of these hypothesis, which were essentially based on results obtained from differential solubility protocols (i.e. gliadins vs. glutenins). Thus, many authors [22–29] have confirmed the existence of a significant relationship between the relative amount of glutenin aggregates and the baking quality of many everyday wheat genotypes.



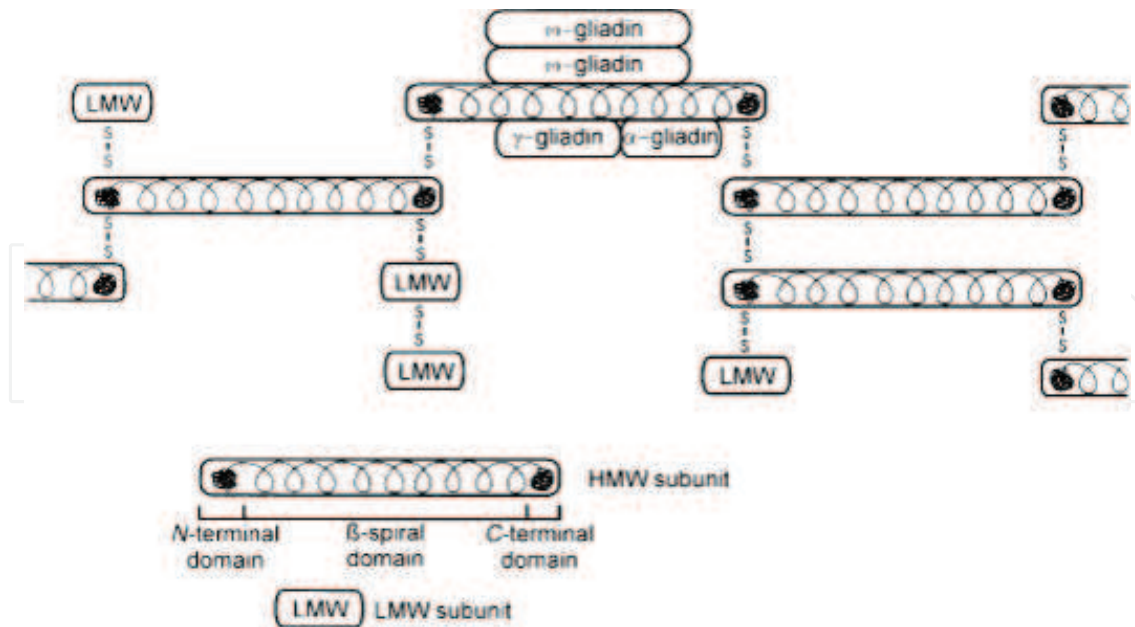

**Figure 4.** A structural model for wheat gluten in which the HMW subunits provide a disulphide-bonded backbone which interacts with other gluten proteins through disulphide bonds (LMW subunits) and non-covalent interactions (gliadins) (From Shewry et al. [19]).

The molecular weight distribution (MWD) of prolamins is becoming recognized as the main determinant of physical dough properties [30, 31]. However, in theory, the MWD can be altered from one sample of wheat (or one cultivar) to another by changes in the relative proportions of monomeric proteins and polymeric proteins (gliadins to glutenins ratio) but also by changes in the size distribution of polymeric proteins [32].

### 2.3. Size distribution of polymeric proteins

Chen and Bushuk [33] revealed that part of the glutenin is soluble in acetic acid thus making the distinction between an insoluble and a soluble fraction. The importance of this distinction became clear when Orth and Bushuk [34] demonstrated a positive correlation between the amount of acetic acid insoluble glutenin and bread loaf volume. From then on, insoluble glutenin became widely recognized as the key protein fraction that can explain differences in dough strength and breadmaking quality [35]. The use of detergents (SDS) and organic solvents (propanol) [36] allowed an even better separation and led to the conclusion that insolubility was due to size and a very high degree of polymerization. Other groups developed methodology with propanol to further separate soluble protein parts from the insoluble glutenin. Currently, two main methods are in use to quantify and characterize this fraction. The first corresponds to the so-called unextractable polymeric protein (UPP) method using propanol and during which unextractable polymeric protein (UPP) fraction is obtained. Upon sonication, this fraction becomes soluble in SDS [28, 29] and can be analysed using size exclusion chromatography [27, 37]. The other method is the SDS method as advanced by Graveland et al. [38] resulting in the SDS-insoluble gel protein fraction. This fraction was renamed glutenin macro polymer (GMP) to reflect its highly aggregated nature [39, 40]. Moonen et al. [41]

found that the SDS-insoluble glutenin-gel protein fraction highly correlated with SDS sedimentation values and loaf volume. Weegels et al. [40, 42] studied this fraction in great detail and presented firm evidence that GMP quantity correlates to bread loaf volume.

In addition to these classical approaches (UPP and/or GMP), new analytical protocols have been developed since the early 2000s to separate and more accurately characterize the molecular size distribution of the polymeric proteins. Flow field-flow fractionation (FFFF) [43–46], which is a new separation technique without any stationary phase, and which is therefore not hampered by a steric exclusion limit [47–49], has been used successfully to separate a number of HMW fractions [50–52]. Furthermore, the MALLS technique which is one of the most effective means of determining molecular weight, size and conformation of glutenin polymers without reference to standards [48, 53–56] has been applied in combination with the A-FFFF method to accurately measure size and conformation of wheat glutenins [57] (Figure 5).

The glutenin association level (i.e. the size distribution) is strongly correlated with the HMW-GS/LMW-GS [58–60] ratio and the nature of the HMW-GS present (especially HMW-GS pair 5 + 10 vs. HMW-GS pair 2 + 12 coded by *Glu-D1*). As demonstrated by the different experimental approaches carried out in recent years [61–64], the different glutenin subunits (i.e. HMW-GS, LMW-GS and HMW-GS  $x$  and  $y$  type) are unequally distributed within polymers. These results demonstrate the existence of a highly ordered structure in which some subunits play a predominant role, notably because of their difference in functionality (i.e. number and especially position of cysteine residues capable of forming intermolecular bonds) [65] (Figure 6).

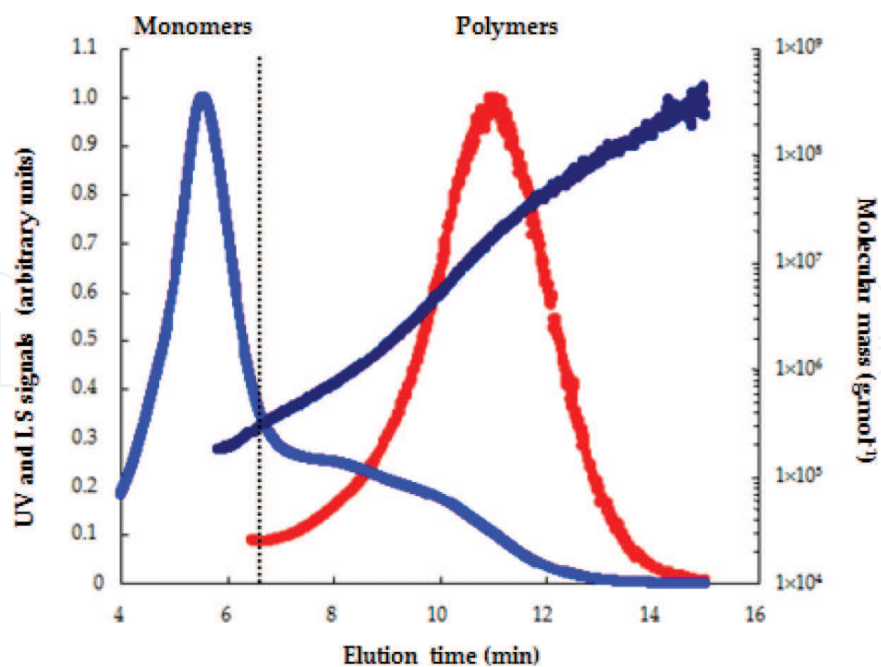

**Figure 5.** Asymmetrical flow field-flow fractionation (A4F) profiles of total solubilized storage proteins of a common French wheat cultivar (Soissons). UV (blue line), light scattering at  $90^\circ$  (red line) and molecular weight in relation to elution time (dark line) (from Lemelin et al. [57]).

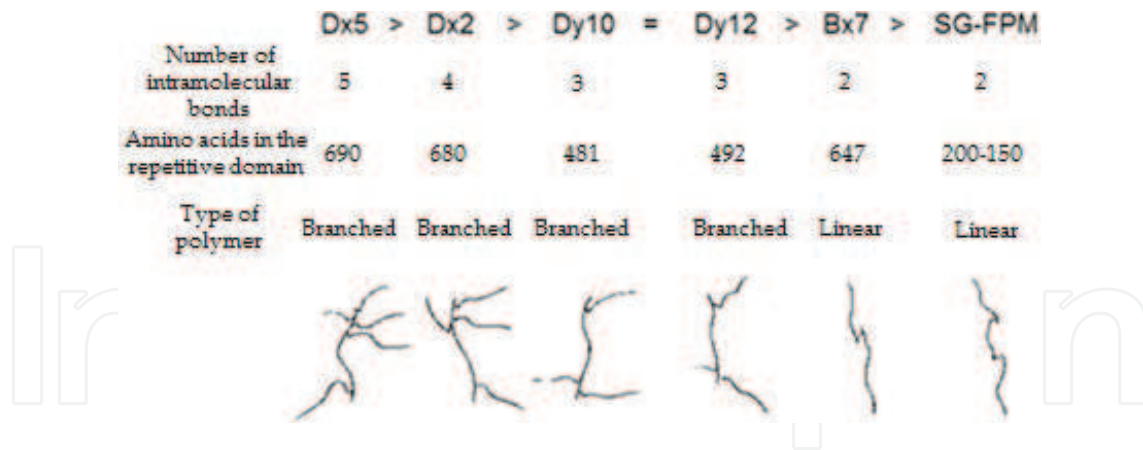

**Figure 6.** Hierarchical arrangement of HMW-GS and LMW-GS in relation to their intrinsic contribution to polymer formation (from Kasarda [65]).

### 3. Accumulation of prolamins in developing wheat grains

#### 3.1. Endosperm development

The development of the wheat endosperm which has been well described at the microscopic level, as reviewed by Bechtel et al. [66], can be quite easily characterized by the study of the temporal variations of several quantitative components of it such as the accumulation of the total dry matter, the water content of the grain and the accumulation of total protein and starch [67] (**Figure 7**).

The accumulation of total dry matter in the grain provides a good insight into the functioning of different accumulation metabolisms (i.e. nitrogen translocation and post-flowering photosynthesis) [68]. Thus, after an initial lag phase (up to 10–15 days after anthesis (DAA)), it is easy to observe a phase of linear accumulation of this dry matter; wheat grains reaching a maximum dry weight from 40 DAA.

During this linear phase, the observed phenomena depend on two main variables: the duration ( $D$ ) and the speed or flux of assimilates towards the grain ( $V$ ), so that the weight of a grain ( $P$ ) is given by the relation  $P = V \times D$  [69].  $D$  can be expressed in days or in the sum of average daily temperatures (i.e. degree-days ( $DD$ )). The filling speed is the limiting factor in the development of the weight of a grain. This speed is mainly by the number of grains per  $m^2$ . Finally, under natural conditions, the duration  $D$  cannot compensate for the weight loss produced by any reduction in the rate of accumulation. The amount of water per grain that gradually increases to about 20 DAA remains relatively constant up to  $\approx 35$  DAA (i.e. “water plateau” phase) before decreasing at harvest time.

The higher the rate of water accumulation in the grain, the greater the height of the “water plateau” and the higher the weight of the grain at maturity [70]. Based on changes in the amount of water and total dry matter per grain after anthesis, three particular phases of grain development can be estimated: the cell division phase, the cell enlargement phase (i.e. grain

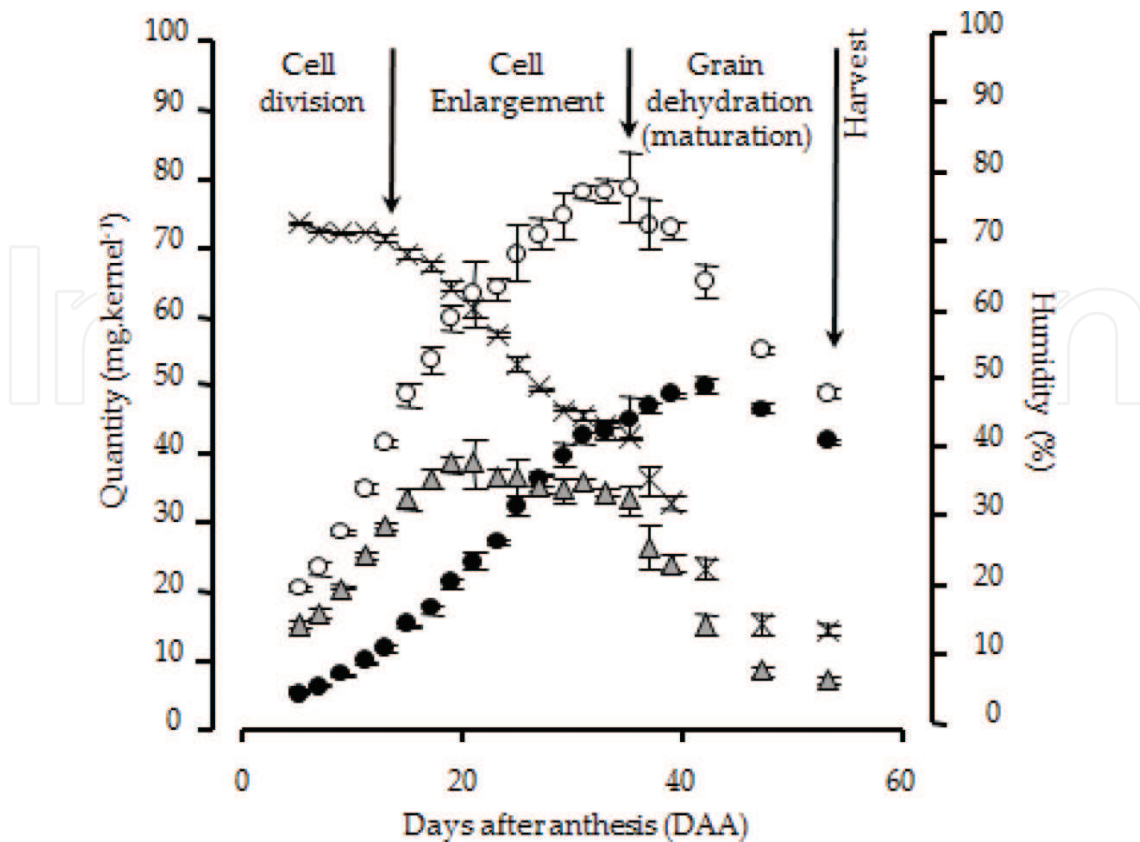

**Figure 7.** Grain filling period for a common wheat cultivar (*Soissons*). Evolution of (●) dry matter per kernel, (○) fresh matter per kernel, (△) water quantity per kernel and (×) grain humidity. The vertical lines represent the standard deviation ( $n = 3$ ) (from Carceller and Aussenac [67]).

filling phase) and the grain desiccation phase (the beginning of this phase corresponding to the acquisition of physiological maturity) [71] during which protein bodies disappear to form the protein matrix [72, 73].

Since 1970s, a great deal of work has been done to evaluate the effects of the environment on grain development. Thus, the effects of several environmental variables (i.e. light, temperature, water availability and nutrient availability), taken individually or in combination, have been studied [74–85]. In general, temperature and water availability strongly affect the filling rate ( $V$ ) and the duration of grain filling ( $D$ ), although some differences in behaviour may exist between wheat genotypes. Consequently, differences in thermal regimes and/or water regimes cause profound changes in the accumulation of the total dry matter ( $P$ ) by affecting indifferently and without compensating the speed and duration of filling [86].

### 3.2. Accumulation of Storage Proteins

The accumulation of different protein fractions (albumins-globulins, gliadins and glutenins) is progressive from flowering until the acquisition of the physiological maturity of the grains ( $\approx 35$ – $40$  DAA). However, even if the time of initiation of the biosynthesis of the different proteins of the grain is not significantly different (5–7 DAA) [87], their rate of accumulation



varies considerably, suggesting a phenomenon of differential regulation of this biosynthesis (Figure 8A and B).

Thus, a certain accumulation asynchrony in the protein fractions of the grain can be highlighted. The albumins-globulins accumulate most rapidly in the grain, followed by the monomeric prolamins and finally the polymeric prolamins. As many researchers have shown [88–93], the accumulation of albumins-globulins is maintained only during the cell division phase, contrary to that of prolamins. This confirms the functional and/or structural role of these specific proteins.

While the ratio between polymeric proteins and monomeric proteins is stable during the first stages of grain development (i.e. cell division and cell enlargement), this ratio increases significantly during the grain desiccation phase (i.e. after 35 DAA) (Figure 8C). A number of results in the literature are quite contradictory [90, 94, 95]. In our opinion, and in accordance with the

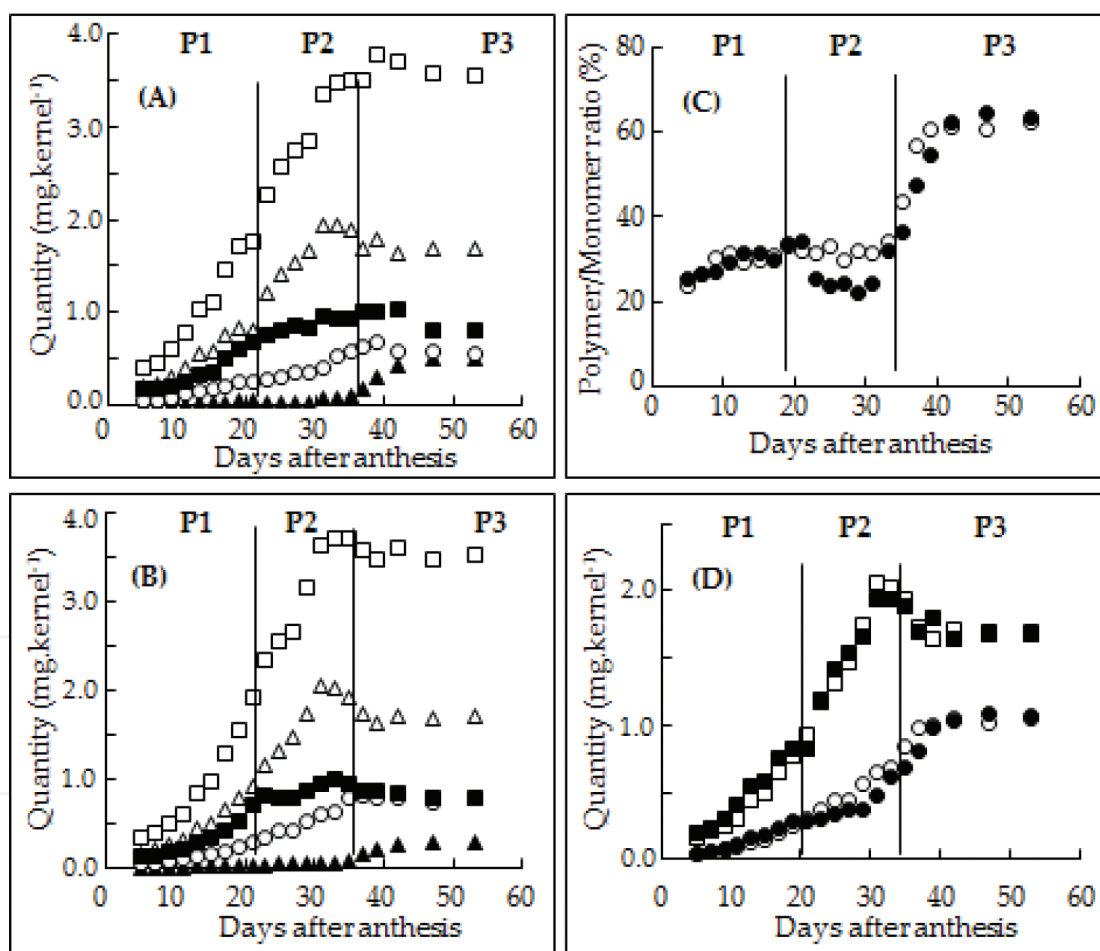

**Figure 8.** Evolution of the quantity of the different protein fractions ( $\text{mg.kernel}^{-1}$ ) for two common French wheat cultivars (A) Soissons and (B) Thésée, as a function of the days after anthesis. (▲) SDS-insoluble polymers; (○) SDS-soluble polymers; (■) albumins and globulins; (△) monomers and (□) total proteins. Evolution of (C) the polymer/monomer ratio (%) and (D) the quantity of monomers and total polymers ( $\text{mg.kernel}^{-1}$ ) as a function of days after anthesis. (○,●) total polymers of Thésée and Soissons, respectively; (□,■) Monomers of Thésée and Soissons, respectively. Stages: (P1) cell division; (P2) cell enlargement and (P3) grain desiccation and maturation (from Carceller and Aussenac [67]).



remarks of Stone and Nicolas [92], most of these differences can be explained by the fact that the methods of extraction and analysis of the polymeric proteins retained are extremely varied from one research group to another; it is therefore certain that all the researchers did not take into account the same protein entities in the calculation of the polymers/monomers ratio.

The accumulation of SDS-soluble polymers that starts very early in the grain (from 7 DAA), is very slow and continues up to the beginning of the drying phase of the grain. The accumulation of SDS-insoluble polymers (i.e. UPP) is, in turn, really visible only when the grain begins to lose its water balance (i.e. end of the “water plateau”) [67, 92, 96] (**Figure 9B**).

These elements must be compared with the observations of researchers such as Woodman and Engledow who, as early as the 1920s, noted the increase in the ability of proteins to form a coherent mass, gluten, in relation to the beginning of the grain desiccation [97]. The accumulation of the protein polymers in the broad sense coincides perfectly with the accumulation of the different glutenin subunits (LMW-GS and HMW-GS) in the grain [91, 98]; the HMW-GS/LMW-GS ratio being an important parameter for differentiating wheat genotypes from each other. For example, in the framework of our own research [67, 99], we have been able to demonstrate that at harvest time, the association state of polymeric proteins (i.e. SDS-insoluble polymers/total polymers ratio) is strongly correlated with the HMW-GS/LMW-GS ratio. Thus, at maturity, with the same total polymer amount (**Figure 9A**), the wheat genotype Soissons, which is characterized by a HMW-GS/LMW-GS ratio twice that of the wheat genotype Thésée, has a SDS-insoluble polymer/total polymer ratio twice as large that of Thésée (**Figure 9B**).

### 3.3. Unextractable polymeric protein (UPP) accumulation

The formation and accumulation of polymeric protein fractions characterized by high levels of aggregation (indifferently qualified in the literature of SDS-insoluble polymeric proteins, unextractable polymeric proteins (UPP) and glutenin macro polymers (GMP)) have been the focus

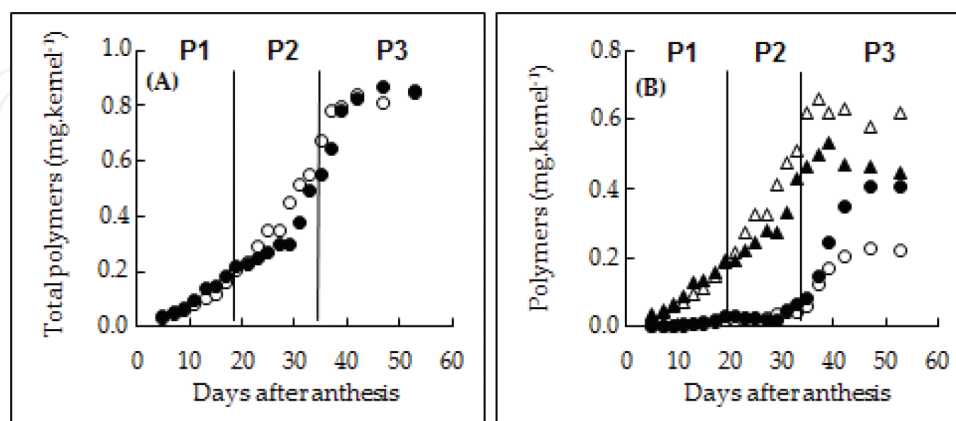

**Figure 9.** Accumulation of total polymers, SDS-soluble and SDS-insoluble polymers as a function of the days after anthesis. (A) Total polymers (mg.kernel<sup>-1</sup>) for (●) Soissons and (○) Thésée. (B) Open symbols are for Thésée and closed symbols are for Soissons. (△) SDS-soluble polymers and (○) SDS-insoluble polymers. Stages: (P1) cell division; (P2) cell enlargement and (P3) grain desiccation and maturation (from Carceller and Aussenac [67]).

of attention during the last 15 years because these fractions became widely recognized as the key protein fraction that can explain differences in dough strength and breadmaking quality.

According to the various physiological observations carried out since the early 2000s [67, 93, 100–102], it appears that the UPP accumulation phase coincides very strongly with the grain desiccation phase (**Figure 9B**), whatever the culture conditions applied (i.e. light, temperature, water availability and nutrient availability). Thus, 95–100% (w/w) of the UPPs present in the grain at harvesting accumulates during the grain desiccation phase. Finally, several experiments of artificial dehydration of wheat grains have confirmed the strong relationship between grain water loss and UPP accumulation [93, 102].

Although today the mechanisms responsible for the formation of UPPs are still the subject of discussions and/or hypotheses, many observations seem to confirm that the strengthening of the aggregation character in these polymeric proteins during grain desiccation results from the reinforcement of intermolecular interactions (mainly covalent interactions) between the different glutenin subunits (HMW-GS and LMW-GS) [103, 104]. This phenomenon has led to a very significant increase in the different molecular dimensions (Mw and Rg) of the glutenin polymers [103].

Studying the function of free glutenin sulfhydryl (SH) and disulphide (SS) groups in glutenins of developing wheat for UPP formation, we showed that the major wheat glutenin subunits residing in the protein bodies undergo redox change during the development and the maturation of the grain [103] (**Figure 10**). Indeed, during the cell division and grain filling,

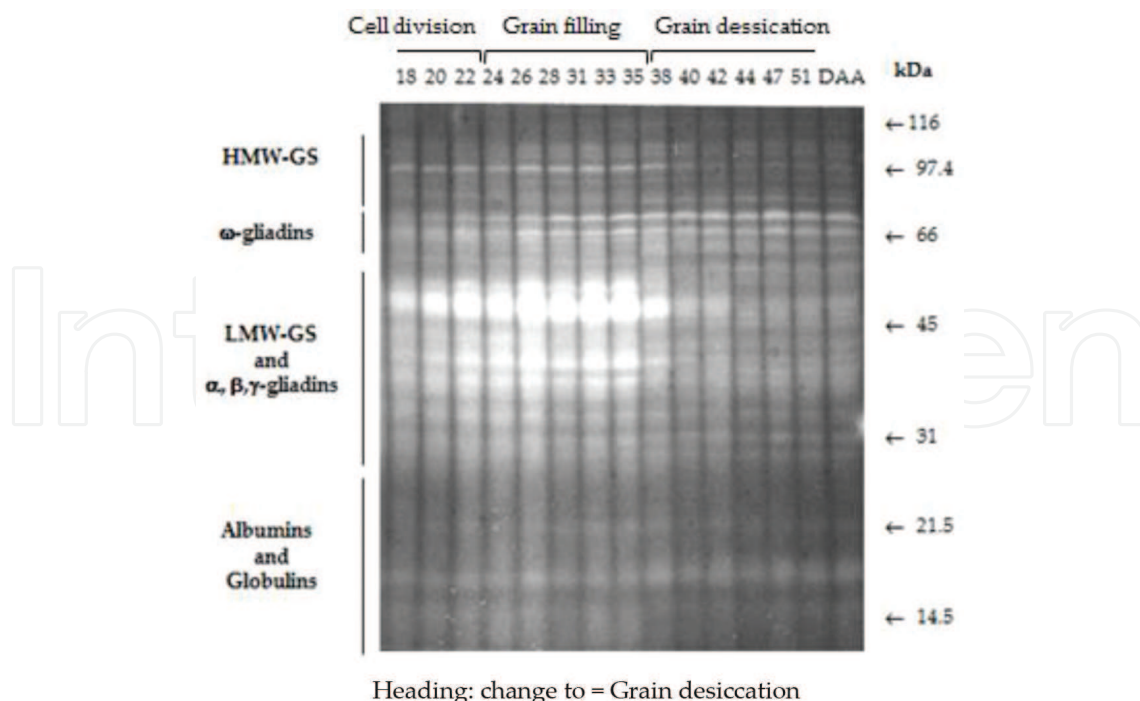

**Figure 10.** Change in sulfhydryl status of wheat proteins during grain development and maturation. MBBBr-derivatized (fluorescence photography) storage proteins of a common French wheat cultivar (Soissons). Days after anthesis (DAA) (from Rhazi et al. [103]).

subunits and particularly LMW-GS have a large amount of free SH groups and become oxidized during grain desiccation which coincided with the accumulation of UPP. Moreover, monobromobimane (mBBBr) derivatized of free glutenin SH groups before the artificial grain desiccation totally inhibits the UPP deposition [104].

In our hypothesis which is very close to the model proposed by Hamer and van Vliet [105] for the gluten structure termed “hyper aggregation” model, the grain desiccation promotes the aggregation of polymers already present (i.e. SDS-soluble polymers or level I aggregates in the “hyper aggregation” model) by facilitating specifically the formation of interchain hydrogen bonding between the repeat regions of glutenin subunits [106–108], which can bring glutenin free accessible SH groups into close proximity to form additional intermolecular disulphide bridges.

#### 4. Impacts of environmental factors on MWD of prolamins

The multiple agronomic studies which were done during the last 25 years indicate that environmental conditions affect the amount, composition and polymerization of the gluten proteins [109–119]. Furthermore, the impact of environmental components on the molecular weight distribution of the prolamins is significantly greater than that of genetic components (i.e.  $\sigma^2_E/\sigma^2_R > \sigma^2_G/\sigma^2_R$ ) (Table 2) [120–122]. This is why, in a context of profound environmental changes [123], it is very important to better understand the mechanisms responsible for these effects in order to better anticipate them.

The availability of nutrients (nitrogen and/or sulphur availability) and the temperature (thermal regime) are the two main environmental factors responsible for these protein changes.

Parameters	Maximum value	Minimum value	Mean value	$\sigma^2_G/\sigma^2_R$	$\sigma^2_E/\sigma^2_R$
Total proteins <sup>1</sup>	8.700	15.100	11.187	11.411 <sup>***</sup>	271.577 <sup>***</sup>
Total polymers <sup>1</sup>	2.785	5.755	4.016	11.104 <sup>***</sup>	187.462 <sup>***</sup>
Polymer/monomer	0.321	0.700	0.561	14.845 <sup>***</sup>	72.611 <sup>***</sup>
Polymer $M_n^2$	$0.730 \times 10^6$	$9.609 \times 10^6$	$0.972 \times 10^6$	1.068 <sup>NS</sup>	4.383 <sup>***</sup>
Polymer $M_w^2$	$1.142 \times 10^6$	$22.970 \times 10^6$	$7.640 \times 10^6$	3.370 <sup>***</sup>	38.974 <sup>***</sup>

<sup>1</sup>Quantity in mg/100 g DM.

<sup>2</sup> $M_n$  = Molecular weight number-average and  $M_w$  = Molecular weight-average (g.mol<sup>-1</sup>).

<sup>\*\*\*</sup>F-test significance at 0.1% level of probability;  $\sigma^2_G/\sigma^2_R$  = Genetic variance/Residual variance ratio and  $\sigma^2_E/\sigma^2_R$  = Environmental variance/Residual variance ratio.

NS: Not significant.

**Table 2.** Genetic (G) and environmental (E) influence on molecular weight distribution of storage proteins determined by analysis of variance (F-test) for 130 common French wheat genotypes cultivated in three different locations for 2005 and 2006 (from Aussenac et al. unpublished data).

High nitrogen availability translates into high protein contents in the grain and flour but also by changes in protein composition. With increasing protein content, gliadins tend to increase at a greater rate than other proteins. This can lead to MWD alterations which results from decreases in the polymeric-to-monomeric protein ratio and/or increases in the HMW-GS to LMW-GS ratio [113, 124, 125].

When sulphur fertilization is limited, the molecular distribution of glutenins is strongly affected insofar as this limitation results in a significant modification of the HMW-GS/LMW-GS ratio [109, 126]. The increase in the HMW-GS/LMW-GS ratio which is linked to the fact that the high molecular weight glutenin subunits are much less affected by a sulphur limitation because they are poorer in corresponding amino acids, therefore results in an increase in the average molecular weight of the polymers. Finally, sulphur deficiency is accentuated by higher nitrogen levels [127].

Temperature (i.e. daily mean temperature, temperature regime and temperature application stage) can induce very large changes in the association state of polymers during grain filling [110, 128–130]. Thus, in the great majority of the work carried out in recent years, various researchers have shown that the increase in temperature and/or the sudden change in the thermal regime during grain filling could lead to a significant decrease in the association status of prolamins resulting in a decrease of MWD (or solubility) of glutenins [131–133].

In the majority of the work to which we have just referred to above, the effects observed are most often attributed to modifications in the synthesis activities of the different storage proteins (i.e. gliadins vs. glutenins and/or HMW-GS vs. LMW-GS) resulting from modulation of the expression of storage protein genes [85]. Today, it seems that other phenomena could also be reasonably involved. These phenomena could be based, in particular, on important variations in the cellular redox status in response to environmental stimuli (i.e. environmental stress).

It has long been established that desiccation of plant tissues causes the appearance of free radicals. Although this phenomenon is a very general mechanism, a large number of observations have been made from seeds of various species [134–137]. In the majority of these studies, the presence of free radicals has been correlated with viability losses [138]. Among these implemented detoxification mechanisms, the ascorbate/glutathione cycle (i.e. trapping of  $H_2O_2$  generated) is one of the most efficient. This essential cycle in chlorophyll tissues [139, 140] has also been studied in seeds [141, 142].

At a cellular level, thiols are the first compounds affected by oxidative stress in general because of the high sensitivity to the oxidation of sulfhydryl (SH) groups. The predominant non-protein thiol in most plant species is glutathione (GSH). This tripeptide ensures the maintenance of the redox status at a cellular level but also the storage and transport of the reduced sulphur necessary for the synthesis of proteins [143–145]. The first compound resulting from the oxidation of glutathione is its dimer (GSSG) which is produced *in vivo* largely thanks to SH/SS exchanges with proteins (noted P) [146]. The reactions below illustrate these exchanges.

The GSSG dimer is normally reduced in GSH by glutathione reductase (GR) activity. Thus, under normal conditions, glutathione is very much present at a cellular level in its reduced

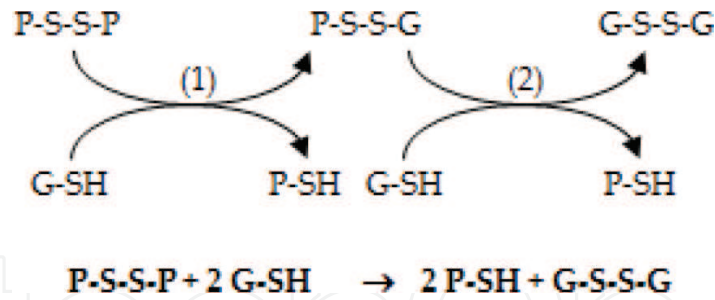

form (i.e. high GSH/GSSH ratio) which has the effect both for maintaining the SH status of proteins (to maintain enzymatic activities [147]) and continue to trap  $\text{H}_2\text{O}_2$ .

Under the influence of oxidative stress, the redox status of glutathione will be modified; GSSG dimer will accumulate due to either an increase in GSH oxidation and/or a decrease in GSSG reduction activity (i.e. decrease of GSH/GSSH ratio). Such changes in the SH/SS status have already been widely observed in response to oxidative stress, especially during seed desiccation [148]. Glutathione which is able to bind to protein thiols is considered a “protective” element of these protein compounds since it prevents the formation of intramolecular disulphide (S-S) bridges during the desiccation phenomena [149]. In this way, GSH contributes both to limit the protein denaturation phenomena and to modulate enzymatic activity [150]. In contrast to desiccation, the imbibition phenomenon preceding germination causes the reduction of the disulphide bonds (SS) of a large number of compounds such as, GSSG [151, 152], protein-S-S-G conjugates [153],  $\alpha$ -amylases [154] or the storage proteins [155, 156]. A synthesis of the presumed role of glutathione can be postulated, referring in particular to the hypothesis formulated by Kranner and Grill [150] (**Figure 11**).

Glutathione may occur endogenously in wheat flour in the free reduced glutathione (GSH) and free oxidized glutathione disulphide (GSSG) forms as well as in the form of protein-glutathione mixed disulphides (PSSG) [146–159]. Moreover, approximately 85% of PSSG in mature wheat grains are represented by polymeric proteins (PP) conjugated to glutathione

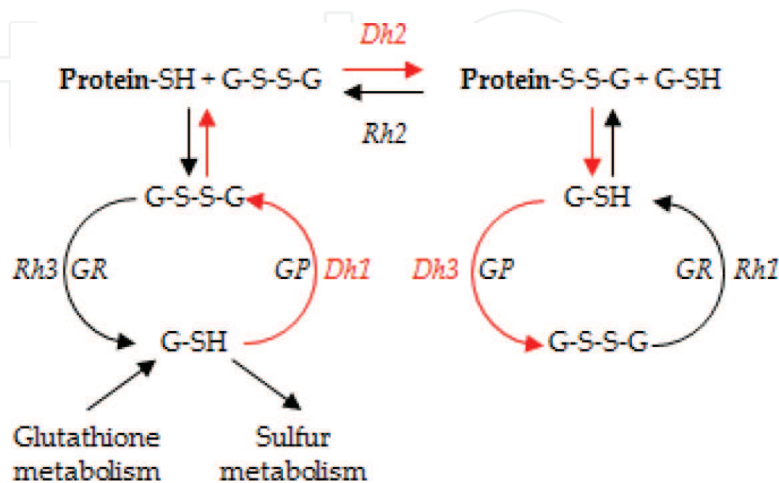

**Figure 11.** SH/SS interchange during dehydration/rehydration phenomenon. (*Dh*) dehydration step, (*Rh*) rehydration step, (*GP*) glutathione peroxidase, (*GR*) glutathione reductase (from Kranner and Grill [150]).



(PPSSG) [159]. Even if glutathione is able to bind to the storage proteins during grain filling, the formation of PSSG is not however correlated with the accumulation of the storage proteins in the grain but coincide rather with the grain desiccation during which the major wheat storage proteins residing in protein bodies undergo redox change (i.e. become oxidized) and UPP are accumulated [103, 159, 160].

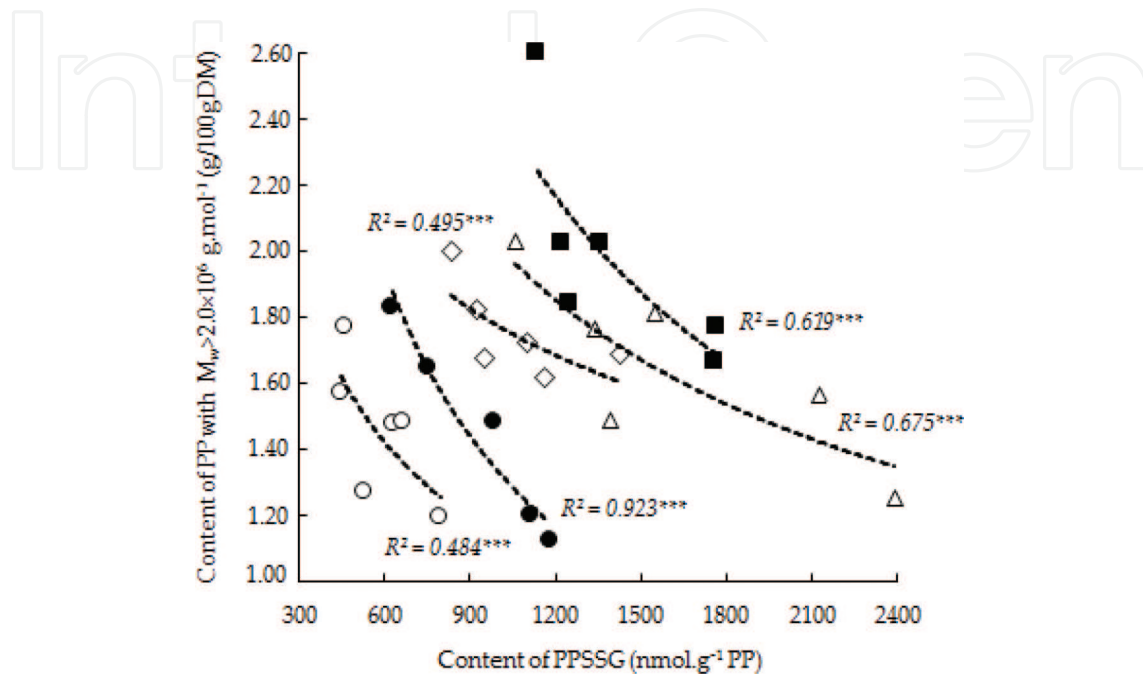

**Figure 12.** The relationship between the content of high aggregated polymeric proteins (PP with  $M_w > 2.0 \times 10^6 \text{ g.mol}^{-1}$ ) and the content of polymeric proteins conjugated to glutathione (PPSSG) for five different common French wheat cultivars (harvest 2005 and 2006 in three locations) (from Aussenac et al. Unpublished data).

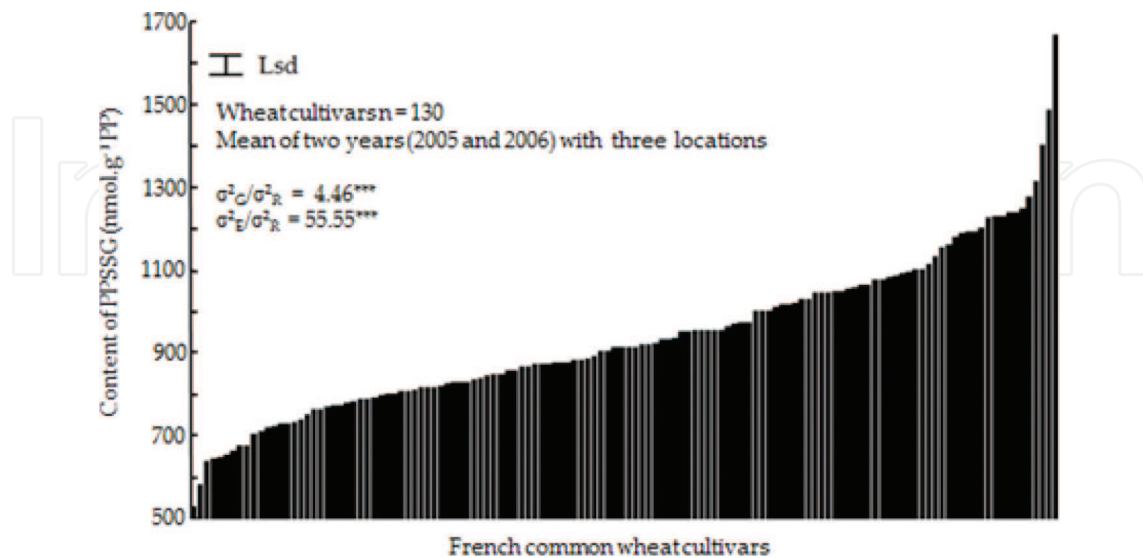

**Figure 13.** Variation of the content of polymeric proteins conjugated to glutathione (PPSSG) for a significant set of common French wheat cultivars (harvest 2005 and 2006 in three locations).  $\sigma^2_G / \sigma^2_R$  = genetic variance/Residual variance ratio and  $\sigma^2_E / \sigma^2_R$  = environmental variance/residual variance ratio (from Aussenac et al. Unpublished data).

Low molecular weight endogenous thiols such as glutathione, which mainly act as “protein protectors” [149] through the formation of PSSG during tissue desiccation, are responsible in wheat grains during its desiccation to a significant reduction of the MWD of the polymeric proteins by the formation of PPSSG (**Figure 12**). This action is all the more important because it is very targeted because GSH was bound almost exclusively to those cysteine residues that have been proposed to form intermolecular disulphide bonds (in particular, cysteines Cb\* and Cx, which are responsible for the aggregative nature of LMW-GS) as Köhler et al. [161] has been able to demonstrate it by using <sup>35</sup>S-labelled GSH.

Consequently, it is now clear that glutathione conjugation with polymeric proteins during the grain development resulting in drastic changes of the cellular redox status (largely due to environmental factors - **Figure 13**) plays a crucial role in controlling the MWD of the polymeric proteins which has been shown to be important in determining baking performance.

## 5. Conclusions

Since the 1990s, there has been a broad consensus within the scientific community that the value of using of a wheat flour depends mainly on the quality of the assembly of its prolamins (glutenins in particular) which are themselves largely under the control of protein polymorphism (the nature and relative abundance of LMW-GS and HMW-GS) and the conditions of development and maturation of the grains from which it is made. Although much progress has been made in the field of characterization of polymeric structures, in particular through the implementation of new analytical approaches (A-4F/MALLS), the fact remains that significant work needs to be done to better understand the structure of its protein assemblies of technological interest (UPP or GMP).

This chapter demonstrates that to achieve these objectives, it is essential to better understand the mechanisms that govern the formation of these polymers and/or protein aggregates in wheat grains during the final stages of their development which are subject to changing environmental conditions (i.e. rising temperatures). In this context, the important role of cellular redox status is addressed by highlighting the significant effects of particular free thiols such as glutathione on the state of association of glutenins. These compounds, of which one of the main functions is to limit the deleterious effects of oxidative stress on protein structures by combining with them, will at the same time reduce the inter-prolamin interactions in the grain thus limiting their technological functionalities. The current improved understanding of these cellular mechanisms will undoubtedly open up new avenues for exploring redox strategies for wheat improvement required for a sustainable quality.

## Acknowledgements

The authors would like to thank the FSOV (French Support Fund for Plant Breeding) and the Conseil Régional HdF (Regional Council of Hauts de France) for supporting part of our research.

## Author details

Aussenac Thierry\* and Rhazi Larbi

Address all correspondence to: [thierry.aussenac@unilasalle.fr](mailto:thierry.aussenac@unilasalle.fr)

Transformations and Agro-Resources (UP 2018.C103), Institut Polytechnique UniLaSalle,  
Beauvais, France

## References

- [1] Finney KF, Barmore MA. Loaf volume and protein content of hard winter and spring wheats. *Cereal Chemistry*. 1948;**25**:291-312
- [2] Cornec M, Popineau Y, Lefebvre J. Characterization of gluten subfractions by SE-HPLC and dynamic rheological analysis in shear. *Journal of Cereal Science*. 1994;**19**:131-139. DOI: 10.1006/jcrs.1994.1018
- [3] Hosney RC, Rogers DE. The formation and properties of wheat flour doughs. *Critical Reviews in Food Science and Nutrition*. 1990;**29**:73-93. DOI: 10.1080/10408399009527517
- [4] Gupta RB, Batey IL, MacRitchie F. Relationships between protein composition and functional properties of wheat flour. *Cereal Chemistry*. 1992;**69**:125-131
- [5] Osborne TB. The proteins of the wheat kernel. Carnegie Institution of Washington D.C. 1907; Pub. N° 84: 119 pp
- [6] Shewry PR, Tatham AS, Forde J, Kreis M, Mifflin BJ. The classification of wheat gluten proteins; a reassessment. *Journal of Cereal Science*. 1986;**4**:97-106. DOI: 10.1016/S0733-5210(86)80012-1
- [7] Singh NK, Shepherd KW. Linkage mapping of genes controlling endosperm storage proteins in wheat. I – Genes on the short arms of group 1 chromosomes. *Theoretical and Applied Genetics*. 1988;**75**:628-641. DOI: 10.1007/BF00289132
- [8] Wieser H, Seilmeier W, Belitz HD. Quantitative determination of gliadin subgroups from different wheat cultivars. *Journal of Cereal Science*. 1994;**19**:149-155. DOI: 10.1006/jcrs.1994.1020
- [9] Brown JWS, Flavell RB. Fractionation of wheat gliadin and glutenin subunits by two dimensional electrophoresis and the role of group 6 and group 2 chromosomes in gliadin synthesis. *Theoretical and Applied Genetics*. 1981;**59**:349-359. DOI: 10.1007/BF00276448
- [10] Autran JC, Bourdet A. L'identification des variétés de blé : établissement d'un tableau général de détermination fondé sur le diagramme électrophorétique des gliadines du grain. *Annales de l'Amélioration des Plantes*. 1975;**25**:277-301
- [11] Gupta RB, Shepherd KW. Two step one dimensional SDS-PAGE analysis of LMG subunits of glutenin. I - Variation and genetic control of the subunits in hexaploid wheats. *Theoretical and Applied Genetics*. 1990;**80**:65-74. DOI: 10.1007/BF00224017

- [12] Payne PI, Holt LM, Law CN. Structural and genetical studies on the high-molecular-weight subunits of wheat glutenin. Part I: Allelic variation in subunit amongst varieties of wheat (*Triticum aestivum*). *Theoretical and Applied Genetics*. 1981;**60**:229-236. DOI: 10.1007/BF02342544
- [13] Curioni A, Dal Belin Peruffo A, Pressi G, Pogna NE. Immunological distinction between x-type and y-type high molecular weight glutenin subunits. *Cereal Chemistry*. 1991;**68**:200-204
- [14] Payne PI, Lawrence GJ. Catalogue of alleles for the complex gene loci, Glu-A1, Glu, B1, and Glu-D1 which code for high-molecular-weight subunits of glutenin in hexaploid wheat. *Cereal Research Communications*. 1983;**11**:29-34
- [15] Shewry PR, Tatham A, Halford NG. The prolamins of the Triticeae. In: Shewry P, Casey R, editors. *Seed Proteins*. Dordrecht, The Netherlands: Kluwer Academic Publishers; 1999. p. 35-78. DOI: 10.1007/978-94-011-4431-5
- [16] Shewry PR, Halford NG. Cereal seed storage proteins: Structures, properties and role in grain utilization. *Journal of Experimental Botany*. 2002;**53**:947-958. DOI: 10.1093/jexbot/53.370.947
- [17] MacRitchie F. Baking quality of wheat flour. *Advanced in Food Research*. 1984;**29**:201-277. DOI: 10.1016/S0065-2628(08)60058-0
- [18] MacRitchie F, Ducros DL, Wrigley CW. Flour polypeptide related to wheat quality. In: Pomeranz Y, editor. *Advances in Cereal Science and Technology*. St Paul, USA: American Association of Cereal Chemists; 1990. Vol. X. p. 79-145. DOI: 10.1002/food.19910350434
- [19] Shewry PR, Popineau Y, Lafiandra D, Belton P. Wheat glutenin subunits and dough elasticity: Findings of the EUROWHEAT project. *Trends in Food Science and Technology*. 2001;**11**:433-441. DOI: 10.1016/S0924-2244(01)00035-8
- [20] Lee JW, MacRitchie F. The effect of gluten protein fractions on dough properties. *Cereal Chemistry*. 1971;**48**:620-625
- [21] MacRitchie F. Studies of gluten proteins from wheat flours. *Cereal Foods World*. 1980;**25**:382-385
- [22] Bietz JA. Analysis of wheat gluten proteins by high-performance liquid-chromatography. Part I. *Baker's Digest*. 1984;**58**:15-17, 20-21, 32
- [23] Bietz JA. High performance liquid chromatography of cereal proteins. In: Pomeranz Y, editor. *Advances in Cereal Science and Technology*. Vol. Vol. VIII. St-Paul: AACC; 1986. pp. 105-170
- [24] Huebner FR, Bietz JA. Detection of quality differences among wheats by high performance liquid chromatography. *Journal of Chromatography*. 1985;**327**:333-342. DOI: 10.1016/S0021-9673(01)81662-9

- [25] Huebner FR, Wall JS. Fractionation and quantitative differences of glutenin from wheat varieties varying in baking quality. *Cereal Chemistry*. 1976;**53**:258-260
- [26] Orsi F, Pallagi E, Bekes F, Lasztity L. Investigation of wheat proteins by high performance gel chromatography. In: *Proceedings of the 3rd Int. Workshop Gluten Proteins*, Budapest. Singapore: World Scientific; 1987. pp. 141-160
- [27] Dachkevitch T, Aufran JC. Prediction of baking quality of bread wheats in breeding programs by size-exclusion high-performance liquid chromatography. *Cereal Chemistry*. 1989;**66**:448-456
- [28] Singh NK, Donovan R, Batey IL, MacRitchie F. Use of sonication and size exclusion high-performance liquid chromatography in the study of wheat flour proteins. I. Dissolution of total proteins in the absence of reducing agents. *Cereal Chemistry*. 1990;**67**:150-161
- [29] Singh NK, Donovan R, MacRitchie F. Use of sonication and size exclusion high-performance liquid chromatography in the study of wheat flour proteins. II. Relative quantity of glutenin as a measure of breadmaking quality. *Cereal Chemistry*. 1990;**67**:161-170
- [30] Weegels PL, Hamer RJ, Schofield JD. Critical review. Functional properties of wheat glutenin. *Journal of Cereal Science*. 1996;**23**:1-18. DOI: 10.1006/jcrs.1996.0001
- [31] Southan M, MacRitchie F. Molecular weight distribution of wheat proteins. *Cereal Chemistry*. 1999;**76**:827-836. DOI: 10.1094/CCHEM.1999.76.6.827
- [32] MacRitchie F, Lafiandra D. Structure-function relationships of wheat proteins. In: Damodaran S, Paraf A, editors. *Food Proteins and Their Applications*. New York: Marcel Dekker; 1997. pp. 293-323
- [33] Chen CH, Bushuk W. Nature of proteins in Triticale and its parental species I. Solubility characteristics and amino-acid composition of endosperm proteins. *Canadian Journal of Plant Science*. 1970;**50**:9-14. DOI: 10.4141/cjps70-002
- [34] Orth RA, Bushuk W. A comparative study of proteins of wheats of diverse baking quality. *Cereal Chemistry*. 1972;**49**:268-275
- [35] Khan K, Bushuk W. Glutenin: Structure and functionality in breadmaking. *Baker's Digest*. 1978; April:14-20
- [36] Graveland A. Extraction of wheat proteins with sodium dodecyl sulphate. *Annales de Technologie Agricole*. 1980;**29**:113-123
- [37] Gupta RB, Khan K, MacRitchie F. Biochemical basis of flour properties in bread wheats. I. Effects of variation in the quantity and size distribution of polymeric protein. *Journal of Cereal Science*. 1993;**18**:23-41. DOI: 10.1006/jcrs.1993.1031
- [38] Graveland A, Bosveld P, Lichtendonk WJ, Moonen JHE. Extraction and fractionation of wheat flour proteins. *Journal of the Science of Food and Agriculture*. 1982;**33**:1117-1128. DOI: 10.1002/jsfa.2740331109



- [39] Weegels PL, Flissebaalje T, Hamer R. Factors affecting the extractability of the glutenin macropolymer. *Cereal Chemistry*. 1994;**71**:308-309
- [40] Weegels PL, Van de Pijpekamp AM, Graveland A, Hamer RJ, Schofield JD. Depolymerisation and repolymerisation of wheat gluten during dough processing I. Relationships between GMP content and quality parameters. *Journal of Cereal Science*. 1996;**23**:103-111. DOI: 10.1006/jcrs.1996.0010
- [41] Moonen JHE, Scheepstra A, Graveland A. Use of the SDS-sedimentation test and SDSpolyacrylamide gel electrophoresis for screening breeder's samples of wheat for bread-making quality. *Euphytica*. 1986;**31**:677-690. DOI: 10.1007/BF00039206
- [42] Weegels PL, Hamer RJ, Schofield JD. Depolymerisation and re-polymerisation of wheat glutenin during dough processing. II. Changes in composition. *Journal of Cereal Science*. 1997;**25**:155-163. DOI: 10.1006/jcrs.1996.0082
- [43] Giddings JC. Field-flow fractionation: Analysis of macromolecular, colloids, and particulate materials. *Science*. 1993;**260**:1456-1465. DOI: 10.1126/science.8502990
- [44] Giddings JC, Benincasa MA, Liu MK, Li P. Separation of water soluble synthetic and biological macromolecules by flow field-flow fractionation. *Journal of Liquid Chromatography*. 1992;**15**:1729-1747. DOI: 10.1080/10826079208018323
- [45] Wahlund KG, Giddings JC. Properties of an asymmetrical flow field-flow fractionation channel having one permeable wall. *Analytical Chemistry*. 1987;**59**:1332-1339. DOI: 10.1021/ac00136a016
- [46] Litzén A, Walter JK, Krischollek H, Wahlund KG. Separation and quantification of monoclonal antibody aggregates by asymmetrical flow field-flow fractionation and comparison to gel permeation chromatography. *Analytical Biochemistry*. 1993;**212**:469-480. DOI: 10.1006/abio.1993.1356
- [47] Bean SR, Lookhart GL. Factors influencing the characterization of gluten proteins by size-exclusion chromatography and multiangle laser light scattering (SEC-MALLS). *Cereal Chemistry*. 2001;**78**:608-618. DOI: 10.1094/CCHEM.2001.78.5.608
- [48] Carceller JL, Aussenac T. Size characterisation of glutenin polymers by HPSEC-MALLS. *Journal of Cereal Science*. 2001;**33**:131-142. DOI: 10.1006/jcrs.2000.0356
- [49] Giddings JC, Yang FJ, Myers MN. Flow field-flow fractionation as a methodology for protein separation and characterization. *Analytical Biochemistry*. 1977;**81**:395-407. DOI: 10.1016/0003-2697(77)90710-2
- [50] Stevenson SG, Preston KR. Flow field-flow fractionation of wheat proteins. *Journal of Cereal Science*. 1996;**23**:121-131. DOI: 10.1006/jcrs.1996.0012
- [51] Wahlund KG, Gustavsson M, MacRitchie F, Nylander T, Wannerberger L. Size characterisation of wheat proteins, particularly glutenin, by asymmetrical flow field-flow fractionation. *Journal of Cereal Science*. 1996;**23**:113-119. DOI: 10.1006/jcrs.1996.0011

- [52] Ueno T, Stevenson SG, Preston KR, Nightingale MJ, Marchylo BM. Simplified dilute acetic acid-based extraction procedure for fractionation and analysis of wheat flour protein by size exclusion HPLC and flow field-flow fractionation. *Cereal Chemistry*. 2002;**79**:155-161. DOI: 10.1094/CCHEM.2002.79.1.155
- [53] Wyatt PJ. Combined differential light scattering with various liquid chromatography techniques. In: Harding SE, Sattelle DB, Bloomfield VA, editors. *Laser Light Scattering in Biochemistry*. Wiltshire, UK: Royal Society of Chemistry; 1992. pp. 35-58
- [54] Egorov TA, Odintsova TI, Shewry PR, Tatham AS. Characterisation of high Mr wheat glutenin polymers by agarose gel electrophoresis and dynamic light scattering. *FEBS Letters*. 1998;**434**:215-217. DOI: 10.1016/S0014-5793(98)00983-1
- [55] Stevenson SG, You S, Isydorczyk MS, Preston KR. Characterization of polymeric wheat proteins by flow field-flow fractionation/MALLS. *Journal of Liquid Chromatography and Related Technology*. 2003;**26**:2771-2781. DOI: 10.1081/JLC-120025044
- [56] Arfvidsson C, Wahlund KG, Eliasson AC. Direct molecular weight determination in the evaluation of dissolution methods for unreduced glutenin. *Journal of Cereal Science*. 2004;**39**:1-8. DOI: 10.1016/S0733-5210(03)00038-9
- [57] Lemelin E, Aussenac T, Violleau F, Salvo L, Lein V. Impact of cultivar and environment on size characteristics of wheat proteins using asymmetrical flow field-flow fractionation and multi-angle laser light scattering. *Cereal Chemistry*. 2005;**82**:28-33. DOI: 10.1094/CC-82-0028
- [58] Gupta RB, Paul JG, Cornish GB, Palmer GA, Bekes F, Rathjen AJ. Allelic variation at glutenin subunit and gliadin loci, *Glu-1*, *Glu-3*, and *Gli-1*, of common wheats. I. Its additive and interaction effects on dough properties. *Journal of Cereal Science*. 1994;**19**:9-17. DOI: 10.1006/jcrs.1994.1004
- [59] Gupta RB, Popineau Y, Lefebvre J, Cornec M, MacRitchie F. Biochemical basis of flour properties in bread wheats. II. Changes in polymeric protein formation and dough/gluten properties associated with the loss of low Mr or high Mr glutenin subunits. *Journal of Cereal Science*. 1995;**21**:103-116. DOI: 10.1016/0733-5210(95)90026-8
- [60] Larroque OR, Gianibelli MC, Batey IL, MacRitchie F. Electrophoretic characterisation of fractions collected from gluten protein extracts subjected to size-exclusion high-performance liquid chromatography. *Electrophoresis*. 1997;**18**:1064-1067. DOI: 10.1002/elps.1150180706
- [61] Lindsay MP, Skerritt JH. Examination of the structure of the glutenin macropolymer in wheat flour and doughs by stepwise reduction. *Journal of Agricultural and Food Chemistry*. 1998;**46**:3447-3457. DOI: 10.1021/jf980315m
- [62] Skerritt JH, Hac L, Bekes F. Depolymerisation of the glutenin macropolymer during dough mixing. I. Changes in levels, molecular weight distribution, and overall composition. *Cereal Chemistry*. 1999;**76**:395-401. DOI: 10.1094/CCHEM.1999.76.3.395

- [63] Aussenac T, Carceller JL, Kleiber D. Changes in SDS solubility of glutenin polymers during dough mixing and resting. *Cereal Chemistry*. 2001;**78**:39-45. DOI: 10.1094/CCHEM.2001.78.1.39
- [64] Veraverbeke WS, Courtin CM, Verbruggen IM, Delcour JA. Factors governing levels and composition of the sodium dodecyl sulphate unextractable glutenin polymers during straight dough breadmaking. *Journal of Cereal Science*. 1999;**29**:129-138. DOI: 10.1006/jcsc.1998.0232
- [65] Kasarda DD. Glutenin polymers: The in vitro to in vivo transition. *Cereal Foods World*. 1999;**44**:566-571
- [66] Bechtel D, Abecassis J, Shewry PR, Evers T. The development, structure and mechanical properties of the wheat grain. In: Khan K, Shewry PR, editors. *Wheat: Chemistry and Technology*. fourth ed. St Paul, MN, USA: AACC; 2009. pp. 51-95
- [67] Carceller JL, Aussenac T. Accumulation and changes in molecular size distribution of polymeric proteins in developing grains of hexaploid wheats: Role of the desiccation phase. *Australian Journal of Plant Physiology*. 1999;**26**:301-310. DOI: 10.1071/PP99010
- [68] Jenner CF, Ugalde TD, Aspinall D. The physiology of starch and protein deposition in the endosperm of wheat. *Australian Journal of Plant Physiology*. 1991;**18**:211-226. DOI: 10.1071/PP9910211
- [69] Triboï E. Modèle d'élaboration du poids du grain chez le blé tendre (*Triticum aestivum* em. Thell.). *Agronomie*. 1990;**10**:191-200
- [70] Dale EH, Houstley TL. Sucrose synthase activity in developing wheat endosperms differing in maximum weight. *Plant Physiology*. 1986;**82**:7-10. DOI: 10.1104/pp.82.1.7
- [71] Wang YP, Gifford RM. A model of wheat grain growth and its applications to different temperature and carbon dioxide levels. *Australian Journal of Plant Physiology*. 1995;**22**:843-855. DOI: 10.1071/PP9950843
- [72] Bechtel DB, Gaines RL, Pomeranz Y. Protein secretion in wheat endosperm—formation of the matrix protein. *Cereal Chemistry*. 1982;**59**:336-343
- [73] Tosi P. Trafficking and deposition of prolamins in wheat. *Journal of Cereal Science*. 2012;**56**:81-90. DOI: 10.1016/j.jcs.2012.02.004
- [74] Brooks A, Jenner CF, Aspinall D. Effects of water deficit on endosperm starch granules and on grain physiology of wheat and barley. *Australian Journal of Plant Physiology*. 1982;**9**:423-436. DOI: 10.1071/PP9820423
- [75] Nicolas ME, Gleadow RM, Dalling MJ. Effects of drought and high temperature on grain growth in wheat. *Australian Journal of Plant Physiology*. 1984;**11**:553-566. DOI: 10.1071/PP9840553
- [76] Morris CF, Paulsen GM. Development of hard winter wheat after anthesis as affected by nitrogen nutrition. *Crop Science*. 1985;**25**:1010. DOI: 10.2135/cropsci1985.0011183X002500060026x

- [77] Wardlaw IF, Dawson IA, Munibi P, Fewster R. The tolerance of wheat to high temperatures during reproductive growth. I. Survey procedures and general response patterns. *Australian Journal of Agricultural Research*. 1989;**40**:1-13. DOI: 10.1071/AR9890001
- [78] Tashiro T, Wardlaw IF. The response to high temperature shock and humidity changes prior to and during the early stages of grain development in wheat. *Australian Journal of Plant Physiology*. 1990;**17**:551-561. DOI: 10.1071/PP9900551
- [79] Randall PJ, Moss HJ. Some effects of temperature regime during grain filling on wheat quality. *Australian Journal of Agricultural Research*. 1990;**41**:603-617. DOI: 10.1071/AR9900603
- [80] Kobata T, Palta JA, Turner NC. Rate of development of postanthesis water deficits and grain filling of spring wheat. *Crop Science*. 1992;**32**:1238-1242. DOI: 10.2135/cropsci1992.0011183X003200050035x
- [81] Gibson LR, Paulsen GM. Yield components of wheat grown under high temperature stress during reproductive growth. *Crop Science*. 1999;**39**:1841-1846. DOI: 10.2135/cropsci1999.3961841x
- [82] Daniel C, Triboi E. Effects of temperature and nitrogen nutrition on the grain composition of winter wheat: Effects on gliadin content and composition. *Journal of Cereal Science*. 2000;**32**:45-56. DOI: 10.1006/jcrs.2000.0313
- [83] Yang J, Zhang J, Zhu Q, Wang L. Remobilization of carbon reserves is improved by controlled soil-drying during grain filling of wheat. *Crop Science*. 2000;**40**:1645-1655. DOI: 10.2135/cropsci2000.4061645x
- [84] Guedira M, McCluskey PJ, MacRitchie F, Paulsen GM. Composition and quality of wheat grown under different shoot and root temperatures during maturation. *Cereal Chemistry*. 2002;**79**:397-403. DOI: 10.1094/CCHEM.2002.79.3.397
- [85] Altenbach SB, DuPont FM, Kothari KM, Chan R, Johnson EL, Lieu D. Temperature, water and fertilizer influence the timing of key events during grain development in a US spring wheat. *Journal of Cereal Science*. 2003;**37**:9-20. DOI: 10.1006/jcrs.2002.0483
- [86] DuPont FM, Altenbach SB. Molecular and biochemical impacts of environmental factors on wheat grain development and protein synthesis. *Journal of Cereal Science*. 2003;**38**:133-146. DOI: 10.1016/S0733-5210(03)00030-4
- [87] Tosi P, Parker M, Gritsch CS, Carzaniga R, Martin B, Shewry PR. Trafficking of storage proteins in developing grain of wheat. *Journal of Experimental Botany*. 2009;**60**:979-991. DOI: 10.1093/jxb/ern346
- [88] Jennings AC, Morton RK. Changes in carbohydrate, protein and non-protein nitrogenous compounds of developing wheat grains. *Australian Journal of Biological Sciences*. 1963;**16**:318-331. DOI: 10.1071/BI9630318
- [89] Flint D, Ayers GS, Ries SK. Synthesis of endosperm proteins in wheat seed during maturation. *Plant Physiology*. 1975;**56**:381-384. DOI: 10.1104/pp.56.3.381



- [90] Stenram U, Heneen WK, Oleredd R. The effect of nitrogen fertilizers on protein accumulation in wheat (*Triticum aestivum* L.). *Swedish Journal of Agricultural Research*. 1990;**20**:105-114
- [91] Gupta RB, Masci S, Lafiandra D, Bariana HS, MacRitchie F. Accumulation of protein subunits and their polymers in developing grains of hexaploid wheats. *Journal of Experimental Botany*. 1996;**47**:1377-1385. DOI: 10.1093/jxb/47.9.1377
- [92] Stone PJ, Nicolas ME. Varietal differences in mature protein composition of wheat resulted from different rates of polymer accumulation during grain filling. *Australian Journal of Plant Physiology*. 1996;**23**:727-737. DOI: 10.1071/PP9960727
- [93] Shewry PR, Underwood C, Wan YF, Lovegrove A, Bhandari D, Toole G, Mills ENC, Denyer K, Mitchell RAC. Storage product synthesis and accumulation in developing grains of wheat. *Journal of Cereal Science*. 2009;**50**:106-112. DOI: 10.1016/j.jcs.2009.03.009
- [94] Kaczkowski J, Kos S, Moskal M. Protein functional composition in developing wheat grains. *Die Nahrung*. 1986;**30**:437-439
- [95] Huebner FR, Kaczkowski J, Bietz JA. Quantitative variations of wheat proteins form grain at different stages of maturity and from different spike locations. *Cereal Chemistry*. 1990;**67**:464-470
- [96] Bénétrix F, Kaan F, Autran JC. Changes in protein complexes of durum wheat in developing seed. *Crop Science*. 1994;**34**:462-468. DOI: 10.2135/cropsci1994.0011183X003400020029x
- [97] Woodman HE, Engledow FJ. A chemical study of the development of the wheat grains. *The Journal of Agricultural Science*. 1924;**14**:563-586
- [98] Seilmeier W, Wieser H, Belitz HD. Weizen während der Reifung. Analyse der gliadine und glutenine mittels RP-HPLC. *Zeitschrift für Lebensmittel-Untersuchung und -Forschung*. 1990;**191**:99-103
- [99] Carceller JL, Aussenac T. SDS-insoluble glutenin polymer formation in developing grains of hexaploid wheat: The role of the ratio of high to low molecular weight glutenin subunits and drying rate during ripening. *Australian Journal of Plant Physiology*. 2001;**28**:193-201. DOI: 10.1071/PP00002
- [100] Ferreira MS, Samson MF, Bonicel J, Morel MH. Relationship between endosperm cells redox homeostasis and glutenin polymers assembly in developing durum wheat grain. *Plant Physiology and Biochemistry*. 2012;**61**:36-45. DOI: 10.1016/j.plaphy.2012.08.015
- [101] Ferrise R, Bindi M, Martre P. Grain filling duration and glutenin polymerization under variable nitrogen supply and environmental conditions for durum wheat. *Field Crops Research*. 2015;**171**:23-31. DOI: 10.1016/j.jcs.2016.12.003
- [102] Koga S, Böcker U, Wieser H, Koehler P, Uhlen AK, Moldestad A. Polymerisation of gluten proteins in developing wheat grain as affected by desiccation. *Journal of Cereal Science*. 2017;**73**:122-129. DOI: 10.1016/j.jcs.2016.12.003



- [103] Rhazi L, Cazalis R, Aussenac T. Sulfhydryl-disulfide changes in storage proteins of developing wheat grain: Influence on the SDS-unextractable glutenin polymer formation. *Journal of Cereal Science*. 2003;**38**:3-13. DOI: 10.1016/S0733-5210(03)00019-5
- [104] Gobin P, Ng PKW, Buchanan BB, Kobrehel K. Sulfhydryl-disulfide changes in proteins of developing wheat grain. *Plant Physiology and Biochemistry*. 1997;**35**:777-783
- [105] Hamer R, van Vliet T. Understanding the structure and properties of gluten and overview. In: Shewry PR, Tatham AS, editors. *Wheat Gluten*. Cambridge: Royal Society of Chemistry; 2000. pp. 125-131
- [106] Belton PS, Colquhoun IJ, Grant A, Wellner N, Field JM, Shewry PR, Tatham AS. FTIR and NMR studies of high Mr subunit of glutenin. *International Journal of Biological Macromolecules*. 1995;**17**:74-80. DOI: 10.1016/0141-8130(95)93520-8
- [107] Belton PS. On the elasticity of wheat gluten. *Journal of Cereal Science*. 1999;**29**:103-107. DOI: 10.1006/jcrs.1998.0227
- [108] Chen X, Schofield JD. Determination of protein-glutathion mixed disulfides in wheat flour. *Journal of Agricultural and Food Chemistry*. 1995;**43**:2362-2368. DOI: 10.1021/jf00057a009
- [109] Wrigley CW, DL dC, Fullington JG, Kasarda DD. Changes in polypeptide composition and grain quality due to sulfur deficiency in wheat. *Journal of Cereal Science*. 1984;**2**:15-24. DOI: 10.1016/S0733-5210(84)80003-X
- [110] Ciaffi M, Tozzi L, Borghi B, Corbellini M, Lafiandra D. Effect of heat shock during grain filling on the gluten protein composition of bread wheat. *Journal of Cereal Science*. 1996;**24**:91-100. DOI: 10.1006/jcrs.1996.0042
- [111] Graybosch RA, Peterson CJ, Baenziger PS, Shelton DR. Environmental modification of hard red winter wheat flour protein composition. *Journal of Cereal Science*. 1995;**22**:45-51. DOI: 10.1016/S0733-5210(05)80006-2
- [112] Borghi B, Corbellini M, Ciaffi M, Lafiandra D, De Stefanis E, Sgrulletta S, Boggini G, Di Fonzo N. Effects of heat shock during grain filling on grain quality of bread and durum wheats. *Australian Journal of Agricultural Research*. 1995;**46**:1365-1380. DOI: 10.1071/AR9951365
- [113] Wieser H, Seilmeier W. The influence of nitrogen fertilization on quantities and proportions of different protein types in wheat flour. *Journal of the Science of Food and Agriculture*. 1998;**76**:49-55. DOI: 10.1002/(SICI)1097-0010(199801)76:1<49::AID-JSFA950>3.0.CO;2-2
- [114] Panozzo JF, Eagles HA. Cultivar and environment effects on quality characters in wheat. II. Protein. *Australian Journal of Agricultural Research*. 2000;**51**:629-636. DOI: 10.1071/AR99137
- [115] Luo C, Branlard G, Griffin WB, McNeil DL. The effect of nitrogen and sulphur fertilization and their interaction with genotype on wheat glutenins and quality parameters. *Journal of Cereal Science*. 2000;**31**:185-194. DOI: 10.1006/jcrs.1999.0298

- [116] Johansson E, Prieto-Linde ML, Jonsson JO. Effects of wheat cultivar and nitrogen application on storage protein composition and breadmaking quality. *Cereal Chemistry*. 2001;78:19-25. DOI: 10.1094/CCHEM.2001.78.1.19
- [117] Vaughan B, Westfall DG, Barbarick KA. Nitrogen rate and timing effects on winter wheat grain yield, grain protein, and economics. *Journal of Production Agriculture*. 1990;3:324-328. DOI: 10.2134/jpa1990.0324
- [118] Uhlen AK, Dieseth JA, Koga S, Böcker U, Hoel B, Anderson JA, Moldestad A. Variation in gluten quality parameters of spring wheat varieties of different origin grown in contrasting environments. *Journal of Cereal Science*. 2015;62:110-116. DOI: 10.1016/j.jcs.2015.01.004
- [119] Johansson E, Malik AH, Hussain A, Rasheed F, Newson WR, Plivelic T, Hedenqvist MS, Gällstedt M, Kuktaite R. Wheat gluten polymer structures: The impact of genotype, environment, and processing on their functionality in various applications. *Cereal Chemistry*. 2013;90:367-376. DOI: 10.1094/CCHEM-08-12-0105-F
- [120] Zhu J, Kahn K, Huang S, O'Brien L. Allelic variation at Glu-D1 locus for high molecular weight (HMW) glutenin subunits: Quantification by multistacking SDS-PAGE of wheat grown under nitrogen fertilization. *Cereal Chemistry*. 1999;76:915-919. DOI: 10.1094/CCHEM.1999.76.6.915
- [121] Finlay GJ, Bullock PR, Sapirstein HD, Naeem HA, Hussain A, Angadi SV, DePauw RM. Genotypic and environmental variation in grain, flour, dough and bread-making characteristics of western Canadian spring wheat. *Canadian Journal of Plant Science*. 2007;87:679-690. DOI: 10.4141/P06-150
- [122] Gouache D, Le Bris X, Bogarda M, Deudonc O, Pagé C, Gate P. Evaluating agronomic adaptation options to increasing heat stress under climate change during wheat grain filling in France. *European Journal of Agronomy*. 2012;39:62-70. DOI: 10.1016/j.eja.2012.01.009
- [123] Jia YQ, Fabre JL, Aussenac T. Effects of growing location on response of protein polymerization to increased nitrogen fertilization for the common wheat cultivar Soissons: Relationship with some aspects of the breadmaking quality. *Cereal Chemistry*. 1996;73:526-532
- [124] MacRitchie F, Gupta RB. Functionality-composition relationships of wheat flour as a result of variation in sulfur availability. *Australian Journal of Agricultural Research*. 1993;44:1767-1774. DOI: 10.1071/AR9931767
- [125] Wooding AR, Martin RJ, MacRitchie F. Effect of sulfur nitrogen treatments on work input requirements for dough mixing in a second season. In: *Proceedings of the 44th Australian Cereal Chemistry Conf. RACI. Australia, Melbourne; 1994. pp. 219-222*
- [126] Blumenthal CS, Barlow EWR, Wrigley CW. Growth environment and wheat quality. *Journal of Cereal Science*. 1993;18:3-21. DOI: 10.1006/jcrs.1993.1030

- [127] Bernardin JE, Witt SC, Milenic J. Effect of heat stress on the pattern of protein synthesis in wheat endosperm. In: Proceeding of the 44th Australian Cereal Chemistry Conference RACI. Melbourne; 1994. pp. 37-41
- [128] Stone P, Nicolas ME. Wheat cultivars vary widely in their responses of grain yield and quality to short periods of post-anthesis heat-stress. *Functional Plant Biology*. 1994;**21**:887-900. DOI: 10.1071/PP9940887
- [129] Stone P, Nicolas ME. Effect of timing of heat stress during grain filling on two varieties differing in heat tolerance. II. Fractional protein accumulation. *Australian Journal of Plant Physiology*. 1996;**23**:739-749. DOI: 10.1071/PP9960739
- [130] Johansson E, Nilsson H, Mazhar H, Skerritt J, MacRitchie F, Svensson G. Seasonal effects on storage proteins and gluten strength in four Swedish wheat cultivars. *Journal of the Science of Food and Agriculture*. 2002;**82**:1305-1311. DOI: 10.1002/jsfa.1185
- [131] Quartacci MF, Navari-Izzo F. Water stress and free radical mediated changes in sunflower seedlings. *Journal of Plant Physiology*. 1992;**139**:621-625. DOI: 10.1016/S0176-1617(11)80381-0
- [132] Simontacchi M, Puntarulo S. Oxygen radical generation by isolated microsomes from soybean seedlings. *Plant Physiology*. 1992;**100**:1263-1268. DOI: 10.1104/pp.100.3.1263
- [133] Leprince O, Deltour R, Thorpe PC, Atherton NM, Hendry GAF. The role of free radicals and radical processing systems in loss of desiccation tolerance in germinating maize (*Zea mays* L.). *New Phytologist*. 1990;**116**:573-580. DOI: 10.1111/j.1469-8137.1990.tb00541.x
- [134] Leprince O, Atherton NM, Deltour R, Hendry GAF. The involvement of respiration in free radical processes during loss of desiccation tolerance in germinating *Zea mays* L. An electron paramagnetic resonance study. *Plant Physiology*. 1994;**104**:1333-1339. DOI: 10.1104/pp.104.4.1333
- [135] Hendry GAF. Oxygen, free radical processes and seed longevity. *Seed Science Research*. 1993;**3**:141-153. DOI: 10.1017/S0960258500001720
- [136] Foyer CH, Halliwell B. The presence of glutathione and glutathione reductase in chloroplasts: A proposed role in ascorbic acid metabolism. *Planta*. 1976;**133**:21-25. DOI: 10.1007/BF00386001
- [137] Foyer CH, Lelandais M, Kunert K. Photooxydative stress in plants. *Physiologia Plantarum*. 1994;**92**:696-717. DOI: 10.1111/j.1399-3054.1994.tb03042.x
- [138] Klapheck S, Zimmer I, Cosse H. Scavenging of hydrogen peroxide in the endosperm of *Ricinus communis* by ascorbate peroxydase. *Plant and Cell Physiology*. 1990;**31**:1005-1013. DOI: 10.1093/oxfordjournals.pcp.a077996
- [139] Cakmak I, Marschner H. Activities of hydrogen peroxide-scavenging enzymes in germinating wheat seeds. *Journal of Experimental Botany*. 1993;**44**:127-132. DOI: 10.1093/jxb/44.1.127

- [140] Renneberg H. Glutathione metabolism and possible biological roles in higher plants. *Phytochemistry*. 1982;**21**:2771-2781. DOI: 10.1016/0031-9422(80)85045-X
- [141] Alsher RG. Biosynthesis and antioxidant function of glutathione in plants. *Physiologia Plantarum*. 1989;**77**:457-464. DOI: 10.1111/j.1399-3054.1989.tb05667.x
- [142] Smith IK, Polle A, Renneberg H. Glutathione. In: Alsher RG, Cumming J, editors. *Stress Responses in Plants*. New York: Wiley-Liss Inc; 1990. pp. 201-215
- [143] Jocelyn PC. *Biochemistry of the SH group*. London: Academic Press; 1972. pp. 63-136
- [144] Gilbert HF, McLean V, McLean M. Molecular and cellular aspects of thiol-disulfide exchange. *Advances in Enzymology and Related Areas of Molecular Biology*. 1990;**63**:169-172. DOI: 10.1002/SERIES2011
- [145] Dhindsa RS. Glutathione redox status and protein synthesis during drought and subsequent rehydration. *Plant Physiology*. 1987;**83**:816-919. DOI: 10.1104/pp.83.4.816
- [146] De Gara L, Pinto M, Moliterni V, D'Egidio M. Redox regulation and storage processes during maturation in kernels of *Triticum durum*. *Journal of Experimental Botany*. 2003;**54**:249-258. DOI: 10.1093/jxb/erg021
- [147] Kunert KJ, Foyer C. Thiol/disulfide exchange in plants. In: Dekok LJ, Stulen I, Renneberg H, Brunold C, Rauser WE, editors. *Sulfur Nutrition and Assimilation in Higher Plants*. The Hague: SPB Academic Publishing; 1993. pp. 139-151
- [148] Kranner I, Grill D. Significance of thiol-disulfide exchange in resting stages of plant development. *Botanica Acta: Journal of the German Botanical Society*. 1996;**109**:8-14. DOI: 10.1111/j.1438-8677.1996.tb00864.x
- [149] Fahey RC, Di Stefano DL, Meier GP, Bryan RN. Role of hydration state and thiol-disulfide status in the control of thermal stability and protein synthesis in wheat embryo. *Plant Physiology*. 1980;**65**:1062-1066. DOI: 10.1104/pp.65.6.1062
- [150] Kranner I, Grill D. Content of low-molecular-weight thiols during the imbibition of pea seeds. *Physiologia Plantarum*. 1993;**88**:557-562. DOI: 10.1111/j.1399-3054.1993.tb01371.x
- [151] Butt AD, Ohlrogge JB. Acyl carrier protein is conjugated to glutathione in spinach seed. *Plant Physiology*. 1991;**96**:937-942. DOI: 10.1104/pp.96.3.937
- [152] Kobrehel K, Yee BC, Buchanan BB. Role of the NADP/thioredoxin system in the reduction of  $\alpha$ -amylase and trypsin inhibitor proteins. *The Journal of Biological Chemistry*. 1991;**266**:16135-16140
- [153] Kobrehel K, Wong JH, Balogh A, Kiss F, Yee BC, Buchanan BB. Specific reduction of wheat storage proteins by thioredoxin. *Plant Physiology*. 1992;**99**:919-924. DOI: 10.1104/pp.99.3.919
- [154] Gerna D, Roach T, Stöggel W, Wagner J, Vaccino P, Limonta M, Kranner I. Changes in low-molecular-weight thiol-disulfide redox couples are part of bread wheat seed

- germination and early seedling growth. *Free Radical Research*. 2017;**51**:568-581. DOI: 10.1080/10715762.2017.1338344
- [155] Sarwin R, Walther C, Laskawy G, Butz B, Grosch W. Determination of free reduced and total glutathione in wheat flours by a radioisotope dilution assay. *Zeitschrift für Lebensmittel-Untersuchung und -Forschung*. 1992;**195**:27-32
- [156] Rhazi L, Cazalis R, Lemelin E, Aussenac T. Changes in the glutathione thiol–disulfide status during wheat grain development. *Plant Physiology and Biochemistry*. 2003;**41**:895-902. DOI: 10.1016/S0981-9428(03)00134-7
- [157] Köhler P, Hüttner S, Wieser H. Binding sites of glutathione in gluten proteins. In: Wrigley CW, editor. *Gluten 96*. North Melbourne, Australia: Royal Australian Chemical Institute; 1996. pp. 137-140
- [158] Luque A, Hegedus S. *Science and Engineering*. 2nd ed. Chichester: Wiley; 2011. p. 1132. DOI: 10.1002/9780470974704
- [159] Luque A, Hegedus S, editors. *Handbook of Photovoltaic Science and Engineering*. 2nd ed. Chichester: Wiley; 2011. p. 1132. DOI: 10.1002/978047974704
- [160] Ceccaroli B, Lohne O. Solar grade silicon feedstock. In: Luque A, Hegedus S, editors. *Handbook of Photovoltaic Science and Engineering*. 2nd ed. Chichester: Wiley; 2011. pp. 169-217. DOI: 10.1002/978047974704.ch5
- [161] Kajihara A, Harakawa T. Model of photovoltaic cell circuits under partial shading. In: *Proceedings of the IEEE International Conference on Industrial Technology (ICIT '05)*; 14-17 December 2005. Hong Kong. New York: IEEE; 2006. pp. 866-870



