



HAL
open science

RAZPOUTYNE project towards compact cooling techniques

Jesús Romero González, Fatima Rahmouni, Benjamin Pointard, Andrea Bertoldi, Jérôme Lodewyck, Rodolphe Le Targat

► **To cite this version:**

Jesús Romero González, Fatima Rahmouni, Benjamin Pointard, Andrea Bertoldi, Jérôme Lodewyck, et al.. RAZPOUTYNE project towards compact cooling techniques. FIRST-TF, Nov 2023, Nice, France. , 2023. hal-04295079

HAL Id: hal-04295079

<https://hal.science/hal-04295079>

Submitted on 20 Nov 2023

HAL is a multi-disciplinary open access archive for the deposit and dissemination of scientific research documents, whether they are published or not. The documents may come from teaching and research institutions in France or abroad, or from public or private research centers.

L'archive ouverte pluridisciplinaire **HAL**, est destinée au dépôt et à la diffusion de documents scientifiques de niveau recherche, publiés ou non, émanant des établissements d'enseignement et de recherche français ou étrangers, des laboratoires publics ou privés.

RAZPOUTYNE project towards compact cooling techniques

Impact of dead time on the clock short term stability

When interrogating the clock transition the result is judged by two criteria :

- **The uncertainty**, or how close we believe the corrected measured frequency is to the 'ideal' unperturbed value, and it will be reflected by how well are known the corrections made due to systematic effects shifting this frequency.
- **The stability**, when the values of repeated measurements are clustered close together and have minimal scatter over time.

The major limitation noise on the stability

Dick effect

Loading as fast as the coherence of the laser will reduce it

The project aims at loading **>10⁴ atoms into the optical trap in <150 ms.**

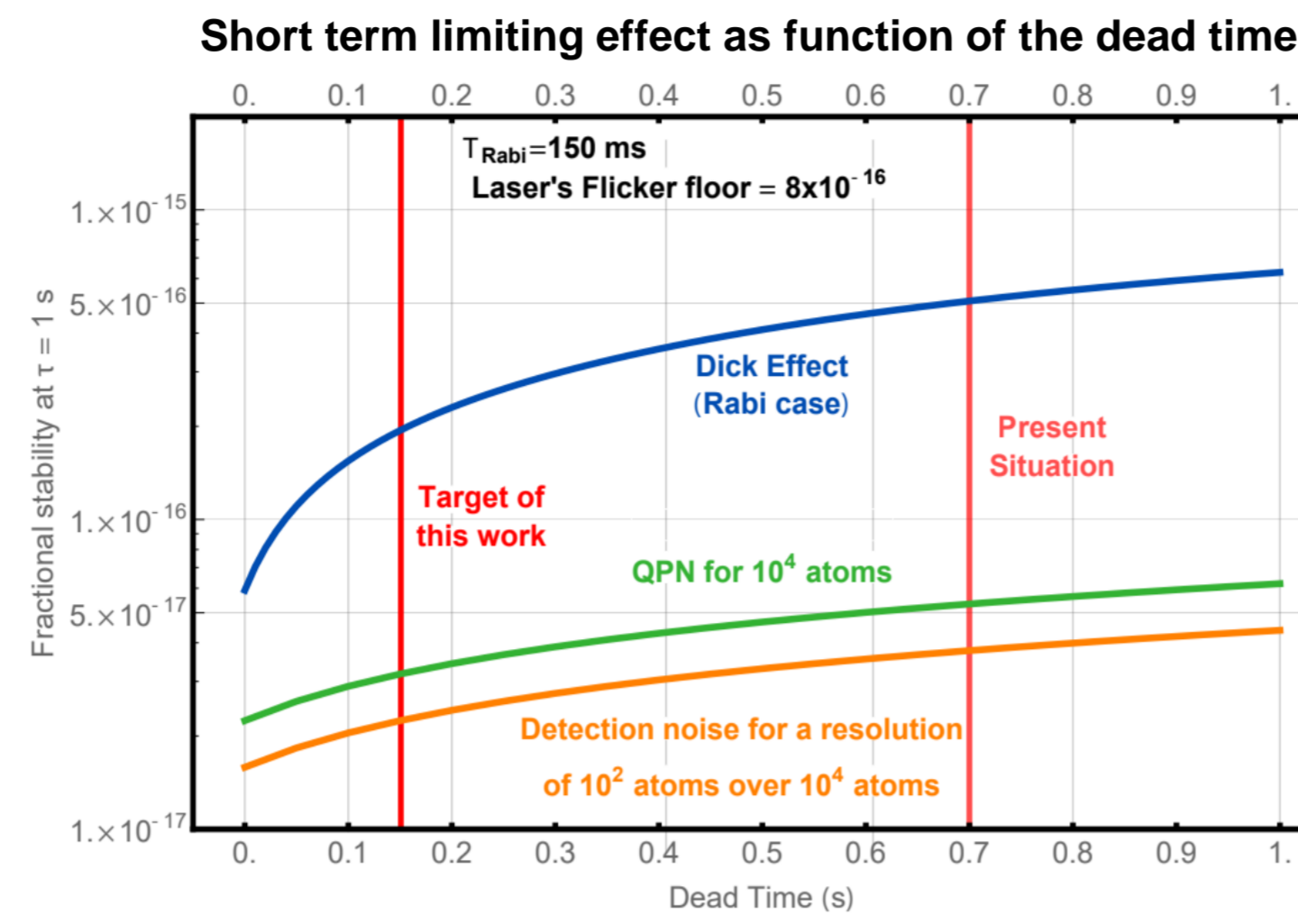

Simulation: Cooling cross

Cooling cross skeleton is based on the next three totally-related parameters:

- Velocity capture, being higher velocity the cross is able to cool down.
- Maximum (des)acceleration, defined by the cooling laser intensity.
- Length of the cross, defined as the minimum distance to stop atoms at $v=0$ m/s.

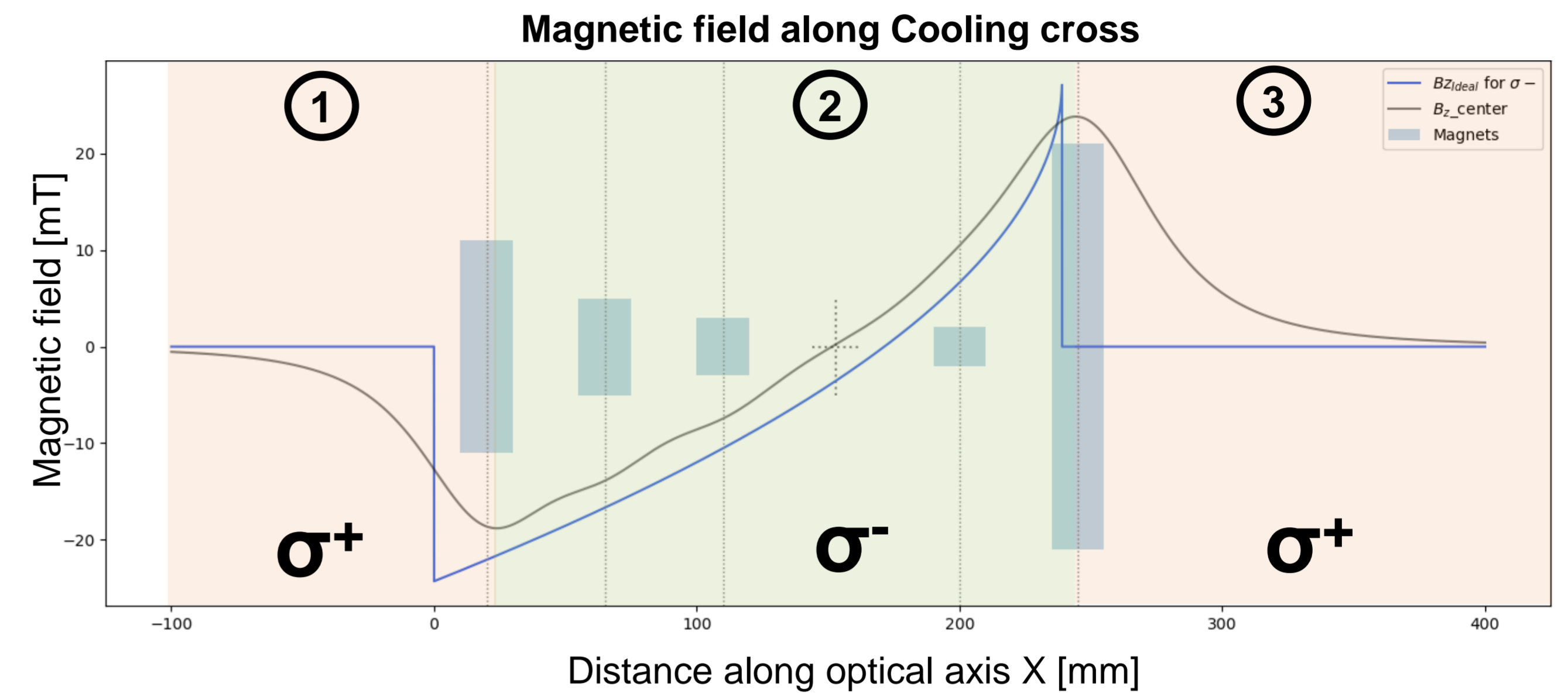

Region 1 and 2 can be use for deceleration (also region 3).

ZS beam contains of 50% σ^- and 50% σ^+ , since the polarization is perpendicular to B field.

Two different circular polarization play a roll:

- σ^+ light slow down atoms where $\nabla B > 0$, and they are capture in the 2D-MOT region.
- σ^- light slow down atoms where $\nabla B < 0$, and they are capture in the 2D-MOT region after the atomic beam "reflection".

The laser detuning (Δ_{laser}) able us to **select a velocity window**, being an offset.

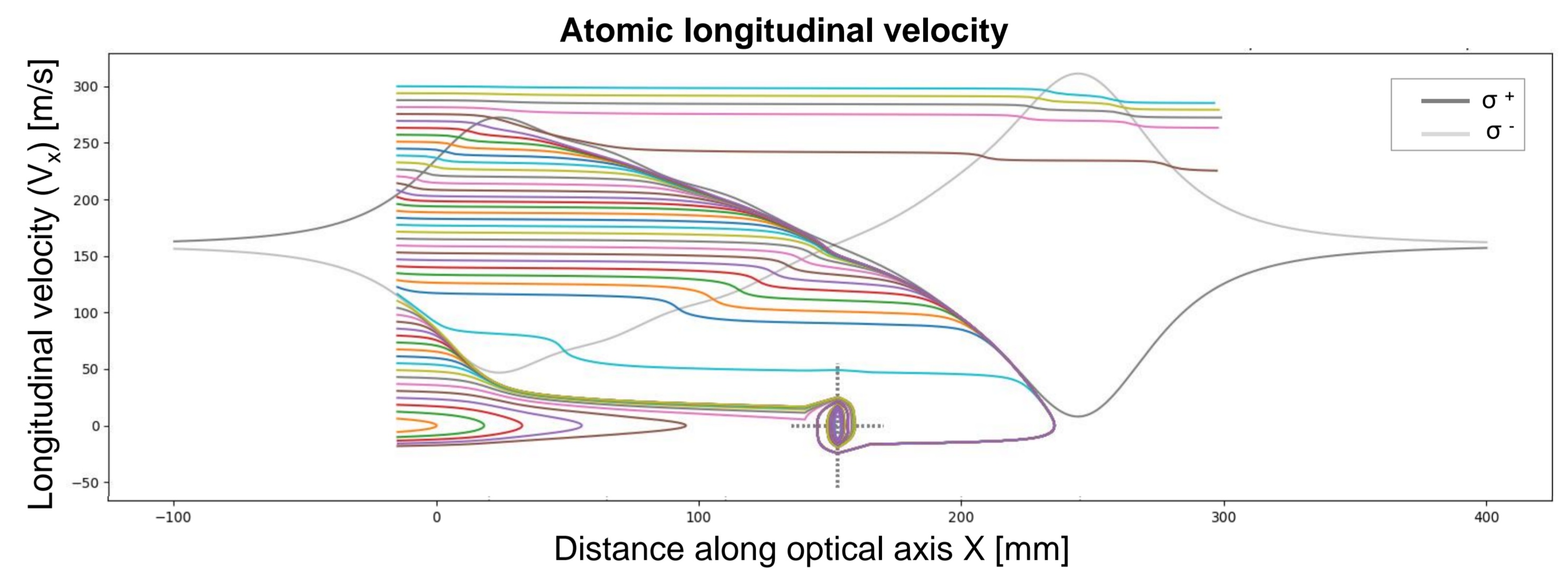

Motivation: Ultrafast loading rates in a optical lattice

Initial Idea: Desing a compact cooling system by combining in space and time two known components:

- **Zeeman Slower with permanent magnets :**

Doppler cooling & Zeeman shift

1D

Cool down longitudinal velocity

- **2D-MOT :**

Doppler cooling & Zeeman shift

2D

Cool down the radial plane of velocities

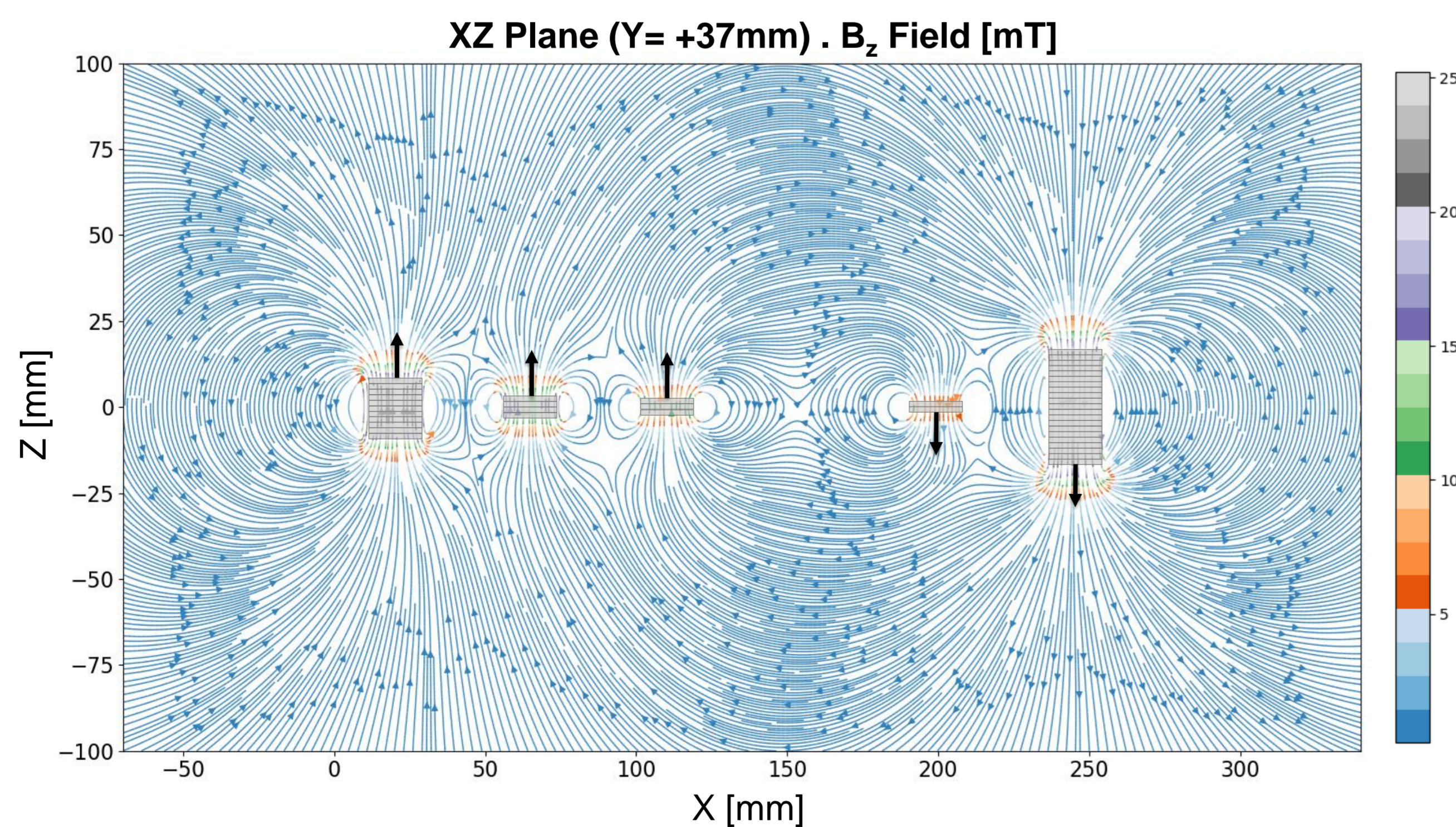
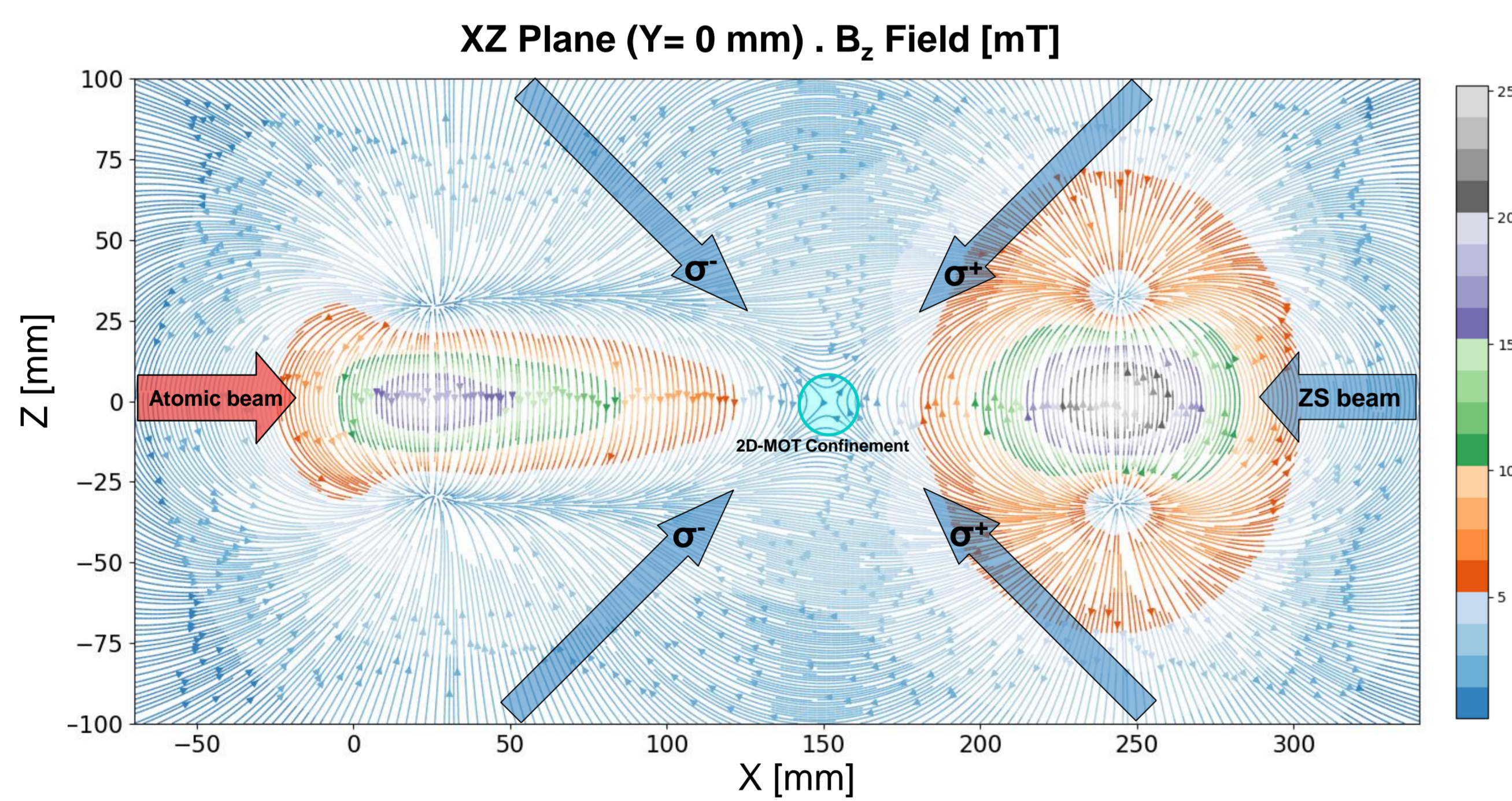
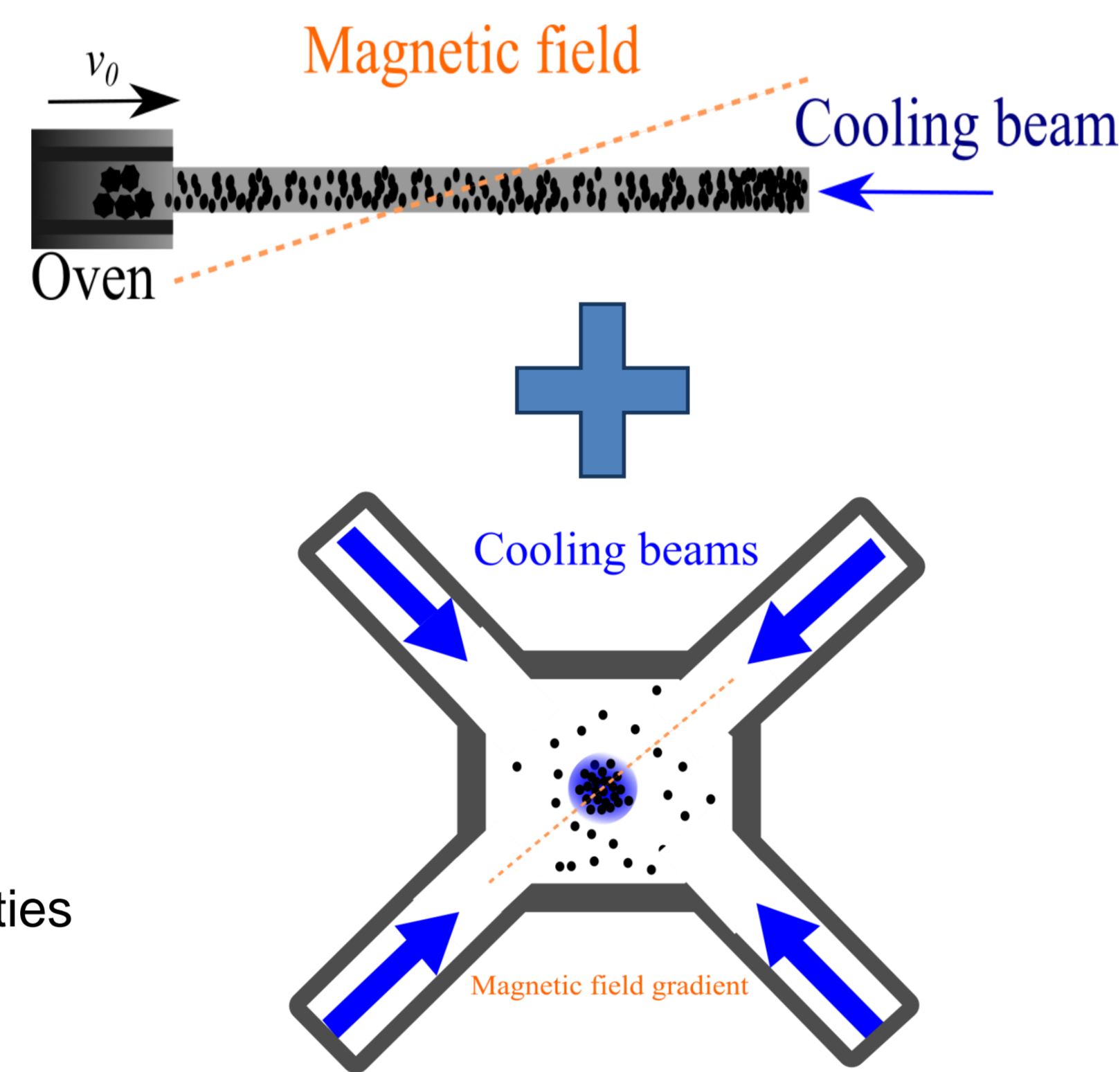

- Zeeman Slower**
- $P_{zs} = 80$ mW
 - $w_{zs} = 12.5$ mm
 - $\Delta_{laser} = -400$ MHz
 - $v_{cap} = 300$ m/s
- 2D-MOT**
- $P_{2D-MOT} = 60$ mW
 - $w_{2D-MOT} = 12.5$ mm
 - $\Delta_{2D-MOT} = 0.00$ MHz
 - $MOT_{pos} = 152.8$ mm

Arrangement of permanent magnets

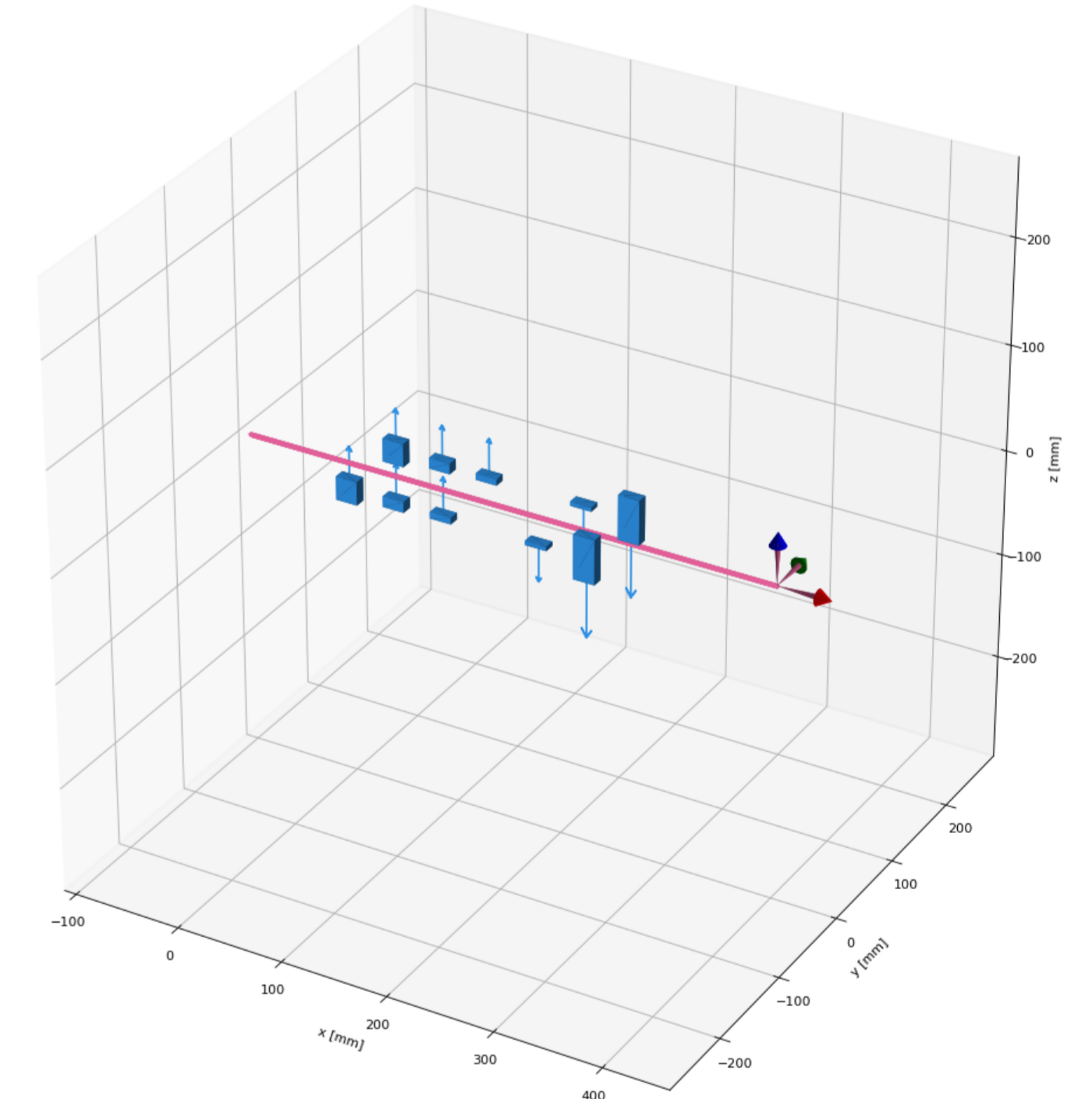

Structure design in SolidWorks®.

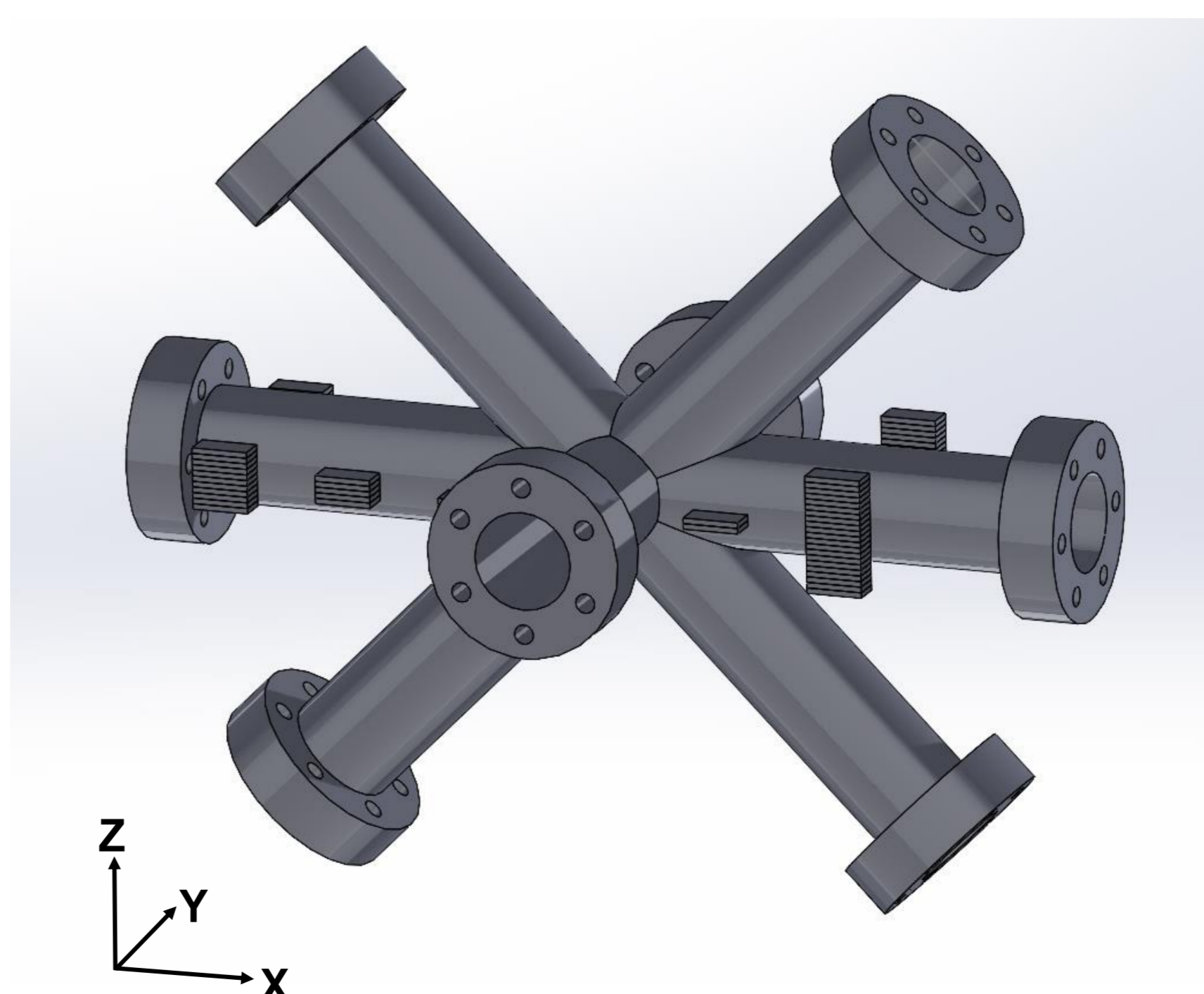

X axis, Zeeman slower beam is counter-propagating to the Yb atoms, who are launched from from the oven.

ZX plane, 4 counter-propagating beam create the 2D-MOT.

Along the Y axis:

- The Yb atoms are confinement in a cigarette shape along the center of the MOT.
- A pushing beam will translate the Yb cigarette shape to the 3D-MOT.

Key aspect:

- The same array of magnets create the necessary magnetic field for the Zeeman Slower and the magnetic gradient for the 2D-MOT.

Fundings

Reference

- [1] Tiecke, Tobias & Gensemer, Stephen & Ludewig, A. & Walraven, Jook. (2009). High-flux two-dimensional magneto-optical-trap source for cold lithium atoms. Physical Review A. 80. 13409-. 10.1103/PhysRevA.80.013409.
- [2] Lamporesi, Giacomo & Donadello, Simone & Serafini, Simone & Ferrari, G. (2013). Compact high-flux source of cold sodium atoms. The Review of scientific instruments. 84. 063102. 10.1063/1.4808375.
- [3] Ingo Nosske, Luc Couturier, Fachao Hu, Canzhu Tan, Chang Qiao, Jan Blume, et al. Two-dimensional magneto-optical trap as a source for cold strontium atoms. Phys. Rev. A 96, 053415 (2017).
- [4] Jianing Li, Kelvin Lim, Swarup Das, Thomas Zanon-Willette, Chen-Hao Feng, et al. Bi-color atomic beam slower and magnetic field compensation for ultracold gases. AVS Quantum Science, 2022, 4, .