

# Relationship between protein production and cell physiology



Olivier Borkowski  
BioRetroSynth



*B. subtilis* / *E. coli*

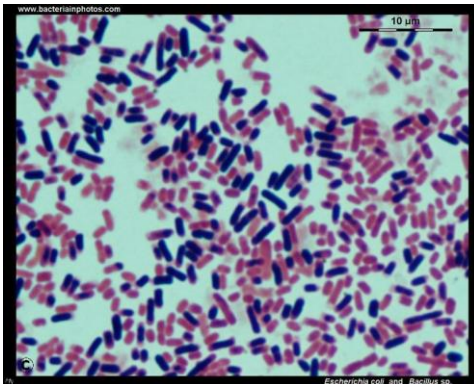

Lysate

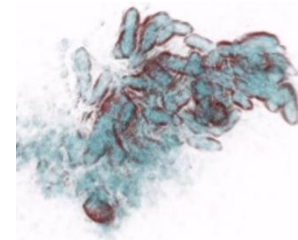



# Protein production ↔ Cell physiology

Cell physiology  
↓  
Protein production

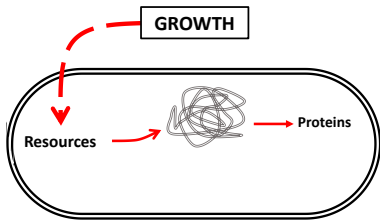

Protein production  
↓  
Cell physiology

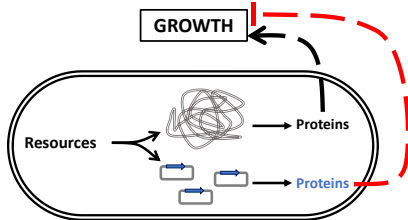

Protein production ↔ Cell physiology  
↓  
Tools for synthetic biology

*In vivo*



Imperial College  
London

*Cell-free*

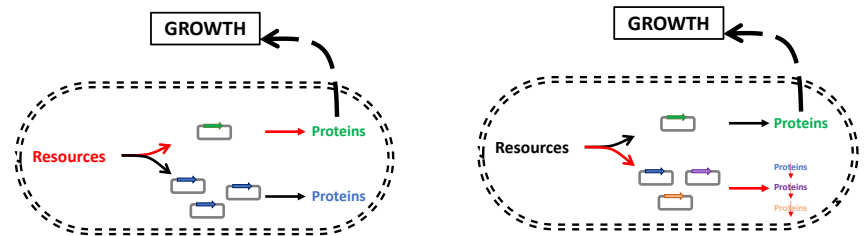

Imperial College  
London



Imperial College  
London

# Protein production ↔ Cell physiology

## Impact of growth rate on protein production

Cell physiology  
↓  
Protein production

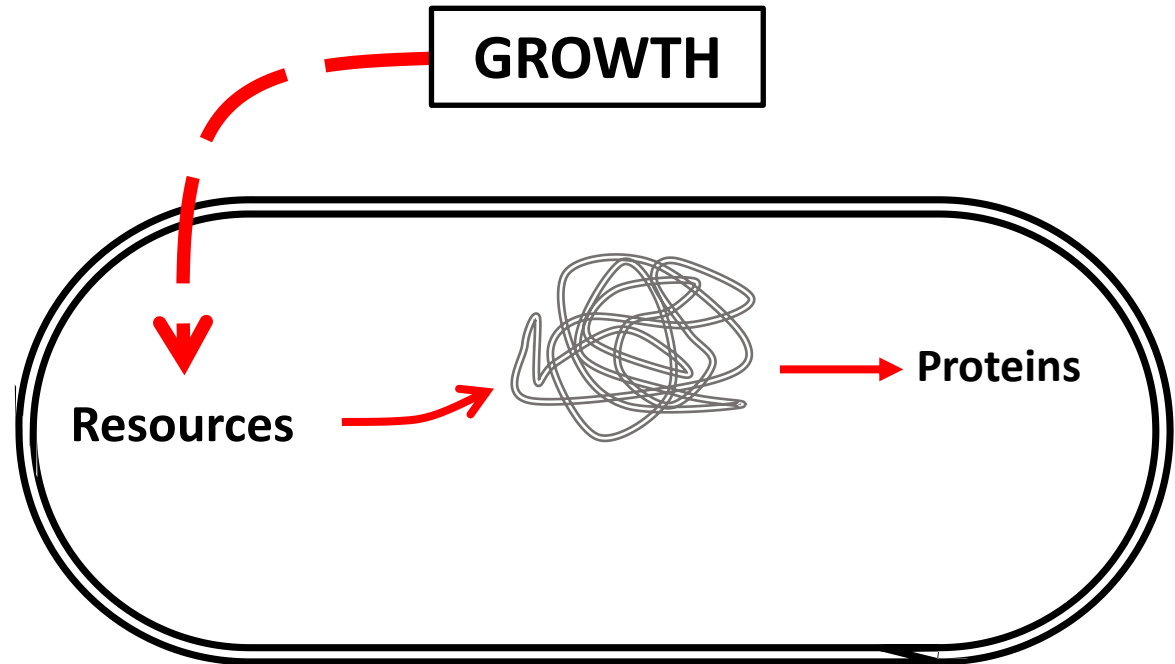
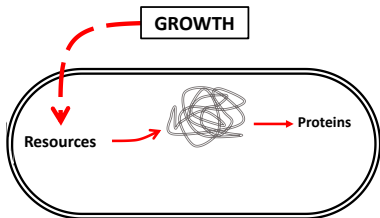

# Impact of growth rate on protein production

Can we predict protein abundance at any growth rate from mRNA concentration?

## Cell physiology is growth-rate dependent

TABLE 2 Macromolecular composition of exponentially growing *E. coli* B/r as a function of growth rate at 37°C<sup>a</sup>

Parameter	Symbol	Units	At $\tau$ (min) and $\mu$ (doublings per h):					Observed parameter(s)	Footnote
			$\tau$ , 100 $\mu$ , 0.6	$\tau$ , 60 $\mu$ , 1.0	$\tau$ , 40 $\mu$ , 1.5	$\tau$ , 30 $\mu$ , 2.0	$\tau$ , 24 $\mu$ , 2.5		
Protein/mass	$P_M$	$10^{17}$ aa/OD <sub>460</sub>	6.5	5.8	5.2	5.1	5.0	$P, M$	<i>b</i>
RNA/mass	$R_M$	$10^{16}$ nucl./OD <sub>460</sub>	4.3	4.9	5.7	6.6	7.8	$R, M$	<i>c</i>
DNA/mass	$G_M$	$10^8$ genomfs/OD <sub>460</sub>	18.3	12.4	9.3	8.0	7.6	$G, M$	<i>d</i>
Cell no./mass	$C_M$	$10^8$ cells/OD <sub>460</sub>	11.7	6.7	4.0	2.7	2.0	Cells/OD <sub>460</sub>	<i>e</i>
( $P + R + G$ )/ $M$	$PRD_M$	$\mu$ g/OD <sub>460</sub>	149	137	129	131	136		<i>f</i>
Protein/genome	$P_G$	$10^8$ aa residues	3.5	4.7	5.6	6.3	6.6	$P_M, G_M$	
RNA/genome	$R_G$	$10^7$ nucl. residues	2.3	4.0	6.1	8.2	10.3	$R_M, G_M$	
Origins/genome	$O_G$	Dimensionless	1.25	1.32	1.44	1.58	1.73	$C$	<i>g</i>
Protein/origin	$P_O$	$10^8$ aa residues	2.8	3.6	3.9	4.0	3.8	$P_G, O_G$	<i>g</i>
Protein/cell	$P_C$	$10^8$ aa residues	5.6	8.7	13.0	18.9	25.0	$P_M, C_M$	
$P_C$ ( $\mu$ g)		$\mu$ g/ $10^9$ cells	100	156	234	340	450		<i>h</i>
RNA/cell	$R_C$	$10^7$ nucl. residues	3.7	7.3	14.3	24.4	39.0	$R_M, C_M$	
$R_C$ ( $\mu$ g)		$\mu$ g/ $10^9$ cells	20	39	77	132	211		<i>h</i>
DNA/cell	$G_C$	genome equiv./cell	1.6	1.8	2.3	3.0	3.8	$C, D$	<i>i</i>
$G_C$ ( $\mu$ g)		$\mu$ g/ $10^9$ cells	7.6	9.0	11.3	14.4	18.3		<i>h</i>
Mass/cell	$M_C$	OD <sub>460</sub> units/ $10^9$ cells	0.85	1.49	2.5	3.7	5.0	$C_M$	<i>j</i>
$M_C$ ( $\mu$ g)		$\mu$ g dry weight/ $10^9$ cells	148	258	433	641	865	$\mu$ g/OD <sub>460</sub>	<i>k</i>
Sum $P + R + G$	$PRD_C$	$\mu$ g/ $10^9$ cells	127	204	322	486	679	$P_C, R_C, G_C$ (in $\mu$ g)	<i>k</i>
Origins/cell	$O_C$	no./cell	1.96	2.43	3.36	4.70	6.54	$C, D$	<i>l</i>
Termini/cell	$T_C$	no./cell	1.23	1.37	1.54	1.74	1.94	$D$	<i>l</i>
Replication forks/cell	$F_C$	no./cell	1.46	2.14	3.64	5.92	9.19	$C, D$	<i>l</i>

# Protein concentration decreases with increasing growth rate

**Previous knowledge:** The concentration of a constitutively expressed protein decreases with increasing growth rate

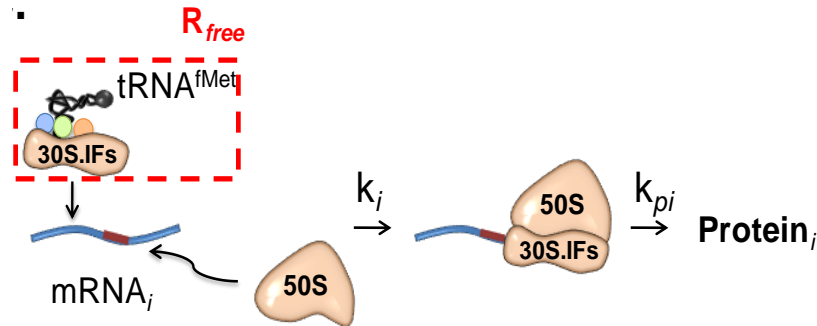
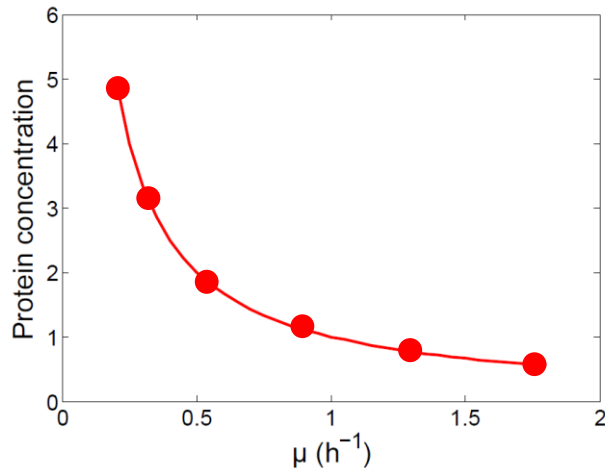

$$\left[ \begin{array}{l} [P_i] = \frac{[m_i] \lambda'_i}{\mu} \\ \lambda'_i = k_i [R_{\text{free}}] \end{array} \right]$$

**Previous theory:** the concentration decreases due to the only resulting dilution (Constant mRNA concentration and Constant translation efficiency)

**With this model:** mRNA concentration (measure with tiling arrays) and protein concentration (proteomic) partially correlate

# mRNA concentration increases with increasing growth rate

*fbaA*, a constitutively expressed genes in *B. subtilis*

mRNA<sub>Tot</sub> abundance increases as much as the rate of growth

mRNA<sub>fbaA</sub> Abundance of the constitutive mRNA<sub>fbaA</sub> increases faster than mRNA<sub>Tot</sub>

**New knowledge**: The concentration of a constitutively expressed mRNA increase with increasing growth rate

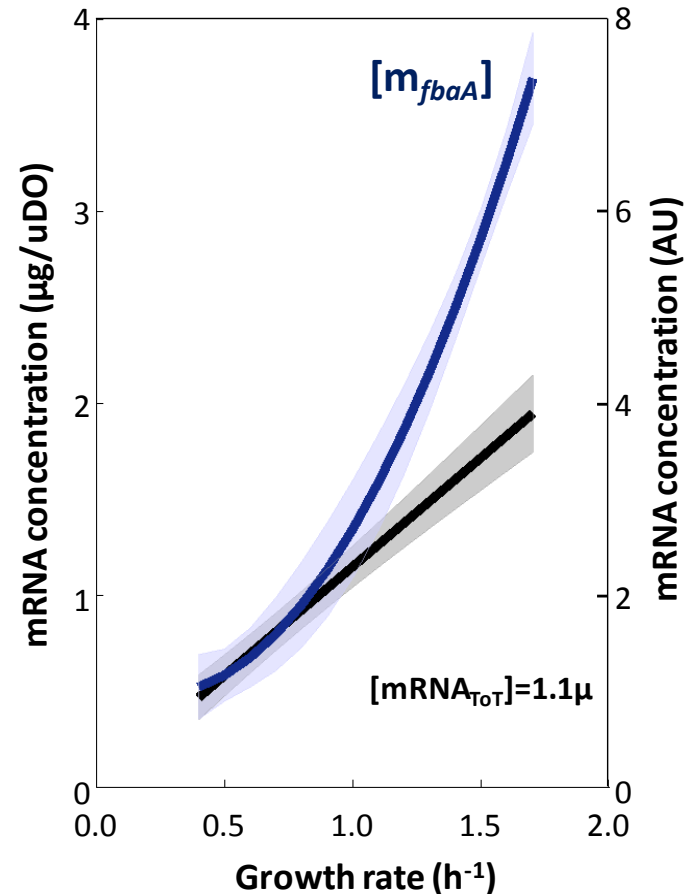

# Translation efficiency decreases with increasing growth rate

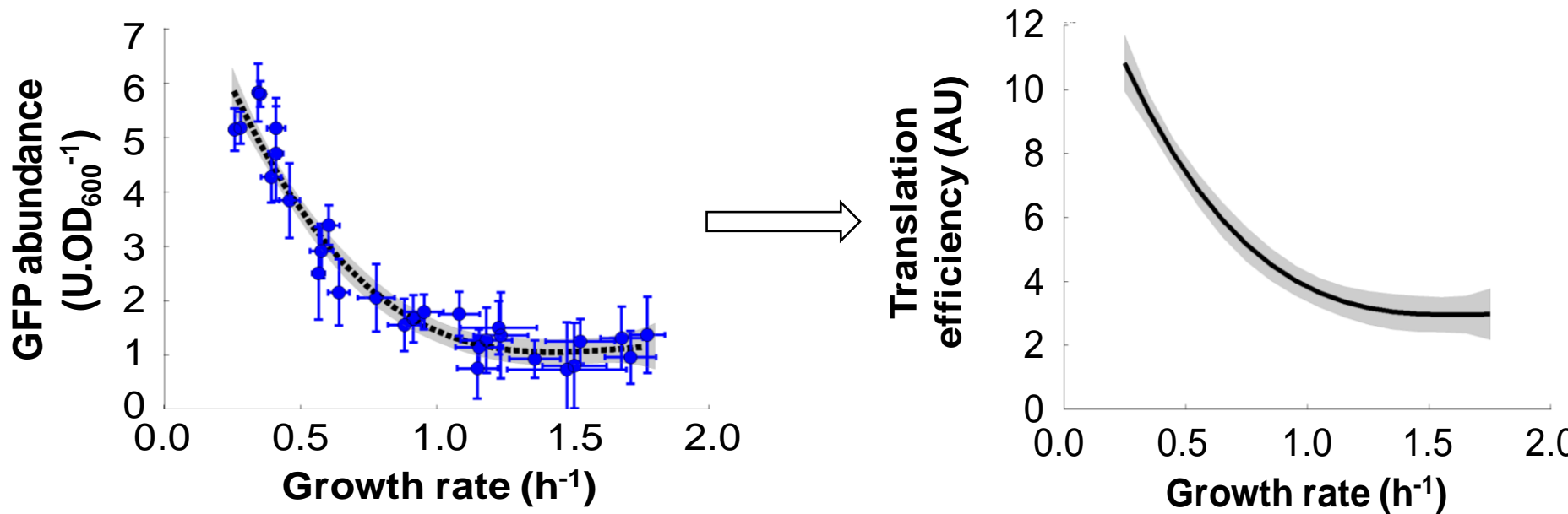

**New knowledge:** Translation efficiency drops with increasing growth rate

**With this model:** mRNA concentration (measure with tiling arrays) and protein concentration (proteomic) exhibit low correlation



# A new model of the translation process

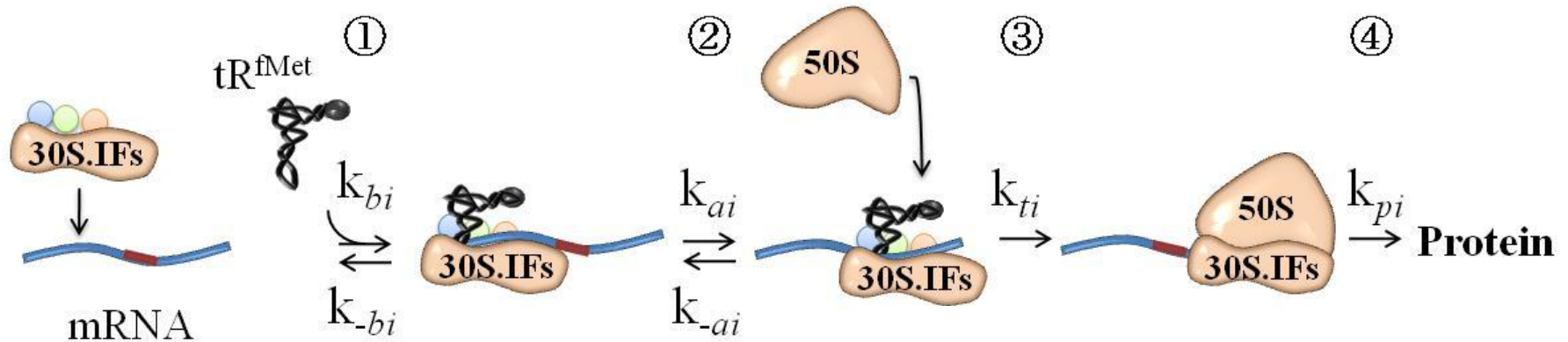

$$\left[ \begin{array}{l} [P_i] = \frac{[m_i]}{\mu} \lambda'_i \\ \lambda'_i = k_i [R_{free}] \end{array} \right]$$

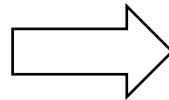

$$\left[ \begin{array}{l} [P_i] = \frac{[m_i]}{\mu} \lambda_i \\ \lambda_i = \frac{K_{1i} [R_{free}]}{K_{2i} + [R_{free}]} \end{array} \right]$$

# Properties of our model

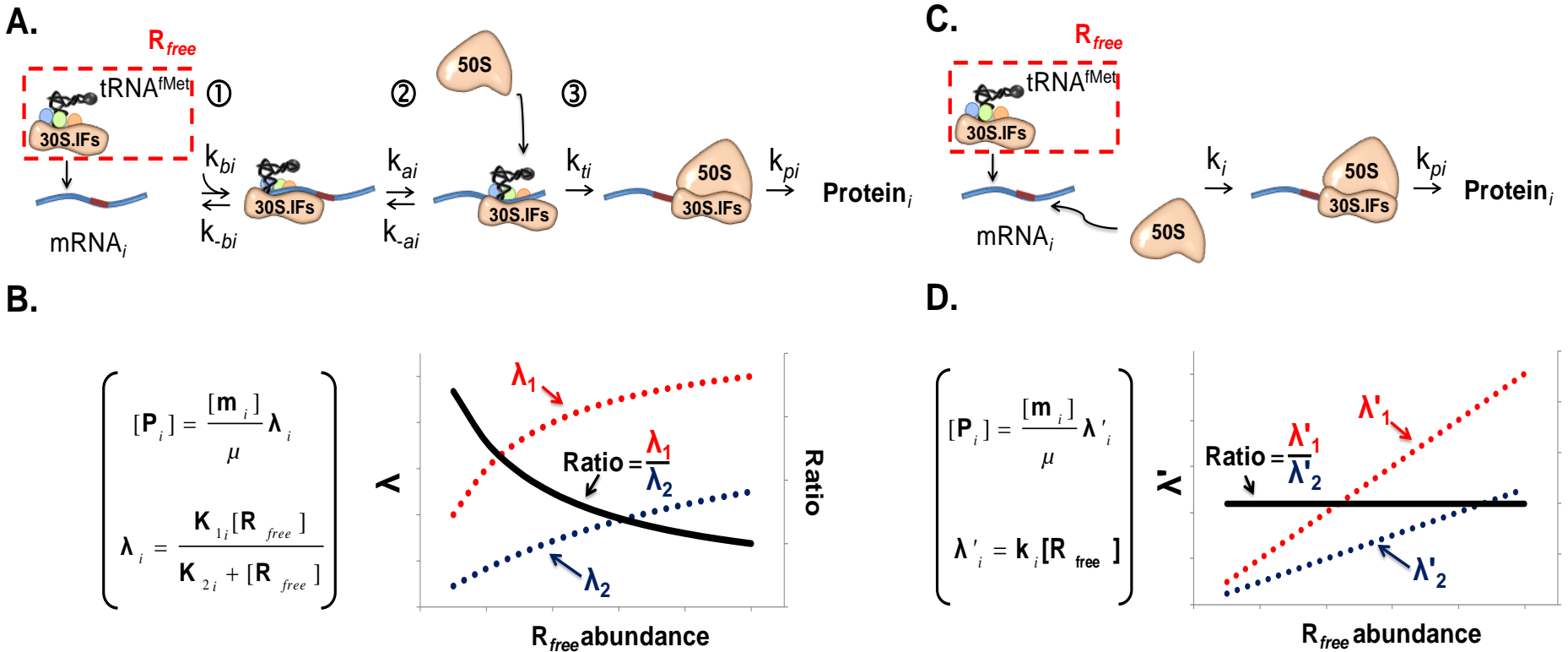

**New model:** Constitutively expressed protein behave differently as a function of the growth rate

# Experimental validation

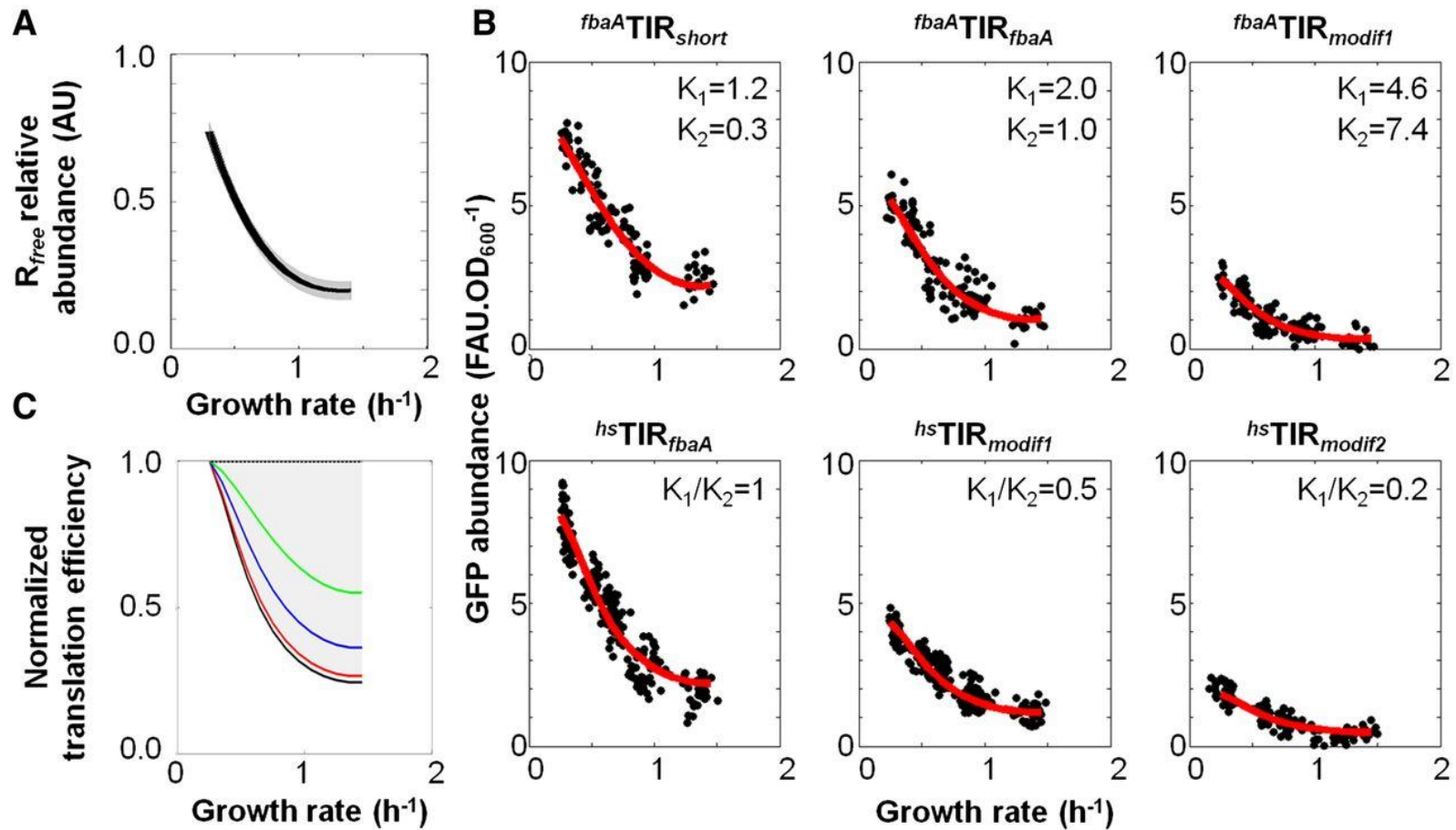

**Data validate the model:** Nonlinear translation efficiencies entail differential drops in protein abundances with increasing growth rate

# Impact of growth rate on protein production

---

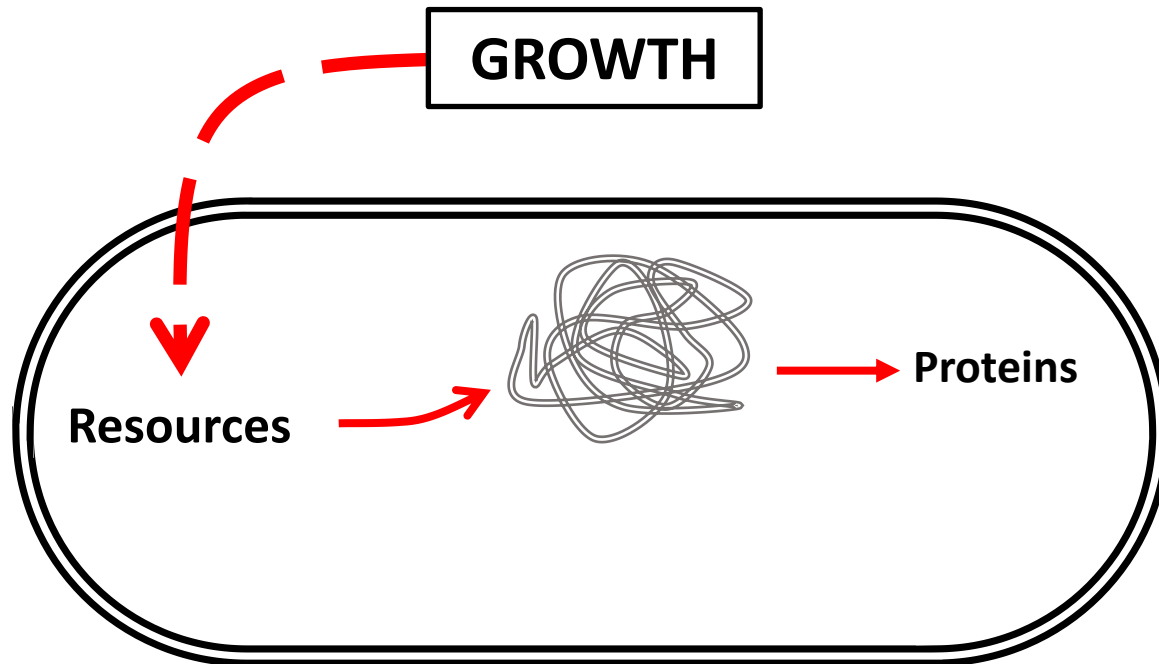

A new regulation based on growth-rate dependent protein production

# Protein production $\Leftrightarrow$ Cell physiology

Protein production  
↓  
Cell physiology

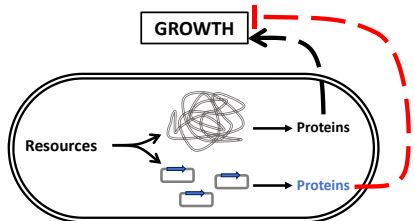

## Impact of protein production on growth rate (Burden)

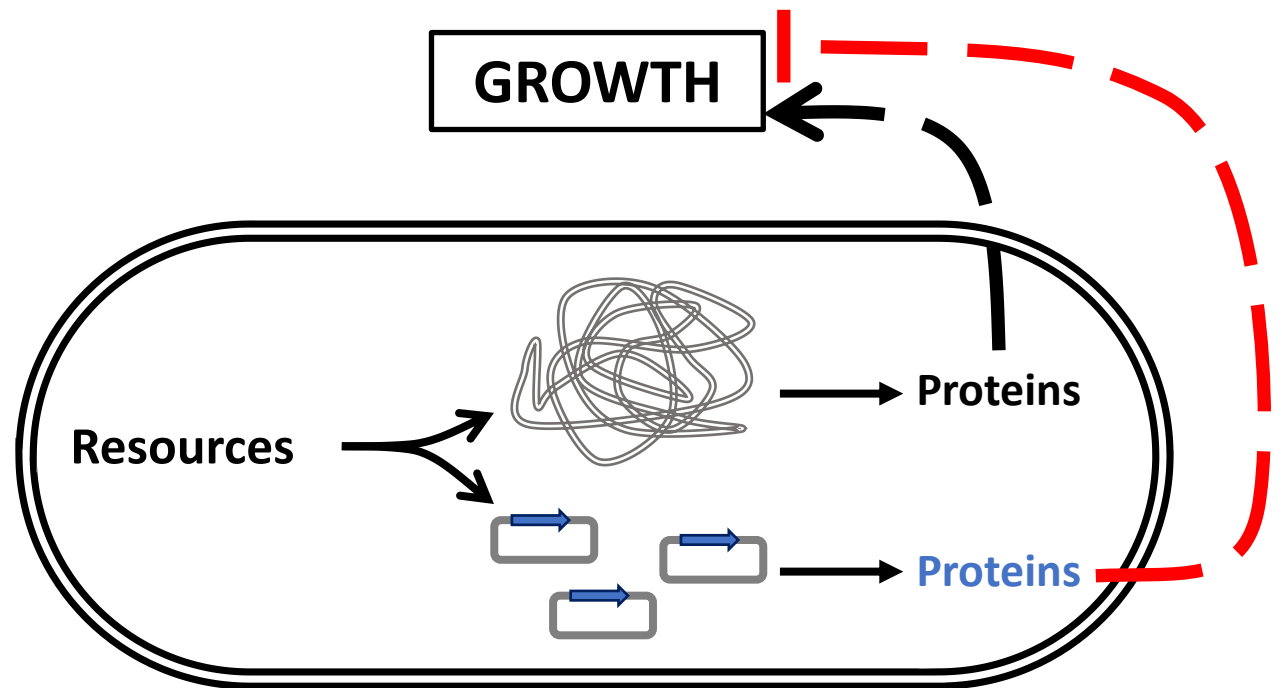

# Impact of protein production on growth rate (Burden)

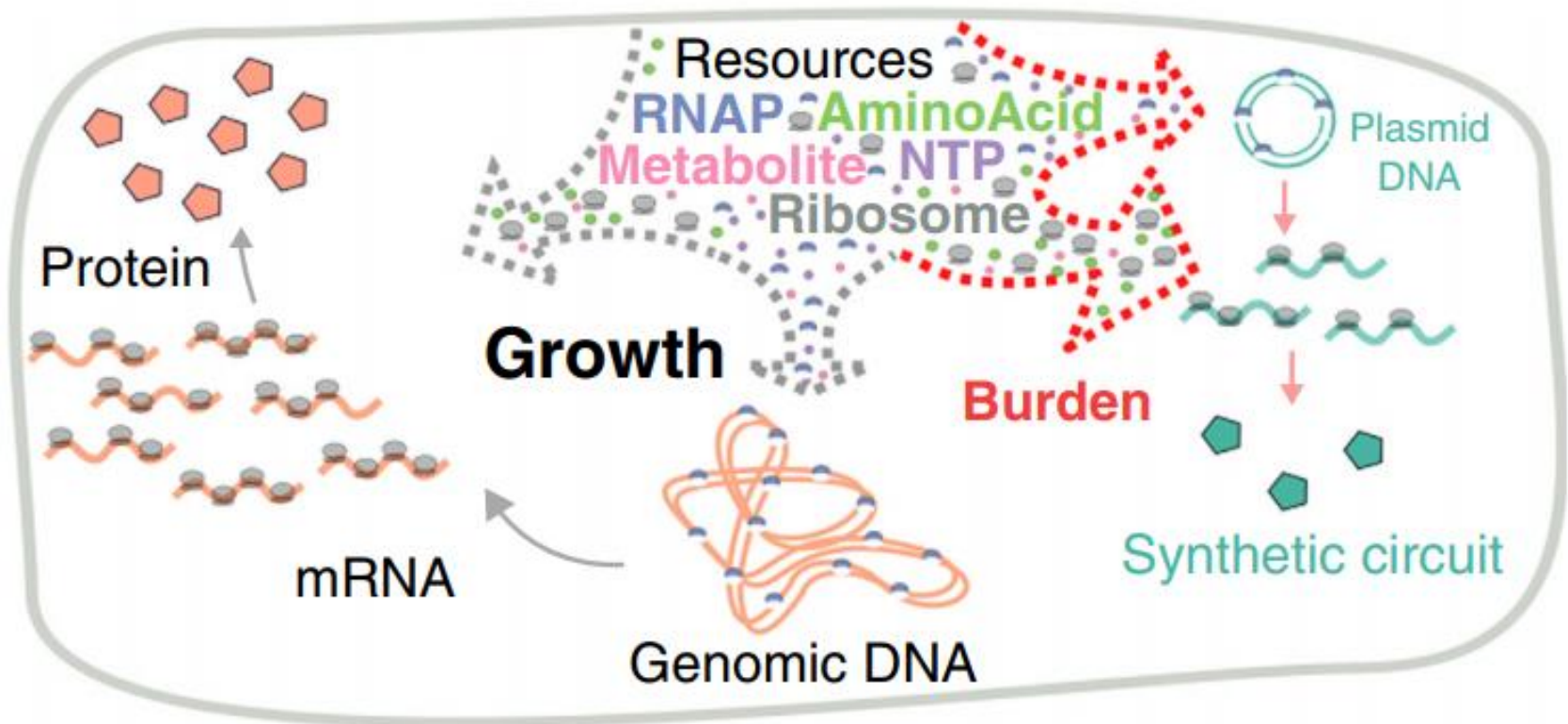

# The impact of synthetic constructs on the host cell

## Low yield (toxicity)

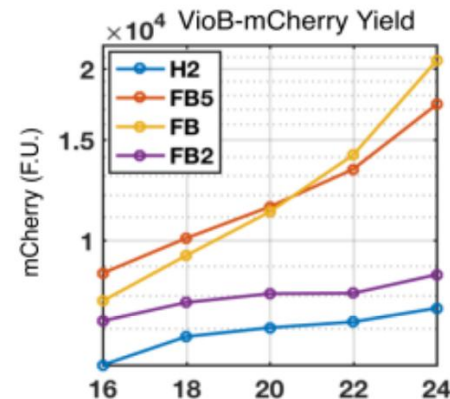
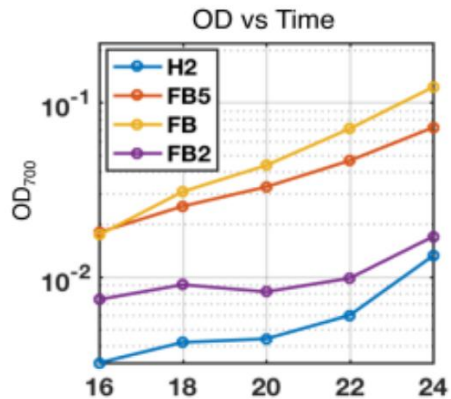

## Cell size

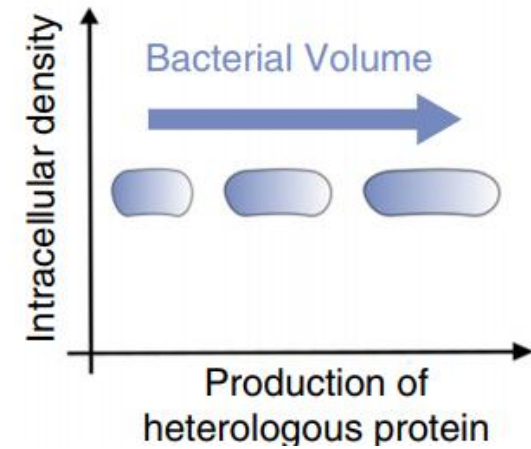

## Stress-response

Overload of ClpX by production of heterologous protein

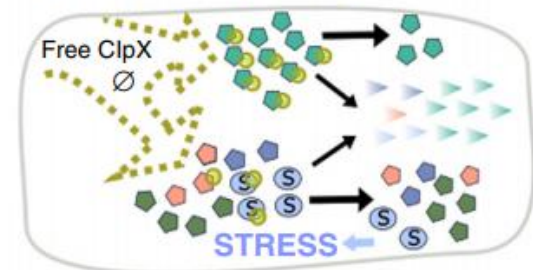

## Escape mutants

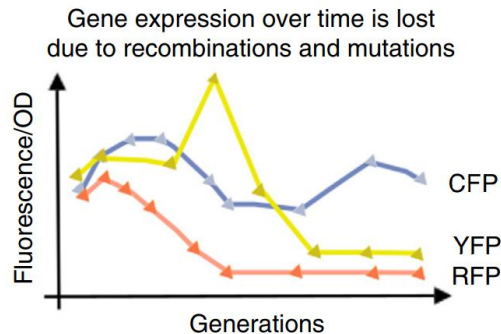

# Protein production $\Leftrightarrow$ Cell physiology

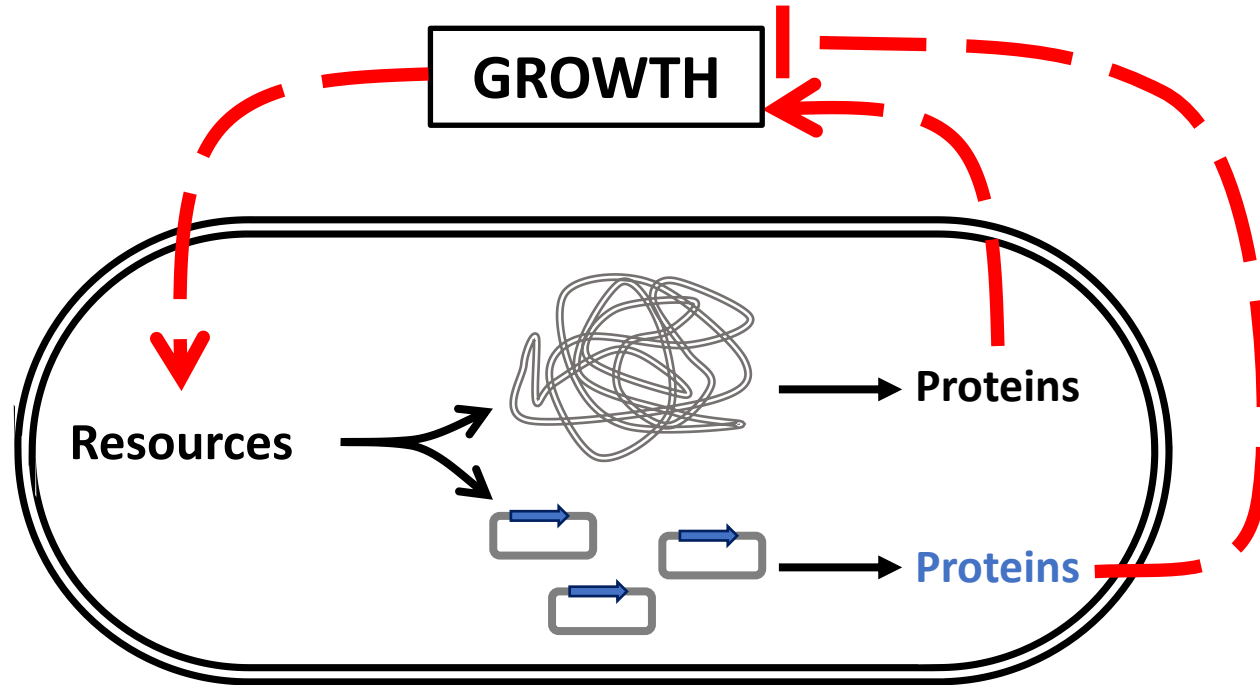

Can we use, predict or decouple protein production and growth in bacteria?



# Protein production ↔ Cell physiology

Protein production ↔ Cell physiology



Tools for synthetic biology

In vivo

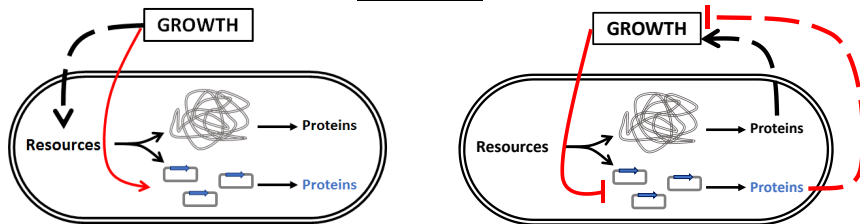

Imperial College London

Cell-free

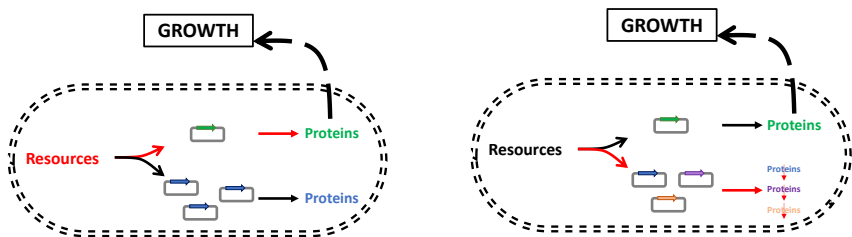

Imperial College London



Can we design a synthetic circuit activated by a growth rate variation over time?

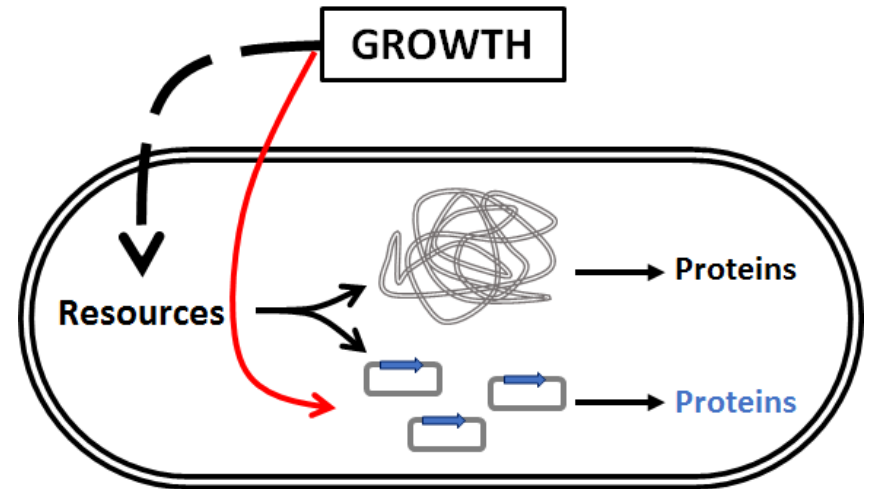

Borkowski O, Subsoontorn P, Endy D: Hands-free control of heterologous gene expression in batch cultures. (Bioarchiv)

# Using change in cell physiology to control gene expression

## Coupling a growth-phase dependent sensor and a DNA switch

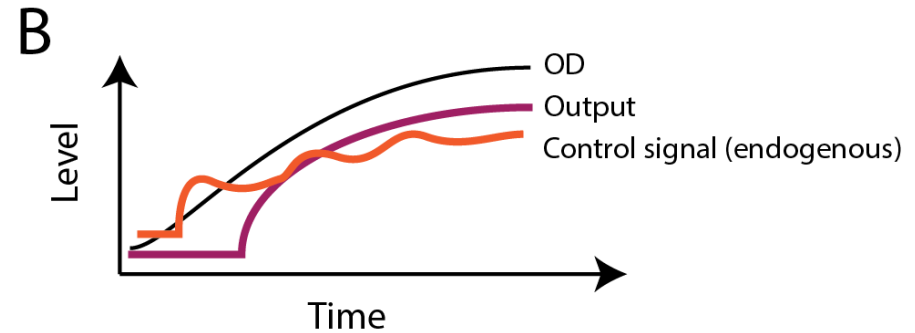
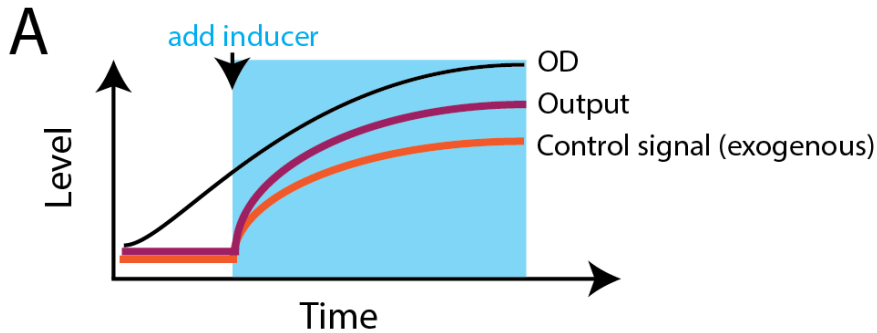

## DNA switches

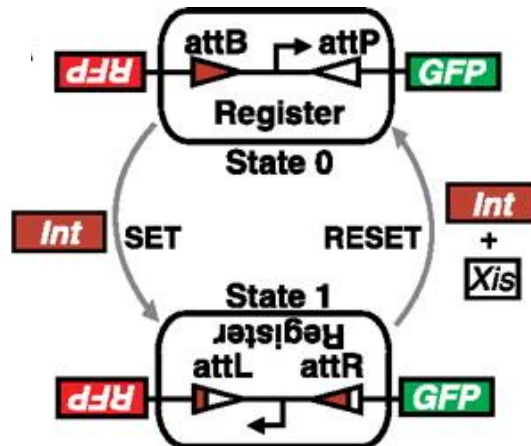

Bonnet J, Subsoontorn P, Endy D: Rewritable digital data storage in live cells via engineered control of recombination directionality. PNAS 2012

# A sensor of growth-phase

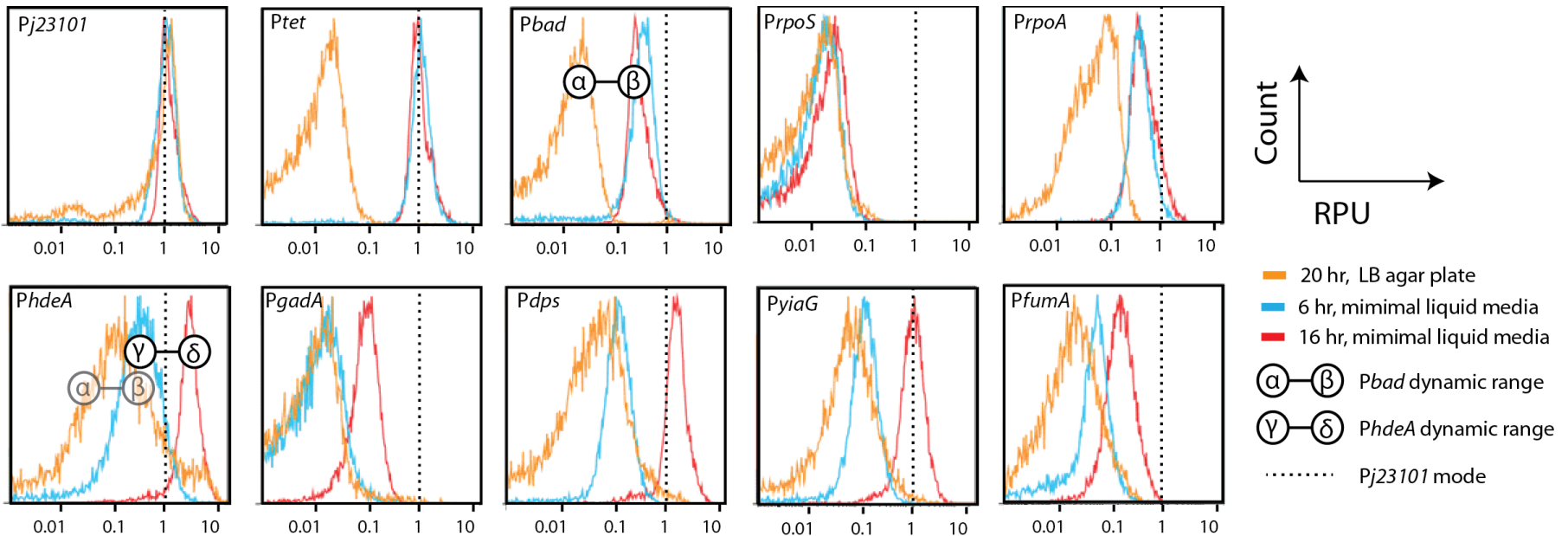

# Single-use switch

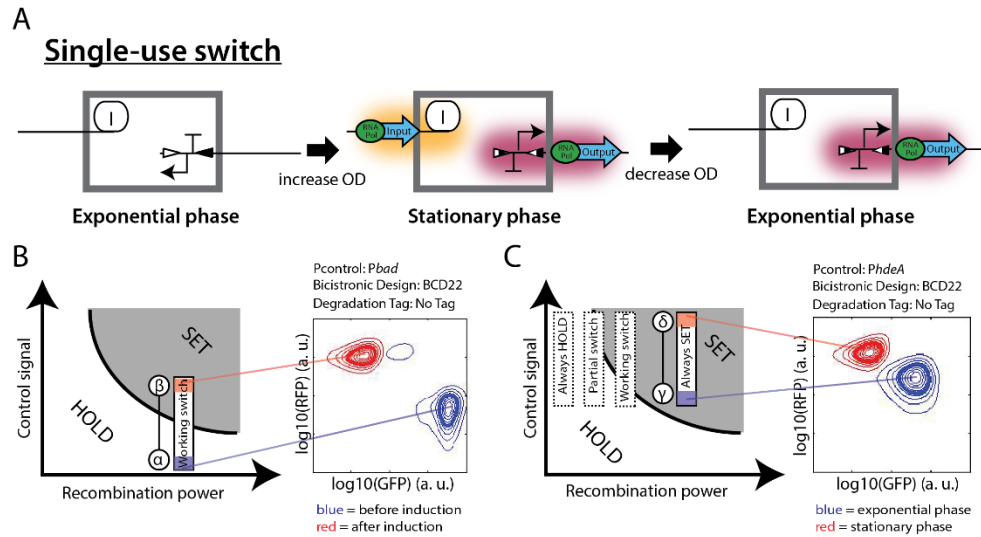

# Reversible switch

A

## Reversible switch

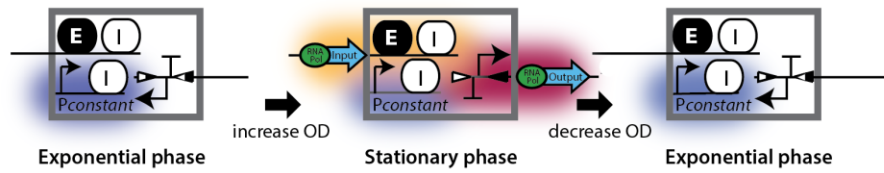

B

Pcontrol: *Pbad*  
Pconstant: *Ptet*

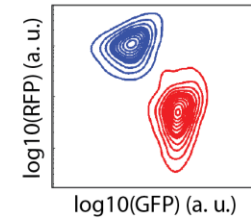

log<sub>10</sub>(GFP) (a. u.)

blue = pre-arabinose induction  
red = post-arabinose induction

Pcontrol: *PfumA*  
Pconstant: *PrpoA*

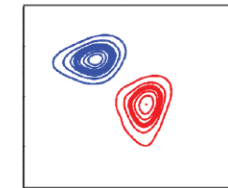

log<sub>10</sub>(GFP) (a. u.)

blue = exponential phase  
red = stationary phase

# Protein production ↔ Cell physiology

Protein production ↔ Cell physiology



Tools for synthetic biology

In vivo

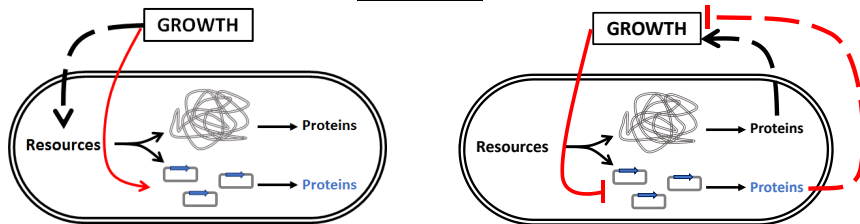

Imperial College  
London

Cell-free

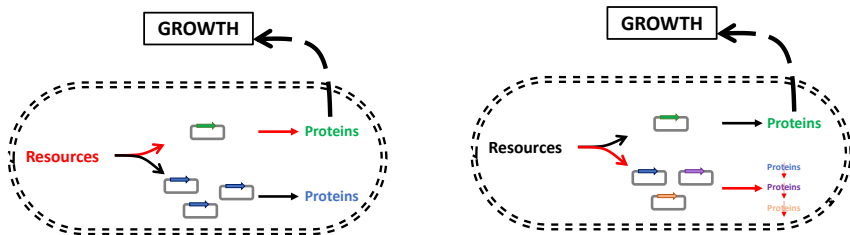

Imperial College  
London



Can we design a synthetic circuit  
activated by a growth rate  
variation over time?

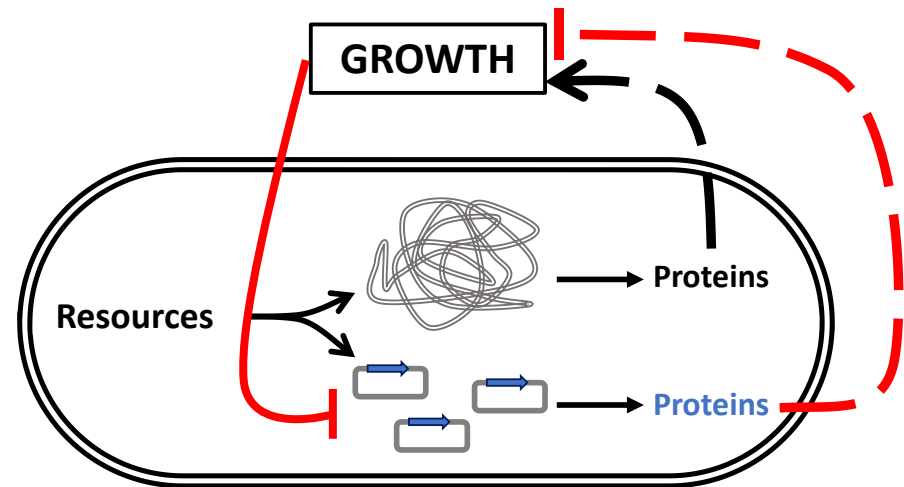

Ceroni F, Boo A, Furini S, Gorochoowski TE, **Borkowski O**, Ladak YN, Awan AR, Gilbert C, Stan GB, Ellis T: Burden-driven feedback control of gene expression. *Nature Methods*. 2018.

# Control of gene expression to reduce burden in *E. coli*

## Feed back control using burden sensor and crispr-dcas9

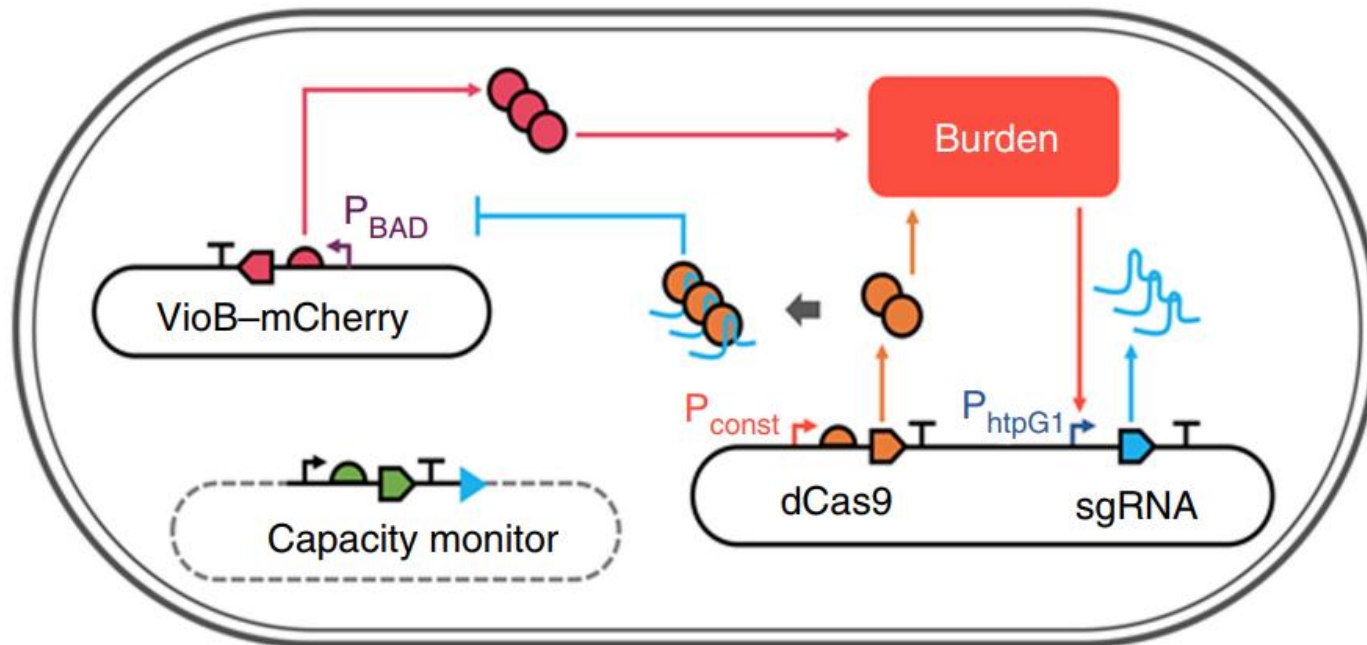

# A sensor of burden

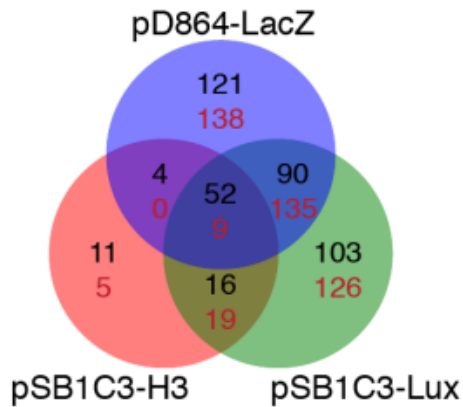

shared	pSB1C3-Lux	pSB1C3-H3	pD864-LacZ
ibpB $\sigma^{32/54}$	<b>ibpB</b> $\sigma^{32/54}$	<b>tktA</b> N/A	<b>gadC</b> $\sigma^{24/70/S}$
ibpA $\sigma^{32}$	<b>ibpA</b> $\sigma^{32}$	<b>malE</b> $\sigma^{70}$	ibpB $\sigma^{32/54}$
ycjX $\sigma^{32}$	<b>ypdH</b> N/A	<b>ptsA</b> N/A	<b>gadA</b> $\sigma^{70/S}$
htpG $\sigma^{32}$	<b>ypdG</b> N/A	<b>metE</b> N/A	<b>gadB</b> $\sigma^{70/S}$
dnaK $\sigma^{32}$	<b>ypdD</b> $\sigma^{28}$	<b>ydeN</b> $\sigma^{70}$	ibpA $\sigma^{32}$
mutM $\sigma^{32}$	<b>ypdF</b> N/A	<b>malM</b> $\sigma^{70}$	<b>hdeB</b> $\sigma^{70/S}$
dnaJ $\sigma^{32}$	<b>malE</b> $\sigma^{70}$	<b>lamB</b> $\sigma^{70}$	<b>hdeD</b> $\sigma^{70}$
hslO $\sigma^{32}$	<b>ypdE</b> N/A	<b>clpB</b> $\sigma^{32/70}$	<b>hdeA</b> $\sigma^{70/S}$
hslR $\sigma^{32}$	<b>cysC</b> $\sigma^{32}$	<b>malF</b> $\sigma^{70}$	<b>slp</b> $\sigma^{70}$
clpB $\sigma^{32/70}$	<b>lamB</b> $\sigma^{70}$	<b>htpG</b> $\sigma^{32}$	<b>gadE</b> $\sigma^{70/S}$

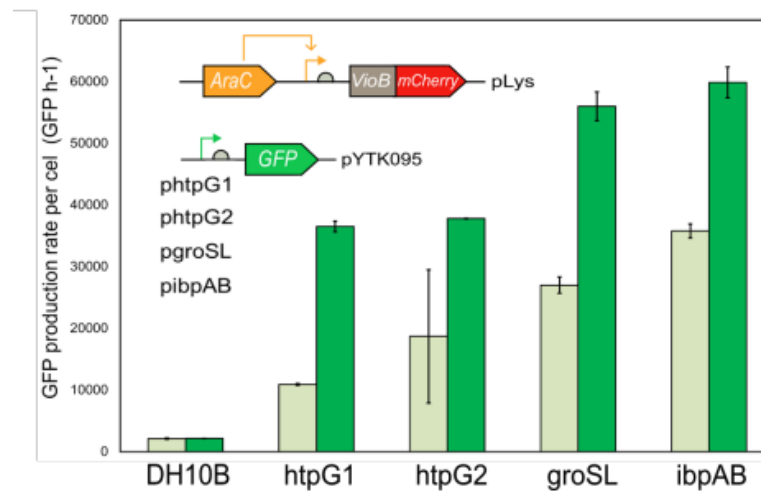
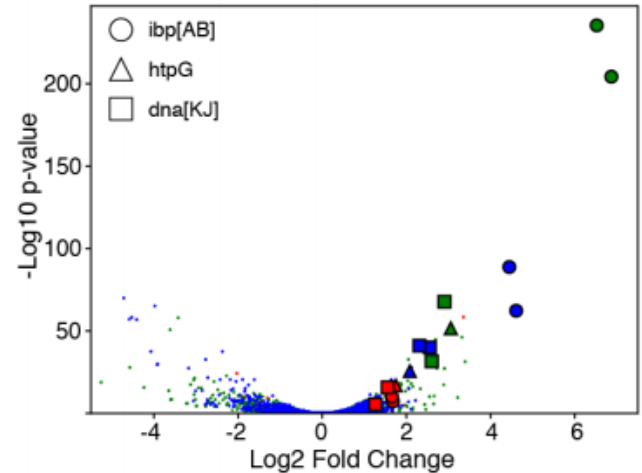



# Control of gene expression to reduce burden in *E. coli*

## Functionality of the feedback

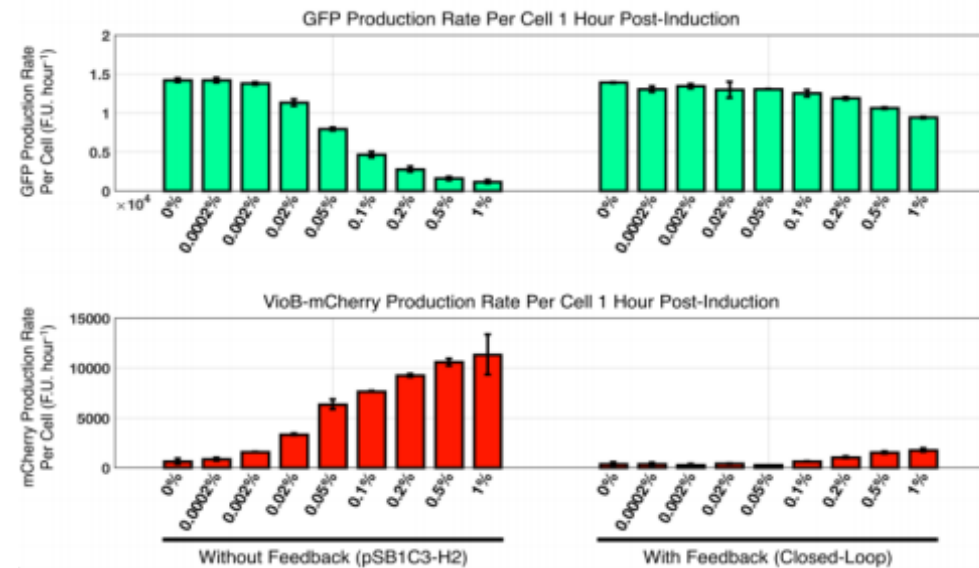

## Tunable feedback system

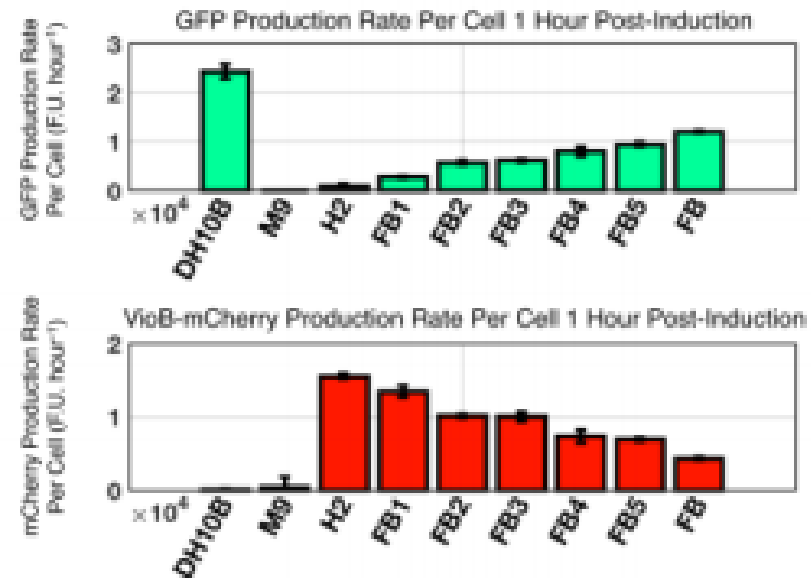

# Control of gene expression to reduce burden in *E. coli*

## Advantages of burden-driven feedback control system

### Robustness and portability

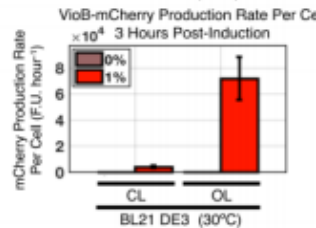
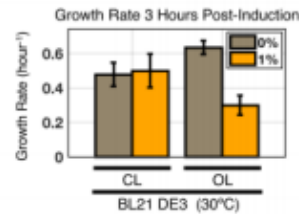
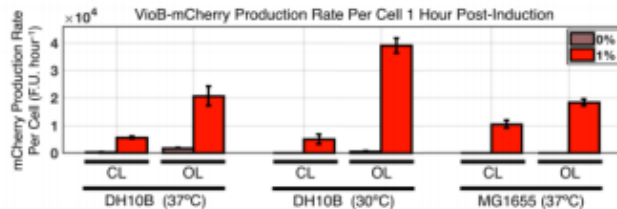
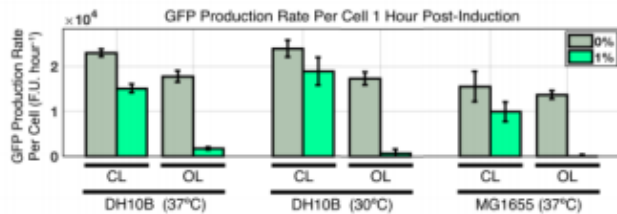

### 24 hour time-course experiment

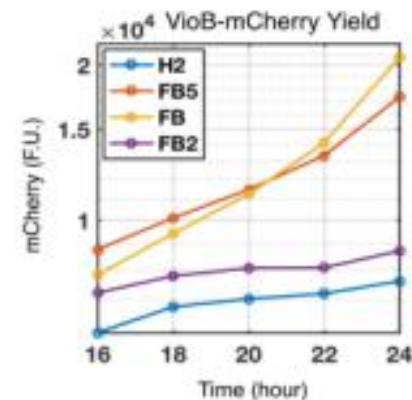
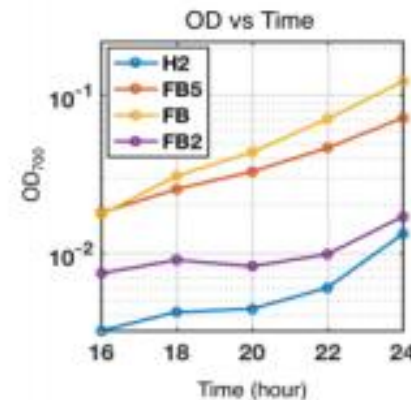

# Protein production ↔ Cell physiology

Protein production ↔ Cell physiology



Tools for synthetic biology

In vivo

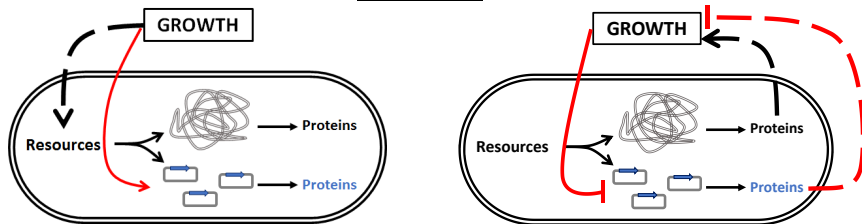

Imperial College London

Cell-free

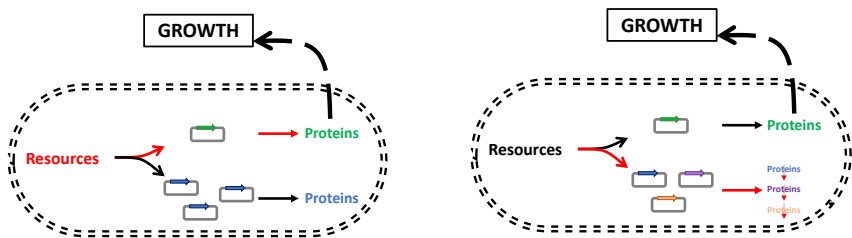

Imperial College London



Can we design a synthetic circuit activated by a growth rate variation over time?

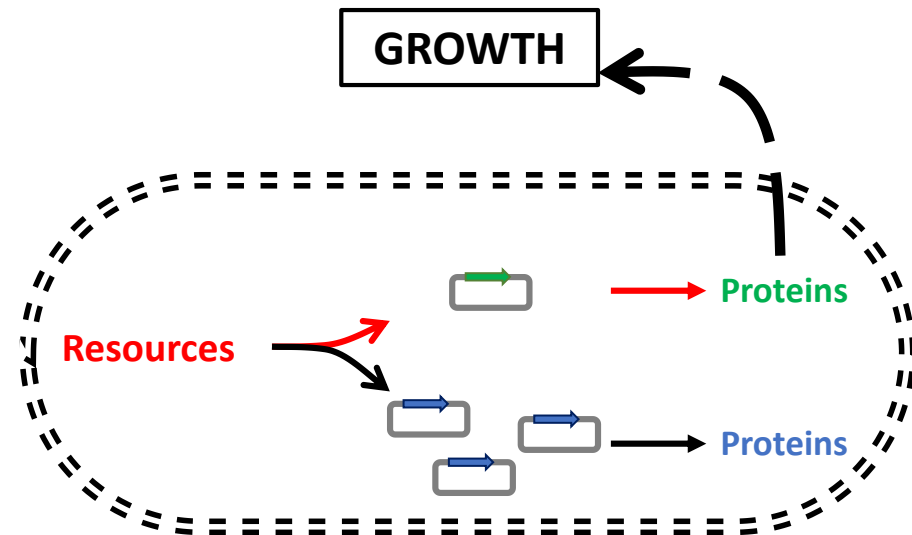

**Borkowski O**, Bricio C, Murgiano M, Rotshchild-Mancinelli B, Stan GB, Ellis T: Cell-free prediction of protein expression costs for growing cells. *Nature Communications*. 2018.

# Cell-free Platform

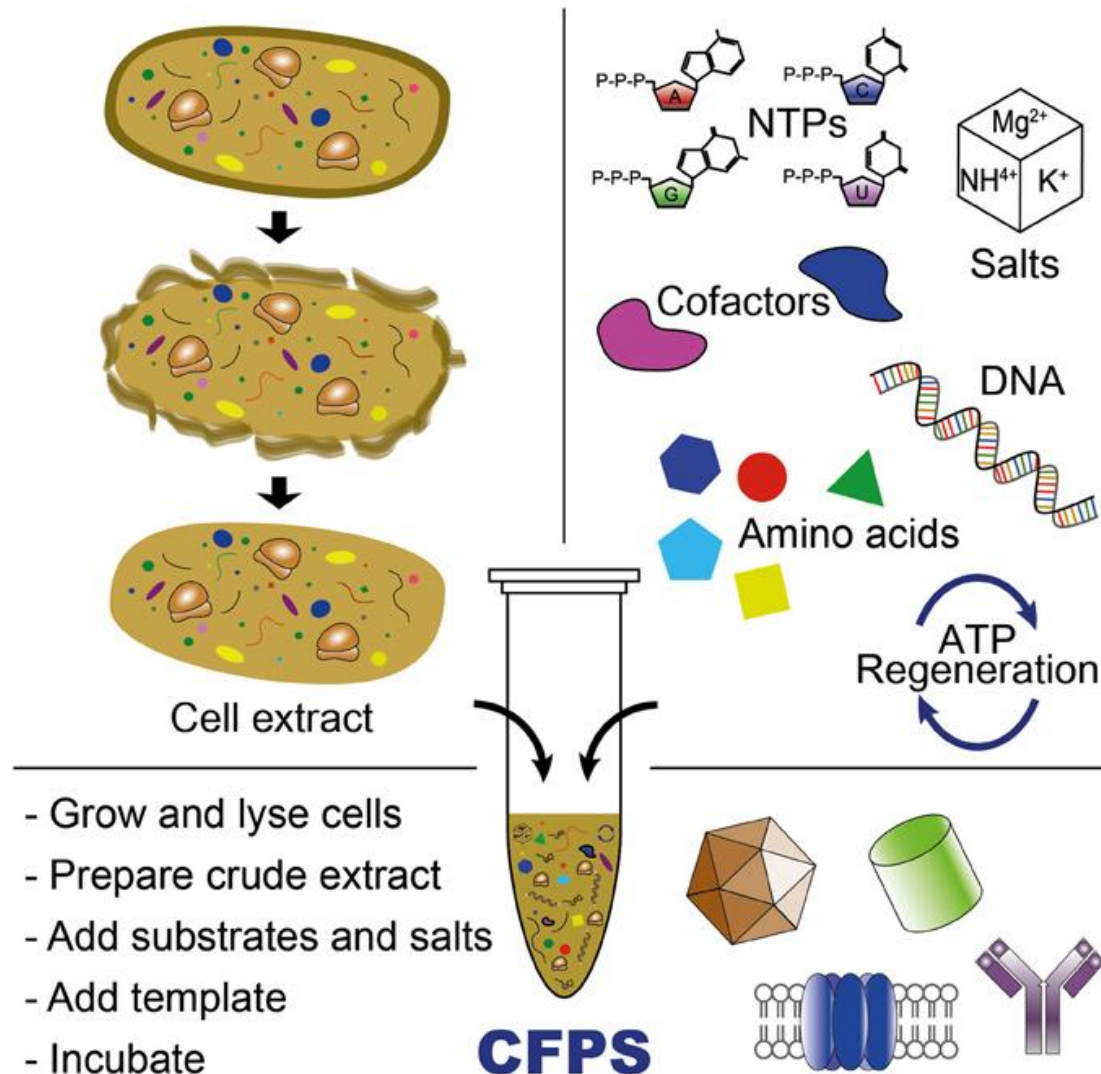

# Burden prediction using Cell-free

Can we predict burden using cell-free system?

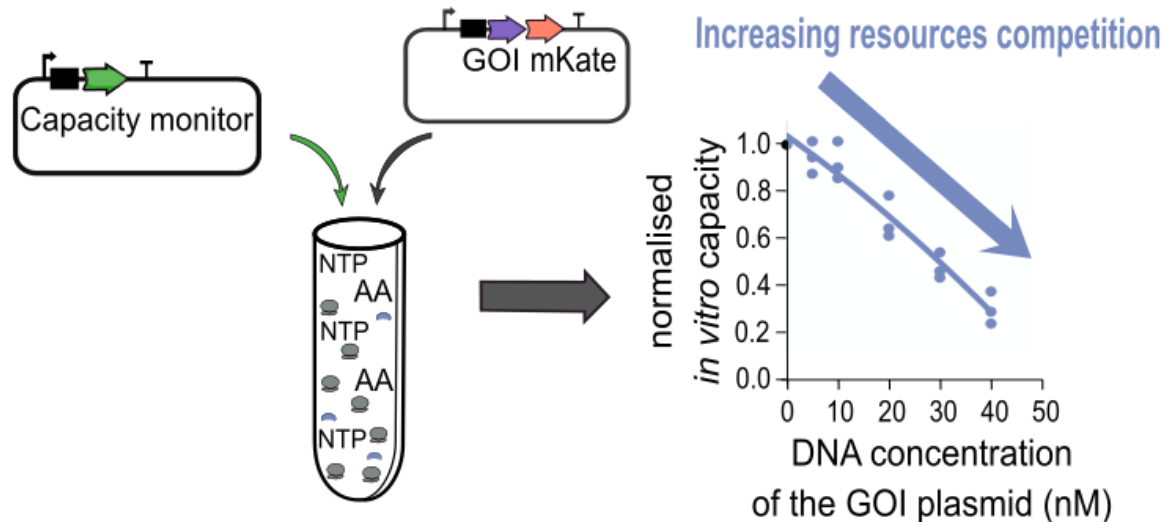

# Burden prediction using Cell-free

## Correlation between cell-free and *in vivo* measurements

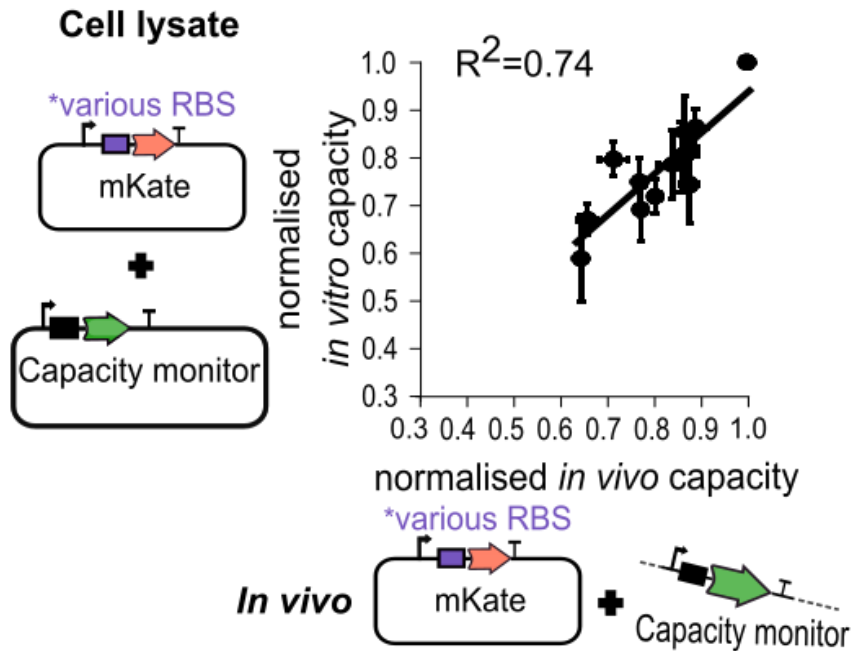

# Burden prediction using Cell-free

Can we predict burden of enzymatic pathways?

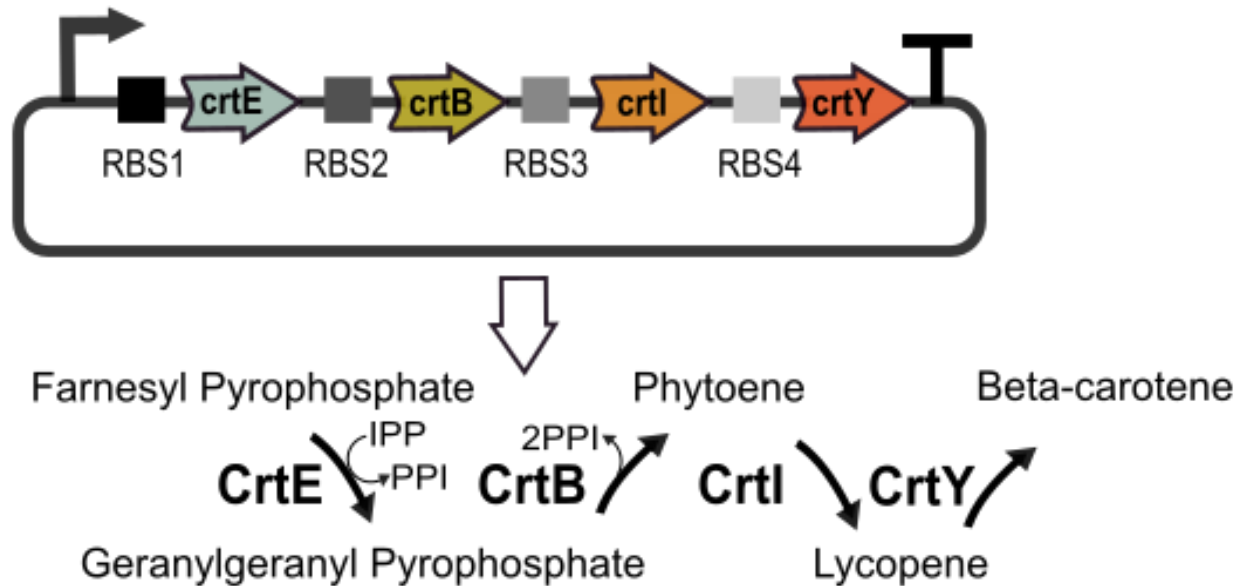

# Burden prediction using Cell-free

## Difference between metabolic and resource burden

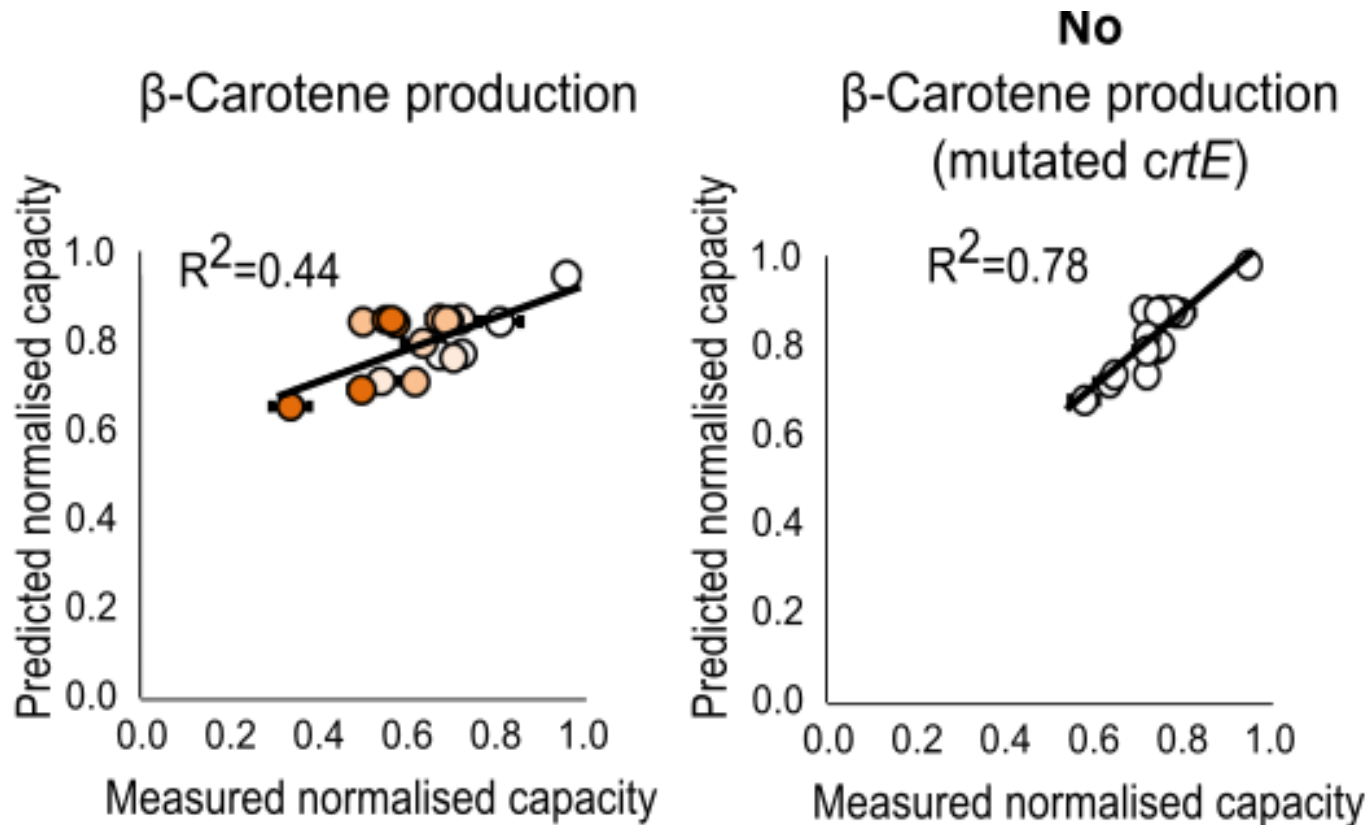



# Protein production ↔ Cell physiology

Protein production ↔ Cell physiology



Tools for synthetic biology

In vivo

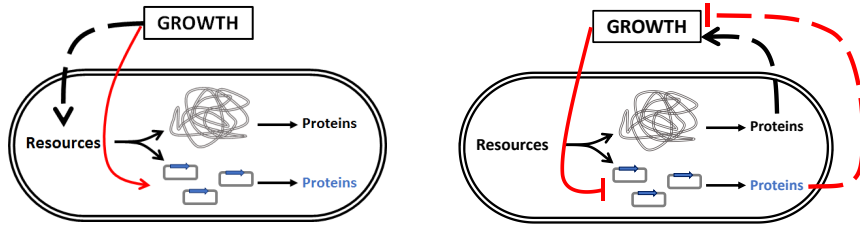

Imperial College London

Cell-free

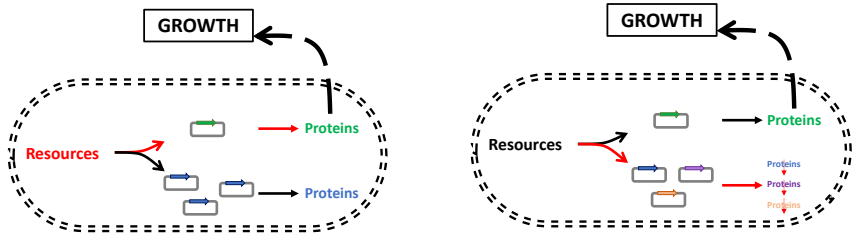

Imperial College London



Can we improve protein production using cell-free?

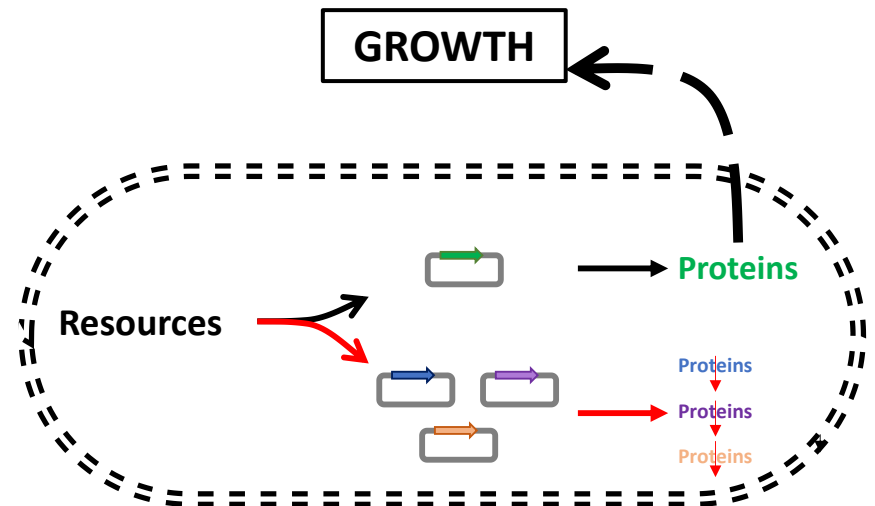

GENOPOLE  
INNOVATION TODAY. EVERY DAY

# Metabolic engineering for flavonoid production using cell free platform

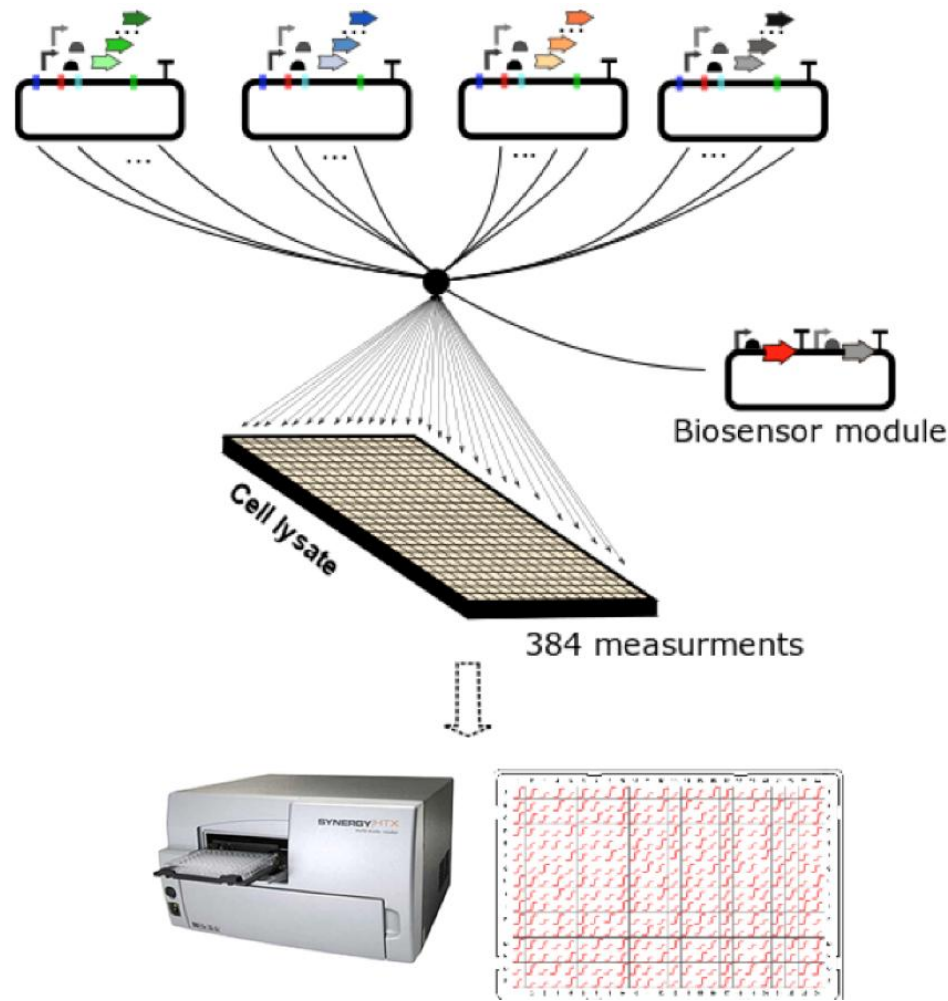

# Protein production $\Leftrightarrow$ Cell physiology

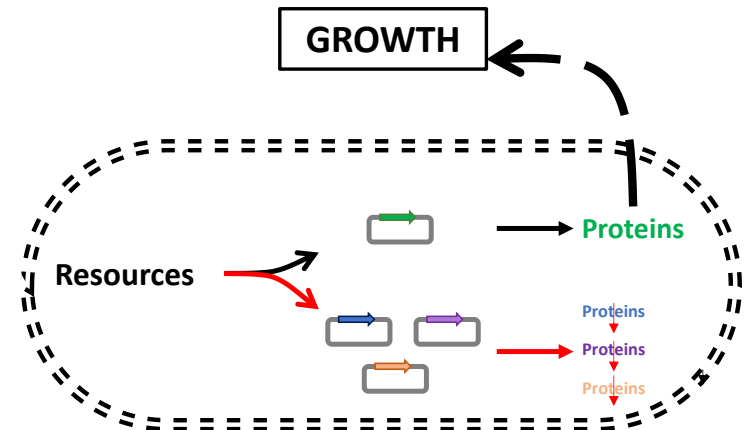
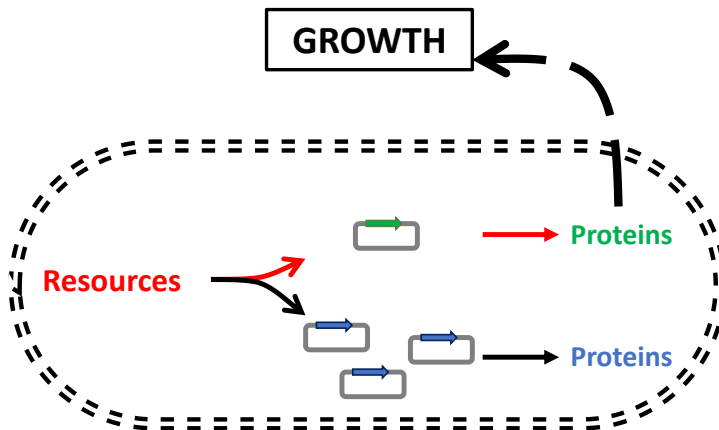
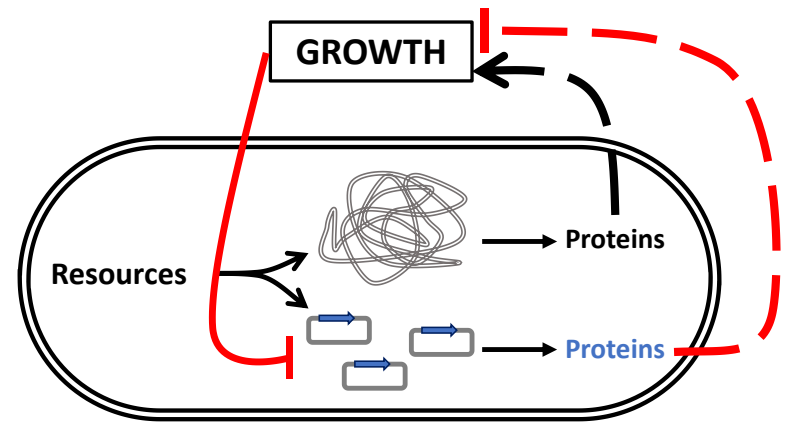
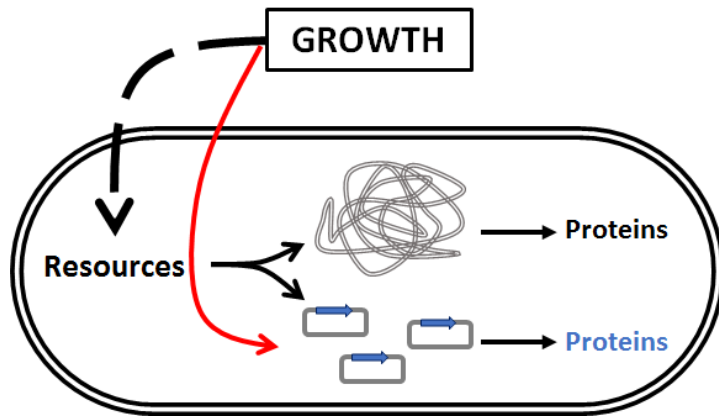

**Synthetic biology: Tools to use, predict or decouple protein production and growth in bacteria**

# Protein production ↔ Cell physiology

Still impossible to predict protein cost based on DNA sequence

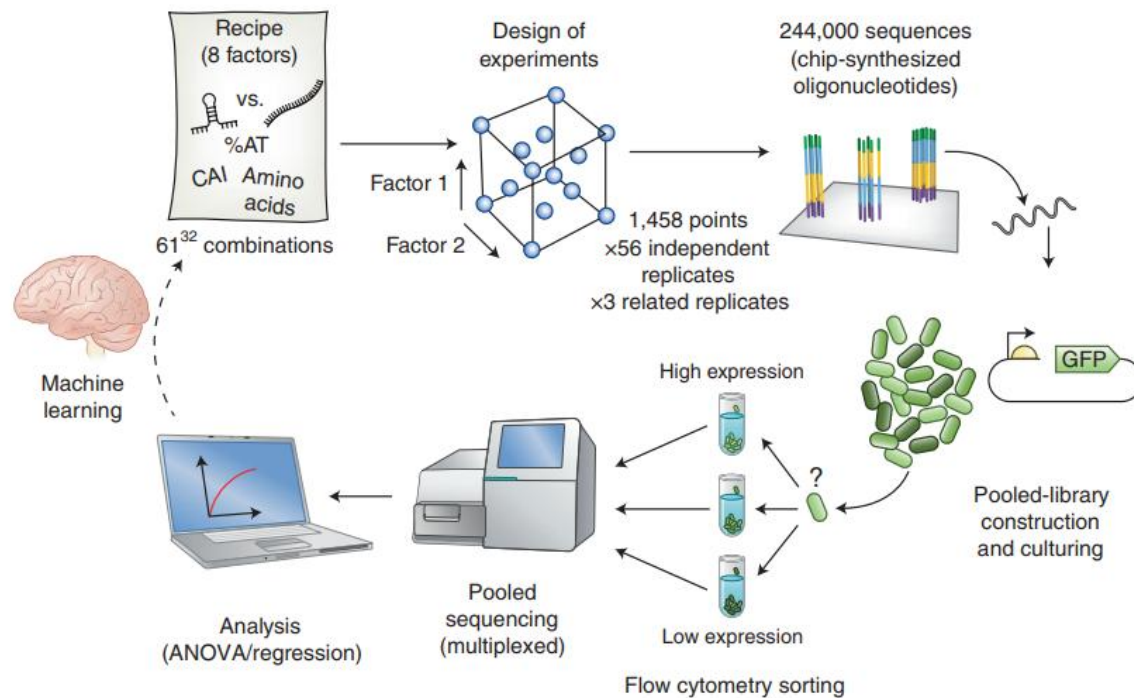

Cambray G, Guimaraes JC, Arkin AP. Evaluation of **244,000 synthetic sequences** reveals design principles to optimize translation in *Escherichia coli*. *Nature biotechnology*. 2018.

Gorochofski TE, Ellis T. Designing efficient translation. *Nature biotechnology*. 2018.

# Protein production ↔ Cell physiology

Cell physiology  
↓  
Protein production

Protein production  
↓  
Cell physiology

Protein production ↔ Cell physiology  
↓  
Tools for synthetic biology

