



HAL
open science

Exploring the fluxotype of the *E. coli* Y-ome using high-resolution fluxomics

Cécilia Bergès, Edern Cahoreau, Pierre Millard, Brice Enjalbert, Mickael Dinclaux, Maud Heuillet, Hanna Kulyk, Lara Gales, Noémie Butin, Maxime Chazalviel, et al.

► To cite this version:

Cécilia Bergès, Edern Cahoreau, Pierre Millard, Brice Enjalbert, Mickael Dinclaux, et al.. Exploring the fluxotype of the *E. coli* Y-ome using high-resolution fluxomics. Séminaire TBI Toulouse, Mar 2023, Toulouse (31000), France. hal-04282012

HAL Id: hal-04282012

<https://hal.science/hal-04282012v1>

Submitted on 13 Nov 2023

HAL is a multi-disciplinary open access archive for the deposit and dissemination of scientific research documents, whether they are published or not. The documents may come from teaching and research institutions in France or abroad, or from public or private research centers.

L'archive ouverte pluridisciplinaire **HAL**, est destinée au dépôt et à la diffusion de documents scientifiques de niveau recherche, publiés ou non, émanant des établissements d'enseignement et de recherche français ou étrangers, des laboratoires publics ou privés.

Exploring the fluxotype of the *E. coli* Y-ome using high-resolution fluxomics

A robust and integrated workflow to measure high-resolution fluxotypes

Cécilia Bergès & Edern Cahoreau, Pierre Millard, Brice Enjalbert, Mickael Dinclaux, Maud Heuillet, Hanna Kulyk, Lara Gales, Noémie Butin, Maxime Chazalviel, Tony Palama, Matthieu Guionnet, Sergueï Sokol, Lindsay Peyriga, Floriant Bellvert, Stéphanie Heux and Jean-Charles Portais.

INTRODUCTION : Fluxomics and fluxotypes

Fluxomics :

Measures the **actual rates of biochemical reactions** in metabolic networks (i.e. the **Fluxome**). It measures the actual output of the **integrated response of the gene-protein-metabolite interaction network** and provides direct access to the cellular phenotype in a **quantitative manner**.

A number of applications :

- Microorganisms, plant cells & tissues, animal cells
- Systems biology
- Biotechnology
- Health, drug targeting

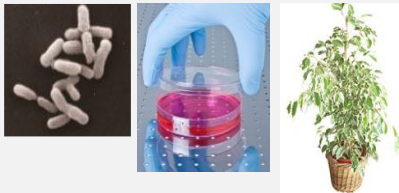

Fluxotype = Metabolic flux phenotype : the particular distribution of metabolic fluxes measured for a given strain under given physiological conditions

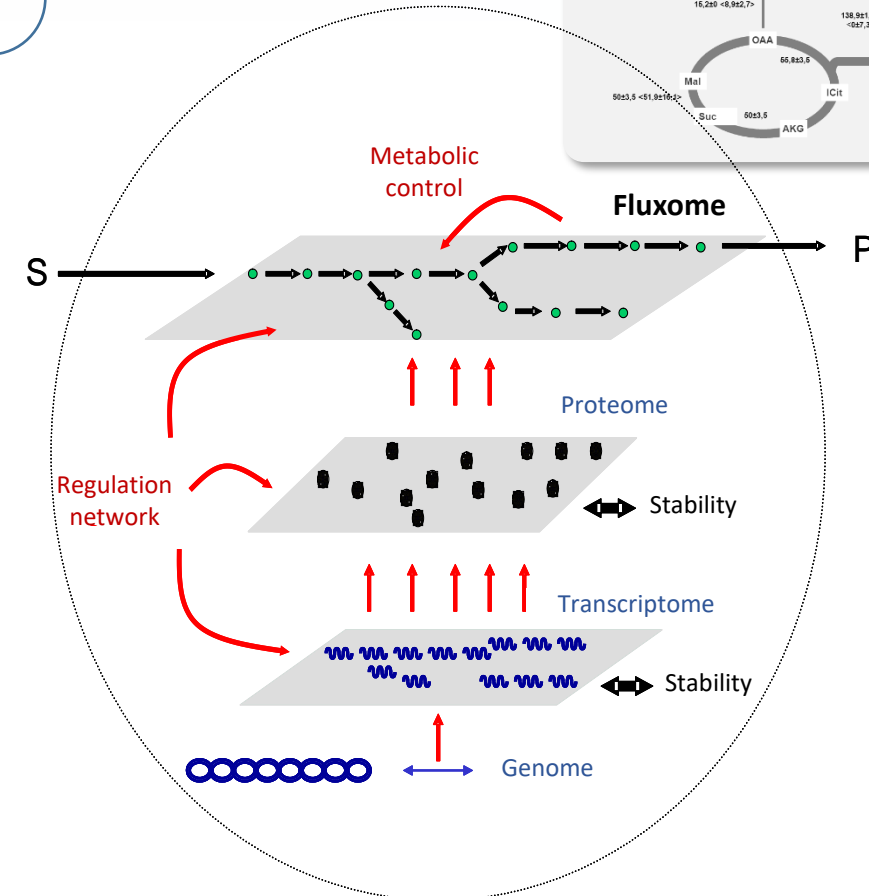
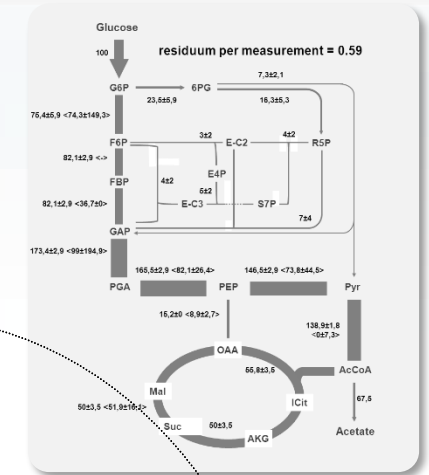

INTRODUCTION : ^{13}C fluxomic analyses

^{13}C -labeled carbon source

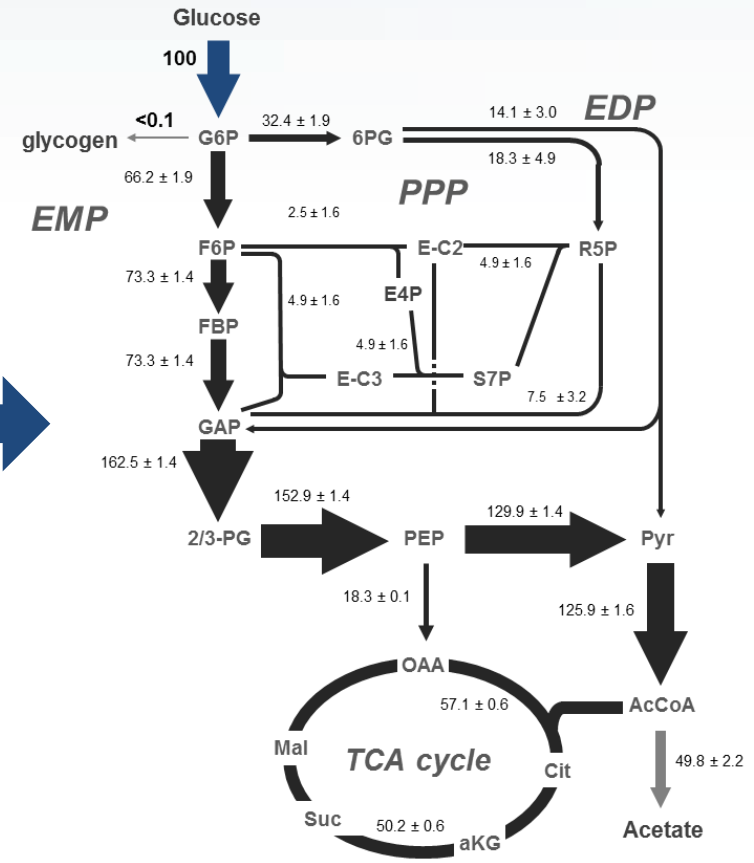
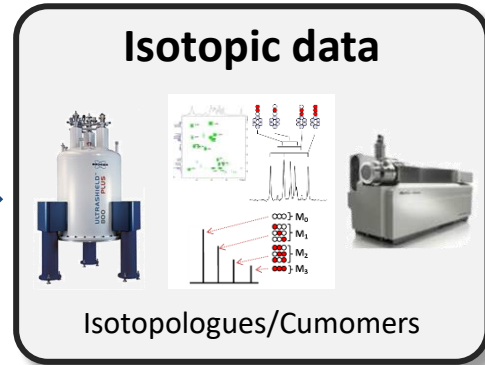
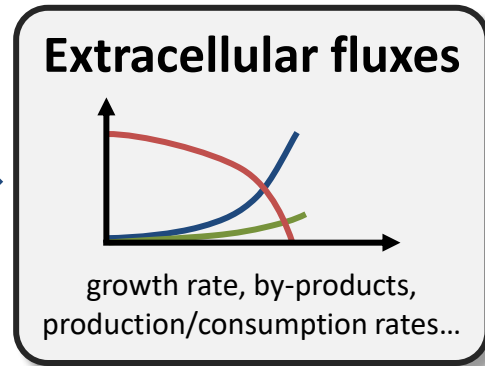
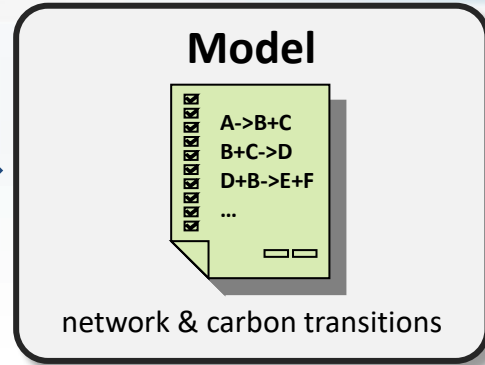

^{13}C targeted fluxomics example

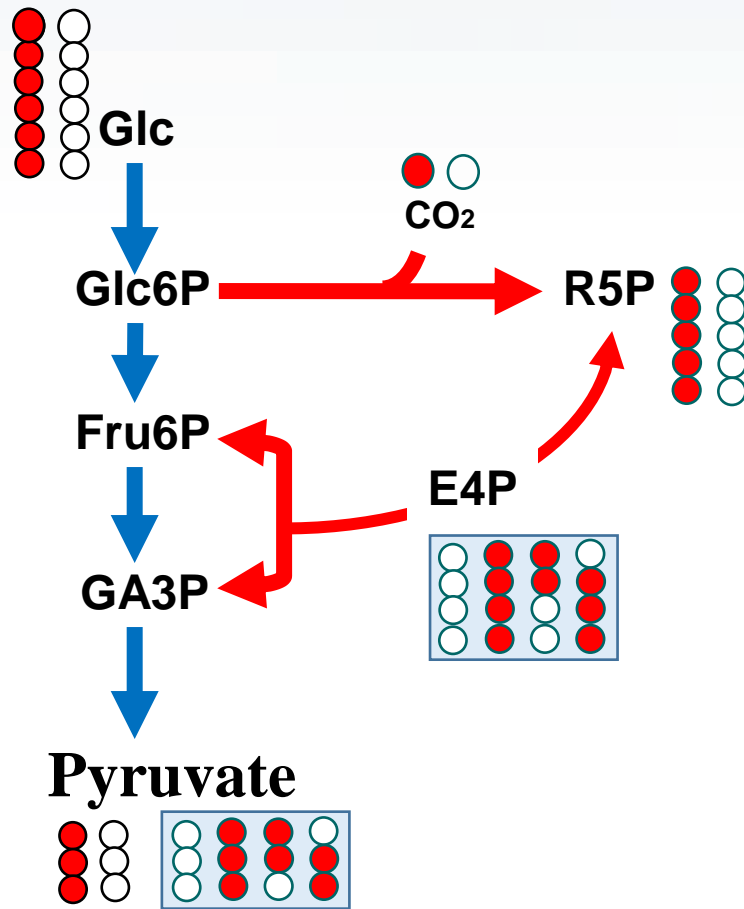

NMR: positional isotopomers

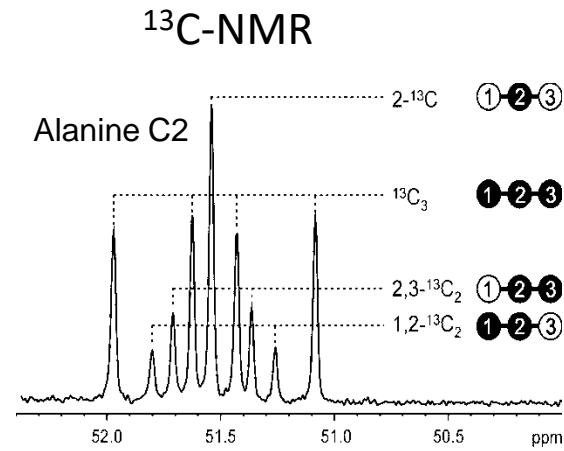

NMR: ^{13}C enrichment

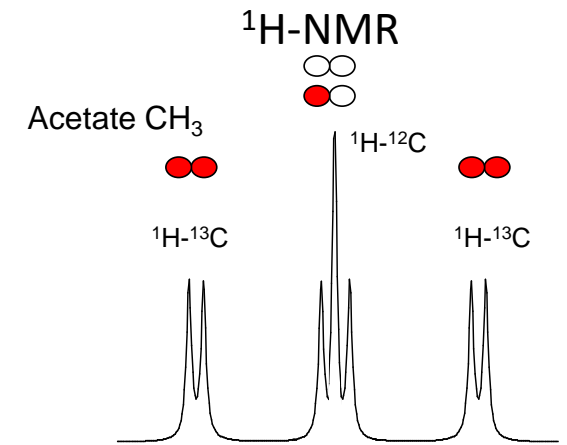

MS: isotopologues

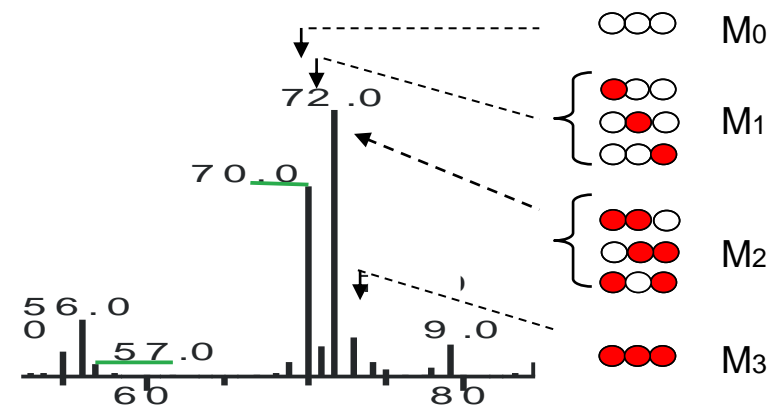

¹³C targeted fluxomics example

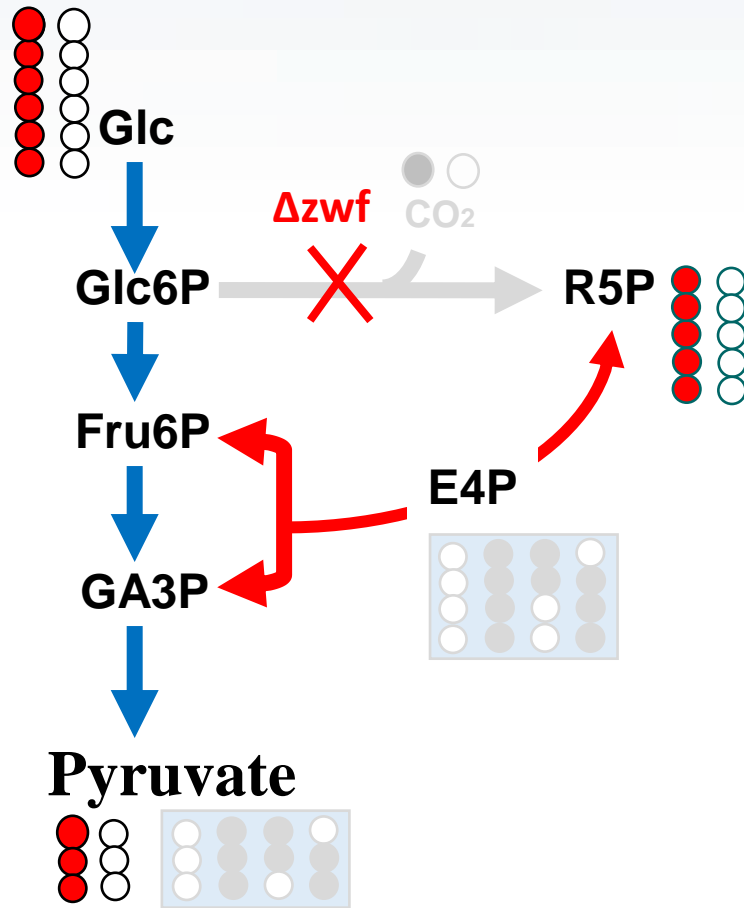

NMR: positional isotopomers

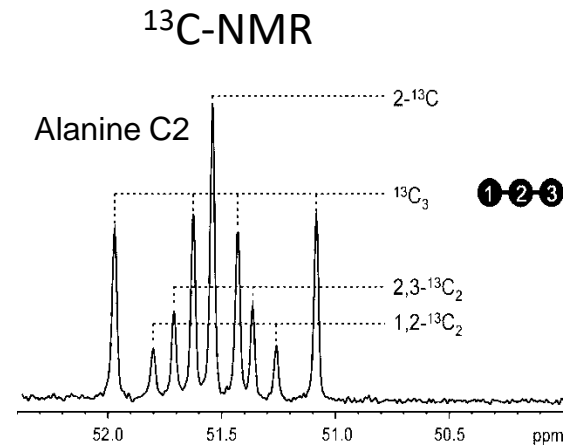

NMR: ¹³C enrichment

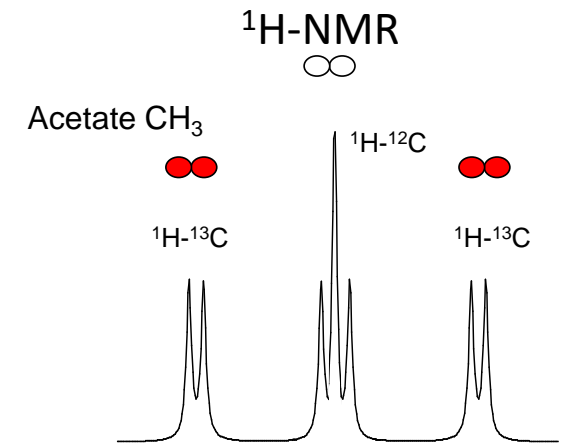

MS: isotopologues

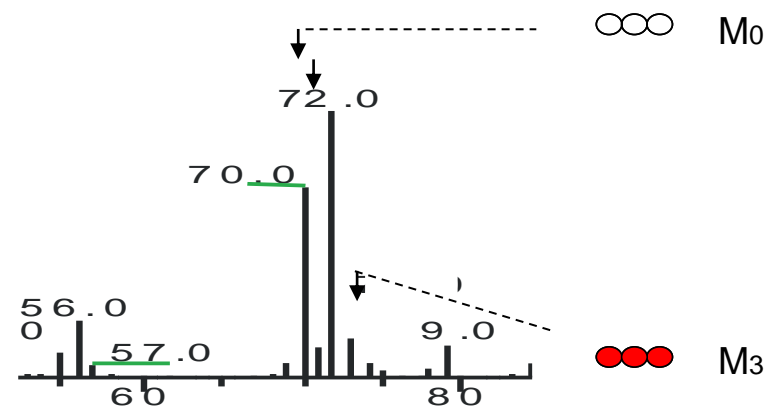

INTRODUCTION : ^{13}C fluxomic analyses

Different ^{13}C exploitation approaches : Different levels of information and throughput :

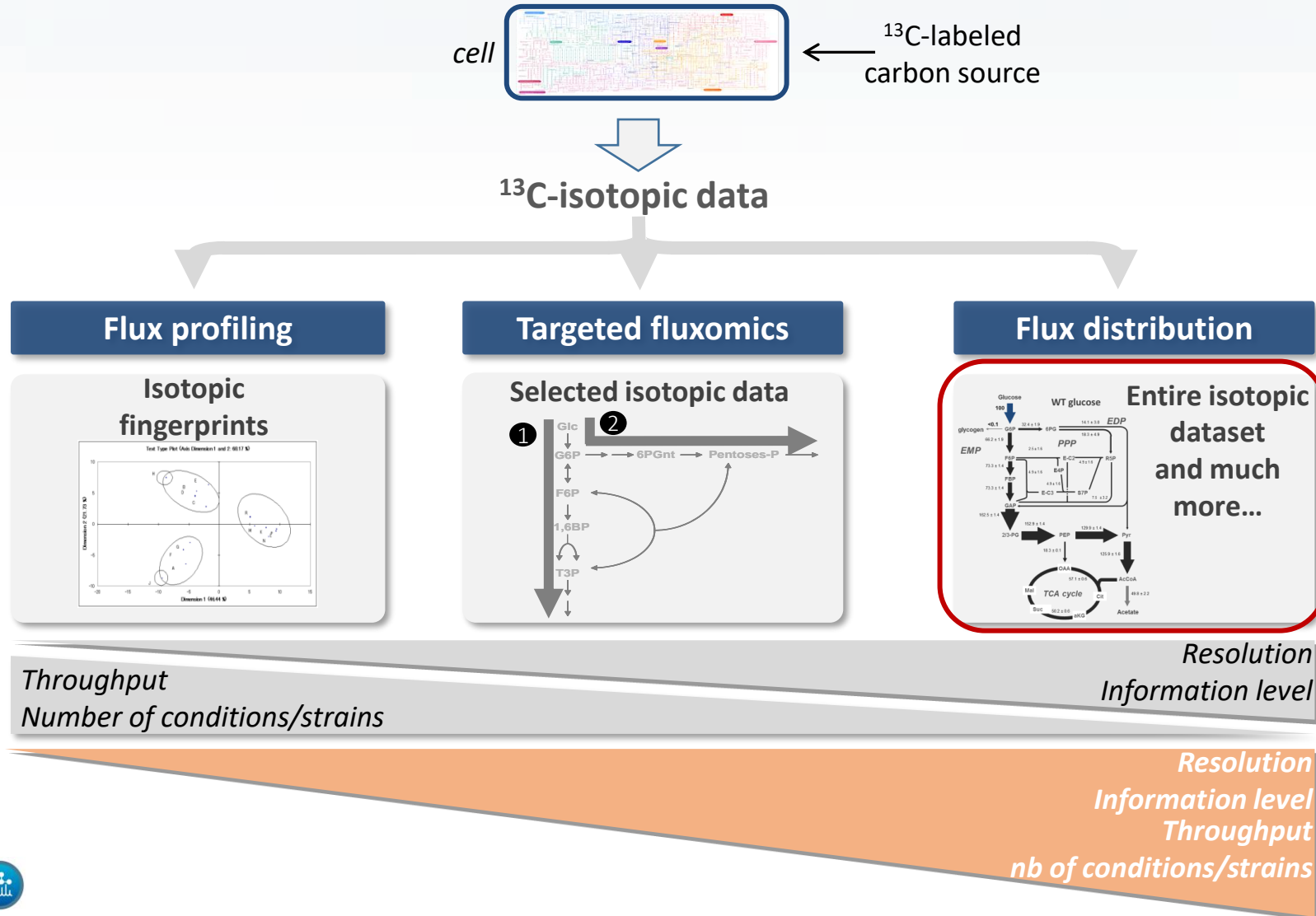

Highly manual and tedious work



Many steps, long process

How to go faster, deeper, stronger...

What do we need to improve :

- Throughput
- Robustness
- Interactivity (data \leftrightarrow results \leftrightarrow brain)

Needs for a development of an integrated fluxomics workflow :

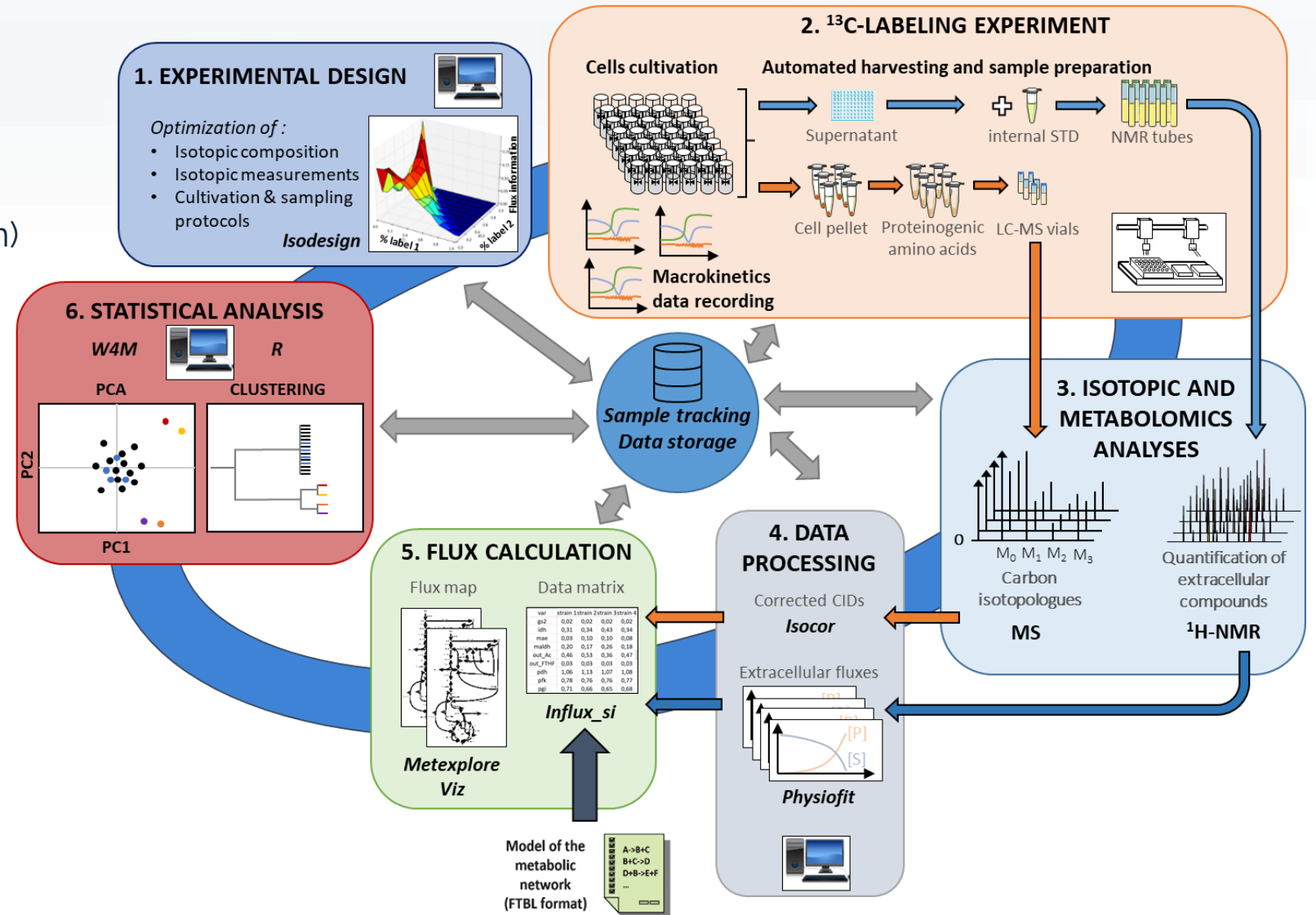

Application to the Fluxotyping of *E.coli* Y-ome

E. coli BW25113



- 4 624 857 pdb
- 4 487 genes
- 4 234 protein-encoding genes
- 122 RNA genes
- 131 pseudogenes
- **Unknown function protein encoding genes ?**
-> **The Y-ome**

- Does Y-ome genes have a role in metabolism activity ?
- Does they affect flux phenotype ?
- If yes, can we affect a potential role to these Y-genes ?

Molecular Systems Biology (2006) doi:10.1038/msb4100050
© 2006 EMBO and Nature Publishing Group All rights reserved 1744-4292/06
www.molecular-systemsbiology.com
Article number: 2006.0008

molecular
systems
biology

Construction of *Escherichia coli* K-12 in-frame, single-gene knockout mutants: the Keio collection

Tomoya Baba^{1,2}, Takeshi Ara¹, Miki Hasegawa^{1,3}, Yuki Takai^{1,3}, Yoshiko Okumura¹, Miki Baba¹, Kirill A Datsenko⁴, Masaru Tomita¹, Barry L Wanner^{4,*} and Hirotsada Mori^{1,2,*}

The Keio collection

The most complete Gene deletion strain collection of *E. coli*

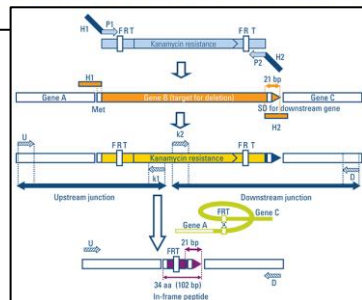

Baba *et al.*, Mol Syst Biol. 2006

1) Y-ome *E. coli* : strain selection

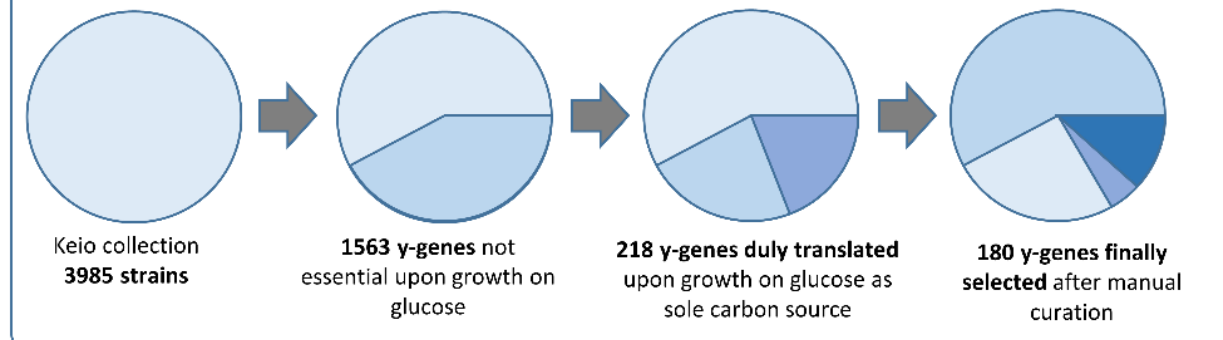

Proteomic data from Schmidt *et al.*, Nat Biotechnol, 2016

Databases used for selection and curation of *y*-genes : *Ecocyc*, *Uniprot*



High-resolution fluxotyping of the *E. coli* Y-ome

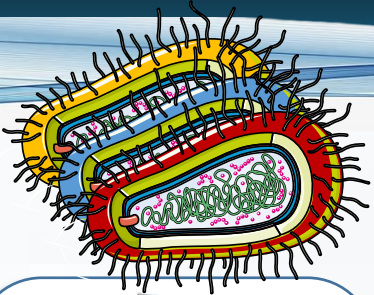

Robotic platforms

Cultivation, monitoring, sampling and preparation

IsoCor

MS isotopic data correction

Physiofit

Calculation of in/output fluxes from NMR data



2) HR Fluxotyping of the 180 selected strains

¹³C labelling experiment

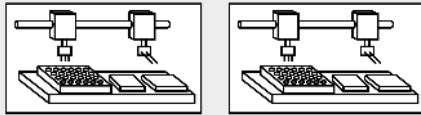

Cells cultivation & sampling

Sample preparation

Data analysis

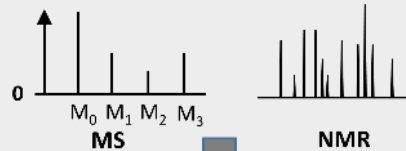

Data processing

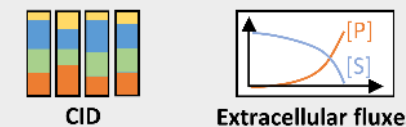

Intracellular fluxes calculation

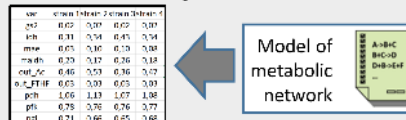

A huge amount of data to process

- 198 fully controlled cultivations (pH, O₂, growth)
- 1074 growth measurements points(OD)
- 1248 samples collected
- more than 20000 isotopic data measured
- **18612 fluxes were calculated for 198 flux maps**



Targeted LC-MS/MS

Thermo LTQ Orbitrap

Targeted analysis on 15 Proteinogenic Amino acids
¹³C isotopic profiling

NMR

Bruker Ascend 800MHz – 5mm QPCI cryoprobe

Analysis of exometabolome
Quantification of substrates and products and ¹³C enrichments



Influx_{si}

Serial flux calculation from a unique starting metabolic network model

Comparison of fluxotypes of γ -ome strains with those of their parental strain

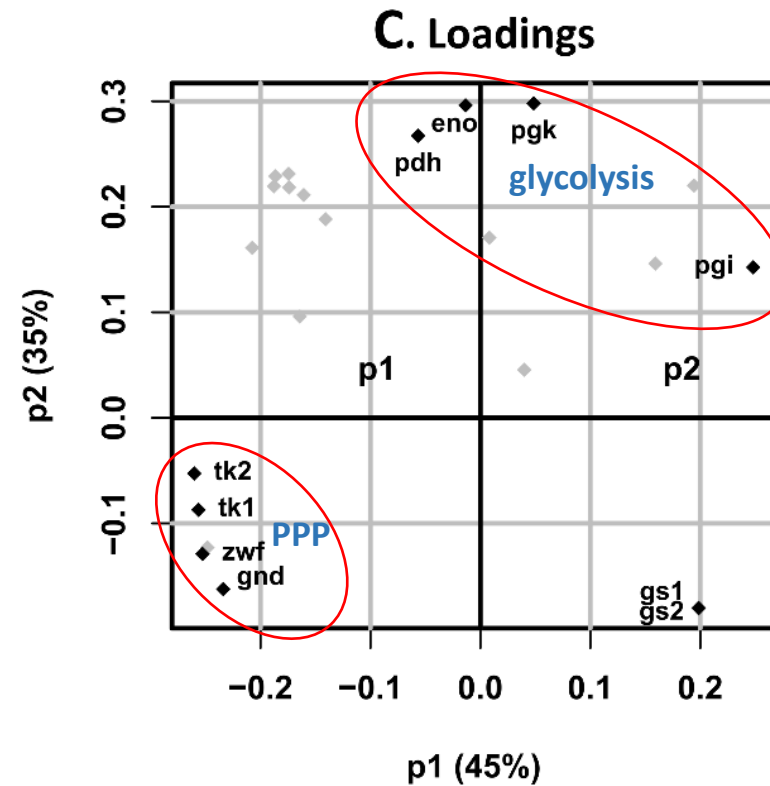
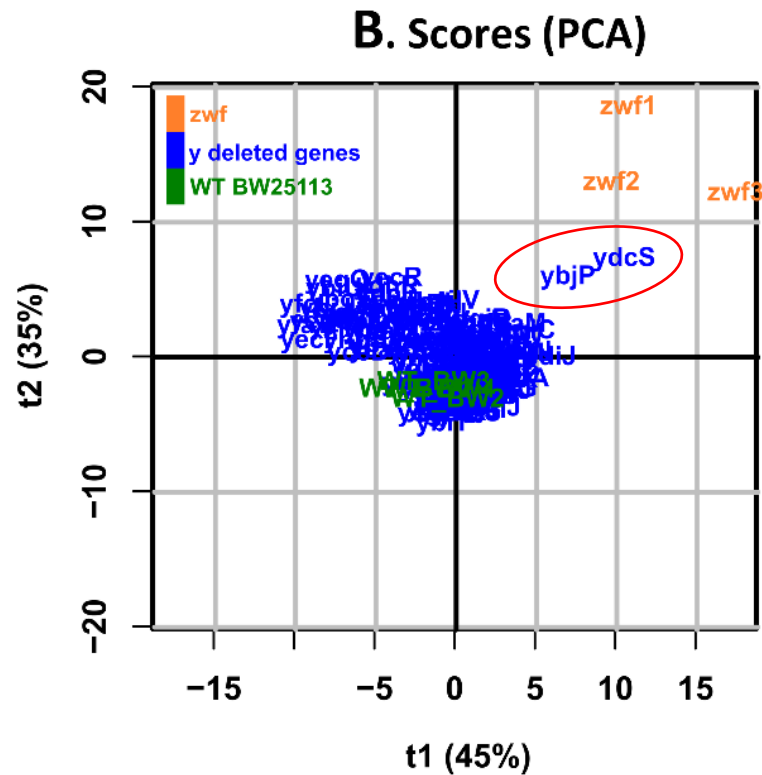

- For a large majority of mutant strains the flux data clustered with those of the WT strains
- Most of the deleted γ -genes has a limited impact on the distribution of intracellular metabolic fluxes

Two mutant strains did not cluster with the WT strains : $\Delta ybjP$ & $\Delta ydcS$

Biological conclusion : Metabolic fluxes of $\Delta ydcS$ and $\Delta ybjP$ strains

Production of NADPH, NADH/FADH₂ and ATP from the central carbon metabolism

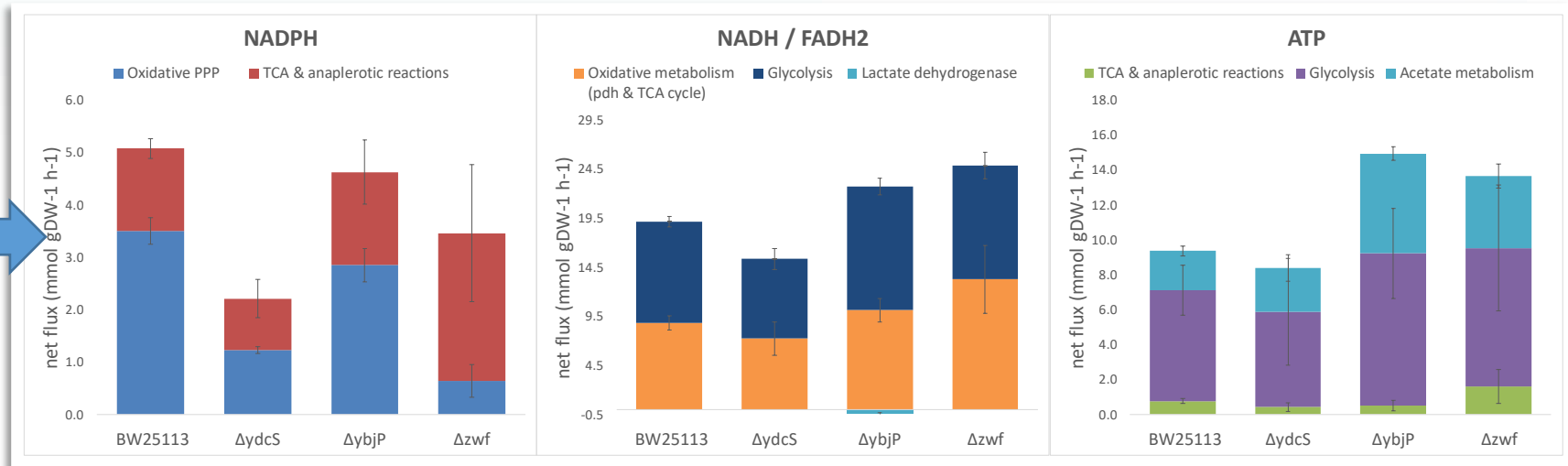
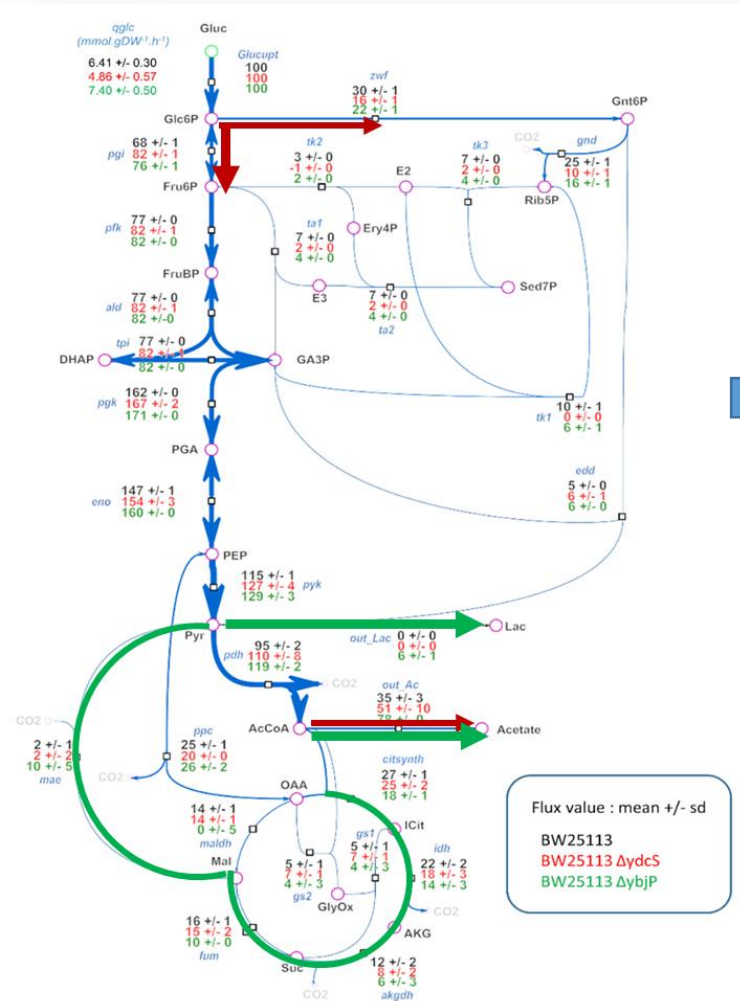

$ydcS$: ↓ NADPH production rate
↓ ATP production rate

$ybjP$: ↑ production rate of ATP
▬ NADPH production



Evaluation of data size and quality in HT fluxomics investigations

HR fluxotyping workflow comparison :

	Leighty et al., 2013 [37]	Crown et al., 2015 [38]	Long & Antoniewicz 2019 [35]	Millard et al., 2014 [30]	Long et al., 2016 [39]	Heux et al., 2014 [22]	Haverkorn van Rijsewijk et al., 2011 [31]	This Paper	
<i>E. coli</i> strains	MG1655	MG1655	BW25113 Δ tpiA mutant	MG1655	BW25113	MG1655	BW25113 + Keio mutants	MG1655 + BW25113 + keio mutants	
Number of measured fluxotypes	1	1	1	1	1	20	190	198	
Number of different label input(s) by strain or condition	6	14	2	1	1	2	2	1	
Fluxome resolution = number of (net) fluxes by fluxotype	71	71	75	84	71	23	23	94	
Isotopic resolution power = number of isotopic data/ number of calculated fluxes	7.52	17.55	5.07	1.4	1.94	2.57	1.61	1.13	
Total flux dimension = number of fluxes per fluxotype \times number of fluxotypes	71	71	75	84	142	460	4370	18,612	
Global flux precision = median RSD over the global dataset	12%	15%	7.80%	19%	23%	285%	14%	32%	
Global pathway precision = median RSD within specific pathways	S.A. (n = 1)	S.A. (n = 1)	S.A. (n = 1)	S.A. (n = 1)	S.A. (n = 1)	S.A. (n = 23)	S.A. (n = 23)	S.A. (n = 198)	biological replicates (n = 20)
Glycolysis	1%	2%	4.20%	3%	3.50%	553%	7%	3%	1%
ppp + edp	14%	11%	17%	131%	10%	41%	25%	24%	7%
tca + gs	11%	19%	4.90%	20%	31%	795%	19%	40%	21%
anaplerosis	122%	144%	87%	13%	1822%	7%	15%	42%	20%
output fluxes	12%	25%	4.7%	15%	42.4%	426%	0%	10%	14%

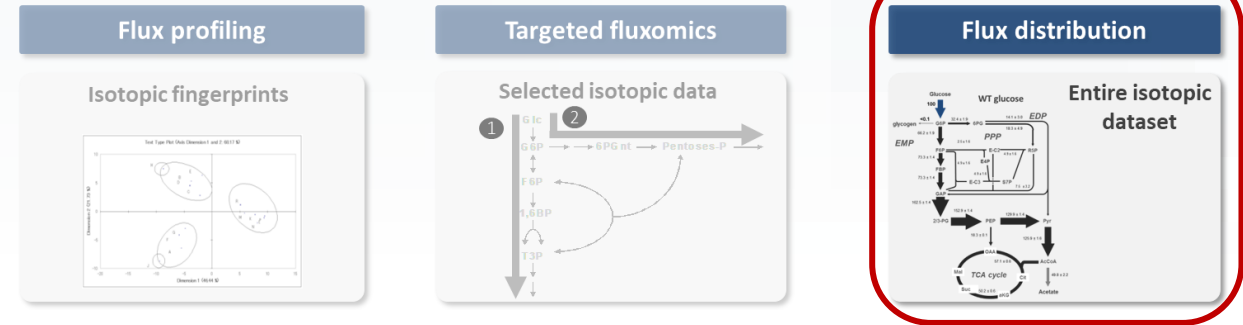

198 isotopically-resolved flux maps generated in 33 days
194 hrs of human time ~ 1hr / flux map

Resolution
 Information level
 Throughput
 Nb of conditions/strains

New metrics introduced :

- **Isotopic resolution power = 1.13**
 - **Total flux dimension = 18612**
 - **Global flux precision = 32 % (from sensitivity analysis)**
- HT and HR character of this workflow
- Compromise resolution / throughput



Conclusions - Perspectives

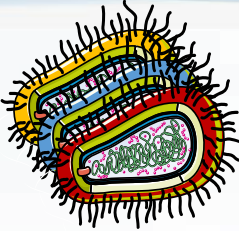

HT & HR fluxotyping workflow :

- Significant **improvements** in the parallelization, automation and implementation of fluxomics in **large-scale investigations**
- Good level of **flux precision / number of isotopic data collected**

Y-ome investigation :

- The **vast majority** of the 180 mutations investigated has a fluxotype **similar to the WT strain**
- **2 interesting fluxotypes identified : Ydcs & Ybjp**
- **help annotation of gene functions -> EcoCyc referenced**

Perspectives of developpements and applications

- **Expanding capacities** of fluxotyping on **other environment / carbon sources**
- Opening to other organisms: **Yeasts, other microorganisms, mammalian cells**
- Opening to **untargeted fluxomics** and **unknown organisms**
- Integration of fluxomics workflow in an improved and **integrated and ¹³C fluxomics workflow**

EcoCyc Change Current Database
Search in Current Database:

gene polypeptide
ybjP **DUF3828 domain-containing lipoprotein YbjP**
Escherichia coli K-12 substr. MG1655

Accession IDs: G6450 (EcoCyc), D0905, ECO0956, P75818 (UniProt) | Length: 516 bp / 171 aa | Map Position: [903,952 - 904,467] (19,4) | Location: inner membrane

Summary | GO Terms (2) | Essentiality | Protein Features | Operons | References | Show All

Summary of Regulatory Influences on ybjP

Diagram: TscC and GcsFp regulate ybjP, which regulates YbjP.

Summary
YbjP is a verified lipoprotein according to unpublished data by S. Matsuyama et al. (cited in [Juncker03]).
Deletion of ybjP is associated with significant changes in the distribution of carbon fluxes in central metabolism [Berges21].
Additional Citations: [Rao20]



Thanks for your attention

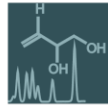
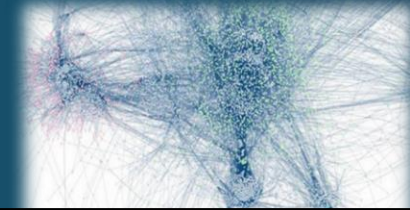
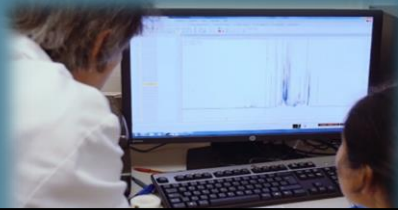











metabolites



Article

Exploring the Glucose Fluxotype of the *E. coli* γ -ome Using High-Resolution Fluxomics

Cécilia Bergès ^{1,2,+} , Edern Cahoreau ^{1,2,+} , Pierre Millard ¹ , Brice Enjalbert ¹ , Mickael Dinclaux ¹ , Maud Heuillet ^{1,2}, Hanna Kulyk ^{1,2}, Lara Gales ^{1,2}, Noémie Butin ^{1,2,3}, Maxime Chazalviel ⁴ , Tony Palama ^{1,2} , Matthieu Guionnet ^{1,2} , Sergueï Sokol ¹ , Lindsay Peyriga ^{1,2} , Floriant Bellvert ^{1,2}, Stéphanie Heux ¹ and Jean-Charles Portais ^{1,2,3,*} 