



HAL
open science

Flexible 5G gNB Implementation for Easy Tactical Deployment: a Focus on the Radio Unit

Guillaume Vercasson, Cyril Collineau, Malo Manini, Jean Dion, Vincent Savaux, Patrick Savelli

► **To cite this version:**

Guillaume Vercasson, Cyril Collineau, Malo Manini, Jean Dion, Vincent Savaux, et al.. Flexible 5G gNB Implementation for Easy Tactical Deployment: a Focus on the Radio Unit. IEEE Conference on Standards for Communications and Networking, IEEE, Nov 2023, Munich (Allemagne), Germany. hal-04281814

HAL Id: hal-04281814

<https://hal.science/hal-04281814>

Submitted on 13 Nov 2023

HAL is a multi-disciplinary open access archive for the deposit and dissemination of scientific research documents, whether they are published or not. The documents may come from teaching and research institutions in France or abroad, or from public or private research centers.

L'archive ouverte pluridisciplinaire **HAL**, est destinée au dépôt et à la diffusion de documents scientifiques de niveau recherche, publiés ou non, émanant des établissements d'enseignement et de recherche français ou étrangers, des laboratoires publics ou privés.



Distributed under a Creative Commons Attribution - NonCommercial - NoDerivatives 4.0 International License

Flexible 5G gNB Implementation for Easy Tactical Deployment: a Focus on the Radio Unit

Guillaume Vercasson, Cyril Collineau, Malo Manini, Jean Dion, Vincent Savaux, and Patrick Savelli
 IRT b<>com, Rennes, France; emails: {firstname.name}@b-com.com

Abstract—This paper deals with the implementation of a light fifth generation (5G) base station (gNB) intended for specific use cases requiring an airborne deployment of the network. We focus on the radio unit (RU) and give details on the components, the implementations, and the technical choices that have been made, driven by the strong constraints inherent to the considered use cases.

Index Terms—5G, gNB, Radio Unit, CU/DU/RU

I. INTRODUCTION

Fifth Generation (5G) gNBs have been implemented by historical manufacturers, usually build on dedicated hardware platforms for network operators market. Meanwhile, the O-RAN alliance has proposed a framework architecture and interfaces [1] enabling smaller companies to deploy cloud RAN SDR platforms. The development of gNBs based on this framework, for specific private operators deployment is still a pending challenge when it comes to constraints such as low weight, low power consumption, and small footprint of the solution. In this paper, we present an original gNB design dedicated to specific civilian and defense 5G use cases such as popular events, natural disaster areas, airborne tactical systems, and more generally, any use case requiring a quick deployment of 5G network. High altitude platform stations (HAPS) [2] are an example of the targeted applications that requires light and fast deployment for areas where there is no infrastructure. Consequently, the gNB must fit particular constraints of compactness (few dozens of cm³), lightness (≤ 10 kg), low power consumption (≤ 120 W), autonomy, while ensuring a large coverage, high data rate, and quality of service. To this end, numerous hardware and software optimizations have been made from off-the-shelf components, with a focus on the optimized radio unit (RU) in this paper, the central and distributed units (CU and DU) being open source software components (Open Air Interface [OAI] [3]). It is noteworthy that the presented gNB is extremely flexible, since all components can be substituted by others according to the use cases and constraints, independently of the other components. The latter are presented in detail in Section II, along with performance measurements in Section III, supporting the relevance of our gNB design.

II. PLATFORM DESCRIPTION

A. General Description

The implemented 5G gNB is split into three sub-components according to Fig. 1: the 5G core network (5GC) and central/distributed units are implemented on a single or on two independent x86 central processing units (CPU), while the RU embeds an Enclustra Mercury board (XU1) [4] including ARM CPUs together with an FPGA, as well as a RF transceiver detailed later in this article. The system is compliant with O-RAN standard interfaces. The results presented in this paper are obtained using open-source projects: Free5GC [5] for the 5GC, OAI [3] for the CU/DU and Analog Devices HDL library in the RU. The system operates in stand-alone (SA) mode, withstanding two channels (2

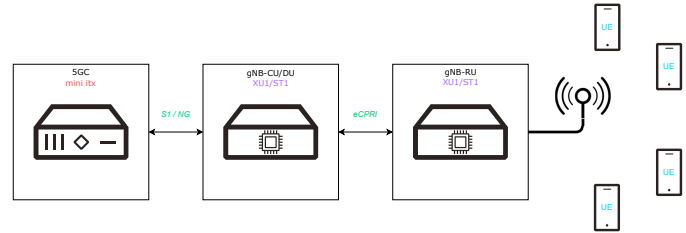

Fig. 1. The implemented platform splits into three system components.

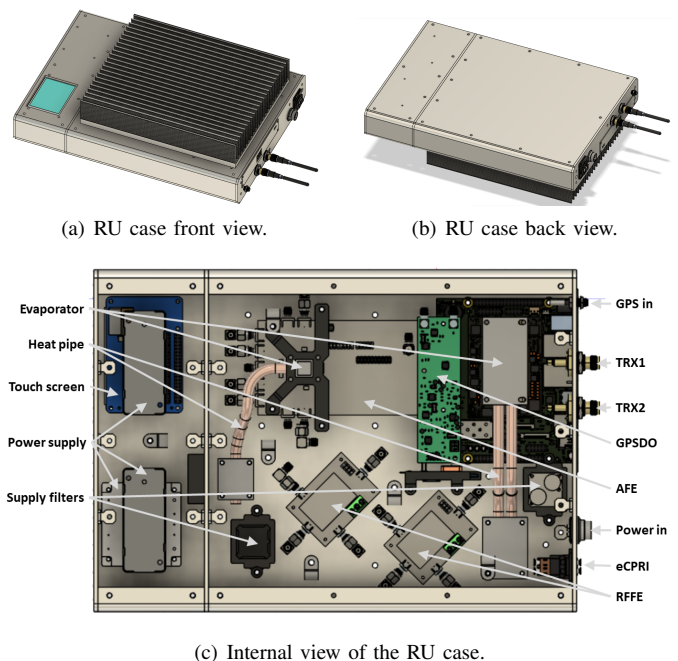

Fig. 2. RU fan-less case front/back (a)-(b) and internal views (c)

Tx and 2 Rx) of 40 MHz bandwidth with 37 dBm output power each, in the n41 band using time division duplexing (TDD) mode. The radio signal is synchronized by a global positioning system disciplined oscillator (GPSDO). The choice of such an architecture has been driven by constraints inherent to HAPS platforms: low power consumption, lightness, reduced size, and flexibility since the weight of the three components can be distributed in different parts of the (possibly light) airborne station to spread the load. CU/DU can be placed in the nose while the RU can be placed near the antennas. We hereby focus on the RU component to detail the design and the technical choices we have made.

B. Detailed RU Description

Since the RU system component may be embedded in a plane (or simply rooftop mounted), a fan-less case has been chosen to improve the mean time before failure. Moreover, to respect size

constraints, a case that integrates all the RU elements has been designed with aluminum plates and extruded aluminum heat sinks to fit the overall weight requirement. Fig. 2 gives an overview of the RU case: Fig. 2-(a) and (b) show the front and back views, respectively. In turn, Fig. 2-(c) shows the bottom view of the case and the layout of its components. More precisely, Fig. 2-(a) presents the screen and the heat sink, directly placed onto the top cover. That is the view presented to the user. Heat is transmitted to the air, and user can check/set system parameters directly with the touch screen interface. Fig. 2-(b) presents the back view reduced to a clear cover to facilitate the installation of the components, or to mount a mast clamp on it. Fig. 2-(c) presents the placement of each component within the case. The switching power supply is on the left, and the signal processing elements on the right. This separation ensures better noise isolation from switching power supplies. Hottest components are directly connected to the case top cover to reduce thermal resistance as much as possible (as the RF front-end [RFFE] power amplifier for example). Other components that need some cooling use heat pipes to drive heat to the heat sink, such as the FPGA and the transceiver (also called AFE in this document) components for a sake of modularity of the gNB. The main inputs/outputs of this case are:

- Data link on optical full duplex Lucent connector (LC).
- Monitoring and debug on Gbps Ethernet and micro USB connections, respectively.
- Power supply supporting from 12 VDC to 75 VDC.
- TRX on TNC connectors (MIMO 2x2).
- GPS input on SMA connector.

Moreover, the case has a size of 371 x 250 x 75 mm, a weigh of 6 kg, and a full power consumption of about 80 W.

The detailed RU architecture is illustrated in Fig. 3. The ST1 motherboard from Enclustra has been selected because of its large system on module (SOM) panel support, its small mechanical form factor, its FPGA mezzanine card (FMC) connector and its small form factor pluggable (SFP+) connector. The first connector allows for the use of analog boards with high speed digital link up to 80 Gbps full duplex and the second one allows for the use of 10 Gbps optical transceiver making the system compliant with the enhanced common public radio interface (eCPRI) standard. A short distance fiber is targeted (up to few hundreds of meters) with 850 nm wavelength into multi-mode fiber, but up to 40 km could be reached with 1530 nm wavelength into single-mode fiber.

The selected system on module (SOM) embeds a 15EG FPGA from Xilinx that contains 3 types of processors : i) Four Cortex-A53 running under Petalinux that manage the global positioning system (GPS) and the touchscreen; ii) Two Cortex-R5 running in bare-metal that manage low level drivers for the ADRV9375 and real-time processing; iii) An FPGA that runs high speed processing blocks as:

- The 10 Gbps Ethernet interface with a packet classifier that routes eCPRI messages (data/control/alarm) from/to FPGA, A53 and R5,
- The TDD management block that safely controls the RF switch,
- The GPSDO management block that locks the RF sampling frequency onto the Pulse Per Second (PPS) signal from the GPS,
- The Low PHY functions as defined in 7.2x split.

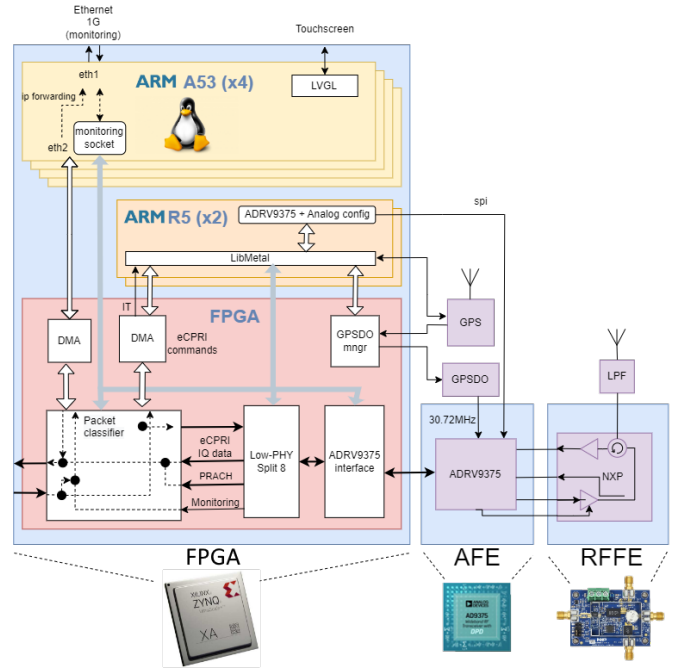

Fig. 3. Detailed RU architecture.

The Enclustra carrier drives the AFE board (ADRV9375 from Analog Device) that deals with digital to analog conversion (and vice versa) and frequency transposition (up to 6 GHz). In turn, it feeds a small power amplifier (from NXP) that emits up to 37 dBm (about 5 W) and whose non-linear response is digitally pre-distorted by the AFE. Such as aforementioned, the system is clocked by a GPSDO. This is based on an oven controlled oscillator (OCXO) whose slight drift is corrected by slaving to the 1 PPS from a GPS receiver. The whole system (CU/DU and RU) is designed to operate in the $[-40, +80]^{\circ}\text{C}$ temperature range, weighs <10 kg, and consumes <120 W, which is compliant with high altitude airborne applications.

III. RESULTS

This section presents some results related to the described flexible gNB. First, the overall system provides full compliant 3GPP 5G-SA communications with 5G UEs. Then, preliminary tests have been carried out to verify the ability of gNB to be integrated into an aircraft or HAPS:

- UL and DL performance following 3GPP test model (TM) such as defined in 3GPP TS 38.104 [6],
- Vibration tests to ensure the mechanical robustness of the equipment,
- GPSDO reference clock temperature sensitivity test,
- Outdoor radio coverage tests from telecommunication tower (55 m high).

Further results are presented afterward. Fig. 4 presents two typical radio spectra at 2.59 GHz frequency for an output power of 37 dBm, one with pre-distortion (in yellow) and one without (in green). It can be observed that the pre-distortion actually reduces the shoulders level by 17 dB. Thus, the use of small PAs combined with digital pre-distortion works properly, and the amplifiers' distortion is cancelled out.

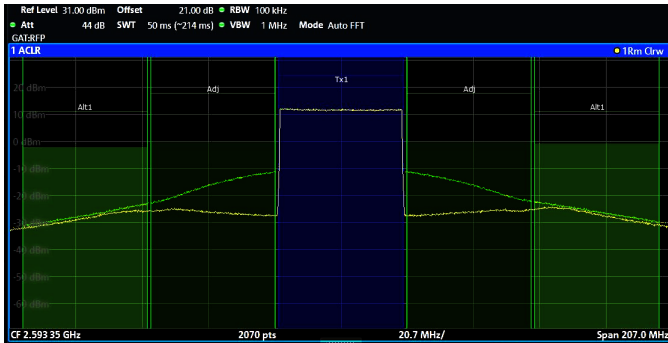

Fig. 4. Output spectrum with (yellow) and without (green) pre-distortion at 37 dBm

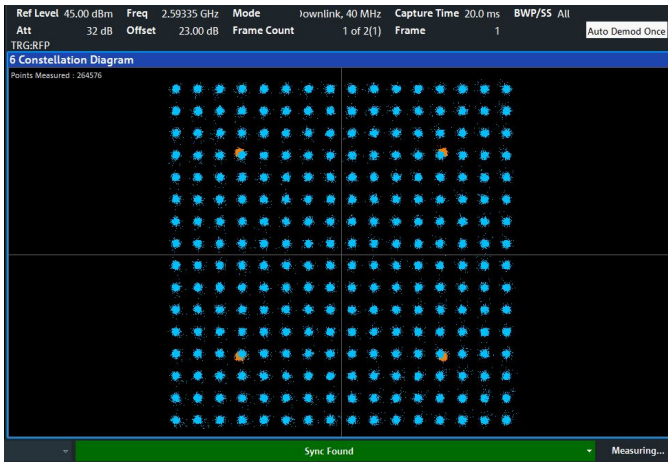

Fig. 5. TM3.1a RF output EVM measured with R&S FSVA3000

TABLE I
TYPICAL EVM AT 37DBM OUTPUT POWER FOR 3GPP REFERENCE PATTERNS

Test Model (TM)	EVM (%)			
	QPSK	16-QAM	64-QAM	256-QAM
TM 1.1	1.41	-	-	-
TM 1.2	2.63	-	-	-
TM 3.1	-	-	1.57	-
TM 3.1a	-	-	-	1.58
TM 3.2	1.74	2.63	-	-
TM 3.3	1.95	-	-	-

This distortion reduction can also be measured through error vector magnitude (EVM) with a spectrum analyzer equipment. Thus, Fig. 5 shows a R&S FSVA3000 screen capture. The generated signal is the TM3.1a test model from 3GPP at 37 dBm output power, single output mode. It can be seen how clean is the 256-QAM generated at the output of the Tx antenna. To give numerical results, Table I summarizes the various EVM measured for all the 3GPP TM. All of them are far below the minimum requirement and allow optimal DL performances [6].

The receiver provides an overall noise figure of 1.3 dB for 85 dB gain and allows for a good UL performance over a wide distance. Coverage measures are still in progress using long sequence PRACH format.

To ensure the structural integrity of the gNB, it passed vibration tests according to the international standard IEC

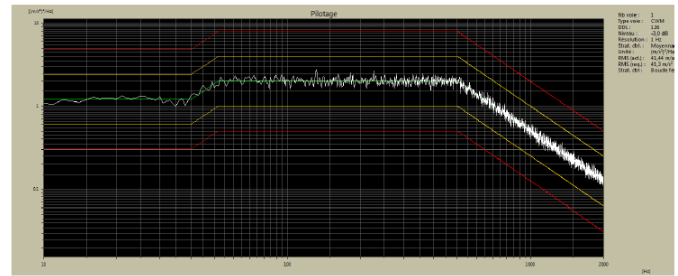

Fig. 6. Vibration power density for IEC 60068-2-64

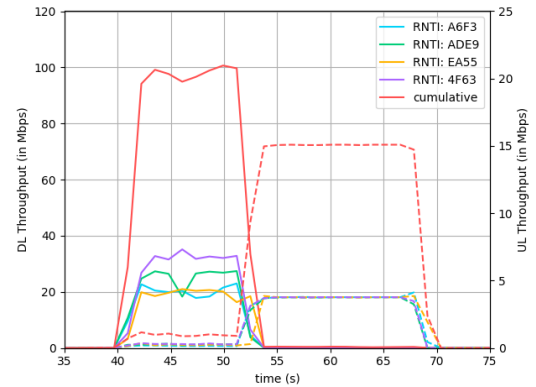

Fig. 7. Four UEs link throughput, and cumulative, when running a Google Speed Test on each

60068-2-64 (Table A7 Cat 2). The applied vibration matches a predefined spectral density over the 3 axes as shown in Fig. 6 for an average acceleration of 5.8 m.s^{-2} onto 3 axes.

To check GPSDO stability over temperature, the reference clock was measured with temperature variations from -40°C to 70°C and low clock frequency deviation was observed. When embedded in the base station, the radio frequency signal maximum deviation is $\pm 4 \text{ Hz}$ over time.

The system is configured in SISO mode, with the 70 % DL slot (and 30 % UL). Fig. 7 shows 4 UEs performing a speedtest in parallel. Both DL (solid line) and UL (dashed one) are fairly shared to achieve up to 100 Mbps in DL, and 15 Mbps in UL.

IV. CONCLUSION

Designing a highly flexible 5G base station, that can be quickly deployed on an aircraft or HAPS, implies careful hardware and software components design, due to weight and power constraints. This article presents the technical choices, related results and performances, that permit to fulfill these requirements.

REFERENCES

- [1] "O-RAN alliance specifications," <https://www.o-ran.org/specifications>, accessed: 2023-09-08.
- [2] E. Setiawan, "The potential use of high altitude platform station in rural telecommunication infrastructure," in *2018 International Conference on ICT for Rural Development (IC-ICTRuDev)*. IEEE, 2018, pp. 35–37.
- [3] "Open Air Interface," <https://openairinterface.org>, accessed: 2023-09-08.
- [4] "Enclustra mercury XU1 board description," <https://www.enclustra.com/en/products/system-on-chip-modules/mercury-xu1/>, accessed: 2023-09-08.
- [5] "Free5GC," <https://free5gc.org/>.
- [6] 3GPP, "3GPP TS 38.104, 5G NR Base Station (BS) radio transmission and reception (Release 17, v17.5.0)," 3GPP, Tech. Rep., April 2022.