



HAL
open science

Influence of a transmission oil degradation on physico-chemical properties and tribological performance

Büşra Duran, Jérôme Cavoret, David Philippon, Fabrice Ville, Arnaud Ruellan, Frank Berens

► **To cite this version:**

Büşra Duran, Jérôme Cavoret, David Philippon, Fabrice Ville, Arnaud Ruellan, et al.. Influence of a transmission oil degradation on physico-chemical properties and tribological performance. *Tribology International*, 2023, pp.109084_1-109084_20. <10.1016/j.triboint.2023.109084>. <hal-04280891>

HAL Id: hal-04280891

<https://hal.science/hal-04280891v1>

Submitted on 13 Nov 2023

HAL is a multi-disciplinary open access archive for the deposit and dissemination of scientific research documents, whether they are published or not. The documents may come from teaching and research institutions in France or abroad, or from public or private research centers.

L'archive ouverte pluridisciplinaire **HAL**, est destinée au dépôt et à la diffusion de documents scientifiques de niveau recherche, publiés ou non, émanant des établissements d'enseignement et de recherche français ou étrangers, des laboratoires publics ou privés.



HAL Authorization

Influence of a transmission oil degradation on physico-chemical properties and tribological performance

Büşra Duran^{1,2}, Jérôme Cavoret¹, David Philippon¹, Fabrice Ville^{*1}, Arnaud Ruellan³, Frank Berens²

* Corresponding author: fabrice.ville@insa-lyon.fr

¹ Univ Lyon, INSA Lyon, CNRS, LaMCoS, UMR5259, 69621 Villeurbanne, France

² SKF France, Saint-Cyr-sur-Loire, France

³ SKF B.V, Houten, The Netherlands

Abstract

Lubricant degradation can have a significant impact on the efficiency and reliability of mechanical systems. This study analyses the effects of field operation on the physicochemical properties and tribological performances of gear transmission oils. Viscosity and composition of fresh-new oils and field-collected ones are analysed and tribological tests on the High Frequency Reciprocating Rig (HFRR) and the Mini Traction Machine (MTM) are carried out to identify potential differences. Results reveal changes in intrinsic properties and tribological behaviour. They show that the evolution of the oil is highly dependent on the system and operating conditions, results that differ from those traditionally observed with engine oils.

Keywords: lubrication oils, mechanical degradation, friction measurement

1. Introduction

Rising environmental awareness on the sustainable use of energy promoted the need to focus more on the reduction of energy losses due to friction. 23 % of the total energy consumption in the world is due to tribological contacts, 87 % of which is used to overcome friction [1]. If lubricant properties are likely to evolve with time due to degradation, it has then the potential to affect the behaviour of tribological contacts, especially friction. On one hand, early oil change causes unreasonable use of limited resources and thus substantial environmental impact. On the other hand, late oil change can result in performance drop and unwanted failures. Therefore, defining the optimum draining intervals requires a thorough understanding of lubricant degradation.

Many studies have been conducted on the impact of oil degradation on their physical and chemical properties or tribological performance. In most cases, oil samples are artificially aged in laboratory conditions according to different methods. It is observed that the degradation is responsible for higher acidity, oxidation and viscosity, reduced additive activity as well as the formation of by-products [2]–[19]. Contamination with water or metallic particles is also known to have harmful effects and to accentuate the oil degradation [8], [13]–[16], [20], [21].

In terms of tribological behaviour, the degradation impacts on the physical and chemical properties of the lubricant lead to less tribofilm build-up and surface deterioration due to wear [2], [3], [13]–[18], [21], [22]. It can have critical consequences on the friction performance as well. Tribological testing conducted on fresh and degraded oils indicates that the friction coefficient is increasing with degradation [3], [5], [6], [15], [17], [18], [23], [24].

Oil degradation represents a complex phenomenon where opposing effects can be competing. Oxidation by-products can behave differently depending on their type and characteristics. Some of them can be detrimental leading to surface deterioration and reducing the

efficiency of tribofilm protection [2], [3], [17], [22]. Some others can however maintain a significant anti-wear property [2], [13], [25]. The overall performance of used lubricants depends on oil formulation and characteristics but also on the degradation mechanisms.

Most of the studies aforementioned deal with engine oils and related application characteristics. In that case, the viscosity rises and insoluble bodies are produced (e.g., soot) due to thermal polymerization caused by high temperatures. However, in transmission applications temperatures are more moderate than in engines but lubricants are subjected to different degradation mechanisms such as shearing. Several studies indicate that lubricants containing viscosity modifier additives exhibit a lower viscosity when being degraded mechanically in controlled conditions [26]–[29].

While the literature on transmission oils degradation is very light, some differences can be distinguished regarding the consequences of the lubricant degradation compared to other applications (such as engines that are widely studied). This indicates that this specific case needs to be addressed differently.

The interest in reducing friction losses that lead to study lubricant degradation is also relevant in that case as transmissions include various tribological contacts as well. Because the degradation mechanisms in these systems remain poorly understood, producing artificially aged oil samples which accurately reflect application conditions is a challenge in itself. This is attributed to the combination of thermal and mechanical stresses. In the present study, oil samples have been collected from the field on purpose to enable studying real cases directly from the application. The present work exposes the results of the physical and chemical analyses and tribological testing conducted on fresh and field-collected transmission oils. The aim is to shed light on the impacts of field operation on the lubricant properties and performance.

2. Materials and methods

a. Oil samples

The three oil samples that have been studied are a fresh mineral transmission oil (see properties in Table 1) and the same lubricant that has been used in two different tractor transmissions. In what follows, the fresh oil will be labelled as “NEW” and the ones collected from the tractors will be labelled as “USED-1” and “USED-2”. The USED-1 oil has been collected after 1292 hours of operation and the USED-2 oil after 2242 hours. These durations are usual operation time for tractor oils.

Table 1
Properties of the NEW oil.

Parameter	Value
Density at 15°C (g/cm ³)	0.872
Kinematic viscosity at 40°C (mm ² /s)	89
Kinematic viscosity at 100°C (mm ² /s)	13
Viscosity Index	145

b. Physical and chemical analysis techniques

The oil samples have been analyzed with conventional and advanced analytical techniques. In the first place, the viscosity has been measured with the SV-10 Tuning Fork Vibro Viscometer from A&D. The cell is filled with the oil sample then placed under the sensors that record both the viscosity and the temperature. The device is first calibrated with demineralized water as its viscosity evolution with temperature is known accurately. Before and after each measurement, the sensors are cleaned with ethyl acetate and the cup containing the oil is cleaned with heptane. In the present study, the samples have been heated up to 120°C approximately to start the measurement at elevated temperature. It has been stopped when the oil reached ambient temperature. Both the viscosity and the temperature are recorded during the experiment, allowing to get the viscosity evolution as a function of temperature.

In addition, the oil composition has been assessed with Fourier Transform InfraRed spectroscopy (FTIR). It is a widely used technique helping to monitor the oil condition [2], [8], [11], [13]–[16], [30]–[32], based on the characteristic vibrations of the chemical bonds in the sample. The resulting spectrum in the infrared range presents peaks that help to identify components such as additives, oxidation products or other kind of molecules. The infrared spectra of the oil samples have been measured from 400 cm⁻¹ to 4000 cm⁻¹, then they have been compared to detect potential differences. Studying the position, the emergence and/or the intensity of these peaks can then indicate the potential evolution of the oil chemistry.

Apart from these conventional techniques, X-Ray Fluorescence spectroscopy (XRF) has also been used to

assess the oil composition. The oil samples are placed into the device and exposed to X-radiation, the resulting response enables to quantify the content of the chemical elements in the oil [33].

c. Tribometers

The impact of the oil degradation can also be considered from a tribological point of view. It enables to evaluate the consequences of the physical and chemical properties evolution. To do so, two single contact tribometers have been used to assess the tribological performance of the oil samples.

The High Frequency Reciprocating Rig (HFRR) from PCS Instruments enables to study the lubricant behaviour under pure sliding conditions [22], [34]–[37]. It is a single contact ball-on-plate tribometer where the lubricant performance can be evaluated over a broad range of contact conditions. The pure sliding condition is achieved with a fixed plate and a reciprocating ball. The oil bath temperature, the amplitude and the frequency of the reciprocating movement, the applied load and the duration of each step can be chosen. In the present work, an in-house test profile has been used to assess the behaviour of the lubricant at different temperatures (Figure 1). The goal with this machine is to focus on specific functionalities of the oil in the boundary lubrication regime, such as viscosity quality or additive activity for instance. Test specimens are mirror-polished with an arithmetic average roughness R_a below 10 nm. During the experiment, the friction coefficient and the film percentage are measured. The latter is a value that quantifies metal surfaces separation: if the two surfaces are completely in direct contact, it is equal to 0 %, if they are completely separated, it returns 100 %. As this measurement is an average on the contact area, it can take various values between 0 % and 100 %. However, this measurement is sensitive to fluctuations and need to be interpreted carefully. Before starting, the component of the test rig and the specimens (ball and plate) are cleaned with ethyl acetate, ethanol, and heptane in an ultrasonic bath during 5 minutes for each solvent. After the test, pictures of both specimens are taken with white light microscopy to observe the wear track aspects, and morphological analysis has been conducted on the lower specimen wear tracks with optical interferometry.

To test the oils behaviour under rolling/sliding conditions, experiments have been conducted on the Mini Traction Machine (MTM) from PCS Instruments. It is a single contact ball-on-disc test rig where both specimens speeds are controlled separately, making it possible to introduce rolling/sliding conditions [38]–[48]. The applied load, the entrainment speed, the slide-to-roll ratio (SRR), the oil bath temperature and the duration of each step can be selected according to the aim of the test.

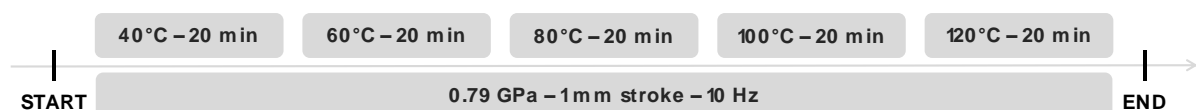

Figure 1: In-house test profile on the HFRR.

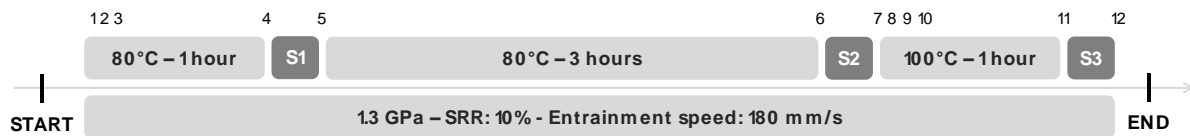

Figure 2: In-house test profile on the MTM.

In the present study, the test profile has been designed to highlight tribofilm build-up and friction performance (see Figure 2). S1, S2, and S3 represent the acquisition of the three "Stribeck curves", where the entrainment speed varies from high to low values, enabling the assessment of distinct lubrication regimes. The upper specimen (ball) was smooth with an R_a below 10 nm. For the lower specimen (disc), the test machine has been modified to mount bearing washers with a specific surface finish, differing from the standard washers used in most studies. The roughness of the lower specimens is chosen to obtain a contact which is at the limit between the boundary lubrication regime and the mixed lubrication regime. During the experiment, the friction coefficient is measured and the Spacer Layer IMaging (SLIM) method, based on optical interferometry, is employed to capture images of the ball wear track. There are twelve specific moments (numbered on Figure 2) when the test stops, and the ball is pressed against a glass disc to examine the wear track for potential tribofilm formation using the SLIM method (Figure 3). As these pictures are taken during the test, their quality may not be ideal. Furthermore, after the test, additional pictures are taken with a white light microscope to gain more information on the wear track aspects of both specimens.

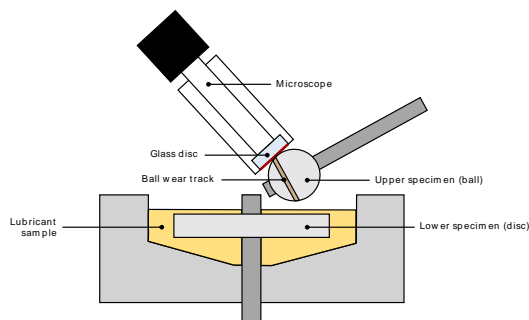

Figure 3: Principle of SLIM pictures acquisition. adapted from [49].

Before the test, the specimens are cleaned with petroleum ether and isopropyl alcohol in an ultrasonic bath during 10 minutes for each solvent. After the test, they are washed with petroleum ether again for microscope observation. In addition, the wear track on the ball is cleaned with ethylenediaminetetraacetic acid (EDTA) to check the presence of tribofilm. Indeed, EDTA is known and used to remove chemically adsorbed species such as tribolayers in wear tracks [17], [46], [50]–[52]. Also, roughness measurements inside and outside the lower specimen wear track are performed with optical interferometry to gain information on the surface topology before and after the tests.

To assess the repeatability of the defined test profile on this machine, three tests were conducted using a reference oil. The obtained friction coefficients and the roughness measurements inside and outside the wear track exhibit variations of less than 10 % from each other. They therefore validate the repeatability of the MTM tests with this test profile.

3. Results

a. Physical and chemical analyses of the oil

Figure 4 shows samples of the tested lubricants. From left to right, there is the NEW oil, USED-1 oil, and USED-2 oil. Field operation potentially induce changes in the oil properties and characteristics. To assess the extent of these changes, physico-chemical analyses have been performed.

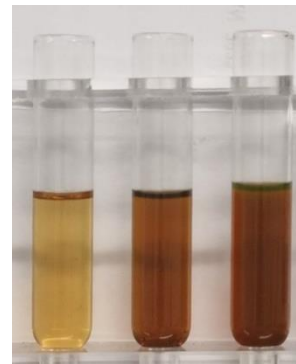

Figure 4: Pictures of the oil samples, from left to right: NEW, USED-1, USED-2.

1.1.1. Viscosity measurements

The lubricant viscosity is one the key parameters to be considered when selecting a lubricant for a given application as it fulfils a crucial role in lubricant performance. That is why monitoring its evolution is part of the conventional oil analysis methods. Figure 5 shows

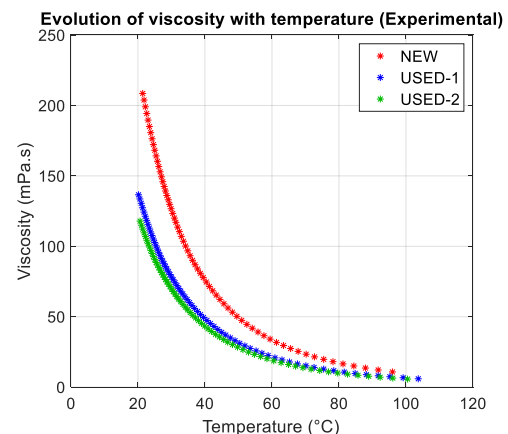

Figure 5: Viscosity measurements of the oil samples.

the results of the conducted viscosity measurements. The used samples exhibit lower values than the new one over the whole temperature range.

The relative viscosity change compared to the new oil is computed as follows:

$$\text{Ratio} = 100 * \frac{\eta_{USED} - \eta_{NEW}}{\eta_{NEW}} \quad (1)$$

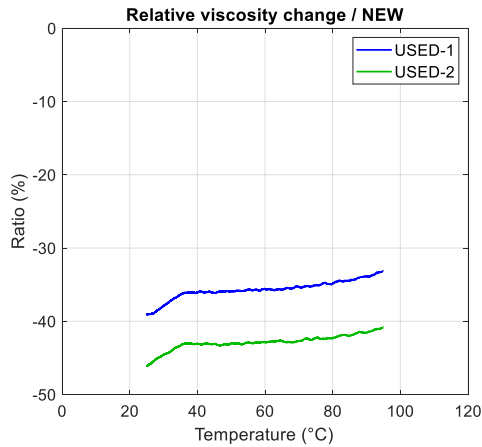

Figure 6: Relative viscosity change compared to the NEW oil according to (1).

The results (Figure 6) show that the viscosity of the used oils dropped in both cases. The one of the USED-1 oil dropped by 36 % in average over the whole temperature range. For the USED-2 oil, it decreased by 43 % in average. As mentioned previously, for engine oils the viscosity tends to increase with degradation [2]–[4], [7], [8], [12], [16], [18], [19], while the opposite is observed in that case. Indeed, the viscosity increase is typically attributed to elevated temperatures causing oxidation and thermal polymerization. In the present case, gearbox temperatures are moderate, thus low thermal oxidation is expected. However, mechanical components induce shearing, that is why the degradation state of the oil is different.

This is coherent with the studies mentioned previously indicating that the viscosity is lower after mechanical shearing [26]–[29]. This is a first result showing a difference of engine oils and transmission ones on the degradation. It suggests that both oils are not degraded in the same way, and therefore the impact of the degradation and potential consequences must be different. The lubricant is initially selected according to the characteristics of the application. Given a certain set of operating conditions, it must be able to separate contacting bodies with an oil film thickness high enough to prevent direct contact and hence reduce friction and wear. In the present case, field operation caused the viscosity to fall by approximately 40 %. According to the formula for the central oil film thickness calculation proposed by Hamrock and Dowson [53], a viscosity drop of 40 % represent a film thickness drop of approximately 30 %. With the same operating conditions, it might be challenging for the lubricant to maintain its ability to separate contacting surfaces, that is to be assessed with tribological testing (see Section b).

1.1.2. Fourier Transform InfraRed spectroscopy (FTIR)

The results of FTIR spectroscopy are presented in Figure 7, for clarity concern used oils spectra have been shifted upwards. Peaks indicating oxidation generally located around 1720 cm⁻¹ (grey area on the figure) are not present in that case. Figure 8 shows the difference between the NEW oil spectrum and the USED oils spectra. The resulting values range from -0.005 to 0.005, meaning that the differences are negligible, and all the spectra are similar. Therefore, no measurable oxidation and additive depletion have occurred in application.

The FTIR spectroscopy is frequently employed in oil condition monitoring and is suitable for oxidation or water contamination detection. Regarding engine oil cases, FTIR spectra show notable differences [11], [13], [14], [16], [18]. However, in the present case the similarity of the spectra indicates that no notable phenomenon is spotted. Again, this reinforces the idea that the oil degradation process in the tractor transmissions studied in the present work is different than in other applications such as engines. It indicates that, for transmission oils, FTIR spectroscopy should be completed by more advanced and detailed oil analysis techniques to gain a more precise understanding of the potential changes in the lubricant. For instance, techniques such as X-ray fluorescence spectroscopy, high-performance liquid chromatography, mass spectrometry or atomic absorption spectroscopy offer a more comprehensive insight into the oil chemistry.

1.1.3. X-Ray Fluorescence spectroscopy (XRF)

More detailed information about the oil composition and its evolution with degradation has been obtained with XRF spectroscopy. It provides the content of some chemical elements in the oil samples as shown in Table 2. Only specific chemical elements have been extracted from the results: phosphorus, sulphur, zinc, and calcium are related to additives while iron gives information on wear and/or contamination.

Phosphorus, zinc, and calcium in the used oils exhibit a slight decrease compared to the fresh oil. For sulphur, the measured concentrations must be interpreted carefully as sulphur is known to be volatile in mineral oils. Moreover, the field-collected oils might not be coming from the same oil batch than the fresh oil. That is why the sulphur content is considered as stable for all the samples in the present case. These observations on the additive-related elements highlight the additive depletion which has occurred in application. They could have been consumed when fulfilling their mission or degraded due to oxidation or shearing.

Furthermore, the values indicated by XRF spectroscopy refer to the content of chemical elements. They do not refer directly to the content of additive molecules. Besser *et al.* showed in [10] that antioxidant and antiwear additives are almost completely depleted after degradation while the elemental composition does not expose notable change. In fact, the molecules may have been deteriorated in some way, so the chemical elements may still be present in the lubricant without being effective as additives. Therefore, these results must be analyzed keeping in mind what is precisely being measured.

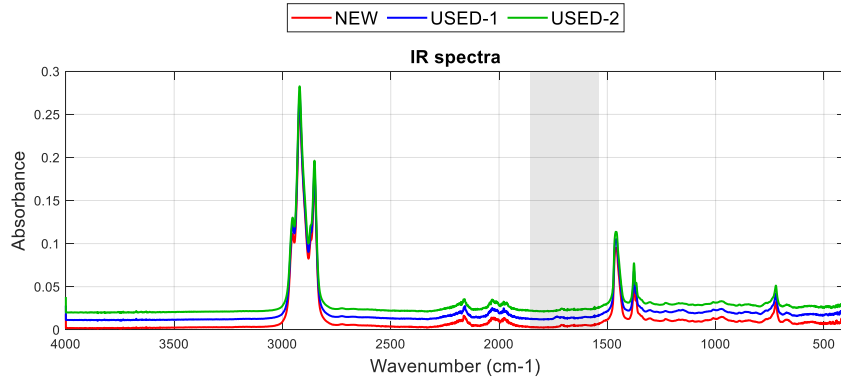

Figure 7: FTIR spectra of the oil samples.

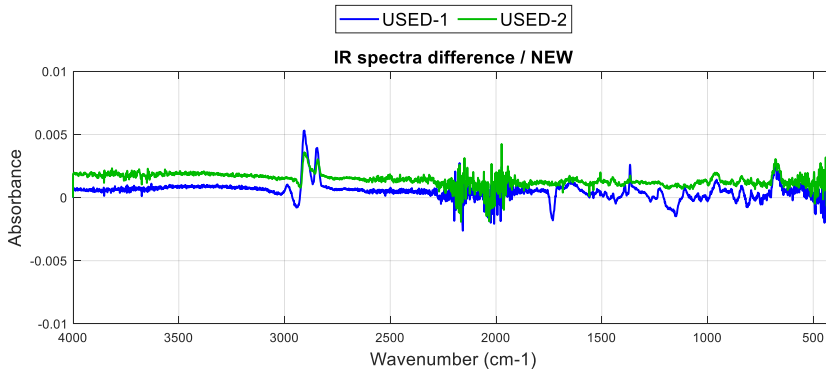

Figure 8: Difference between the NEW oil spectrum and the USED oils spectra.

Table 2
Elemental composition of the oil samples

Oil sample	P	S	Zn	Ca	Fe
NEW	ref	ref	ref	ref	ref
USED-1	67 %	110 %	77 %	70 %	161 %
USED-2	82 %	96 %	84 %	87 %	224 %

Another key indicator is the content of iron in the lubricant. For both USED oils, it has increased, and different hypotheses can explain it. If wear occurs between components in contact in application (specifically during running-in), debris are generated and ingested by the lubricant (internal contamination). In addition, various sources in the environment of the application potentially contaminate the lubricant with iron particles (external contamination). For instance, improper maintenance practices with dirty tools can introduce impurities into the lubricant. Iron-containing particles (either from internal or external contamination) can be damaging for the proper operation of the mechanical system. When trapped in the contacts, they cause surface indentation resulting in local pressure peaks and thus more friction and wear but also premature failures and damages on the components [54], [55]. Moreover, they can act as catalysts and accelerate oxidation reactions in the lubricant.

b. Tribological performance

The conducted analyses have shed light on the physical and chemical changes in the oils due to potential degradation. With identical operating conditions but different oil properties, the lubrication of the mechanical

system might be affected. The viscosity drop, the additive reduction and the contamination will certainly impact the tribological performance.

1.1.4. High Frequency Reciprocating Rig (HFRR) testing

Tribological testing has been performed on the HFRR with an inhouse test profile (Figure 1). Figure 9 exposes the film percentage and the friction coefficient for the NEW, USED-1 and USED-2 oils. Every test has been carried out twice, the bold line represents the mean curve of the two tests and the lighter area is delimited by minimum and maximum values. Table 3 and Table 4 show the average friction coefficient and film percentage for each step and each sample.

During the tests with the USED oils, the friction coefficient is always higher compared to the NEW oil and the difference is becoming larger as the temperature increases. As a result of the pure sliding condition, the lower oil film thickness due to lower viscosity leads to more asperity interactions and therefore higher friction. However, as the temperature rises throughout the test, the oil film becomes even thinner: there is more and more direct contact between both surfaces. In that case, additives are more reactive and building up more tribofilm, thus protecting steel surfaces. This could be one of the reasons explaining the gradual decrease of the friction coefficients throughout the test. This hypothesis is also supported by the fact that the film percentage values stay high even if the temperature rises. In this case, the higher oil film thickness and additive content of the NEW sample might justify its lower value. In addition, it seems that the friction coefficient of the NEW oil is not impacted by the film percentage drop during step 3.

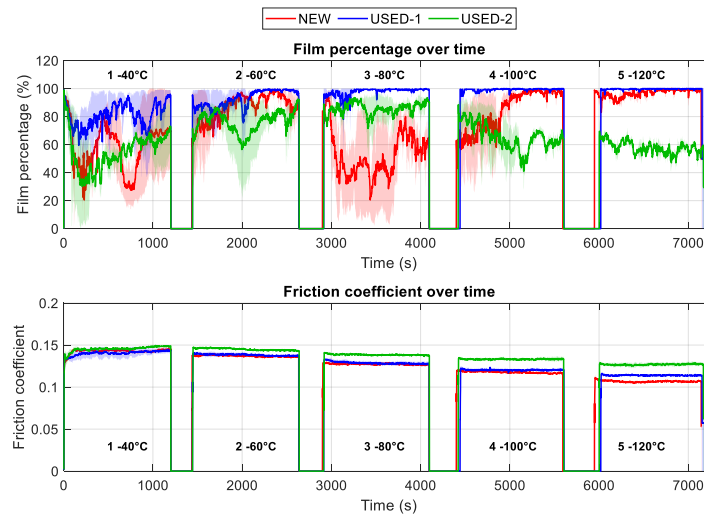

Figure 9: Film percentage and friction coefficient during the HFRR tests of the oil samples.

On this contact-level tribometer, the conducted tests show that the oils have a different tribological behaviour. However, it is important to underline that this test rig is employed to focus on some specific lubricant functionalities at the contact level. It is a single contact tribometer with specific conditions whose results cannot be directly related to friction and efficiency at the system level. As an example, Uy *et al.* showed in [22] that degraded lubricants show a lower wear rate and friction torque in component-level test rig while the friction coefficient is higher during HFRR tests.

Table 3

Average friction coefficient per step during HFRR tests of the oil samples

Oil sample	Step 1	Step 2	Step 3	Step 3	Step 4
NEW	0.143	0.137	0.127	0.118	0.107
USED-1	0.140	0.138	0.129	0.120	0.114
USED-2	0.146	0.145	0.139	0.133	0.127

Table 4

Average film percentage per step during HFRR tests of the oil samples

Oil sample	Step 1	Step 2	Step 3	Step 3	Step 4
NEW	59 %	87 %	53 %	85 %	97 %
USED-1	81 %	93 %	98 %	99 %	100 %
USED-2	55 %	76 %	86 %	66 %	58 %

After the tests, the two test specimens are cleaned and observed with a microscope (Figure 10). The wear tracks on the lower specimens look similar for all the oils: they are dark and exhibit scratches on the right and left sides. The harsh test conditions lead to the removal of surface particles, the dark area represents where this wear occurs. The generated wear particles can be trapped in the contact and expelled at the end of the oscillating movement, causing the observed scratches.

The upper specimens of the three oil samples present more differences. For the NEW oil, the picture shows notable scratches in the wear mark whereas there are very few for the other wear marks. They all exhibit blue and brown patches with a varying density. Their origin has not been identified, it might be attributed to the formation of

tribofilm patches but it requires chemical analysis to confirm.

To go further in the morphological analysis of the wear marks, some characteristic parameters have been measured on the lower specimens. As shown on Figure 11, the wear mark after a HFRR test is characterized by a central valley with shoulders on the right and left sides. These shoulders are generally attributed to the plastic displacement of the material. Several quantities can be measured to discriminate the different wear marks. In the present study, three indicators have been chosen: the peak volume, the valley volume and the maximal depth of the wear marks.

The results listed in Table 5 indicate that the peak and valley volumes are larger for the USED-2 oil than for the NEW and USED-1 oils, which are closer, highlighting the increased wear for this case. Another observation is that the peak volume is higher than the valley volume in the NEW and USED-1 cases. If only wear occurs in the track, the peak volume should be lower than the valley volume, which is the case for the USED-2 oil. One hypothesis that might justify these observations is that other deposits in the valley (*e.g.* tribofilm) are detected by the microscope, thus decreasing the valley volume. Additionally, the maximal depths of the USED oils are slightly higher than the one of the NEW oil, underlining the higher deterioration of the specimens for the degraded oils. The performed morphological measurements allow to discriminate the wear marks of the HFRR tests, however it requires more precise analysis (*e.g.* chemical analysis) to verify the hypotheses and gain information on the wear behaviour and additive activity of the fresh and degraded oils.

Table 5

Morphological characteristics of the HFRR lower specimen wear marks

Oil variant	Peak volume (μm^3)	Valley volume (μm^3)	Maximal depth (nm)
NEW	20,142	16,796	435
USED-1	21,991	14,409	615
USED-2	29,333	34,400	582

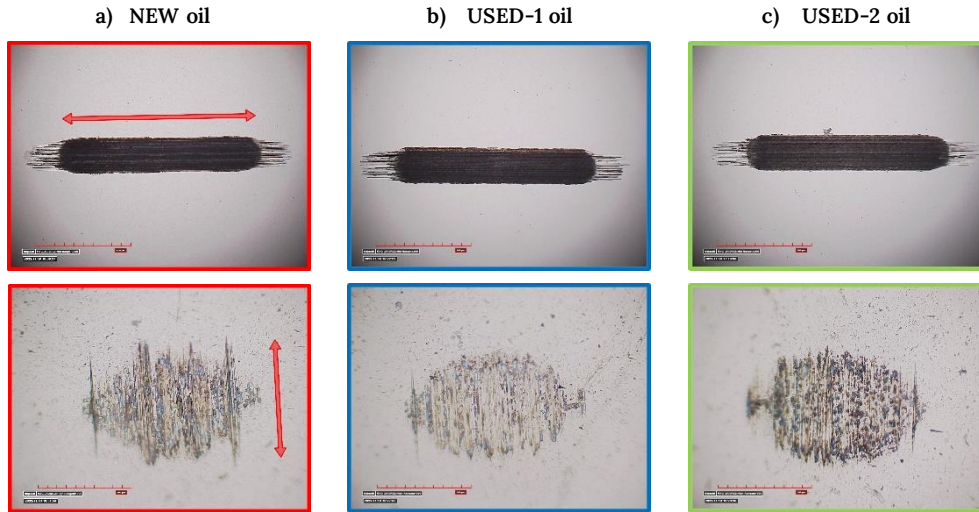

Figure 10: Microscope pictures of lower (1st row) and upper (2nd row) specimens after the HFRR tests (red arrows indicate the direction of the reciprocating movement)

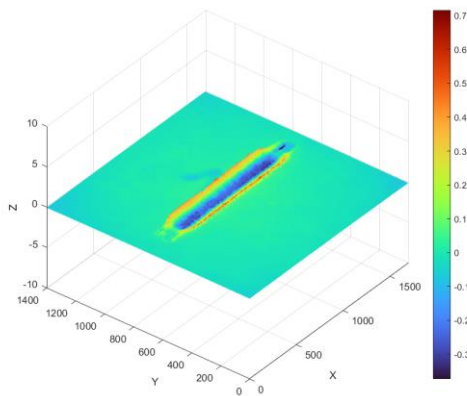

Figure 11: 3D view of a wear mark after the HFRR test.

1.1.1. Mini Traction Machine (MTM) testing

MTM tests have been conducted to evaluate oil samples performance for different conditions than the HFRR, in particular rolling has been introduced in the contact. The test profile is given Figure 2.

Figure 12 shows the friction coefficient during the MTM tests for all the samples. The one of the NEW oil falls at the beginning then rises slowly until it reaches 0.08 at the end of the test. The drop at the beginning is likely due to running-in in the contact, leading to a smoothing of the surface and thus lower friction coefficient. For the field-collected samples, the friction coefficient is more stable but at a much higher value: around 0.11 for the USED-1 oil and almost 0.13 for the USED-2 oil.

The pictures of the ball wear track recorded during the tests with the SLIM method are exposed Figure 13. The adjustment of the contact area between the ball and the camera includes both the inner and outer side of the wear track. Indeed, the blue area at the top of the contact area is outside the wear track. In this way, any evolution in the wear track can be distinguished when compared to the outer section. The first picture is captured at the beginning of the test, the contact area is blue and uniform for all the oils, since no chemical reaction happened yet in the wear track. Progressively, a brownish coloration starts appearing, generally attributed to the growth of tribofilm in the wear track [40], [41], [44]–[48], [52]. In the present case, a darker wear track corresponds to a thicker tribofilm. For the NEW oil,

the tribofilm started to build up clearly on the 6th picture, after 4 hours and a Stribeck curve. For the USED oils, the first distinct color change is observed on the 4th picture, after only 1 hour of running. The tribolayer is building up earlier for the field-collected lubricants, while it requires more time for the fresh oil. The color of the contact zone in images 4 and 5 for USED-2 oil suggests that the tribofilm formed at this point is thicker than that of the other two oils throughout the test. Moreover, it seems that the tribofilm of the used oils has been worn off and grew again during the test.

Finally, the major evolutions in the wear track appearance are observed on the pictures taken before and after the acquisition of the Stribeck curves (e.g., pictures 4 and 5, pictures 6 and 7 and pictures 11 and 12). The shift from darker to lighter coloration denoted in most cases corresponds to a deterioration of the tribofilm. The pictures 4 and 5 of the USED-2 oil are an exception and exhibit the opposite trend: the wear track is slightly darker, the tribofilm has grown a bit more. The steps during which the Stribeck curves are acquired, different entrainment speeds are evaluated. The low values in the speed range set the contact in the boundary lubrication regime. This means asperity interactions are accentuated which can result in tribofilm growth or wear off.

In sum, optical interferometry of the SLIM enabled to highlight that tribofilm generation and removal mechanisms are different depending on the oil. Thus, in the present case, tribofilm growth and wear behaviours are impacted by oil degradation.

After the tests, the upper specimen (ball) where the tribofilm potentially builds up is cleaned and observed with a microscope. Ball wear tracks are shown Figure 14 before (left) and after (right) cleaning with EDTA. The brown and blue colorations indicate that some reactions took place in the contact area, traditionally attributed to the formation of tribofilm [3], [38], [41], [46]. On the left side of the pictures, the tribofilm of the field-collected oils looks different than in the case of the fresh oil. The width, the colors, and the density of the formed tribolayers are some characteristics that have changed. The wear tracks have been cleaned with EDTA, known to remove only tribofilm and leave other deposits. On the right side of the pictures, the brown and blue patches disappear, confirming it was tribofilm.

Regarding lower specimen wear tracks, they exhibit a brown coloration, light for the NEW and USED-1 oils and dark

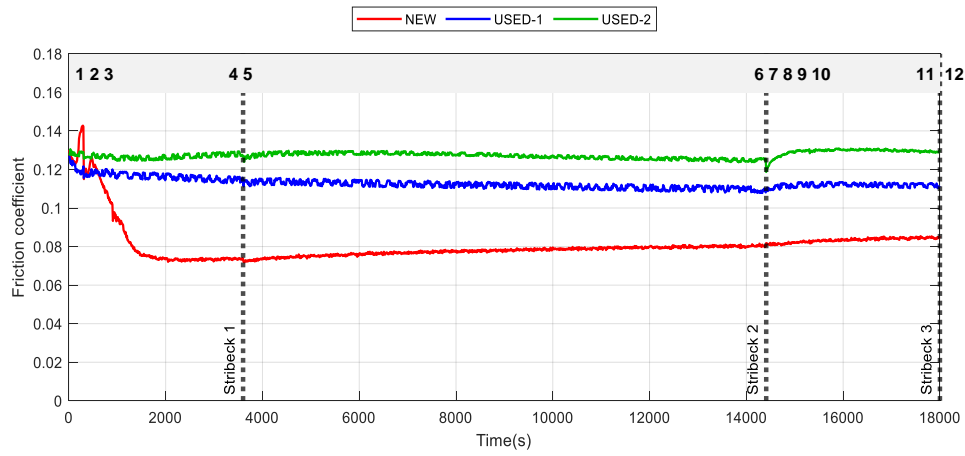

Figure 12: Friction coefficient during the MTM tests of the oil samples

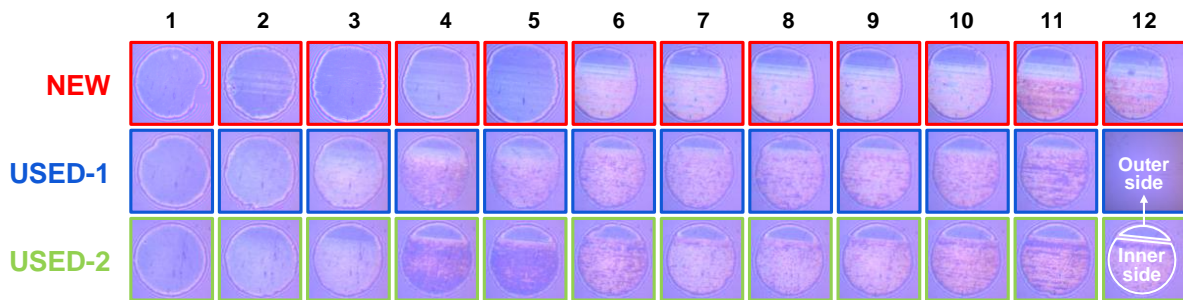

Figure 13: SLIM pictures of the ball wear track during the MTM tests for the NEW oil (red), USED-1 oil (blue) and USED-2 oil (green).

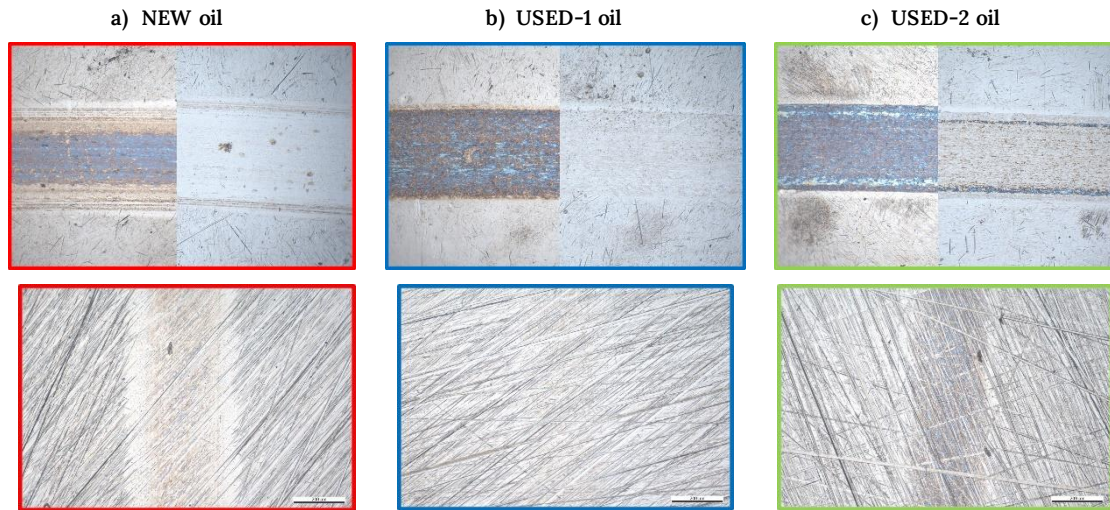

Figure 14: Microscope pictures of the upper specimens (1st row) before and after cleaning with EDTA and the lower specimens (2nd row) after the MTM tests.

for the USED-2 oil. The wear track for the USED-1 case looks almost unaffected whereas the two other wear tracks are more impacted.

To understand better the potential changes in these wear marks, the surface topology has been assessed. Roughness measurements on the lower specimens are presented Figure 15. The darker rectangles refer to the roughness outside the wear track, whereas the lighter rectangles indicate the one inside the track after the test. For all the oils, the roughness has decreased inside the track, the surfaces are smoothed during the MTM tests. The biggest gap between the inside and outside roughnesses is for the NEW oil case. This might be a consequence of the initial running-in, leading to a smoothed

surface and thus to the observed lower friction coefficient. Both USED oil cases present lower gaps compared to the NEW oil case. The USED-1 oil cases has the lowest gap in terms of roughness, which is consistent with the lower specimen aspect on the microscope picture that is almost unchanged.

As a result, MTM testing has highlighted differences in the tribological behaviour of the fresh and field-collected oils, especially in terms of friction and tribofilm formation. The test parameters on the MTM have been chosen to position the contact at the border between the boundary and the mixed lubrication regime. Therefore, the viscosity reduction of the USED oils corresponds to a higher friction coefficient due to

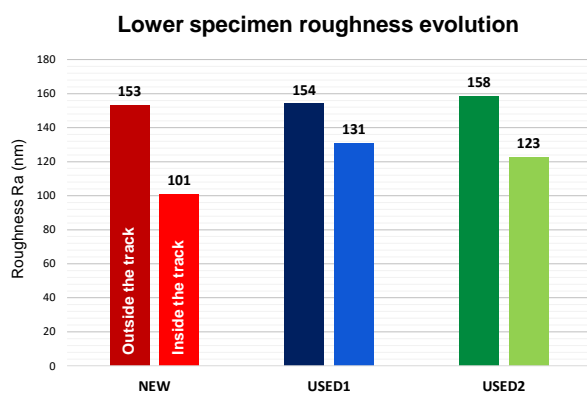

Figure 15: Arithmetic average roughness inside and outside the wear track of the lower specimens of the MTM tests.

increased asperity-asperity contacts. Moreover, the higher asperity interactions are responsible for different tribofilm formation and removal mechanisms in the case of the USED oils.

4. Discussion

In both tribometers, some similarities can be identified. It is observed that field-collected oils behave differently than the fresh oil: they exhibit a higher friction coefficient. Both on the HFRR and the MTM, the selected test parameters were severe. Consequently, a reduction in viscosity signifies a shift towards harsher conditions, where increased friction is expected. At the same time, the harsher conditions contribute to both enhanced tribofilm formation and its subsequent removal. The higher friction due to lower viscosity and the tribofilm generation fostered by accentuated asperity interactions are competing in the contact. In addition, the increasing content of iron is coherent with the results, in the sense that more contaminants also lead to higher friction. From this point of view, the operation in the field has induced a change in the behaviour of the lubricant during contact-level tribological testing.

Both test rigs have highlighted the impact of the physical and chemical properties evolution on the tribological performance. Field-collected lubricants had a lower viscosity, lower content of additives and higher iron content. For the same operating conditions, it led to higher friction coefficient but also higher tribofilm generation. Depending on the contact conditions, the latter can result in friction reduction or increase.

5. Conclusion

The present study has shown that oil degradation can have a significant impact on the tribological performance of lubricants. Conventional and advanced oil analysis techniques as well as single contact tribometers have been used to evaluate the degradation level of lubricants collected from tractor transmissions that have operated in the field.

Thanks to these investigations, viscosity drop and additive depletion have been identified as the main physical and chemical changes occurring in the transmission oil during operation. In addition, field-collected lubricants exhibit a higher level of contamination. Tribological testing has demonstrated that degradation impacts on the physical and chemical properties of the lubricant can lead to harsher

conditions and therefore higher friction in the tribological contacts. At the same time, tribofilm formation is also enhanced, competing with the asperity interactions in the contact.

In contrast to the extensively investigated domain of engine oils, transmission oils exhibit several distinctive characteristics. Viscosity evolution with degradation show different trends, and it is apparent that the use of FTIR spectroscopy alone may not be sufficient for a comprehensive assessment of degraded oils. This implies the necessity for a differentiated approach to understand the degradation impacts of these two oil categories. However, the validation of these observations necessitates a more comprehensive study.

More work is also required to build knowledge on field operation consequences in this type of application and be able to generalize the conclusions. Additional physico-chemical properties could be evaluated with advanced techniques to have more detailed knowledge on the degradation impacts. For instance, parameters such as thermal and chemical stability, oxidation, acidity or even antioxidant property could be measured. Moreover, chemical analysis of tribological testing specimens can bring valuable insights on the wear behavior and additive activity of the oil samples. Also, testing at system level is necessary to gain information on the behaviour of the lubricants in more realistic conditions.

Finally, this work emphasizes the need to clarify the relations between physical and chemical parameters (commonly measured during oil condition monitoring) and tribological and system level behaviour, which is the actual performance. This will lead to have a more precise understanding of the lubricant degradation phenomenon and its impact on the performance of mechanical systems.

6. CRediT authorship contribution statement

Büşra Duran: Writing – original draft, Methodology, Conceptualization, Formal analysis, Investigation, Visualization. **Jérôme Cavoret:** Methodology, Data curation. **David Philippon:** Writing – review & editing, Methodology, Conceptualization, Investigation, Supervision. **Fabrice Ville:** Writing – review & editing, Methodology, Conceptualization, Investigation, Supervision, Project administration, Funding acquisition. **Arnaud Ruellan:** Writing – review & editing, Methodology, Conceptualization, Investigation, Supervision, Funding acquisition. **Frank Berens:** Writing – review & editing, Methodology, Conceptualization, Investigation, Supervision, Project administration.

7. Declaration of Competing Interest

The authors declare that they have no known competing financial interests or personal relationships that could have appeared to influence the work reported in this paper.

8. Acknowledgments

The authors would like to express their gratitude to GIMA for providing the oil samples used in this study, as well as to the ANRT (CIFRE N° 2021/1080) for their support.

9. References

- [1] K. Holmberg and A. Erdemir, 'The impact of tribology on energy use and CO₂ emission globally and in combustion engine and electric cars', *Tribol. Int.*, vol. 135, pp. 389–396, Jul. 2019, doi: 10.1016/J.TRIBOINT.2019.03.024.
- [2] N. Dörr, J. Brenner, A. Ristić, B. Ronai, C. Besser, V. Pejaković, and M. Frauscher, 'Correlation Between Engine Oil Degradation, Tribochemistry, and Tribological Behavior with Focus on ZDDP Deterioration', *Tribol. Lett.*, vol. 67, no. 2, pp. 1–17, Jun. 2019, doi: 10.1007/s11249-019-1176-5.
- [3] M. De Feo, C. Minfray, M. I. De Barros Bouchet, B. Thiebaut, T. Le Mogne, B. Vacher, and J. M. Martin, 'Ageing impact on tribological properties of MoDTC-containing base oil', *Tribol. Int.*, vol. 92, pp. 126–135, Jun. 2015, doi: 10.1016/j.triboint.2015.04.014.
- [4] J. C. O. Santos, I. M. G. dos Santos, A. G. Souza, E. V. Sobrinho, V. J. Fernandes, and A. J. N. Silva, 'Thermoanalytical and rheological characterization of automotive mineral lubricants after thermal degradation', *Fuel*, vol. 83, no. 17–18, pp. 2393–2399, Dec. 2004, doi: 10.1016/j.fuel.2004.06.016.
- [5] M. De Feo, C. Minfray, M. I. De Barros Bouchet, B. Thiebaut, and J. M. Martin, 'MoDTC friction modifier additive degradation: Correlation between tribological performance and chemical changes', *RSC Adv.*, vol. 5, no. 114, pp. 93786–93796, Oct. 2015, doi: 10.1039/c5ra15250j.
- [6] M. I. De Barros Bouchet, J. M. Martin, T. Le Mogne, P. Bilas, B. Vacher, and Y. Yamada, 'Mechanisms of MoS₂ formation by MoDTC in presence of ZnDTP: Effect of oxidative degradation', *Wear*, vol. 258, no. 11–12, pp. 1643–1650, Jun. 2005, doi: 10.1016/j.wear.2004.11.019.
- [7] A. Sheikhsari, E. Alborzi, C. Parks, S. Siouris, and S. Blakey, 'Investigation of Aviation Lubricant Aging under Engine Representative Conditions', *Tribol. Trans.*, vol. 64, no. 3, pp. 501–512, 2021, doi: 10.1080/10402004.2020.1862378.
- [8] A. B. Vipper, I. I. Zadko, M. V. Ermolaev, and J. Y. Oleinik, 'Engine oil ageing under laboratory conditions', *Lubr. Sci.*, vol. 14, no. 3, pp. 363–375, May 2002, doi: 10.1002/ls.3010140307.
- [9] C. Besser, N. Dörr, F. Novotny-Farkas, K. Varmuza, and G. Allmaier, 'Comparison of engine oil degradation observed in laboratory alteration and in the engine by chemometric data evaluation', *Tribol. Int.*, vol. 65, pp. 37–47, 2013, doi: 10.1016/j.triboint.2013.01.006.
- [10] C. Besser, A. Agocs, A. Ristic, and M. Frauscher, 'Implementation of Nitration Processes in Artificial Ageing for Closer-to-Reality Simulation of Engine Oil Degradation', *Lubricants*, vol. 10, no. 298, Nov. 2022, doi: 10.3390/LUBRICANTS10110298.
- [11] C. Besser, C. Schneidhofer, N. Dörr, F. Novotny-Farkas, and G. Allmaier, 'Investigation of long-term engine oil performance using lab-based artificial ageing illustrated by the impact of ethanol as fuel component', *Tribol. Int.*, vol. 46, pp. 174–182, Feb. 2012, doi: 10.1016/j.triboint.2011.06.026.
- [12] M. Björling, B. Björling, K. Berglund, A. Spencer, and R. Larsson, 'The effect of ageing on elastohydrodynamic friction in heavy duty diesel engine oils', *Proc. Inst. Mech. Eng. Part J J. Eng. Tribol.*, vol. 231, no. 6, pp. 708–715, 2017, doi: 10.1177/1350650116674848.
- [13] H. Cen, A. Morina, and A. Neville, 'Effect of lubricant ageing on lubricants' physical and chemical properties and tribological performance; Part I: effect of lubricant chemistry', *Ind. Lubr. Tribol.*, vol. 70, no. 2, pp. 385–392, 2018, doi: 10.1108/ILT-03-2017-0059.
- [14] H. Cen, A. Morina, and A. Neville, 'Effect of ageing on lubricants' physical and chemical properties and tribological performance: Part II: effect of water contamination on lubricant', *Ind. Lubr. Tribol.*, vol. 71, no. 1, pp. 48–53, Jan. 2019, doi: 10.1108/ILT-01-2018-0025.
- [15] De Feo Modestino, 'Impact of thermo-oxidative degradation of MoDTC additive on its tribological performances for steel-steel and DLC-steel contacts' Ph.D. dissertation, Ecole Centrale de Lyon, Lyon, 2015. [Online]. Available: <https://tel.archives-ouvertes.fr/tel-01424132>
- [16] N. Dörr, A. Agocs, C. Besser, A. Ristić, and M. Frauscher, 'Engine Oils in the Field: A Comprehensive Chemical Assessment of Engine Oil Degradation in a Passenger Car', *Tribol. Lett.*, vol. 67, no. 3, 2019, doi: 10.1007/s11249-019-1182-7.
- [17] A. Agocs, C. Besser, J. Brenner, S. Budnyk, M. Frauscher, and N. Dörr, 'Engine Oils in the Field: A Comprehensive Tribological Assessment of Engine Oil Degradation in a Passenger Car', *Tribol. Lett.*, vol. 70, Mar. 2022, doi: 10.1007/s11249-022-01566-7.
- [18] Q. Zeng, G. Dong, Y. Yang, and T. Wu, 'Performance Deterioration Analysis of the Used Gear Oil', *Adv. Chem. Eng. Sci.*, vol. 06, no. 02, pp. 67–75, 2016, doi: 10.4236/ACES.2016.62008.
- [19] A. L. Nagy, J. Rohde-Brandenburger, and I. Zsoldos, 'Artificial Aging Experiments of Neat and Contaminated Engine Oil Samples', *Lubricants*, vol. 9, no. 63, Jun. 2021, doi: 10.3390/LUBRICANTS9060063.
- [20] A. Singh, R. T. Gandra, E. W. Schneider, and S. K. Biswas, 'Lubricant degradation and related wear of a steel pin in lubricated sliding against a steel disc', *ACS Appl. Mater. Interfaces*, vol. 3, no. 7, pp. 2512–2521, Jul. 2011, doi: 10.1021/AM200375A.
- [21] W. Tuszynski, R. Michalczewski, W. Piekoszewski, and M. Szczerek, 'Effect of ageing automotive gear oils on scuffing and pitting', *Tribol. Int.*, vol. 41, no. 9–10, pp. 875–888, Sep. 2008, doi: 10.1016/J.TRIBOINT.2007.12.010.
- [22] D. Uy, S. J. Simko, R. O. Carter, R. K. Jensen, and A. K. Gangopadhyay, 'Characterization of anti-wear films formed from fresh and aged engine oils', *Wear*, vol. 263, no. 7–12 SPEC. ISS., pp. 1165–1174, Sep. 2007, doi: 10.1016/j.wear.2006.12.026.
- [23] K. Berglund, P. Marklund, and R. Larsson, 'Lubricant ageing effects on the friction characteristics of wet clutches', *Proc. Inst. Mech. Eng. Part J J. Eng. Tribol.*, vol. 224, no. 7, pp. 639–647, Jul. 2010, doi: 10.1243/13506501JET734.
- [24] T. Cousseau, J. S. Ruiz Acero, and A. Sinatora, 'Tribological response of fresh and used engine oils: The effect of surface texturing, roughness and fuel type', *Tribol. Int.*, vol. 100, pp. 60–69, Aug. 2016, doi: 10.1016/J.TRIBOINT.2015.11.016.
- [25] A. M. Barnes, K. D. Bartle, and V. R. A. Thibon, 'A review of zinc dialkyldithiophosphates (ZDDPS): Characterisation and role in the lubricating oil', *Tribol. Int.*, vol. 34, no. 6, pp. 389–395, 2001, doi: 10.1016/S0301-679X(01)00028-7.
- [26] B. Wright and J. P. R. du Parquet, 'Degradation of polymers in multigrade lubricants by mechanical shear', *Polym. Degrad. Stab.*, vol. 5, no. 6, pp. 425–447, Jan. 1983, doi: 10.1016/0141-3910(83)90025-3.
- [27] M. Mortier, 'Laboratory shearing tests for viscosity index improvers', *Tribotest*, vol. 2, no. 4, pp. 329–349, 1996, doi: 10.1002/tt.3020020403.
- [28] M. J. Covitch, J. Weiss, and I. M. Kreutzer, 'Low-temperature rheology of engine lubricants subjected to mechanical shear: Viscosity modifier effects', *Lubr. Sci.*, vol. 11, no. 4, pp. 337–364, Aug. 1999, doi: 10.1002/LS.3010110403.
- [29] P. Bezot, C. Hesse-Bezot, D. Faure, and J. C. Calvez, 'The effect of mechanical stress on four viscosity improver polymers', *Lubr. Sci.*, vol. 12, no. 4, pp. 301–312, Jul. 2000, doi: 10.1002/LS.3010120402.
- [30] N. Robinson, 'Monitoring Oil Degradation With Infrared Spectroscopy', *Machinery Lubrication*, 2007. Accessed: Oct. 10, 2023. [Online]. Available: <https://www.machinerylubrication.com/Read/1109/oil-degradation-spectroscopy>
- [31] Noria Corporation, 'Fourier Transform Infrared Spectroscopy', *Machinery Lubrication*, 2002. Accessed: Oct. 10, 2023. [Online]. Available: <https://www.machinerylubrication.com/Read/305/fourier-transform-infrared-spectroscopy>
- [32] C. M. C. G. Fernandes, R. C. Martins, and J. H. O. Seabra, 'Torque loss of type C40 FZG gears lubricated with wind turbine gear oils', *Tribol. Int.*, vol. 70, pp. 83–93, Feb. 2014, doi: 10.1016/j.triboint.2013.10.003.
- [33] J. A. Wolska and B. A. R. Vrebos, 'XRF: A Powerful Oil Analysis Tool', *Machinery Lubrication*, 2004. Accessed: Oct. 10, 2023. [Online]. Available: <https://www.machinerylubrication.com/Read/602/xrf-oil-analysis>.

- [34] A. Kontou, R. I. Taylor, and H. A. Spikes, 'Effects of Dispersant and ZDDP Additives on Fretting Wear', *Tribol. Lett.*, vol. 69, no. 1, p. 6, Mar. 2021, doi: 10.1007/s11249-020-01379-6.
- [35] A. Adebogun, R. Hudson, A. Matthews, and P. J. Withers, 'Industrial Gear Oils: Influence of Bulk Oil Temperature and Contact Pressure on Tribological Performance and Subsurface Changes', *Tribol. Lett.*, vol. 68, no. 1, p. 48, Mar. 2020, doi: 10.1007/s11249-020-1287-z.
- [36] P. Rabaso, F. Ville, F. Dassenoy, M. Diaby, P. Afanasiev, J. Cavoret, B. Vacher, and T. Le Mogne, 'Boundary lubrication: Influence of the size and structure of inorganic fullerene-like MoS₂ nanoparticles on friction and wear reduction', *Wear*, vol. 320, no. 1, pp. 161–178, 2014, doi: 10.1016/j.wear.2014.09.001.
- [37] P. Rabaso, F. Dassenoy, F. Ville, M. Diaby, B. Vacher, T. Le Mogne, M. Belin, and J. Cavoret, 'An Investigation on the Reduced Ability of IF-MoS₂ Nanoparticles to Reduce Friction and Wear in the Presence of Dispersants', *Tribol. Lett.*, vol. 55, no. 3, pp. 503–516, Sep. 2014, doi: 10.1007/s11249-014-0381-5.
- [38] M. Meheux, C. Minfray, F. Ville, T. Le Mogne, A. A. Lubrecht, J. M. Martin, and H. P. Lieurade, 'Influence of slide-to-roll ratio on tribofilm generation', *Proc. Inst. Mech. Eng. Part J J. Eng. Tribol.*, vol. 222, no. 3, pp. 325–334, Mar. 2008, doi: 10.1243/13506501JET349.
- [39] J. E. Johansson, M. T. Devlin, J. M. Guevremont, and B. Prakash, 'Effects of Gear Oil Properties on Pitting Life in Rolling Four-Ball Test Configuration', *Tribol. Trans.*, vol. 57, no. 1, pp. 104–113, 2014, doi: 10.1080/10402004.2013.856979.
- [40] J. Zhang and H. Spikes, 'On the Mechanism of ZDDP Antiwear Film Formation', *Tribol. Lett.*, vol. 63, no. 2, p. 24, Aug. 2016, doi: 10.1007/s11249-016-0706-7.
- [41] V. Brizmer, C. Matta, I. Nedelcu, and G. E. Morales-Espejel, 'The Influence of Tribolayer Formation on Tribological Performance of Rolling/Sliding Contacts', *Tribol. Lett.*, vol. 65, no. 2, Jun. 2017, doi: 10.1007/s11249-017-0839-3.
- [42] J. A. Brandão, M. Meheux, J. H. O. Seabra, F. Ville, and M. J. D. Castro, 'Traction curves and rheological parameters of fully formulated gear oils', *Proc. Inst. Mech. Eng. Part J J. Eng. Tribol.*, vol. 225, no. 7, pp. 577–593, Jul. 2011, doi: 10.1177/1350650111405111.
- [43] J. A. Brandão, M. Meheux, F. Ville, J. H. O. Seabra, and J. Castro, 'Comparative overview of five gear oils in mixed and boundary film lubrication', *Tribol. Int.*, vol. 47, pp. 50–61, Mar. 2012, doi: 10.1016/j.triboint.2011.10.007.
- [44] Y. Shimizu and H. A. Spikes, 'The Tribofilm Formation of ZDDP Under Reciprocating Pure Sliding Conditions', *Tribol. Lett.*, vol. 64, no. 3, p. 46, Dec. 2016, doi: 10.1007/s11249-016-0776-6.
- [45] M. Ueda, H. Spikes, and A. Kadiric, 'In-situ observations of the effect of the ZDDP tribofilm growth on micropitting', *Tribol. Int.*, vol. 138, pp. 342–352, Oct. 2019, doi: 10.1016/j.triboint.2019.06.007.
- [46] K. Topolovec-Miklozic, T. R. Forbus, and H. A. Spikes, 'Film thickness and roughness of ZDDP antiwear films', *Tribol. Lett.*, vol. 26, no. 2, pp. 161–171, Mar. 2007, doi: 10.1007/s11249-006-9189-2.
- [47] K. T. Miklozic, T. R. Forbus, and H. A. Spikes, 'Performance of Friction Modifiers on ZDDP-Generated Surfaces', *Tribol. Trans.*, vol. 50, no. 3, pp. 328–335, Jun. 2007, doi: 10.1080/10402000701413505.
- [48] M. K. Dubey, R. Chaudhary, R. Emmandi, S. Seth, R. Mahapatra, A. K. Harinarain, and S. S. V. Ramakumar, 'Tribological evaluation of passenger car engine oil: Effect of friction modifiers', *Results Eng.*, vol. 16, Dec. 2022, doi: 10.1016/j.rineng.2022.100727.
- [49] PCS Instruments, 'MTM Brochure' <https://pcs-instruments.com>. https://pcs-instruments.com/wp-content/uploads/2021/01/MTM-Brochure_Final.pdf (accessed Oct. 10, 2023).
- [50] A. Ghanbarzadeh, E. Piras, I. Nedelcu, V. Brizmer, M. C. T. Wilson, A. Morina, D. Dowson, and A. Neville, 'Zinc dialkyl dithiophosphate antiwear tribofilm and its effect on the topography evolution of surfaces: A numerical and experimental study', *Wear*, vol. 362–363, pp. 186–198, Sep. 2016, doi: 10.1016/J.WEAR.2016.06.004.
- [51] A. Karpinska, 'Running-in and the evolution of metallic surfaces subjected to sliding and rolling contact' Ph.D. dissertation, Imperial College London, London, 2010. [Online]. Available: <http://hdl.handle.net/10044/1/6191>
- [52] Y. Shimizu and H. A. Spikes, 'The Influence of Slide-Roll Ratio on ZDDP Tribofilm Formation', *Tribol. Lett.*, vol. 64, no. 2, p. 19, Nov. 2016, doi: 10.1007/s11249-016-0738-z.
- [53] B. J. Hamrock and D. Dowson, 'Isothermal Elastohydrodynamic Lubrication of Point Contacts: Part 1—Theoretical Formulation', *J. Lubr. Technol.*, vol. 98, no. 2, pp. 223–228, Apr. 1976, doi: 10.1115/1.3452801.
- [54] F. Ville and D. Nelias, 'Early Fatigue Failure Due to Dents in EHL Contacts', *Tribol. Trans.*, vol. 42, no. 4, pp. 795–800, Jan. 1999, doi: 10.1080/10402009908982285.
- [55] R. S. Dwyer-Joyce, 'The Life Cycle of a Debris Particle', *Tribol. Interface Eng. Ser.*, vol. 48, pp. 681–690, 2005, doi: 10.1016/S0167-8922(05)80070-7.