



HAL
open science

A viscoplasticity model to predict delayed behavior of materials: parametric study and application to ancient textiles

Rana Al Ali, Mohamed Dallel, Elhem Ghorbel, Boumediene Nedjar

► To cite this version:

Rana Al Ali, Mohamed Dallel, Elhem Ghorbel, Boumediene Nedjar. A viscoplasticity model to predict delayed behavior of materials: parametric study and application to ancient textiles. 25ème Congrès Français de Mécanique, Association Française de Mécanique - AFM, Aug 2022, Nantes, France. 6 p. hal-04280012

HAL Id: hal-04280012

<https://hal.science/hal-04280012>

Submitted on 13 Nov 2023

HAL is a multi-disciplinary open access archive for the deposit and dissemination of scientific research documents, whether they are published or not. The documents may come from teaching and research institutions in France or abroad, or from public or private research centers.

L'archive ouverte pluridisciplinaire **HAL**, est destinée au dépôt et à la diffusion de documents scientifiques de niveau recherche, publiés ou non, émanant des établissements d'enseignement et de recherche français ou étrangers, des laboratoires publics ou privés.

A viscoplasticity model to predict delayed behavior of materials: parametric study and application to ancient textiles

R. AL ALI^{a,b,c}, M. DALLEL^b, E. GHORBEL^a, B. NEDJAR^c

a. L2MGC, Cergy Paris Université, Neuville-sur-Oise, France,
rana.al-ali@cyu.fr / elhem.ghorbel@cyu.fr

b. LRMH, Laboratoire de recherche des monuments historiques, Champs-sur-Marne, France,
mohamed.dallel@culture.gouv.fr

c. EMGCU, Université Gustave Eiffel, Champs-sur-Marne, France,
boumediene.nedjar@univ-eiffel.fr

Abstract:

Numerical modeling offers a great tool for evaluating textile materials and predicting their behavior. Many researchers have modeled the behavior of textiles. However, none of these proposed models that take into account the effect of time, namely the creep behavior. This phenomenon is of great importance when dealing with historical and museographical textile such like tapestries since they are hung for a long period of time. And under their own weight will undergo permanent deformations, later in time. In this work, we propose a new frame of work that includes a time-dependent visco-elastic network responsible of the time-delayed response, and an elastic-plastic network that is able to simulate permanent deformations especially in the weak zones of the material. This mechanical coupling is ensured by the use of the rheological model implemented in Abaqus, the two-layers viscoplasticity. It's a well-known model and widely used nowadays to model structures that undergo cyclic behaviors and relaxation after forming process. In this work, we first explore this model by mean of a 1D numerical integration, which allows a direct parametric study and to highlight its ability to simulate creep: primary, secondary and tertiary. Then this model implemented in Abaqus, was used to study the creep of hanged tapestries. This needed an analytical formulation of the problem in the tensorial form, the tapestry was simulated as a shell. It allows to find the evolution of the tapestry with time and to predict the failure zones in tapestries.

Key-words: creep, two-layers viscoplasticity, finite elements method, ancient textiles, conservation.

1 Introduction

The so called two-layers viscoplasticity model was initially proposed by Kichenin in 1996 [1] to study non-linear viscoelasticity of polyethylene. The “one-dimensional” constitutive model he proposed was intended to study the cyclic behavior of this material, namely the creep, stress-relaxation and strain rates effect. The model associated a Maxwell branch in parallel with an elastoplastic one with kinematic hardening. Later on, this model was implemented into the finite element (FE) tool Abaqus [2] and

extended to the three-dimensional. One advantage of this material model is that it allows to assign for each non-linear element, different material laws. Such as von-Mises or Hill criteria for the plasticity with stress-strain experimental data to be defined for the plastic flow. Regarding the viscous element, one can chose from different power laws such as Norton-Hoff law, defined through viscous properties found experimentally.

In the last two decades, the two-layers models has been used to study a wide range of materials. In [3], the viscous properties of polymer Nafion was determined using the two-layers models with an inverse procedure based on simple indentation test. Berezvai et al [4] used this model to predict the behavior of thermoplastic foam during forming procedures. In [5], the fatigue behavior of a metal composites polymers was modeled. Then, for our purpose to predict the behavior of ancient textile under their own weight, this model seems to be well-adapted. This has been validated through this article, and some of the results of tapestries in different configurations are presented.

2 The Two-layers viscoplasticity model

We consider the illustration of this model in Figure 1. It is a parallel coupling of two networks denoted [I] and [II]:

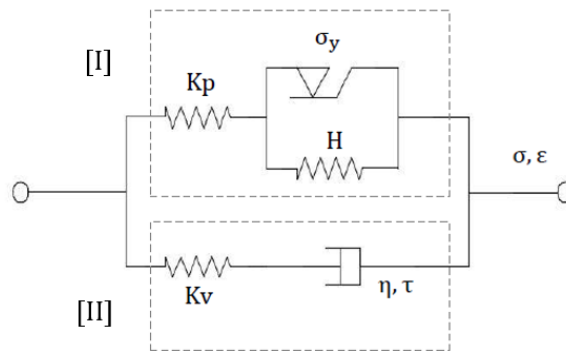

Figure 1 **one-dimensional illustration of the rheological model: 2-layers viscoplasticity implemented in Abaqus [1]**

[I]: gives an elasto-plastic response. To this network, are associated the state variables (tensors) σ_I and ϵ , representing the stress and strain tensors respectively. \mathbf{Kp} is the stiffness tensor associated to the elastic contribution in this network (spring) and σ_y is the yield stress of the plastic mechanism.

[II]: is a Maxwell-type visco-elastic network. We associate to it, the state variables (tensors) σ_{II} and ϵ . \mathbf{Kv} is the corresponding stiffness tensor.

The total stress is divided between the two branches of the system, i.e.,

$$\sigma = \sigma_I + \sigma_{II} \quad (1.a)$$

$$\sigma = \mathbf{Kp} : (\epsilon - \epsilon_p) + \mathbf{Kv} : (\epsilon - \epsilon_v) = (1 - f) \mathbf{E} : (\epsilon - \epsilon_p) + f \mathbf{E} : (\epsilon - \epsilon_v) \quad (1.b)$$

such that,

$$f = \frac{Kv}{Kv + Kp} = \frac{Kv}{E}, \quad \epsilon_p \text{ and } \epsilon_v \text{ are respectively the plastic and viscous strain.}$$

We assume the plastic flow as,

$$\dot{\boldsymbol{\varepsilon}}_p = \frac{d\mathcal{F}(\boldsymbol{\sigma}, \alpha)}{d\boldsymbol{\sigma}} \quad (2)$$

\mathcal{F} is the yield function and α is an internal variable defining the hardening/softening process. The viscous deformation is defined through the internal variable $\dot{\boldsymbol{\varepsilon}}_v$ (viscous strain rate):

$$\dot{\boldsymbol{\varepsilon}}_v = \frac{\boldsymbol{\sigma}_v}{\eta} \quad (3)$$

where η is the viscosity.

3 Numerical integration scheme

We considered in our parametric study, different scenarios such as strain as input or stress which allows to model for the first a relaxation phenomenon and for the second a creep. Also, different parameters were evaluated in order to see their influence. Here, we will only present the scheme of the creep phenomenon.

Two time-steps are defined. The first is a loading step (step1), where the stress increase linearly from zero to S_{max} . Followed by a load-holding step (step 2). (Figure 2-a).

The numerical integration scheme is an incremental step. More details can be found in [6]. Subscript n indicates the particular value of a quantity at the beginning of the increment.

<p>For the elastoplastic branch (rate independent plasticity)</p> $\sigma_{n+1}^{trial} = (1 - f) E (\varepsilon_{n+1} - \varepsilon_n^p)$ $\varepsilon_{n+1}^{p, trial} = \varepsilon_n^p; \alpha_{n+1}^{trial} = \alpha_n;$ $f_{n+1}^{trial} = \sigma_{n+1}^{trial} - [\sigma_y + K \alpha_n]$ <p>If $f_{n+1}^{trial} \leq 0$, then</p> $\varepsilon_{n+1}^p = \varepsilon_n^p; \alpha_{n+1} = \alpha_n; \sigma_{n+1} = \sigma_{n+1}^{trial}$ <p>If $f_{n+1}^{trial} > 0$</p> $\Delta\gamma = \frac{f_{n+1}^{trial}}{(1-f)E+k}$ $\sigma_{n+1} = \sigma_{n+1}^{trial} - \Delta\gamma (1-f)E \text{ sign}(\sigma_{n+1}^{trial})$ $\varepsilon_{n+1}^p = \varepsilon_n^p + \Delta\gamma (1-f)E \text{ sign}(\sigma_{n+1}^{trial})$ $\alpha_{n+1} = \alpha_n + \Delta\gamma.$	}	(4)	<p>For the Maxwell branch (rate dependent elasticity)</p> $\varepsilon_{n+1}^v = \left(1 - e^{\left(\frac{-\Delta t}{\tau}\right)}\right) \varepsilon_{n+1} + e^{\left(\frac{-\Delta t}{\tau}\right)} \varepsilon_n^v$ $\sigma_{n+1}^v = f E (\varepsilon_{n+1} - \varepsilon_{n+1}^v)$ $ct = ct + f E e^{\left(\frac{-\Delta t}{\tau}\right)}$ $\Delta = \frac{\sigma_{app} - \sigma}{ct}$ $\varepsilon_{n+1} = \varepsilon_{n+1} + \Delta$	}	(5)
---	---	-----	---	---	-----

4 Parametric study

For the set of values presented in table 1 we obtained the results shown in Figure 2 and Figure 3. Results confirm that the sum of stresses of both branches will be equal to total applied stress. (Figure 2-a, Figure 2-b, Figure 2-c). Then, the most relevant result is the curve in Figure 3. We can see that the model captures all three stages of creep: primary, secondary and tertiary.

Table 1 set of values used for the numerical integration

Young Modulus, E [MPa]	Yield stress, σ_y [MPa]	Softening modulus, K	S max [MPa]	Characteristic time, τ [T]	f	Step 1 [T]	Step 2 [T]
1000	8.5	-125	9	2000	0.2	1	5000

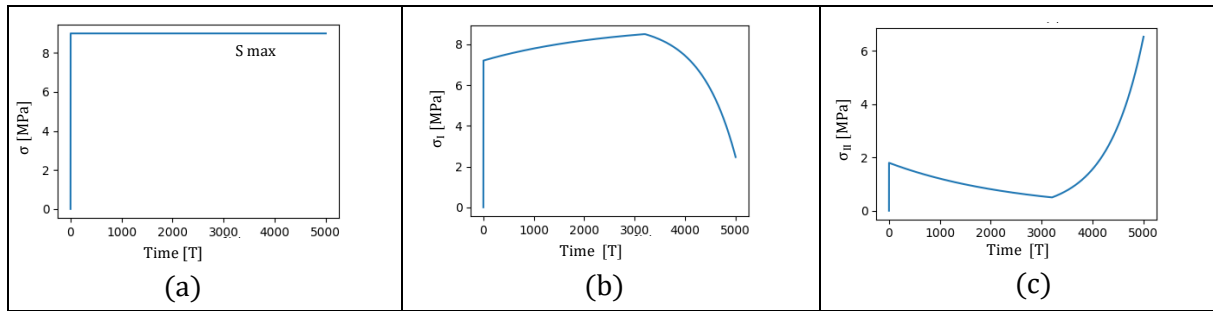

Figure 2 1D numerical integration of the two-layers viscoplasticity: a-total stress. b-stress in branch 1. c-stress in branch 2.

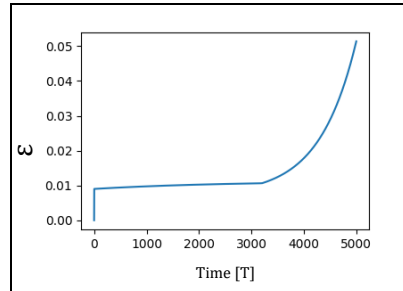

Figure 3 the total deformation: Creep (primary, secondary and tertiary)

5 Validation

In order to validate our 1D model with the 3D model of Abaqus, we studied the behavior of a beam pulled on one surface and with boundary conditions such that it undergoes uni-axial deformation with a uniform stress state (Figure 4-a). The evolution of the total deformation with respect to time (Figure 4-b) confirm the result found previously.

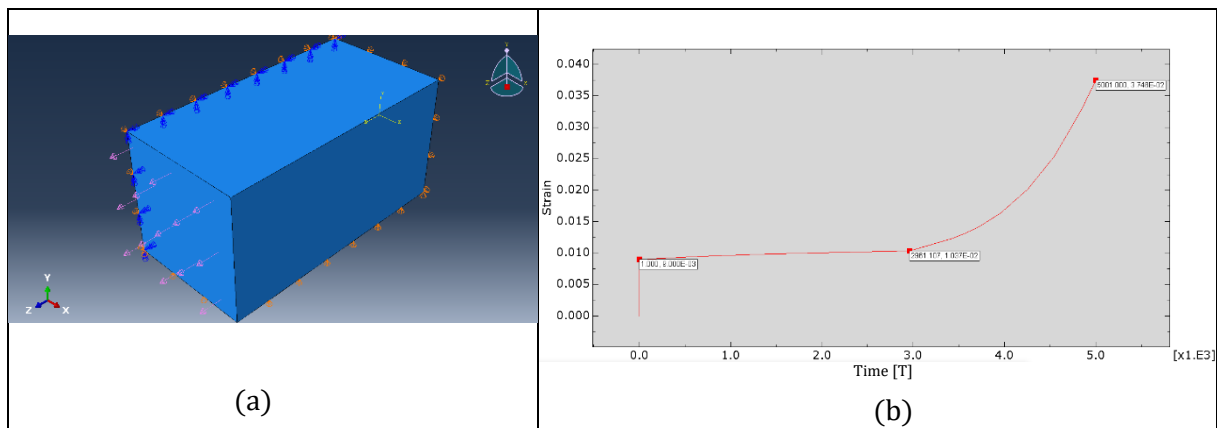

Figure 4 a-beam analysis using the two-layers viscoplasticity model implemented in Abaqus. b-Total deformation with respect to time for an arbitrary point of the beam

6 Modelling ancient textiles: tapestries

Let the tapestry shown in Figure 5 with dimensions ($W \times L$) equals to 2×3 m, and it is 5 mm thick. It has a surface density of 15 kg/m^2 . It is simulated as a shell structure with a rectangular meshing of 1×1 cm in size. The boundary conditions defined on the upper edge simulate a hanging with a Velcro system, widely used nowadays. It is subject only to the action of gravity. Orthotropic material properties were assigned through Lamina (laminated material) for the elastic element. For the plastic element, Hill criteria was used and the plastic flows follows a liner softening response. The viscous part of the material was defined through Norton-hoff power law. And the viscosity was considered isotropic.

Figure 5 shows the equivalent plastic deformation (PEEQ) at two different times. This deformation profile is a result of the orthotropic properties. The evolution of total strain with respect to time is given in Figure 6.

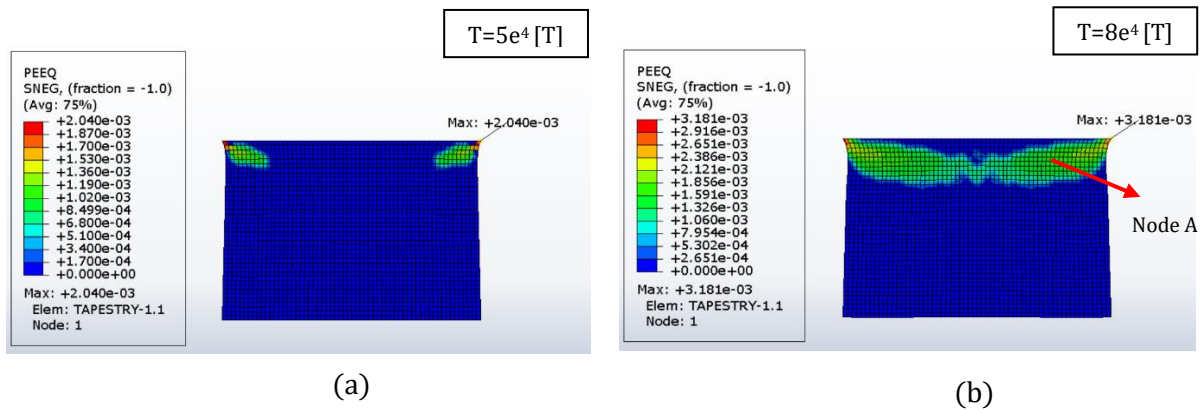

Figure 5 Simulation of hunged tapestry under its own weight: Equivalent plastic deformation at two different time $t=5e4 [T]$ and $t=8 e4 [T]$

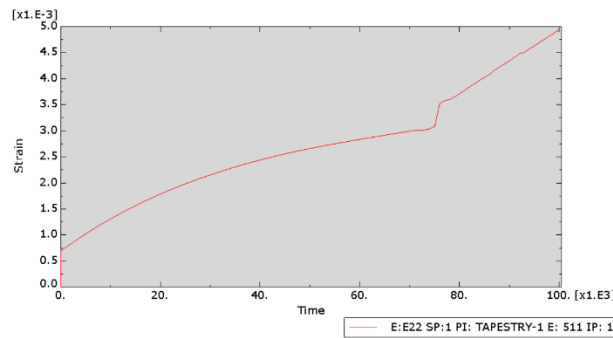

Figure 6 plot of the total deformation with respect to time for the node A

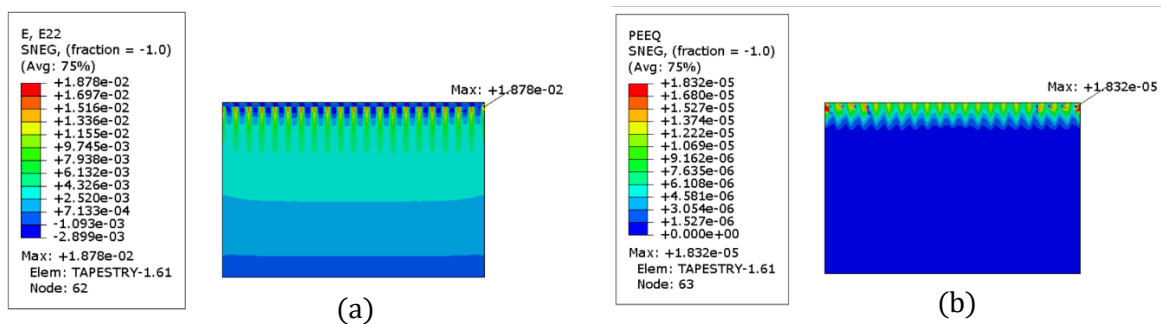

Figure 7 tapestry hunged using with pins at 15 cm from each other

In Figure 7, the hanging is provided using nails 10 cm apart near the top edge. We can clearly see the inefficiency of this system. We observe a concentration of stresses around the hanging points. In the last case presented, Figure 8, we see the effect of the presence of tears or open slits, which is common for tapestries. It shows high degree of deformation around the horizontal slits. While, the vertical slit has no considerable effect.

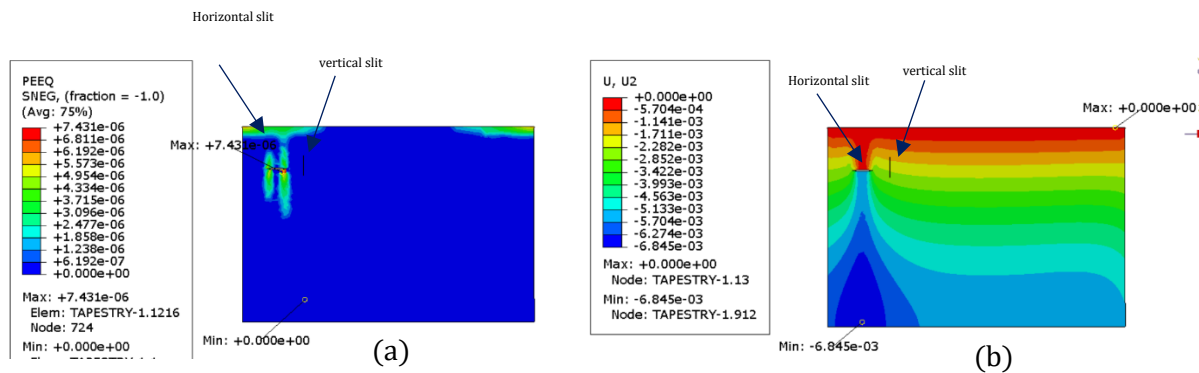

Figure 8 presence of two open slits in the tapestry

7 Conclusion

The two-layers viscoplasticity material model was explored through 1D numerical scheme developed using the open source code Python. A parametric study was made to see the sensitivity of the model to the parameters it involves. One set of these parameters was selected and presented in this article; it permits to highlight the creep phenomenon namely the tertiary creep that takes place latter on in time and is related to the plastic element being activated. This study was made in the framework of a thesis on the mechanical behavior of tapestries by mean of mechanical and numerical modelling. some results of tapestries simulations with the two-layers model were presented showing the profile of deformation of a hanged tapestry and its evolution with time. This aspect regarding delayed in time behavior of tapestries is very important. In museum, tapestries display follows a circulation in order to make it possible to display different pieces during the year. This means hanging time could be optimized, to limit the degradation. Other aspects were simulated such as hanging with nails and presence of slits.

References

- [1] Kichenin, J. et al.: Finite-element simulation of a new two-dissipative mechanisms model for bulk medium-density polyethylene. *J. Mater. Sci.*, **31** (6), 1996, p. 1653–1661.
- [2] ABAQUS 6.14 Documentation, D.S., Simulia Corporation: *Two-layer viscoplasticity*. no date.
- [3] Zhang, W. et al.: An effective inverse procedure for identifying viscoplastic material properties of polymer Nafion. *Comput. Mater. Sci.*, **95**, 2014, p. 159–165.
- [4] Berezvai, S., Kossa, A.: Characterization of a thermoplastic foam material with the two-layer viscoplastic model. *Mater. Today Proc.*, **4** (5), 2017, p. 5749–5754.
- [5] Figiel, L., Gunther, B.: Modelling the high-temperature longitudinal fatigue behaviour of metal matrix composites (SiC/Ti-6242): Nonlinear time-dependent matrix behaviour. *Int. J. Fatigue*, **30** (2), 2008, p. 268–276.
- [6] Simo, J.C., Hughes, T.J.R.: *Computational Inelasticity*. New York: Springer-Verlag, 1998.