



HAL
open science

3D digital image correlation analysis of medium velocity soft impacts on laminated composite

Olivier Dorival, Pablo Navarro, Steven Marguet, Jean-François Ferrero

► To cite this version:

Olivier Dorival, Pablo Navarro, Steven Marguet, Jean-François Ferrero. 3D digital image correlation analysis of medium velocity soft impacts on laminated composite. *Forces in Mechanics*, inPress, pp.100245. 10.1016/j.finmec.2023.100245 . hal-04276627

HAL Id: hal-04276627

<https://hal.science/hal-04276627>

Submitted on 9 Nov 2023

HAL is a multi-disciplinary open access archive for the deposit and dissemination of scientific research documents, whether they are published or not. The documents may come from teaching and research institutions in France or abroad, or from public or private research centers.

L'archive ouverte pluridisciplinaire **HAL**, est destinée au dépôt et à la diffusion de documents scientifiques de niveau recherche, publiés ou non, émanant des établissements d'enseignement et de recherche français ou étrangers, des laboratoires publics ou privés.



Distributed under a Creative Commons Attribution - NonCommercial 4.0 International License

1 3D digital image correlation analysis of medium velocity
2 soft impacts on laminated composite

3 O. Dorival^{a, b}, P. Navarro^a, S. Marguet^a, J.-F. Ferrero^a

4 ^a*Université de Toulouse, Institut Clément Ader, UMR CNRS 5312, INSA/ISAE/Mines*
5 *Albi/UPS, 3 Rue Caroline Aigle, 31400, Toulouse, France*

6 ^b*Icam School of Engineering, Toulouse campus, 75 avenue de Grande Bretagne, 31300,*
7 *Toulouse, France*

8 **Abstract**

9 In aerospace academic and industrial world, soft impacts are commonly
10 used to replace bird strike tests for the validation of materials and structures
11 as well as the calibration of numerical models. However in general, the anal-
12 ysis reported show only a few part of the experimental information available.
13 In this paper, three laminate composites made of epoxy resin reinforced by
14 glass or carbon fibres are tested under gelatin impact at several velocities
15 up to complete failure. A detailed analysis based on 3D Digital Image Cor-
16 relation (3D DIC) and visual inspection of the three laminates is provided
17 for a total of 21 tests with impact velocities in the range 60-112 m/s. DIC
18 extraction provides accurate quantitative displacement fields of the rear face
19 in both time and space. Moreover, specific failure scenarios are identified for
20 each laminate. The results obtained provide a suitable database for the de-
21 velopment of numerical models. In addition, all experimental data from DIC
22 extractions are opened to the readers on the *Recherche Data Gouv* website
23 for comparisons with their own tests or numerical models.

24 *Keywords:* bird strike, gelatin, laminated composites, digital image

25 correlation, damage of composites, gas gun test, experimental transient
26 dynamics, carbon/epoxy, glass/epoxy

27 **1. Introduction**

28 As a major threat in the aeronautical area, impact loading has received
29 close attention over the past decades. Not only for aircrafts but also for
30 helicopters, impact events such as bird strikes, impact with hailstones, metal
31 debris, tyre debris, drone, etc. are likely to damage vital parts of aircrafts
32 and helicopters such as fuel tanks [1], windshields [2, 3, 4], wings [5, 6, 7, 8],
33 engine blades [9, 10], rotor blades, rotor parts, or flying instrument such
34 as Pitot tube. At the design stage, this requires to evaluate the resistance
35 of structures to such severe loadings whenever the material is modified. In
36 particular, increasing use of laminate or sandwich composites in structural
37 parts [11, 12, 13], favored by their high stiffness to weight ratio, is still given
38 a special focus due to the competition between several failure mechanisms
39 [14, 15] and large number of design parameters.

40 This study focuses on bird strikes for which number of catastrophic events
41 have been reported in the past decades, as reviewed for instance in [16, 17].
42 Early experiments were performed by Barber [18], in which small birds (60
43 gr. to 125 gr.) were shot perpendicularly to a rigid target. The pressure time
44 histories recorded were composed of a low frequency signal starting with a
45 peak pressure followed by a steady state flow, plus a high frequency signal
46 attributed to bird heterogeneity. In [19] the study was completed with a
47 limited number of impacts with larger birds (0.9 to 3.6 kg) but no steady state
48 phase was found in this case. Effects of oblique impact and target compliance

49 were also briefly investigated. A hydrodynamic model was developed by
50 Wilbeck [20] that allows to calculate the peak pressure (Hugoniot pressure),
51 the steady-state pressure (stagnation pressure) and the impact duration. The
52 model was compared with real birds and substitute bird material and some
53 differences were reported, in particular for real birds due to large scatter. It
54 is worth noting that despite the inevitable simplifications of Wilbeck's 1D
55 model (already mentioned by Wilbeck himself), the equations still serve as
56 a reference for quick but yet reasonably precise evaluation of the Hugoniot
57 and stagnation pressure onto the target. However, this theory was developed
58 for rigid targets only. It cannot capture the time-space repartition of the
59 pressure, nor effects such as of waves reflection, target compliance, target
60 shape, projectile shape, etc. For instance, large differences in the shock
61 pressure between Willbeck's theory and experiments were reported in [21].

62 Since then, several numerical methods to solve the dynamic fluid-structure
63 interaction problem have emerged with the ambition to provide designers
64 with a much more detailed model. A precise representation of the physics
65 involved could tackle the problem up to the prediction of damage in the struc-
66 ture. As reviewed in [22], a huge number of papers have been devoted to the
67 development of numerical methods. The most promising strategies are based
68 on Smooth Particle Hydrodynamics (SPH) methods or Arbitrary Eulerian
69 Lagrangian (ALE) approaches. The validation of these numerical approaches
70 is usually made by comparisons with Wilbeck's theory (despite simplified)
71 or confronted to experimental results that generally use substitute birds like
72 gelatin projectiles for instance. The question of the validity of replacing real
73 birds by substitute materials is still discussed. In [23] for instance, very few

74 impacts with 1.8 kg birds showed differences between gelatin and real birds.
75 Consistent with this, Lavoie [24] measured a drop in the velocity of the pro-
76 jectile end during the past half of the impact while Wilbeck's theory assumes
77 constant velocity during the flow to calculate the impact time. Nevertheless,
78 in the academic world as well as in aircraft industry, gelatin impact tests are
79 commonly used for testing structures under soft impact sollicitation.

80 Such soft impact experiments are challenging to perform, and most of the
81 time, a very limited experimental information is extracted from the tests,
82 which limits the validation of numerical models. This is also questionable
83 because one ambition of numerical models is to help the design process with
84 a very detailed local space-time information, what would need to validate the
85 models with this scale of representation. In [25], the failure modes caused by
86 bird strike to metallic or composite plates and half-rings were the only data
87 studied. Most of the time, the time history of deflections or strains taken at
88 the center or at a few points in the sample were compared to the numerical
89 results [2, 26, 27, 28, 29]. In [30], Fiber Bragg Grating (FBG) sensors were
90 used to record the strain on the back face of a small representative segment of
91 front fairing of an helicopter. The structure tested to soft impact was a curved
92 rectangular sandwich structure made of a 20 mm thick closed-cell polymeric
93 foam core with relative high stiffness and strength and low density, and two
94 2.88 mm thick quasi-isotropic carbon fibre reinforced plastic (CFRP). In [31],
95 impact absorption of two reinforced composite sandwich panels were tested
96 against bird strike with the main information - apart the impact velocity
97 - being the internal damage inspection by pulse thermography and X-ray
98 CT. The sandwiches consisted in two facesheets made of 1 mm thick woven

99 carbon fibre prepreg, and a low density polyurethane foam core reinforced
100 with either a corrugated carbon composite sheet, or orthotropic carbon fibre
101 twill prepreg tubes.

102 The resulting force and the momentum imparted onto the structure can
103 also be compared [32]. In particular, one question in the field is the amount
104 of momentum transferred to the structure in the case of normal or oblique
105 impacts. In [33], the momentum transfer on three rigid targets (a plate, a
106 wedge and a splitter) was studied experimentally and numerically in order to
107 quantify the forces originating from the change of momentum and splitting
108 of the bird. A precise measurement of the pressure field is still beyond ca-
109 pabilities. Direct point pressure measurements with carbon gages have been
110 reported to lead to unacceptable values in [24]. It could be due to impedance
111 effects between the projectile and the target as explained in [34], who pro-
112 posed to use a simple force sensor to derive the average pressure (but not the
113 pressure field) during the shock. It was shown that it is necessary to account
114 for the acoustic impedance of the sensor in order to achieve reliable values
115 of the dynamic pressure.

116 The radial expansion of the projectile, that can be compared with Wilbeck's
117 model or numerical models, is also easily extractable from impact tests up
118 to a given precision. This is a very interesting information since it strongly
119 depends on the material behavior in large deformation and at high strain
120 rate. While [30] found good agreements with SPH simulations, results of [35]
121 indicate that "models predict less accurately the radial expansion, especially
122 at lower impact velocities", pointing out the need of improvement in the
123 material model for the substitute bird.

124 In the recent years, the development of digital image correlation (DIC)
125 has provided a very efficient tool for the analysis of specimen deflection as it
126 gives a field information over the visible area of the sample along the time
127 evolution. Although it was already mentioned in [36] as one of the promising
128 techniques to study strain rate effects in highly dynamic problems, to the
129 authors knowledge it has not been widely used for birds strike tests. The main
130 technical difficulty is to record with high frequency devices, and in particular
131 to synchronize the different cameras with each other. The scope of this paper
132 is to present this experimental technique as the best candidate to validate
133 numerical models since the experimental information is very rich. Use of DIC
134 for various type of impulsive loadings has been briefly reviewed in [37]. To
135 study severe dynamic loadings, high-speed digital image correlation has been
136 used, for instance for low velocity impacts [38], air blast [39, 40], dynamic
137 Brazilian test [37]. High-speed stereo-digital image correlation is capable to
138 provide the time history of 3D displacement field of the sample face and, by
139 differentiation, the in-plane strains. For bird impacts, it should be applied on
140 the back face of the sample because the face impacted is blurred by the gelatin
141 flowing on the target. However, despite the very rich information available
142 from DIC, the comparison between experiments and numerical models have
143 so far been limited to a very partial information. In [41], only the central
144 deflection (both dynamic and residual) was extracted from DIC and, together
145 with forces on the test rig, compared with SPH simulations with the idea to
146 validate a bird substitute material model for the helicopter flight domain. In
147 [3, 4], 3D DIC was used on a small part of a laminated windshield and a
148 similar trend was found between SPH simulations and experimental results.

149 Quantitative comparisons were mainly given at a few points: the central out-
150 of-plane displacement and center or off-center major principal stain. Note
151 that the deflection profile along an horizontal line was also plotted, and can
152 be considered as a premise of a field validation of the simulations. A similar
153 approach was used in [42].

154 The objective of this paper is to analyze gelatin impact tests performed
155 on three laminated composites based on 3D DIC data. Tests with various
156 impact velocities were performed on each type of material up to failure. The
157 materials tested and the experimental set up are described in Section 2. One
158 aim of this paper is also to provide some DIC data available as an open
159 material for potential validation of numerical methods. To this aim, results
160 of experimental natural modes and frequencies obtained by free-free tap tests
161 are also given in Section 2 to allow stiffness and mass calibration. The results
162 of impacts tests are given in Section 3 based on the analysis of DIC data,
163 strain gages and visual inspection. All experimental data from DIC analysis
164 are open to the readers on the *Recherche Data Gouv* website at the following
165 URL [43]: <https://doi.org/10.57745/UA1CRZ>. Conclusions are then given in
166 Section 4.

167 **2. Materials and experimental set-up**

168 *2.1. Specimen description*

169 Three laminated composites (10 specimens each) were provided by Multi-
170 plast company in the framework of the projet named SUCCESS. The stacking
171 sequences are detailed in Tab. 1. Laminate 1 is composed of 16 plies of plain
172 weave fabrics prepreg made of epoxy resin reinforced by glass fibres. The

173 nominal areal mass is $600\text{g}/\text{m}^2$ for the 14 inner plies, and $300\text{g}/\text{m}^2$ for the
174 upper and lower ones. Laminate 2 is composed of 20 prepreg plies of epoxy
175 resin reinforced with equivalent T700 unidirectional (UD) with a nominal
176 areal mass of $300\text{g}/\text{m}^2$ for each ply. Laminate 3 is composed of 20 prepreg
177 plies of UD or plain weave fabrics made of epoxy resin reinforced with equiv-
178 alent T700 carbon fibres with a nominal areal mass of $300\text{g}/\text{m}^2$. Stackings
179 were compressed at 0.8 bar minimum each 1 or 2 plies during 10 minutes. The
180 curing conditions for laminate 1 use a temperature ramp rate of $0.3^\circ\text{C}/\text{min}$,
181 followed by a first plateau at 80°C during 1 hour and a second plateau at
182 92.5°C during 6 hours. For laminates 2 and 3, the ramp rate is $0.5^\circ\text{C}/\text{min}$,
183 followed by a first plateau at 80°C during 3 hours and a second plateau at
184 100°C during 5 hours. After curing, composite plates were cut in $400\text{mm} \times$
185 400mm samples. The masses and thicknesses measured are given in Tab. 2.

Designation	Stacking
Laminate 1	glass-epoxy plain weave fabrics $[(0-90)^f/(0-90)_{14}^f/(0-90)^f]$
Laminate 2	carbon-epoxy unidirectional $[45/-45/0/90/45/-45/0/90/45/0/90/-45/90/0/-45/45/90/0/-45/45]$
Laminate 3	carbon-epoxy unidirectional & plain weave fabrics $[(\pm 45)^f/(0)_3^{UD}/(\pm 45)^f/(0)_3^{UD}/(90)_2^{UD}]_{\text{sym}}$

Table 1: Specimen tested. UD and f denotes a unidirectional ply and fabric ply respectively.

186 In order to allow models calibration, the basic modal properties of the
187 samples have been tested by tap test in free-free boundary conditions. The

Designation	Areal mass [kg/m ²]	Thickness [mm]	
	(measured)	(nominal)	(measured)
Laminate 1	13.075 ±0.1875	8.5	7.29 ±0.83
Laminate 2	9.231 ±0.1875	5.5	6.16 ±0.23
Laminate 3	9.294 ±0.1875	5.5	6.43 ±0.13

Table 2: Sample properties measured.

188 sample plate was hanging on sandows to mimic free-free boundary conditions.
189 The experimental mesh was a 5×5 grid with 90mm between each point. The
190 accelerometer was fixed at corner (1, 1) and the hammer was moved at each
191 point of the grid. The tap tests were performed in the range [0-5000 Hz] with
192 a frequency resolution of 0.15 Hz (32768 lines). 10 measures per point and
193 Hanning windowing were used. The force and acceleration signals were then
194 treated by dBFA Suite software to obtain the Frequency Response Functions
195 (H1-estimator) and extract the modal properties with Star7 modal analysis
196 software. The natural frequencies, mode shapes and modal dampings are
197 given in Fig. 1, 2 and 3 for laminates 1, 2, 3 respectively. To help numerical
198 model construction, ply properties obtained in the framework of the project
199 SUCCESS [44] by calibration between the experimental natural frequencies
200 and the numerical ones are given in Tab. 3.

201 2.2. Experimental set-up

202 The soft impact tests were performed on the STIMPACT platform at
203 Institut Clément Ader, Toulouse, France. This apparatus is classically used
204 for reproducing impact events such as bird strikes or debris or hail impacts.
205 The gas gun impact set-up is shown in Fig. 4.

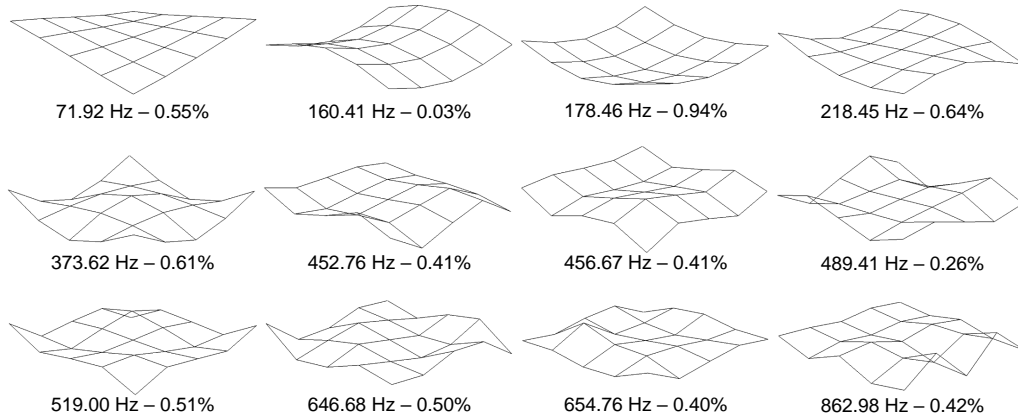

Figure 1: Experimental modal analysis on laminate 1: natural frequencies, modal shapes and modal dampings.

206 The gas gun used is composed of a pressurized air tank closed by a PET
 207 membrane. At a given pressure, the membrane breaks and a pressure wave is
 208 released in a 120mm diameter tube. A 750g gelatine projectile, stabilized in
 209 a sabot made of foam, is accelerated during its course in the tube. At the exit

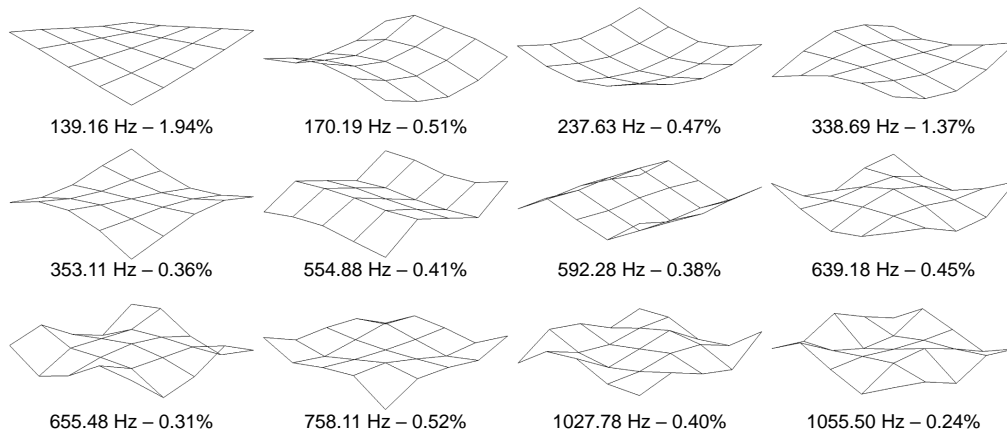

Figure 2: Experimental modal analysis on laminate 2: natural frequencies, modal shapes and modal dampings.

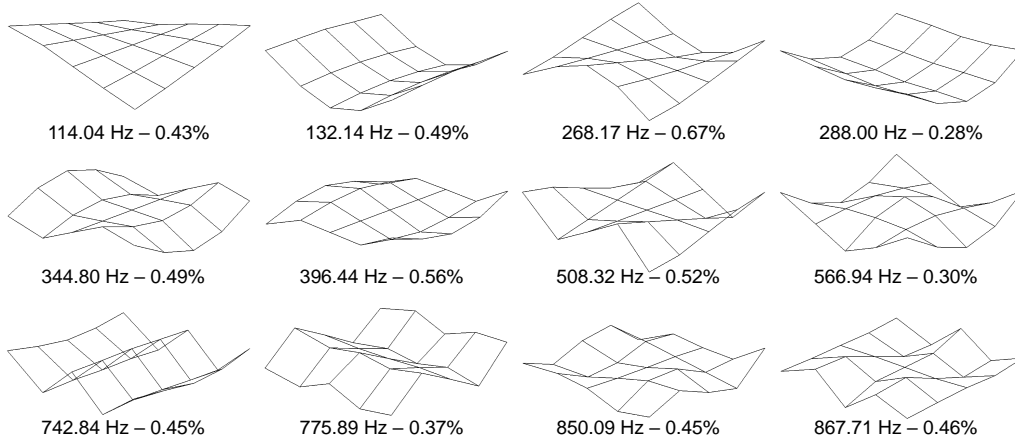

Figure 3: Experimental modal analysis on laminate 3: natural frequencies, modal shapes and modal dampings.

Glass-epoxy plain weave fabrics		
Longitudinal elastic modulus [GPa]	E_{11}	34.14
Transverse elastic modulus [GPa]	E_{22}	10.04
In-plane shear modulus [GPa]	G_{12}	3.032
Poisson's ratio	ν_{12}	0.297
Carbon-epoxy UD		
Longitudinal elastic modulus [GPa]	E_{11}	137.6
Transverse elastic modulus [GPa]	E_{22}	8.98
In-plane shear modulus [GPa]	G_{12}	3.66
Poisson's ratio	ν_{12}	0.281

Table 3: Ply properties used in [44].

210 of the tube, a deflector allows to deviate the foam sabot from the projectile,
 211 in order to ensure that only the gelatine impacts the composite structure.
 212 For a given projectile mass and pressure released, the length of acceleration

213 in the tube leads to a given impact velocity when the projectile reaches the
214 sample plate. The impact velocity has been adapted in order to provoke
215 gradual damage. The range of velocities (resp. trigger pressure) was 87-112
216 m/s (resp. 1.64-2.37 bar) for laminate 1, 64-105 m/s (resp. 0.93-2.19 bar)
217 for laminate 2, 60-90 m/s (resp. 0.82-1.71 bar) for laminate 3. Details of
218 velocities and pressure measured are given in Tab. 4-6.

219 The projectile shape consists of a 100 mm diameter cylinder terminated
220 by a spherical edge (for the impact side) and a flat edge (for the back side).
221 The head of the projectile was painted in order to help the localization of
222 the projectile on the camera pictures. Following [24], the projectile was
223 composed of 10% porcine gelatin mixed in hot water and cooled at least 8
224 hours at fridge temperature before testing. The projectile density used in
225 [44] was 950 kg/m^3 . Since gelatin properties are likely to vary due to drying,
226 impacts tests were performed maximum 24h after moulding.

227 The composite sample plate leaned on a 50mm thick aluminum support
228 plate. Clamped conditions, which are commonly used because of technical
229 simplicity, have been reported to create shear stresses near the clamping,
230 which could initiate damage in the structure [45, 46, 47]. Also, clamped
231 boundary conditions are less reliable for numerical models as the deformation
232 of the support frame is not accounted for. Since in real conditions, strains
233 due to bending deflection and not the pressure wave itself was suspected to be
234 the main reason for creating damage, simply supported boundary conditions
235 appeared more suitable to characterize damage for a given impact condition.
236 In order to favour it, the aluminum support plate was machined with a
237 350mm diameter hole in its center and then chamfered to obtain a 360mm

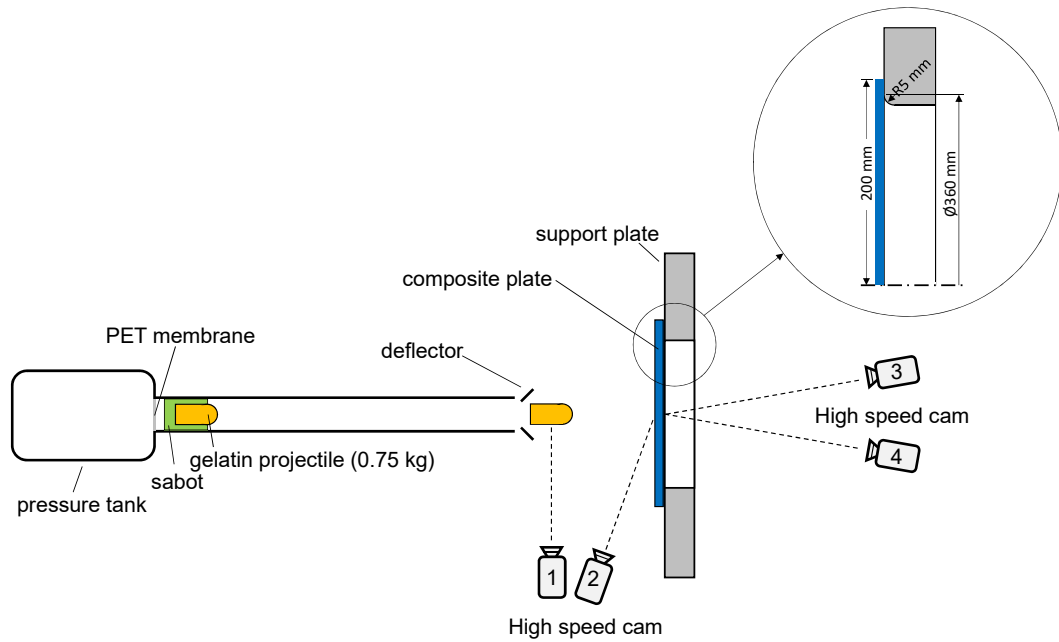

Figure 4: Gas gun setup used for gelatin impact tests with 3D DIC devices (STIMPACT platform).

238 cylindrical simply supported boundary condition during the impact. The
 239 complete set-up is shown in Fig. 5. Small parts and shelf brackets that fixed
 240 the support plate allowed to adjust the position in order for the composite
 241 plate center to coincide with the impact center.

242 The instrumentation mainly consisted of four fast cameras (SA5 model
 243 1300K-M3) : two ahead of the plate, and two behind the support plate, see
 244 Fig. 4:

- 245 • camera 1 recorded the projectile at the exit of the tube. It was used to
 246 measure the initial speed of the projectile and to check the deflection
 247 of the sabot;

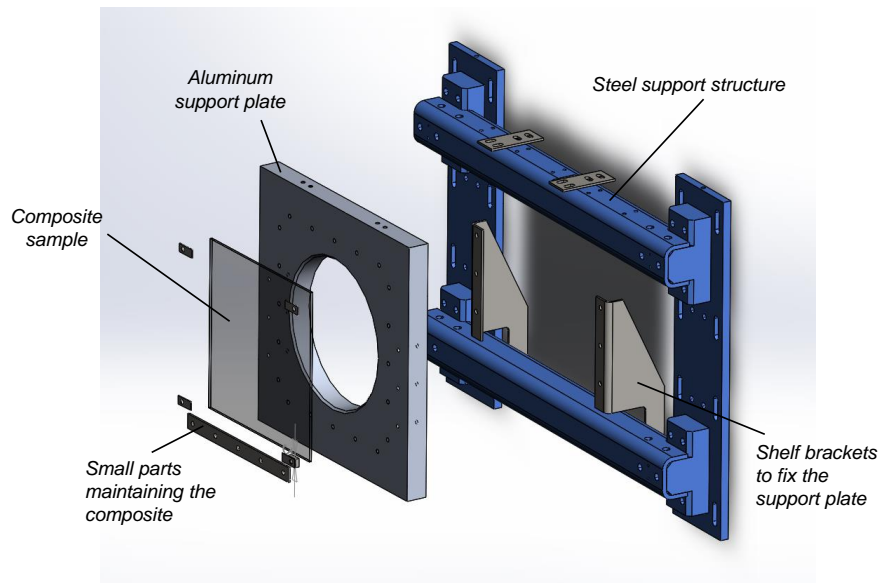

Figure 5: Composite specimen with simply supported set-up.

- 248 ● camera 2 recorded the impact of the projectile on the sample. It was
249 used to check that the impact is located at the center of the plate;
- 250 ● cameras 3 and 4 recorded the deflection of the composite plate on the
251 back face. The aim was to use 3D DIC to obtain the displacement field
252 of the plate.

253 In order to perform 3D digital image correlation analysis, a speckle was
254 painted on the back face of the sample plate as shown in Fig. 6 (left).
255 The support plate was also speckled in order to get a fixed reference. The
256 speckle was composed of random dark spot adapted in order to improve
257 the resolution of DIC analysis with respect to the image size. The order of
258 magnitude was 3-5 pixels per dark spot. $704 \times 512 \text{ pixels}^2$ was the maximum
259 image size available on the cameras at the 20000 img/sec sampling frequency

277 frequencies were filtered by DIC subset averaging process. After several trial
 278 tests, 3D DIC analysis was found to provide reliable data with respect to the
 279 strain gauges. For these reasons, strain gauges were abandoned for the next
 280 tests and 3D DIC was considered the main source of experimental data.

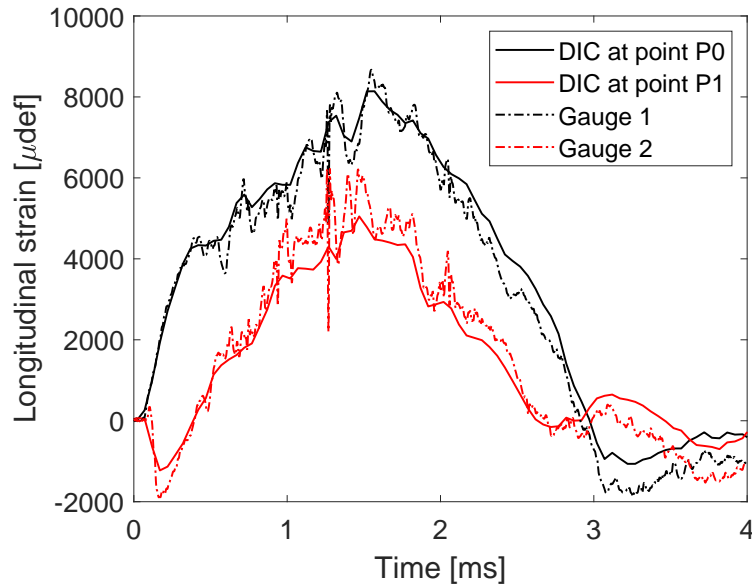

Figure 7: Validation of 3D DIC by strain gauges results. Laminate 3 impacted at 68 m/s. Points P0 and P1 are shown in Fig. 6.

281 3. Results and discussion

282 3.1. Example: laminate 1 impacted at 92 m/s

283 Fig. 8 provides an example of impact recorded by the impact camera on
 284 laminate 1 at 92 m/s . Immediately after the impact, the gelatin projectile
 285 flows radially from the plate center. At time $t \simeq 1700 \mu\text{s}$ the whole length

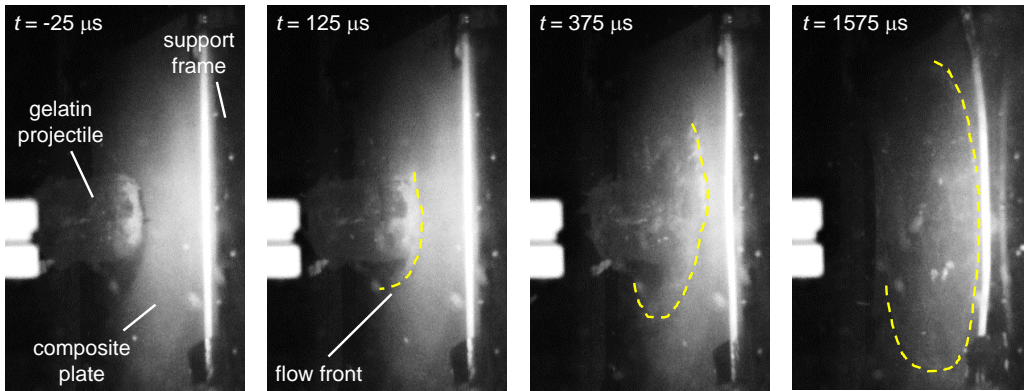

Figure 8: Impact recorded for laminate 1 impacted at 92 m/s.

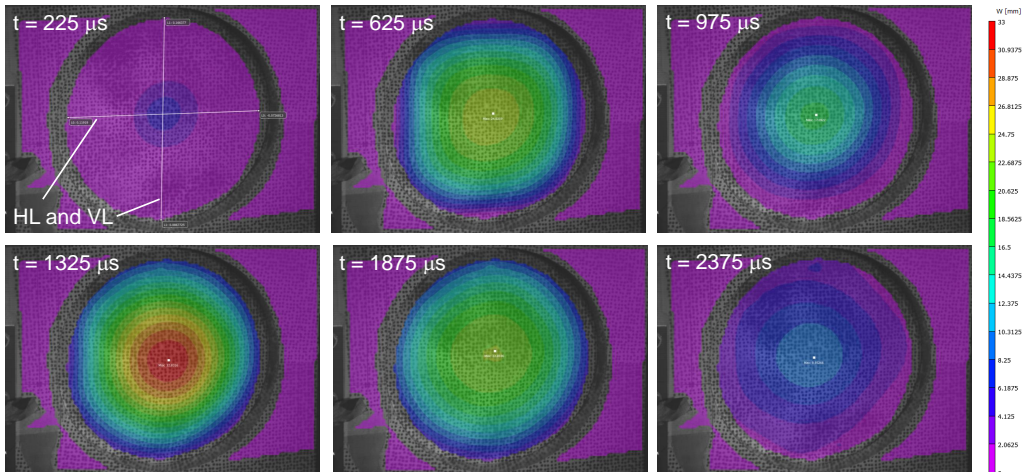

Figure 9: DIC extraction at various time steps for laminate 1 impacted at 92 m/s.

286 has flowed and the projectile has a “pancake” shape. As discussed later, this
 287 time is slightly longer than the time obtained theoretically by dividing the
 288 projectile length by the impact velocity. During most of the experiments, the
 289 projectile regained its initial shape after impact due to elastic return, or was
 290 eventually found destroyed into a few gelatin parts for the highest impact
 291 velocities.

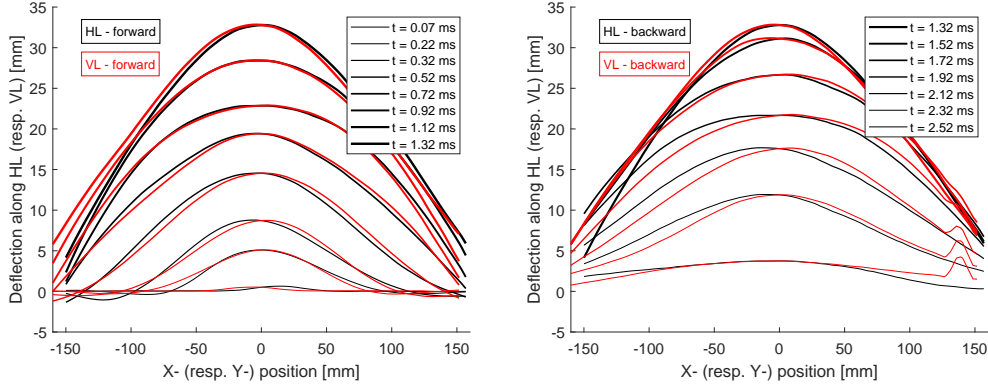

Figure 10: Deflection along horizontal line HL (black) and vertical line VL (red) at various time during the forward (left) and backward (right) motion for laminate 1 impacted at 92 m/s.

292 The corresponding 3D DIC extraction shown in Fig. 9 illustrates the
 293 progressive deflection of the sample plate. In the DIC extraction, time $t = 0$
 294 was defined as the last picture for which the out-of-plane deflection remained
 295 below a threshold of 0.1 mm, roughly corresponding to the noise before im-
 296 pact. As the gelatin reaches the structure, only the center of the plate deflects
 297 during the first microseconds. The deflection then increases and quickly prop-
 298 agates towards the edges. Maximum deflection takes place at around 1300
 299 μs . After that, elasticity causes the plate to deform backwards to zero, then
 300 back and forth into negative and positive directions during number of oscil-
 301 lations. The duration of 1300 μs to reach the maximum deflection roughly
 302 corresponds to a quarter of the natural period of the first bending mode with
 303 the simply supported conditions imposed by the set-up.

304 Fig. 10 shows the out-of-plane displacement at various time steps along
 305 the central horizontal line (HL) and vertical line (VL) during the forward and

306 backward motion. Lines HL and VL are depicted in Fig. 9. For laminate
 307 1, the stiffnesses in the 90° and 0° directions are equal, what can be checked
 308 experimentally by comparing the shapes between the deflections along HL
 309 and VL in Fig. 10. The strange deflection measured along VL during the
 310 backward motion at $Y \simeq 140\text{mm}$ is due to a debris crossing the pictures and
 311 blurring the DIC process.

312 3.2. Results for laminate 1 at various velocities

313 The theoretical impact duration was obtained by Wilbeck [20] by assum-
 314 ing that the target is rigid and firmly fixed and that the gelatin flows at its
 315 initial velocity during the impact:

$$t_{\text{impact}} = \frac{L_{\text{gel}}}{v_0} \quad (1)$$

316 where L_{gel} is the projectile length and v_0 the impact velocity.

317 During the tests, a slightly longer time was measured. To account for
 318 the deformation of the plate, the impact duration given by Wilbeck can be
 319 modified to account for the additional distance as follows:

$$t_{\text{modified}} = \frac{L_{\text{gel}} + w_{\text{end}}}{v_0} \quad (2)$$

320 where w_{end} is the deflection measured at the end of flow calculated by Eq. 1.
 321 Estimation of time durations for laminate 1 are given in Tab. 4. Note that
 322 experimental evaluation of the impact duration remains rather rough due to
 323 the transparency of the gelatin projectile and the visual interpretation of the
 324 end of the flow. One must note that both Eq. 1 and Eq. 2 assume that
 325 the projectile is impacting the target with its undeformed length L_{gel} and
 326 without any change in velocity, what is questionable as already noticed in

327 [24]. However, a precise measure of the projectile length at time of impact
 328 was not possible with the current set-up. Without surprise, the modification
 329 proposed in Eq. 2 to account for the target deformation is greatly improving
 330 the evaluation of the impact duration.

Velocity (m/s)	Pressure (bar)	Exp. duration (ms)	Eq. 1 (ms)	Diff. w. exp. %	Eq. 2 (ms)	Diff. w. exp. %
87	1.64	1.55	1.29	-17%	1.69	+9%
92	1.76	1.70	1.22	-28%	1.56	-8%
96	1.91	1.70	1.17	-31%	1.47	-14%
99 (*)	1.98	1.40	1.13	-19%	1.49	+6%
106 (*)	2.20	1.30	1.06	-19%	1.38	+6%
112 (*)	2.37	1.35	1.00	-26%	1.30	-4%

Table 4: Impact duration for laminate 1. (*) indicates tests with large crack noticed.

331 Fig. 11 shows the time history of center deflection obtained for various
 332 impact velocities in the range 87-112 m/s. Dashed lines are used to indi-
 333 cate samples that experienced large failure (at least one large macro-crack
 334 of several centimeters) during the impact, as noticed during post-mortem in-
 335 spections. For the test at 99 m/s, one strain gauge detached from the sample
 336 at 1.07 ms due to the shock wave. This did not allow a precise DIC analysis
 337 beyond this time. However, shifting the central point by 10 mm from the
 338 center to the right gave a very similar curve before 1.07 ms, and allowed the
 339 central deflection to be measured beyond detachment of the gauge.

340 The time to reach maximum deflection is similar for all specimens. The
 341 time for returning to zero is also similar, except for 112 m/s. This indicates
 342 that, unlike for 112 m/s, the failure mechanisms caused in the case of 99 m/s
 343 and 106 m/s did not modify significantly the first natural frequency that

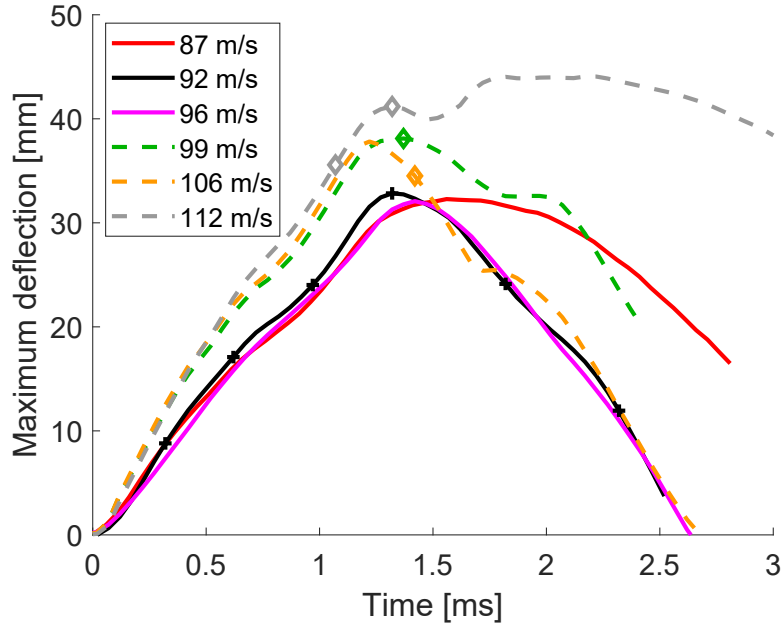

Figure 11: Time history of deflections for laminate 1 impacted at various velocities. Dashed lines show tests in which samples experienced large macro-cracks. “+”-ticks denote time steps of contour plots given in Fig. 9. Diamonds denotes crack visible in fast camera picture.

344 mainly governs the response of the structure. This is in agreement with the
 345 results of quasi-static bending tests by [48] who showed that laminate 1 has
 346 a very progressive failure propagation and a very progressive stiffness loss.
 347 This is attributed to a good resistance to delamination and, as a consequence,
 348 an improved redistribution of stresses in the plies adjacent to a cracked one.

349 Fig. 12 shows post-mortem photos of the samples that failed. In the
 350 case when delamination was noticed, the edges are also shown. Samples
 351 impacted below 99 m/s did not fail. At 99 m/s (see the back base) and 106
 352 m/s (see the impact face) , the samples experienced a major vertical crack -

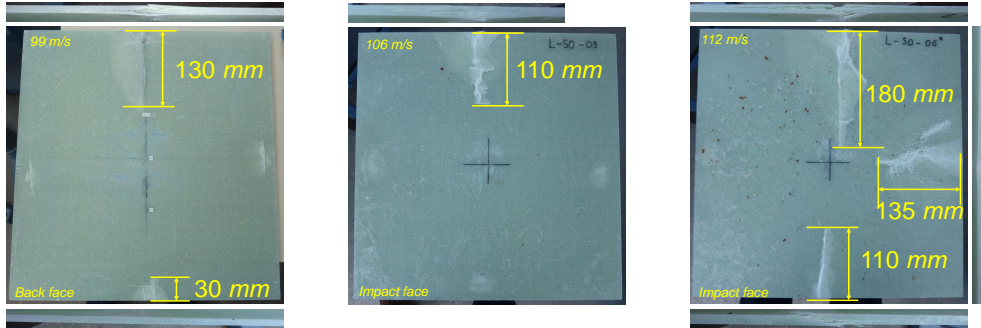

Figure 12: Post-mortem observation of damage on laminate 1 samples: (left) 99 m/s , (middle) 106 m/s , (right) 112 m/s . The side pictures show the edges delamination.

353 longer than 110 mm - starting from the top middle edge towards the center.
 354 In both case, the crack runs through the entire thickness and is visible on
 355 the two faces of the sample. Close to the crack, a large white area can be
 356 attributed to resin damage. The crack was initiated by the bending of the
 357 plate, allowed by the simply supported boundary conditions. The bending
 358 resulted in maximum stresses located in the middle of the plate edges (not
 359 visible in Fig. 9 as it is hidden by the support plate). Those damages were
 360 created by the main bending of the square sample (i.e. mode 1) that led the
 361 middle edge zones to experience tension on the back face and compression
 362 on the impact face beyond the material yield limit. A second shorter crack
 363 is found for 99 m/s . Although it is less energetic than 106 m/s , the larger
 364 deflection and larger damage at 99 m/s compared to 106 m/s are attributed
 365 to experimental dispersion (projectile excentration, projectile tilted, etc.).
 366 [21] showed by SPH simulations that, in the case of gelatin impact on a rigid
 367 target, very moderate inclination could change the pressure pulse on the
 368 structure although the impact energy and momentum transfer are constant.

369 At 112 m/s, larger deflections caused three major cracks, all of them starting
 370 from the middle of the edges and running through the entire thickness.

371 Photos of plates' edges show that cracks are accompanied by the presence
 372 of delamination mainly located in the mid surface of the plate. It is linked
 373 to maximum shear stresses in the mid-plane of the sample and near the edge
 374 centres, leading to mode II delamination . As it can be observed in Fig. 12,
 375 on the edge, the delamination has almost not propagated beyond the white
 376 damage zones, indicating a high interlaminar tenacity.

377 *3.3. Laminate 2*

Velocity (m/s)	Pressure (bar)	Exp. duration (ms)	Eq. 1 (ms)	Diff. w. exp. %	Eq. 2 (ms)	Diff. w. exp. %
64	0.93	2.25	1.75	-22%	1.98	-12%
72	1.18	1.85	1.56	-16%	1.81	-2%
82	1.47	NA	1.37	NA	1.62	NA
93 (*)	1.83	2.50	1.21	-52%	1.42	-43%
100 (*)	2.02	1.90	1.12	-41%	1.33	-30%
105 (*)	2.19	1.35	1.07	-21%	1.41	+5%

Table 5: Impact duration for laminate 2. (*) indicates tests with large crack noticed.

378 Impact duration measured and calculated for laminate 2 is shown in Tab.
 379 5. As for laminate 1, the theoretical squash up time used by Wilbeck under-
 380 estimates due to the assumption of rigid target and is improved by modifying
 381 the relation according to Eq. 2. However, in the case of failure (see the re-
 382 sults for 93, 100, 105 m/s), the improvement given by Eq. 2 is very moderate.
 383 As will be shown later with post-mortem observations for laminate 2, failure
 384 consisted in major cracks accompanied by large delamination. Also, the time

385 responses for failed samples show a large drop in the natural frequency of
 386 the plate. This indicates a huge change in the global stiffness of the sample
 387 that caused large increase in the maximum deflection and, as a consequence,
 388 a longer duration.

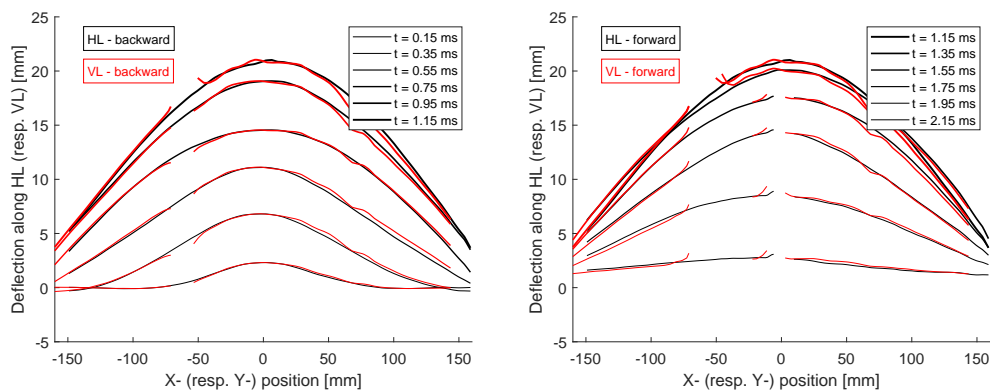

Figure 13: Deflection along horizontal line HL (black) and vertical line VL (red) at various time during the forward (left) and backward (right) motion for laminate 2 impacted at 82 m/s.

389 Deflection profiles along HL and VL are given in Fig. 13 for the forward
 390 (Fig. 13 left) and backward (Fig. 13 right) motion of laminate 2 impacted at
 391 82 m/s. Some parts of the deflection could not be extracted by DIC due to
 392 the presence of strain gauges. The horizontal and vertical profiles are clearly
 393 similar. This was expected since the stacking in laminate 2 leads to similar
 394 stiffnesses in the 0° and 90° directions.

395 Fig. 14 shows time histories of maximum deflection for laminate 2 im-
 396 pacted in the range 64-105 m/s. For a test at 100 m/s, the fast cameras did
 397 not trigger and the DIC extraction is not available. In raw data, the deflec-
 398 tion for 93 m/s test increased much slower than for 64, 72 and 82 m/s. The

399 reason is due to technical issues: the gelatin projectile was very stretched
400 compared to other tests. As a consequence, the impact duration was abnor-
401 mally longer. However, as shown by [33], it must be noticed that the impact
402 energy and momentum transfer can be considered as independant of the tilt
403 angle and projectile shape. In order to give a correct interpretation of 93
404 m/s curve, a time scaling was calculated based on the actual length of the
405 projectile approximately measured with front cameras 1 and 2 (see Fig. 4).
406 Impact velocities greater than 93 m/s led to exceeding the yield stress of the
407 samples. Change in slope in Fig. 14 indicates a sudden loss of stiffness due
408 to immediate propagation of cracks and delamination in the sample. This
409 change in slope closely follows the crack initiation noticed in the rear cam-
410 eras and indicated by diamond ticks in Fig. 14. Consistent with this, the
411 deflections of samples that failed also show a very long time for returning
412 to zero. Theoretically, this response time is mainly linked to the first natu-
413 ral period of composite plates and the duration of the loading. It regularly
414 decreases for unfailed samples when increasing from 64 to 82 m/s as the im-
415 pact duration decreases. However beyond failure (see for 93 and 105 m/s),
416 the response time largely increases. This is attributed an important drop in
417 the plate stiffness that has two direct consequences. Firstly, the first natu-
418 ral period (that mainly governs the response time) is longer. Secondly, the
419 maximum deflection is largely extended, what increases the impact duration
420 as discussed earlier.

421 Fig. 15 shows the impact face of the samples observed at 93, 100 and
422 105 m/s. As for laminate 1, mode 1 bending excited beyond a certain limit
423 led to compressive cracks occuring at the edge centers, running through the

424 thickness and propagating to the center of the plate. All cracks are accompa-
425 nied by large delamination, in most cases, along the whole edge. Only large
426 cracks occurred even though the velocity range was finely sampled. The first
427 sample failed at 93 m/s along a 190 mm long crack. At 100 and 106 m/s,
428 several cracks are created at the same time, all starting from an edge cen-
429 ter. All cracks are accompanied by very large delamination visible from the
430 edges, indicating a low interlaminar strain energy release rate for laminate
431 2. At this point, two possible scenarios are envisaged. In the first scenario,
432 large deflection of the plate led to excessive bending of the plate edges that
433 initiated folding. Cracks were created in the outer plies due to compressive
434 or tensile stresses and propagated through the thickness as the local stiffness
435 was lost. This also initiated local delamination that immediately propagated.
436 In the second scenario considered, large deflection of the plate led to exces-
437 sive shear stresses in the corners of the plate, which initiated delamination
438 that immediately propagated. This resulted in a sudden drop of the global
439 stiffness of the plate, that led bending to folding and initiated cracks at the
440 edge centres, propagating towards the plate centre. Eventually, variation
441 of interfacial properties and stress distribution due to the stacking sequence
442 could slightly shift the delamination plane from the exact geometrical mid-
443 surface of the sample. The dependency of failure with respect to the impact
444 velocity looks progressive, with a threshold below 93 m/s.

445 3.4. Laminate 3

446 Comparisons between experimental impact duration and Eq. 1 and 2 for
447 laminate 3 are given in Tab. 6. As previously, Wilbeck's theory underesti-
448 mates the impact duration due to the target flexibility. The underestimation

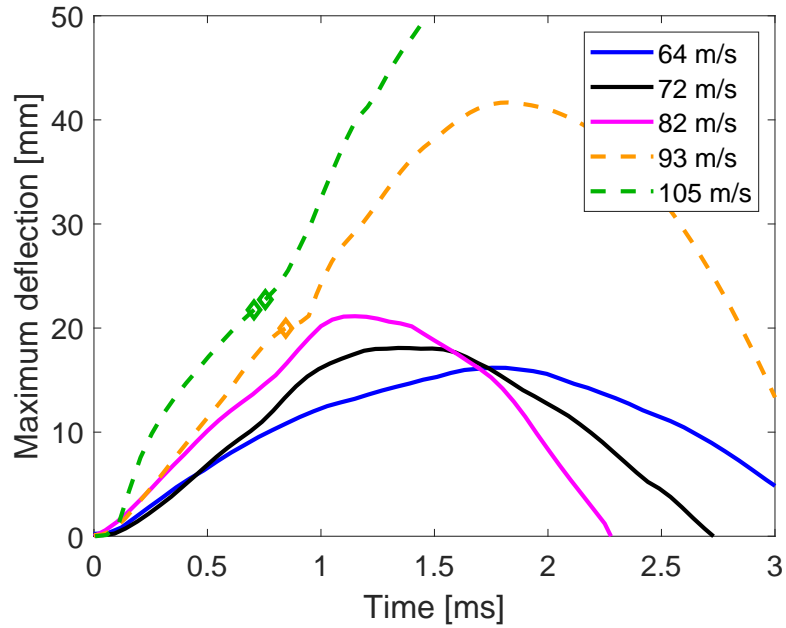

Figure 14: Time history of deflections for laminate 2 impacted at various velocities. Dashed lines show tests in which samples experienced large macro-cracks. Diamonds denotes crack visible in fast camera picture.

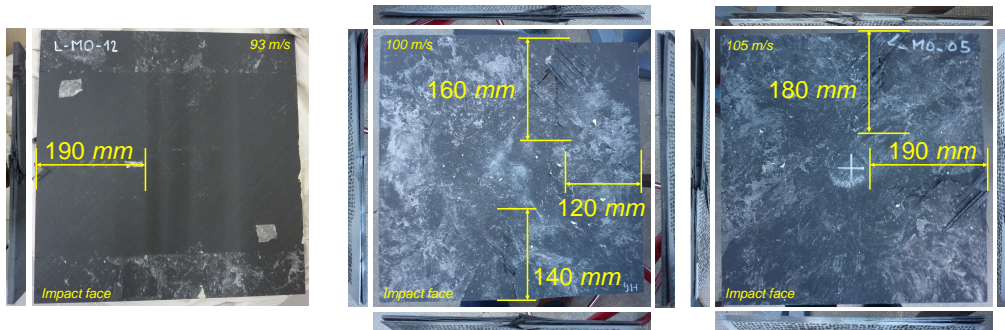

Figure 15: Post-mortem observation of damage on laminate 2 samples: (left) 93 *m/s*, (middle) 100 *m/s*, (right) 105 *m/s*. The side pictures show the edges delamination.

Velocity (m/s)	Pressure (bar)	Exp. duration (ms)	Eq. 1 (ms)	Diff. w. exp. %	Eq. 2 (ms)	Diff. w. exp. %
60	0.82	2.40	1.87	-22%	2.09	-13%
67 (*)	1.01	1.95	1.67	-14%	2.19	+12%
68	1.06	2.40	1.65	-31%	1.91	-21%
70 (*)	1.13	2.35	1.60	-32%	2.14	-9%
76	1.32	1.85	1.48	-20%	1.75	-5%
78	1.34	1.65	1.44	-13%	1.71	+4%
83 (*)	1.50	2.75	1.35	-51%	1.77	-36%
85	1.57	1.85	1.32	-29%	1.58	-15%
90 (*)	1.71	2.35	1.25	-47%	1.62	-31%

Table 6: Impact duration for laminate 3. (*) indicates tests with large crack noticed.

449 is particularly important for samples that failed (i.e. 67, 70, 83 and 90 m/s)
450 because failure led to a loss in stiffness and, as a consequence, an increased
451 deflection. Evaluation by Eq. 2 gives a more precise evaluation of the impact
452 duration, although still underestimating in the case of failure.

453 Fig. 16 shows the line profile of laminate 3 deflection along VL and HL for
454 the impact at 76 m/s during the forward motion (Fig. 16 left) and backward
455 motion (Fig. 16 right). During the impact, the center of laminate 3 sample
456 deflects first. However, the stiffness is different in 0° and 90° direction due
457 to preferential 0° fibre reinforcement, with 0° corresponding to the vertical
458 direction. As a consequence, the deflection is clearly more distributed along
459 the 0° direction (i.e. VL direction), in particular in the forward part of the
460 impact.

461 Fig. 17 shows the time history of deflections for laminate 3 for gelatin
462 impacts in the range 60-90 m/s. Maximum deflection takes place at approx-

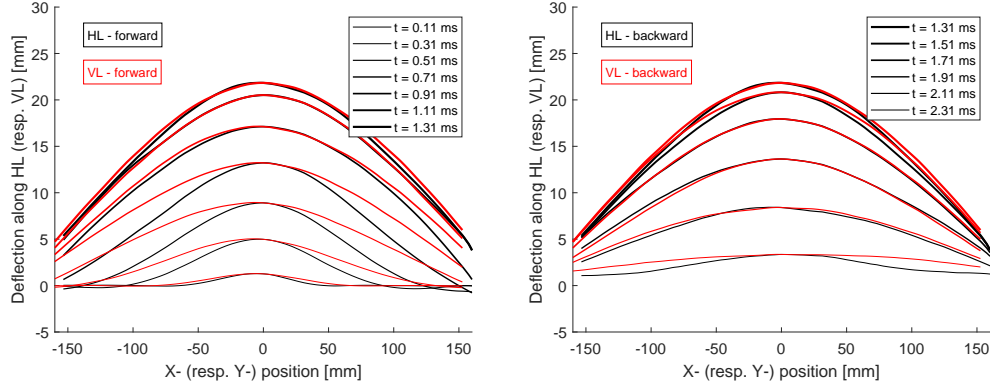

Figure 16: Deflection along horizontal line HL (black) and vertical line VL (red) at various time during the forward (left) and backward (right) motion for laminate 3 impacted at 76 m/s.

463 imately $1300 \mu\text{s}$. After that, the plate deforms backwards to zero except in
 464 the case of large cracks causing the loss of stiffness and, as a consequence,
 465 of strain energy. Dashed lines show tests in which samples experienced large
 466 macro-cracks or extended delamination. As expected, at the beginning, the
 467 deflection slope increases with the impact velocity. However, contrary to
 468 laminates 1 and 2, failure occurred in random order: the sample impacted at
 469 67 m/s failed, but the one at 85 m/s sustained without any visible damage.
 470 This “non-deterministic” failure behavior is attributed to a “all or none”
 471 behavior of laminate 3 UD material: as soon as damage or delamination
 472 initiates, it immediately propagates and leads to the complete failure of the
 473 sample. In particular, dispersion in the interlaminar properties of the mate-
 474 rial would lead to unpredictable sudden stiffness drop of the samples. This
 475 behavior was also noticed during quasi-static bending tests performed on
 476 beam samples of the same material [48]. In addition, random imperfections

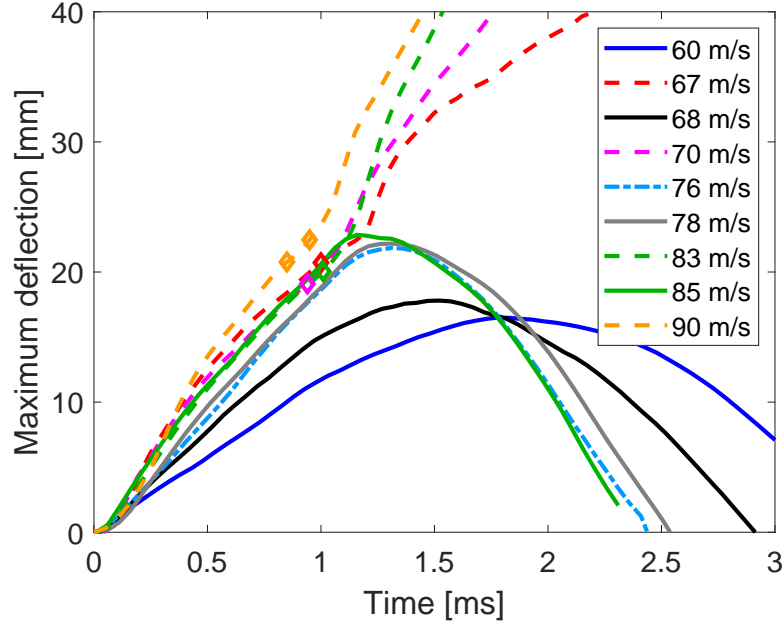

Figure 17: Time history of deflections for laminate 3 impacted at various velocities. Dashed lines show tests in which samples experienced large macro-cracks. The dash-dotted curve (76 m/s) corresponds to a sample experienced only delamination. Diamonds denotes times when crack seemed to appear on the camera picture.

477 (in particular porosities) in the material and experimental dispersion (pro-
 478 jectile tilt for instance) are expected to increase this chaotic behavior. This
 479 immediate propagation to quasi-complete failure is directly responsible for
 480 the change in slope points in time histories (see Fig. 17) for 67, 70, 83, 90
 481 m/s tests around 20-25 mm deflection. As for laminate 2, the response time
 482 slightly decreases for unfailed samples. In this case, the samples should have
 483 the same natural period, but the duration of the loading – related to the im-
 484 pact duration - slightly increases. However for failed samples, the response

485 time largely increases, and eventually the deflection did not come back to
486 zero when the loss in stiffness was too large.

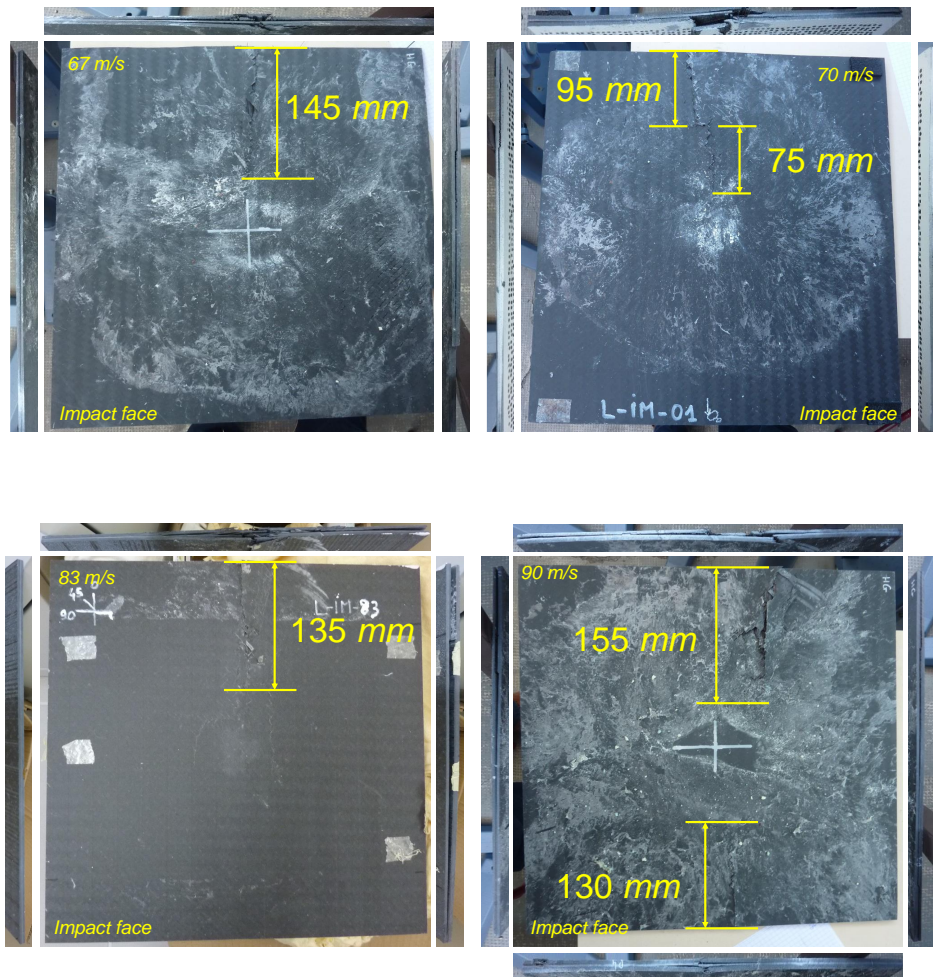

Figure 18: Post-mortem observation of damage on laminate 3 samples: (upper left) 67 m/s , bottom left 70 m/s , (upper right) 83 m/s , (bottom right) 90 m/s . The side pictures show the edges delamination.

487 Fig. 18 shows the impact faces and delaminated edges during post-

488 mortem inspection of the plates that failed. Despite the very moderate in-
489 crease in the impact velocity, only long cracks occurred, always longer than
490 130 mm. For 70 m/s, the first 95 mm crack “recentered” in a horizontal
491 bifurcation and then continued vertically towards the center of the plate. At
492 90 m/s, two vertical cracks were created at the top and bottom edges. It
493 should be noticed that only vertical cracks occurred. As noticed on the de-
494 formed shape, laminate 3 stiffness is different in 0° and 90° directions. This
495 difference has directly driven the directions of the cracks appearance as be-
496 ing caused by bending in the weakest direction (90°), what led to long cracks
497 along the 0° direction. From the edges’ pictures, all cracks were accompanied
498 by large delamination between the mid plies of the samples, with possibly
499 some bifurcation here and there.

500 Note that for the impact at 76 m/s, large delamination was noticed along
501 the edges without any crack in the facesheets. However, no difference with
502 undamaged plates can be noticed in the time history (Fig. 11), indicating
503 that the stiffness was globally maintained. This tends to indicate that in
504 laminate 3, delamination occurred first, then followed by cracks initiation
505 and immediate propagation, what led to a sudden drop in the stiffness.

506 For laminate 3, delamination was never located in the exact mid-surface
507 interface which is between two plies in 0° direction. In all cases, even when
508 initiated by the large cracks, the delaminated interface was between a 0° ply
509 and a 90° ply, or between a unidirectional ply (at 0°) and a fabric ply (at
510 $\pm 45^\circ$).

511 **4. Conclusion**

512 This paper provides a detailed analysis of 21 gelatin impact tests per-
513 formed on three laminated composite configurations at several velocities up
514 to complete failure. One objective of this paper is to open the experimen-
515 tal data to the readers for comparison with other tests or numerical models.
516 The experimental data from DIC analysis are available on the *Recherche Data*
517 *Gouv* website at the following URL [43]: <https://doi.org/10.57745/UA1CRZ>.

518 Some conclusions can be drawn:

- 519 • for transient dynamic experiments, DIC analysis provides a very de-
520 tailed experimental information. The field data extracted is able to
521 capture both the time and space variations, what should be considered
522 of key interest for the validation of numerical models.
- 523 • DIC analysis was shown to finely capture the strain field on the back
524 face of the sample; as a consequence, strain gauges could be removed.
- 525 • neglecting the target flexibility leads to high underestimation of the im-
526 pact duration by around -20% to -30% or more with Wilbeck's relation.
527 Based on the deflection recorded during the test, a modified equation
528 was proposed that improves the estimation of impact duration.
- 529 • failure mechanisms were different for the materials tested: for glass/epoxy
530 plain weave fabrics laminate, bending led to cracking the outer plies
531 by global folding of the plate, without extended delamination. For
532 the carbon/epoxy materials, delamination seemed to occur first and to
533 propagate immediately, then leading to large bending and loss of stiff-
534 ness. A fine prediction of such failure mechanisms based on material

535 models is a challenge. In particular for laminate 3, failure occurred in
536 a non progressive way with respect to impact speed. Such dispersion
537 can not be solely attributed to experimental hazards. Dispersion in
538 the materials properties are currently being investigated to explain the
539 failure noticed.

540 Continuation of this study is currently under progress, with other ma-
541 terials tested, and an improvement of the experimental set-up with force
542 sensors. A multiscale numerical model involving the failure mechanisms is
543 also undertaken.

544 **CRedit authorship contribution statement**

545 **O. Dorival** Conceptualization, Methodology, State of the art, experi-
546 ments preparation, experimental campaign, post-treatment, validation, fund-
547 ing acquisition, project management, writing - original draft, writing - review
548 & editing. **P. Navarro** Experiments preparation, experimental campaign,
549 writing - review & editing. **S. Marguet** Set-up design, experimental cam-
550 paign, post-treatment, writing - review & editing. **J.-F. Ferrero** Conceptu-
551 alization, Methodology, Experimental campaign, funding acquisition, super-
552 vision, writing - review & editing.

553 **Acknowledgements**

554 This research work has been conducted with the financial grant of DGA
555 Naval Systems, France, within the framework of the DGA RAPID project
556 named SUCCESS. The authors would also like to express their gratitude

557 to the engineering design office Meca (www.calcul-meca.fr) and Multiplast
558 company for their technical assistance.

559 **Declaration of Competing Interest**

560 The authors declare that they have no known competing financial inter-
561 ests or personal relationships that could have appeared to influence the work
562 reported in this paper.

563 **References**

- 564 [1] P. Wang, C. Lian, C. Yue, X. Wu, J. Zhang, K. Zhang,
565 Z. Yue, Experimental and numerical study of tire debris im-
566 pact on fuel tank cover based on coupled eulerian-lagrangian
567 method, *International Journal of Impact Engineering* 157
568 (2021) 103968. URL: [https://www.sciencedirect.com/science/
569 article/pii/S0734743X2100155X](https://www.sciencedirect.com/science/article/pii/S0734743X2100155X). doi:[https://doi.org/10.1016/j.
570 ijimpeng.2021.103968](https://doi.org/10.1016/j.ijimpeng.2021.103968).
- 571 [2] L. Wu, D. Huang, F. Bobaru, A reformulated rate-dependent
572 visco-elastic model for dynamic deformation and fracture of pmma
573 with peridynamics, *International Journal of Impact Engineering*
574 149 (2021) 103791. URL: [https://www.sciencedirect.com/science/
575 article/pii/S0734743X20308617](https://www.sciencedirect.com/science/article/pii/S0734743X20308617). doi:[https://doi.org/10.1016/j.
576 ijimpeng.2020.103791](https://doi.org/10.1016/j.ijimpeng.2020.103791).
- 577 [3] I. Mohagheghian, Y. Wang, J. Zhou, L. Yu, X. Guo, Y. Yan,
578 M. Charalambides, J. Dear, Deformation and damage mech-
579 anisms of laminated glass windows subjected to high velocity

- 580 soft impact, International Journal of Solids and Structures
581 109 (2017) 46–62. URL: [https://www.sciencedirect.com/science/
582 article/pii/S0020768317300082](https://www.sciencedirect.com/science/article/pii/S0020768317300082). doi:[https://doi.org/10.1016/j.
583 ijsolstr.2017.01.006](https://doi.org/10.1016/j.ijsolstr.2017.01.006).
- 584 [4] I. Mohagheghian, M. Charalambides, Y. Wang, L. Jiang, X. Zhang,
585 Y. Yan, A. Kinloch, J. Dear, Effect of the polymer in-
586 terlayer on the high-velocity soft impact response of laminated
587 glass plates, International Journal of Impact Engineering 120
588 (2018) 150–170. URL: [https://www.sciencedirect.com/science/
589 article/pii/S0734743X18300265](https://www.sciencedirect.com/science/article/pii/S0734743X18300265). doi:[https://doi.org/10.1016/j.
590 ijimpeng.2018.06.002](https://doi.org/10.1016/j.ijimpeng.2018.06.002).
- 591 [5] N. Ahmed, P. Xue, Determination of the size of the local region
592 for efficient global/local modeling in a large composite structure un-
593 der impact loading, International Journal of Impact Engineering
594 144 (2020) 103646. URL: [https://www.sciencedirect.com/science/
595 article/pii/S0734743X18312181](https://www.sciencedirect.com/science/article/pii/S0734743X18312181). doi:[https://doi.org/10.1016/j.
596 ijimpeng.2020.103646](https://doi.org/10.1016/j.ijimpeng.2020.103646).
- 597 [6] J. LIU, Y. LI, X. YU, X. GAO, Z. LIU, Design of aircraft struc-
598 tures against threat of bird strikes, Chinese Journal of Aeronautics 31
599 (2018) 1535–1558. URL: [https://www.sciencedirect.com/science/
600 article/pii/S1000936118301614](https://www.sciencedirect.com/science/article/pii/S1000936118301614). doi:[https://doi.org/10.1016/j.
601 cja.2018.05.004](https://doi.org/10.1016/j.cja.2018.05.004).
- 602 [7] X. Meng, Y. Sun, J. Yu, Z. Tang, J. Liu, T. Suo, Y. Li,
603 Dynamic response of the horizontal stabilizer during uas air-

- 604 borne collision, International Journal of Impact Engineering
605 126 (2019) 50–61. URL: [https://www.sciencedirect.com/science/
606 article/pii/S0734743X18305098](https://www.sciencedirect.com/science/article/pii/S0734743X18305098). doi:[https://doi.org/10.1016/j.
607 ijimpeng.2018.11.015](https://doi.org/10.1016/j.ijimpeng.2018.11.015).
- 608 [8] M. S. Tatlier, T. Baran, Structural and cfd analysis of an airfoil
609 subjected to bird strike, European Journal of Mechanics - B/Fluids
610 84 (2020) 478–486. URL: [https://www.sciencedirect.com/science/
611 article/pii/S0997754619307721](https://www.sciencedirect.com/science/article/pii/S0997754619307721). doi:[https://doi.org/10.1016/j.
612 euromechflu.2020.07.012](https://doi.org/10.1016/j.euromechflu.2020.07.012).
- 613 [9] R. Vignjevic, M. Orłowski, T. De Vuyst, J. C. Campbell, A
614 parametric study of bird strike on engine blades, International
615 Journal of Impact Engineering 60 (2013) 44–57. URL: [https://www.
616 sciencedirect.com/science/article/pii/S0734743X13000870](https://www.sciencedirect.com/science/article/pii/S0734743X13000870).
617 doi:<https://doi.org/10.1016/j.ijimpeng.2013.04.003>.
- 618 [10] L. Liu, G. Luo, W. Chen, Z. Zhao, X. Huang, Dynamic behavior and
619 damage mechanism of 3d braided composite fan blade under bird impact,
620 International Journal of Aerospace Engineering 2018 (2018) 5906078–
621 . URL: [https://doi.org/10.1155/2018/
622 5906078](https://doi.org/10.1155/2018/5906078). doi:10.1155/2018/5906078.
- 623 [11] P. Davies, Composites for Marine Applications, Springer Nether-
624 lands, Dordrecht, 1999, pp. 235–248. URL: [https://doi.org/10.1007/
625 978-94-011-4489-6_12](https://doi.org/10.1007/978-94-011-4489-6_12). doi:10.1007/978-94-011-4489-6_12.
- 626 [12] G. Gupta, A. Kumar, R. Tyagi, S. Kumar, Application and future

- 627 of composite materials: A review, *International Journal of Innovative*
628 *Research in Science, Engineering and Technology* 5 (2016) 6907–6911.
- 629 [13] R. Masilamani, N. Dhandapani, K. V. Kumar, K. T. Mani, A review on
630 usage of carbon fiber reinforced plastics in automobiles, *International*
631 *Journal of Pure and Applied Mathematics* 117 (2017) 537–544.
- 632 [14] M. Fuwa, A. Bunsell, B. Harris, Tensile failure mechanisms in carbon
633 fibre reinforced plastics, *J. Mater. Sci.* 10 (1975) 2062–2070. doi:<https://doi.org/10.1007/BF00557484>.
- 635 [15] D. Gay, *Composite Materials: Design and Applications* (4th ed.),
636 CRC Press, Boca Raton, 2022. doi:[https://doi.org/10.1201/](https://doi.org/10.1201/9781003195788)
637 [9781003195788](https://doi.org/10.1201/9781003195788).
- 638 [16] S. Abrate, Soft impacts on aerospace structures, *Progress*
639 *in Aerospace Sciences* 81 (2016) 1–17. URL: [https://www.](https://www.sciencedirect.com/science/article/pii/S0376042115300294)
640 [sciencedirect.com/science/article/pii/S0376042115300294](https://www.sciencedirect.com/science/article/pii/S0376042115300294).
641 doi:<https://doi.org/10.1016/j.paerosci.2015.11.005>, dynamic
642 Loading Aspects of Composite Materials.
- 643 [17] I. C. Metz, J. Ellerbroek, T. Mühlhausen, D. Kügler, J. M. Hoekstra,
644 The bird strike challenge, *Aerospace* 7 (2020). URL: [https://www.](https://www.mdpi.com/2226-4310/7/3/26)
645 [mdpi.com/2226-4310/7/3/26](https://www.mdpi.com/2226-4310/7/3/26). doi:10.3390/aerospace7030026.
- 646 [18] J. P. Barber, H. R. Taylor, J. S. Wilbeck, Characterization of bird
647 impacts on a rigid plate: Part 1, in: Technical report AFFDL-TR-75-
648 5, Air Force Flight Dynamics Laboratory, Wright-Patterson Air Force
649 Base, OH, 1975.

- 650 [19] R. L. Peterson, J. P. Barber, Bird impact forces in aircraft windshield
651 design, in: Technical report AFFDL-TR-75-150, Air Force Flight Dy-
652 namics Laboratory, Wright-Patterson Air Force Base, OH, 1976.
- 653 [20] J. S. Wilbeck, Impact behavior of low strength projectiles., in: Techni-
654 cal report AFML-TR-77-134, Air Force Materials Laboratory, Wright-
655 Patterson Air Force Base, OH, 1978.
- 656 [21] F. Allaey, G. Luyckx, W. Van Paepegem, J. Degrieck, Numer-
657 ical and experimental investigation of the shock and steady state
658 pressures in the bird material during bird strike, International Jour-
659 nal of Impact Engineering 107 (2017) 12–22. URL: <https://www.sciencedirect.com/science/article/pii/S0734743X16308843>.
660 doi:<https://doi.org/10.1016/j.ijimpeng.2017.05.006>.
- 662 [22] S. Heimbs, Computational methods for bird strike simulations: A
663 review, Computers & Structures 89 (2011) 2093–2112. doi:<https://doi.org/10.1016/j.compstruc.2011.08.007>.
664
- 665 [23] C. J. Welsh, V. Centonze, Aircraft transparency testing - artificial birds.
666 report aedc-tr-86-2, us air force, in: Technical report AEDC-TR-86-2,
667 Arnold Engineering Development Center, Arnold Air Force Station, TN,
668 1986.
- 669 [24] M. Lavoie, A. Gakwaya, M. N. Ensan, D. Zimcik, D. Nand-
670 lall, Bird's substitute tests results and evaluation of available nu-
671 merical methods, International Journal of Impact Engineering 36
672 (2009) 1276–1287. URL: <https://www.sciencedirect.com/science/>

- 673 [article/pii/S0734743X0900058X](https://doi.org/10.1016/j.ijimpeng.2009.03.009). doi:<https://doi.org/10.1016/j.ijimpeng.2009.03.009>.
- 674
- 675 [25] G. D. Roberts, J. M. Pereira, D. M. Revilock, W. K. Binienda, M. Xie,
676 M. Braley, Ballistic impact of braided composites with a soft projectile,
677 Journal of Aerospace Engineering 18 (2005) 3–7. doi:10.1061/(ASCE)
678 0893-1321(2005)18:1(3).
- 679 [26] S. Zhu, M. Tong, Y. Wang, Experiment and Numerical Simula-
680 tion of a Full-Scale Aircraft Windshield Subjected to Bird Impact,
681 ???? URL: <https://arc.aiaa.org/doi/abs/10.2514/6.2009-2575>.
682 doi:10.2514/6.2009-2575.
- 683 [27] D. Hu, B. Song, D. Wang, Z. Chen, Experiment and numeri-
684 cal simulation of a full-scale helicopter composite cockpit structure
685 subject to a bird strike, Composite Structures 149 (2016) 385–
686 397. URL: <https://www.sciencedirect.com/science/article/pii/S0263822316303269>. doi:<https://doi.org/10.1016/j.compstruct.2016.04.035>.
- 687
- 688
- 689 [28] J. Liu, Y. Li, X. Yu, Z. Tang, X. Gao, J. Lv, Z. Zhang, A
690 novel design for reinforcing the aircraft tail leading edge structure
691 against bird strike, International Journal of Impact Engineering
692 105 (2017) 89–101. URL: <https://www.sciencedirect.com/science/article/pii/S0734743X16310995>. doi:<https://doi.org/10.1016/j.ijimpeng.2016.12.017>, design and Analysis of Protective Structures
693
694
695 2015.

- 696 [29] Y. Liu, J. Qu, X. Yan, Y. Pang, P. Yang, Study on dynamic response
697 characteristics of bird impact glass fiber laminate, *Journal of Physics:*
698 *Conference Series* 1676 (2020) 012178. URL: [https://dx.doi.org/
699 10.1088/1742-6596/1676/1/012178](https://dx.doi.org/10.1088/1742-6596/1676/1/012178). doi:10.1088/1742-6596/1676/
700 1/012178.
- 701 [30] E. Giannaros, A. Kotzakolios, V. Kostopoulos, G. Sotiriadis,
702 R. Vignjevic, N. Djordjevic, M. Boccaccio, M. Meo, Low-
703 and high-fidelity modeling of sandwich-structured composite re-
704 sponse to bird strike, as tools for a digital-twin-assisted dam-
705 age diagnosis, *International Journal of Impact Engineering* 160
706 (2022) 104058. URL: [https://www.sciencedirect.com/science/
707 article/pii/S0734743X21002451](https://www.sciencedirect.com/science/article/pii/S0734743X21002451). doi:[https://doi.org/10.1016/j.
708 ijimpeng.2021.104058](https://doi.org/10.1016/j.ijimpeng.2021.104058).
- 709 [31] R. Vignjevic, J. Campbell, K. Hughes, M. Orłowski, S. Garcea,
710 P. Withers, J. Reed, Soft body impact resistance of composite
711 foam core sandwich panels with unidirectional corrugated and tubu-
712 lar reinforcements, *International Journal of Impact Engineering*
713 132 (2019) 103320. URL: [https://www.sciencedirect.com/science/
714 article/pii/S0734743X19301800](https://www.sciencedirect.com/science/article/pii/S0734743X19301800). doi:[https://doi.org/10.1016/j.
715 ijimpeng.2019.103320](https://doi.org/10.1016/j.ijimpeng.2019.103320).
- 716 [32] M. Anghileri, G. Sala, Theoretical assessment, numerical simulation
717 and comparison with tests of birdstrike on deformable structures, in:
718 *Proceedings of the 20th Congress of the International Council of the
719 Aeronautical Sciences (ICAS 96)*, 1996.

- 720 [33] F. Allaeyns, G. Luyckx, W. Van Paepegem, J. Degrieck, Characterization of real and substitute birds through experimental and
721 numerical analysis of momentum, average impact force and residual energy in bird strike on three rigid targets: A flat plate, a
722 wedge and a splitter, *International Journal of Impact Engineering* 99 (2017) 1–13. URL: [https://www.sciencedirect.com/science/](https://www.sciencedirect.com/science/article/pii/S0734743X16303165)
723 [article/pii/S0734743X16303165](https://www.sciencedirect.com/science/article/pii/S0734743X16303165). doi:[https://doi.org/10.1016/j.](https://doi.org/10.1016/j.ijimpeng.2016.08.009)
724 [ijimpeng.2016.08.009](https://doi.org/10.1016/j.ijimpeng.2016.08.009).
725
726
727
- 728 [34] D. Nandlall, A. Gakwaya, On the determination of the shock and steady state parameters of gelatine from cylinder im-
729 pact experiments, *International Journal of Impact Engineering* 116 (2018) 22–33. URL: [https://www.sciencedirect.com/science/](https://www.sciencedirect.com/science/article/pii/S0734743X17309028)
730 [article/pii/S0734743X17309028](https://www.sciencedirect.com/science/article/pii/S0734743X17309028). doi:[https://doi.org/10.1016/j.](https://doi.org/10.1016/j.ijimpeng.2018.02.001)
731 [ijimpeng.2018.02.001](https://doi.org/10.1016/j.ijimpeng.2018.02.001).
732
733
- 734 [35] J. Pernas-Sanchez, J. Artero-Guerrero, D. Varas, J. Lopez-Puente, Artificial bird strike on hopkinson tube device: Experimental and
735 numerical analysis, *International Journal of Impact Engineering* 138 (2020) 103477. URL: [https://www.sciencedirect.com/science/](https://www.sciencedirect.com/science/article/pii/S0734743X19308280)
736 [article/pii/S0734743X19308280](https://www.sciencedirect.com/science/article/pii/S0734743X19308280). doi:[https://doi.org/10.1016/j.](https://doi.org/10.1016/j.ijimpeng.2019.103477)
737 [ijimpeng.2019.103477](https://doi.org/10.1016/j.ijimpeng.2019.103477).
738
739
- 740 [36] J. Field, S. Walley, W. Proud, H. Goldrein, C. Siviour, Review of experimental techniques for high rate deformation and
741 shock studies, *International Journal of Impact Engineering* 30 (2004) 725–775. URL: <https://www.sciencedirect.com/science/>
742
743

- 744 article/pii/S0734743X04000521. doi:<https://doi.org/10.1016/j.ijimpeng.2004.03.005>, fifth International Symposium on Impact En-
745 gineering.
746
- 747 [37] F. Hild, A. Bouterf, S. Roux, Measurement of kinematic fields
748 via dic for impact engineering applications, International Journal
749 of Impact Engineering 130 (2019) 163–171. URL: <https://www.sciencedirect.com/science/article/pii/S0734743X1831087X>.
750 doi:<https://doi.org/10.1016/j.ijimpeng.2019.04.007>.
751
- 752 [38] H. Xin, J. Tao, M. Xiaomin, S. Xuefeng, L. Xin, Dynamic re-
753 sponse of single curved fiber-metal hybrid lamina composites subject
754 to low-velocity impact, International Journal of Impact Engineering
755 164 (2022) 104209. URL: <https://www.sciencedirect.com/science/article/pii/S0734743X22000550>. doi:<https://doi.org/10.1016/j.ijimpeng.2022.104209>.
756
757
- 758 [39] H. Arora, P. A. Hooper, J. P. Dear, The effects of air and un-
759 derwater blast on composite sandwich panels and tubular laminate
760 structures, Experimental Mechanics 52 (2012) 59–81. URL: <https://doi.org/10.1007/s11340-011-9506-z>. doi:<https://doi.org/10.1007/s11340-011-9506-z>, dynamic Loading Aspects of Composite Ma-
761 terials.
762
763
- 764 [40] M. Louar, B. Belkassem, H. Ousji, K. Spranghers, D. Kakogiannis,
765 L. Pyl, J. Vantomme, Explosive driven shock tube loading of aluminium
766 plates: experimental study, International Journal of Impact Engineering
767 86 (2015) 111–123. URL: <https://www.sciencedirect.com/science/>

768 [article/pii/S0734743X15001682](https://doi.org/10.1016/j.ijimpeng.2015.07.013). doi:<https://doi.org/10.1016/j.ijimpeng.2015.07.013>.

770 [41] D. Delsart, F. Boyer, A. Vagnot, Assessment of a substitute bird model
771 for the prediction of bird-strike of helicopters structures, in: Proceed-
772 ings of the 7th International Conference on Mechanics and Materials in
773 Design. Albufeira/Portugal 11-15 June 2017, 2017.

774 [42] J. Zhou, J. Liu, X. Zhang, Y. Yan, L. Jiang, I. Mohagheghian,
775 J. Dear, M. Charalambides, Experimental and numerical in-
776 vestigation of high velocity soft impact loading on aircraft ma-
777 terials, *Aerospace Science and Technology* 90 (2019) 44–
778 58. URL: [https://www.sciencedirect.com/science/article/pii/](https://www.sciencedirect.com/science/article/pii/S1270963818327147)
779 [S1270963818327147](https://www.sciencedirect.com/science/article/pii/S1270963818327147). doi:[https://doi.org/10.1016/j.ast.2019.04.](https://doi.org/10.1016/j.ast.2019.04.015)
780 015.

781 [43] O. Dorival, P. Navarro, S. Marguet, J.-F. Ferrero, 3D digital image
782 correlation of soft impact test on composite plates, 2023. URL: <https://doi.org/10.57745/UA1CRZ>. doi:10.57745/UA1CRZ.
783

784 [44] L. Marquez Duque, H. Le Sourne, J.-C. Petiteau, Arbitrary lagrangian
785 eulerian method to study gel projectile impacts against composite naval
786 plates, in: Proceedings of the 7th ECCOMAS Thematic Conference on
787 the Mechanical Response of Composites. Girona, Spain., 2019.

788 [45] A. M. Amaro, P. N. B. Reis, A. G. Magalhães, M. F. S. F. de Moura, The
789 influence of the boundary conditions on low-velocity impact composite
790 damage, *Strain* 47 (2011) e220–e226. URL: [https://onlinelibrary.](https://onlinelibrary)

- 791 wiley.com/doi/abs/10.1111/j.1475-1305.2008.00534.x.
792 doi:<https://doi.org/10.1111/j.1475-1305.2008.00534.x>.
793 arXiv:<https://onlinelibrary.wiley.com/doi/pdf/10.1111/j.1475-1305.2008.00534.x>.
- 794 [46] T. M. Pham, H. Hao, Effect of the plastic hinge and
795 boundary conditions on the impact behavior of reinforced con-
796 crete beams, International Journal of Impact Engineering
797 102 (2017) 74–85. URL: [https://www.sciencedirect.com/science/](https://www.sciencedirect.com/science/article/pii/S0734743X16305851)
798 [article/pii/S0734743X16305851](https://www.sciencedirect.com/science/article/pii/S0734743X16305851). doi:[https://doi.org/10.1016/j.](https://doi.org/10.1016/j.ijimpeng.2016.12.005)
799 [ijimpeng.2016.12.005](https://doi.org/10.1016/j.ijimpeng.2016.12.005).
- 800 [47] K. R. Kaware, M. S. Kotambkar, Effect of impactor velocity and bound-
801 ary condition on low velocity impact finite element modelling of cfrp
802 composite laminates, IOP Conference Series: Materials Science and
803 Engineering 1004 (2020) 012018. URL: [https://dx.doi.org/10.1088/](https://dx.doi.org/10.1088/1757-899X/1004/1/012018)
804 [1757-899X/1004/1/012018](https://dx.doi.org/10.1088/1757-899X/1004/1/012018). doi:10.1088/1757-899X/1004/1/012018.
- 805 [48] G. Barlow, O. Dorival, G. Kemlin, Endommagements de compos-
806 ites stratifiés et sandwiches sous impacts de gélatine moyenne vitesse,
807 in: 21ème Journées Nationales sur les Composites, École Nationale
808 Supérieure d’Arts et Métiers (ENSAM) - Bordeaux, Bordeaux, Talence,
809 France, 2019. URL: <https://hal.science/hal-02420804>.