



**HAL**  
open science

## SCCS OPINION ON Fullerenes, Hydroxylated Fullerenes and hydrated forms of Hydroxylated Fullerenes (nano) - SCCS/1649/23 - Final Opinion

U. Bernauer, L. Bodin, Q. Chaudhry, P.J. Coenraads, M. Dusinska, E. Gaffet, E. Panteri, M. Stepnik, S. Wijnhoven, W.H. De Jong, et al.

### ► To cite this version:

U. Bernauer, L. Bodin, Q. Chaudhry, P.J. Coenraads, M. Dusinska, et al.. SCCS OPINION ON Fullerenes, Hydroxylated Fullerenes and hydrated forms of Hydroxylated Fullerenes (nano) - SCCS/1649/23 - Final Opinion. Scientific Committee for Consumer Safety (SCCS, EC). , 2023, Scientific Committee for Consumer Safety (SCCS, EC). hal-04270321

**HAL Id: hal-04270321**

**<https://hal.science/hal-04270321>**

Submitted on 8 Nov 2023

**HAL** is a multi-disciplinary open access archive for the deposit and dissemination of scientific research documents, whether they are published or not. The documents may come from teaching and research institutions in France or abroad, or from public or private research centers.

L'archive ouverte pluridisciplinaire **HAL**, est destinée au dépôt et à la diffusion de documents scientifiques de niveau recherche, publiés ou non, émanant des établissements d'enseignement et de recherche français ou étrangers, des laboratoires publics ou privés.



## **Scientific Committee on Consumer Safety**

### **SCCS**

### **OPINION ON**

## **Fullerenes, Hydroxylated Fullerenes and hydrated forms of Hydroxylated Fullerenes (nano)**



The SCCS adopted this document  
during its plenary meeting on 26 October 2023

## **ACKNOWLEDGMENTS**

Members of the Working Group are acknowledged for their valuable contribution to this Opinion. The members of the Working Group are:

### The SCCS members

Dr U. Bernauer (Chairperson)

Dr L. Bodin

Prof. Q. Chaudhry

Prof. P.J. Coenraads (Vice-Chair)

Prof. M. Dusinska

Dr E. Gaffet

Prof. E. Panteri (Rapporteur)

Dr M. Stepnik

Dr S. Wijnhoven

### The SCHEER member

Dr W.H. de Jong

### External experts

Dr N. von Goetz

All Declarations of Working Group members are available on the following webpage:

[Register of Commission expert groups and other similar entities](#)

## 1. ABSTRACT

### The SCCS concludes the following:

1. *In view of the above, and taking into account the scientific data provided, does the SCCS consider Fullerenes, Hydroxylated Fullerenes and hydrated forms of Hydroxylated Fullerenes safe when used in cosmetic products according to the maximum concentrations and specifications as reported via CPNP, taking into account reasonably foreseeable exposure conditions?*

Having assessed the information provided by the Notifiers, and the information available from published literature, the SCCS cannot conclude on the safety of fullerenes and (hydrated) hydroxylated forms of fullerenes due to a number of uncertainties and data gaps in regard to physicochemical, toxicokinetic and toxicological aspects. These uncertainties and data gaps have been indicated in relevant sections of the Opinion and must be addressed by the Notifiers to enable a conclusion on the safety of these materials for use in cosmetic products.

In particular, the SCCS cannot exclude the genotoxicity potential of fullerenes (C60 and C70). The available evidence also indicates that hydrated forms of hydroxylated fullerenes are genotoxic and hence the SCCS considers them as not safe for use in cosmetic products. In view of the equivalence to hydrated forms of hydroxylated fullerenes, as discussed in section 3.1.1.5, the same concerns over genotoxicity potential also apply to hydroxylated fullerenes.

2. *Based on the currently available scientific literature and SCCS' expert judgement, the SCCS is requested to assess any further scientific concerns with regard to the use of Fullerenes, Hydroxylated Fullerenes and hydrated forms of Hydroxylated Fullerenes in cosmetic products and whether a potential risk to human health can be identified according to Article 16(6) Reg.1223/2009.*

In Annex-1 of this Opinion, the SCCS has noted the basis for concerns over the risks that the use of fullerenes, hydroxylated fullerenes and hydrated forms of hydroxylated fullerenes in cosmetic products may pose to the consumer. In brief, the SCCS has concerns in regard to:

- the potential presence of impurities (such as epoxide forms), heavy metals, accompanying contaminants and/or organic solvents in the notified nanomaterials. There is also a lack of data on the stability of hydroxylated fullerenes and their hydrated forms.
- the potential ability of fullerenes and derivatives to induce production of free oxyradicals when used in cosmetic products.
- phototoxicity of hydroxylated fullerenes – with similar concerns for the hydrated forms of hydroxylated fullerenes.
- sensitising potential of hydroxylated fullerenes.
- potential dermal absorption and systemic availability of the nanoparticles via the use in cosmetic products.
- potential distribution of systemically available fullerenes to various organs in the body and accumulation of the nanoparticles in certain organs – such as lungs and liver.
- the available evidence being insufficient to allow the SCCS to exclude genotoxic/carcinogenic potential of any of the materials assessed in this Opinion.

This Opinion has been subject to a commenting period (from 24 April to 12 June 2023) after its initial publication. Comments received during this period were considered by the SCCS. For this Opinion, main changes occurred in the sections on physicochemical part and in toxicokinetic part, based on the newly submitted information.

Keywords: SCCS, scientific opinion, Fullerenes, Hydroxylated Fullerenes, hydrated forms of Hydroxylated Fullerenes, nano, CAS/EC No. 99685-96-8/628-630-7, 11538-22-7/-, 182024-42-6/-, Regulation 1223/2009

Opinion to be cited as: SCCS (Scientific Committee on Consumer Safety), Opinion on Fullerenes, Hydroxylated Fullerenes and hydrated forms of Hydroxylated Fullerenes (nano), final version of 26 October 2023, SCCS/1649/23

#### About the Scientific Committees

Two independent non-food Scientific Committees provide the Commission with the scientific advice it needs when preparing policy and proposals relating to consumer safety, public health and the environment. The Committees also draw the Commission's attention to the new or emerging problems which may pose an actual or potential threat.

They are: the Scientific Committee on Consumer Safety (SCCS) and the Scientific Committee on Health, Environmental and Emerging Risks (SCHEER) and are made up of scientists appointed in their personal capacity.

In addition, the Commission relies upon the work of the European Food Safety Authority (EFSA), the European Medicines Agency (EMA), the European Centre for Disease Prevention and Control (ECDC) and the European Chemicals Agency (ECHA).

#### SCCS

The Committee shall provide Opinions on questions concerning all types of health and safety risks (notably chemical, biological, mechanical and other physical risks) of non-food consumer products (for example: cosmetic products and their ingredients, toys, textiles, clothing, personal care and household products such as detergents, etc.) and services (for example: tattooing, artificial sun tanning, etc.).

#### Scientific Committee members

Ulrike Bernauer, Laurent Bodin, Qasim Chaudhry, Pieter Jan Coenraads, Maria Dusinska, Janine Ezendam, Eric Gaffet, Corrado Lodovico Galli, Eirini Panteri, Vera Rogiers, Christophe Rousselle, Maciej Stepnik, Tamara Vanhaecke, Susan Wijnhoven

#### Contact

European Commission  
Health and Food Safety  
Directorate B: Public Health, Cancer and Health security  
Unit B3: Health monitoring and cooperation, Health networks  
L-2920 Luxembourg  
[SANTE-SCCS@ec.europa.eu](mailto:SANTE-SCCS@ec.europa.eu)

© European Union, 2023

ISSN

ISBN

Doi

ND

The opinions of the Scientific Committees present the views of the independent scientists who are members of the committees. They do not necessarily reflect the views of the European Commission. The opinions are published by the European Commission in their original language only.

[http://ec.europa.eu/health/scientific\\_committees/consumer\\_safety/index\\_en.htm](http://ec.europa.eu/health/scientific_committees/consumer_safety/index_en.htm)

**TABLE OF CONTENTS**

ACKNOWLEDGMENTS .....	2
1. ABSTRACT .....	3
2. MANDATE FROM THE EUROPEAN COMMISSION .....	7
3. OPINION.....	8
3.1 CHEMICAL AND PHYSICAL SPECIFICATIONS .....	8
3.1.1 Chemical identity .....	8
3.1.2 Physical form .....	12
3.1.3 Molecular weight .....	13
3.1.4 Purity, composition, and substance codes.....	13
3.1.5 Impurities / accompanying contaminants .....	19
3.1.6 Solubility .....	21
3.1.7 Partition coefficient (Log P <sub>ow</sub> ).....	24
3.1.8 Additional physical and chemical specifications.....	24
3.1.9 Particle size .....	26
3.1.10 Crystal structure.....	30
3.1.11 UV absorption .....	30
3.1.12 Surface characteristics.....	31
3.1.13 Droplet size in formulations.....	32
3.1.14 Homogeneity and stability.....	32
3.1.15 Other parameters of characterisation.....	33
3.1.16 Summary on supplementary physicochemical characterisation ....	33
3.2 TOXICOKINETICS .....	35
3.2.1 Dermal / percutaneous absorption.....	35
3.2.2 Other studies on toxicokinetics .....	42
3.3 EXPOSURE ASSESSMENT .....	47
3.3.1 Function and uses.....	47
3.4 TOXICOLOGICAL EVALUATION.....	49
3.4.1 Acute toxicity .....	50
3.4.2 Irritation and corrosivity .....	54
3.4.3 Skin sensitisation.....	57
3.4.4 Repeated dose toxicity .....	60
3.4.5 Mutagenicity/genotoxicity .....	66
3.4.6 Carcinogenicity.....	77
3.4.7 Reproductive toxicity.....	77
3.4.8 Photo-induced toxicity .....	78
3.4.9 Human data.....	80
3.5 SAFETY EVALUATION (INCLUDING CALCULATION OF THE MOS) .....	81
3.6 DISCUSSION .....	81
4. CONCLUSION .....	82
5. MINORITY OPINION.....	83
6. REFERENCES.....	84
Annex 1.....	87

## 2. MANDATE FROM THE EUROPEAN COMMISSION

### Background

Article 2(1)(k) of Regulation (EC) No. 1223/2009 (Cosmetics Regulation) states that "nanomaterial" means an insoluble or biopersistent and intentionally manufactured material with one or more external dimensions, or an internal structure, on the scale from 1 to 100 nm. In addition, the Commission Recommendation of 2011 on the definition of nanomaterial specifically addressed the issue of Fullerenes by stating: 'By derogation from the above, fullerenes, graphene flakes and single wall carbon nanotubes with one or more external dimensions below 1 nm should be considered as nanomaterials'.

The nanomaterials definition covers materials in the nano-scale that are intentionally made and are insoluble/partially-soluble or biopersistent (e.g. metals, metal oxides, carbon materials, etc.). It does not cover those that are soluble or degradable/non-persistent in biological systems (e.g. liposomes, emulsions, etc.). Article 16 of the Cosmetics Regulation requires cosmetic products containing nanomaterials other than colorants, preservatives and UV-filters and not otherwise restricted by the Cosmetics Regulation to be notified to the Commission six months prior to being placed on the market. Article 19 of this Regulation requires nano-scale ingredients to be labelled (name of the ingredient, followed by 'nano' in brackets). If there are concerns over the safety of a notified nanomaterial, the Commission shall refer it to the Scientific Committee on Consumer Safety (SCCS) for a full risk assessment.

The Commission services received 19 notifications under Article 16 of the Cosmetics Regulation via the Cosmetic Product Notification Portal (CPNP) for cosmetic products containing Fullerenes, Hydroxylated Fullerenes (CAS/EC No.: 99685-96-8/628-630-7, 11538-22-7/-, 182024-42-6/-0), and hydrated forms of Hydroxylated Fullerenes (for example CAS / EC No.: 2803976-74-9/-)

According to the notifications submitted via the CPNP, Fullerenes, Hydroxylated Fullerenes and hydrated forms of Hydroxylated Fullerenes are used in cosmetic products with different concentration and specifications. These ingredients are reported in CosIng database with the function of 'antimicrobial' and 'skin conditioning-miscellaneous' and in the open literature as 'antioxidants' (scavenging ability against free radicals). Currently, Fullerenes, Hydroxylated Fullerenes and hydrated forms of Hydroxylated Fullerenes are not regulated under the Cosmetic Regulation (EC) No. 1223/2009.

The Commission has concerns on the use of Fullerenes, Hydroxylated Fullerenes and hydrated forms of Hydroxylated Fullerenes because of the potential for nanoparticles to be absorbed dermally or across a mucous membrane and to enter cells. Therefore, we request the SCCS to carry out a safety assessment of Fullerenes, Hydroxylated Fullerenes and hydrated forms of Hydroxylated Fullerenes reported in the notifications.

### Terms of reference

1. In view of the above, and taking into account the scientific data provided, does the SCCS consider Fullerenes, Hydroxylated Fullerenes and hydrated forms of Hydroxylated Fullerenes safe when used in cosmetic products according to the maximum concentrations and specifications as reported via CPNP, taking into account reasonably foreseeable exposure conditions?
2. Based on the currently available scientific literature and SCCS' expert judgement, the SCCS is requested to assess any further scientific concerns with regard to the use of Fullerenes, Hydroxylated Fullerenes and hydrated forms of Hydroxylated Fullerenes in cosmetic products and whether a potential risk to human health can be identified according to Article 16(6) Reg.1223/2009.



### 3. OPINION

#### Preamble

The information provided by the Notifiers through CPNP on the materials considered in this Opinion (Fullerenes, Hydroxylated fullerenes and Hydrated forms of hydroxylated fullerenes) was assessed by the SCCS, and further clarifications were requested where necessary. Additionally, a call for information was made and a literature search was performed by the Commission to obtain further information from other sources. In developing this Opinion, the SCCS has therefore also considered the responses received from the Notifiers, the information received in response to the Commission's call, and the results of the literature search.

It needs to be emphasised that the safety evaluations carried out by the SCCS are limited to cosmetic ingredients, and not formulations. Two of the notified materials, Radical Sponge® and Lipofullerene® are formulations and are, therefore, out of the scope for assessment in this Opinion. Radical Sponge® is a water-soluble polymer-enwrapped fullerene (PVP/C60 fullerene), and LipoFullerene® is an oil soluble fullerene in which fullerenes are dissolved in Squalene. Only the fullerenes present in these formulations (Radical Sponge® and LipoFullerene®) can be considered as basic cosmetic ingredients that are covered in this assessment as ingredients but not as part of a formulation.

The SCCS has not evaluated safety of fullerene materials via inhalation exposure because application in sprayable products or other products that could lead to inhalation exposure of the consumer is not supported by the Notifiers.

Following publication of the SCCS preliminary Opinion (SCCS/1649/23), the manufacturer of raw fullerene powder and the Notifier for hydrated hydroxylated fullerene (3HWC) provided further detailed information during the commenting period. The SCCS needs to emphasise that preliminary Opinions are published to invite comments and suggestions for finalisation of the Opinions that are based on the data that had been assessed in that Opinion, and not an opportunity to submit a new dossier. Therefore, the SCCS has only considered those issues that had been raised in the Preliminary Opinion, and the Notifiers will need to submit any other additional information to the Commission in a separate new submission.

#### 3.1 CHEMICAL AND PHYSICAL SPECIFICATIONS

##### 3.1.1 Chemical identity

###### 3.1.1.1 Primary name and/or INCI name

**Fullerenes:**

IUPAC name:

(C60-Ih) [5,6] fullerene

**Hydroxylated fullerenes:** C60(OH)<sub>x</sub> [where x has been reported to range 24-60]**Hydrated forms of hydroxylated fullerenes:**

INCI name: Hydroxylated Fullerene (and) Aqua, also termed as Hyperharmonized Fullerenol/Water Complex (HFWC).

Ref: 281\_safety\_file\_2020-3-12-18-44-18.pdf

### 3.1.1.2 Chemical names

**Fullerenes:**

Fullerene (C60),  
Fullerene(C70)

Ref: NANOMATERIALS SPECIFICATIONS\_ENGLISH\_Fullerene-V2

**Hydroxylated fullerenes: /**

**Hydrated forms of Hydroxylated Fullerenes: /**

### 3.1.1.3 Trade names and abbreviations

**Fullerenes: /**

**Hydroxylated fullerenes: /**

**Hydrated forms of hydroxylated fullerenes:**

Product name: 3HFWC, (or) HFWC

Ref: 281\_spec\_file\_2020-2-28-19-37-53

Ref: PRODUCT INFORMATION DOSSIER-Radical Sponge\_VC60 - V9

**SCCS comment**

Trade names were not provided for fullerene (C60 and C70) and hydroxylated fullerenes.

### 3.1.1.4 CAS / EC number

**Fullerenes:**

Fullerene C60: 99685-96-8/628-630-7

Fullerene C70: 115383-22-7/-

Ref: PRODUCT INFORMATION DOSSIER-Radical Sponge\_VC60 - V9; NANOMATERIALS  
SPECIFICATIONS\_ENGLISH\_Fullerene-V2;

<https://pubchem.ncbi.nlm.nih.gov/compound/Buckminsterfullerene#section=Related-CAS>

**Hydroxylated fullerenes:** 182024-42-6/-

**Hydrated forms of hydroxylated fullerenes:** 2803976-74-9/-

### 3.1.1.5 Structural formula



**Fullerenes:**

A polyhedral carbon structure composed of around 60-80 carbon atoms in pentagon and hexagon configuration. They are named after Buckminster Fuller because of structural resemblance to geodesic domes. Fullerenes can be made in high temperatures, such as arc discharge in an inert atmosphere.

**Fullerene C60 and fullerene C70:**

The molecular structures, shape and size of fullerene C60 and fullerene C70 are shown in Table 1, as given by the Notifier.

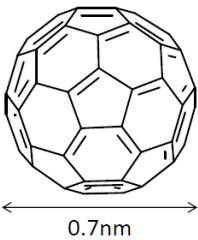
**Table 1:** Molecular structure, shape and size of Fullerenes C60, C70

	Fullerene C60	Fullerene C70
Molecular structure		
Shape	sphere	rugby-ball shape
Size	0.7 nm	Major-Axis 0.8 nm and minor-Axis 0.7nm

Fullerene C60 molecule is the most common fullerene with a spherical structure – a truncated icosahedron, like a football, and a molecular size of about 0.7 nm. Fullerene C70 has a short axis diameter of 0.7 nm like C60, but its long axis diameter is 0.8 nm, making it like a rugby ball.

Ref: <https://pubchem.ncbi.nlm.nih.gov/compound/123591>; NANOMATERIALS SPECIFICATIONS\_ENGLISH\_Fullerene-V2; Risk\_Assessment\_-\_Fullerenes\_NEDO\_Oct\_16\_2009

### Hydroxylated fullerenes:

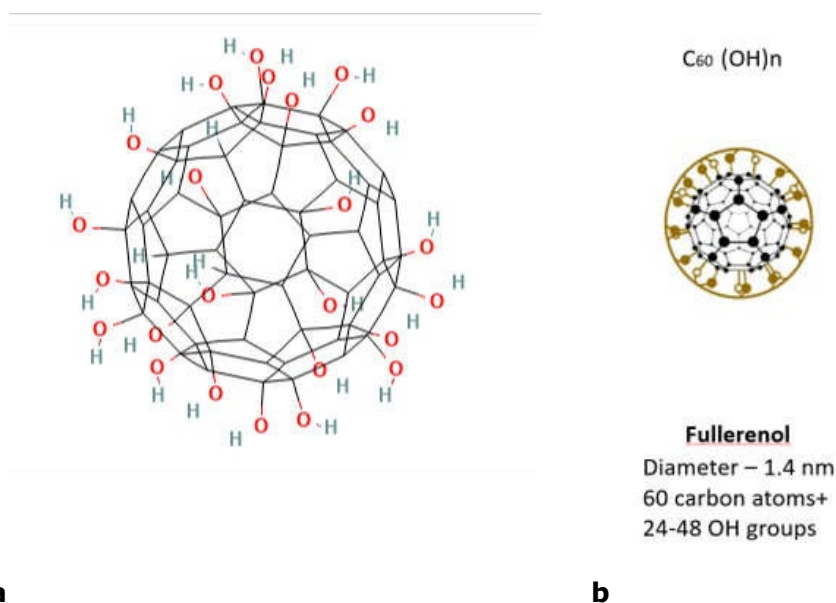

**Figure 1:** **a)** Structure of Hydroxylated fullerenes, and **b)** Hydroxylated fullerenes (Fullerenol) structure with numbers of OH groups, as given by the Notifier.

Ref: 06 HF Number of OH groups

### Hydrated forms of Hydroxylated Fullerenes:

According to one of the Notifiers, the ingredient used in the intended cosmetic formulation contains additionally functionalised fullerenol, an ingredient which qualifies as a nanomaterial according to the EU legislation. Polyhydroxylated fullerenes, known as fullerenols, are a class of fullerenes that have many hydroxyl groups, formed by the chemical modification of covalent C–O bonds, on their spherical surfaces. In recent years, they have gained a lot of attention due to their unique properties, their ability to bio-physically interact with biological

systems and their excellent antioxidant efficacy. Fullerenol and Harmonised Fullerenol-Water Complex (HFWC) substance are derived from the same spherical molecule (fullerene C<sub>60</sub>) with icosahedral symmetry, consisting of 60 carbon atoms. The addition of hydroxyl groups (OH group) to the surface of the fullerene sphere creates a hydroxylated fullerene [C<sub>60</sub>(OH)<sub>x</sub>] or fullerenol (Figure 2). The fullerenol molecule itself is in the form of powder and unlike fullerene, it is soluble in water and polar solvents. By additionally functionalising fullerenols by means of water molecules and energy that oscillates according to icosahedral symmetry, a Hyperharmonised Fullerenol-Water Complex (HFWC) is formed.

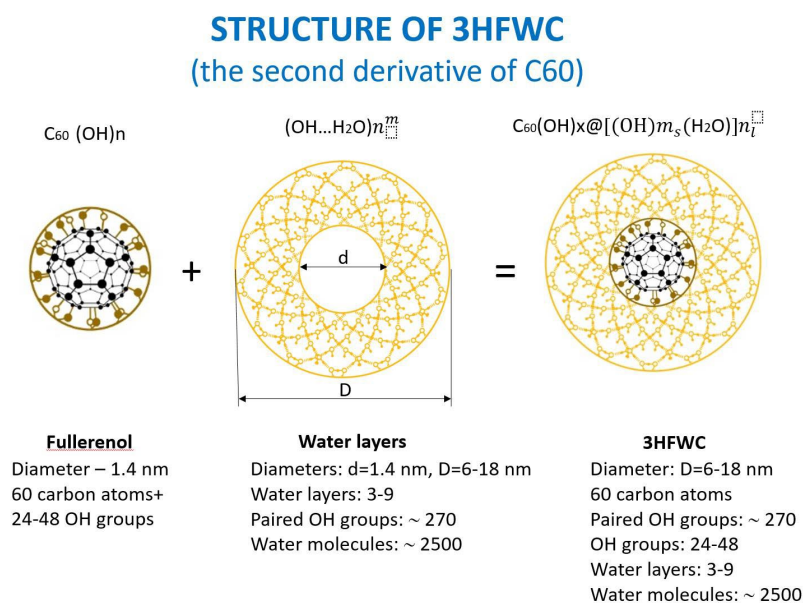

**Figure 2:** Structure, generated for 3HFWC by ACD/ChemSketch

This harmonised particle can be best described chemically as [C<sub>60</sub>(OH)<sub>x</sub> \* (H<sub>2</sub>O)<sub>n</sub>], where x describes the number of covalently bound hydroxy groups (x = 36±12) and n the number of water molecules surrounding the fullerenol and held in place and stabilised with hydrogen bonds under the influence of an oscillating magnetic field, according to the Fibonacci law (n = 144 - 2528). Through the harmonisation process, water layers, bound by hydrogen bonds, are formed around the fullerenol and have properties similar to liquid crystals (Figure 2).

**3HFWC:** 3H – hyper-harmonized-hydroxylated, F – fullerene core C<sub>60</sub>, W-water, C- complex stabilized with hydrogen bonds under the influence of oscillating magnetic field according to the Fibonacci law (F/f): [C<sub>60</sub>(OH)<sub>x</sub>@(H<sub>2</sub>O)<sub>y</sub>]F/f.

**3HFWC/HFWC** substance is a nanomaterial, without any covalent chemical modification, which is entirely based on hydroxylated fullerene (fullerenol) and water. Hydroxylated fullerene is based in the core of the substance, surrounded by water layers in the form of liquid crystalline. The substance retains as a particle in the formulation.

Ref: 281\_safety\_file\_2020-3-12-18-44-18.pdf; 281\_spec\_file\_2020-2-28-19-37-53

### SCCS comment

Despite a few exchanges of queries and clarifications between the SCCS and the Notifier, the basis for regarding 3HFWC as being a discretely different entity from other hydrated forms of hydroxylated fullerenes in terms of chemical identity/composition and physicochemical properties remains unclear. Therefore, for the purpose of this safety assessment, the SCCS has considered 3HFWC as equivalent to hydrated form of a hydroxylated fullerene – i.e. similar to other hydroxylated fullerenes when dispersed in aqueous media, for the following reasons:

1. From the Notifier's feedback, the SCCS understands that the linkage between water molecules and hydroxylated fullerene (the starting material used in the synthesis of 3HFWC) is hydrogen bonding in nature. Thus, in terms of chemical nature, there is little difference between 3HFWC and other hydroxylated fullerenes dispersed in water, except that a higher number of water molecules is claimed to be surrounding the core hydroxylated fullerene in 3HFWC.
2. The reported range of the number of surrounding water molecules (claimed to be in a coordinated structure) is very large (144 to 2528). This, in the absence of a justified scientific explanation for the nature of bonding involved (other than hydrogen bonding), casts further uncertainty over the exact chemical composition of this material, and the basis to regard it a discrete entity that is different from other hydroxylated fullerenes dispersed in aqueous media.
3. Further information provided by the Notifier during the commenting period claimed that hydrogen peroxide used in the manufacturing process of 3HFWC neither reacts with hydroxylated fullerene nor is available as an oxidising agent but is complexed between and as part of the hydration shells of 3HFWC. This is, however, not demonstrated by the Notifier, and indicates that the water sphere claimed to be surrounding hydroxylated fullerene is not entirely composed of water but an aqueous solution of hydrogen peroxide. In such a case, the interaction between H<sub>2</sub>O<sub>2</sub> and water molecules could only be due to hydrogen bonding, and not due to chemical bonding. Further evidence would be needed to support the claim that H<sub>2</sub>O<sub>2</sub> is not available for imparting any reactions/transformations of the starting material (hydroxylated fullerene) during the manufacturing process, or for causing any adverse cellular effects from use of the material in cosmetic products due to the formation of oxyradicals.

#### 3.1.1.6 Empirical formula

##### Fullerenes:

C<sub>60</sub>, C<sub>70</sub>

##### Hydroxylated fullerenes:

C<sub>60</sub>(OH)<sub>24-48</sub>

According to one for the Notifiers, the manufacturer specification for the empirical formula of hydroxylated fullerene is C<sub>60</sub>(OH)<sub>30-50</sub>

##### Hydrated forms of hydroxylated fullerenes:

3HFWC: C<sub>60</sub>(OH)<sub>36±12</sub>@(H<sub>2</sub>O)<sub>144-2528</sub>

According to one for the Notifiers, the empirical formula of 3HFWC is given as C<sub>60</sub>(OH)<sub>30-50</sub>@(H<sub>2</sub>O)<sub>144-2528</sub>

Ref: 281\_spec\_file\_2020-2-28-19-37-53; 06 HF Number of OH groups;  
10 Characterization 3HFWC

##### SCCS comment

The exact degrees of hydroxylation for hydroxylated fullerenes and their hydrated forms must be specified.

#### 3.1.2 Physical form

##### Fullerenes:

Morphology: solid

Agglomeration/aggregation state: aggregate

Ref: NANOMATERIALS SPECIFICATIONS\_ENGLISH\_Fullerene-V2

**Hydroxylated fullerenes:**

Physical form: Hydroxylated fullerene is a clear flowable liquid, as given by the Notifier. It is nearly colourless with a yellow shine, not comparable with RAL colour.

Ref: 02 Colour, odour and physical state HF

**Hydrated forms of hydroxylated fullerenes:**

Physical form: 3HFWC is a clear flowable liquid, as given by the Notifier. It is nearly colourless with a yellow shine, not comparable with RAL colour.

Ref: 02 Colour, odour and physical state HFWC

**3.1.3 Molecular weight****Fullerenes:**

C60: 720.60

C70: 840.77

Ref: Risk\_Assessment\_-\_Fullerenes\_NEDO\_Oct\_16\_2009

**Hydroxylated Fullerenes: /**

**Hydrated forms of Hydroxylated Fullerenes:** 3,826 – 47,126 g/mol

Ref: 10 Characterization 3HFWC

**SCCS comment**

Molecular weights of hydroxylated fullerenes were not provided. From the empirical formulae, these could be calculated to range between 1128.60 to 1536.60 g/mol of C<sub>60</sub>(OH)<sub>24-48</sub>, and 1248.77 to 1656.77 g/mol of C<sub>70</sub>(OH)<sub>24-48</sub>.

**3.1.4 Purity, composition, and substance codes****Fullerenes:**

Purity:

According to one of the Notifiers, the appearance of fullerene C60 (Lot 040406) was as a black powder. The IR spectrum of the fullerene C60 had absorbance at 526.5, 576.7, 673.1, 794.6, 1182,3 and 1427.2 cm<sup>-1</sup>. The purity of fullerene C60 was 66.4 ± 0.78 %, and C.V. 1.2%.

The content of fullerene C60 in three batches of the raw fullerene powder is described in Table 2a. Fullerene C60 was dissolved in toluene and the sample solution was analysed by HPLC with UV detection at 285 nm. The fullerene C60 content of raw fullerene powder was quantified under the same conditions and on the same day.

**Table 2a:** Purity of fullerene C60 in three batches

Sample	Amount of sample (mg)	Average peak area	C60 content (%)
standard	10.47	90.19	-
Lot 170529	10.04	62.17	71.9
Lot 190806	11.34	78.7	80.5
Lot 190701	11.41	75.09	76.2

Ref: C60 content of raw fullerene powder for cosmetics

According to one of the Notifiers, the raw fullerene powder is a mixture of C<sub>60</sub> and C<sub>70</sub>, and the content of C<sub>60</sub> measured by HPLC-UV in five batches ranges approximately from 70 to 80%.

Ref: NANOMATERIALS SPECIFICATIONS\_ENGLISH\_Fullerene-V2; Appendix 3 Manufacturing Process, Composition and Properties of Raw Fullerene Powder; B040337\_Characteristics Analysis Study of Fullerene

During the commenting period, additional data on purity on five representative batches of raw fullerene powder have been submitted to the SCCS. The contents of fullerene C<sub>60</sub> and Fullerene C<sub>70</sub> in five batches of the raw fullerene powder are summarized in the Table below.

**Table 2b:** Contents (%Area) of fullerene C<sub>60</sub> and fullerene C<sub>70</sub> in five batches of the raw fullerene powder

Lot #	Percentage of peak area		
	C <sub>60</sub>	C <sub>70</sub>	Total of other peaks
151104	80	15	5
160815	80	14	6
170531	81	15	4
170529	80	15	3
180413	84	13	3

The contents of fullerenes are expressed using percentage of peak area of each fullerene against total peak area in the HPLC chromatogram. This treatment is due to the fact that the submitter could not obtain working standards for C<sub>70</sub>, C<sub>60</sub> oxide, C<sub>70</sub> oxide as well as higher order fullerenes.

#### SCCS comment

It is unclear why the batch (Lot 170529) in Table 2a contains 62.17% (in terms of % area) or 71.9% (in terms of content) of fullerene C<sub>60</sub>, while in the newly submitted Table 2b the same batch (Lot 170529) contains 80% fullerene C<sub>60</sub>, and 15% fullerene C<sub>70</sub>. Data in Table 2b indicate that all the lots contain 3 to 6% of other peaks (impurities).

#### Hydroxylated fullerenes:

According to the Notifier, the purity of the test item was determined as 99.9% by chromatography.

Ref: 10 Characterization HF

#### IR spectroscopy

According to one of the Notifiers, IR spectroscopy was used to calculate the number of -OH groups for hydroxylated fullerene C<sub>60</sub>(OH)<sub>30-50</sub>, batch no 20H0229A according to the method of the DIN EN ISO 4629-2:2016 (hydroxyl value) standards. This method can be applied to resins, binders for coating materials, primary alcohols, glycols and fats. The results are given in mg KOH/g sample. The number of hydroxyl groups was determined as ≈ 40. IR main absorbance bands with structural assignments are presented in Table 3.



**Table 3:** IR main absorbance bands with structural assignments of the solid test item (hydroxylated fullerene C<sub>60</sub>(OH)<sub>30-50</sub>, batch no 20H0229A), as given by the Notifier

Wavenumber (cm <sup>-1</sup> )	Transmission (%T)	Structural Assignment Vibrations
3357.68	92.89	ν OH
1582.01	69.55	ν C-C
1323.91	71.06	δ OH, ν C-O
777.72	75.20	
513.04	66.27	

As concluded by the Notifier, all the typical vibrations such as ν OH water and ν C-C were found in the IR. The observed absorption bands correlate excellent with the existing reference spectrum of Fullerenol.

Ref: 06 HF Number of OH groups

### Elemental Analysis

Elemental analysis data, as reported by the Notifier, are presented in Table 4.

**Table 4:** Elemental analysis data of hydroxylated fullerene

Parameter	Experimental value	Calculated on: C <sub>60</sub> (C <sub>60</sub> (OH) <sub>30-50</sub> )
C	50.45	51.44 %
	50.40	
H	2.02	2.87 %
	2.05	
O	48.6	45.68 %
	48.7	

Ref: 06 HF Number of OH groups

### Gel permeation Chromatography (GPC)

According to the Notifier, the peak-area report of GPC shows three different separated peaks.

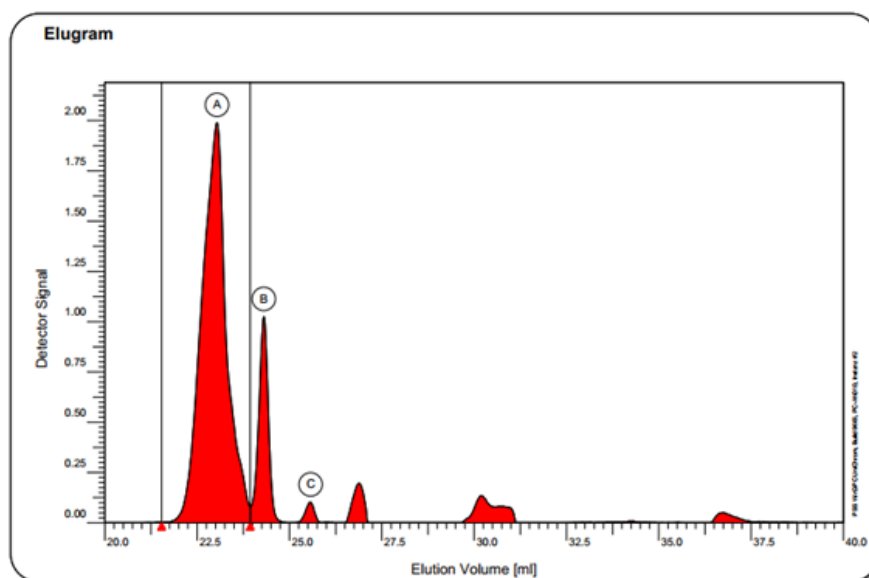

**Figure 3:** Elugram of Hydroxylated Fullerene

The relative content of each "species" and the molar mass at the peak maximum, M<sub>p</sub>, is listed in the table below.



**Table 5.** Gel permeation chromatography data for hydroxylated fullerene

	Molar mass at the peak maximum (Mp), Da / Peak Area %
Peak A	48819/ 82.04%
Peak B	22462/ 16.43%
Peak C	10232/ 1.53%
Peak D	/

Ref: 10 Characterization HF

**LC-MS**

According to the Notifier, the LC-MS showed one peak for the test item, hydroxylated Fullerene. MS spectra were extracted from TIC chromatograms obtained by using ESI (+) and ESI (-) ion mode. The LC-MS observes and detects a fragmentation about m/z 68 which correlate with 4 OH-groups. The range of measurements of LC-MS is limited at m/z 2000, therefore, no further OH-groups can or could be observed.

Ref: The Regulatory Company – 3HFWC data submission main document; 10 Characterization HF

**Hydrated forms of hydroxylated fullerenes**

According to the Notifier, the amount of water was determined as 99.5% by the Karl-Fischer method and the concentration of 3HFWC in water as 0.5%. The purity of this concentration of 0.5% in water was determined as >99.9 by chromatography, no further impurities were observed.

Ref: 10 Characterization 3HFWC

The composition information of HFWC is presented in Table 6.

**Table 6.** Composition information of HFWC, as given by the Notifier

Components	Chemical formula	%
Hydroxylated fullerenes	C <sub>60</sub> (OH) <sub>24-48</sub>	0.015
Ultra-pure water	H <sub>2</sub> O	99.985

Ref: 281\_spec\_file\_2020-2-28-19-37-53

**Determination of the content of active ingredient in five batches of 3HFWC by HPLC**

According to the Notifier, the test item, 3HFWC, is a fullerene with a 30 – 50 covalently attached hydroxyl groups and further coordinated with 144 – 2528 water molecules. The composition of the test item is hydroxylated fullerene C<sub>60</sub> 0.015 % and ultra-pure water (0.055 µS/cm) 99.985 %. The SANCO 3030/99 rev. 5 guideline requires an analytical method which is specific for the active ingredient. Method development was performed for the dry active ingredient (hydroxylated fullerene) using HPLC coupled to UV and mass spectrometric detection. Column types ranging from C18 (separation based on hydrophobic interaction) to HILIC (separation based on hydrophilic interaction) were tested. Under no tested conditions was retention achieved. The test item showed one peak at or even before the dead time of the tested column. This indicated that, due to the large aqueous solvation shell, the target

molecule is not able to interact with the column material and/or is too large to enter the pores of the column materials. Experiments were then performed by gel permeation chromatography.

Ref: 09 Active ingredient 3HFWC HPLC

### Gel- Permeation Chromatography (GPC)

According to the Notifier, fullerenes are expected to exhibit UV activity and calculations of molar mass distributions have only been carried out for the UV active species. Peak areas of RI signal of side components have been analysed as well. Analysis of the UV signal at 250 nm revealed that the sample solutions contain a UV active main component and different side components, that eluted in the relevant elution volume area for GPC analysis. Three peaks and their observed masses are within the calibration curve, and one is out (peak D) of the calibration curve.

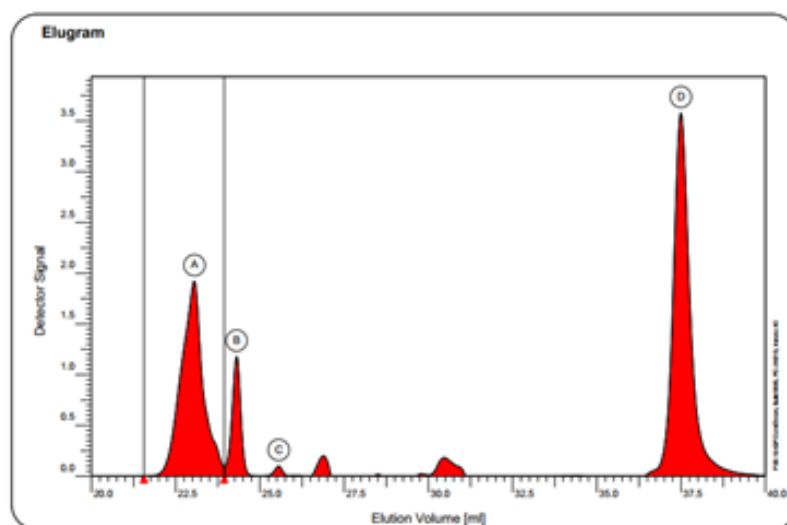

**Figure 4:** Elugram of 3HFWC

According to the Notifier, the mass of the peak D cannot be determined, but it should be more hydrophilic than the test item "3HFWC". Peaks at elution volumes of appr. 27 and 31 mL are presumably system peaks. The test item 3HFWC contains an additional, UV active component which elutes outside of the GPC calibrated range (appr. 37.5 mL). Hence, no molar mass result has been calculated for the substance. Size distribution was found to be corresponding to the range 10314 to 48213 g/mol (Table 7). Due to very broad peaks in this methodology, it is not suitable for sensitive quantitative analysis.

**Table 7.** Gel permeation chromatography data for 3HFWC

	Molar mass at the peak maximum (Mp), Da / Peak Area %
Peak A	48213/ 35.77%
Peak B	22409/ 9.02%
Peak C	10314/ 0.71%
Peak D	Out of calibration range / 53.49%

Ref: 09 Active ingredient 3HFWC HPLC; Ref: The Regulatory Company – 3HFWC data submission main document; 10 Characterization HFWC

**NMR data**

According to the Notifier, the recording of  $^1\text{H-NMR}$  spectra was only feasible with water suppression. The first spectra were performed with tetramethylsilane as standard, but the broad signal of TMS made it difficult to separate the peaks for the integrations. Therefore, the recording of the NMR spectra was repeated without TMS, which is the log signal, in the hope that more precise signals might be received for the integration. The chemical shift at about 8.5 ppm in the  $^1\text{H-NMR}$  can be assigned as Fullerenol C60 with more hydroxylic groups. This conclusion is based on the high value of the integral which increased from 3.57 (3HFWC) to 15.38 OH-groups. The factor of the integral can be assumed as approximately 5. Through the high symmetry and the water layers, only one signal was observed, at about 8.458 ppm of the hydroxylic groups in 3HFWC.

The difference between 3HFWC and Hydroxylated Fullerene are marked in Table 8. The integral high at about 8.5 ppm was determined in 3HFWC as 3.57 and in Hydroxylated Fullerene as 15.38. The sum of all other protons was determined in 3HFWC as 96.44 and in Hydroxylated Fullerene as 84.41. The total sum of all kinds of protons was determined as approximately 100.

**Table 8:** NMR data of 3HFWC and Hydroxylated Fullerene with and without Tetramethylsilan (TMS)

$^1\text{H-NMR}$ data with TMS			
3HFWC with TMS chemical shift / ppm	3HFWC with TMS integral	Hydroxylated Fullerene with TMS chemical shift / ppm	Hydroxylated Fullerene with TMS integral
		10.027	0.02
8.458	0.22	8.770 – 5.490	6.04
3.774 – 3.741	15.25	4.385 – 0.868	93.80
3.123	3.95		
2.849	2.18		
2.612 – 2.158	10.04		
1.921 – 2.158	44.63		
1.280 – 1.039	4.18		
-0.050 – -0.060	19.55	-0.007 – -0.055	0.14
$^1\text{H-NMR}$ data without TMS			
3HFWC without TMS chemical shift / ppm	3HFWC without TMS integral	Hydroxylated Fullerene C60 without TMS chemical shift / ppm	Hydroxylated Fullerene C60 without TMS integral
		10.027	0.05
8.459	3.57	8.765 – 4.811	15.38
3.123	11.81	4.537 – 1.108	84.41
2.851 – 2.075	44.59		
1.921	22.70		
1.342 – 0.899	17.34		
<b>Sum of protons (marked)</b>	<b>96.44</b>		
Sum total of protons	100.01		99.79

**LC-MS data**

MS spectra were extracted from TIC chromatograms obtained using ESI (+) and ESI (-) ion mode. According to the Notifier, the LC-MS observes and detects a fragmentation about  $m/z$  68 which correlate with 4 OH-groups. The range of measurements of LC-MS is limited at  $m/z$  2000, therefore, non-further OH-groups can or could be observed.

Ref: 10 Characterization 3HFWC

During the commenting period, the Notifier for 3HFWC reported that the test substance is stabilized by a small percentage of  $\text{H}_2\text{O}_2$ . According to the Notifier,  $\text{H}_2\text{O}_2$  neither reacts with hydroxylated fullerenes nor is available as an oxidising agent but it is complexed with hydroxylated fullerenes as part of the hydration shells of 3HFWC. The amount of total

oxidizing substances (expressed as hydrogen peroxide) present in 3HFWC is 0.04% and this content is in line with the current regulations for cosmetic products (<0.1%).

Formula	Substance	%
C <sub>60</sub> (OH) <sub>30-50</sub>	Hydroxylated fullerene C60 C=0.15 g/L	0.15
H <sub>2</sub> O	Ultra-pure water (0,055 µS/cm)	99.955
H <sub>2</sub> O <sub>2</sub>	Hydrogen peroxide	0.030

### SCCS comment

According to the Notifiers, raw fullerene powder is a mixture of fullerenes C60 and C70, and the content of fullerene C60 measured in five batches ranges approximately from 70 to 80%. Data on the exact content of fullerene C70 were not provided.

One of the Notifiers has reported that retention of 3HFWC was not achieved by any HPLC method and also that the GPC method is not suitable for sensitive quantitative analysis. Based on these findings, the SCCS understands that the accurate quantitation of 3HFWC cannot be achieved by any of the reported analytical methods.

The composition of 3HFWC is provided in Table 6, by measuring the content of hydroxylated fullerenes and water, and in Table 9, by including the estimated percentage of hydrogen peroxide; this further supports the conclusion of the SCCS that, in terms of chemical composition, 3HFWC is a hydrated form of hydroxylated fullerene - similar to other hydroxylated fullerenes dispersed in aqueous media - with an additional proportion of hydrogen peroxide.

Considering the manufacturing process of 3HFWC, the SCCS is of the opinion that the theoretical percentage of hydrogen peroxide (0.03%) reported by the Notifier is not accurate. The provided explanation suggests that hydrogen peroxide is largely associated with the hydroxyl groups of the core hydroxylated fullerene, whereas percentage of H<sub>2</sub>O<sub>2</sub> is calculated based on dispersion of the material in water, which would also include (large amounts of) 'uncoordinated' water. Also, the Notifier's claim that H<sub>2</sub>O<sub>2</sub> neither reacts with hydroxylated fullerenes nor is available as an oxidising agent but is complexed between and as part of the hydration shells of 3HFWC, is not demonstrated by any supporting evidence. Considering the hydrogen bonding nature of the interaction of H<sub>2</sub>O<sub>2</sub> and the water molecules surrounding hydroxylated fullerene, the SCCS considers that the so-called water sphere is not entirely composed of water but an aqueous solution of hydrogen peroxide.

### 3.1.5 Impurities / accompanying contaminants

#### Fullerenes:

Fullerene (C60) [65%],

Fullerene(C70): /

Coatings or surface moieties: None

Doping material: None

Encapsulating materials: None

Processing chemicals: None

Dispersing agents: None

Stabilizers: None

Other additives: None

According to one of the Notifiers, the concentration of other fullerenes such as C82 and oxygenated fullerene was less than 1% in 5 batches of raw fullerene powder, and no impurities derived from raw fullerene powder were detected with liquid chromatography. Since toluene is used in the extraction of raw fullerene powder, the residual amount of toluene

was also measured and the values were much lower than the residual tolerance, i.e. 890 ppm, specified in the ICH guideline.

It is stated by the Notifier(s) that in fullerenes formulations, heavy metals should be not more than 20 ppm, arsenic should be not more than 2 ppm, and the residue on ignition should be not more than 0.1%.

Ref: NANOMATERIALS SPECIFICATIONS\_ENGLISH\_Fullerene-V2; Appendix 3 Appendix 3  
Manufacturing Process, Composition and Properties of Raw Fullerene Powder

During the commenting period the SCCS has received additional data on the method of manufacturing and on impurities and of raw fullerene powder. The raw fullerene powder was synthesised using a scaled-up version of the method reported by Scrivens *et al.* (1992).

A typical certificate of analysis of a raw fullerene powder batch (Lot No 230320) provided by the manufacturer, shows that residual content of lead and arsenic was less than 1 ppm and 0.1 ppm, respectively. It also shows that the content of toluene was 89 ppm which satisfies its criteria, i.e., less than 890 ppm, that was specified by ICH-Q3C for toluene. Other fullerene related impurities were already introduced in the purity section. There is no possibility that carbon nanotubes and amorphous carbon as well as other organic small molecules are contained in the raw fullerene powder.

A typical chromatogram of the raw fullerene C60 powder (Lot. No. 160815) is shown in Figure 5. The chromatogram shows that the raw fullerene powder mainly contains C60 and C70 as well as oxides of C60 and C70 oxide and higher order fullerenes such as C82 and C88.

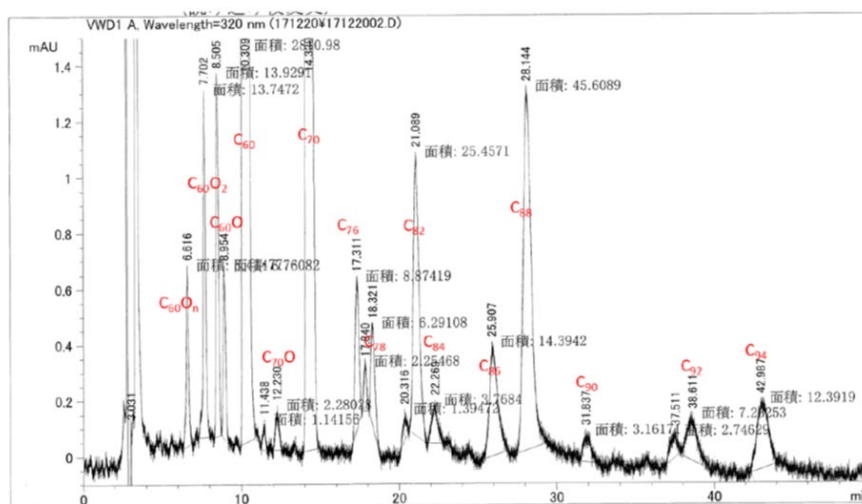

**Figure 5:** Typical chromatogram of raw fullerene C60 powder (Lot. No. 160815)

### Hydroxylated fullerenes

According to the Notifier, the amount of water (moisture) was determined as 99.1% by the Karl-Fischer method.

Ref: 10 Characterization HF

### Hydrated forms of Hydroxylated Fullerenes

According to the Notifier, the amount of water was determined as 99.5% by the Karl-Fischer method. Based on the data submitted by the Notifier and as reported in the purity section of this Opinion, no further impurities were observed.

During the commenting period, the SCCS has received additional data on the method of manufacturing and on impurities and of 3HFWC.

According to the Notifier, no significant concentrations of heavy metals or organic solvents were detected in the aqueous solution of 3HFWC.

Ref: 10 Characterization 3HFWC

**SCCS comment**

From the limited data provided relating to the impurities of fullerenes, the SCCS has noted the presence of fullerene epoxides as byproducts of fullerene synthesis. Epoxides are generally unstable and highly reactive. HPLC method showed the presence of various impurities in the range 3 to 6% (% peak area) in raw fullerene powder, however this technique is not suitable for the chemical characterisation of epoxides. The chemical characterisation (exact chemical formulae and percentage) of fullerene epoxides impurities that are present in raw fullerene powder by an appropriate identification technique, is necessary for the safety evaluation.

The Notifiers have not provided detailed information on the levels of impurities, heavy metals, accompanying contaminants and organic solvents, for hydroxylated fullerenes and the hydrated forms of hydroxylated fullerenes. The chemical characterisation of impurities by an appropriate identification technique needs to be provided.

**3.1.6 Solubility****Fullerenes:**

It is stated by the Notifier(s), that fullerene is a strong hydrophobic substance which is insoluble in aqueous media.

Ref: NANOMATERIALS SPECIFICATIONS\_ENGLISH\_Fullerene-V2

Data of the solubility of fullerenes C60 and C70 in various solvents are presented in Table 10, as submitted by the Notifier(s).

**Table 10.** Solubility of fullerenes C60 and C70

Opinion on Fullerenes, Hydroxylated Fullerenes and hydrated forms of Hydroxylated Fullerenes (nano)

SOLUBILITY OF C <sub>70</sub> AND C <sub>60</sub> IN ORGANIC SOLVENTS						References
		C-70		C-60		Sivaranam <i>et al.</i> , 2006
Solvent	µg/ml	MF	µg/ml	SP	n	
1. Pentane	2	0.00268	4	14.52	1.358	
2. Hexane	13	0.02074	40	14.85	1.380	
3. Heptane	47	0.08258	**	15.10	1.387	
4. Octane	42	0.08037	25	15.45	1.392	
5. Isooctane	**	**	26	14.17	1.398	
6. Decane	53	0.12208	70	15.81	1.411	
7. Dodecane	98	0.26399	91	16.07	1.422	
8. Tetradecane	**	**	126	16.24	1.428	
9. Cyclohexane	80	0.1030	51	16.77	1.426	
10. Acetone	1.9	0.0017	**	20.00	1.359	
11. Isopropanol	2.1	0.0020	**	23.70	1.377	
12. Dioxane	**	**	41	20.50	1.423	
13. CCl <sub>4</sub>	121	0.1390	447	17.59	1.460	
14. p-Xylene	3985	5.8127	**	18.00	1.496	
15. Mesitylene	1472	2.4373	997	18.04	1.498	
16. Toluene	1406	1.7785	2150	18.20	1.497	
17. Benzene	1300	1.3829	1440	18.82	1.501	
18. CS <sub>2</sub>	9875	7.065	5160	20.50	1.627	
19. Dichloro-methane	80	0.0610	254	20.00	1.424	
20. p-Dichloro-benzene	36210	48.286	**	20.50	1.550	
MF : Mole Fraction*10 <sup>4</sup> n : Refractive Index						
** : Solubility not measured						
SP: Hildebrand's Solubility Parameter (δ) (J <sup>1/2</sup> .cm <sup>-3/2</sup> )						
Solubility of C <sub>60</sub> fullerene (mg/L)						Cataldo and Braun, 2007
Brassica methyl ester (biodiesel)				187 mg/L		
Sunflower triglyceride				116 mg/L		
Soybean triglyceride				134 mg/L		
Linseed triglyceride				91 mg/L		
Olive triglyceride				173 mg/L		



## Opinion on Fullerenes, Hydroxylated Fullerenes and hydrated forms of Hydroxylated Fullerenes (nano)

Solubility of C <sub>60</sub> in various solvents				A. Hirsch and M. Brettreich, 2005
Solvent	[C <sub>60</sub> ] (mg mL <sup>-1</sup> )	Mole fraction ( $\cdot 10^4$ )	<i>n</i>	
<i>n</i> -Pentane	0.005	0.008	1.36	
<i>n</i> -Hexane	0.043	0.073	1.38	
Cyclohexane	0.036	0.059	1.43	
<i>n</i> -Decane	0.071	0.19	1.41	
Decalines	4.6	9.8	1.48	
Dichloromethane	0.26	0.27	1.42	
Carbon disulfide	7.9	6.6	1.63	
Dichloromethane	0.26	0.27	1.42	
Chloroform	0.16	0.22	1.45	
Tetrachloromethane	0.32	0.40	1.46	
Tetrahydrofuran	0.000	0.000	1.41	
Benzene	1.7	2.1	1.50	
Toluene	2.8	4.0	1.50	
Tetraline	16	31	1.54	
Benzonitrile	0.41	0.71	1.53	
Anisole	5.6	8.4	1.52	
Chlorobenzene	7.0	9.9	1.52	
1,2-Dichlorobenzene	27	53	1.55	
1-Methylnaphthalene	33	68	1.62	
1-Chloronaphthalene	51	97	1.63	
Acetone	0.001	0.001	1.36	
Methanol	0.000	0.000	1.33	

Ref: Appendix 2 Physicochemical Properties of Fullerenes C60 and C70

**Hydroxylated fullerenes**

Water solubility: Since the test item, hydroxylated fullerene (batch no. 20H0229A) is the dry material for an aqueous formulation, the solubility of the test item in water was performed using a simplified flask method. In this case it was not possible to weigh the fivefold saturation concentration of the test item in water to perform a main test following OECD 105. The results of the main test indicate that hydroxylated fullerene is miscible with water in all proportions. The calculated concentration of the test item in the test solutions corresponds to the nominal load of the test item 150 mg/L (146.4 – 157.6 mg/L). In the flasks 4 and 5, higher concentrations were measured as the determination of DOC is less precise in the low range (< 10 mg/L).

Ref: 08 Water solubility HF

**Hydrated forms of Hydroxylated Fullerenes**

Solubility/dissolution (in relevant solvents): /

Water solubility: Since the test item 3HFWC (batch 01-2021-10-14) is an aqueous formulation, the solubility of the test item in water was performed using a simplified flask method. In this case it was not possible to weigh the fivefold saturation concentration of the test item in water to perform a main test following OECD 105. The results of the main test indicate that hyperharmonized hydroxylated fullerene water complex (3HFWC) is miscible with water in all proportions. The calculated concentration of the test item in the test solutions corresponds to the nominal concentration of the test item 150 mg/L (141.3 – 161.6 mg/L). In the flask, 5 higher concentrations were measured as the determination of DOC is less precise in the low range (< 5 mg/L).

N-Octanol (mg/L): n.a.

Ref: 281\_spec\_file\_2020-2-28-19-37-53; 08 Water solubility 3HFWC



**Additional solubility data – SCCS literature search**

A literature search by the SCCS has indicated that fullerenes are practically insoluble in water, whereas hydroxylated fullerenes are soluble in water.

The calculated solubility of fullerene C60 in water at 25°C is  $7.42 \times 10^{-6}$  mg/L (water-phase of water-octanol), based on measured values in octanol (of octanol-saturated water phase) and octanol-water partition coefficient. Solubilities in various solvents at 25 °C range from 1.4 mg/L in ethanol to 2430 mg/L in water-saturated toluene and 3000 mg/L in toluene, (Jafvet *et al.*, 2008). Water solubility is also reported to be greatly increased by the addition of hydroxyl groups either to the cage (giving fullerenols) or having them present in addends (Li *et al.*, 2013).

Fullerenes are also virtually insoluble in acetone, ethers, alcohols (Taylor, 2001) and other polar solvents, sparingly soluble in alkanes, while appreciably soluble in aromatic solvents and in carbon disulfide. The solubility of fullerene C60 in a number of solvents ranges from 0.0 g/L in methanol and tetrahydrofuran, to 41 g/L in 1-chloronaphthalene (Cadek *et al.*, 1999).

Ruoff *et al.* (2003) have determined solubility of pure fullerene C60 in 47 solvents at room temperature. These range from 0.01 g/L in methanol to 50 g/L in 1-chloronaphthalene. The solubilities in CS<sub>2</sub>, toluene, and hexane, three of the commonly employed solvents, are 7.9, 2.8, and 0.04 g/L, respectively.

**3.1.7 Partition coefficient (Log P<sub>ow</sub>)****Fullerenes:**

Log P<sub>o/w</sub>: /

Fullerene C60 log K<sub>o/w</sub> = 6.67

Fullerene C60 toluene-water partition coefficient, log K<sub>T/W</sub>: 8.44

Ref: <https://www.bioactivec60.com/wp-content/uploads/2016/06/Fullerene-C60-C60-PubChem.pdf>; Jafvert CT, Kulkarni PP; Environ Sci Technol 42: 5945-5950 (2008)

**Hydroxylated fullerenes: /****Hydrated forms of Hydroxylated Fullerenes:**

Octanol/water partition coefficient: P<sub>o/w</sub> = 0.18941

Log P<sub>o/w</sub> = -0.72

Ref: 281\_spec\_file\_2020-2-28-19-37-53

**SCCS comment**

Log P<sub>o/w</sub> values for hydroxylated fullerenes should be provided.

**3.1.8 Additional physical and chemical specifications****Fullerenes:**

<b>Table 11.</b> Additional physicochemical properties of Fullerene C60 and Fullerene C70.			
	<b>Fullerene C60</b>	<b>Fullerene C70</b>	<b>Ref.</b>
Molecular Structure [nm]	0.704 (Frame) 1.002 (Electron Cloud)	0.796 (Transverse Diameter) 0.712 (Conjugate Diameter)	Ahmad, 1999.

## Opinion on Fullerenes, Hydroxylated Fullerenes and hydrated forms of Hydroxylated Fullerenes (nano)

Electron Affinity [eV]	2.65	2.72	
Melting Point [°C]	1180	No data	Beckhaus <i>et al.</i> , 1992.
Electric Conductivity (300K) [S/cm]	$10^{-8} \sim 10^{-14}$	No data	Arai <i>et al.</i> , 1992; Mort <i>et al.</i> , 1992.
Sublimation Heat [kcal/mol]	40, 38	43, 45	Pan <i>et al.</i> , 1991.
Vapor Pressure [Torr]	1.9 x 10 <sup>-5</sup> (400 °C) 5 x 10 <sup>-4</sup> (500 °C) 1 x 10 <sup>-3</sup> (600 °C)	1.4 x 10 <sup>-5</sup> (430 °C) 2 x 10 <sup>-4</sup> (500 °C) 7 x 10 <sup>-3</sup> (600 °C)	Abrefah and Olander, 1992

According to one of the Notifiers, the appearance of Fullerene C60 (Lot 040406) was as a black powder.

Ref: Risk\_Assessment\_-\_Fullerenes\_NEDO\_Oct\_16\_2009

### Hydroxylated fullerenes:

Melting point: 101.59 ± 0.14 °C (374.74 K)  
 Colour: The test substance is nearly colourless with a yellow shine, not comparable with RAL colour.  
 Determination of Odour: No odour was detectable.  
 Flash point: No flash point could be detected up to 100 °C. Therefore, no flash point could be established.  
 Viscosity: 1.005 ± 0.004 mPa·s at 20.00 ± 0.02 °C

Ref: 05 Viscosity HF; 02 Boiling point HF; 02 Colour, odour and physical state HF; 04 Flash point HF

### Hydrated forms of Hydroxylated Fullerenes:

According to the Notifier, the Hydrated forms of Hydroxylated Fullerenes are formed by mixing the hydroxylated fullerene [ $C_{60}(OH)_x$ ] with ultrapure water (grade 2), and then water layers are generated and stabilised by oscillatory magnetic field: [ $C_{60}(OH)_x@(H_2O)nlf$ ] (n is number of water molecules, l is number of water layers and f is number of frequency modes). Before mixing with water, hydroxylated fullerene is pre-treated with heating (drying) and the UV-Vibro apparatus (prevention of agglomeration and aggregation process).

Melting point: 102.07 ± 0.14 °C (375.22 K)  
 Colour: The test substance is nearly colourless with a yellow shine, not comparable with RAL colour.  
 Determination of Odour: No odour was detectable.  
 Flash point: No flash point could be detected up to the boiling stage of 102.4 °C in the pre-test. Therefore, no flash point could be established.  
 Viscosity: 1.007 mPa·s at 20.00 ± 0.02 °C

Ref: 281\_spec\_file\_2020-2-28-19-37-53; Risk\_Assessment\_-\_Fullerenes\_NEDO\_Oct\_16\_2009; The Regulatory Company - 3HFWC data submission main document; 01 Boiling point 3HFWC; 02 Colour, odour and physical state 3HFWC; 04 Flash point 3HFWC; 05 Viscosity 3HFWC

### SCCS comment

More detailed information about composition and manufacturing procedure of the hydrated forms of hydroxylated fullerenes was provided during the commenting period for the preliminary opinion.

This has been discussed in Section 3.1.5.

**3.1.9 Particle size****Fullerenes\*:**

The following data were submitted by the Notifier:

Lowest cut-off level (nm):

Volume weighed median: 0.7 nm (C60)

Number weighed median: 0.7 nm (C60)

\* Since fullerene is a molecule, the primary particle size is the same as the molecular size.

According to one of the Notifiers, Fullerene C70 (Table 1) is a rugby-ball shaped particle with major axis 0.8 nm and minor axis 0.7 nm.

Ref: NANOMATERIALS SPECIFICATIONS\_ENGLISH\_Fullerene-V2;  
<https://pubchem.ncbi.nlm.nih.gov/compound/123591>

**Hydroxylated fullerenes:** 2.0 ± 0.6 nm

According to one of the Notifiers, hydroxylated fullerenes can be clustered, forming large agglomerates.

Ref: The Regulatory Company - 3HFWC data submission main document;  
10 Characterization HF

**Dynamic light scattering**

Dynamic Light Scattering for hydroxylated fullerenes is presented in the next Figure, as given by the Notifier.

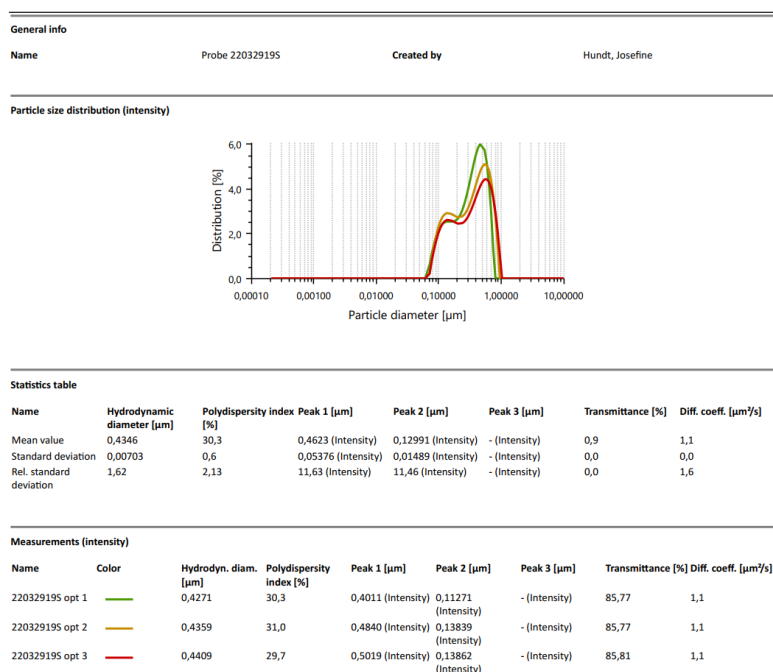
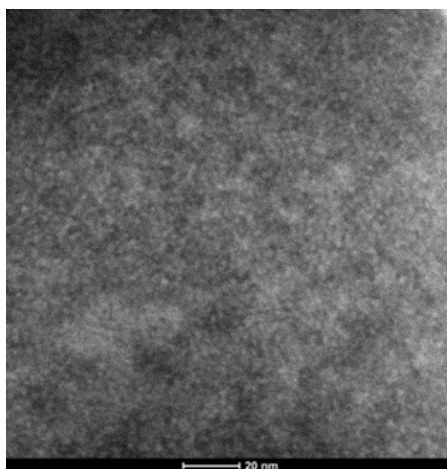

**Figure 6:** Dynamic Light Scattering for hydroxylated fullerenes.

**Particle Size Distribution****- Particle size distribution by scanning transmission electron microscopy (STEM) method:**

As reported by the Notifier, High-angle annular dark-field (HAADF) scanning transmission electron microscopy (STEM) carried out on a FEI Osiris ChemiSTEM microscope at 200 keV

was employed for investigation of the size, the shape and the chemical composition of the test item (Hydroxylated Fullerene).



**Figure 7:** Images of the test item Hydroxylated Fullerenes captured with a HAADF-STEM at 200 keV

According to the Notifier, the constituent particles of the test item are expected to have a diameter between 0.7 and 1.4 nm. It was not possible to clearly identify single constituent particles due to blurred borders of the particulate structures. The particles were expected to be clustered, forming large agglomerates. The visible nanostructures have diameters of approximately  $2.0 \pm 0.6$  nm, which is above the expected size, but in the same order of magnitude.

Ref: LAUS, Report Aug.2022.

### Zeta potential by electrophoretic light scattering (ELS)

ELS data are presented in the table below as given by the Notifier.

**Table 12:** ELS data for hydroxylated fullerene

Test item	Temperature [°C]	Zeta potential [mV]	Electrophoretic mobility [ $\mu\text{m/s}/(\text{V/cm})$ ]	Conductivity [mS/cm]
Hydroxylated Fullerene	25 °C	$-25.85 \pm 1.71$	$-2.01 \pm 0.13$	0.18

Ref: 10. Characterization HF

### Hydrated forms of Hydroxylated Fullerenes:

**Primary particle size**, as given by the Notifier

1. Lowest cut-off level (nm) value: 6 nm.
2. Volume weighted median (nm) min: 8.66 nm; max: 18.06 nm
3. Number weighted median (nm) min: 8.66 nm; max: 18.06 nm

### Secondary particle size

There is no secondary particle size

Ref: 281\_spec\_file\_2020-2-28-19-37-53

### Dynamic Light Scattering

Dynamic Light Scattering for 3HFWC is presented in the next Figure, as given by the Notifier.

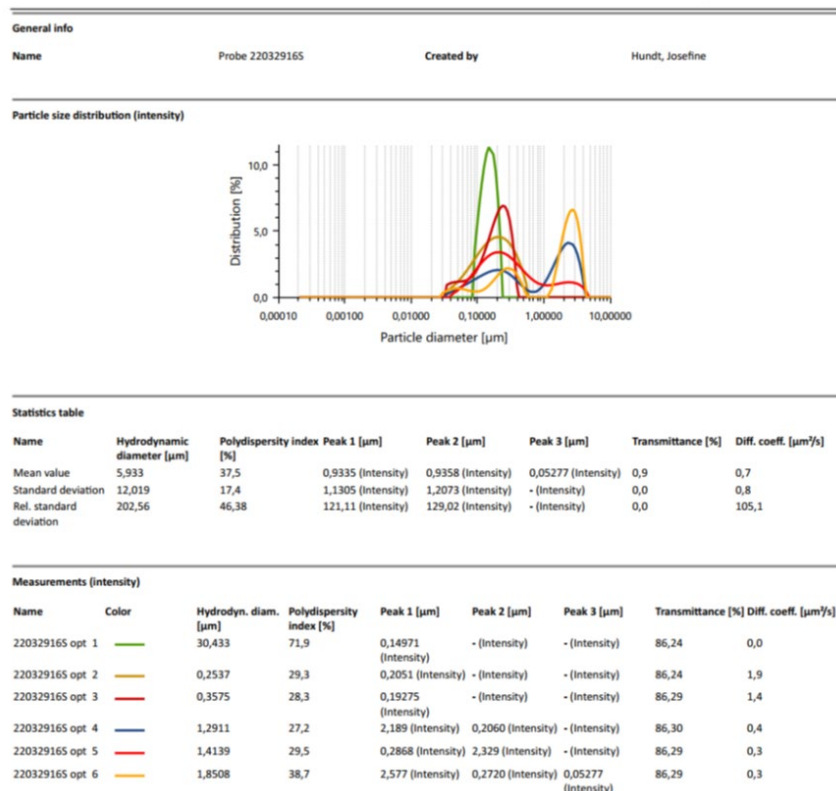

**Figure 8.** Dynamic Light Scattering for 3HFWC

### Particle Size Distribution -Wet dispersion cell

First measurements: As reported by the Notifier, during the initial studies, 3HFWC was filled by a pipette into the tank of the wet dispersion cell (SUCELL), and no increase of the obscuration was observed. When more test item was filled into the tank of the SUCELL, no increase of the obscuration was observed. Therefore, no measurement could be taken. No increase of the obscuration showed that no aggregates and agglomerates or particles in the measuring range above 100 nm could be detected.

Repetition of measurements: The SUCELL was then filled with 400 mL of water for the blank measurement and then drained. In the next step, 400 mL of the liquid sample were inserted into the tank and measured twice - with and without sonification (ultrasound 100% for seconds before the measurement). Very large values resulted, which exceeded the range 5 (maximum range for our SUCELL), meaning that particles larger than 850 µm can be found. Conclusion of the wet dispersion with and without ultra-sonic: According to the Notifier, particles in the range from 5 µm up to 850 µm were observed, which is the limitation of the feasibility.

Ref: LAUS, Report Aug. 2022.

### -Particle size distribution by scanning transmission electron microscopy (STEM) method

As reported by the Notifier, High-angle annular dark-field (HAADF) scanning transmission electron microscopy (STEM); carried out on a FEI Osiris ChemiSTEM microscope at 200 keV electron energy was employed for investigation of the size, the shape and the chemical composition of test item.

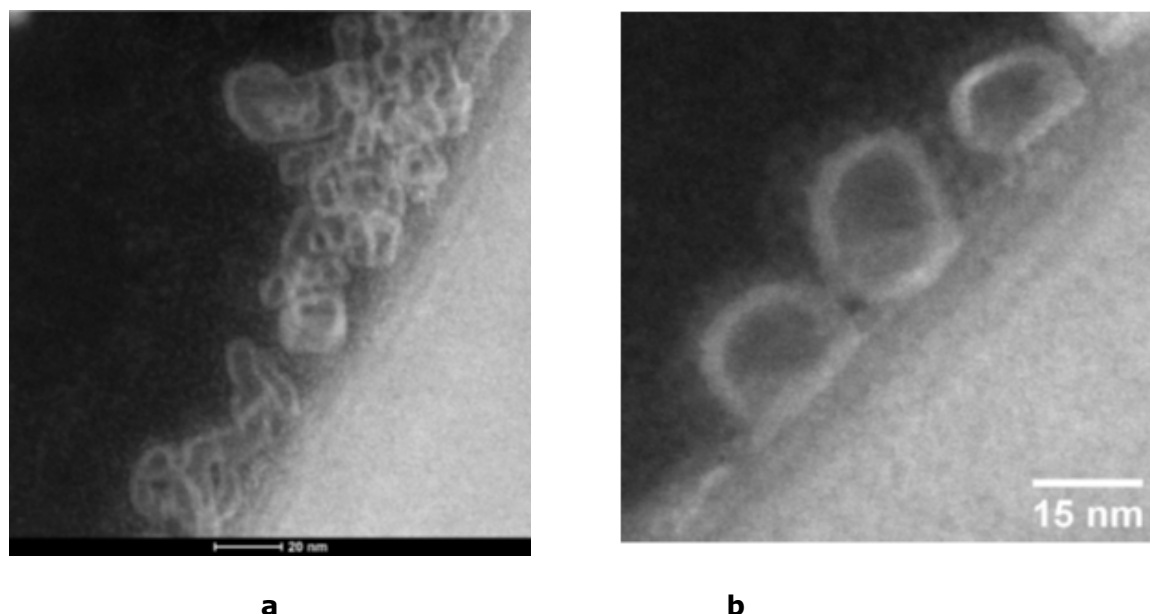

**Figure 9.** Images of the test item 3HFWC captured with a HAADF-STEM at 200 keV, **a)** 20 nm, and **b)** 15 nm.

Evaluation of the observed HAADF-STEM images: According to the Notifier, the constituent particles of 3HFWC are expected to have a diameter between 0.7 and 1.4 nm. It was not possible to identify single constituent particles. The particles were expected to be clustered, forming micelles and "chains". If that has happened the maximum particle size can be assumed to be equivalent to the diameter of walls of the visible structures, which is approximately 2.3 nm above the expected size, but in the same order of magnitude.

Notifiers' conclusions: The evaluation of the results was performed by the Notifier according to the NanoDefine approach: <https://ec.europa.eu/jrc/en/publication/nanodefine-methods-manual> by using the particle size laser, particles in the range from 5  $\mu\text{m}$  up to 850  $\mu\text{m}$ , which is the limitation of the feasibility. Using Dynamic light scattering yielded no results and particles in the range between 0-100 nm, as the concentration of the test item "3HFWC" was too low. The diameters of the "circles" in HAADF-STEM images are  $\sim 20$  nm, and according to the literature and the information provided, the fullerenes should be  $\sim 1$  nm in size. It can be assumed that the observed structures are "chains, tubes" in the form of a circle of functionalised fullerenes that have formed a kind of micelle. The wall thickness diameter of the "circles" was 2 to 4 nm. Hydrodynamic diameter of 3HFWC was reported as  $5.933 \pm 12.019$   $\mu\text{m}$ .

### Zeta potential by electrophoretic light scattering

ELS data for 3HFWC are presented in the table below, as given by the Notifier.

**Table 13:** ELS data for 3HFWC

Test item	Temperature [ $^{\circ}\text{C}$ ]	Zeta potential [mV]	Electrophoretic mobility [ $\mu\text{m/s}/(\text{V/cm})$ ]	Conductivity [mS/cm]
HFWC	25 $^{\circ}\text{C}$	$-43.29 \pm 1.23$	$-3.37 \pm 0.10$	0.17

According to the Notifier, zeta potential was measured as an indicator of the stability of a particle system. According to substance categorization stated in the report, substances with zeta potential values higher than +30 mV or lower than -30 mV are considered stable. The

experimental value of zeta potential for 3HFWC is -43.29 mV (table 13) and it can enable the classification of this substance into the group of stable substances.

Ref: 10. Characterization HFWC;  
The Regulatory Company - 3HFWC data submission main document;  
LAUS, Report Aug. 2022.

### SCCS comment

Although a few electron microscopy (EM) images have been provided for fullerenes C60, hydroxylated fullerenes and 3HFWC, a more detailed quantitative EM analysis is needed for accurate measurement of size distribution of the particles in the nano-scale. A proper dispersion of the samples is also essential, and it is not clear whether this was carried out as part of the sample preparation for electron microscopy. For this, the detailed guidance on the use of EM for characterising nanoparticles, including sample preparation, EM imaging, image analysis, provided in a recent EFSA Guidance (EFSA, 2021) may be used. The level of magnification and pixel size for EM imaging should be determined based on the criterion of Merkus (2009), and suitability of the imaging settings can be evaluated on the basis of the simplified criterion that requires the minimal external dimension of the smallest detected particle to be at least 10 pixels.

With respect to fullerenes, the SCCS has noted that it is not the Notifier's intention to market C60 as such, but as a mixture of C60 and C70.

### 3.1.10 Crystal structure

#### Fullerenes:

Crystalline shape: Irregular, as given by the Notifier.

**Table 14:**

	Fullerene C60	Fullerene C70
Crystal structure	Face-Centered Cubic Lattice (>260K) Simple Cubic Lattice.	Face-Centered Cubic Lattice, Trigonal Lattice, and Hexagonal Close-Packed Lattice at Transitional Phase

Ref: NANOMATERIALS SPECIFICATIONS\_ENGLISH\_Fullerene-V2; Risk\_Assessment\_-\_Fullerenes\_NEDO\_Oct\_16\_2009; Lichtenberger *et al.* (1992); Beckhaus *et al.* (1992).

#### Hydroxylated fullerenes: /

#### Hydrated forms of hydroxylated fullerenes: /

### SCCS comment

Information indicating the particle shape, aspect ratio and agglomeration/aggregation state of the hydroxylated fullerenes and hydrated forms of hydroxylated fullerenes was not provided.

### 3.1.11 UV absorption

#### Fullerenes:

Fullerene C60 exhibits strong absorption bands at 213, 257 and 329 nm.

Ref: Cadek M *et al.* (1999-2013)



**Hydroxylated Fullerenes:**

According to one of the Notifiers, the UV-Vis spectrum of a solution of the test item (hydroxylated fullerene) showed a high absorption at 243.5 nm in neutral medium which increased by addition of basic medium to a maximum at 244 nm and is the same by addition of acidic medium to a maximum at 243.5 nm (Figure 10). No extinction coefficients could be calculated as the molecular mass of the test item is unknown.

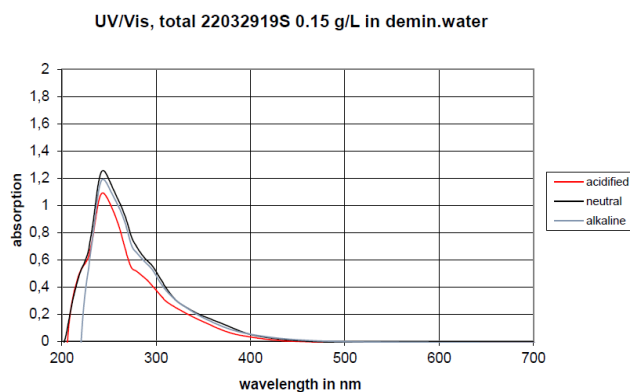
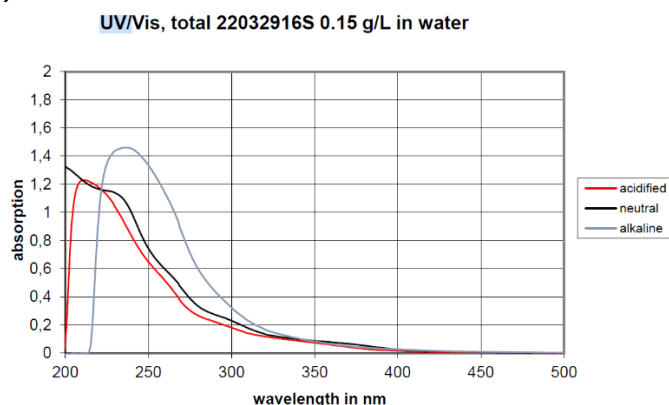

**Figure 10.** UV spectra of hydroxylated Fullerene, as given by the Notifier.

Ref: 10 Characterization HF

**Hydrated forms of hydroxylated fullerenes:**

According to one of the Notifiers, in the UV-Vis spectrum, the test item solution (3HFWC) showed a high absorption at 200 nm in neutral medium which increased by the addition of basic medium to a maximum at 235.5 nm and by the addition of acidic medium to a maximum at 211 nm (Figure 11).



**Figure 11.** UV spectra of 3HFWC as given by the Notifier.

Ref: 10 Characterization HFWC

**3.1.12 Surface characteristics**

The following data on surface characteristics were provided by the Notifiers

**Fullerenes:**

Surface charge (mV): No data

According to the Notifier, fullerene is a strong hydrophobic substance. Surface charge is unmeasurable because it is not dispersed in water.

Surface modifications or functionalization: No

Coating: None

Ref: NANOMATERIALS SPECIFICATIONS\_ENGLISH\_Fullerene-V2



**Hydroxylated fullerenes:**

Surface charge (zeta potential, mV) value: /

**Hydrated forms of Hydroxylated Fullerenes:**

Surface charge (zeta potential, mV) value: 50-70 mV

According to the Notifier, at the surface of the 3HFWC substance, there is a positive charge which depends on the number of hydrogen atoms. The zeta potential depends on the number of water layers and the diameter of the sphere.

Surface modifications or functionalization: No

Coating: None

Ref: 281\_spec\_file\_2020-2-28-19-37-53

**SCCS comment**

Data on the surface charge of hydroxylated fullerenes was not provided.

**3.1.13 Droplet size in formulations**

**Fullerenes:** /

**Hydroxylated fullerenes:** /

**Hydrated forms of Hydroxylated Fullerenes:** /

**SCCS comment**

Data were not provided.

**3.1.14 Homogeneity and stability****Fullerenes:**

During the commenting period the SCCS has received data on the stability of raw Fullerene powder. To show stability of the raw fullerene powder, three batches were stored at 40°C up to six months and were analysed with HPLC. In the HPLC chromatogram, the contents of Fullerene C60 and Fullerene C70 were calculated using percentage of their area peaks against total peak, and these values were compared as a function of time. Since the contents of Fullerene C60 and Fullerene C70 were not changed under these conditions, the raw fullerene powder was judged to be stable at least at 40°C for 6 months. This conclusion was supported by the data in which the contents of the oxides of Fullerene C60 and Fullerene C70, that are main degradants, did not increase at 40°C for six months.

**Hydroxylated fullerenes:** /

**Hydrated forms of Hydroxylated Fullerenes:**

As reported by the Notifier, determination of pH-dependent hydrolysis in water of 3HFWC was conducted according to OECD Guideline 111 and EU Method C.7. The test item is a fullerene with a 30 – 50 covalently attached hydroxyl groups and further coordinated with 144 – 2528 water molecules. Experiments were performed by a partner laboratory using gel permeation chromatography where molecules are separated using their apparent size, including the solvation shell. A size distribution was found corresponding to the range 10314 – 48213 g/mol. However, this technique is not suitable for monitoring the hydrolysis process due to an expected very small change in molecular mass during the reaction. Due to the practical and scientific challenges pointed out above, the performance of the study pH-dependent hydrolysis of Hyperharmonized hydroxylated fullerene water complex (3HFWC) is concluded to be technically not feasible.

Ref: 07 3HFWC Hydrolysis Statement

During the commenting period the Notifier of 3HFWC submitted a summary report, stating that no production of free radicals was detected in any of tested samples and stating that this does not necessarily mean that there was no production, but that it was below the detection limit.

### SCCS comment

Detailed information on homogeneity of fullerenes was not provided. Chemical characterisation of Fullerene epoxides (exact chemical formula and quantity), indicated as byproducts of the manufacturing process of raw fullerene powder, was also not provided.

Detailed information on homogeneity and stability of hydroxylated fullerenes and the hydrated forms of hydroxylated fullerenes was not provided.

The SCCS also needs experimental evidence to exclude the potential formation of free oxyradicals by the notified nanomaterials when used in cosmetics (full reports of relevant studies).

### 3.1.15 Other parameters of characterisation

The following data were provided by the Notifier(s)

#### Fullerenes:

Density/porosity (for granular materials): /

Mass density: Fullerene C60: 1.729 g/cm<sup>3</sup>(5K Calculated value),  
Fullerene C70: 1.6926 g/cm<sup>3</sup>(Ambient Temperature).

Molecular density: Fullerene C60: 1.44 x 10<sup>21</sup> molecule/cm<sup>3</sup>,  
Fullerene C70: no data

Ref: NANOMATERIALS SPECIFICATIONS\_ENGLISH\_Fullerene-V2;  
Risk\_Assessment\_-\_Fullerenes\_NEDO\_Oct\_16\_2009; Heiney *et al.* (1991).

#### Hydroxylated fullerenes:

Mass density: 0.9982 g/cm<sup>3</sup> at 20.0 ± 0.4 °C

Ref: 03 Density HF

#### Hydrated forms of Hydroxylated Fullerenes:

During the commenting period the Notifier reported that the density of 3HFWC is 1.088 g/cm<sup>3</sup>.

### 3.1.16 Summary on supplementary physicochemical characterisation

It is notable from the provided supplementary information that fullerenes contain a proportion of epoxide forms, and that the hydrated form of hydroxylated fullerene consists of an aqueous layer that contains (0.03%) hydrogen peroxide, which according to the Notifier, incorporated into ordered water layers and is not present in its original form in 3HFWC. The SCCS considers that the calculation of percentage of H<sub>2</sub>O<sub>2</sub> does not represent correct concentration in the water sphere surrounding the hydroxylated fullerene core (see SCCS comments under 3.1.4).

**SCCS general comment on the physicochemical part**

- The nanomaterial notified as raw fullerene powder is indicated by the Notifier to be a mixture of fullerenes C60 and C70. The measured values for the contents in five batches have shown that the C60 content ranges from 70% to 80%. Data on the exact content of fullerene C70 have not been provided, but could be deduced to range between 20-30%.
- In this Opinion, the SCCS has considered 3HFWC as a hydrated form of hydroxylated fullerene - similar to other hydroxylated fullerenes dispersed in aqueous media (with an additional proportion of H<sub>2</sub>O<sub>2</sub>) – because of the absence of a justified scientific explanation for the nature of the bonding between hydroxylated fullerene and water molecules (being other than hydrogen bonding), and other possible reactions/transformations of the starting materials (hydroxylated fullerene, hydrogen peroxide) during the manufacturing process.
- The Notifier regarded that no analytical method was reliable for quantitative determination of 3HFWC. The composition of 3HFWC was provided by the Notifier as the measured content of hydroxylated fullerenes and water, and this further supports that, in terms of chemical composition, 3HFWC is equivalent to a hydrated form of hydroxylated fullerene – as considered by the SCCS to be similar to other hydroxylated fullerenes dispersed in aqueous media.

For adequate safety evaluation, the SCCS requires the following information:

Fullerenes (C60 and C70):

- Complete chemical characterisation, by an appropriate identification technique, (exact chemical formulae, and percentage content) of impurities and also fullerene epoxides byproducts that are present in Fullerene raw powder (mixture of Fullerene C60 and Fullerene C70).
- Quantitative EM analysis for accurate size measurement of the particles in the nanoscale.
- Detailed information on homogeneity of the material.

Hydroxylated fullerenes and hydrated forms of hydroxylated fullerenes:

- Clarification on the exact degree of hydroxylation of hydroxylated fullerenes as such, and in their hydrated form (3HFWC).
- Since during the commenting period, the Notifier of 3HFWC reported that the test substance is stabilized by a small percentage of H<sub>2</sub>O<sub>2</sub>. Evidence is needed to support the claim that H<sub>2</sub>O<sub>2</sub> is not available for imparting any reaction/transformation of the starting material (hydroxylated fullerene) during the manufacturing process or cause potential adverse cellular effects due to the formation of oxyradicals.
- Accurate quantification of H<sub>2</sub>O<sub>2</sub> content in the hydrated forms of hydroxylated fullerenes.
- Detailed information on the levels of impurities, heavy metals, accompanying contaminants and organic solvents, along with detailed information on the methods of manufacturing (synthesis route, solvent removal, and any co-synthesized by-products).
- Quantitative EM analysis for accurate size measurement of the particles in the nanoscale.
- Detailed information on homogeneity and stability of the notified nanomaterials.
- Information is also needed on the shape, aspect ratio and agglomeration/aggregation state of hydroxylated fullerenes and hydrated forms of hydroxylated fullerenes, and data on the surface charge of hydroxylated fullerenes.

The SCCS also needs more data/information to exclude the potential formation of free oxyradicals by the notified nanomaterials when used in cosmetics.

## 3.2 TOXICOKINETICS

### 3.2.1 Dermal / percutaneous absorption

#### Fullerenes:

According to one of the Notifiers, data analysis in general allows assumption of fullerenes' negligible dermal bioavailability during the cosmetics application. Available *in vitro* data shows its penetration ability only to the stratum corneum. Fullerenes were not detected in the dermis (one publication describes its detection in the epidermis in high-dose tests, but the test was performed only for 3 skin samples).

Ref: FULLERENES toxicity profile

The following two studies are reported by this Notifiers for dermal/ percutaneous absorption:

Based on the *in vivo* skin penetration studies of Xia *et al.* (2010) in Yorkshire weanling pigs and *in vitro* studies using skin discs from the same pig strain using powdered fullerene (99.5 % purity) in different solvents (chloroform, toluene, cyclohexane and mineral oil), penetration depth into stratum corneum was dependent on the solvent used. In the *in vitro* part of the study, fullerenes were not detected in the receptor fluid, but there was no report on epidermis or dermis.

Ref: Xia *et al.* (2010)

#### SCCS comment to the study by Xia *et al.* (2010)

The study by Xia *et al.* (2010) was cited by one of the Notifiers and is presented as an article from the public literature. The original study report was not available for evaluation of the study quality. The reported results indicated that by applying fullerenes *in vivo* and *in vitro*, the depth of penetration into stratum corneum is solvent dependent and that distribution of fullerene C60 into the stratum corneum was not only at the superficial layers, but also into deeper layers of the stratum corneum. In *in vitro* experiments using flow-through diffusion cells, for each of the organic solvents used, fullerene C60 could not be detected in the receptor fluid. This is, however, an exploratory study, not performed according to the SCCS requirements, especially for the flow-through experiments, the amounts in epidermis and dermis were either not measured or not presented. The study material used was Fullerene C60 at 99.5% purity, while the notified material (raw Fullerene powder) consists of a mixture of Fullerene C60 and Fullerene C70. It is also not clear what receptor fluid has been used. Therefore, the study cannot be considered for safety assessment.

Another *in vitro* study of Kato *et al.* (2009) using human skin and Fullerene C60 in squalene showed that, after 24h Fullerene C60 was not detected in the dermis. Some amount was detected only in the epidermis with the highest dose tested. Only 3 skin samples were used.

Ref: Kato *et al.* (2009)

#### SCCS comment to the study by Kato *et al.* (2009)

The study is described in a publication from the open literature. The original study report was not available for evaluation. Moreover, it was performed using the test material in an organic solvent and not in a representative formulation, and therefore the findings of the study cannot be used for safety assessment.

One of the Notifiers stated that they do not have data on the skin and percutaneous absorption of Fullerenes C60 and C70 in accordance with the guidelines. In addition, they have not evaluated skin permeability using cosmetic formulations containing the fullerenes. Therefore, the Notifier agrees with SCCS recommendation to use a default 50% dermal absorption value in safety assessment.

Ref.: 20220627 supplemental document SCCS interim feedback.pdf

During the commenting period, in reply to the SCCS comment on the absence of proper studies on the skin and percutaneous absorption of Fullerenes C60 and C70, information was submitted (Study Number: AE-7191-G) and is described below.

**NOTE: translation from Japanese into English as provided by the Notifier**

**Study number:** AE-7191-G

**Guideline:** Study performed according to OECD TG 427, except for the concentration and dosage of the test substance.

**Species/strain:** Male rat/Crl:CD(SD), 7 weeks of age at the time of application

**Group size:** 5 groups, 4 animals per group (20 animals in total).

**Test substance:** <sup>14</sup>C-labelled fullerene C60

**Batch:** 030713R1-2

**Purity:** 98.2 ± 0.2% (Percentage of specific radioactivity)

**Vehicle:** Olive oil

**Dose levels:** 0.015 mg/body (0.00125 mg/cm<sup>2</sup>)

**Dosing volume:** 0.03 mL/body

**Radioactivity applied:** 0.01875 MBq/body

**Frequency of Application:** Once

**Administration:** Dermal application

**Feeding conditions:** non-fasted

**GLP:** OECD Principles on Good Laboratory Practice (revised 1997, issued Jan 1998) ENV/MC/CHEM(98)17 and the "Standards for the Reliability of Application Data" (Article 43 of the Ordinance for Enforcement of the Pharmaceutical Affairs Act).

**Study period:** 13 November 2013 – 27 February 2014

The results showed that the applied [<sup>14</sup>C]C60 penetrated from the application site to the dermis, but hardly transferred to the whole body. In addition, there was a rapid elimination from the skin, with no retention in the skin and specific tissues. Although the dermal absorption rate was only 1.2%, the absorbed [<sup>14</sup>C]C60 was shown to be excreted in urine and feces at almost the same level. There was no retention in the body. The total recovery of radioactivity relative to the dose was 96.1%, which was acceptable to ensure the study reliability.

Ref: Absorption, Distribution, and Excretion Study Following a Single Dermal Application of [<sup>14</sup>C]Fullerene C60 to Normal Skin of Male Rats (Study No. AE-7191-G)

**SCCS comment to the Study No. AE-7191-G**

During the commenting period, an *in-vivo* dermal penetration study using [<sup>14</sup>C] fullerene C60 performed in male Crl:CD(SD) rats has been submitted to the SCCS by one of the respondents. The study was submitted in Japanese and in English translation. The study was performed after the animal testing ban (first administration to animals: 26 November 2013). According to one of the respondents, the study was performed in line with OECD Principles on Good Laboratory Practice (revised 1997, issued Jan 1998) ENV/MC/CHEM(98)17 and the "Standards for the Reliability of Application Data" (Article 43 of the Ordinance for Enforcement of the Pharmaceutical Affairs Act) in order to apply the raw fullerene powder as a quasi-pharmaceutical product to the Japanese government for the purpose of usage as an antioxidant agent and according to Pharmaceuticals and Medical Devices Law in Japan. The SCCS has noted this study and will consider its usefulness in the safety evaluation.

**SCCS overall comment on dermal absorption of fullerenes**

Studies on dermal penetration of fullerenes (a mixture of C60 and C70) have been described in the open literature and one study report in English translation on an *in vivo* study was provided during the commenting period. However, the studies were not performed in line with the current OECD test guidelines and/or the SCCS basic requirements for dermal penetration studies. Moreover, the published studies have indicated that dermal penetration of fullerenes is influenced by the solvents used in the test. It is not clear whether and to what extent the materials used in the published literature refer to the notified substances. Therefore, appropriately conducted dermal penetration studies would be required on the notified ingredients, performed in line with the SCCS requirements as detailed in the SCCS Notes of Guidance (SCCS/1628/21). In the absence of sound experimental data on the notified ingredients, it cannot be assumed that there is no dermal penetration of the nanoparticles, and the SCCS will use the default value of 50% for dermal absorption in safety assessment.

**Hydroxylated fullerenes**

Hydroxylated Fullerenes, as large water soluble (hydrophilic) molecules, with MW > 500 Da, are generally not expected to pass the skin barrier easily. A molecular dynamics study by Qiao *et al.* (2007) on translocation of Fullerene C60 and Hydroxylated Fullerene (C60(OH)20) across a model cell membrane of di-palmitoyl-phosphatidylcholine showed that the molecule of Hydroxylated Fullerene can barely penetrate the bilayer. The mean translocation time via diffusion for the Hydroxylated Fullerene molecule was several orders of magnitude longer than for the Fullerene C60. It was also determined that the two different forms of fullerenes, when adsorbed into/onto the bilayer, affected the membrane structure differently. This study offers a mechanistic explanation of that difference and for the reduced acute toxicity of functionalized fullerenes.

Ref: Qiao *et al.* (2007)

**SCCS overall comment on dermal absorption of Hydroxylated fullerenes**

The study provided on dermal penetration of hydroxylated fullerenes is an exploratory study and does not meet the SCCS basic requirements as laid out in the SCCS Notes of Guidance (SCCS/1628/21). Appropriately conducted dermal penetration studies would be required on the notified ingredients, performed in line with the SCCS requirements as detailed in the SCCS Notes of Guidance (SCCS/1628/21). In the absence of sound experimental data on the notified ingredients, it cannot be assumed that there is no dermal penetration of the nanoparticles, and in such situations the SCCS recommends the use of a default value of 50% for dermal absorption in safety assessment as detailed in the SCCS guidance on the safety assessment of nanomaterials in cosmetics - 2<sup>nd</sup> revision (SCCS/1655/23).

**Hydrated forms of Hydroxylated Fullerenes**

The Notifier cites the study by Kato *et al.* (2009), reported above for LipoFullerenes. According to the Notifier, based on the available studies indicating limited to negligible percutaneous absorption of Fullerenes, and in particular that of water-soluble functionalised derivatives like fullerenol, it can be concluded that the percutaneous absorption of Hyperharmonised Fullerenol-Water Complex (HFWC), with its additional stable water layers surrounding the fullerenol core, will be very low (practically negligible).

Ref: Kato *et al.* (2009); 281\_safety\_file\_2020-3-12-18-44-18.pdf

The Notifier submitted the following OECD TG 428 *in vitro* dermal absorption studies using cosmetic products:



**Skin Absorption Assay V07 (Ref: VT\_DA-PVA\_664\_22\_001):**

Guideline:	OECD 428 Guideline
Test system:	Human skin explants. Fresh abdomen skin collected from surgery and frozen.
Number of donors:	2 samples from 4 donors (2 Caucasian Females, 1 African Female and 1 Caucasian male).
Skin preparation:	200 µm thick prepared with a dermatome
Membrane integrity:	Not provided
Test substance:	Hyper-Harmonized Hydrolylated fullerene water complex (3HFWC)
Test item:	La Danza Hyperlight Fusion Anti-Aging Essential Complex. A cream containing 16% 3HFWC substance (formed from fullerenol at 0.15 g/L concentration). Initial dose of hydroxylated fullerene in cream is 14.9 mg/l.
Batch:	69226016
Purity:	Unknown
Dose applied:	2.5 mg
Exposed area:	Unknown
Study period:	24 hours
Assay conditions:	32°C±1°C. and 50% relative humidity
Sampling:	at 4 hours and 24 hours
Receptor fluid:	Phosphate Buffer Saline (PBS)
Solubility in receptor fluid:	Not provided
Mass balance analysis:	Not provided
Tape stripping:	No
Method of analysis:	LC-MS
GLP:	No
Period:	16/03/22 – 29/08/22

The test item investigated was a cosmetic cream (La Danza Hyperlight Fusion Anti-Aging Essential Complex Cream) containing 16% of 3HFWC substance (formed from fullerenol at 0.15 g/L concentration). The skin samples were maintained overnight with maintenance medium at assay conditions before the application of the product. Fresh receptor solution was put in the receptor chamber avoiding the formation of air bubbles below the membrane. The incubation time with product started once the product was applied on the surface of the skin. Once the time was over, samples were taken from the receptor chamber, donor chamber, and skin, and analysed to obtain the absorbed amount of each analyte. The LC-MS analyses carried out to date allow the adequate determination of the analyte hydroxylated fullerene reliably and accurately in the expected real samples.

**Results**

The concentration of analyte detected and quantified in the donor chamber is below the limit of quantification of the analytical method used for analyte determination.

A mean percentage of 44.97% ( $\pm$  22.62) of the analyte retained on human skin is observed.

In the receptor chamber, after 4 hours of contact, the concentration obtained was not measurable (out of the limit of detection and quantification).

After 24 hours of contact, the evaluated analyte was not detected in most of the analysed replicates, with the exception of one replicate, in which a concentration of 2.6 mg/L was quantified.

The detection of an amount of analyte in one replicate, in contrast to the 7 replicates where it cannot be quantified, may be due to the variability of the absorption system itself when using human skin from 4 different donors, which may result in anomalous values or outliers.

**Conclusions**

The concentration obtained after the absorption through human skin after application of "La Danza Hyperlight Fusion anti-aging Essential Complex" for the analyte Hydroxylated Fullerene is as follows:

**Table 15:**

Initial quantity	Quantity of unabsorbed dose	Quantities absorbed on/in the skin	Quantities that pass the skin after 4 hours	Quantities that pass the skin after 24 hours
14.9	< 2.8 mg/L	6.7 mg/L	< 1.38 mg/L	< 1.8 mg/L
100%	< 18.792%	44.97%	< 9.23%	< 12.33%

Ref: Skin Absorption test 16 V7 OECD 428

**SCCS comment**

According to the Notifier, the purpose of this study was to estimate the skin absorption of 3HFWC. However, the concentration of hydroxylated fullerene was measured by LC-MS in the cosmetic product and in the donor and receptor chambers, without measuring the concentration of the test material (hydrated forms of hydroxylated fullerene) itself. Human skin samples (n=8) from 4 different donors was used. Skin samples were not separated into epidermis and dermis, therefore it remains unclear how much material was present in living skin layers, which has to be included in the amounts considered absorbed. A proper mass balance is not possible, as concentrations in donor chambers and receptor fluid were below LoQ. Also, the fact that amounts in donor chamber were below LoQ puts the study results into question. However, based on the amounts determined in/on the skin, it can be assumed that the material becomes systemically available through the dermal route.

**Skin Absorption Assay V08 (Ref: VT\_DA-PVA\_664\_21\_004):**

Guideline:	OECD 428 Guideline
Test system:	Human skin explants. Fresh abdomen skin collected from surgery and frozen.
Number of donors:	2 samples from 4 donors (2 Caucasian Females, 1 African Female and 1 Caucasian male).
Skin preparation:	200 µm thick prepared with a dermatome
Membrane integrity:	Not provided
Test substance:	Hyper-Harmonized Hydrolylated fullerene water complex (3HFWC)
Test item:	Hyperlight Fusion anti-aging essential complex containing 71,517% 3HFWC substance (formed from fullerenol at 0.15 g/L concentration).
Batch:	210825.005
Purity:	Unknown
Dose applied:	2.5 mg
Exposed area:	Unknown
Study period:	24 hours
Assay conditions:	32°C±1°C. and 50% relative humidity
Sampling:	at 4 hours and 24 hours
Receptor fluid:	Phosphate Buffer Saline (PBS)
Solubility in receptor fluid:	Not provided



Mass balance analysis:	Not provided
Tape stripping:	No
Method of analysis:	LC-MS
GLP:	No
Period:	16/03/22 – 30/08/22

The test item investigated was a cosmetic cream (Hyperlight Fusion anti-aging essential complex) containing 71,517% of 3HFWC substance (formed from fullerenol at 0.15 g/L concentration).

The skin absorption study is performed using a semipermeable membrane such as reconstructed skin or skin explants. The membrane is located between the (i) donor and the (ii) receiver chambers. The product is applied on the stratum corneum exposed in the donor chamber. Below the membrane, the receptor chamber contains tissue culture media or a solution that simulates the physiological conditions and where the tested substances are highly soluble.

Fresh receptor solution was put in the receptor chamber avoiding the formation of air bubbles below the membrane. The incubation time with product started once the product was applied on the surface of the skin. Once the time was over, samples were taken from the receptor chamber, donor chamber, and skin, and analysed to obtain the absorbed amount of each analyte.

The LC-MS analyses carried out to date allow the determination of the analyte hydroxylated fullerene reliably and accurately in the expected real samples.

## Results

The concentration of analyte detected and quantified in the donor chamber is below the limit of quantification of the analytical method used for analyte determination.

A mean percentage diffusion of 40.02% ( $\pm$  14.75) of the analyte retained on human skin is observed.

In the receptor chamber, after 4 hours of contact, the concentration obtained for most of the analysed replicates was not measurable (out of the limit of quantification), except one replicate, which showed 5.6 mg/L.

After 24 hours of contact, the evaluated analyte was detected in all analysed replicates, in which a mean concentration of 4.8 mg/L was detected.

The detection of an amount of analyte in one replicate, in contrast to the 7 replicates where it cannot be quantified, may be due to the variability of the absorption system itself when using human skin from 4 different donors, which may result in anomalous values or outliers.

## Conclusions

This skin absorption assay, based on the OECD 428 Guideline for the testing of chemicals "Skin absorption: *in vitro* method", was conducted to determine the skin and trans-dermal absorption of the Hyper-harmonized Hydroxylated fullerene water complex (3HFWC) using a nanosubstance (Hydroxylated Fullerene) as reference molecule used in cosmetic products to measure the diffusion of chemicals into and across human skin from 4 different donors.

The concentration obtained after the absorption through human skin after application of "Hyper-harmonized Hydroxylated fullerene water complex (3HFWC)" for the analyte Hydroxylated fullerene is as follows:

**Table 16:**

Initial quantity	Quantity of unabsorbed dose	Quantities absorbed on/in the skin	Quantities that pass the skin after 4 hours	Quantities that pass the skin after 24 hours
13.9	< 2.8 mg/L	5.56 mg/L	< 2.28 mg/L	4.75 mg/L
100%	< 20.14%	40.02 %	< 16.40 %	34.17%

Ref: Skin Absorption test 71,517 V8 OECD 428

**SCCS comment**

According to the Notifier, the purpose of this study was to estimate the skin absorption of 3HFWC, however, the concentration of hydroxylated fullerene was measured by LC-MS in the cosmetic product and in the donor and receptor chambers without measuring the concentration of the test material (3HFWC). Human skin samples (n=8) from 4 different donors was used. Skin samples were not separated into epidermis and dermis; therefore, it remains unclear how much material was present in living skin layers, which should be included in the amounts considered absorbed. A proper mass balance is not possible as concentrations in donor chambers and receptor fluid were below LoQ. Also, the fact that amounts in donor chamber were below LoQ puts the study results into question. However, based on the amounts determined in/on the skin, it can be assumed that the material becomes systemically available through the dermal route.

**Skin Absorption Assay V04**

Guideline:	OECD 428 Guideline
Test system:	Human skin explants. Fresh abdomen skin collected from surgery and frozen.
Number of donors:	2 samples from 4 donors (2 Caucasian Females, 1 African Female and 1 Caucasian male).
Skin preparation:	200 µm thick prepared with a dermatome
Membrane integrity:	Not provided
Test substance:	Hyper-Harmonized Hydrolylated fullerene water complex (3HFWC)
Test item:	Hyperlight Fluid Fusion Subcellular Essential Complex (aqueous solution 0.15 g/L)
Batch:	22DHA002/21
Purity:	Unknown
Dose applied:	2.5 mg
Exposed area:	0.38465 cm <sup>2</sup>
Study period:	24 hours
Assay conditions:	32°C±1°C. and 50% relative humidity
Sampling:	at 4 hours and 24 hours
Receptor fluid:	Phosphate Buffer Saline (PBS)
Solubility in receptor fluid:	Not provided
Mass balance analysis:	Not provided
Tape stripping:	No
Method of analysis:	LC-MS
GLP:	No
Period:	2/08/22 – xx/08/22

**Results**

-Qualitative and quantitative analysis on donor chamber:

In the donor chamber samples, the concentration obtained is below the limit of quantification of the analytical method used for analyte determination.

-Qualitative and quantitative analyses on skin:

In the skin samples, the concentration obtained is below the limit of quantification of the analytical method used for analyte determination.

-Qualitative and quantitative analysis on receptor chamber after 4 hours:

In the receptor chamber, after 4 hours of contact, the concentration obtained is below the limit of quantification of the analytical method used for analyte determination.

-Qualitative and quantitative analysis on receptor chamber after 24 hours:

In the receptor chamber, after 24 hours of contact, the concentration obtained is below the limit of quantification of the analytical method used for analyte determination.

### Notifiers' conclusions

The concentration obtained after the absorption through human skin after application of "Hyperlight Fluid Fusion Subcellular Essential Complex" for the analyte Hydroxylated fullerene is as follows:

**Table 17:**

	Unabsorbed dose	Absorbed on/in the skin	Doses that pass the skin after 4 hours	Doses that pass the skin after 24 hours
Concentration detected	< 2.5 mg/L	< 2.5 mg/L	< 2.5 mg/L	< 2.5 mg/L

In the receptor chamber, after 4 hours of contact, the concentration obtained is below the limit of quantification of the analytical method used for analyte determination of Hydroxylated fullerene. Moreover, after 24 hours of contact, the concentration obtained is below the limit of quantification of the analytical method used for analyte determination of Hydroxylated fullerene.

Ref: Skin Absorption test 100 V4 OECD 428 not signed

### SCCS comment

The Notifier also submitted the above unsigned skin absorption study, where in the receptor chamber, after 4 and 24 hours of contact, the concentration obtained was below the limit of quantification of the analytical method used for analyte determination.

### SCCS overall comment on dermal absorption of Hydrated forms of Hydroxylated Fullerenes

For the hydrated forms of hydroxylated fullerenes (3HFWC), the studies provided on *in vitro* dermal penetration are not in line with the OECD guidelines and/or the SCCS Notes of Guidance (SCCS/1647/22). In addition, there are various uncertainties concerning the results. Nevertheless, based on the amounts determined in/on the skin, it can be inferred that the material becomes systemically available through the dermal route. Therefore, in the absence of sound experimental data on dermal penetration, the SCCS will use the default value of 50% for dermal penetration. In this regard, the SCCS appreciates the intention of one of the Notifiers to carry out further studies to address some of the data gaps on dermal absorption.

## 3.2.2 Other studies on toxicokinetics

### Fullerenes

According to one of the Notifiers, published data show low oral bioavailability of C60 fullerene.

Ref: FULLERENES toxicity profile

### *In vivo* Studies

#### Oral

During the commenting period, in reply to the SCCS comment on the absence of proper studies on oral toxicokinetics of fullerenes C60 one of the responders has submitted the study (Study Number: AE-7457) described below.

**Study: Preliminary Study of [<sup>14</sup>C] Fullerene C60 Administered as a Single Oral Dose in Male Rats (2); Study No.AE-7457**

NOTE: translation from Japanese into English as provided by the Notifier.

Study number:	AE-7457
Guideline:	not indicated
Species/strain:	CrI:CD(SD) rat, male, 5 weeks of age, body weight 203.7 – 218.5g
Group size:	7 animals were used, 1 animal per group
Test substance:	Fullerene C60 as unlabelled substance, <sup>14</sup> C-labeled C60,
Batch:	Unlabelled C60:12A0134-A, Branch number: K-1 (3); <sup>14</sup> C-labeled C60: Lot nr 030713R1-2
Purity:	99.5%
Vehicle:	Olive oil (according to Japanese Pharmacopeia)
Dose levels:	2.5 mg/kg [ <sup>14</sup> C]-fullerene C60, dosing volume 5 mL/kg, dosing solution concentration checked at dosing time
Administration:	Single oral dose in fasted animals by use of gastric gavage
Sampling time:	Group 1: 30 min, 1, and 2 hours post-dose; Group 2: 30 min, 1, 2, 4, 6, and 8 hours post-dose; Group 3: 30 min, 1, 2, 4, 6, 8, 10, 12, and 24 hours post-dose; Group 4: 30 min, 1, 2, 4, 6, 8, 10, 12, 24, and 48 hours post-dose; Group 5: 30 min, 1, 2, 4, 6, 8, 10, 12, 24, 48, 96, and 168 hours post-dose; Group 6: 30 min, 1, 2, 4, 6, 8, 10, 12, 24, 48, 96, 168, 240, and 336 hours post-dose
Feeding conditions:	Animals were fasted for approximately 16 hours from the day before administration, and feeding was started at 6 hours post-dose.
GLP:	Statement on use of company Standard Operating Procedures (SOP)
Study period:	October 31, 2014 – February 13, 2015

At 24 hours, the cumulative excretion of radioactivity (urinary and faecal excretion) was 93% of the administered radioactivity dose.

According to the responder this study was conducted to submit the raw fullerene powder as a quasi-pharmaceutical product to the Japanese government for the purpose of usage as an antioxidant agent.

Ref: Preliminary Study of [<sup>14</sup>C]Fullerene C60 Administered as a Single Oral Dose in Male Rats (2) Study No.AE-7457

**SCCS comment**

The authors of this study do not provide any information regarding oral bioavailability. Nevertheless, results showed that [<sup>14</sup>C]C60 was absorbed from the gastrointestinal tract and systemic distributed. [<sup>14</sup>C]C60 is distributed in different tissues in rat, mainly liver, kidneys, fat, mesenteric lymph node. Despite a long half-life in blood (109 hours), results at 24h showed that the radioactivity concentration in tissues was less than 0.5% of the administered dose. The SCCS also noted that the cumulative excretion of radioactivity (urinary and faecal excretion) was 93% of the administered radioactivity dose at 24 h, suggesting a low potential of accumulation. In this study, for total body distribution, only one animal per group was used limiting the usefulness of this study. However, the blood values obtained in several animals, indicate gastro-intestinal absorption.

The SCCS has noted this study and will consider its usefulness in the safety evaluation.

## Inhalation

The following studies were cited by the Notifier:

Taken from OECD 2016 (ENV/JM/MONO(2016)21 Part 2) on the study by Shinohara *et al.* (2010) :

To estimate the clearance rate and deposition fraction of C60 from inhalation exposure, the Fullerene C60 burden in the lungs, liver and brain of rats was determined after intratracheal instillation and inhalation (Shinohara *et al.*, 2010). The concentration of Fullerene C60 in the liver and brain was below the detection limit: 8.9 ng/g tissue after intratracheal instillation and inhalation. The half-life in the lung of intratracheally instilled Fullerene C60 was 15-28 days. Mode evaluation revealed that most instilled particles could be eliminated by the fast clearance pathway. This finding was consistent with the transmission electron microscopy finding that many particles were present in alveolar macrophages.

Ref: Shinohara *et al.* (2010)

A study by Naota *et al.* (2009) cited by Hendrickson *et al.* (2014) investigated the translocation pathway of intratracheally instilled fullerene C60 particles from the lung into the blood circulation in the mouse. Using light microscopy, aggregated particles of fullerene were observed in the capillary lumen in the lung and the pulmonary lymph nodes immediately after instillation. Electron microscopic analysis demonstrated an increased number of pinocytotic vesicles (caveolae) of various sizes in the type 1 alveolar epithelial cells and endothelial cells; occasional caveolae containing some particulate substances were observed. In addition, particles of various sizes were observed throughout the structure of the air-blood barrier. These findings suggest that fullerene particles may pass the air-blood barrier by both diffusion and caveolae-mediated pinocytosis, resulting in immediate translocation into the systemic circulation.

Ref: Naota *et al.* (2009)

## IV administration

The following study was referenced by the Notifier:

Taken from OECD 2016 (ENV/JM/MONO(2016)21 Part 2)

Biodistribution of C60 (Nanom Purple) in male Wistar rats (5 rats/time point) after tail vein administration (5 mg/kg bw/injection x 4 times) was examined using LC-MS/MS (Kubota *et al.*, 2011). Fullerene C60 was detected in various tissues, such as brain, kidneys, liver, lungs, and spleen of male Wistar rats. On the other hand, no Fullerene C60 was found in blood. The highest Fullerene C60 concentration was observed in the lungs, followed by spleen, liver, kidneys and brain. These results suggested that Fullerene C60 injected in the tail vein could be filtered by lung capillary vessels and accumulate in the lungs prior to being distributed to other tissues. Furthermore, Fullerene C60 not being detected in the blood indicated that clearance of Fullerene C60 from the blood by filtration might effectively occur in the lungs. The time-dependent variation in the biodistribution of Fullerene C60 was evaluated. A time-dependent decrease in Fullerene C60 concentrations was observed in all tissues, except spleen. Moreover, a decreasing trend of Fullerene C60 levels differed among tissues, which could be due to differences in accumulation.

Ref: Kubota *et al.* (2011); OECD 2016 (ENV/JM/MONO(2016)21)

## Hydroxylated fullerenes

### *In-silico* ADME prediction – toxicokinetics modelling

The Notifier conducted *in-silico* assessment of the ADME properties of Hydroxylated Fullerenes C<sub>60</sub>(OH)<sub>x</sub>. According to the Notifier 'Hydroxylated Fullerene C<sub>60</sub>(OH)<sub>30-50</sub> is experimentally

obtained nanomaterial which contains 40 hydroxyl groups. Therefore, selected substances,  $C_{60}(OH)_{30}$ ,  $C_{60}(OH)_{40}$  and  $C_{60}(OH)_{50}$ , as well as related Hydroxylated Fullerenes from the literature,  $C_{60}(OH)_{24}$  and  $C_{60}(OH)_{60}$  were analysed by *in-silico* methodology. Additionally, Fullerene,  $C_{60}$  was tested, as a substance insoluble in water. The available online servers ADMETlab, admetSAR 2.0, ALOGPS 2, Molinspiration, pkCSM, and SwissADME were used for *in-silico* ADME prediction. Contradictory results were obtained for the assessment of intestinal resorption in the gastrointestinal tract.

According to one *in-silico* tool and for all tested substances, Hydroxylated Fullerenes are poorly resorbed (HIA and Lipinski parameters), while the results of the other two *in-silico* tools indicated good intestinal resorption for most of the tested substances. *In-silico* prediction of volume of distribution factors for tested Hydroxylated Fullerenes showed low value ( $<0.6$  L/kg) and average value ( $0.6 < V_d < 5.0$  L/kg). The predicted results for the binding potential of the investigated substances to bind to plasma proteins and BBB permeability are radically different depending on the applied software. For most of the tested Hydroxylated Fullerenes used *in-silico* tools showed that they do not inhibit CYP enzymes. Also, the majority of the investigated substances are not substrates for CYP enzymes according to the used online software. The obtained *in-silico* results about skin permeability indicating that Hydroxylated Fullerenes  $C_{60}(OH)_x$  have no potential for permeability through the skin.

In context of the obtained opposite results, it is not clear how the results obtained by two or more models/systems should be interpreted where the estimates are widely different or contradicting. In general, taking into account the many different available *in-silico* tools, systemic exposure Hydroxylated Fullerenes  $C_{60}(OH)_x$ , as cosmetic ingredients, via oral (*in-silico* prediction) and dermal absorption (*in-silico* prediction of skin permeability) is expected to be minimal. But, according to the Notifier these *in-silico* ADME results should be taken into account with all the uncertainty of *in-silico* analysis, especially when it comes to nanomaterials and applicability of tools'.

Ref: 3HFWC data submission main document

Another study by Ji *et al.* (2009) examined the biodistribution and tumour uptake of hydroxylated fullerenes ( $C_{60}(OH)_x$ ) in five mouse-bearing tumour models. The results showed that the intravenously administered  $^{125}I$ -labelled fullereneol [ $^{125}I-C_{60}(OH)_x$ ] at dose of  $10 \mu\text{g}$  per mouse is distributed in all organs of rats, except for the brain. One hour after the administration, labelled fullereneol was accumulated mainly in the liver, spleen, and bone tissues and was also detected in the stomach and blood. After 6 h, the character of the distribution of  $^{125}I-C_{60}(OH)_x$  changed and the level decreased in the blood and increased in the liver, spleen, kidney, and bone tissues. After 72 h, the compound was completely absent in the tissues and 92% of the particles were excreted in the urine and 8% in the faeces.

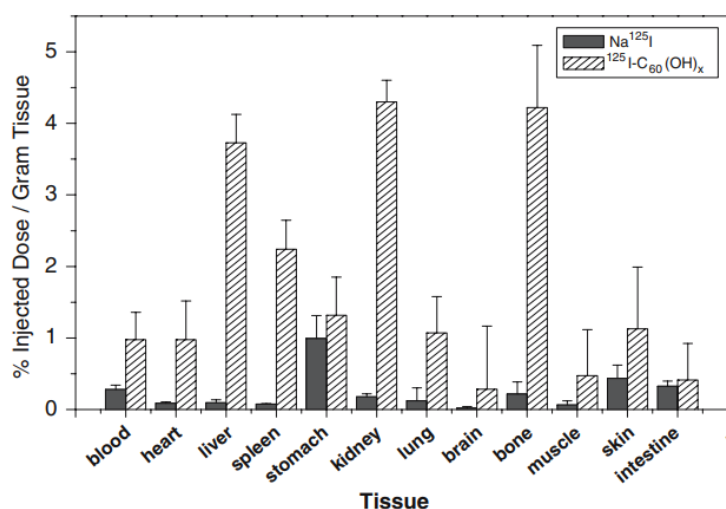

**Figure 12:** Comparison of the biodistribution between  $^{125}I-C_{60}(OH)_x$  and  $Na^{125}I$  in normal Kunming mice at 6 h post dosing (Ji *et al.*, 2006).



Figure 12 shows the distribution of  $^{125}\text{I}-\text{C}_{60}(\text{OH})_x$  in normal mice, at 6 h post-dosing the levels increased in the liver, spleen, kidney, and bone tissues. These findings indicate that systemically available hydroxylated fullerenes can be distributed to various organs in the body.

### **Hydrated forms of hydroxylated fullerenes**

No studies were submitted for the hydrated forms of hydroxylated fullerenes.

### **SCCS overall comments in toxicokinetics**

#### *Fullerenes*

##### Oral route

According to the studies reviewed by Hendrickson *et al.* (2014), systemically available fullerenes have been found in liver, kidney, and spleen after oral exposure of test animals. Fullerenes were mainly excreted in faeces.

In a toxicity study in rats by Takahashi *et al.* (2012) (see section 3.4.4), after oral exposure Fullerene C60 was not detected in the liver, spleen or kidney at the end of the administration period (day 30) and after the 14 days recovery period.

During the commenting period, the Notifier has submitted a Preliminary Study of [ $^{14}\text{C}$ ]Fullerene C60 administered as a single oral dose in male rats that was performed after the animal testing ban.

The authors of this study do not provide any information regarding oral bioavailability. Nevertheless, results showed that [ $^{14}\text{C}$ ]fullerene C60 is absorbed from the gastrointestinal tract and systemically distributed. [ $^{14}\text{C}$ ] fullerene C60 is distributed in different tissues in rat, mainly liver, kidneys, fat, mesenteric lymph node. Despite a long half-life in blood (109 hours), results at 24h showed that the radioactivity concentration in tissues is less than 0.5% of the administered dose. The SCCS also note that the cumulative excretion of radioactivity (urinary and faecal excretion) was 93% of the administered radioactivity dose at 24 h, suggesting a low potential of accumulation. As this study was performed after the animal testing ban, and it is not known whether it was performed for drug or cosmetics purpose, it was not further considered. However, it was noted that the study results are in line with reports in the open literature.

##### Inhalation route

The SCCS has noted that information has been provided on inhalation exposure but since this ingredient is not foreseen for an application in a spray product, the information provided on inhalation exposure has been noted but not considered relevant for this opinion.

##### IV route

According to the studies reviewed by Hendrickson *et al.* (2014), the liver is the main target organ and the site of accumulation of fullerenes after intravenous administration.

In summary, the limited toxicokinetics data indicate that systemically available fullerenes will be distributed to various organs in the body, with a potential for accumulation in the lungs and the liver.

#### *Hydroxylated Fullerenes*

For the hydroxylated fullerenes, the Notifier reported that *in-silico* assessment was carried out of the ADME properties of fullerenes, and hydroxylated fullerenes C60(OH) $_x$

[x=24,30,40,50,60]. Although the Notifier had indicated that details were provided in a report, this information could not be found in any of the submitted documents.

From the brief available summary of the *in-silico* assessment, the SCCS has noted that:

- *in-silico* ADME assessment was not performed for 3HFWC due to the lack of SMILES identifiers.
- the results of the assessment carried out for fullerenes and hydroxylated fullerenes showed contradictory results, where one *in-silico* tool predicted hydroxylated fullerenes to be poorly resorbed, and two other tools indicated good intestinal resorption for most of the substances.

The SCCS also noted that, for the *in silico* ADME assessment, the Notifier had considered fullerenes and hydroxylated fullerenes as chemical substances. Considering that these materials also have a particle nature, the SCCS is of the view that the *in silico* tools used to predict ADME properties are not appropriate in such cases as they have been developed and tested/validated for predicting ADME behaviour of chemicals, not of (nano)particles. Also, in view of the contradictory results from different *in silico* tools, the SCCS considers that the information from *in silico* assessment is not of any use for safety assessment of fullerenes and hydroxylated fullerenes.

### 3.3 EXPOSURE ASSESSMENT

#### 3.3.1 Function and uses

Data on function and uses were not provided by the Notifiers.

During the commenting period one of the Notifiers has reported that 3HFWC is currently used in a moisturising fluid (skin tonic) and an anti-aging cream. In the future, the scope of application may include skin lotions, deodorants, hand creams, and other anti-aging products. The Notifier also reported that the starting material of HFWC is 99.99% pure hydroxylated C60 fullerene. Due to the lack of adequate INCI name in CosIng and CPNP portal that describes 3HFWC complex as a unique entity, the concentrations of 3HFWC in the notified products (see table below) was at the time of notification expressed as concentration of hydroxylated fullerene (C<sub>60</sub>(OH)<sub>30-50</sub>), which is the starting material in the production of 3HFWC and a component of 3HFWC, and not as the concentration of 3HFWC. The correct concentration of 3HFWC in the notified finished products is 0.260% (instead of 0.015%) and 0.0416% (instead of 0.0024%).

#### SCCS comment

Detailed data on function and uses for fullerenes, hydroxylated fullerenes and the hydrated forms of hydroxylated fullerenes must be provided.

The SCCS has retrieved the following information from 19 notifications uploaded on the CPNP portal by the Notifiers:

Notification No.	Ingredient/CAS No	Cosmetic Product	Concentration	Exposure route
1003493	(C60-Ih)[5,6]fullerene/ 99685-96-8	1279 RF 1 Face Cream	0.0002 % w/w	Dermal/ Leave on
1003557	C60-Ih)[5,6]fullerene/ 99685-96-8	1280 RF 2 Face Cream	0.0002 % w/w	Dermal/ Leave on



## Opinion on Fullerenes, Hydroxylated Fullerenes and hydrated forms of Hydroxylated Fullerenes (nano)

1003558	C60-Ih)[5,6]fullerene/ 99685-96-8	1281 RF 3 Face Cream	0.0002 % w/w	Dermal/ Leave on
1003559	C60-Ih)[5,6]fullerene/ 99685-96-8	1282 RF 4 Face Cream	0.0002 % w/w	Dermal/ Leave on
1003560	C60-Ih)[5,6]fullerene/ 99685-96-8	1283 RF 5 Face Cream	0.0002 % w/w	Dermal/ Leave on
1003561	C60-Ih)[5,6]fullerene/ 99685-96-8	1285 RF 1 Face Serum	0.0002 % w/w	Dermal/ Leave on
1003562	C60-Ih)[5,6]fullerene/ 99685-96-8	1285 RF 2 Face Serum	0.0002 % w/w	Dermal/ Leave on
1003563	C60-Ih)[5,6]fullerene/ 99685-96-8	1287 RF 1 Face Mask	0.0002 % w/w	Dermal/ Leave on
1003564	C60-Ih)[5,6]fullerene/ 99685-96-8	1287 RF 2 Face Mask	0.0002 % w/w	Dermal/ Leave on
1003565	C60-Ih)[5,6]fullerene/ 99685-96-8	Face care products other than face mask/ 1288 RF 1 Skin Lightening	0.0002 % w/w	Dermal/ Leave on
1003566	C60-Ih)[5,6]fullerene/ 99685-96-8	Face care products other than face mask/ 1289 RF 2 Skin Lightening	0.0002 % w/w	Dermal/ Leave on
1003567	C60-Ih)[5,6]fullerene/ 99685-96-8	1277 RF 1 Eye Contour	0.0002 % w/w	Dermal/ Leave on
1003568	(C60-Ih)[5,6]fullerene/ 99685-96-8	1278 RF 2 Eye Contour	0.0002 % w/w	Dermal/ Leave on
1004108	Hydroxylated Fullerenes/ not reported	Face care products/ Anti-Ageing Essential Complex	0.0024 % w/w	Dermal/ Leave on
1004204	Hydroxylated Fullerenes/ not reported	Other skin care products/ Hyperlight Fusion - Intensive Body Sculptor- Anti- cellulite body lotion	0.0024 % w/w	Dermal/ Leave on
1004546	(C60-Ih)[5,6]fullerene/ 99685-96-8	Global Anti-ageing Face Cream	0.0002 % w/w	Dermal/ Leave on
1004547	(C60-Ih)[5,6]fullerene/ 99685-96-8	Illuminating Eye Contour Cream	0.0002 % w/w	Dermal/ Leave on
1004548	(C60-Ih)[5,6]fullerene/ 99685-96-8	Neck & Décolleté Firming Cream	0.0002 % w/w	Dermal/ Leave on
1004864	Hydroxylated Fullerenes/ not reported	Body care products/ Hyperlight Fluid Fusion - Subcellular Essential Complex - Personal Care Nanolotion	0.015 % w/w	Dermal/ Leave on

From the received notifications, it is not clear whether the concentration of 0.0002 % w/w is related to fullerene C60 or to "raw fullerene powder", which is a mixture of fullerene C60 and fullerene C70. The concentration of HFWC in cosmetic products as it is now reported by the Notifier is a theoretical concentration based on the starting materials.

### 3.4 TOXICOLOGICAL EVALUATION

#### Fullerenes

As reported by the Notifier on Fullerenes, the raw fullerene powder provided by them is a mixture of Fullerene C60 and Fullerene C70. The content of Fullerene C60 ranges approximately from 70 to 80% and the concentration of other fullerenes such as Fullerene C82 and oxygenated fullerene is less than 1%. As shown in Table 1, both Fullerene C60 and C70 particles are composed only of carbon atoms, and their physical properties such as solubility are similar. Based on the chemical similarity between C60 and C70, the Notifier speculates that C70 possesses the same physiological activity, transdermal absorption, and safety as C60. The Notifier also stated that the National Institute of Advanced Industrial Science and Technology in Japan reported in a study published by Horie *et al.* (2013) that the safety of Fullerene C60 and Fullerene C70 are equivalent (Table 17).

**Table 18:** *In vitro* evaluation of cellular influences induced by stable fullerene C70 medium dispersion: Induction of cellular oxidative stress (Horie *et al.*, 2013)

Comparison of cellular influences induced by C <sub>60</sub> and C <sub>70</sub> .								
	HaCaT				A549			
	C <sub>60</sub> <sup>a</sup>		C <sub>70</sub>		C <sub>60</sub> <sup>a</sup>		C <sub>70</sub>	
Concentration of fullerene (µg mL <sup>-1</sup> )	14.2	6.6	13.4	5.4	14.2	6.6	13.4	5.4
MTT conversion (24 h) (% of control)	104.9 ± 4.6	108.4 ± 6.4	96.8 ± 9.1	102.4 ± 6.2	86.4 ± 3.5	97.3 ± 8.9	90.4 ± 8.1	96.6 ± 7.6
Colony forming ability (% of control)	107.8 ± 13.6	97.8 ± 11.3	59.6 ± 11.1**	90.2 ± 15.0	71.1 ± 11.4**	80.9 ± 12.7**	77.3 ± 16.6**	84.1 ± 6.9**
Intracellular ROS level (24 h)	1.9 ± 0.3	1.25 ± 0.14	2.13 ± 0.1**	1.40 ± 0.04**	1.22 ± 0.24	0.95 ± 0.08	0.99 ± 0.04	1.22 ± 0.1**
Intracellular lipid peroxidation level (24 h)	1.97 ± 1.0*	2.31 ± 1.0*	1.4 ± 0.3*	1.9 ± 0.02**	2.02 ± 0.3**	2.16 ± 0.5**	1.85 ± 0.2**	2.09 ± 0.2**

The value of the intracellular ROS level and lipid peroxidation level were indicated as a relative value to the unexposed cells.  
<sup>a</sup> These values were reported previously except lipid peroxidation level. Horie *et al.* (2010).  
\* P < 0.05 (vs. unexposed cells, Dunnett, ANOVA).  
\*\* P < 0.01 (vs. unexposed cells, Dunnett, ANOVA).

All safety evaluation studies submitted by the Notifier were conducted using raw fullerene powder (mixture of Fullerene C60 and Fullerene C70), while the safety evaluations reported in the externally cited references mainly used Fullerene C60. However, based on the equivalence between C60 and C70 mentioned above (Table 18), the Notifier decided to use equally both internal and external safety data in the evaluation of safety of fullerenes.

#### SCCS comment

Considering the similarities between fullerenes C60 and C70 in terms of chemical composition, close structural analogy, and toxicological aspects tested via *in vitro* assays, the SCCS has accepted the Notifier's justification for data read-across between the two fullerenes.

In this regard, the SCCS is also aware of two studies that reported a disparity between C60 and C70 fullerenes in terms of the potential to induce reactive oxygen species (ROS) in exposed cell lines *in vitro* (Proskurnina *et al.*, 2021), and ROS production and photoinduced cleavage of supercoiled plasmid pBR322 DNA (Liosi *et al.*, 2021). The study by Liosi *et al.* (2021) used a conjugate of fullerene-polyethylene glycol, and not (neat) fullerenes that are under current assessment. However, both *in vitro* studies reported that C60 is more active in inducing ROS production, and eliciting DNA damage, than C70. These findings further support the SCCS consideration of an equivalence for data read-across between C60 and C70 because most studies were performed with fullerenes C60, and from a risk assessment point of view they will cover the worst case for a fullerene mixture composed of C60 (70-80%) and C70 (20-30%) fullerenes.

**3.4.1 Acute toxicity****3.4.1.1 Acute oral toxicity****Fullerenes**

The following reports and studies were provided by the Notifier(s):

In a study by Mori *et al.* (2006), Fullerenes (mixture of C60 and C70, fullerite, sublimed technical grade, purity: 99.5%, supplied by one of the Notifiers) were administered once orally at a dose level of 2000 mg/kg to male and female Sprague–Dawley rats. The study was conducted in compliance with the guiding principles for the care and use of laboratory animals by the Japanese Pharmacological Society. No deaths were observed and the body weights in both sexes of the 2000 mg/kg group increased in a similar pattern to the control group.

LD50 > 2000 mg/kg.

Ref: Mori *et al.* (2006).

**A Single Dose Oral Toxicity Study of Fullerenes in Rat**

Guideline:	Non-Guideline study - conducted following Standards for Conduct of Nonclinical Studies on the Safety of Drugs (MHW, Ordinance No. 21, March 26, 1997)
Species/strain:	Rats/ CD(SD)IGS, 6 weeks old at the time of administration
Group size:	2 groups of 5 males and 5 females
Test substance:	Fullerene (powder)
Batch:	Lot No. 040406
Purity:	66.4 ± 0.78 % (impurities not mentioned)
Vehicle:	Water containing 0.5% carboxymethylcellulose-sodium salt and 0.1% Tween 80
Dose levels:	2000 mg/kg bw; 10 ml/kg body weight
Administration:	Oral gavage (single)
GLP:	In compliance
Study period:	21 May – 30 November 2004

Results: A single dose of fullerene (powder) suspended in water was administered via oral gavage at 2000 mg/kg bw (10 ml/kg bw) to two groups of 3 females each. No animal died during the 14-day post-administration observation period. Body weights were comparable to the control group. Necropsy did not show any abnormal findings in any of the animals. Coloured stool was noted on day-1 in both sexes and day-2 in one male, which was attributed to excretion of the test substance. It was concluded that fullerene has no acute toxicity and the lowest lethal dose is above 2000 mg/kg bw in both sexes.

Ref: B040373: A Single Dose Oral Toxicity Study of Fullerenes in Rat

**Acute Oral Toxicity Study of Water-Soluble Fullerenes in Rat**

Guideline:	OECD Guideline no. 423:2001
Species/strain:	Rats/ CD(SD)IGS, 8-week-old

---

Group size:	2 groups of 3 females each
Test substance:	mentioned as 'water-soluble fullerenes (synonym fullerene)'
Batch:	Not given
Purity:	Not given. The composition of test substance is mentioned as to contain 0.365% C60 fullerene in excipient polyvinylpyrrolidone (PVP)
Vehicle:	Water
Dose levels:	2000 mg/kg bw; 10 mL/kg body weight
Administration:	Oral gavage (single)
GLP:	In compliance
Study period:	24 February – 12 July 2005

Results: A single dose of fullerene suspended in water was administered via oral gavage at 2000 mg/kg bw (10 ml/kg bw) to two groups of 3 female rats each. The animals were fasted from the evening before administration. No dead animals were recorded during the 14-day post-administration observation period. Body weights showed normal growth. Necropsy did not show any abnormal findings in any of the animals. Coloured stool was noted on day2, which was attributed to excretion of the test substance. It was concluded that the test substance has no acute toxicity under the test conditions, and hence can be regarded as category 5 (unclassified) in regard to acute oral toxicity.

Ref: B040965: Acute Oral Toxicity Study of Water-Soluble Fullerenes in Rat; SDS\_Radical Sponge170331; FULLERENES toxicity profile

### SCCS comment

The raw fullerene powder used in the single dose oral toxicity study of Fullerenes contains ~66% C60 fullerene; from the test reports it is unclear whether the remaining content is C70 or another material. In view of the results from this study, the SCCS agrees with the Notifier that raw Fullerene powder is not acute toxic via the oral route.

The Notifier submitted an additional acute oral toxicity study of water-soluble fullerenes in rat (compliant with OECD Guideline 423) which was conducted by using the formulation (Radical sponge®) and therefore it has not been included in this safety evaluation.

### Hydroxylated fullerenes

The following reports and studies were provided by the Notifier(s):

An *in-vivo* study on acute toxicity of C<sub>60</sub>(OH)<sub>30</sub> from 2012, after intravenous administration to female Sprague-Dawley rats observed no clinically significant chemistry changes after IV treatment with 10 mg/kg dose. These experiments suggest that fullerenol is well tolerated after IV administration to rats (administered dose was 10 mg/kg).

According to the Notifier, based on the available studies, it can be concluded that the applied concentrations and exposure (potentially achievable biological exposure) in practice is far below the demonstrated tolerated acute dose in rodents.

Ref: Monteiro-Riviere *et al.* (2012); 281\_safety\_file\_2020-3-12-18-44-18

### Study: Acute toxicity study of Hydroxylated Fullerene C<sub>60</sub>(OH)<sub>30-50</sub>

NOTE: Certified translation from Serbian into English

Study number: LMEM-AT-03/2022

---

Guideline:	Study performed according to OECD TG no 423, EU Directive 2010/63/EU, and ISO 10993-2:2006 Animal welfare requirements.
Species/strain:	Mouse, NMRI HAN, 5 weeks of age
Group size:	2 groups of 6 experimental and 6 controls (animals of both genders were used).
Test substance:	Hydroxylated Fullerene C <sub>60</sub> (OH) <sub>30-50</sub>
Batch:	Laboratory sample
Purity:	Not given. The composition of test substance is mentioned with a concentration of 0.15 g/L
Vehicle:	Not given
Dose levels:	7.5 mg/kg
Administration:	Gastric probe (1 mL in two applications of 0.5 mL in 24 hours)
GLP:	-
Study period:	10 May – 24 May 2022

Results: Treated animals did not show signs of intoxication immediately upon administration, or later during the period of observation. Treated experimental animals behaved quite normally (just like the control group). Behaviour was also normal on intentional standard provocation tests. No neurological misbehaviour was noticed. Hygienic behaviour was normal. Eyes were clear and clean; the nostrils and other natural orifices were clean.

Experimental animals did not exhibit any abnormal reactions in relation to food and water. They ate and drank water in a normal manner. No animals died during the experimental period.

After day 14 of the experiment, all animals were sacrificed and pathoanatomical examination was performed. Macroscopic examination of organs and tissues (liver, spleen, kidney, stomach, small intestines, lungs, heart, and brain) did not show any pathological changes in any animal.

Based on clinical observation of the experimental animals during the 14-day period and on subsequent pathoanatomical examination, it was concluded that the test substance Hydroxylated Fullerene C<sub>60</sub>(OH)<sub>30-50</sub> applied at a dose of 7.5 mg/kg does not cause any toxic effects in test animals.

Ref: Acute toxicity – ENG Report HF

### SCCS comment

According to the Notifier, the data produced in this study are not specifically intended for demonstrating the safety of substance for use in cosmetics, but in concordance with the recommendation of Directive 2001/83/EC of the European Parliament and of the Council of 6 November 2001 on the Community code relating to medicinal products for humans. However, in the absence of an effect at the used single dose no conclusions on the toxicity can be drawn. An increasing dose needs to be used to determine an acute toxic level. In contrast to what was stated in the study reports, these studies were not performed according to OECD TG 423, and therefore the results of this study do not allow a conclusion on acute toxicity.

### Hydrated forms of Hydroxylated Fullerenes

The following report was provided by the Notifier(s):

#### Investigation of acute toxicity of 3HFWC

Study number:	LMEM-AT-01/2022
Guideline:	Study performed according to OECD TG no 423, EU Directive 2010/63/EU, and ISO 10993-2:2006 Animal welfare requirements.
Species/strain:	Mouse, NMRI HAN, 5 weeks of age
Group size:	2 groups of 6 experimental and 6 controls (animals of both genders were used).
Test substance:	Hyper-Harmonized Hydroxylated Fullerene Water Complex-3HFWC
Batch:	Laboratory sample

Purity:	Not given. The composition of test substance is mentioned with a concentration of 0.15 g/L
Vehicle:	Not given
Dose levels:	7.5 mg/kg
Administration:	Gastric probe (1 mL in two applications of 0.5 mL in 24 hours)
GLP:	-
Study period:	10 May – 24 May 2022

Results: Treated animals did not show signs of toxic reaction immediately after application, or in the later course of observation. They behaved normally in accordance with what is expected for their species, gender, age and environment. The reaction of animals to provoked behaviour was normal and expected. No signs of neurological deficits were observed. The hygienic behaviour of the animals was normal. The eyes were clear and clean, the nostrils and other natural orifices were clean.

Experimental animals did not exhibit any eating disorders. They ate and drank water as usual. No animals died during the experimental period.

After 14 days from the start of the experiment, all animals were sacrificed, and a macroscopic examination was performed. Macroscopic examination of organs and tissues (liver, spleen, kidney, stomach, intestines, lungs, and heart) did not reveal any changes in any animal.

Based on clinical observation of the experimental animals and the macroscopic examination of the organs after 14 days from the start of the experiment, it was concluded that the investigated product Hyper Harmonized Hydroxylated Fullerene Water Complex-3HFWC at a dose of 7.5 mg/kg does not cause toxic effects in tested animals.

Ref: Acute toxicity – ENG Report 3HFWC.

#### **SCCS comment**

According to the Notifier, the data produced in this study are not specifically intended for demonstrating the safety of substance for use in cosmetics, but in concordance with the recommendation of Directive 2001/83/EC of the European Parliament and of the Council of 6 November 2001 on the Community code relating to medicinal products for humans. However, in the absence of an effect at the used single dose no conclusions on the toxicity can be drawn. An increasing dose needs to be used to determine an acute toxic level. In contrast to what was stated in the study reports, these studies were not performed according to OECD TG 423, and therefore the results of this study do not allow a conclusion on acute toxicity.

#### **SCCS overall comment on acute oral toxicity**

The limited available information indicates that C60/C70 fullerenes are not likely to be acutely toxic. The acute oral toxicity studies provided by one of the Notifiers for hydroxylated fullerenes and hydrated forms of hydroxylated fullerenes do not allow to draw a conclusion on acute toxicity.

### **3.4.1.2 Acute inhalation toxicity**

#### **Fullerenes:**

According to the Notifier, considering the nature of the used cosmetic material (the Fullerene water dispersion) the inhalation route of exposure is out of concern, thus the available data about the inhalation toxicity were not analysed.

Ref: FULLERENES toxicity profile

#### **SCCS comment**

The SCCS has noted the Notifiers' reasoning for not carrying out inhalation exposure assessment and has therefore not considered the use of the materials in inhalable products in this safety assessment.

**3.4.2 Irritation and corrosivity****Fullerenes*****Skin irritation***

The following two reports were provided by the Notifier(s):

**1. Primary dermal irritation study of fullerenes in rabbits**

Guideline: /  
Substance: 0.5 g fullerenes moistened with 0.3 ml propyleneglycol  
Lot: 040406  
Application: 0.5 g per test site 24 hrs on intact and abraded skin  
Animals: 3 Japanese white rabbits  
Results: No skin reactions upon removal of patches and at 48 and 72 hrs.  
Year: 2004

Ref: Primary dermal irritation study in rabbits  
Mitsubishi Chemical Safety Institute 2004, B040374

**2. A 14-day cumulative skin irritation study of fullerenes in rabbits**

Guideline: /  
Substance: 10% fullerenes w/v in propyleneglycol  
Lot: 040406  
Application: 0.2 mL per test site without occlusion, daily 14 days  
Animals: 5 Japanese white rabbits  
Results: No skin reactions.  
Year: 2004

Ref: A 14-day cumulative skin irritation study of fullerenes in rabbits  
Mitsubishi Chemical Safety Institute 2004, B0403745

**SCCS comment**

The raw fullerene powder consists of about 66% fullerene C60. From the test reports, it is unclear whether the remaining 34 % is Fullerene C70 or another material. The primary test was performed in 3 animals; therefore, it can be regarded as a preliminary test, *i.e.* only indicative of the absence of irritation potential. The cumulative test indicates absence of potential for skin irritation.

**3. Occlusive human patch-test study, 24 hours, in 20 subjects**

Guideline: /  
Test material: Suspension of 3% natural fullerene in petrolatum  
Control: saline and white petrolatum  
Product ID: 10970, Product code 080508-01  
Application: 1 cm<sup>2</sup> under occlusion, during 24 hours in Finn chamber  
Reading: 2 hrs and 24 hrs after patch removal  
Subjects: 20 humans (2 m, 18 f)  
Year: 2020  
Study No: NDR-0007236 and 4200162  
Results: None of the subjects presented clinical signs.

Ref: NDR-0007236NF Human Patch Test

The following published studies were referenced by the Notifier(s):



### 1. Dermal skin irritation study with Fullerene C60

A Guinea pig skin irritation study according to OECD Guideline 404 with 10% fullerenes in olive oil showed no skin reactions.

Ref: Ema *et al.* (2013) (study conducted in 2010)

### 2. Primary and cumulative skin irritation tests according to the Draize method

The tests were conducted with highly purified fullerenes (a mixture of C60 and C70 fullerite) in 3 resp. 5 rabbits. Dose: 0.5 g in 0.3 ml propyleneglycol (PG) for the primary test and 20 mg in 0.2 ml PG for the cumulative test. Results: no skin reactions.

Ref: Aoshima *et al.* (2009)

### 3. Human patch test study

A 24-hour patch test (Finn chamber) with 0.01 g highly purified fullerenes on the upper arms in 55 human volunteers showed no skin reactions.

Ref: Aoshima *et al.* (2009)

### 4. Human patch-test study

A brief study report on a 24-hour patch-test in 55 human volunteers with 0.01 g fullerene (no further specification) showed no skin reactions.

Ref: Nichimoko No. 16027

### SCCS comment

It seems that the Aoshima *et al.* (2009) publication presents the same data as the studies presented in the B040374, B040375 and Nichimoko 16027 reports (see above). Overall, the studies indicate that the test material is not a skin irritant.

### Eye irritation

The following study was provided by the Notifier:

#### Primary eye irritation study in rabbits

Study nr: B040376-1  
Guideline: Standard for conduct of nonclinical studies on the safety of drugs, Japan (MHW, Ordinance No 21, March 26, 1997), Draize method.  
Test material: Fullerene, lot nr 040406, black powder, purity 66.4 %.  
Animals: 6 male Japanese White rabbits  
Schedule: 3 animals' right eye exposed without washing after application, 3 animals right eye exposed followed by rinsing after 30 seconds  
Application: 0.1 g test substance in lower conjunctival sac  
Assessments: 1, 24, 48, 72 hrs and 4 days after application  
Scoring: Draize method  
Date: 2004  
Results: Weighted mean score (Draize) 6.0, indicating eye irritating potential attributable to physical effects from powder.

Ref: Primary eye irritation study in rabbits  
Mitsubishi Chemical Safety Institute 2005

### SCCS comment

From the test report, the composition of the Fullerene powder is unclear. From other reports, it can be deduced that it is about 66% Fullerene C60, but it is unclear whether the remaining 34% is Fullerene C70.



## Hydroxylated fullerenes

### *Skin irritation:*

The following information was provided by the Notifier:

An OECD compliant study on reconstructed human skin with hydroxylated fullerene powder (C<sub>60</sub>(OH)<sub>n</sub>, n=30-60) showed no skin irritation potential

Guideline: OECD 439  
Test material: Hydroxylated fullerene C<sub>60</sub>(OH)<sub>n</sub>, n=30-50, as 99.9% pure beige/yellow powder  
Batch: 21C0226  
Control: DPBS buffer (negative control) and SDS 5% aq (positive control)  
Tissue: human epidermis.  
Nr: 3 tissues for main test, 3 tissues for neg control, 3 tissues for positive control  
Historic data: negative and positive controls compatible with current test results  
Exposure: 60 minutes  
Result: Tissue viability (optical density MTT) was 85%, indicating non-irritant.

Ref: Laus version2 21102502G840 (2021)

### *Eye irritation:*

The following information was provided by the Notifier:

An OECD compliant study on reconstructed human cornea-like epithelium (RhCE) with hydroxylated fullerene powder (C<sub>60</sub>(OH)<sub>n</sub>, n=30-60) showed that the test item is an eye irritant

Guideline: OECD 492  
Test material: Hydroxylated fullerene C<sub>60</sub>(OH)<sub>n</sub> (n=30-50) 99.9% pure beige/yellow powder  
Batch: 21C0226  
Control: Sterile demi water (neg.) and methyl acetate  
Tissue: Reconstructed human corneal epithelium  
Nr: 2 tissues for main test, 2 tissues for neg control, 2 tissues for positive control  
Historic data: negative and positive controls compatible with current test results  
Exposure: 6 hours  
Result: Tissue viability (optical density, MTT) reduced to 8.1%, indicating irritant

Ref: Laus version2 21102502G891 (2022)

## Hydrated forms of hydroxylated fullerenes

The following information was provided by the Notifier:

An OECD compliant study on reconstructed human skin with HFWC shows no skin irritation potential.

Guideline: OECD 439  
Test material: Hydroxylated fullerene C<sub>60</sub>(OH)<sub>30-50</sub> @(H<sub>2</sub>O)<sub>144-2528</sub> 0.015% in water  
Batch: 01-2021-07-13  
Control: DPBS buffer (negative control) and SDS 5% aq (positive control)  
Tissue: Reconstructed human epidermis.  
Nr: 3 tissues for main test, 3 tissues for negative control, 3 tissues for positive control  
Historic data: Negative and positive historical controls compatible with current test results  
Exposure: 60 minutes  
Result: Relative tissue viability (optical density MTT) 122%, indicating non-irritant.

Date: 2022

Ref: Laus version1 21092301G840 (2022)

**Eye irritation:**

The following information was provided by the Notifier:

An OECD compliant study on reconstructed human cornea-like epithelium (RhCE) with HFWC shows that the test item is not an eye irritant.

Guideline: OECD 492  
 Test material: Hydroxylated fullerene C60(OH)<sub>30-50</sub> @(H<sub>2</sub>O)<sub>144-2528</sub> 0.015% in water  
 Batch: 21C0226  
 Control: Sterile demi water (neg) and methyl acetate  
 Tissue: Reconstructed human corneal epithelium  
 Nr: 2 tissues for main test, 2 tissues for negative control, 2 tissues for positive control  
 Exposure: 28 minutes  
 Result: Mean relative tissue viability (optical density, MTT) 103%

**SCCS overall comment on skin and eye irritation**

For raw fullerene powder (mixture of C60 and C70) and hydroxylated fullerene, the tests showed no skin irritation potential. The eye irritation from raw fullerene powder is likely due to physical effects of the powder. The raw fullerene powder contains about 66% C60 fullerene; from the test reports it is unclear whether the remaining content is C70 or another material.

The available information on hydroxylated fullerene showed eye irritation potential. Hydrated forms of Hydroxylated Fullerenes (HFWC) showed no skin and eye irritation at the tested concentration (0.015%).

During the commenting period the Notifier stated that, contrary to the test report, this concentration should be 0.26% in 3HFWC complex substance manufactured, since the concentration reported in the study was expressed as concentration of the starting material (hydroxylated fullerene 0.015% or 0.15 g/L).

**3.4.3 Skin sensitisation****Fullerenes**

The following information was provided by the Notifier:

A Guinea pig skin sensitisation study according to OECD Guideline 406 with 10% fullerenes in olive oil showed no skin reactions.

Ref: Ema *et al.* (2013) (study conducted in 2010)

**Guinea pig adjuvant and patch test study**

Guideline: /  
 Test material: Raw fullerenes powder 50% w/v in propyleneglycol (PG) for induction.  
 Raw fullerenes powder 25% w/v in propyleneglycol for challenge.  
 Propyleneglycol (PG) for control induction  
 DNCB 0.05% w/v in acetone as positive control substance  
 FCA as adjuvant intradermally on each induction site  
 Lot: 040406: raw fullerene powder containing 66.4% C60  
 Animals: 30 male guinea pigs, Hartley strain  
 Schedule: 10 animals induced with fullerenes, 10 with propyleneglycol,  
 5 with DNCB and 5 with acetone on day 1 and 9.  
 10% SLS patch on all induction sites on day 8.

Year: Challenge on day 22  
2004  
Results: No skin reactions on the sites challenged with fullerenes or PG.  
Skin reactions in all animals on the sites challenged with DNCB.

Ref: study report B040377

### Human repeat patch-test study

Test material: Suspension of 3% natural fullerene in petrolatum  
Control: saline  
Product ID: 10970, Product code 080508-01  
Application: as is, 1 cm<sup>2</sup> under occlusion  
Subjects: 107 humans (21 m, 86 f) enrolled, 54 completed the study  
Induction: 3x per week same spot during 48 hrs on the back during 3 weeks.  
Challenge: 10 days after the last induction, application on a site that had not been used for induction.  
Year: 2020  
Results: None of the subjects presented clinical signs at the challenge site.

Ref: NDR-0006973

### SCCS comment

The Guinea pig adjuvant test showed that the tested fullerenes are not sensitizers. The raw fullerene powder used in this study contains about 66% C60 fullerene; from the test reports it is unclear whether the remaining content is C70 or another material.

The repeat human patch-test study is a modification of the existing HRIPT protocols, however the SCCS has expressed its ethical concerns on conducting human skin sensitisation tests, such as the HRIPT (SCCNFP, 2000; SCCP, 2008; SCCS, 2015). Because the high number of subjects who did not complete the study raises uncertainties in the interpretation of the results, the SCCS considers the results as inconclusive. While the test report does not specify the composition of the raw fullerene, the Notifier stated that it was derived from a plant and contained about 66% C60. The chemical nature of the remaining content is unclear.

### Hydroxylated fullerenes

The following information was provided by the Notifier:

#### Are-Nrf-2 Luciferase test (Keratinosens)

Guideline: OECD 442 D  
Test material: C<sub>60</sub>(OH)<sub>n</sub>, n=30-50  
Concentrations: 3.91 - 8000 μM  
Batch: 21C0226  
Date: 2021  
Ref: Zurko-version2 – VT\_SEG-ARE.NRF2-01\_664\_\_21\_002 (2021)  
Result: inconclusive because of no clear dose-response and because the viability at max concentration did not reach cytotoxicity.

#### Direct Peptide Reactivity Assay (DPRA)

Guideline: OECD 442 C  
Test material: Hydroxylated fullerene c60(OH)<sub>n</sub>, n=30-60 powder 8000 μMol  
Concentration: 471 mg powder in 3 ml water  
Depletion: Cys peptide 29.98%, Lys peptide 3.36%  
Result: Positive, low reactivity.  
Ref: Laus-version2 21102502G875 (2022)

**SCCS comment**

The low reactivity and the turbidity in the Cys sample cast doubt on the DPRA result.

**Hydrated forms of hydroxylated fullerene-Water Complex**

The following information was provided by the Notifier:

**Are-Nrf-2 Luciferase test (Keratinosens)**

Guideline: OECD 442D  
Test material: Hydroxylated fullerene C60 (C<sub>60</sub>(OH)<sub>30-50</sub>) 10 g ad ultra-pure water 10 L, called Hyperharmonised Fullerene-Water Complex (HFWC)  
Batch: 01-2021-12-07  
Concentration: range from 0.49 µg/ml to highest concentration 1000 µg/ml  
Date: 2022  
Test result: Negative  
Ref: Zurko-version1 (2022) 22032914G888

**h-CLAT test**

Guideline: OECD 442E  
Test material: Hydroxylated fullerene C60(OH)<sub>30-50</sub> @(H<sub>2</sub>O)<sub>144-2528</sub> 0.015% in water  
Batch: 01-2021-10-14  
Concentr: highest concentration tested 1.5 µg/mL  
Date: 2022  
Result: Negative - no upregulation of markers at the highest test concentration  
Ref: Laus-version1 22032914G888 (2022)

**Direct Peptide Reactivity Assay (DPRA)**

Guideline: OECD 442 C  
Test material: Hydroxylated fullerene C60(OH)<sub>30-50</sub> @(H<sub>2</sub>O)<sub>144-2528</sub> 0.015% in water  
Concentration: 100 mM  
Reactivity: Cys peptide 100%, Lys peptide 3.68%  
Result: Positive

Ref: Laus-1 21092301G875 (2022)

**SCCS comment**

The description of the test material used in the Are-Nrf2 Luciferase test (Keratinosens) report seems to refer to hydroxylated fullerene and not to the hydrated forms of hydroxylated fullerene (3HFWC). During the commenting period the Notifier stated that this material was 3HFWC.

The test concentration used in the DPRA is not clear in the absence of a well-defined specification for the molecular weight.

The test concentrations used in the hCLAT tests appear to be too low.

During the commenting period the Notifier stated that, contrary to the description in the report, the concentration of 3HFWC complex substance manufactured was 0.26%, since the concentration reported in the study report was expressed as concentration of the starting material (0.015% or 0.15 g/L).

**SCCS overall comment on sensitisation**

A Guinea pig study indicates the absence of sensitisation potential of fullerenes. For hydroxylated fullerene and hydrated forms of hydroxylated fullerenes, the test results do not clearly exclude a sensitising potential.

### 3.4.4 Repeated dose toxicity

#### Fullerenes

As reported by one of the Notifiers, repeated-dose toxicity studies with the raw fullerene powder have never been conducted in accordance with the guidelines. On the other hand, in external references, there are two important reports of the repeated dose studies conducted by affiliated organizations of the Japanese Government. The first study by Shinohara *et al.* (2010), covered repeated inhalation to determine the toxicokinetics of Fullerene C60 using rats conducted by The National Institute of Advanced Industrial Science and Technology (AIST) belonging to the Japanese government. The second study by Takahashi *et al.* (2012) covered repeated oral safety evaluation of Fullerene C60 using rats conducted by National Institute of Health Sciences belonging to the Japanese government. These reports are also cited in the OECD Document ENV/JM/MONO(2016)21.

In the study by Takahashi *et al.* (2012), a repeated oral toxicity study on Fullerene C60 was conducted using rats in accordance with the test guideline of the Japanese Chemical Control Act. In this study, the NOAEL was reported to be 1000 mg/kg-bw /day because the maximum dose of 1000 mg/kg-bw/day was not toxic after oral administration at 1, 10, 100, and 1000 mg/kg bw/day for 29 days. However, dose-independent results showed increased urinary ketones, decreased lymphocyte ratio, and increased eosinophil ratio in the 10 mg/kg-bw/day group, as well as increased blood creatinine and increased relative weight of the thymus gland in the 100 mg/kg/day males. Based on these results, the Notifier determined that a dose of 1 mg/kg-bw/day, which showed similar safety data to the control, was the non-toxic dose for this evaluation.

#### SCCS comments

The Notifier has quoted two repeat-dose toxicity studies from the open literature that have also been described in the OECD Document ENV/JM/MONO(2016)21. However, the original study reports were not made available to the SCCS. The first study by Shinohara *et al.* (2010) is an intratracheal and inhalation study on fullerenes C60 kinetics after lung exposure and it is also mentioned under section 3.2 of this Opinion. Although the rats were repeatedly exposed by inhalation to fullerenes C60, the study by Shinohara *et. al* was aimed at determining the lung clearance and lung kinetics. In this study fullerenes C60 was also evaluated in the brain and liver as possible indication for systemic tissue distribution after inhalation while toxicological effects on organs were not evaluated in this study.

Nevertheless, the SCCS does not consider inhalation studies relevant for this safety assessment as the notified fullerenes are not considered to be used for spray applications resulting in inhalation exposure.

Details on Takahashi *et al.* (2012) on the oral repeated dose toxicity study, that was used by the Notifier to derive the NOAEL, could be retrieved from the open literature as follows:

Guideline:	Test Guideline of the Japanese Chemical Control Act for 28 d Test
Species/strain:	Rat, CrI: CD(SD), 4 weeks old
Group size:	10/sex in controls and highest dose; 5/sex for the other doses
Test substance:	Fullerene C60 (Nanom Purple SU, 0.71 nm in diameter, black powder, CAS 99685-96-8)
Batch:	10B0098-A
Purity:	99.9 %
Vehicle:	Olive Oil
Dose levels:	0, 1, 10, 100, and 1000 mg/kg bw/d
Administration:	Oral gavage (10 ml/kg bw)
Duration:	29 d treatment, 14 d recovery
GLP:	In compliance
Study period:	2010-2011

Rats were given Fullerene C60 by gavage once daily at the doses given in the table above. One day after the last dosing, five animals/sex/dose were euthanised for the assessment of haematology, blood biochemistry, organ weights, macroscopic and microscopic findings. The remaining five animals from the control and high dose group were kept without treatment for 14 days and examined thereafter. Functional observation battery (FOB) was investigated during the 4<sup>th</sup> week of treatment. Clinical signs, body weight and food consumption were monitored on a regular basis. Urine was collected for urinalysis during the 4<sup>th</sup> week of treatment. At the end of treatment and after recovery, concentrations of C60 fullerenes were determined in liver (median lobe), right and left kidneys and spleen from male control and high dose animals.

#### Results:

No deaths or clinical signs of toxicity occurred. In high-dose animals, blackish faeces was observed at the highest dose starting from dosing day 4 (until day 1 of the recovery period). Urinalysis revealed increased incidences of ketone bodies in male animals at 10 and 1000 mg/kg bw/d. In male animals, there was an increase in the differential eosinophil ratio at 10 mg/kg bw/d and a decrease in the differential lymphocyte ratio at the end of treatment, but not after recovery. Haematology revealed a statistically significant ( $p < 0.01$ ) increase in creatinine in 100 mg/kg bw/d males and a decrease in albumin ( $p < 0.05$ ) at the highest dose at the end of treatment but not after recovery. In high-dose females, protein was statistically significantly ( $p < 0.05$ ) increased after recovery. No changes from controls were observed for serum levels of triiodothyronine, thyroxine and thyroid stimulating hormone. At the end of the treatment period, but not after recovery, relative thymus weights were increased in females at 100 mg/kg bw/d and in males, relative kidney weights were decreased ( $p < 0.05$ ). After recovery both absolute and relative liver weights as well as absolute spleen weight were increased ( $p < 0.05$  each). There were no histopathological findings and the concentrations of fullerene C60 were below detection limit in the tissue samples investigated.

#### Further studies cited by the Notifier(s)

In a study by Shipelin *et al.* (2015), male Wistar rats ( $n=24$ ), peroral administration of dispersion of nano-sized (31 nm) multimolecular fullerene C60 particles in doses of 0.1, 1.0, and 10 mg/kg body weight over 92 days. No noted physiological, biochemical, hematological and immunological changes which can be addressed with Fullerene C60 toxicity. However, the highest doses (1 and 10 mg/kg bw) increased population and modified distribution of hepatic CD106+ cells; also resulted in accumulation of cytoplasmic granules presumably identified as Kupffer macrophages without any signs of visible inflammation or necrotic areas. In the authors' opinion, it is a proof of the beginning of a hepatotoxic effect.

Ref: Shipelin *et al.* (2015)

In a study by Baati *et al.* (2012), rats, oral administration of C(60) dissolved in olive oil (0.8 mg/ml) at reiterated doses (1.7 mg/kg of body weight) for 7 months (dosing schedule: each day for first 7 days; once a week till the end of 2<sup>nd</sup> month; once every 2 weeks till the end of experiment). Effects in rats – not only does not entail chronic toxicity but it almost doubles their lifespan.

Ref: Baati *et al.* (2012)

Ref: FULLERENES toxicity profile [67051\_spec\_file\_2019-4-17-12-4-16.zip]

#### SCCS comment

The study of Takahashi *et al.* (2012) was not performed according to an OECD test guideline, because a lower number of animals was used. The Notifier indicated a NOAEL of 1 mg/kg bw/d from the Takahashi *et al.* (2012) study. However, another study by Shipelin *et al.* (2015) points to a lower NOAEL of 0.1 mg/kg bw/day. A third study by Baati *et al.* (2012) is not considered relevant for this safety assessment.



**Study: 13-week Repeated Dose Dermal Toxicity Study of Fullerene C60 in Rats (Study No. P120327)**

During the commenting period the SCCS has received the following 13-week repeated dose dermal toxicity study of Fullerene C60 in Rats. According to the manufacturer, in this study Fullerene C60 was employed instead of the raw fullerene powder because the manufacturer applied Fullerene C60 as the quasi-pharmaceutical product instead of the raw fullerene powder. Also, usage of Fullerene C60 in this study was consistent with SCCS consideration of an equivalence of safety data read across between C60 and C70.

NOTE: translation from Japanese into English as provided by the Notifier

Study number:	Study No. P120327
Guideline:	This study was performed in compliance with the "Ministerial Ordinance on Good Laboratory Practice for Nonclinical Safety Studies of Drugs," Ministry of Health and Welfare Ordinance No. 21 (March 26, 1997, partially revised by Ministry of Health, Labour and Welfare Ordinance No. 114 dated June 13, 2008). The confirmation of the description, purity, and stability of the test substance was not covered by the GLP regulation
Species/strain:	rat strain Crl:CD(SD), 4 weeks of age at purchase, 6 weeks of age at start of administration. Body weight males 74.3 – 86.9g, females, 71.4 – 84.5 g.
Group size:	total n=40 animals per sex, group size n=10 per dose group
Test substance:	Fullerene C60 (Vitamin C60 BioResearch Corporation)
Batch:	12A0108-A, and 12A0108-B
Purity:	Lot No. 12A0108-A: 100.5% (non-GLP); Lot No. 12A0108-B: 99.7% (non-GLP)
Vehicle:	Olive oil (Lot nr WEM2894, Wako Pure Chemical Industries, Ltd)
Dose levels:	0 (vehicle), 2, 10, and 50 mg/kg (dose volume administered 5 mL/kg, based on latest body weight)
Administration:	dermal application. At dorsal area (approx. 4 x 5cm) of fur clipped skin covered by a lint cloth, once daily, 7 days a week for 13 weeks starting at day 1 of week 1. Animals wore collars during administration period. The dose was impregnated in the lint cloth.
GLP:	in compliance; however, the confirmation of the description, purity, and stability of the test substance was not covered by the GLP regulation.
Study period:	10 August 2012 – 29 March 2013 (Date of necropsy: 6 December 2012)

**Results summary**

Fullerene C60 was dermally applied to 10 Crl:CD(SD) rats of each sex per group at doses of 2, 10, and 50 mg/kg repeatedly for 13 weeks to investigate its toxicity. The highest dose (50 mg/kg) corresponded to approximately 25,000 times the clinical dose (0.4 ppm).

Olive oil was used as the vehicle in the dosing solution, and the dosing volume was 5 mL/kg. The test items were observation of general condition, body weight, food consumption, ophthalmology, urinalysis, hematology, blood biochemistry, necropsy, organ weight, and histopathology.

In each test substance group, there were no deaths or obvious toxicological changes attributable to the test substance. Nor were there any test substance-related changes in the topical skin.

Based on the above findings, the no-observed-adverse-effect level of Fullerene C60 was estimated to be 50 mg/kg/day in both sexes.

**SCCS comment**

The study was conducted according to GLP and the GLP declaration was added to the study report. The GLP declaration was signed by the responsible person in the Japanese version of the report. Result Tables and Annexes were presented in English in the original Japanese report.

Reddish urine was noted in two male animals, one in the control group and one in the 50mg/kg group, that was not ascribed to the treatment. Some ophthalmic and hematological parameters (low values in hemoglobin concentration and hematocrit were observed in males in the 50 mg/kg group in the absence of histopathological changes in the hematopoietic system) showed alterations compared to the control group which were explained as being also present in the control animals and before treatment, while for the hematological parameters the changes were minor and within the background levels of historical values in the test facility. Some weights of some organs (brain, epididymis, epididymis, lung, pituitary gland, thyroid gland) showed changes compared to the control animals. These changes were considered unrelated to the test substance because they were minor and within the range of background data in the testing facility, and because of the absence of test-substance-related histopathological changes in these organs. Furthermore, no dose response relationship was noted.

In the topical skin, acanthosis was observed in 3 males and 6 females in the control group and 4 males and 5 females in the 50 mg/kg group. However, there was no difference in the severity or incidence between groups, nor were there any effects of the test substance. In addition, in various organs changes in histopathology were sporadically observed. However, these changes were comparable in nature or magnitude to those that develop non-specifically in rats, and most were observed both in the control group and 50 mg/kg treatment group, and were not considered dose-dependent. The SCCS agrees with these explanations.

However, the SCCS notes that the top dose levels might have been too low to detect any effect.

**Hydroxylated Fullerenes****Study: Subacute systemic toxicity study of the product Hydroxylated Fullerene C<sub>60</sub>(OH)<sub>30-50</sub>**

NOTE: Certified translation from Serbian into English as provided by the Notifier

Study number:	LMEM-SAT-03/2022
Guideline:	Study performed according to OECD TG no 407, EU Directive 2010/63/EU, and ISO 10993-2:2006 Animal welfare requirements.
Species/strain:	Mouse, NMRI HAN, 5 weeks of age
Group size:	total number of animals 40 (30 experimental and 10 control animals, 10 animals per group). Animals of both genders were used (5 males and 5 females per group).
Test substance:	Hydroxylated Fullerene C <sub>60</sub> (OH) <sub>30-50</sub>
Batch:	Laboratory sample
Purity:	Not given. According to the manufacturer the composition of test substance has a concentration of 0.15 g/L
Vehicle:	Not given
Dose levels:	0.75 mg/kg, 2.25 mg/kg, 3.75 mg/kg. Experimental group: 0.1 mL/mouse; 0.3 mL/mouse; 0.5 mL/mouse (every day for 28 days) Control group: 0.5 mL of purified water (every day for 28 days)
Administration:	Gastric probe
GLP:	-
Study period:	10 May – 6 June 2022

Results: Treated animals did not demonstrate signs of toxic reactions immediately upon application, as well as in the later course of observation. They acted normal, in conformity



with the expected for their species, sex, age and environment. Reaction of animals to the provoked behaviour was normal and expected. No signs of neurological misbehaviour were noticed. Hygienic behaviour of the animals was normal. Eyes were clear and clean; nostrils and other natural openings were clean.

There were no significant differences in body weight gain of experimental compared to control animals. The experimental animals did not demonstrate any nutritional disorders. They were feeding and drinking water in the customary manner. Food and water consumption did not significantly differ between experimental and control animals.

During the experimental period, there were no fatalities of experimental and control animals. After 28 days since the beginning of the experiment, all animals were sacrificed and a pathoanatomical examination was performed. Macroscopic examination of organs and tissues did not show any pathological changes in experimental and control groups.

Based on clinical monitoring of the experimental animals and on performed macroscopic examination of the organs after 28 days since the commencement of the experiment, it was concluded that the tested Hydroxylated Fullerene C<sub>60</sub>(OH)<sub>30-50</sub> applied at doses of 0.75, 2.25, and 3.75 mg/kg of body weight does not cause any toxic effects on tested animals.

Ref: Subacute (28d) toxicity -ENG report HF.

### SCCS comment

According to the Notifier, the data produced in this study are not specifically intended for demonstrating the safety of hydroxylated fullerene for use in cosmetics, but in concordance with the recommendation of Directive 2001/83/EC of the European Parliament and of the Council of 6 November 2001 on the Community code relating to medicinal products for humans. In this study, a toxic dose level was not achieved and hence this study does not add any useful information to this safety evaluation.

### Hydrated forms of Hydroxylated Fullerenes

The following information was provided by the Notifier:

By reviewing mentioned literature different, even contradictory results of fullerene/fullerol toxicity investigations. Many studies do not clearly state which substance was investigated, the manner of obtaining the substance, if the presence of impurities was established, etc. In accordance with results of some of the mentioned studies, the Notifier expresses the opinion that it is exactly the presence of solvent residues and other impurities that are the cause of undesirable/toxic effects of the substance, but also the reason for the absence of expected positive effects. For this reason, during 3HFWC production special attention is devoted to removing solvent residues and obtaining a quality, safe and efficient cosmetic ingredient.

Ref:281\_tox\_profile\_2020-3-12-18-44-18

### Study: Subacute systemic toxicity study of 3HFWC

NOTE: Certified translation from Serbian into English as provided by the Notifier.

Study number:	LMEM-SAT-01/2022
Guideline:	Study performed according to OECD TG no 423, EU Directive 2010/63/EU, and ISO 10993-2:2006 Animal welfare requirements.
Species/strain:	Mouse, NMRI HAN, 5 weeks of age
Group size:	total number of animals 40 (30 experimental and 10 control animals, 10 animals per group). Animals of both genders were used (5 males and 5 females per group).
Test substance:	Hyper-Harmonized Hydroxylated Fullerene Water Complex-3HFWC
Batch:	Laboratory sample
Purity:	Not given. According to the manufacturer the composition of test substance has a concentration of 0.15 g/L

Vehicle:	Not given
Dose levels:	0.75 mg/kg, 2.25 mg/kg, 3.75 mg/kg. Experimental group: 0.1 mL/mouse; 0.3 mL/mouse; 0.5 mL/mouse (every day for 28 days) Controls: 0.5 mL of purified water (every day for 28 days)
Administration:	Gastric probe
GLP:	-
Study period:	10 May – 6 June 2022

Results: No treated animals in any of the groups showed signs of a toxic reaction immediately after application, or in the later during observation. Animals behaved normally in accordance with what is expected for their species, gender, age and environment. The reaction of animals to provoked behaviour was normal and as expected. No signs of neurological deficits were observed. The hygienic behaviour of animals was normal. Their eyes were clear and clean, nostrils and other natural orifices were clean.

There were no significant differences in weight gain of experimental compared to control animals. They ate and drank water in the usual manner. Food and water consumption of experimental and control animals did not differ significantly.

During the experimental period there were no deaths of experimental or control animals. After 28 days from the beginning of the experiment, all animals were sacrificed and a pathoanatomical examination was performed. Macroscopic examination of organs and tissues did not reveal any changes in any animal, both in the treated and control group.

Based on clinical observation of the experimental animals and the macroscopic examination of the organs after 28 days from the commencement of the experiment, it was concluded that the investigated product Hyper Harmonized Hydroxylated Fullerene Water Complex-3HFWC at doses of 0.75, 2.25, and 3.75 mg/kg did not cause toxic effects in tested animals.

Ref: 3HFWC data submission main document.pdf; FULLERENES toxicity profile;  
Subacute (28d) toxicity -ENG report 3HFWC

### **SCCS comment**

According to the Notifier, the data produced in this study are not specifically intended for demonstrating the safety of 3HFWC for use in cosmetics, but in concordance with the recommendation of Directive 2001/83/EC of the European Parliament and of the Council of 6 November 2001 on the Community code relating to medicinal products for humans. In this study, a toxic dose level was not achieved and hence this study does not add any useful information to this safety evaluation.

### **SCCS overall comments on repeated-dose toxicity**

The studies were not performed with the fullerenes that have been notified in the CPNP. Most studies on fullerene C60 were cited from literature overviews, and full study reports were not provided. Data on fullerene C70 were not provided in any of the submitted studies.

For hydroxylated fullerenes and their hydrated forms, the Notifier provided results from two *in vivo* toxicity studies performed in the context of medical application. However, the exact regulations, for which these studies were performed in concordance with the recommendation of Directive 2001/83/EC of the European Parliament and of the Council of 6 November 2001 on the Community code relating to medicinal products for humans were not presented. In addition, only limited parameters were reported which is not in line with requirements according to OECD guidelines on repeated dose toxicity. Therefore, conclusions on repeated dose toxicity from these studies cannot be drawn on the materials.

**3.4.5 Mutagenicity/genotoxicity**

Following the mandate Fullerenes, Hydroxylated Fullerenes and Hydrated forms of Hydroxylated Fullerenes were evaluated for genotoxicity. Radical Sponge® and LipoFullerene® were excluded from the evaluation.

**1. Fullerenes**

Following information on Fullerenes was provided by Notifier(s):

Data presented in ENV/JM/MONO(2016)21:

- OECD 471: negative with and without metabolic activation
- OECD 473 and Japanese Guideline (Chemical Substances Control Law of Japan): negative
- Chromosomal aberration, DNA damage and/or repair *in vivo*: no effects

Ref.: ENV/JM/MONO(2016)21

Several full reports and two publications were further provided and analysed by SCCS.

**Bacterial Reverse Mutation test**

Several reports and publications on Bacterial Reverse Mutation tests have been submitted:

## 1. Ames test (with and without metabolic activation)

Mori *et al.* (2006): Fullerenes (the mixture of C60 and C70, fullerite), sublimed technical grade, purity: 99.5%, were supplied from Vitamin C60 BioResearch Corp. (Tokyo, Japan) – result negative.

Shinohara *et al.* (2009): Commercially available C60, 500-mg Nanom purple, refined by sublimation, C60 purity >99.5%; Frontier Carbon Co., Ltd., Japan – result negative

Ref: Mori *et al.* (2006); Shinohara *et al.* (2009)

## 2. Ames test (with and without metabolic activation)

Study report: "Fullerene raw powder"; probably 66.4% fullerene C60, with the rest being mainly Fullerene C70 – result negative.

Ref.: Bacterial Reverse Mutation Study of Fullerenes. Final Report #B040380, Mitsubishi Chemical Safety Institute, Ltd. 2004a

**SCCS comment**

As explained in the SCCS Guidance on Nanomaterials (SCCS/1611/19), the bacterial gene mutation test is not suitable for testing nanoparticles for gene mutation, and thus these studies were not included in the evaluation of mutagenicity of fullerenes.

**Chromosomal aberration test in Cultured Mammalian Cells**

Guideline:	Chromosomal aberration test Guidelines on Genotoxicity Tests of Pharmaceuticals (Notification No.1604 of the Evaluation and Licensing Division, MHW'S PMSB dated November 1, 1999)
Test system:	CHL/IU lung Chinese hamster cells
Replicates:	2 replicates
Test substance:	Water-Soluble Fullerenes 0.365% of C60, amorphous granule
Batch (Purity):	Lot 041206
Vehicle:	water

Assay medium:	MEM Eagle
Concentrations:	313, 625, 1250, 2500 and 5000 µg/mL
Treatment:	experiment I: 6 h exposure, without and with metabolic activation; experiment II; 24h exposure, only without metabolic activation.
S9	phenobarbital induced rat liver
Positive controls:	Mitomycin C (MMC) 0.1 µg/mL without S9 and Benzo[a]pyrene with S9 20 µg/mL
Negative control:	Vehicle
Statistics:	None
GLP:	Yes
Study period:	2005

The confirmation of the stability and contents of the test substance solutions (vehicle DMSO) was measured by HPLC before the experiments in another study.

An *in vitro* chromosomal aberration study of Water-Soluble Fullerenes was conducted using CHL/IU cells derived from the lungs of female Chinese hamsters as the indicator cells. Based on the result of a preliminary test, the cell growth inhibition test was conducted at 313, 625, 1250, 2500 and 5000 µg/mL in the short-term treatment assay for 6 hours in the absence of S9 mix (-S9 mix assay) and the presence of S9 mix (+S9 mix assay), and in the continuous treatment assay for 24 hours (24-hour assay). As a result, cell growth was not inhibited more than 50% in any treatment condition. Based on the result of the cell growth inhibition test, the chromosomal aberration test was conducted at 1250, 2500 and 5000 µg/mL in each treatment condition. 100 cells per plate (200 cells per concentration) have been assessed for chromosomal aberrations. Incidences of cells with structural and numerical chromosome aberrations were less than 5.0% in all the treatment conditions. In conclusion, Water-Soluble Fullerenes was considered not to have the ability to induce chromosomal aberration under the conditions employed in the present study.

Ref. Final report B040967, Mitsubishi Chemical Safety Institute, Ltd. 2005

### SCCS comment

The SCCS considers the study inconclusive, as the uptake of fullerene by CHL/IU cells was not demonstrated. Also, information on historical positive and negative control was not provided. Characterisation of fullerene in dispersion for size and size distribution was not performed. It is not clear which form of fullerene was tested, as it was mentioned that it was water soluble fullerene, which suggests that it might have been Radical Sponge®. Radical Sponge® was not evaluated in this Opinion.

### Chromosomal Aberration Study in Cultured Mammalian Cells

Guideline:	Chromosomal aberration test Guidelines on Genotoxicity Tests of Pharmaceuticals (Notification No.1604 of the Evaluation and Licensing Division, MHW'S PMSB dated November 1, 1999)
Test system:	CHL/IU lung Chinese hamster cells
Replicates:	2 replicates
Test substance:	Fullerenes (synonym: Fullerene) purity 66.4%, powder
Batch (Purity):	Lot 040406
Vehicle:	DMSO
Assay medium:	MEM Eagle
Concentrations:	313, 625, 1250, 2500 and 5000 µg/mL
Treatment:	experiment I: 6 h exposure, without and with metabolic activation; experiment II; 24h exposure, only without metabolic activation.
S9	phenobarbital induced rat liver
Positive controls:	Mitomycin C (MMC) 0.1 µg/mL without S9 and Benzo[a]pyrene with S9 20 µg/mL

---

Negative control:	Vehicle
Statistics:	None
GLP:	Yes
Study period:	2005

Fullerene was suspended in DMSO. The confirmation of the stability and contents of the test substance solutions was measured by HPLC before the experiments in another study. The confirmation of contents and homogeneity of the test substance suspension was done in testing facility. The highest and lowest concentrations in the same dilution series of the chromosomal aberration test (500 and 31.3 mg/mL) were analysed by HPLC. The contents (average of the measured values, n=3) of the test substance suspensions ranged 100.8 % - 102.9% of the nominal concentrations and were within the laboratory criterion (90% - 110%).

An *in vitro* chromosomal aberration study of Fullerenes was conducted using CHL/IU cells derived from the lungs of female Chinese hamsters as the indicator cells. Based on the result of a preliminary test, the cell growth inhibition test was conducted at 156, 313, 625, 1250, 2500, and 5000 µg/mL in the short-term treatment assay for 6 hours in the absence of S9 mix (-S9 mix assay) and the presence of S9 mix (+S9 mix assay), and in the continuous treatment assay for 24 hours (24-hour assay). As a result, the concentrations producing 50% inhibition in cell growth were estimated to be 2317 µg/mL in the +S9 mix assay and 564 µg/mL in the 24-hour assay. Cell growth was not inhibited more than 50% in -S9 mix assay. Based on the result of the cell growth inhibition test, the chromosomal aberration test was conducted at 625, 1250, 2500, and 5000 µg/mL in the -S9 mix assay and +S9 mix assay, as well as at 313, 625, 1250, 2500, and 5000 µg/mL in the 24-hour assay. As a result, the incidences of cells with structural and numerical chromosome aberrations were less than 5.0% in all the treatment conditions. In conclusion, Fullerenes were considered not to have the ability to induce chromosomal aberration under the conditions employed in the present study.

Ref.: Final Report #B040381, Mitsubishi Chemical Safety Institute, Ltd. 2004

### SCCS comment

The SCCS considers the study inconclusive, as the uptake of fullerene by CHL/IU cells was not demonstrated. Cytotoxicity after 24h exposure exceeded the recommended cytotoxicity range in all tested concentrations (cell growth index was 23-44%). Also, information on historical positive and negative controls was not provided. Additionally, characterisation of fullerene in dispersion for size and size distribution was not performed. The raw fullerene powder consists of about 66 % fullerene C60. From the test reports it is unclear whether the remaining 34 % is Fullerene C70.

### Chromosomal aberration test in Cultured Mammalian Cells

Chromosomal aberration test in cultured Chinese hamster lung (CHL/IU) cells *in vitro* was reported by Mori *et al.* (2006). Fullerenes (the mixture of C60 and C70, fullerite), sublimed technical grade, purity: 99.5%, supplied from Vitamin C60 BioResearch Corp. (Tokyo, Japan)– result negative.

Ref: Mori *et al.* (2006)

### SCCS comment

The study is of limited reliability for the following reasons: no physicochemical analysis (e.g. TEM, stability of nanoparticle suspension before and after dilution in culture medium, etc.) of the in-laboratory synthesised C60 was performed; no demonstration of cell internalisation of C60 has been provided; for chromosomal aberration test no data on historical negative and positive controls have been provided; the study was not performed under GLP conditions. The results were identical with those reported in the final report B040381, but with incorrect transposition of the data for structural and numerical aberrations after continuous treatment assay. Also, in the publication by Mori *et al.* (2006) referred to fullerenes (the mixture of C60

and C70, fullerite), sublimed technical grade, purity: 99.5%, which is probably not identical to the fullerene used in the B040381 study report, in which fullerenes purity 66.4% was reported.

#### **Chromosomal aberration test in Cultured Mammalian Cells**

Chromosomal aberration test in cultured Chinese hamster lung (CHL/IU) cells *in vitro* was reported by Shinohara *et al.* (2009) who used commercially available C60 (500-mg Nanom purple, refined by sublimation, C60 purity >99.5%; Frontier Carbon Co., Ltd., Japan; mixed with carboxymethylcellulose sodium. The material was tested with and without metabolic activation – with negative results.

Ref: Shinohara *et al.* (2009)

#### **SCCS comment**

The study is of limited reliability for the following reasons: no physicochemical analysis (e.g. stability of nanoparticle suspension before and after dilution in culture medium, etc.) of the C60 was performed; no demonstration of cell internalisation of C60 has been provided; no data on historical negative and positive controls have been provided; the study was not performed under GLP conditions.

#### **Bone marrow micronucleus test *in vivo***

Shinohara *et al.* (2009) reported bone marrow micronucleus test *in vivo* using a stable C60 nanoparticle suspension (commercially available C60 (500-mg Nanom purple, refined by sublimation, C60 purity >99.5%; Frontier Carbon Co., Ltd., Japan; mixed with Tween 80) on ICR mice with negative results. In this study male mice were twice administrated with doses of 22, 45, and 88 mg/kg C60 by gavage with a stomach tube at 24-h intervals.

Ref: Shinohara *et al.* (2009)

#### **SCCS comment**

Although the MN result was negative, there is no proof of systemic availability/distribution of the test material after oral administration (including to bone marrow). Hence, the SCCS considers the study result inconclusive.

#### **Conclusion from the Notifier**

According to the Notifier #1, based on the above studies *in vitro* and some *in vivo* tests confirms lack of fullerene genotoxic potential.

Ref: FULLERENES toxicity profile [CPNP data/ 67051\_spec\_file\_2019-4-17-12-4-16.zip]

#### **Overall SCCS comment on genotoxicity of fullerene**

Having considered all the available data, the SCCS is not able to conclude on the genotoxicity of fullerenes (C60 and C70) for following reason:

- From the information provided by the Notifiers, it is not clear if the physicochemical characteristics of the test items used in the biological studies cited were the same as those nanomaterials notified for this assessment. To enable the SCCS to assess the relevance of the submitted genotoxicity studies, a detailed comparative analysis of the physicochemical characteristics of the tested nanomaterials with those intended to be used by the Notifiers is required.
- The study on chromosomal aberration with negative results has limited value, as uptake of fullerene by CHL/IU cells was not demonstrated. *In vivo* micronucleus study results are considered inconclusive due to the lack of proof of systemic exposure.



- Additionally, valid data on gene mutation endpoint (mammalian gene mutation test) are missing. It is generally recommended for regulatory safety assessments, as detailed in the SCCS Guidance on Nanomaterials (SCCS/1611/19), that bacterial gene mutation tests are not suitable for testing the genotoxic potential of nanomaterials. Therefore, the SCCS did not consider studies on bacterial model in the evaluation of genotoxicity of fullerenes.

## 2. Hydroxylated Fullerenes

### ***In vitro* Mammalian Cell Micronucleus Test**

Guideline:	Micronucleus™ instaCELL Micronucleus Assay Kit,
Test system:	V79 Chinese hamster cells
Replicates:	3-well chamber slides from Ibidi®, 2 replicates
Test substance:	Hydroxylated fullerenes, C60(OH) <sub>n</sub> (n=30-50) MW=1332g/mol
Batch (Purity):	21C0226
Vehicle:	assay buffer,
Assay medium:	DMEM+20%FBS
Concentrations:	160, 80, 8, 0.8 and 0.08 mM
Treatment:	16h
Positive controls:	Mitomycin C (MMC): 4.7 µg/mL (4 h), 0.02 µg/mL (24 h)
Negative control:	Vehicle
Statistics:	Student t-test
GLP:	No
Study period:	November 03-17, 2021

The aim of this study was to determine the genotoxic potential of the product HYDROXYLATED FULLERENES (reference: -, batch: 21C0226) according to the micronucleus assay. Assay was performed with instaCELL Micronucleus Assay Kit according to the protocol. To set up the assay, 3-well chamber slides from Ibidi® were used. Within the slides, cells can be cultured, treated, fixed and mounted without transfer. One vial of Assay Ready V79 was thawed, and the cells were seeded into 3-well chamber slides at a density of 10.000 cells per well. The cells were incubated at 37°C for 24h to allow them to attach to the glass slide. The next day, medium was removed, and the cells were treated with test fullerenes dilutions for 16h. After incubation, the cells were fixed with mixture of acetic acid and methanol (1:4), washed and stained with DAPI. 2.000 cells per well were analysed by fluorescence microscopy counting the cells with and without micronuclei. The criteria used to determine whether a test sample is positive or negative for genotoxicity were based on the OECD 487. All 5 concentrations of test sample induced significant increase of micronuclei with respect to the negative control. Inverse dose-dependent effect was observed. The authors noted that the reason to the results obtained *i.e.* at higher concentrations the sample dispersion might be less stable and form aggregates that decrease the bioavailability of the product and therefore, reduce the differences with the negative control. The lowest 2 concentrations tested were similar, however only 2 values are not sufficient to evaluate the trend adequately. Repetition of the test with lower concentrations is recommended. The authors concluded that under the experimental conditions adopted and taking into account the defined procedure, the test is considered inconclusive.



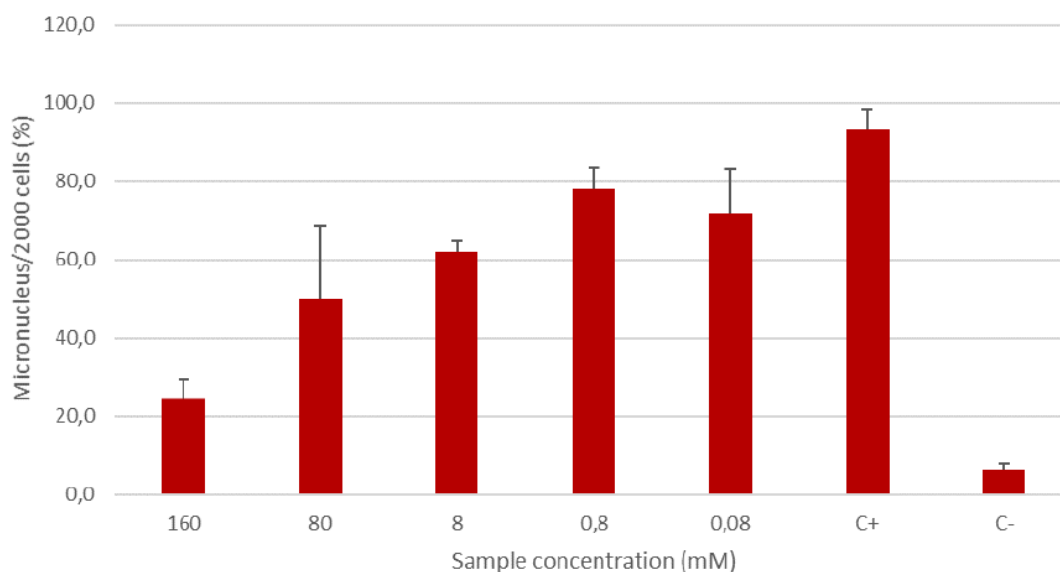

Percentage of micronucleate cells from 2000 cells after the treatment with Hydroxylated fullerenes. Positive control (C+) MMC.

Study ref. VT\_SEG-GEN.MN\_664\_21\_002

#### SCCS comment

The study was performed on a commercially available Micronucleus Assay Kit and it was not done under GLP conditions. Basic data on test substance, how concentrations were calculated, dispersion procedure, vehicle and characterisation of hydroxylated fullerenes in dispersion (size, size distribution, agglomeration) were not provided. Information on the uptake of hydroxylated fullerenes by V79 cells was not provided. Historical positive and negative controls data were also missing. The test substance was clearly positive in all 5 tested concentrations.

Based on all the shortcomings identified, the SCCS considers the study as not acceptable for evaluation of genotoxicity of hydroxylated fullerenes.

#### Chromosome aberration assay and the cytokinesis-block micronucleus test *in vitro*

Mrdanovic *et al.* (2009) in their *in vitro* study on CHO-K1 cells, analysed the genotoxic and antigenotoxic potential of fulleranol C<sub>60</sub>(OH)<sub>24</sub>. The results show that fulleranol does not induce genotoxic effects in a wide range of concentrations (11-221 μM), and that it protects both non-damaged and MMC-damaged CHO-K1 cells.

Ref: Effects of fulleranol C<sub>60</sub>(OH)<sub>24</sub> on the frequency of micronuclei and chromosome aberrations in CHO-K1 cells, Mrdanovic *et al.* 2009; Mutation Research 680 (2009) 25–30

#### SCCS comment

The study is not considered reliable for the following main reasons: no physicochemical analysis was provided of the in-laboratory synthesised C<sub>60</sub>(OH)<sub>24</sub> (e.g. TEM, stability of nanoparticle suspension before and after dilution in culture medium, etc.); no demonstration of cell internalisation of C<sub>60</sub>(OH)<sub>24</sub> has been provided; for micronuclei and chromosomal aberration tests, no data on historical negative and positive controls were provided; studies were not performed under GLP conditions.

#### Bacterial gene mutation test

Internal company study (unpublished data) showed absence of mutagenicity alert in Ames test (reference test result data included in references file).

**SCCS comment**

The bacterial gene mutation test is not suitable for testing nanoparticles for gene mutation and thus it was not included in the evaluation of mutagenicity of fullerene.

***In vitro* comet assay**

An unpublished study from 2018 (data from *in vitro* Comet assay; University of Belgrade, Faculty of Veterinary Medicine) showed that the tested substance (fullerenol) exhibited genotoxic effects solely at concentrations > 150 µg/ml. Consequently, the authors concluded that the substance is potentially genotoxic at high doses, but not in potentially achievable biological exposure concentrations.

**SCCS comment**

The information provided by Notifiers has limited value, as the *in vitro* Comet assay results can be considered only as supportive in the overall weight of evidence.

**Conclusion from the Notifier**

Based on the above referred data, it can be concluded that the substance does not show genotoxic or mutagenic potential in potentially achievable biological exposure concentrations as used in cosmetic products.

Ref: 281\_safety\_file\_2020-3-12-18-44-18

**Overall SCCS comment on Hydroxylated Fullerenes**

The SCCS cannot conclude on the genotoxicity of hydroxylated fullerenes due to the lack of data on gene mutation and valid data on chromosomal aberrations, and due to high uncertainty due to missing information on the characterisation and uptake of hydroxylated fullerenes.

**3. Hydrated forms of Hydroxylated Fullerenes*****In vitro* Mammalian Cell Micronucleus Test**

Guideline:	Micronucleus™ instaCELL Micronucleus Assay Kit,
Test system:	V79 Chinese hamster cells
Replicates:	3-well chamber slides from Ibidi®, 2 replicates
Test substance:	Hyper Harmonized Hydroxylated Fullerene Water Complex (3HFWC), C60;C= 0.15 g/L, Ultra-pure water (0,055 µS/cm)
Batch (Purity):	/
Vehicle:	assay buffer
Assay medium:	DMEM+20%FBS
Concentrations:	15.0, 7.50, 3.75 ,1.88 and 0.94 µg/mL
Treatment:	16h
Positive controls:	Mitomycin C (MMC): 4.7 µg/mL (4 h), 0.02 µg/mL (24 h)
Negative control:	Vehicle
Statistics:	Descriptive analysis, t-test, central tendency, variance, Linear mixed effects models, Wilcoxon Signed Rank test.
GLP:	No
Study period:	August 10-19, 2022

The aim of this study was to determine the genotoxic potential of the Hyper Harmonized Hydroxylated Fullerene according to the micronucleus assay. Assay was performed with instaCELL Micronucleus Assay Kit according to the protocol. To set up the assay, 3-well chamber slides from Ibidi® were used. Within the slides, cells can be cultured, treated, fixed and mounted without transfer. One vial of Assay Ready V79 was thawed, and the cells were seeded into 3-well chamber slides at a density of 10.000 cells per well. The cells were incubated at 37°C for 24h to allow them to attach to the glass slide. The next day, medium

was removed and the cells were treated with test fullerenes dilutions for 16h. After incubation, the cells were fixed with mixture of acetic acid and methanol (1:4), washed and stained with DAPI. 2.000 cells per well were analysed by fluorescence microscopy counting the cells with and without micronuclei. The test sample concentrations 3.75µg/mL, 1.88µg/mL and 0.94µg/mL did not induce a significant increase of micronuclei with respect to the negative control. The tested concentrations 15.0µg/mL and 7.50µg/mL of the product clearly show a statistically significant increase compared to the negative control. Authors concluded that under the experimental conditions adopted and taking into account the defined procedure, according to the criteria determining whether a test sample is positive or negative for genotoxicity, based on OECD 487, they shall consider that: The tested concentrations 15.0µg/mL and 7.50µg/mL of the product clearly show a statistically significant increase compared to the negative control. Therefore, the response is considered to be positive, the test chemical is then considered able to induce chromosome breaks and/or gain or loss in this test system under the experimental conditions examined.

Study ref. VT\_SEG-GEN.MN\_664\_22\_002

### SCCS comment

The study was not performed according to OECD TG 487 and it was not done under GLP conditions. Basic data on test substance, how concentrations were calculated, dispersion procedure, vehicle, and characterisation of hydrated forms of hydroxylated fullerenes in dispersion (size, size distribution, agglomeration) were not provided. Information on the uptake of hydrated forms of hydroxylated fullerenes by V79 cells was not provided. Historical positive and negative controls data were missing. Based on all the shortcomings identified, the SCCS considers this study as not acceptable for evaluation of the genotoxicity of hydrated forms of hydroxylated fullerenes.

### *In vitro* Mammalian Cell Micronucleus Test

Guideline:	OECD TG 487, EU B.49
Test system:	Human peripheral lymphocytes in whole blood culture
Replicates:	2 replicates
Test substance:	Hyper Harmonized Hydroxylated Fullerene Water Complex (3HFWC), C60; C= 0.15 g/L, Ultra-pure water (0.055 µS/cm) 99.985 %
Batch (Purity):	01-2021-10-14
Vehicle:	water (ROTIPURAN® Ultra)
Assay medium:	Lymphogrow Medium with FBS
Concentrations:	15.0, 7.50, 3.75 µg/mL (for cytotoxicity from 0.24-15 µg/mL)
Treatment:	experiment I: 4 h exposure, without and with metabolic activation; experiment II; 23.5 h exposure, only without metabolic activation.
S9	rat liver induced by Phenobarbital/5,6-Benzoflavone
Positive controls:	Mitomycin C (MMC): 0.3 µg/mL and colchicine 0.035 µg/mL without S9 mix and Cyclophosphamide mono-hydrate (CPA) with S9mix
Negative control:	Vehicle
Statistics:	Descriptive analysis, Fisher's exact test
GLP:	Yes
Study period:	Ju 13- August 24, 2022

The study was performed to assess the potential of Hyperharmonized hydroxylated fullerene water complex (3HFWC) to induce formation of micronuclei in human lymphocytes cultured *in vitro* in absence and presence of an exogenous metabolic activation system in two valid experiments. In deviation from OECD TG 487, testing of test item was started with 15.0 µg/mL as highest concentration, based on the specification of the sponsor. Precipitation or turbidity of the test item was not visible in all experimental parts at any of the concentrations tested. Human peripheral blood lymphocytes in whole blood culture were stimulated to divide by phytohaemagglutinin. All cell cultures were set up in duplicates. The cytokinesis-block

proliferation index (CBPI) was calculated for all evaluable cultures to assess cytotoxicity. Three highest concentrations were selected to determine the proportion of binucleated cells containing micronuclei.

In experiment I as well as in experiment II, no relevant cytotoxic effects were observed up to the maximum test item concentration (15.0 µg/mL).

In experiment I with metabolic activation, the concentration 3.75 µg/mL showed a statistically significantly increased value of binucleated cells with micronuclei compared with the concurrent solvent control above the 95.5% control limits and also slightly above the range min – max of the historical data for solvent controls. No dose-response relationship was found. Therefore, in experiment I with metabolic activation two criteria (out of three) for a positive result are fulfilled.

In experiment I without metabolic activation, the value of micronuclei was also slightly (but not statistically significantly) increased at the concentration 3.75 µg/mL lying above the 95.5% control limits but still inside the range min – max of the historical data for solvents. No dose-response relationship was found. That means, one criterion for a positive result is met.

In experiment II (extended exposure, only without metabolic activation), the highest test item concentration (15.0 µg/mL) showed a statistically significantly increased value ( $p = 0.039$ ) of binucleated cells with micronuclei. This value also lay above the historical laboratory data for solvents, both above the range min – max and the 95.5% control limits. The micronucleus rates of the two lower test item concentrations (7.5 µg/mL and 3.75 µg/mL) did not show a statistically significant difference compared to the solvent control. A clear dose-dependency was observed as well but did not reach statistical significance. Nevertheless, this effect was declared as biologically relevant since the values were increased at higher dose(s) but since the values of the test item concentrations 7.5 µg/mL and 3.75 µg/mL were already in the range of the solvent control, the fulfilment of the dose dependence criteria must be taken with limited relevance. Therefore, all three criteria for a positive result are fulfilled and the result of experiment II is considered “positive”. All positive control compounds caused large, statistically significant increases in the proportion of binucleate cells with micronuclei, demonstrating the sensitivity of the test system.

In conclusion, under the experimental conditions reported, Hyperharmonized hydroxylated fullerene water complex (3HFWC) is able to induce the formation of micronuclei in human lymphocytes *in vitro*.

Study ref. No. 22032914G86LAUS GmbH, 2022

### **SCCS comment**

The SCCS is of the opinion that Hyper Harmonized Hydroxylated Fullerene is positive in micronucleus assay. The study was performed according to OECD TG 487 under GLP conditions. Characterisation of Hyperharmonised hydroxylated fullerene in dispersion (size, size distribution, agglomeration) was not provided. Information on the uptake of Hyper Harmonized Hydroxylated Fullerene by human peripheral blood mononuclear cells was also not provided.

### **Additional information from the Notifier**

The information provided by Notifiers indicates that Hyperharmonised Fullerenol-Water Complex (3HFWC) was tested in the bacterial genotoxicity test (Ames test) and the *in vitro* comet assay on human peripheral blood lymphocytes.

### **SCCS comment**

Bacterial gene mutation tests are not recommended for testing genotoxic potential of nanomaterials (SCCs Guidance on Nanomaterials SCCS/1611/19), and the *in vitro* Comet assay results can be considered only as supportive in the overall weight of evidence.

**The following study was provided by one of the Notifiers at the SCCS's request during the commenting period**

### **Mammalian gene mutation assay (Mouse Lymphoma Assay)**

Guideline:	OECD 490 (2016), EU-Method B.17 of the Commission Regulation (EC) No. 440/2008, adopted
Test system:	L5178Y TK <sup>±</sup> mouse lymphoma cells
Replicates:	Duplicates
Test substance:	Hyperharmonized hydroxylated fullerene water complex (3HFWC); C <sub>60</sub> (OH) <sub>30-50</sub> @ (H <sub>2</sub> O) <sub>144-2528</sub>
Batch (Purity):	01-2021-10-14; Hydroxylated fullerene C60 c = 0.15 g/L; purity 100%
Vehicle:	RPMI 1640 medium with 10 % horse serum (HS)
S9	Phenobarbital-5,6 Benzo-flavon (PB/BNF)
Treatment:	Exp I: 4 h ±S9-mix, Exp II: 24h-S9-mix
Concentrations:	7 concentrations, for cytotoxicity and genotoxicity at least 4 concentrations
Without S9:	Exp I - 4h: 0.47, 0.94, 1.88, 3.75, 7.5, 15 µg/mL Exp II - 24h: 0.2, 0.4, 0.8, 0.9, 1.0 µg/mL
With S9	Exp I - 4h: 0.47, 0.94, 1.88, 3.75, 7.5, 15 µg/mL
Expression period:	2 days
Colony counting:	10-12 days incubation with Trifluorothymidine (TFT) 5 µg/mL
Positive controls:	-S9: Methylmethanesulphonate (MMS): 19.5 µg/mL (Experiment I) 12.5 µg/mL (Experiment II) +S9: Cyclophosphamide monohydrate (CPM): 5.5 µg/mL
Negative control:	Vehicle +solvent ultrapure water (ROTIPURAN® Ultra, ROTH) 10%
Statistics:	A linear regression (least squares) to assess dose dependent increase of mutant frequencies.
GLP:	Yes
Study period:	March 2 - August 31, 2022

The potential of Hyperharmonized hydroxylated fullerene water complex (3HFWC) to induce mutations at the *thymidine kinase locus (Tk1)* was investigated with and without S9 mix and a treatment period of 4 h as well as without metabolic activation and a treatment period of 24 h. The pre-test was performed to detect a potential cytotoxic effect of the test item. Three independent and valid experiments using two parallel cultures each were performed and evaluated. The highest nominal concentration (experiment I: 15 µg/mL; experiment II: 1.0 µg/mL) applied was specified by the sponsor. Precipitation or turbidity of the test item was not visible in all experimental parts up to the maximum concentration of the test item. Methyl methanesulphonate (MMS) and Cyclophosphamide (CPA) as appropriate reference mutagens were used as positive controls. Both induced a distinct increase in mutant colonies and thus, showed enough sensitivity of the testing procedure and the activity of the metabolic activation system.

In experiment I with metabolic activation no significant reduction of growth was observed after 4 h treatment with test item (all concentrations). Therefore, the four highest test item concentrations (15.0 µg/mL, 7.5 µg/mL, 3.75 µg/mL and 1.88 µg/mL) could be evaluated for mutagenicity. A dose dependent increase in mutant colony numbers was observed. However, the mutation frequency did not reach or exceed the threshold of 126 above the corresponding solvent control. According to the OECD 490 the result of this approach is considered as "negative".

In experiment I without metabolic activation a significant and dose dependent reduction of growth was observed after 4 h treatment. At the highest test item concentration (15.0 µg/mL) the viability was reduced to 7 % and is therefore not suitable for inclusion in the final evaluation. For that reason, the four following test item concentrations (7.5 µg/mL, 3.75 µg/mL, 1.88 µg/mL and 0.94 µg/mL) were also analysed and used for the final evaluation. A

substantial and reproducible dose dependent increase in mutant colony numbers was observed and a relevant shift of the ratio of small versus large colonies was observed which may indicate that the test item is more likely to lead to the formation of structural chromosomal aberrations rather than gene mutations. The mutation frequency exceeded the threshold of 126 above the corresponding solvent control at the concentrations 7.5 µg/mL and 3.75 µg/mL. According to the OECD 490 the result of this approach has to be considered as "clearly positive".

In experiment II without metabolic activation, which was performed with much lower test item concentrations (1 µg/mL) than experiment I (15 µg/mL). The lower starting concentration of 1 µg/mL was a sponsor request. The biological relevance was the basis of the decision. No significant reduction of growth was observed after 24 h treatment with test item (all concentrations). Therefore, the four highest test item concentrations (1.0 µg/mL, 0.9 µg/mL, 0.8 µg/mL and 0.6 µg/mL) could be evaluated for mutagenicity. No substantial and reproducible dose dependent increase in mutant colony numbers was observed in this experiment.

Taken together, a cytotoxic as well as mutagenic potential of the test item Hyperharmonized hydroxylated fullerene water complex (3HFWC) was only found in the approach without metabolic activation. In the presence of metabolic activation, mutagenic as well as cytotoxic potential of the test item was not detected. Nevertheless, according to OECD 490, the test item has to be classified as "positive" in the mouse lymphoma assay.

In conclusion, it can be stated that under the experimental conditions reported the test item did induce gene mutations at the *thymidine kinase locus (Tk1)* in heterozygous mouse lymphoma L5178Y *Tk+/-* cells. Therefore, the test item Hyperharmonized hydroxylated fullerene water complex (3HFWC) is considered to be "mutagenic under the conditions of the mouse lymphoma assay" without metabolic activation.

Ref: Study No. 22032914G880

### SCCS comments

The SCCS agrees with the conclusion of the study and considers Hydrated forms of Hydroxylated Fullerenes (HFWC) positive in mammalian gene mutation test. The study was performed according to OECD TG 490 under GLP conditions.

SCCS however noted that:

- characterisation data for Hydrated forms of Hydroxylated Fullerenes in dispersion (size, size distribution, agglomeration) was not provided.
- information was not provided on the internalisation of nanoparticles by cells to interact directly with the DNA or cause genotoxicity via indirect mechanisms (e.g. DNA associated proteins, mitotic spindle apparatus, oxidative stress, etc.)
- the highest concentration of Hydroxylated fullerene C<sub>60</sub> 0.015 % (active component of the test item) tested was 15.0 µg/mL for short treatment and 1 µg/mL for 24h treatment instead of 2 mg/mL. The highest concentration to be tested was requested by the sponsor.

### Overall SCCS comments on mutagenicity/genotoxicity of Hydrated forms of Hydroxylated Fullerenes

There is a high uncertainty due to missing information on characterisation and cellular uptake of hydrated forms of hydroxylated fullerenes. However, the SCCS considers that hydrated forms of hydroxylated fullerenes are potentially genotoxic due to the indication of positive chromosomal aberration results in both *in vitro* micronucleus studies.

One additional study (Study No. 22032914G880) on mouse lymphoma assay on Hydrated forms of Hydroxylated Fullerenes was provided during the commenting period at the request of the SCCS. The SCCS considers results of this study as positive, which confirms that hydrated form of hydroxylated fullerenes are potentially genotoxic.



**Overall SCCS comments on mutagenicity/genotoxicity on fullerenes, hydroxylated fullerenes and Hydrated forms of Hydroxylated Fullerenes**

Having considered all the information provided by the Notifiers, the SCCS cannot conclude on the genotoxicity of fullerenes (C60, C70) and hydroxylated fullerenes.

The SCCS considers that the hydrated forms of hydroxylated fullerenes are potentially genotoxic.

To exclude the genotoxicity potential of the notified materials, the Notifiers need to provide valid information (data) from mammalian cell gene mutation assays and a micronucleus test performed with the relevant nanomaterials. This information may be provided either from the published literature (if available) relating to these nanomaterials, or from experimental studies. Cellular uptake of the nanoparticle also needs to be confirmed in such studies.

Physicochemical characterisation data for the test materials should be provided, e.g. quantitative TEM analysis, description of the dispersion method used, and the measurement of stability of nanoparticle suspensions in the culture media (SCCS/1611/19).

**3.4.6 Carcinogenicity****Fullerenes:**

There are no data about the carcinogenic properties of fullerenes.

Ref: FULLERENES toxicity profile

**Hydroxylated fullerenes**

Data were not provided.

**Hydrated forms of Hydroxylated Fullerenes**

Data were not provided.

**SCCS comment**

Data on carcinogenicity were not provided on any of the materials assessed in this Opinion. As described in the SCCS Guidance on Nanomaterials (SCCS/1611/19), information on carcinogenicity is required if significant systemic exposure or genotoxicity cannot be excluded. The SCCS considers that the currently available information is not sufficient to exclude both systemic availability via the relevant uptake route(s), and genotoxicity, to allow discounting the need for information on carcinogenicity. Data on carcinogenicity potential will therefore be needed if further evidence cannot exclude systemic availability and/or genotoxicity of the material included in this safety assessment.

**3.4.7 Reproductive toxicity****Fullerenes**

According to the Notifier, some toxicity data show reprotoxic properties of Fullerene C60, however, those kinds of effects are not expected after dermal application (the effects were noted after injection or intraperitoneally administered fullerenes).

Ref: FULLERENES toxicity profile

**Hydroxylated fullerenes**

Data were not provided.



**Hydrated forms of Hydroxylated Fullerenes**

Data were not provided.

**SCCS comment**

Information on reproductive toxicity of the Notified materials was not provided. As described in the SCCS Guidance on the Safety Assessment of Nanomaterials in Cosmetics (SCCS/1611/19), information on reproductive toxicity is required if systemic exposure cannot be excluded.

**3.4.8 Photo-induced toxicity****Fullerenes**

The following information was provided by the Notifier:

**1. Skin photosensitization study in Guinea pigs**

Guideline: /  
Test material: Raw Fullerenes powder 50% w/v in propyleneglycol (PG) for induction.  
Raw Fullerenes powder 25% w/v in propyleneglycol for challenge.  
(PG) for control induction  
(TBS) 2% w/v in acetone as positive control  
FCA as adjuvant intradermally on each induction site  
Lot: 040406: raw Fullerene powder containing 66.4% Fullerene C60  
Animals: 30 male guinea pigs, Hartley strain  
Irradiation: Long-wave UV, 10 J/cm<sup>2</sup>  
Schedule: 10 animals induced with fullerenes in PG and UV, days 1-5  
5 with TBS in acetone with UV on days 1-5  
with FCA and UV on days 1-5  
Challenge on day 23  
Year: 2004  
Results: No skin reactions on the sites challenged & irradiated with fullerenes or PG.  
Skin reactions on all the sites challenged with TBS and UV.

Ref: study report B040378

**2. Skin phototoxicity study in Guinea pigs**

Guideline: /  
Test material: raw Fullerenes powder 25% w/v in propyleneglycol (PG).  
8-Methoxypsoralen 0.005% in 70% ethanol as positive control.  
Propylene glycol as negative control  
Lot: 040406: raw Fullerene powder containing 66.4% Fullerene C60 (same lot as the combined study B040378 mentioned above)  
Animals: 10 male guinea pigs, Hartley strain  
Irradiation: Long-wave UV, above 320 nm, 11.2 J/cm<sup>2</sup>  
Schedule: Irradiation started 30 mins after application of the test articles  
Reading of test sites at 24, 48 and 72 hrs after irradiation  
Year: 2004  
Results: No skin reactions on the irradiated sites treated with fullerene powder or suspension or propyleneglycol. Skin reactions on all the irradiated sites treated with 8-Methoxypsoralene (pos control).

Ref: study report B040379

**3. Combined phototoxicity and photosensitization patch-test study in humans**

Guideline: /  
Test material: raw Fullerene powder 3% w/v dispersed in petrolatum.

Control: Saline.  
Lot: product ID 10970, code 080508001  
Subjects: 36 humans enrolled, 28 completed  
Irradiation: Induction: UV-A and UVB 6.2 J. Challenge: UVA 6.4 J  
Schedule: Induction: 2x/week for 3 wks test material 24hrs, followed by irradiation.  
Challenge: after 10 days rest, patch-test 24 hrs, followed by UVA irradiation.  
Year: 2020  
Results: No skin reactions on the sites challenged & irradiated with fullerenes or PG.  
Skin reactions on all the sites challenged with the positive control and UV.

Ref: study report NDR-0006972

**SCCS comment**

The design of the study in humans is a modification of an HRIPT. While conclusions about photosensitisation cannot be drawn, the study points towards the absence of phototoxicity by the test material (fullerene). From the test report, the exact composition of the test material (described as natural fullerene) is unclear; according to the Notifier's report it is about 70-70% fullerene C60 and 20-30% fullerene C70.

The Guinea pig studies indicate absence of phototoxic potential of the fullerenes.

**Hydroxylated fullerenes:**

/

**Hydrated forms of Hydroxylated Fullerenes:**

The following information was provided by the Notifier:

***In vitro* phototoxicity test**

Test system: 3T3 NRU phototoxicity test  
Guideline: OECD 432  
Test material: Transparent yellow liquid stock solution 1 g/L  
Batch: 01-2021-12-07  
Test concentrations: 0.39 – 50 µg/mL from stock solution  
Date: 2022  
Result: PIF 7.9, indicating phototoxicity

Ref: ENAC – Instit Val Micr TX/22/088 (2022)

**SCCS comment**

The study shows that hydrated forms of hydroxylated fullerenes are phototoxic. Although a clear specification of the test material was not provided in the report, the SCCS assumes that it is the same material that was used in the Are-Nrf-2 Luciferase test for sensitisation. In a subsequent response to queries from the SCCS, the Notifier stated that, based on the cell viability data, the results of phototoxicity test and PIF calculation should be taken with caution.

**SCCS overall comment on phototoxicity**

Hydroxylated fullerene and its aggregates absorb both UVA and VIS radiation and have the potential to act phototoxically on the skin and the eye. Hydroxylated fullerene exposed to UV or VIS radiation has been shown to be phototoxic to human keratinocytes *in vitro* (Zhao *et al.* 2008). Hydroxylated fullerene has also been reported to cause phototoxic damage to epithelial cells of the human lens *in vitro* (Roberts *et al.*, 2008), and the pigment epithelial cells of the retina (Wielgus *et al.*, 2010). Therefore, hydroxylated fullerenes can be regarded as phototoxic. Similar concerns about phototoxicity are also applicable to hydrated forms of hydroxylated fullerenes.

### 3.4.9 Human data

#### Skin sensitisation

##### Fullerenes:

The relevant skin irritation and sensitisation studies in humans are covered in the section 3.4.2

##### Hydroxylated fullerenes: /

##### Hydrated forms of hydroxylated fullerenes:

One Notifier has submitted clinical studies with formulated cosmetic products containing HFWC. The SCCS does not consider studies on products for an assessment of the safety of a specific ingredient.

### 3.4.10 Special investigations

#### Information from the Notifier

##### ***In-vitro* cytotoxicity and *in-vivo* (Drosophila) toxicity**

An *in-vitro* study on effect of fullerlenols (C60(OH)20, C60(OH)24 and C60(OH)30) on human skin cells by Saathof *et al.* in 2011 showed that the tested substances had no effect on HEK viability, suggesting they are not toxic to HEK at concentrations up to 8,5 µg/ml. Only at highest concentration C60(OH)30 tested, 42.5 µg/mL, significant decrease in cell viability was noted at 24 h. By 48 h, however, the cells appeared to recover from the treatment. Characterisation studies suggest that fullerlenol agglomeration increased with concentration and decreased with hydroxyl groups at 8.5 and 42.5 µg/mL, indicating a possible relation between agglomeration at very high concentrations and observed effect. These effects are only seen at high concentrations, which may exist outside of any potentially achievable biological exposure.

Ref: *In vitro* toxicity assessment of three hydroxylated fullerenes in human skin cells; J.G. Saathof *et al.*, *Toxicology in Vitro* 25 (2011) 2105–2112

A recent study from 2019 by O. Bolshakova *et al.* studied *in-vitro* toxicity on Chinese hamster lung fibroblasts (cell line V79) and HeLa cells (human cervix carcinoma cells) and *in-vivo* toxicity on *Drosophila* wild type Canton-S (alternative model study). The results showed that C60(OH)30 and C70(OH)30 at concentrations 0.1 mg/mL, 0.5 mg/mL and 1 mg/mL are non-toxic for cells and that even high concentrations, such as 1mg/ml for C60(OH)30 and C70(OH)30 did not cause a significant increase in the level of apoptosis in cells compared to control. *In-vivo* study on *Drosophila* Canton-S line flies (a model system for evaluating the toxicities of artificial nanomaterials) showed that the studied compounds administered in dose at 2 mg/mL (the flies were fed with yeast that contained fullerlenols during the duration of their life) did not cause the decrease in the life span and did not change the form of the survival curve. The results of this study indicate that studied fullerlenols are of very low toxicity.

Ref: *In vitro* and *in vivo* study of the toxicity of fullerlenols C60, C70 and C1200 obtained by an original two step method; O. Bolshakova *et al.* *Materials Science and Engineering: C* Volume 104, November 2019, 109945

Notifiers Conclusions: Based on the above referred studies, it can be concluded that *in-vitro* studies and an *in-vivo* alternative study on *Drosophila* indicate very low toxicity of Hyperharmonised Fullerlenol-Water Complex (HFWC). The lowest No Observed Effect Level (NOEL) of 8.5 µg/ml is significantly higher than the potentially achievable biological

concentrations when used in cosmetic products (0.0006 µg/g bw/day, which equals the average tissue concentration of 0,0006 µg/mL).

Ref: 281\_safety\_file\_2020-3-12-18-44-18

#### **SCCS comment**

The SCCS considers that this study is more relevant to environmental risk assessment and not suitable for deriving a PoD for assessment of risk to human health.

### **3.5 SAFETY EVALUATION (INCLUDING CALCULATION OF THE MOS)**

#### **SCCS comment**

The SCCS has noted that Notifiers have provided calculations for the Margin of Safety (MoS) for fullerenes and hydrated forms of hydroxylated fullerenes. However, the SCCS considers that calculation of MoS is not possible because genotoxicity potential cannot be excluded on the basis of the available data on any of the materials considered in this Opinion.

### **3.6 DISCUSSION**

The information provided by three Notifiers through CPNP on the materials considered in this Opinion was assessed by the SCCS, and further clarifications were requested where appropriate. Additionally, a call for information was made and a literature search performed by the Commission to obtain further information from other sources. In developing this Opinion, the SCCS has taken into account the responses received from the Notifiers, the information received from the Commission's call for information, and the results of the open literature search.

Having considered all the available information, the SCCS is of the view that the information available at present is insufficient to allow drawing conclusions on the safety of fullerenes, hydroxylated fullerenes, and the hydrated forms of hydroxylated fullerene.

- According to two Notifiers, the raw fullerene powder is a mixture of C60 and C70, and the content of C60 measured in five batches ranges approximately from 70 to 80%. Considering that there are similarities between fullerenes C60 and C70 in terms of chemical composition, structural features, and toxicological aspects tested via *in vitro* assays, the SCCS has accepted the Notifier's justification for data read-across between the two fullerenes.
- In the absence of reasonable scientific explanation for the nature of bonding involved between hydroxylated fullerenes and water molecules, the SCCS has considered in this Opinion the hydrated form of hydroxylated fullerene as equivalent to other hydroxylated fullerenes dispersed in aqueous media – with an additional proportion of H<sub>2</sub>O<sub>2</sub>.
- Unless sound experimental data on the dermal absorption of the notified nanomaterials are provided, the use of default value of 50% is recommended by the SCCS.

The following information/data is missing and is needed for safety assessment:

- Detailed information on the levels of impurities, heavy metals, accompanying contaminants, organic solvents, and any co-synthesised by-product for fullerenes (C60 and C70), hydroxylated fullerenes and hydrated forms of hydroxylated fullerenes.
- Chemical characterization (the exact chemical formula, and percentage content) of fullerene epoxides that are present as manufacturing byproducts in Fullerene raw powder.

- Evidence to support the claim that H<sub>2</sub>O<sub>2</sub> is not available for imparting any reactions/transformations of the starting material (hydroxylated fullerene) during the manufacturing process of the hydrated forms of hydroxylated fullerenes, or cause adverse cellular effects due to the formation of oxyradicals.
- Accurate quantification of H<sub>2</sub>O<sub>2</sub> content in the hydrated forms of hydroxylated fullerenes.
- Detailed quantitative EM analysis for accurate measurement of size distribution of the particles in the nanoscale.
- Information indicating the particle shape, aspect ratio and agglomeration/ aggregation state of the hydroxylated fullerenes and hydrated forms of hydroxylated fullerenes and data on the surface charge of hydroxylated fullerenes.
- Detailed information on homogeneity and stability of the notified nanomaterials.
- Information/data on the function and uses.
- Data on the systemic availability for fullerenes (C<sub>60</sub> and C<sub>70</sub>), hydroxylated fullerenes and hydrated forms of hydroxylated fullerenes.
- Valid information (data) on mammalian cell gene mutation assays and micronucleus test performed with the notified nanomaterials - either from published studies with these nanomaterials, and/or new experimental studies. Cellular uptake of the nanoparticles needs to be confirmed for the study results to be acceptable.
- Phototoxic potential of hydroxylated fullerenes, including hydrated forms of hydroxylated fullerenes (HFWC) need to be excluded to address the concern for consumer safety when used in leave-on products that are applied to (sun)light exposed skin.

In Annex-I, the SCCS has provided more detailed views about concerns over the risks that the use of these materials in cosmetic products may pose to the consumer.

#### 4. CONCLUSION

##### **The SCCS concludes the following:**

1. In view of the above, and taking into account the scientific data provided, does the SCCS consider Fullerenes, Hydroxylated Fullerenes and hydrated forms of Hydroxylated Fullerenes safe when used in cosmetic products according to the maximum concentrations and specifications as reported via CPNP, taking into account reasonably foreseeable exposure conditions?

Having assessed the information provided by the Notifiers, and the information available from published literature, the SCCS cannot conclude on the safety of fullerenes and (hydrated) hydroxylated forms of fullerenes due to a number of uncertainties and data gaps in regard to physicochemical, toxicokinetic and toxicological aspects. These uncertainties and data gaps have been indicated in relevant sections of the Opinion and must be addressed by the Notifiers to enable a conclusion on the safety of these materials for use in cosmetic products.

In particular, the SCCS cannot exclude the genotoxicity potential of fullerenes (C<sub>60</sub> and C<sub>70</sub>). The available evidence also indicates that hydrated forms of hydroxylated fullerenes are genotoxic and hence the SCCS considers them as not safe for use in cosmetic products. In view of the equivalence to hydrated forms of hydroxylated fullerenes, as discussed in section 3.1.1.5, the same concerns over genotoxicity potential also apply to hydroxylated fullerenes.

2. Based on the currently available scientific literature and SCCS' expert judgement, the SCCS is requested to assess any further scientific concerns with regard to the use of Fullerenes, Hydroxylated Fullerenes and hydrated forms of Hydroxylated Fullerenes in cosmetic products and whether a potential risk to human health can be identified according to Article 16(6) Reg.1223/2009.

In Annex-1 of this Opinion, the SCCS has noted the basis for concerns over the risks that the use of fullerenes, hydroxylated fullerenes and hydrated forms of hydroxylated fullerenes in cosmetic products may pose to the consumer. In brief, the SCCS has concerns in regard to:

- the potential presence of impurities (such as epoxide forms), heavy metals, accompanying contaminants and/or organic solvents in the notified nanomaterials. There is also a lack of data on the stability of hydroxylated fullerenes and their hydrated forms.
- the potential ability of fullerenes and derivatives to induce production of free oxyradicals when used in cosmetic products.
- phototoxicity of hydroxylated fullerenes – with similar concerns for the hydrated forms of hydroxylated fullerenes.
- sensitising potential of hydroxylated fullerenes.
- potential dermal absorption and systemic availability of the nanoparticles via the use in cosmetic products.
- potential distribution of systemically available fullerenes to various organs in the body and accumulation of the nanoparticles in certain organs – such as lungs and liver.
- the available evidence being insufficient to allow the SCCS to exclude genotoxic/carcinogenic potential of any of the materials assessed in this Opinion.

## **5. MINORITY OPINION**

None.

## 6. REFERENCES

- Abrefah J. and Olander D.R. (1992): Vapor pressure of Buckminsterfullerene. *Applied Physics Letters*; 60: 1313-1314. <https://doi.org/10.1063/1.107327>
- Ahmad S. (1999) FIETE. Carbon Nanostructures Fullerenes and Carbon Nanotubes. *IETE Technical Review*; 16(3-4): 297-310. <https://doi.org/10.1080/02564602.1999.11416845>
- Aoshima H., Saitoh Y., Ito S., Yamana S., Miwa N. (2009): Safety evaluation of highly purified fullerenes (HPFs): Based on screening of eye and skin damage. *J. Toxicol. Sci.* ;34(5):555-562, <http://doi.org/10.2131/jts.34.555>
- Arai T., Murakami Y., Suematsu H., Kikuchi K., Achiba Y., Ikemoto I. (1992): Resistivity of single crystal C60 and effect of oxygen. *Solid State Communications*; 84: 827-829 [https://doi.org/10.1016/0038-1098\(92\)90099-U](https://doi.org/10.1016/0038-1098(92)90099-U)
- Baati T., Bourasset F., Gharbi N., Njim L., Abderrabba M., Kerkeni A., Szwarc H., Moussa F. (2012). The prolongation of the lifespan of rats by repeated oral administration of [60]fullerene. *Biomaterials* ;33(19):4936-4946 <http://dx.doi.org/10.1016/j.biomaterials.2012.03.036>
- Beckhaus H.D., Ruchardt C., Kao M., Diederich F., Foote C.S. (1992) The Stability of Buckminsterfullerene (C60): Experimental Determination of the Heat of Formation. *Angewandte Chemie-International Edition in English*; 31: 63-64 <https://doi.org/10.1002/anie.199200631>
- Cadek M *et al.* (199 – 2013) Carbon, 7. Fullerenes and Carbon Nanomaterials. *Ullmann's Encyclopedia of Industrial Chemistry*. 7<sup>th</sup> edition. New York, NY: John Wiley & Sons. Online Posting Date: Jan 15, 2010, from HSDB.
- Cataldo F. and Braun T. (2007) The solubility of C60 fullerene in long chain fatty acids esters, Fullerenes, Nanotubes and Carbon Nanostructures; 15:5, 331-339 <http://dx.doi.org/10.1080/15363830701512450>
- EFSA Scientific Committee, More, S., Bampidis, V., Benford, D., Bragard, C., Halldorsson, T., Hernández-Jerez, A., Bennekou, S. H., Koutsoumanis, K., Lambré, C., Machera, K., Naegeli, H., Nielsen, S., Schlatter, J., Schrenk, D., Silano, V., Turck, D., Younes, M., Castenmiller, J., Chaudhry, Q., Cubadda, F., Franz, R., Gott, D., Mast, J., Mortensen, A., Oomen, A. G., Weigel, S., Barthelemy, E., Rincon, A., Tarazona, J., & Schoonjans, R. (2021). Guidance on technical requirements for regulated food and feed product applications to establish the presence of small particles including nanoparticles. *EFSA Journal*, 19(8), e06769. <https://doi.org/10.2903/j.efsa.2021.6769>
- Ema M., Matsuda A., Kobayashi N., Naya M., Nakanishi (2013) J. Dermal and ocular irritation and skin sensitization studies of fullerene C60 nanoparticles. *Cutan. Ocul. Toxicol.* ;32(2):128-134. <http://dx.doi.org/10.3109/15569527.2012.727937>
- Fujita, K. *et al.* (2009) Gene expression profiles in rat lung after inhalation exposure to C60 fullerene particles, *Toxicol.*, 258: 47-55. <https://doi.org/10.1016/j.tox.2009.01.005>
- Hendrickson O.D., Zherdev A.V., Gmshinskii I.V., Dzantiev B.B. (2014) Fullerenes: *In Vivo* Studies of Biodistribution, Toxicity, and Biological Action, *Nanotechnologies in Russia*; 9(11-12), 601-617. <https://doi.org/10.1134/S199507801406010X>
- Heiney P.A., Fischer J.E., McGhie A.R., Romanow W.J., Denenstien A.M., McCauley Jr. J.P., Smith A.B., Cox D.E. (1991). Orientational ordering transition in solid C60. *Physical Review Letters*; 2911-2914. <https://doi.org/10.1103/PhysRevLett.66.2911>
- Hirsch A., Brettreich M. (2005): Fullerenes: chemistry and reactions, *J. Am. Chem. Soc.*, 127, 33, 11876. <https://doi.org/10.1021/ja059725z>
- Horie M., Nishio K., Kato H., Shinohara N., Nakamura A., Fujita K., Kinugasa S., Endoh S., Yoshida Y., Hagihara Y., Iwahashi H. (2013) *In vitro* evaluation of cellular influences induced



- by stable fullerene C70 medium dispersion: Induction of cellular oxidative stress. *Chemosphere*, 93(6), 1182-1188. <https://doi.org/10.1016/j.chemosphere.2013.06.067>
- Ji Z.Q, Sun H., Wang H., Xie Q., Liu Y., and Wang Z. (2006) Biodistribution and tumor uptake of C<sub>60</sub>(OH)<sub>x</sub> in mice, *J. Nanoparticle Res.* 8 (1), 53–63. <https://doi.org/10.1007/s11051-005-9001-5>
- Kato S., Aoshima H., Saitoh Y., Miwa N. (2009) Biological safety of lipofullerene composed of squalane and fullerene-C60 upon mutagenesis, photocytotoxicity, and permeability into the human skin tissue. *Basic. Clin. Pharmacol. Toxicol.*; 104(6): 483–487, <http://dx.doi.org/10.1111/j.1742-7843.2009.00396.x>
- Kubota R., Tahara M., Shimizu K., Sugimoto N., Hirose A., Nishimura T. (2011) Time-dependent variation in the biodistribution of C60 in rats determined by liquid chromatography-tandem mass spectrometry, *Toxicol. Lett.*; 206: 172-177 <http://dx.doi.org/10.1016/j.toxlet.2011.07.010>
- Li F.B., Wang G.W. Fullerenes. Kirk-Othmer (1999 – 2013) *Encyclopedia of Chemical Technology*. New York, NY: John Wiley & Sons. Online Posting Date: 19 Apr 2013. <https://doi.org/10.1002/0471238961.0621121220012512.a01.pub2>
- Liosi, K., Stasyuk, A. J., Masero, F., Voityuk, A. A., Nauser, T., Mougel, V., Solà, M. & Yamakoshi, Y. (2021). Unexpected Disparity in Photoinduced Reactions of C60 and C70 in Water with the Generation of O<sub>2</sub><sup>•-</sup> or <sup>1</sup>O<sub>2</sub>. *JACS Au*, 1(10), 1601–1611 <https://doi.org/10.1021/jacsau.1c00239>
- Mrdanovic J., Solajic S., Bogdanovic V., Stankov, K., Bogdanovic G., Djordjevic A. 2(2009). Effects of fullerene C<sub>60</sub>(OH)<sub>24</sub> on the frequency of micronuclei and chromosome aberrations in CHO-K1 cells. *Mutation Research* 680, 25–30 <https://doi.org/10.1016/j.mrgentox.2009.08.008>
- Merkus H.G. (2009). *Particle size measurements: fundamentals, practice, quality*, Springer Science & Business Media, ISBN: 978-1-4020-9015-8.
- Monteiro-Riviere N.A., Linder K.E., John A.O., Saathoff G., Xia X.-R., Riviere J.E. (2012). Lack of Hydroxylated Fullerene Toxicity after Intravenous Administration to Female Sprague-Dawley Rats; *J Toxicol Environ Health A*; 75(7): 367–373. <https://doi.org/10.1080/15287394.2012.670894>
- Mori T., Takada H., Ito S., Matsubayashi K., Miwa N., Sawaguchi T. (2006). Preclinical studies on safety of fullerene upon acute oral administration and evaluation for no mutagenesis, *Toxicology* 225, 48–54, <https://doi.org/10.1016/j.tox.2006.05.001>
- Morimoto, Y. *et al.* (2010) Inflammogenic effect of well-characterized fullerenes in inhalation and intratracheal instillation studies, *Part. Fibre. Toxicol.*, 7:4 <https://doi.org/10.1186/1743-8977-7-4>
- Mort J., Machonkin, M., Ziolo R. (1992) Temperature dependence of photoconductivity in buckminsterfullerene films. *Appl. Phys. Lett.*; 60: 1735-1737. <https://doi.org/10.1063/1.107201>
- Naota M, Shimada A., Morita T., Inoue K., Takano H. (2009) Translocation Pathway of the Intratracheally Instilled C60 Fullerene from the Lung into the Blood Circulation in the Mouse: Possible Association of Diffusion and Caveolae-mediated Pinocytosis, *Toxicologic Pathology*; 37, 456-462. <https://doi.org/10.1177/0192623309335059>
- OECD 2016: ENV/JM/MONO(2016)21: Environment Directorate Joint Meeting Of The Chemicals Committee And The Working Party On Chemicals, Pesticides And Biotechnology Fullerenes (C60): Summary Of The Dossier Series on the Safety of Manufactured Nanomaterials No. 69.
- Qiao R., Roberts A.P., Mount A.S., Klaine S.J., Ke R.CH. (2007). Translocation of C60 and Its Derivatives Across a Lipid Bilayer, *Nanoletters*, 7(3), 614-619. <https://doi.org/10.1021/nl062515f>

- Ogami, A. *et al.* (2011). Pathological features of rat lung following inhalation and intratracheal instillation of C60 fullerene, *Inhal. Toxicol.*, 2011; 23(7): 407-416. <https://doi.org/10.3109/08958378.2011.580386>
- Pan C., Sampson M.P., Chai Y., Hauge R.H., Margrave J.L. (1991). Heats of sublimation from a polycrystalline mixture of carbon clusters (C60 and C70). *J Phys Chem*; 95: 2944-2946. <https://pubs.acs.org/doi/pdf/10.1021/j100161a003>
- Proskurnina E.V., Mikheev I.V., Savinova E.A., Ershova E.S., Veiko N.N., Kameneva L.V., Dolgikh O.A., Rodionov I.V., Proskurnin M.A., Kostyuk S.V. (2021). Effects of Aqueous Dispersions of C60, C70 and Gd@C82 Fullerenes on Genes Involved in Oxidative Stress and Anti-Inflammatory Pathways. *Int. J. Mol. Sci.*, 22, 6130 <https://doi.org/10.3390/ijms22116130>
- Ryan J.J., Bateman H.R., Stover A., Gomez G., Norton S.K., Zhao W., Schwartz L.B., Lenk R., Kepley C.L. (2007). Fullerene nanomaterials inhibit the allergic response. *J Immunol.* Jul 1;179(1):665-72. <https://doi.org/10.4049/jimmunol.179.1.665>
- Roberts J.E., Wielgus A.R., Boyes W.K., Andley U., Chignell C.F. (2008). Phototoxicity and cytotoxicity of fullerol in human lens epithelial cells. *Toxicol. Appl. Pharmacol.*; 228: 49–58. <https://doi.org/10.1016/j.taap.2007.12.010>
- Shinohara N., Matsumoto K., Endoh S., Maru J., Nakanishi J. (2009). *In vitro* and *in vivo* genotoxicity tests on fullerene C60 nanoparticles. *Toxicol. Lett.*;191(2–3):289–296, <http://dx.doi.org/10.1016/j.toxlet.2009.09.012>
- Shinohara N., Nakazato T, Tamura M., Endoh S., Fukui H., Morimoto Y., Myojo T., Shimada M., Yamamoto K., Tao H., Yoshida Y., Nakanishi J. (2010). Clearance kinetics of fullerene C60 nanoparticles from rat lungs after intratracheal C60 instillation and inhalation C60 exposure. *Toxicol Sci.* ;118(2):564-73. <https://doi.org/10.1093/toxsci/kfq288>
- Shipelin V.A., Smirnova T.A., Gmshinskii I.V., Tutelyan V.A. (2015). Analysis of toxicity biomarkers of fullerene C60 nanoparticles by confocal fluorescent microscopy. *Bull. Exp. Biol. Med.* ;158(4):443–449, <http://dx.doi.org/10.1007/s10517-015-2781-4>
- Sivaraman N., Dhamodaran R., Kaliappan I., Srinivasan T. G., Vasudeva Rao P. R. P., Mathews C. K. C. (1994). Solubility of C70 in Organic Solvents, *Fullerene Science and Technology*; 2 (3): 233-246. <https://doi.org/10.1080/15363839408009549>
- Scrivens W.A., Tour J.M. (1992) Synthesis of gram quantities of C60 by plasma discharge in a modified round-bottomed flask. Key parameters for yield optimization and purification. *J Org Chem.* 57(25):6932-6936. <https://doi.org/10.1021/jo00051a047>
- Taylor R; Fullerenes. Kirk-Othmer (2001). *Encyclopedia of Chemical Technology*. New York, NY: John Wiley & Sons. Online Posting Date: Sept 20, 2002 from HSDB.
- Takahashi M., Kato H., Doi Y., Hagiwara A., Hirata-Koizumi M., Ono A., Kubota R., Nishimura T., Hirose A. (2012). Sub-acute oral toxicity study with fullerene C60 in rats, *J. Toxicol. Sci.*; 37(2): 353-361. <https://doi.org/10.2131/jts.37.353>
- Wielgus A.R., Baozhong Z., Chignell C.F., Hu D.N., Roberts J.E. (2010). Phototoxicity and cytotoxicity of fullerol in human retinal pigment epithelial cells. *Toxicology and Applied Pharmacology*; 242: 79-90. <https://doi.org/10.1016/j.taap.2009.09.021>
- Xia X.R., Monteiro-Riviere N.A., Riviere J.E. (2010). Skin penetration and kinetics of pristine fullerenes (C60) topically exposed in industrial organic solvents, *Toxicol. Appl. Pharmacol.*; 242(1):29-37. <http://dx.doi.org/10.1016/j.taap.2009.09.011>
- Zhao B., He Y.Y., Bilski P.J., Chignell C.F. (2008). Pristine (C60) and hydroxylated [C60(OH)24] fullerene phototoxicity towards HaCaT keratinocytes: type I vs type II mechanisms. *Chem. Res. Toxicol.*; 21(5): 1056-1063. <https://doi.org/10.1021/tx800056w>

---

## Annex 1

### SCCS concerns over the safety of Fullerenes and Hydroxylated/Hydrated form of Hydroxylated Fullerenes

As indicated in this Opinion, the data/information provided by the Notifiers were not sufficient to enable a safety assessment of fullerenes, hydroxylated fullerenes and the hydrated forms of hydroxylated fullerenes. In view of this, the SCCS obtained and considered additional information on these materials from the published literature.

Although safety of the materials could still not be concluded on the basis of evaluation of all the available data/information, the SCCS has noted the following scientific aspects that raise a concern over the potential risk to consumer's health from the use of these materials in cosmetic products:

#### PHYSICOCHEMICAL ASPECTS

Fullerenes are lipophilic molecules that exist in the form of extremely small particles (below 1 nm), made of carbon lattice. Fullerenes are practically insoluble in water, whereas derivatives of fullerene with added hydroxyl (-OH) groups – such as hydroxylated fullerenes and their hydrated forms - are water-soluble. This makes them potentially useful for a variety of applications, including cosmetics. Surface chemistry, such as the degree of hydroxylation of fullerenes and concentration, may affect the degree of agglomeration and thus biological effects (Saathoff *et al.*, 2011). The presence of certain impurities, residual solvents, heavy metals and synthesis byproducts such as epoxides, in fullerenes and their derivatives is a common concern since they can affect their properties and behaviour, and potentially alter their efficacy and toxicity (Zhang *et al.*, 2009). It is, therefore, important to ensure the highest purity of fullerenes and their derivatives and minimise the potential presence of impurities that may affect their safety and efficacy.

In this regard, the SCCS has a concern that a proper evaluation of safety will not be possible without the provision of detailed information on the levels of impurities, heavy metals, accompanying contaminants and any organic solvents for the notified nanomaterials. Similar issues may arise from degradation of hydroxylated fullerenes and their derivatives (Rodriguez-Zavala *et al.*, 2006 ; Xing *et al.*, 2006 ; Kong *et al.*, 2009). Therefore, stability data of hydroxylated fullerene and hydrated forms of hydroxylated fullerenes are also important for a safety evaluation.

Due to their unique physicochemical properties, fullerenes and their hydroxylated derivatives have been reported to act both as pro-oxidants as well as antioxidants (Marcovic *et al.*, 2008 cited by Savinova *et al.*, 2023 ; Markelic *et al.*, 2022). It is well known that free radicals of oxygen are highly reactive and can cause oxidant damage to the exposed cells and tissues in the body. The SCCS has a concern in this regard for consumer safety and needs evidence to exclude the potential formation of free radicals by these materials when used as ingredients in cosmetic products.

#### TOXICOLOGICAL ASPECTS

##### Cytotoxicity *in vitro*

Harhaji *et al.* (2008) observed that C60/C70 and polyhydroxylated fullerene preparations (up to 250 µg/ml for 24 h, dispersed in serum-containing cell culture medium) were cytotoxic to the mouse L929 fibroblast cell line but that C60/C70 was more potent. Sayes *et al.* (2005) demonstrated that C60 fullerene (0.00024–2.4 µg/mL) exerted cytotoxicity that was mediated through enhanced ROS production, lipid peroxidation, and membrane damage in a variety of cell lines (dermal fibroblasts, hepatocytes, and astrocytes).

The SCCS is aware of other studies that have indicated lack of cytotoxicity results but considers that the available data are not sufficient to convincingly exclude the potential cytotoxicity of the fullerenes and fullerene-derivatives assessed in this Opinion under some exposure conditions of the materials.

### **Skin Sensitisation**

The test results available for hydroxylated fullerene and hydrated forms of hydroxylated fullerenes discussed in this opinion do not clearly exclude a sensitising potential.

### **Phototoxicity**

The available scientific literature indicates that hydroxylated fullerene as such, and in aggregated form, absorbs both UVA and VIS light, and has the potential to cause phototoxicity to skin and eyes. Hydroxylated fullerene exposed to UV or VIS radiation has been shown to be phototoxic to human keratinocytes *in vitro* (Zhao *et al.*, 2008). *In vitro*, hydroxylated fullerene has also been shown to cause phototoxic damage to epithelial cells of the human lens (Roberts, 2008), and the pigment epithelial cells of the retina (Wielgus, 2010).

Without excluding the phototoxicity potential of hydroxylated fullerenes and hydrated forms of hydroxylated fullerenes, these nanomaterials cannot be considered safe in cosmetic products intended for use on the skin exposed to sunlight.

### **Induction of lung inflammatory reaction**

From the published literature, the SCCS has noted a concern relating to inflammatory responses in the lung to fullerenes hydroxylated fullerenes and hydrated forms of hydroxylated fullerenes. Although the current evaluation did not consider the use the materials in cosmetic products that could lead to inhalation exposure of the consumer, it is still an important aspect to consider because the currently available evidence is not sufficient to exclude the possibility of systemic availability and accumulation of the nanoparticles in the lungs.

#### **Fullerene**

Gene expression profiles in the rat lung, after inhalation exposure to C60 fullerene, revealed that few genes involved in the inflammatory response, oxidative stress, apoptosis, and metalloendopeptidase activity were up-regulated at both 3 days and 1-month post-exposure (Fujita *et al.*, 2009). C60 fullerene after intratracheal instillation in mice induced an increase in sub G1 and G1 arrest in BAL cells, an increase in proinflammatory cytokines such as IL-1, TNF- $\alpha$ , and IL-6, and an increase of Th1 cytokines such as IL-12 and IFN $\gamma$  in BAL fluid (Park *et al.*, 2010). Cell infiltration and expression of tissue damage related genes in lung tissue were constantly observed during the experiment period. In addition to the effects on pulmonary responses (Sayers *et al.*, 2016; Pinheiro *et al.*, 2021), fullerenes were also reported to modulate the immune system (e.g. induction of splenic inflammatory process) (Ding *et al.*, 2011).

#### **Hydroxylated fullerene**

Xu *et al.* (2009) showed that the polyhydroxylated derivative of fullerene [C60(OH) $x$ ] was not able to induce adverse pulmonary pathological changes but elicited dose-dependent inflammation (increase in %neutrophils, IL-1 $\beta$ , TNF- $\alpha$  and IL-6) in BAL supernatants, associated with the nitric oxide synthase-dependent induction.

Intratracheal exposure to fullerols at a dose of 200  $\mu$ g (equivalent to 10 mg/kg) elicited a neutrophil-driven pulmonary inflammatory response, which was associated with increased macrophage inflammatory protein-2 production (Roursgaard *et al.*, 2008).

Although, the exposure route via lung is not relevant to the current submission, the SCCS is of the opinion that it might be of importance for other submissions where the materials are intended to be used in inhalable products that could lead to exposure of the consumer's lung (such as powders, sprayable products).

### **Genotoxicity/mutagenicity**

Analysis of the currently available information from published literature has yielded both negative and positive results for genotoxicity of fullerenes and fullerene-derivatives. For example, a dose-dependent increase in micronucleus frequencies by fullerene C60 was observed in A549 cells (Totsuka *et al.*, 2009), as well as in CHO, HeLa, and HEK293 cell lines after long-term incubation with C60(OH)<sub>24</sub> at picogram per mL concentrations (Niwa *et al.*,

2006).

Comet assay using stable aqueous suspensions of colloidal fullerenes C60 prepared by two methods - ethanol to water solvent exchange (EtOH/nC60 suspensions) and extended mixing in water (aqu/nC60 suspensions) - demonstrated genotoxicity potential for both types of suspensions. There was a strong correlation between the genotoxic response and the nC60 concentration, with genotoxicity observed at concentrations as low as 2.2 µg/L for aqu/nC60 and 4.2 µg/L for EtOH/nC60 (Dhawan *et al.*, 2006). Jacobsen *et al.* (2008) also reported an increase in FPG sensitive sites/oxidised purines in fullerenes C60 exposed FE1-Muta™ Mouse lung epithelial cells, as revealed by the Comet assay. In another study, in Comet assay C60 and C60(OH)<sub>24</sub> showed DNA damaging effect on HepG2 cells and human peripheral blood mononuclear cells (Vesterdal *et al.*, 2014; Sharoyko *et al.*, 2021).

Fullerene C60 has also been reported to induce DNA damage *in vivo* in the lungs of C57BL/6J mice, measured by Comet assay. Moreover, single, or multiple instillations of fullerenes C60 increased gpt mutant frequencies in the lungs of gpt delta transgenic mice (Totsuka *et al.*, 2009).

The SCCS is aware of other studies that have indicated negative genotoxicity results (see Section 3.4.5 of the Opinion) but considers that the currently available weight of evidence is not sufficient to conclusively exclude the genotoxicity potential of fullerenes, whereas available evidence for hydroxylated, and hydrated forms of hydroxylated fullerenes indicates genotoxic potential.

### **Systemic Toxicity**

#### *Fullerenes*

In a developmental toxicity study (Tsuchiya *et al.*, 1996 reviewed by Nielsen *et al.*, 2008 and Snyder *et al.*, 2015), fullerene C60/PVP was administered to pregnant SLC mice on gestational day (GD) 10 by intraperitoneal injection. The administered doses ranged from 25 to 137 mg/kg, and the effects were monitored at 18 hours following administration. At a dose of 137 mg/kg, all the embryos died and showed severe abnormalities. At a dose of 50 mg/kg, C60 was clearly distributed into the embryos based on the characteristic colour development of C60, and caused abnormalities, especially around the head region and tail. At 25 mg/kg, abnormal enlargement of the head was reported in one embryo. This study by Tsuchiya *et al.* (1996), however has certain shortcomings in that the number of animals per exposure group was low, the route of administration was unusual, and the study covered only a small part of the pregnancy period.

Fullerene C60 given intratracheally to mice (1.0 mg/kg bw) which were tested at 12, 24, 72 and 96 h thereafter, worsened the spermatic parameters in the animals over the whole study period (Pinheiro *et al.*, 2021).

Although the analysed studies have some limitations, they indicate potential developmental effects and therefore the need for further investigation to exclude the reproductive/developmental effects of fullerenes and the hydroxylated/hydrated derivatives.

### **Exposure Aspects**

Although the exposure calculations by the Notifier(s) have indicated that the amount to be used in cosmetics will be very small, considering the extremely small particle size of fullerenes and fullerene-derivatives, these amounts still represent very large number of the particles.

### **Dermal penetration**

#### *Fullerenes*

Some studies have suggested that fullerenes can penetrate the skin, particularly if they are formulated in a way that enhances dermal penetration. A study by Martins *et al.* (2017) showed that 14% of fullerene C60 dispersed in a solution of fatty acids was able to cross the intact skin into the receptor compartment. In this study, the localisation and permeation extent of fullerene C60 was depicted by TEM analysis that clearly showed the presence of fullerene C60 aggregates in the skin sample. Another study investigated the dermal penetration of a fullerene C60 derivative (fullerene coupled to a heptapeptide) in flexed and



unflexed porcine skin (Rouse *et al.*, 2007 reviewed by Nielsen *et al.*, 2008). The results of this study showed that the fullerene particles could penetrate to the dermis. Therefore, it can be inferred that systemic availability of fullerenes after dermal administration is possible. There are indications that skin penetration of pristine fullerenes C60 will be dependent of the solvent used (Xia *et al.*, 2010), and that dermal penetration of fullerenes and their derivatives may be modulated by the formulations they have been added to. This means that certain (lipophilic) formulations may enable them to cross the dermal barrier to reach other organs in the body.

### **Toxicokinetics/distribution**

#### **Fullerene**

Information from the available literature so far has indicated systemic bioavailability of fullerenes via the oral route. Systemically available fullerenes will be well distributed to various organs in the body and may accumulate in certain organs – such as lungs and liver (Hendrickson *et al.*, 2014). In studies using parenteral administration, approximately a quarter of a pristine Fullerene C60 suspension was found accumulated in the liver (mainly in Kupffer cells), where their levels remained constant for about one week (Gharbi *et al.*, 2005 reviewed by Nielsen *et al.*, 2008).

A study by Sumner *et al.* (2010) determined the distribution of <sup>14</sup>C-labelled fullerene C60 in the pregnant rat and fetuses, and in the lactating rat and offspring after i.v. administration of the radiolabelled fullerene C60 suspended in PVP. The results of this study indicated distribution to the placenta, fetuses, and to the milk and offspring of the exposed lactating dam. Another study by Snyder *et al.* (2015) investigated the distribution of [<sup>14</sup>C(U)]C60 (in 5% PVP-saline suspension) in pregnant and lactating rat exposed by the i.v. route at different developmental time points, and at different time points post administration. Radioactivity was distributed from mothers to their offspring both during pregnancy through the placenta to fetuses, and via milk to lactating pups. The distribution and organ specific distribution were different in pregnant and lactating rats. In the case of pregnant dams, maternal-fetal transfer depended on both the stage of gestation and the elapsed time between exposure and termination.

#### **Hydroxylated fullerene and their hydrated forms**

A study by Ji *et al.* (2006) used <sup>125</sup>I-labelled hydroxy-fullerenes, administered i.v. to mice that had been implanted subcutaneously with various tumours. These mouse models were used to study the accumulation of <sup>125</sup>I-C60(OH)<sub>x</sub> [x = ~ 24]. The results showed that <sup>125</sup>I-labelled hydroxy-fullerenes distributed to all major organs and accumulated mostly in liver, spleen, kidney, and bone tissues. In the same study, the distribution of <sup>125</sup>I-C60(OH)<sub>x</sub> in normal Kunming mice showed similar results.

It should also be kept in mind that the toxicokinetics of fullerenes derivatives may be influenced by surface modifications (Aschberger *et al.*, 2010).

The available studies, as discussed in this Opinion, also indicate the possibility that exposure to fullerenes, hydroxylated fullerenes and the hydrated forms of hydroxylated fullerenes could lead to systemic uptake via the relevant uptake routes. The evidence from toxicokinetics studies, although from non-dermal routes, further indicates that the systemically available nanoparticles can be distributed within the various organs in the body.

### **Conclusions**

The SCCS has identified a number of concerns over the safety of the notified nanomaterials due to:

- the potential presence of impurities, heavy metals, accompanying contaminants and organic solvents, and more information on the impurity profiles will be needed to exclude this concern. Stability data of hydroxylated fullerenes and their hydrated forms are also important for effective evaluation of the notified nanomaterials.
- potential systemic availability of fullerenes after dermal application. The limited available information also indicates that systemically available fullerenes and hydroxylated fullerenes will be widely distributed to various organs in the body and

may accumulate in certain organs – such as lungs and liver. Such information is not available for the hydrated forms of hydroxylated fullerenes.

- the potential ability of systemically available fullerenes and derivatives to induce production of free oxyradicals.
- insufficient evidence to exclude a sensitising potential of hydroxylated fullerenes.
- phototoxicity of hydroxylated fullerenes. Similar concerns for phototoxicity are also applicable to the hydrated forms of hydroxylated fullerenes.
- insufficient data to exclude genotoxic/carcinogenic potential of any of the materials assessed in this opinion – with indications that hydrated forms of hydroxylated fullerenes are potentially genotoxic.

## References for Annex I

1. Aschberger K, Johnston HJ, Stone V, Aitken RJ, Tran CL, Hankin SM, Peters SAK, Christensen FM (2010). Review of fullerene toxicity and exposure--appraisal of a human health risk assessment, based on open literature. *Regul Toxicol Pharmacol* ;58(3):455-73. <https://doi.org/10.1016/j.yrtph.2010.08.017>
2. Damgård Nielsen GD, Roursgaard M, Jensen KA, Alstrup K, Poulsen SS, Seier S, Larsen ST (2008). *In vivo*, Biology and Toxicology of Fullerenes and Their Derivatives, *Basic & Clinical Pharmacology & Toxicology*; 103, 197–208. <https://doi.org/10.1111/j.1742-7843.2008.00266.x>
3. Dhawan A, Taurozzi JS, Pandey AK, Shan W, Miller SM, Hashsham SA & Tarabara VV. (2006). Stable Colloidal Dispersions of C60 Fullerenes in Water: Evidence for Genotoxicity. *Environmental Science & Technology*, 2006 40(23), 7394–7401. <https://doi.org/10.1021/es0609708>
4. Ding N, Kunugita N, Ichinose T, Song Y, Yokoyama M, Arashidani K, & Yoshida Y. (2011). Intratracheal administration of fullerene nanoparticles activates splenic CD11b+ cells. *Journal of Hazardous Materials*, 194, 324–330. <https://doi.org/10.1016/j.jhazmat.2011.07.101>
5. Franskevych D, Palyvoda K, Petukhov D, Prylutska S, Grynyuk I, Schuetze C, ... Ritter U. (2017). Fullerene C60 Penetration into Leukemic Cells and Its Photoinduced Cytotoxic Effects. *Nanoscale Research Letters*, 12(1). <https://doi.org/10.1186/s11671-016-1819-5>
6. Fujita K, Morimoto Y, Ogami A, Myojyo T, Tanaka I, Shimada M, ... Nakanishi J. (2009). Gene expression profiles in rat lung after inhalation exposure to C60 fullerene particles. *Toxicology*, 258(1), 47–55. <https://doi.org/10.1016/j.tox.2009.01.005>
7. Gharbi N, Pressac M, Hadchouel M, Szwarc H, Wilson SR, Moussa F. (2005). [60]Fullerene is a powerful antioxidant *in vivo* with no acute or subacute toxicity. *Nano Lett* ;5:2578–85. <https://doi.org/10.1021/nl051866b>
8. Hendrickson O.D., Zherdev A.V., Gmoshinskii I.V., Dzantiev B.B. (2014) Fullerenes: *In Vivo* Studies of Biodistribution, Toxicity, and Biological Action, *Nanotechnologies in Russia*; 9(11–12), 601–617. <https://doi.org/10.1134/S199507801406010X>
9. Jacobsen NR *et al.* (2008). Genotoxicity, cytotoxicity, and reactive oxygen species induced by single-walled carbon nanotubes and C60 fullerenes in the FE1-Muta™ Mouse lung epithelial cells, *Environ. Mol. Mutagen.* 49 (6), 476–487. <https://doi.org/10.1002/em.20406>
10. Ji Z.Q, Sun H., Wang H., Xie Q., Liu Y., and Wang Z. (2006). Biodistribution and tumor uptake of C60(OH)<sub>x</sub> in mice, *J. Nanoparticle Res.* 8 (1), 53–63. <https://doi.org/10.1007/s11051-005-9001-5>
11. Kong L, Tedrow O, Chan YF, Zepp RG (2009). Light-Initiated Transformations of Fullerenol in Aqueous Media, *Environ. Sci. Technol.*, 43, 24, 9155–9160. <https://doi.org/10.1021/es901839q>
12. Markelic, M.; Draca, D.; Krajnovic, T.; Jovic, Z.; Vuksanovic, M.; Koruga, D.; Mijatovic, S.; Maksimovic-Ivanic, D. (2022). Combined Action of Hyper-Harmonized Hydroxylated Fullerene Water Complex and Hyperpolarized Light Leads to Melanoma Cell Reprogramming *In Vitro*. *Nanomaterials*, 12, 1331



- <https://doi.org/10.3390/nano12081331>
13. Markovic, Z.; Trajkovic, V. Biomedical potential of the reactive oxygen species generation and quenching by fullerenes (C60). *Biomaterials* 2008, 29, 3561–3573
  14. Martins M., Azoia N.G., Melle-Franco M., Ribeiro A., Cavaco-Paulo A. Permeation of skin with (C60) fullerene dispersions. *Eng Life Sci.* 2017 17(7): 732–738.
  15. Niwa Y and Iwai N. (2006). Genotoxicity in Cell Lines Induced by Chronic Exposure to Water-Soluble Fullerenes Using Micronucleus Test. *Environmental Health and Preventive Medicine*, 11, 292–297. <https://doi.org/10.1007/BF02898019>
  16. Park EJ, Kim H, Kim Y, Yi J, Choi K, & Park K. (2010). Carbon fullerenes (C60s) can induce inflammatory responses in the lung of mice. *Toxicology and Applied Pharmacology*, 244(2), 226–233. <https://doi.org/10.1016/j.taap.2009.12.036>
  17. Pinheiro FG, Moreira-Gomes MD, Machado MN, Almeida T dos S, Barboza P da PA, Silva Oliveira LF, ... Zin WA. (2021). Eugenol mitigated acute lung but not spermatotoxicity of C60 fullerene emulsion in mice. *Environmental Pollution*, 269, 116188. <https://doi.org/10.1016/j.envpol.2020.116188>
  18. Roberts JE, Wielgus AR, Boyes WK, Andley U, Chignell CF. (2008). Phototoxicity and cytotoxicity of fullerol in human lens epithelial cells. *Toxicol Appl Pharmacol*; 228: 49–58. <https://doi.org/10.1016/j.taap.2007.12.010>
  19. Rodríguez-Zavala JG, Guirado-López R.A. (2006). Stability of Highly OH-Covered C60 Fullerenes: Role of Coadsorbed O Impurities and of the Charge State of the Cage in the Formation of Carbon-Opened Structures. *J. Phys. Chem. A*, 110, 30, 9459–9468. <https://doi.org/10.1021/jp061855m>
  20. Rouse JG, Yang JZ, Ryman-Rasmussen JP, Barron AR, Monteiro-Riviere NA. (2007). Effects of mechanical flexion on the penetration of fullerene amino acid-derivatized peptide nanoparticles through skin. *Nano Lett*; 7: 155–160. <https://doi.org/10.1021/nl062464m>
  21. Roursgaard M, Poulsen SS, Kepley CL, Hammer M, Nielsen GD, and Larsen ST. (2008). Polyhydroxylated C60 fullerene (fullerenol) attenuates neutrophilic lung inflammation in mice. *Basic Clin. Pharmacol. Toxicol.* 103, 386–388. <https://doi.org/10.1111/j.1742-7843.2008.00315.x>
  22. Saathoff J.G., Inman A.O., Xia X.R., Riviere J.E., Monteiro-Riviere N.A. (2011). *In vitro* toxicity assessment of three hydroxylated fullerenes in human skin cells. *Toxicology in Vitro*; 25(8) 2105–2112. <https://doi.org/10.1016/j.tiv.2011.09.013>
  23. Sayes CM, Gobin AM, Ausman KD, Mendez J, West JL, and Colvin VL. (2005). Nano-C60 cytotoxicity is due to lipid peroxidation. *Biomaterials* 26, 7587–7595. <https://doi.org/10.1016/j.biomaterials.2005.05.027>
  24. Sayers BC, Germolec DR, Walker NJ, Shipkowski KA, Stout MD, Cesta MF, ... Smith MJ. (2016). Respiratory toxicity and immunotoxicity evaluations of microparticle and nanoparticle C60 fullerene aggregates in mice and rats following nose-only inhalation for 13 weeks. *Nanotoxicology*, 10(10), 1458–1468 <https://doi.org/10.1080/17435390.2016.1235737>
  25. Savinova, E.A.; Salimova, T.A.; Proskurnina, E.V.; Rodionov, I.V.; Kraevaya, O.A.; Troshin, P.A.; Kameneva, L.V.; Malinovskaya, E.M.; Dolgikh, O.A.; Veiko, N.N.; *et al.* (2023). Effect of Water-Soluble Chlorine-Containing Buckminsterfullerene Derivative on the Metabolism of Reactive Oxygen Species in Human Embryonic Lung Fibroblasts. *Oxygen*, 3, 1–19. <https://doi.org/10.3390/oxygen3010001>
  26. Sharoyko VV *et al.* (2021) *In Vitro* and *In Silico* Investigation of Water-Soluble Fullerenol C60(OH)24: Bioactivity and Biocompatibility. *J. Phys. Chem. B.*, 125, 9197–9212. <https://doi.org/10.1021/acs.jpcc.1c03332>
  27. Snyder RW, Fennell TR, Wingard CJ, Mortensen NP, Holland NA, Shannahan JH, Pathmasiri W, Lewin AH, Sumnera SCJ (2015) Distribution and Biomarker of Carbon-14 Labeled Fullerene C60([<sup>14</sup>C(U)]C60) in Pregnant and Lactating Rats and their Offspring after Maternal Intravenous Exposure. *J Appl Toxicol.*; 35(12): 1438–1451. <https://doi.org/10.1002/jat.3177>
  28. Sumner SC, Fennell TR, Snyder RW, Taylor GF, Lewin AH (2010). Distribution of carbon-14 labeled C60 ([<sup>14</sup>C]C60) in the pregnant and in the lactating dam and the

- effect of C60 exposure on the biochemical profile of urine, *J Appl Toxicol* May;30(4):354-60. <https://doi.org/10.1002/jat.1503>
29. Totsuka Y *et al.* (2009). Genotoxicity of nano/microparticles in *in vitro* micronuclei, *in vivo* comet and mutation assay systems. *Part Fibre Toxicol* 2009; 6:23. <https://doi.org/10.1186/1743-8977-6-23>
  30. Tsuchiya T., Oguri I., Yamakoshi Y.N., Miyata N.(1996). Novel harmful effects of [60]fullerene on mouse embryos *in vitro* and *in vivo*. *FEBS Lett* 9;393(1):139-45. [https://doi.org/10.1016/0014-5793\(96\)00812-5](https://doi.org/10.1016/0014-5793(96)00812-5)
  31. Vesterdal LK, Danielsen PH, Folkmann JK, Jespersen LF, Aguilar-Pelaez K, Roursgaard M, ... Møller P. (2014). Accumulation of lipids and oxidatively damaged DNA in hepatocytes exposed to particles. *Toxicology and Applied Pharmacology*, 274(2), 350–360. <https://doi.org/10.1016/j.taap.2013.10.001>
  32. Wielgus AR, Baozhong Z, Chignell CF, Hu DN, Roberts JE (2010). Phototoxicity and cytotoxicity of fullerol in human retinal pigment epithelial cells. *Toxicology and Applied Pharmacology*; 242: 79-90. <https://doi.org/10.1016/j.taap.2009.09.021>
  33. Xia X.R., Monteiro-Riviere N.A., Riviere J.E. (2010). Skin penetration and kinetics of pristine fullerenes (C60) topically exposed in industrial organic solvents, *Toxicol. Appl. Pharmacol.*; 242(1):29-37.
  34. Xing G, Zhang J, Zhao y, Tang J, Zhang B, Gao X, Yuan H, Qu L, Cao W, Chai Z, Ibrahim K, Su R (2006). Influences of Structural Properties on Stability of Fullerenols, *J. Phys. Chem. A* 2006, 110, 9459-9468.
  35. Xu JY, *et al.* (2009). Pulmonary responses to polyhydroxylated fullerenols, C60 (OH)<sub>x</sub>, *J. Appl. Toxicol.* 29 (7), 578–584. <https://doi.org/10.1002/jat.1442>
  36. Zhang B., Cho M., Fortner JD, Lee J, Huang CH, Hughes JB, Kim JH (2009). Delineating Oxidative Processes of Aqueous C60 Preparations: Role of THF Peroxide, *Environ. Sci. Technol.*, 43, 1, 108–113. <https://doi.org/10.1021/es8019066>
  37. Zhao B, He YY, Bilski PJ, Chignell CF. (2008). Pristine (C60) and hydroxylated [C60(OH)<sub>24</sub>] fullerene phototoxicity towards HaCaT keratinocytes: type I vs type II mechanisms. *Chem. Res. Toxicol.*; 21(5): 1056-1063  
<https://doi.org/10.1021/tx800056w>