



**HAL**  
open science

## **Estimation of relative magnetostriction and Maxwell's forces in stacked grain oriented steel structures**

Remi Penin, Jean-Philippe Lecointe, Guillaume Parent, Jean-Francois Brudny,  
Thierry Belgrand

### ► **To cite this version:**

Remi Penin, Jean-Philippe Lecointe, Guillaume Parent, Jean-Francois Brudny, Thierry Belgrand. Estimation of relative magnetostriction and Maxwell's forces in stacked grain oriented steel structures. XX International Conference on Electrical Machines (ICEM), Sep 2012, Marseille, France. pp.1971-1976, <10.1109/ICEL-Mach.2012.6350151>. <hal-04260725>

**HAL Id: hal-04260725**

**<https://hal.science/hal-04260725v1>**

Submitted on 26 Oct 2023

**HAL** is a multi-disciplinary open access archive for the deposit and dissemination of scientific research documents, whether they are published or not. The documents may come from teaching and research institutions in France or abroad, or from public or private research centers.

L'archive ouverte pluridisciplinaire **HAL**, est destinée au dépôt et à la diffusion de documents scientifiques de niveau recherche, publiés ou non, émanant des établissements d'enseignement et de recherche français ou étrangers, des laboratoires publics ou privés.



HAL Authorization

# Estimation of relative Magnetostriction and Maxwell's forces in stacked Grain Oriented steel structures

R. Penin, J-Ph. Lecoite, G. Parent, J-F.Brudny, T. Belgrand

**Abstract** –Vibrations and noise in transformers core have two main origins: the Maxwell's forces, located in the corners, and the magnetostriction inside magnetic steel. In this paper, these two phenomena are differentiated and analyzed and analyzed using a test bench, which allows comparing the vibrations of two different annular structures. In the first case only the magnetostriction occurs, whereas the second case is submitted to both the magnetostriction and the Maxwell's forces.

**Index Terms**— Magnetic anisotropy, magnetic flux density, magnetic forces, magnetostriction, soft magnetic materials, vibrations.

## I. INTRODUCTION

Acoustic noise emitted by transformers results from many contributions. Indeed the inside core and the electrical steels composing the latter are sources of high concern for the steel producer and the transformer manufacturer [1]. Two main components can be suspected as the problem for noise in such structures: the Maxwell's forces due to development of attractive and repulsive effects between laminations [2] and the magnetostriction due to the proper behaviour of the electrical steel [3]-[4]. So far, it has been a challenge to separate the influence of these two factors and to weight their respective contribution when Grain Oriented (GO) steel is used to build the magnetic circuit.

The corner joints of transformers stand for the areas where these two phenomena are particularly engaged. They correspond to a situation of changing in plane and out of the plane directions for the magnetic field combined to a superposition of mixed easy magnetization directions of the steel. To investigate that very question of separating the aforementioned contributions, simplified magnetic structures build on the basis of stacked GO electrical steel rings have been studied.

The first part of the paper presents the phenomenon of magnetostriction and the forces arising between the sheets. The second part describes the test bench. The results are presented and discussed in the third part. Hence, hints are given for understanding the noise generation at the transformer corner joints.

---

This work is supported by MEDEE program supervised by the French national technological research cluster on electrical machine efficiency increase. This program, including ThyssenKrupp Electrical Steel, is sponsored by the region Nord Pas-de-Calais (France), the French ministry and the European funds (FEDER).

R. Penin is with Uartois, LSEE, F-62400 Béthune, France (remi\_penin@ens.univ-artois.fr).

J-Ph. Lecoite is with Uartois, LSEE, F-62400 Béthune, France

G.Parent is with Uartois, LSEE, F-62400 Béthune, France

J-F.Brudny is with Uartois, LSEE, F-62400Béthune, France

T. Belgrand is with ThyssenKrupp Electrical Steel (TKES), F-62330 Isbergues, France

## II. MAGNETOSTRICTION AND MAXWELL'S FORCES

The Maxwell's forces are generated by the presence of magnetic flux across the air gap between the magnetic steel laminations. It is particularly the case in the transformer corners because in this area, the magnetic field has to change direction and, due to the high anisotropy of GO electrical steel, and so has to cross the air gaps existing between the latter, creating magnetic discontinuities. Indeed, the field can remain in the same plane or pass from one layer to another depending on permeability situation [5]. Moreover two potential sources for Maxwell forces exist: in plane (Fig. 1b way 1) due to the distributed air gap of the step lap arrangement (Fig. 1a) and out of the plane (Fig. 1b way 2) due to the air gap brought by the insulation layer intrinsic to the steel. The present study, according to the used specific devices, focuses on the second case.

The  $p$  pressure corresponding to the Maxwell's forces interacting between two successive laminations can be expressed as follows:

$$p = \frac{B_e^2}{2\mu_0} \quad (1)$$

where  $B_e$  is the air gap magnetic flux density and  $\mu_0 = 4\pi 10^{-7}$  H/m is the vacuum permeability. Expression (1) shows that  $p$  components contain a prevailing term of fundamental frequency twice the value of the excitation one. This study will be focused on vibrations induced by this component, the corresponding induced external displacements being tied to the mechanical response of the structure.

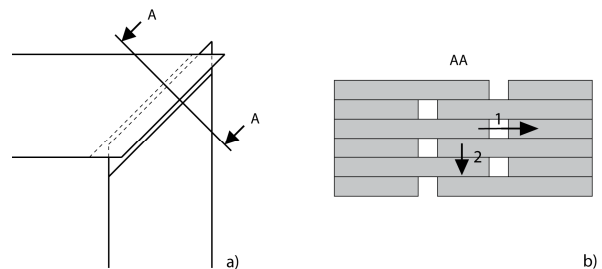

Fig.1:Joint region in conventional single step lap assembling

The Magnetostriction appears during the magnetization of the electrical steel. It takes place when the domains have to rotate to align along the direction of the magnetic field. This is particularly the case at the transformer joint where the magnetic field concentrates at the inner part of the corners and makes its magnitude high enough to move locally the domains. This applies for the original 180° domain walls and

also to all the other  $90^\circ$  domain walls [6].

Magnetostriction is generally expressed as a relative deformation  $\frac{\Delta l}{l}$  which depends on the magnetostriction coefficients  $\lambda_{100}$  and  $\lambda_{111}$ , respectively  $2 \times 10^{-5}$  and  $-5 \times 10^{-6}$  for the case of the GO structure; where  $l$  is the material length and  $\Delta l$  is the change in length.

Let us denote  $\alpha$  the anisotropic angle of applied field which respect to the Rolling Direction (RD) which will be marked with a bold arrow in the figures. For  $\alpha$  from  $0^\circ$  to  $55^\circ$ , the magnetostriction is negative, and so the sheet is contracting. On the other hand, for  $\alpha$  from  $55^\circ$  to  $90^\circ$ , the magnetostriction is positive and so the sheet is stretching. This specificity can be easily visualized thanks to the so-called “butterfly loop” graphs [7]. Fig.2 shows the link between the magnitude of the relative deformations of a sheet due to the magnetostriction depending on  $\alpha$ . The displacements in the RD have amplitude higher than those in the Transverse Direction (TD) and no deformation around  $55^\circ$ . Since magnetostriction is at constant volume, the deformation in the outer plane direction is a consequence of the in-plane ones; that means that the lamination presents a deformation according to its thickness [8].

Like Maxwell’s forces, prevailing vibration due to magnetostriction presents a fundamental frequency twice the excitation one.

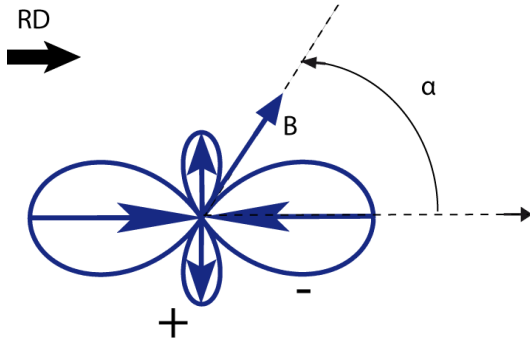

Fig 2: GO steel sheet variation of the relative elongation/compression

### III. TEST BENCH

#### A. Ring structure

The experimental device presented in this paper deals with stacks of rings built with GO electrical steel. Each ring of the stack is shifted from the previous one by a constant  $\beta$  angle (Fig. 3). This structure is able to give an image of the magnetic behavior of a transformer corner joint when the Maxwell’s forces in plane are assumed to be nul. Axial (along  $z$ ) and radial (along  $y$ ) vibrations are analysed in this study considering  $\beta = 0^\circ$  and  $\beta = 90^\circ$ .

##### Case of axial vibrations:

•For  $\beta = 0^\circ$ , there is no reason for the field to move from one layer to another since all rings are stacked with their RD parallel. In that way no Maxwell’s force takes place and the only possible deformations may be related to magnetostriction.

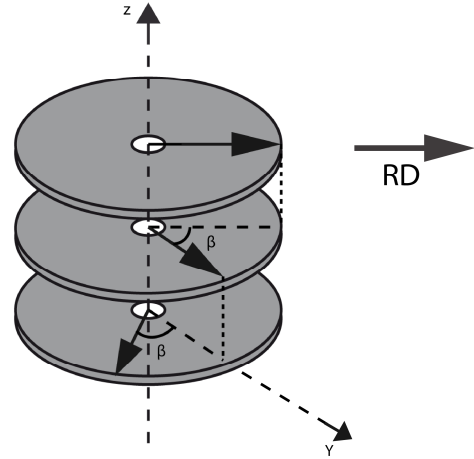

Fig 3: Stack of shifted rings

•For  $\beta = 90^\circ$  between successive layers, deformations will result from a mix of Maxwell’s forces and magnetostriction. Maxwell’s forces are here supposed to be at their maximum.

##### Case of radial vibrations:

• Radial vibrations are caused, whatever the shift, only by the magnetostrictive effect.

#### B. Test bench presentation

The experimental device has been designed to maximize the reliability of the measurements (Fig. 4). The two stack configurations are mounted inside the same frame structure. The stacks can be rotated around the stacking direction axis. Each stack is made of 174 GO “Power Core C” electrical steel sheets of 0,35mm nominal thickness. Insulation between sheets is around  $10\mu\text{m}$ . The sheets are clamped between two non magnetic Bakelite A and B plates and maintained with threaded rods. The tightening torque applied on the nuts can be controlled with a torque wrench.

Holes have been disposed through the bakelite plates for sensor access in order to record the axial deformations of the stacks (Fig.4).The measurements points  $A_1$  to  $A_4$  and  $B_1$  to  $B_4$  are presented in Fig. 5a (holes face to face are numbered in the same way).

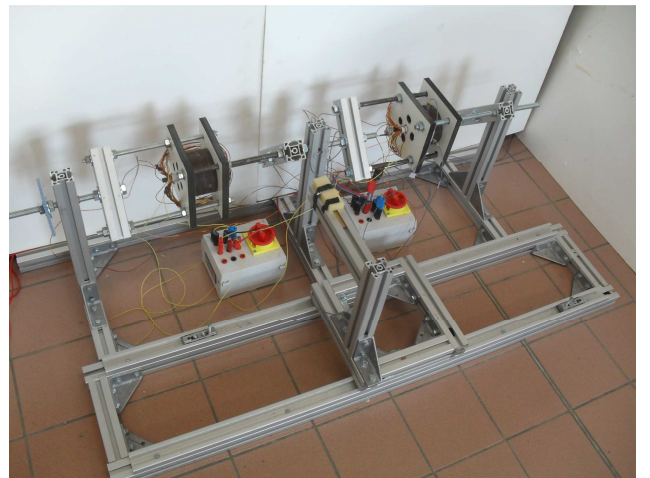

Fig 4: Vibration analysis system stacks

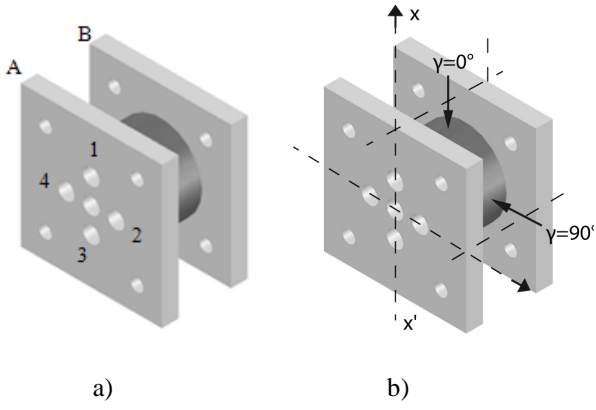

Fig 5: Axial and Radial measuring points

The spatial reference for the radial measurements is the RD of the first sheet of the stacks (against the plate A), which is aligned along the  $x'x$  axis of the 1 and 3 holes (Fig.5b).

The radial measured point is located with the  $\gamma$  angle with respect to this reference.

So for the non-shifted structure,  $\gamma=0^\circ$  is in all RD of sheet's stack. For shifted structure,  $\gamma=90^\circ$  correspond of both RD of odd sheets and TD of pair sheets. The excitation is provided by a primary 28 turns winding, and a 10 turns secondary winding allows measuring the average flux density in the core. Those windings are distributed on one half of the structure only (Fig. 4) in order to apply measuring devices. The primary winding is supplied with a 50Hz sinusoidal voltage provided by an auto-transformer. Hence, the devices are submitted to a unidirectional field.

Finally, the  $B$  peak flux density in the core is computed from the secondary voltage through the following formula:

$$B = \frac{V_2 \sqrt{2}}{n_2 \omega S} \quad (2)$$

where  $V_2$  is the sinusoidal secondary rms voltage of  $\omega$  angular frequency (frequency  $f$ ),  $n_2$  is the secondary winding turn number and  $S$  is the stack cross section.

The measurements have been made under  $B$  values of 0.7T, 1.1T and 1.5T.

A Bruël and Kjaer PULSE data acquisition system is used in association with mono-axial accelerometers for measuring the vibrations.

#### IV. EXPERIMENTAL RESULTS

##### A. Measurements of axial vibrations

The accelerations of the deformations are presented in Fig. 6 for the 100 Hz frequency component only for points A1 to A4 of the non-shifted structure with  $B$  value of 1.1T. Theoretically, for both configurations, according to symmetries, points A1 and A3 should present the same vibrations. The same remark can also be done for points A2 and A4. But, differences between these points are measured; this comes from the uncertainty of the placement of accelerometers. To reduce this, an averaging measured values on points 1 and 3 as well as on points 2 and 4 was made for plates A and B. Fig. 7 shows this averaging for

both configurations ( $\beta=0^\circ$  and  $\beta=90^\circ$ ) denoting, for example,  $A_1$ - $A_3$  the averaging concerning measurements realized on  $A_1$  and  $A_3$ .

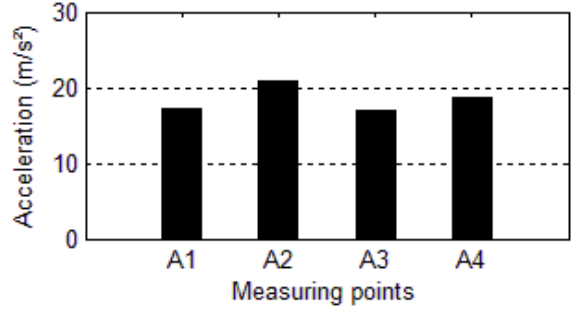
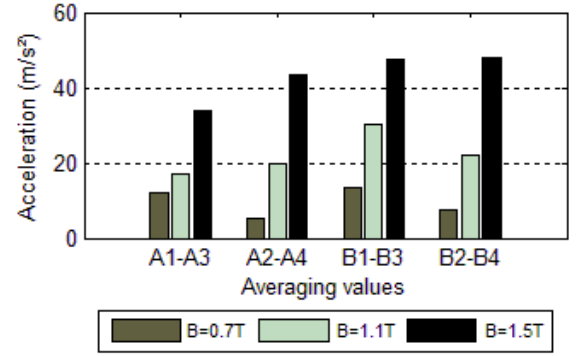
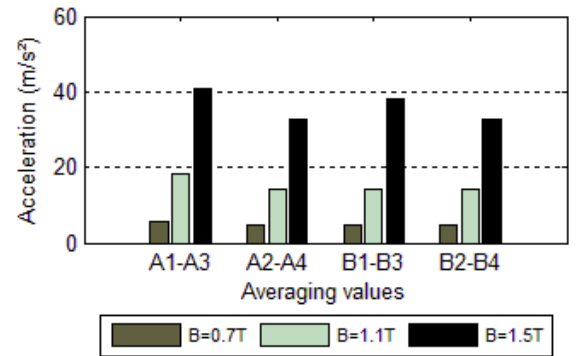

Fig 6 : Axial vibrations for plate A ( $B = 1.1T$ )



a)  $\beta = 0^\circ$



b)  $\beta = 90^\circ$

Fig 7 : Axial vibrations

It appears that the non-shifted structure ( $\beta=0^\circ$ ) presents higher vibration levels than the shifted one apart from  $A_1$ - $A_3$  for 1.1T and 1.5T. The higher vibration level for  $\beta=0^\circ$  explanation can be as follow:

- The Maxwell's forces arising in the case of the shifted configuration induce a contraction of the interlaminar air gaps which limits the mechanical displacements [9].
- The flux density inside the shifted stack is spread in a more homogeneous way, magnetostriction is though weaker compared to the non shifted configuration. On the other hand, this homogeneity leads to more regular mechanical deformations as it appears in Fig.7b.
- Both phenomena (magnetostriction and Maxwell's forces) can compensate each other at a given frequency, and then

can explain the observed vibration differences.

It is interesting to note that, for  $B = 0.7T$ , the non-shifted structure has the more important vibrations for averagings  $A_1-A_3$  and  $B_1-B3$ . Indeed, these points correspond where the flux is in the TD of the sheet. Hence, the magnetostrictive effect is the highest. For the shifted structure these vibrations are the same for all averagings.

**B. Radial vibration measurements**

For those measurements, the accelerometers measuring devices are located on the edges of the stacks for both  $\gamma = 0^\circ$  and  $\gamma = 90^\circ$  (Fig.5b). The results are presented in Fig. 8 for the 100Hz frequency component and for both  $\beta = 0^\circ$  and  $\beta = 90^\circ$ .

Whatever the value of the  $\beta$  angle is, the radial vibrations are always due to magnetostriction. For the non-shifted setup, the vibration occurring along the RD is bigger than the one across the TD. This is in accordance with the “butterfly” loops previously mentioned. Moreover, the shifted setup pretty much identical vibrations for both  $\gamma = 0^\circ$  and  $\gamma = 90^\circ$ .

Fig. 8 also highlights noteworthy acceleration amplitude differences. Indeed, for a B value of 0.7T and for both  $\gamma = 0^\circ$  and  $\gamma = 90^\circ$ , the shifted setup shows respectively amplitudes that are 27 and 8.3 as weak as in the non-shifted one. Nevertheless, the ratio decreases while B value increases: 6.6 and 2.2 for 1.1T and 3 and 0.95 for 1.5T.

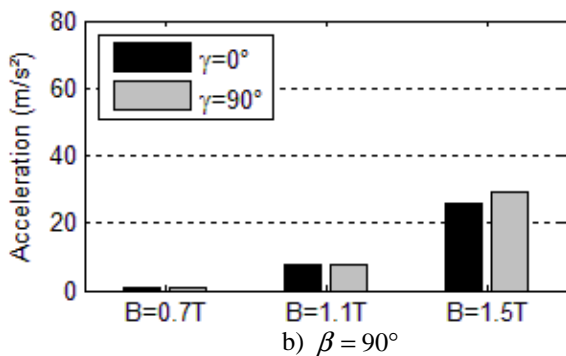
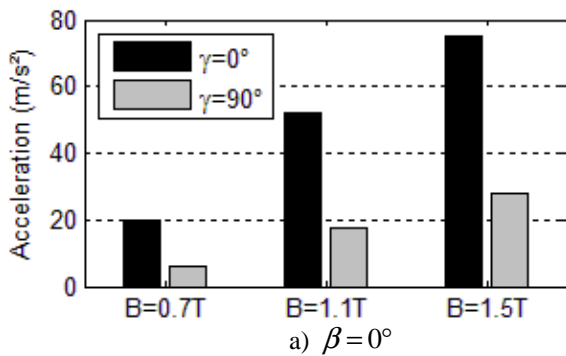

Fig8 : Radial vibrations

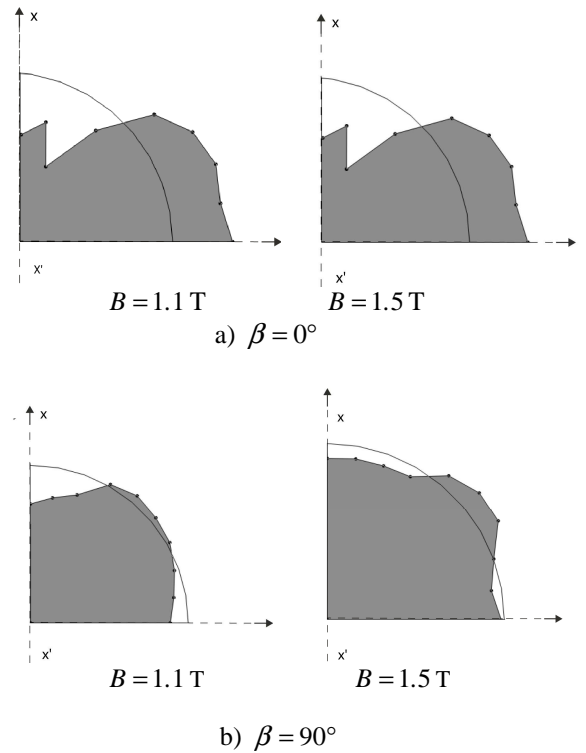
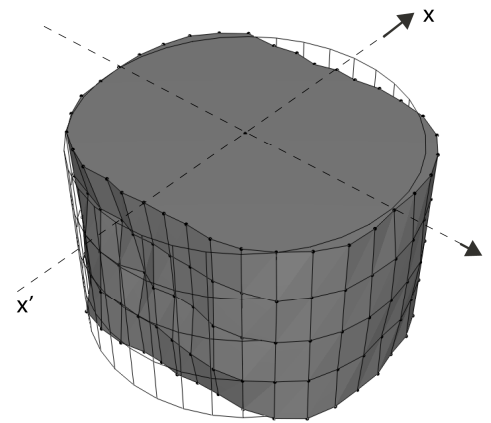
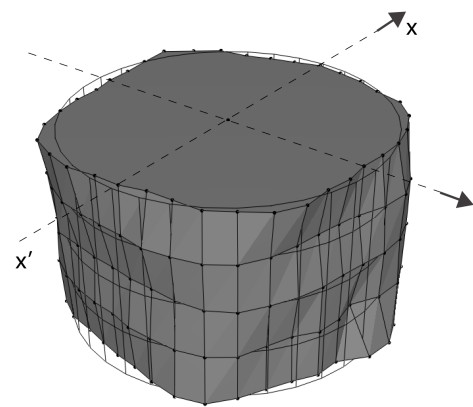

Fig 9: Radial vibrations (quarter of structure)



a)  $\beta = 0^\circ$



b)  $\beta = 90^\circ$

Fig 10 : Radial vibrations for  $B = 1.5T$

The vibration reaction of the whole structure has also been investigated. For this, an “Operating Deflection Shape” has been performed on one fourth of both stacks for 1.1T and 1.5T. For 0.7T, the vibrations were too weak to be efficiently analyzed. The results are presented in Fig.9a ( $\beta=0^\circ$ ) and Fig.9b ( $\beta=90^\circ$ ) Fig.10a and Fig.10b show the 3D acceleration of the wholes structures for 1.5T respectively for  $\beta=0^\circ$  and  $90^\circ$ . They put in evidence the reaction differences between the two configurations. The non-shifted stack presents counter-phased vibrations between the RD and TD. This is the usual vibration reaction of GO steels. On the other hand, the shifted stack presents in-phase vibrations between the RD and TD. Moreover, the vibrations for  $\gamma=45^\circ$  are counter-phased.

The phase reference is set for  $\gamma=0^\circ$  and the measured values corresponding to A1, B1, and  $\gamma=90^\circ$ , are presented in Fig.11. As previously mentioned, it can be noted that the axial and radial vibrations are in phase on both setups.

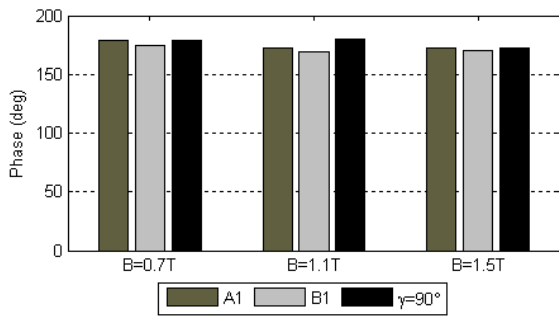

a)  $\beta=0^\circ$

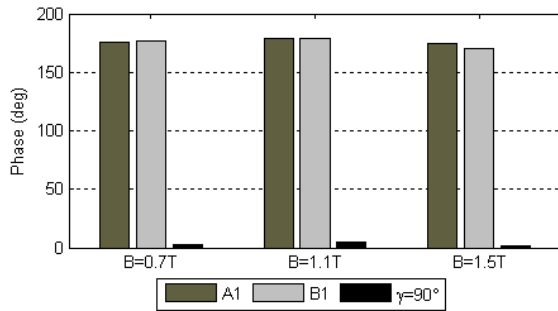

b)  $\beta=90^\circ$

Fig11 : Phases

### C. Radial deformations

In the previous measures, only the accelerations have been presented. In this part, the deformations of the stacks are considered. In order to determine their nature, which means contraction or extension, the acceleration and the secondary voltage are used.

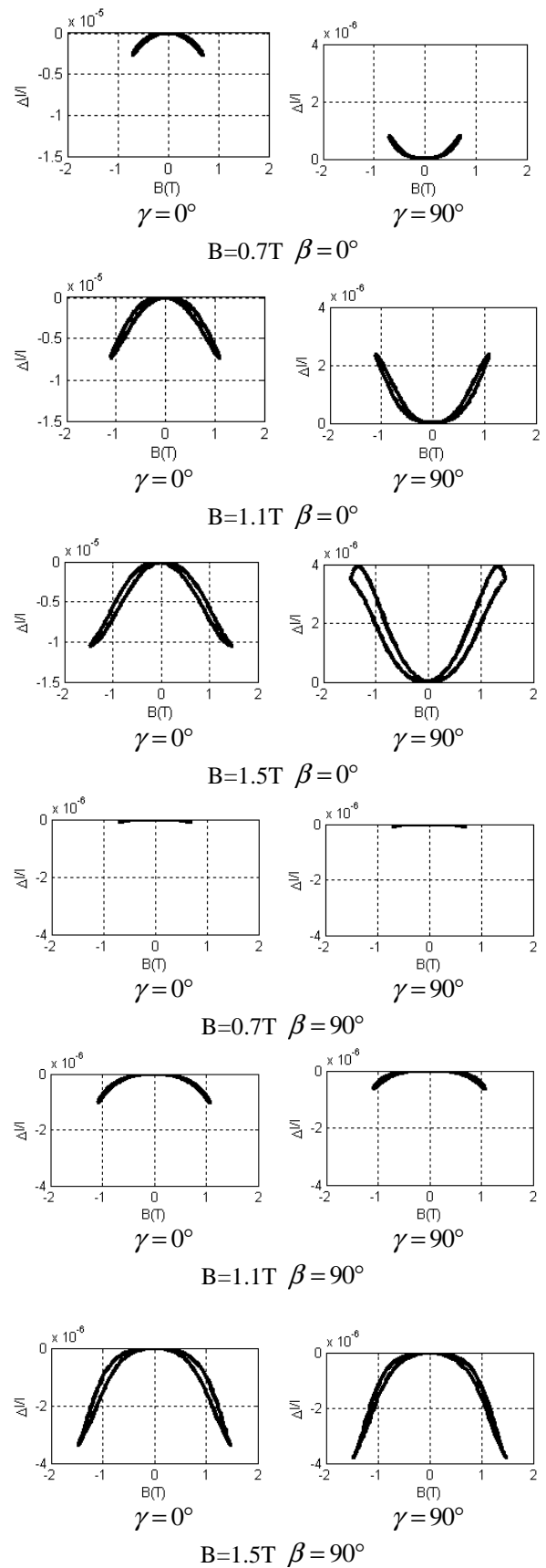

Fig 12 : Radial displacements along  $\gamma=0^\circ$  and  $\gamma=90^\circ$

The wave forms of the flux density and deformations have been evaluated from formula 3 and 4 respectively.

$$B(t) = \frac{1}{n_2 S} \int v_2(t) dt \quad (3)$$

$$\Delta l(t) = \int \int a(t) dt^2 \quad (4)$$

where  $a$  is the acceleration in  $m/s^2$ . For this evaluation, the integration constant is  $\Delta l(t_0) = 0$  at  $B(t_0) = 0$  T.

The magnetostriction effect value with respect to the B is presented in Fig. 12 for  $\gamma = 0^\circ$  and  $90^\circ$ . The non-shifted setup presents a contraction along the RD and an elongation across the TD. This is the case for all the considered B values. For  $\gamma = 0^\circ$ , the maximal displacement values of the shifted configuration are 26 (0.7T), 7 (1.1T), and 3 (1.5T) times lower than with the non shifted setup. For  $\gamma = 90^\circ$ , the nature of the displacement has changed: an elongation for the shifted setup and a contraction for the non-shifted device. The amplitude of the displacements are lowered with the shifting. This is the case of the step lap transformer joint, where the GO lamination RD are crossed.

## V. CONCLUSION

The measurement results presented in this paper provide interesting informations about magnetostriction and Maxwell's forces effects. Although, in this study, the in plane Maxwell's forces at the corner joints of the step lap have not been modelled, it seems to give some hints towards explanation for vibration mechanisms inside transformer core, particularly at the joints. Two important results can be extracted from this analysis:

- The first one is that, in this case, both Maxwell's forces and magnetostriction effects are, concerning vibrations, of same order of magnitude.
- The second one is that a  $\beta = 90^\circ$  shifting of the sheets leads to decrease axial and radial vibrations and so on, the generated noise.

The obtained results seem to be interesting and they raise numerous questions, which will be answered in the future. For example, the study of the Maxwell's forces in plane with proper magnetic circuit. Additional tests will be also performed using a symmetric current excitation instead of a voltage one. Moreover, Finite Element simulations will give information about the flux distribution in the stack in order to propose theoretical statements about the vibration mechanism.

## VI. ACKNOWLEDGMENT

This work is supported by MEDEE program supervised by the French national technological research cluster on electrical machine efficiency increase. This program, including ThyssenKrupp Electrical Steel, is sponsored by the region Nord Pas-de-Calais (France), the French ministry and the European funds (FEDER).

## VII. REFERENCES

- [1] K. Majer, "The analysis of the vibrations of the cores of model transformers," Book of digests, ISEF 09, ARRAS (France), pp.587-588, 2009.
- [2] B. Weiser, A. Hasenzagl, T. Booth, and H.Pfutzner, "Mechanisms of noise generation of model transformer cores," Journal of Magnetism and Magnetic Materials, 160(1996), 207-209.
- [3] A. Moses, "Measurement of magnetostriction and vibration with regard to transformer noise," Magnetics, *IEEE Trans. on Magnetics*, vol.10, no.2, pp. 154- 156, Jun 1974.
- [4] W. Kubiak, P Witczak, "Vibration analysis of small power transformer," Book of digests, ISEF 09, ARRAS (France), pp.581-582, 2009.
- [5] B. Weiser, H. Pfutzner, and J. Anger, "Relevance of magnetostriction and forces for the generation of audible noise of transformer cores," *IEEE Trans. On Magnetics*, vol.36, no.5, pp.3759-3777, Sep 2000
- [6] S. Arai, M. Mizokami, and M. Yabumoto, "Magnetostriction of grain oriented Si-Fe and its domain model," *Przeglad elektrotechniczny*, ISSN 0033-2097, R. 87 No 9b/2011.
- [7] H. Yamaguchi, H. Pfutzner, and A. Hasenzagl "Magnetostriction measurement on the multidimensional magnetization performance of SiFe steel," *J.Magn. Magn. Matr.*, 320 (2008), 618-622.
- [8] D. Wakabayashi, T. Todaka, Takashi, and M. Enokizono, "Measurement of Three-Dimensional Magnetostriction on Grain-Oriented Electrical Steel Sheet", *Journal of Electrical Engineering*, Vol.62, Iss.3, pp.153, 2011
- [9] C. Demian, B. Cassoret, J.F. Brudny, T. Belgrand."AC magnetic circuits using non segmented shifted grain oriented electrical steel sheets: impact on induction machine magnetic noise". *IEEE Trans. on Magnetics*, Vol. 48, N°4, published in April 2012

## VIII. BIOGRAPHIES

**Rémi Penin** was born in Armentières (France), in 1986. He received master degree in 2009 from University of Artois (France). He is now Ph.D. student at the University of Artois (LSEE). His research interest is the core losses and the vibrations in transformers.

**Jean-Philippe Lecoite**, DSc, received the MSc degree in Electrical Engineering from the Université des Sciences et Technologies de Lille, France, in 2000. He received the PhD degree from the Université d'Artois, France, in 2003. He is currently Associate Professor at the Artois University and he joined the institute LSEE (Electrical Systems and Environment Research Laboratory), France. His research interests focus on electromagnetic design, efficiency, noise and vibrations of electrical machines

**Guillaume Parent** was born in Strasbourg, France. He received the Ph.D. degree in electrical engineering jointly from the University of Lille, Lille, France, and the University of Liège, Liège, Belgium, in 2008. He is currently an Associate Professor of electrical engineering at the Artois University, Béthune. His main research interests include electromagnetic analysis with the Finite-element method and noise analysis in electromagnetic systems and vibrations.

**Jean-François Brudny** (M'92-SM'04) received the Ph.D. and the D.Sc. degrees from Lille University, Lille, France, in 1984 and 1991, respectively. Since 1992, he has been with the Université d'Artois, Béthune, France, where he was a Full Professor and is currently the Head of the Laboratoire Systèmes Electrotechniques et Environnement (EA 4025). His research interests include noise and vibrations of electromechanical systems and new designs for efficiency increase of ac rotating electrical machines.

**Thierry Belgrand** is head of R&D of TKES UGO