



HAL
open science

Luminescence and mechanoluminescence of $\text{Ba}_4\text{Si}_6\text{O}_{16}:\text{Eu}^{2+}$, RE phosphors

Alexis Duval, Yan Suffren, Mourad Benabdesselam, Patrick Houizot, Tanguy Rouxel

► **To cite this version:**

Alexis Duval, Yan Suffren, Mourad Benabdesselam, Patrick Houizot, Tanguy Rouxel. Luminescence and mechanoluminescence of $\text{Ba}_4\text{Si}_6\text{O}_{16}:\text{Eu}^{2+}$, RE phosphors. *Journal of Chemical Physics*, 2023, 159 (13), pp.134501. 10.1063/5.0167222 . hal-04258645

HAL Id: hal-04258645

<https://hal.science/hal-04258645>

Submitted on 11 Dec 2023

HAL is a multi-disciplinary open access archive for the deposit and dissemination of scientific research documents, whether they are published or not. The documents may come from teaching and research institutions in France or abroad, or from public or private research centers.

L'archive ouverte pluridisciplinaire **HAL**, est destinée au dépôt et à la diffusion de documents scientifiques de niveau recherche, publiés ou non, émanant des établissements d'enseignement et de recherche français ou étrangers, des laboratoires publics ou privés.

Luminescence and mechanoluminescence of

$\text{Ba}_4\text{Si}_6\text{O}_{16}:\text{Eu}^{2+}$, *RE* phosphors

Alexis Duval^{1,a)}, Yan Suffren², Mourad Benabdesselam³, Patrick Houizot¹ and Tanguy Rouxel^{1,4}

AFFILIATIONS

¹Glass Mechanics Lab., IPR (Institut de Physique de Rennes), UMR 6251, University of Rennes, Campus de Beaulieu, Rennes, France.

²INSA Rennes, CNRS, ISCR (Institut des Sciences Chimiques de Rennes), UMR 6226, University of Rennes, Campus de Beaulieu, Rennes, France.

³INPHYNI (Institut de Physique de Nice), UMR 7010, Côte d'Azur University, Nice, France.

⁴Institut Universitaire de France, Paris, France.

^{a)}Author to whom correspondence should be addressed: alexis.duval@univ-rennes.fr

ABSTRACT

The luminescence properties of green $\text{Ba}_4\text{Si}_6\text{O}_{16}:\text{Eu}^{2+}$, *RE* (*RE* = Sc, Y, La-Lu except Pm) phosphors are reported. Their long-lasting phosphorescence is discussed in view of trap depths and concentrations determined from thermally stimulated luminescence experiments. A second emission band centered at 439 nm was evidenced at low temperatures, which stems from the substitution of Eu^{2+} in the two non-equivalent Ba^{2+} sites of $\text{Ba}_4\text{Si}_6\text{O}_{16}$. The mechanoluminescence properties of $\text{Ba}_4\text{Si}_6\text{O}_{16}:\text{Eu}^{2+}$, *RE* phosphors are described, and a new mechanoluminescence mechanism is proposed, in the case where *RE* = Ho^{3+} involving a trap

22 distribution from 0.694 to 0.924 eV. Mechanical loading (post UV irradiation) induces a
23 decrease in depth of the trap distribution leading to an increase of the luminescence intensity,
24 whereas a drop of the luminescence intensity is observed upon unloading, following the faster
25 release of the charge carriers.

26 1. INTRODUCTION

27 The luminescence properties of oxides, oxynitrides and nitrides from the BaO-SiO₂-Si₃N₄
28 system were reported in the past few years, such as BaSi₂O₅:Eu²⁺ ^{1 2} (λ_{em} = 500-505 nm),
29 Ba₃Si₅O_{13- δ} N _{δ} :Eu²⁺ ³ (broad emission bands from 400 to 620 nm), Ba₅Si₈O₂₁:Eu²⁺ ^{4 5 6}
30 (λ_{em} = 473-480 nm), Ba₄Si₆O₁₆:Eu²⁺ ^{7 8 9 10} (λ_{em} = 496-515 nm), β -BaSiO₃:Eu²⁺ ^{6 11}
31 (λ_{em} = 560-565 nm), Ba₂SiO₄:Eu²⁺ ^{12 13 14 15} (λ_{em} = 503-510 nm), Ba₃SiO₅:Eu²⁺ ^{6 16 17 18 19}
32 (λ_{em} = 585-596 nm), BaSi₂O₂N₂:Eu²⁺ ^{20 21 22} (λ_{em} = 498-500 nm) or Ba₂Si₅N₈:Eu²⁺ ²³
33 (λ_{em} = 585 nm). This chemical system offers a broad range of emission colors, ranging from
34 blue to orange.

35 The luminescence properties of Ba₄Si₆O₁₆:Eu²⁺ were reported as early as the 60s, but were
36 mostly studied during the last 15 years with various luminescent centers such as Eu²⁺, Pr³⁺ and
37 Ce³⁺ ^{8 24 25}. In the crystal, the rare-earths (*RE*) substitute for Ba²⁺ ions thanks to close ionic radii
38 ²⁶. Its space group is *P2₁/c* ²⁷ ($a = 12.477 \text{ \AA}$, $b = 4.685 \text{ \AA}$, $c = 13.944 \text{ \AA}$, $\beta = 93.54^\circ$, $Z = 2$),
39 which is similar to the non-standard *P2₁/a* formerly used ⁸. Ba₄Si₆O₁₆:Eu²⁺ is a potential
40 phosphor for applications in white light emitting diodes (*wLEDs*), but synthesis complications
41 including mixed phases like Ba₃Si₅O₁₃ and Ba₅Si₈O₂₁ and high sintering temperatures limit its
42 use ¹⁰.

43 Ba₄Si₆O₁₆ exhibits an intense long-lasting phosphorescence (*LLP*) as well as
44 elasto-mechanoluminescence (*EML*) ²⁸ when doped with Eu²⁺, in a similar way as BaSi₂O₂N₂.

45 Recall that elasto-mechanoluminescence is the emission of light resulting from an elastic

46 deformation. This phenomenon has recently aroused great interest, because of potential
47 applications of mechanoluminescent materials for energy storage or as stress sensors ²⁹. The
48 BaO-SiO₂ binary diagram shows a glass-forming region with a BaO content from 20 to
49 50 mol. % ³⁰, along with congruent crystallization at given BaO contents. This allowed the
50 formation of Ba₄Si₆O₁₆:Eu²⁺, Ho³⁺-containing glass-ceramics exhibiting *EML* thanks to
51 uniformly dispersed active crystals ²⁸. In our previous work (ref. ²⁸), we have reported
52 mechanoluminescence in a new glass-ceramic material mainly consisting of
53 Ba₄Si₆O₁₆:Eu²⁺, *RE* crystalline phase. In this preliminary work, we focused on the choice for
54 the *RE* co-dopant and we have reported the first mechanical testing results, which revealed
55 significant differences with the behavior of SrAl₂O₄:Eu²⁺, Dy³⁺. The present manuscript
56 provides an in-depth investigation of the role of the co-dopant in the e⁻ trapping energetics and
57 in the physics of the luminescence mechanism. *LLP* behavior as well as *EML* properties are
58 related to the characteristics of electron traps within the active crystalline phase. Trap depths
59 and concentrations were determined from thermally stimulated luminescence experiments.
60 Experiments with different loading rates and loading modes allow to propose a mechanism of
61 the *EML* phenomenon in the particular crystal.

62 2. EXPERIMENTAL

63
64 Ba₄Si₆O₁₆:Eu²⁺, *RE* crystals were synthesized starting from dried BaCO₃ (Sigma-Aldrich
65 99 %), Gd₂O₃, Lu₂O₃, Dy₂O₃, Sc₂O₃, Eu₂O₃ (Sigma-Aldrich 99.9 %), SiO₂ (Sigma-Aldrich
66 99.5 %), Pr₂O₃, Sm₂O₃ (Fischer 99.9 %), Tb₄O₇ (Fischer 99.998 %), Tm₂O₃ (Alfa Aesar
67 99.9 %), Yb₂O₃, La₂O₃, CeO₂, Nd₂O₃ (Rhône-Poulenc 99.99 %), Y₂O₃ (Acros 99.99 %), and
68 Ho₂O₃, Er₂O₃ (Rhône-Poulenc 99.999 %). Three series of Ba₄Si₆O₁₆:Eu²⁺, *RE* crystals were
69 studied, with i) a fixed cationic composition: 35 Ba – 60 Si – 3 Eu – 2 *RE* for each *RE*, ii)

70 varying $\text{Eu}^{2+}:\text{RE}$ ratio for $\text{RE} = \text{Pr}^{3+}$ or Ho^{3+} , and iii) varying $\text{Eu}^{2+}:\text{RE}$ quantity for $\text{RE} = \text{Ho}^{3+}$.
71 Stoichiometric amounts were weighted and grounded during 15 minutes in ethanol in an agate
72 mortar, and then fired 6 h at 1300 °C in an alumina crucible under a $\text{N}_2:\text{H}_2 = 94:6$ reducing
73 atmosphere. Each specimen was grounded into a fine powder.

74 The X-ray diffraction (XRD) patterns were collected using a PANalytical X'pert Pro
75 diffractometer using Cu-K α radiation (1.5418 Å).

76 Solid-state excitation and emission spectra were recorded using a Horiba Jobin-Yvon
77 Fluorolog III fluorescence spectrometer equipped with a Xe lamp operating at 450 W, a
78 UV-vis-nearIR photomultiplier (Hamamatsu R928, sensitivity 190 – 860 nm), or a
79 Horiba Jobin-Yvon FluoroMax-4 Plus fluorescence spectrometer equipped with a Xe lamp
80 operating at 150 W and a UV-vis photomultiplier (Hamamatsu R928, sensitivity
81 190 – 860 nm). The luminescence spectra were realized on powder samples placed inside the
82 solid-sample holder fixed in 30° rotation and blocked by a quartz blade.

83 Emission and excitation spectra of $\text{Ba}_4\text{Si}_6\text{O}_{16}:\text{Eu}^{2+}$, Ho^{3+} were recorded from 77 to 300 K in
84 quartz cuvettes with an optical cryostat (OptistatCF from Oxford Inst.) coupled to a liquid
85 nitrogen bath under a N_2 atmosphere, and from 300 to 380 K in a solid holder using a F-3004
86 Jobin-Yvon heating Peltier module.

87 Appropriate filters were used to remove the residual excitation laser light, the Rayleigh
88 scattered light and associated harmonics from the spectra. All spectra were corrected for the
89 instrumental response function.

90 Solid-state UV-visible absorption measurements were obtained with a PerkinElmer Lambda
91 650 spectrometer using a 60 mm integrated sphere.

92 Quantum yield measurements were recorded using a G8 GMP integrating sphere according to:
93 $\Phi = (E_c - E_a)/(L_a - L_c)$, where E_c is the integrated emission spectrum of the sample, E_a is the
94 integrated “blank” emission spectrum, L_a is the “blank” absorption, and L_c is the sample
95 absorption at the excitation wavelength. Samples were introduced in specific capillaries for a
96 G8 integrating sphere, and placed directly inside the integrating sphere.

97 Rapid luminescence decays were measured directly with the fluorescence spectrometer
98 connected to an additional time-correlated single photon counting (*TCSPC*) module and a
99 360 nm pulsed delta diode. Lifetimes and quantum yields are the averages of three independent
00 measurements.

01 Luminance, expressed in $\text{mcd}\cdot\text{m}^{-2}$, was measured on a 1.5 cm^2 sample pellet using a Konica
02 Minolta LS-150 luminancemeter with an integration time of 3 s under UV irradiation
03 ($\lambda_{exc} = 365\text{ nm}$) in a lab-made black box. The working distance between the luminancemeter
04 and the pellet surface was 45 cm. The irradiation was realized with a lab-made source
05 constituted by 1 LED CUN66B1B from Roithner at 365 nm plugged in a Keysight
06 Technologies E36104B benchtop power supply that provides the desired current (mA) and
07 voltage (V). The incident beam angle is 30° with respect to the normal of the pellet surface and
08 the distance *LED*-sample is 12 cm. In order to avoid saturation the current was fixed at 90 mA
09 and the voltage at 3.32 V, with an effective power of $0.57\text{ mW}\cdot\text{cm}^{-2}$.

10 Thermally stimulated luminescence (*TSL*) experiments were performed from 293 to 573 K with
11 a heating rate of $1\text{ K}\cdot\text{s}^{-1}$. The delay between the end of the UV illumination and reading was
12 40 s. During heating, the *TSL* signal was detected by means of a UV-visible photomultiplier
13 tube.

14 *LLP* emission spectra were collected by an optical multichannel analyzer (*OMA*), consisting of
15 a multimode optical fiber connected to an integrated spectrograph equipped with a CCD array

This is the author's final revised and accepted manuscript. However, the online version of this manuscript may differ from the printed version once it has been copyedited and typeset. PLEASE CITE THIS ARTICLE AS DOI: 10.1063/1.5016722

16 covering the range 200-1100 nm. An appropriate grating covering the 200-1100 nm range was
17 used.

18 *LLP* and *EML* experiments were performed on powder/epoxy composites, where each
19 $\text{Ba}_4\text{Si}_6\text{O}_{16}:\text{Eu}^{2+}$, *RE* crystal was mixed with an epoxy resin (obtained by mixing EPOFIX resin
20 Struers and EPOFIX hardener Struers with a 90:10 concentration by weight) with a final powder
21 content of 20 wt. %. Mechanical tests were carried out on disks using a Shimadzu-AGS-X
22 testing machine with a 10 kN load cell and a SiC pusher. The stress σ induced at the center of
23 a disk made in the composite material (epoxy + ceramic powder) during the diametral
24 compression test is expressed as $\sigma = \frac{2P}{\pi dh}$, where P is the load, d the diameter (11.5 mm) and h
25 the height (6 mm) of the disk ³¹. The *LLP* intensity and the *EML* intensity were quantified
26 consistently using a Zyla 5.5 sCMOS Andor Technology high sensitivity camera, by irradiating
27 each sample for 2 minutes using a 365 nm handheld UV light with an effective power of
28 1.22 mW·cm⁻² prior to mechanical loading.

30 3. RESULTS AND DISCUSSION

31 3.1 Luminescence properties of $\text{Ba}_4\text{Si}_6\text{O}_{16}:\text{Eu}^{2+}$, *RE*

32 In a $\text{Ba}_4\text{Si}_6\text{O}_{16}$ crystal, SiO_4 tetrahedra are corner-sharing to form 2-periodic single chains ²⁷
33 FIG. 1 (a). Three single chains are linked into triple chains, running along [010] with a 21
34 symmetry, therefore forming 6-membered rings ^{5 7}. Two non-equivalent VIII-coordinated Ba^{2+}
35 sites exist in $\text{Ba}_4\text{Si}_6\text{O}_{16}$, where Ba(1) is located in between two triple chains while Ba(2) is
36 located between two single chains.

37 Three series of $\text{Ba}_4\text{Si}_6\text{O}_{16}:\text{Eu}^{2+}$, *RE* crystals were designed as to study both the incidence of the
38 various *RE* co-doping, the *Eu:RE* ratio and the *Eu+RE* quantity on the luminescence properties.

39 XRD patterns confirmed the sole crystallization of $\text{Ba}_4\text{Si}_6\text{O}_{16}$ in each sample FIG. 1 (b). The
 40 excitation spectra were similar with a change of RE , extending up to 420 nm with a maximum
 41 at $\lambda_{max} = 329$ nm FIG. 2 (a). Just like $\text{Ba}_5\text{Si}_8\text{O}_{21}:\text{Eu}^{2+}$, Dy^{3+} ⁵, such broad excitation spectra
 42 make it possible to activate $\text{Ba}_4\text{Si}_6\text{O}_{16}:\text{Eu}^{2+}$, RE phosphors simply through sunlight irradiation.

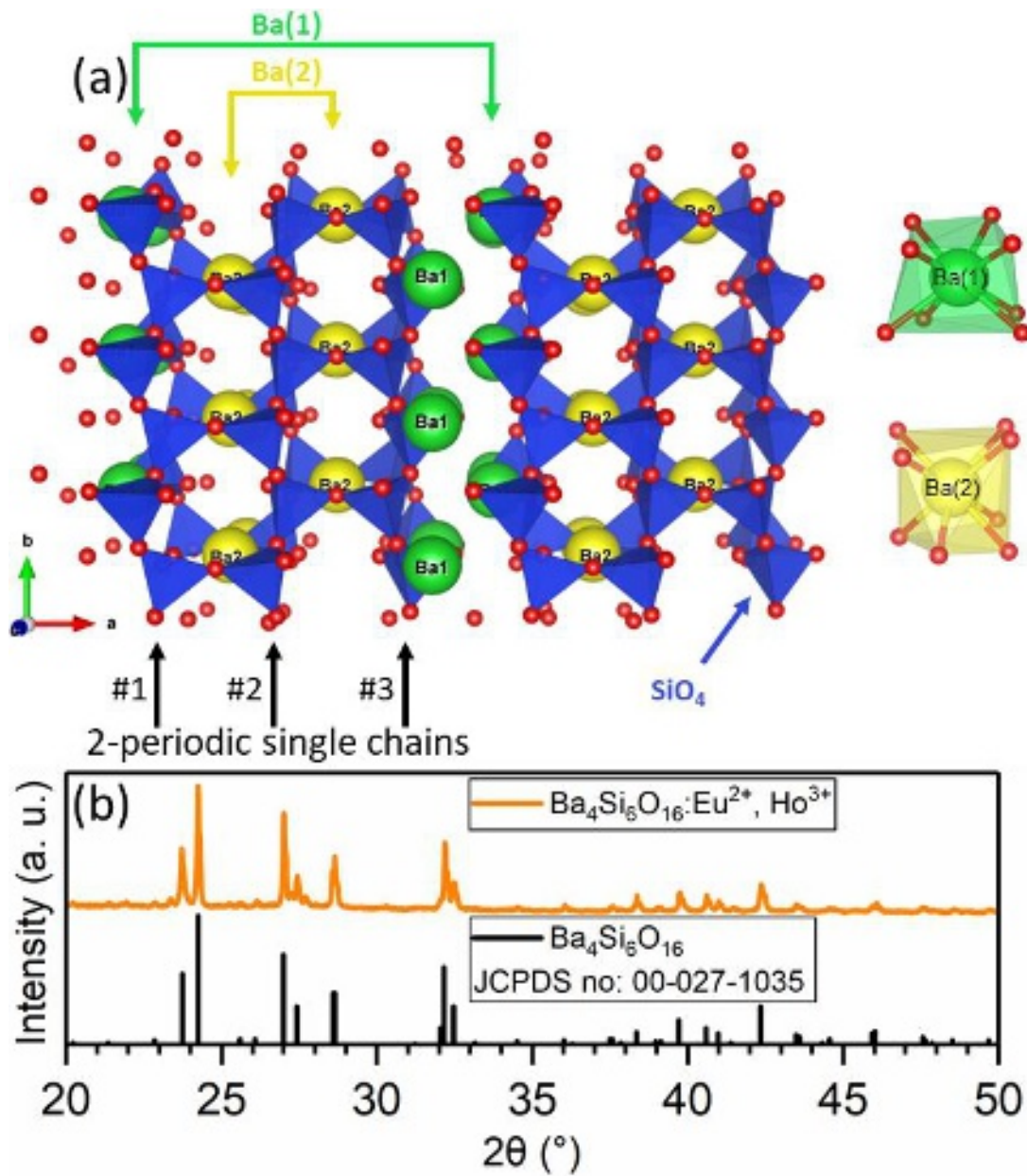

43
 44 **FIG. 1.** (a) Crystal structure of $\text{Ba}_4\text{Si}_6\text{O}_{16}$. Green, yellow, and blue polyhedra correspond to
 45 Ba(1), Ba(2), and Si-based polyhedra respectively. The local coordination of the Ba(1) and

46 Ba(2) sites with the oxygen atoms (red) is shown (b) Typical *XRD* pattern of a $\text{Ba}_4\text{Si}_6\text{O}_{16}:\text{Eu}^{2+}$,
 47 *RE* crystal, here when $RE = \text{Ho}^{3+}$ (orange), and the standard *XRD* pattern of $\text{Ba}_4\text{Si}_6\text{O}_{16}$ (black).
 48 An excitation wavelength of 365 nm was chosen for the following measurements to remain
 49 consistent with the *EML* experiments discussed later in the article. The emission spectra consist
 50 of a broad emission band from 400 to 700 nm characteristic of the $4f^65d^1 \rightarrow 4f^7$ transition of
 51 Eu^{2+} , with a maximum ranging from 516 to 526 nm. While its position is *RE*-dependent, no
 52 conclusions could be obtained regarding its trend. All $\text{Ba}_4\text{Si}_6\text{O}_{16}:\text{Eu}^{2+}$, *RE* crystals exhibited a
 53 green emission, with CIE coordinates $x = 0.302$, $y = 0.478$ when $RE = \text{Ho}^{3+}$ FIG. 2 (b).

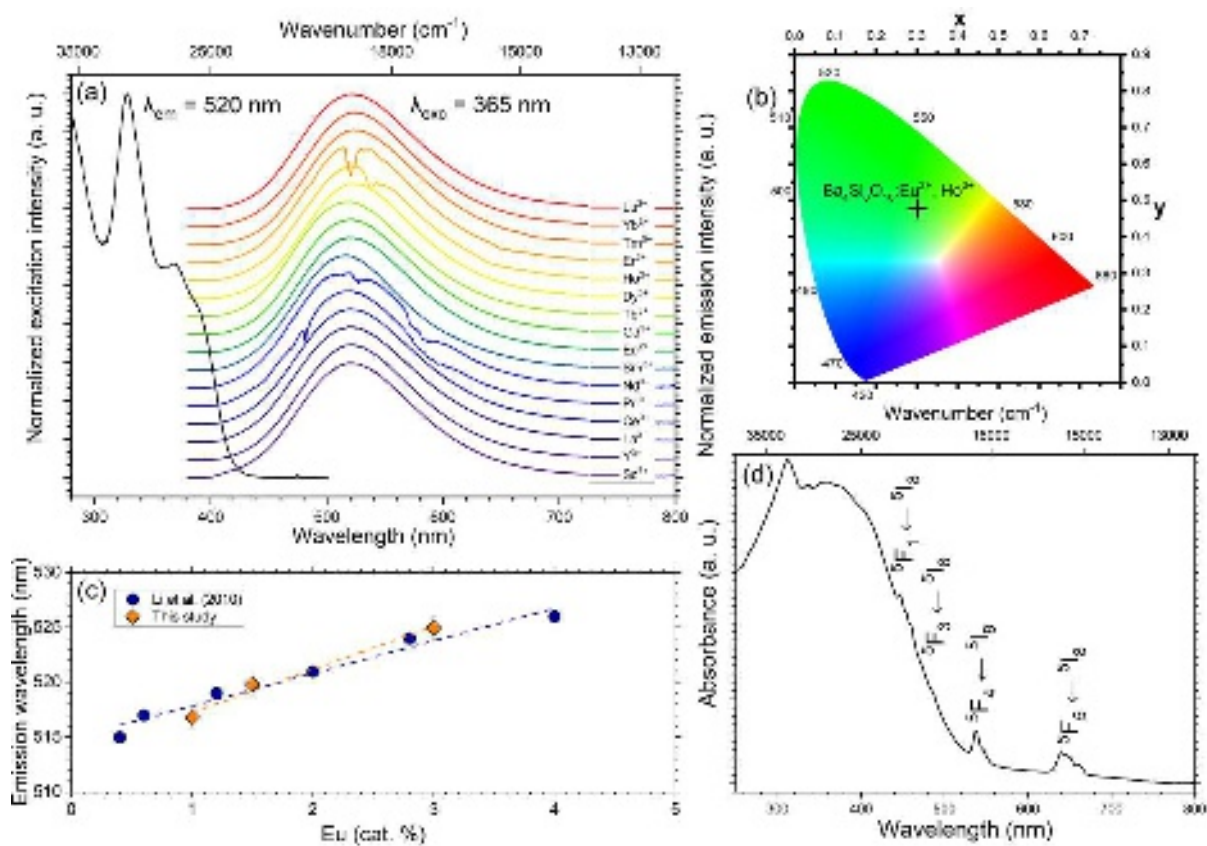

54
 55 **FIG. 2.** (a) Excitation spectrum of $\text{Ba}_4\text{Si}_6\text{O}_{16}:\text{Eu}^{2+}$, Ho^{3+} , and emission spectra of
 56 $\text{Ba}_4\text{Si}_6\text{O}_{16}:\text{Eu}^{2+}$, *RE* crystals (b) CIE chromaticity coordinates of $\text{Ba}_4\text{Si}_6\text{O}_{16}:\text{Eu}^{2+}$, Ho^{3+} (c)
 57 Dependence of the emission wavelength on the europium concentration in $\text{Ba}_4\text{Si}_6\text{O}_{16}:\text{Eu}^{2+}$, Ho^{3+}

58 crystals with a fixed Eu:Ho ratio, and in $\text{Ba}_{4-y}\text{Eu}_y\text{Si}_6\text{O}_{15.85}\text{N}_{0.1}$ crystals ⁷ (d) Absorption
59 spectrum of $\text{Ba}_4\text{Si}_6\text{O}_{16}:\text{Eu}^{2+}, \text{Ho}^{3+}$.

60 In the literature, the λ_{max} position of the broad emission band of $\text{Ba}_4\text{Si}_6\text{O}_{16}:\text{Eu}^{2+}$, *RE* crystals
61 ranges from 494 up to 526 nm. Indeed, its position is slightly redshifted when the europium
62 concentration is increased ⁷. Here, the emission maximum of $\text{Ba}_4\text{Si}_6\text{O}_{16}:\text{Eu}^{2+}, \text{Ho}^{3+}$ crystals with
63 a fixed Eu:Ho ratio but with increasing europium concentrations from 1 to 3 cat. % increases
64 from 517 to 525 nm FIG. 2 (c). Typically, Eu^{2+} concentrations from 0.08 to 1.5 cat. % lead to
65 emission maxima ranging from 495 to 505 nm ^{9 10 32 33}, while higher concentrations up to
66 4 cat. % lead to a maximum emission at 526 nm ⁷. Hence, the reported emission color of
67 $\text{Ba}_4\text{Si}_6\text{O}_{16}:\text{Eu}^{2+}$, *RE* phosphors ranges from bluish-green to green, and can easily be tuned by
68 choosing the right *RE* co-doping as well as Eu^{2+} concentration. The higher the Eu^{2+}
69 concentration is and the smaller the distance between the europium ions becomes, which means
70 that the probability of energy transfer from higher-energy 5d levels Eu^{2+} ions to lower-energy
71 5d levels Eu^{2+} ions increases, resulting in the end in an emission band shifting towards longer
72 wavelength ⁹.

73 Several absorption peaks were observed when *RE* = $\text{Pr}^{3+}, \text{Nd}^{3+}, \text{Ho}^{3+}$, or Er^{3+} , with positions at
74 538, 547, and 638 nm in the case of Ho^{3+} corresponding to transitions from the ground state $^5\text{I}_8$
75 to $^5\text{F}_4, ^5\text{S}_2$, and $^5\text{F}_5$ respectively ³⁴. The absorption spectrum of $\text{Ba}_4\text{Si}_6\text{O}_{16}:\text{Eu}^{2+}, \text{Ho}^{3+}$ revealed
76 both the broad absorption band of Eu^{2+} at short wavelength (< 400 nm), as well as various Ho^{3+}
77 intraconfigurational transitions FIG. 2 (d). The absorption and the quantum efficiency were
78 estimated at $79 \pm 10\%$ and $17 \pm 10\%$ respectively with $\lambda_{exc} = 365$ nm. Li *et al.* ⁷ reported a
79 similar absorption (80 %) but a considerably higher quantum efficiency (46 %) in
80 $\text{Ba}_{3.8}\text{Eu}_{0.2}\text{Si}_6\text{O}_{15.85}\text{N}_{0.1}$.

This is the author's peer-reviewed manuscript. How to cite this article: DOI: 10.1063/1.5016722

81 The luminescence decay was studied over a duration of 6000 ns for $RE = \text{Ho}^{3+}$ and Er^{3+} . It can
82 be fitted using equation (1):

$$83 \quad I(t) = A_1 \exp\left(-\frac{t}{\tau_1}\right) + A_2 \exp\left(-\frac{t}{\tau_2}\right) \quad (1)$$

84 Where $I(t)$ is the luminescence intensity at a given time t , A_1 and A_2 are constants, and τ_1 and
85 τ_2 are time constants describing the luminescence decay. Two regimes are observed in the
86 beginning for a duration of about 200 ns : a rapid one at $t < 200$ ns followed by a slower one,
87 corresponding respectively to $\tau_1 = 0.107 \pm 0.002 \mu\text{s}$ and $\tau_2 = 1.140 \pm 0.004 \mu\text{s}$ FIG. 3 (a),
88 suggesting that in both cases the luminescent center is Eu^{2+} while the RE act as sensitizers.
89 Yang *et al.*¹⁰ also identified two lifetimes in $\text{Ba}_4\text{Si}_6\text{O}_{16}:\text{Eu}^{2+}$, RE crystals when $RE = \text{Eu}^{2+}$, Dy^{3+} ,
90 or Ho^{3+} , however these lifetimes are significantly larger than those reported here ($\tau_1 = 4 \mu\text{s}$ and
91 $\tau_2 = 30.3 \mu\text{s}$). In addition, Chen *et al.*⁸ observed a decrease of the effective decay time with an
92 increase of the europium content in $\text{Ba}_{3.86-y}\text{Si}_6\text{O}_{16}:0.07\text{Ce}^{3+}, 0.07\text{Li}^+, y\text{Eu}^{2+}$, which suggests that
93 a variation of the $\text{Eu}^{2+}:\text{RE}$ ratio and/or $\text{Eu}^{2+}+\text{RE}$ quantity induces a visible change of the
94 specimens lifetime. This was attributed to energy transfers between RE^{3+} co-dopants and Eu^{2+} .
95 However, the kinetics of the LLP decay depends significantly on the selected RE FIG. 3 (b).
96 While the steady-state luminescence (SSL) intensity is roughly similar whatever the RE , the
97 LLP intensity changes significantly. For example, it is increased by two orders of magnitude as
98 Ho^{3+} substitutes Sm^{3+} . The RE leading to the highest LLP intensity at times smaller than 250 ns
99 are, in descending order, Ho^{3+} Nd^{3+} Pr^{3+} and Er^{3+} . The luminescence of $\text{Ba}_4\text{Si}_6\text{O}_{16}:\text{Eu}^{2+}$, Ho^{3+}
00 is visible to the naked eye beyond a day after the excitation source is stopped. FIG. 3 (c) displays
01 photographs at various times of the LLP decay in the case of $\text{Ba}_4\text{Si}_6\text{O}_{16}:\text{Eu}^{2+}$, Ho^{3+} .

This is the author's peer reviewed, accepted manuscript. Version of record for the final published article. This manuscript has been accepted for publication and is subject to future peer review conditions. DOI: 10.1063/1.5167222

This is the author's pre-proof reviewed, accepted manuscript. However, the online version of record will be different from this version once it has been copyedited and typeset.
PLEASE CITE THIS ARTICLE AS DOI: 10.1063/5.0167222

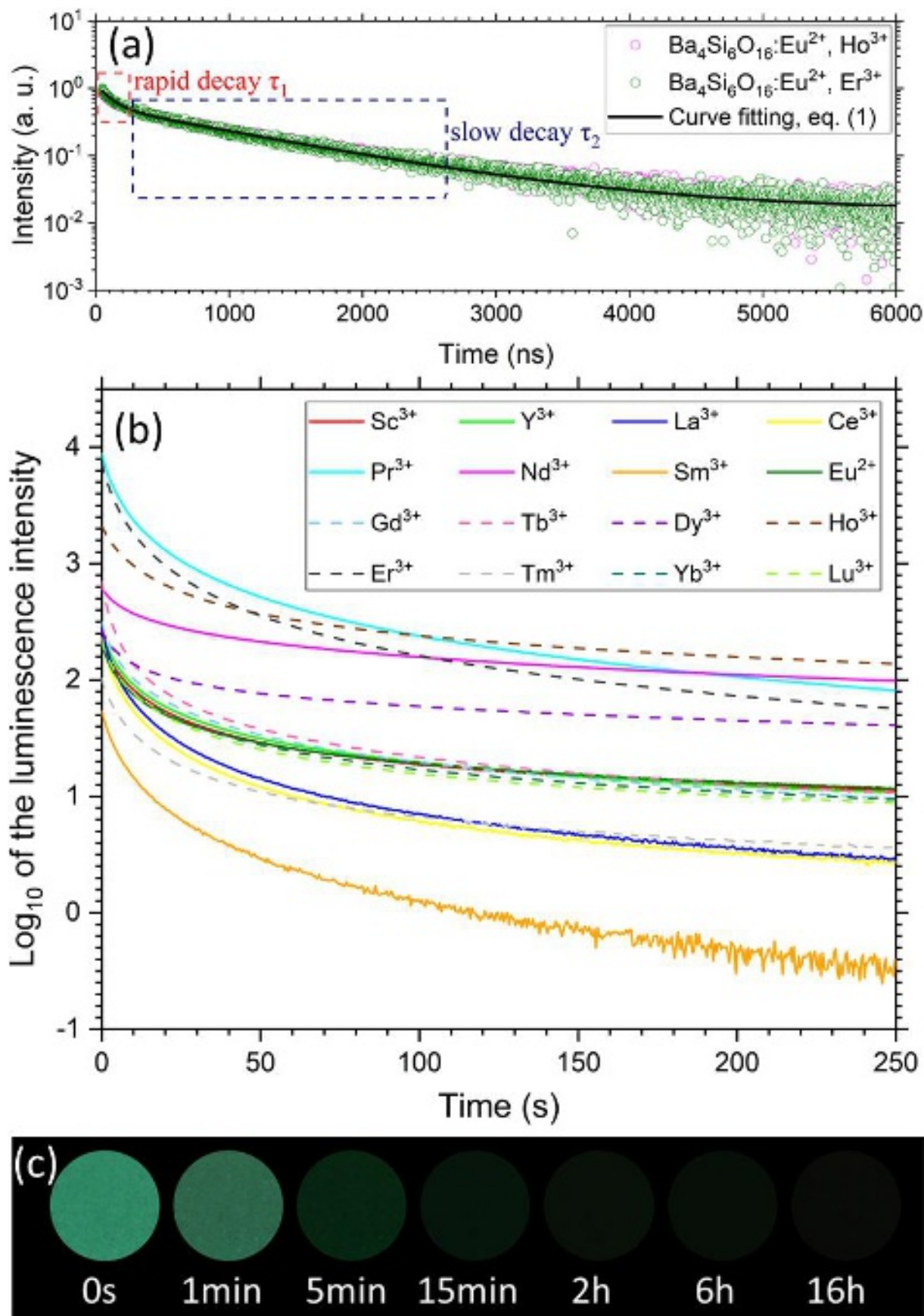

This is the author's peer-reviewed, accepted manuscript. However, the online version of record will be different from this version once it has been fully edited and proof corrected. PLEASE CITE THIS ARTICLE AS DOI: 10.1063/5.0167222

03 **FIG. 3.** (a) Rapid-decay of $\text{Ba}_4\text{Si}_6\text{O}_{16}:\text{Eu}^{2+}$, RE crystals for $RE = \text{Ho}^{3+}$ or Er^{3+} (b) LLP decay of
 04 $\text{Ba}_4\text{Si}_6\text{O}_{16}:\text{Eu}^{2+}$, RE crystals (c) Photographs of $\text{Ba}_4\text{Si}_6\text{O}_{16}:\text{Eu}^{2+}$, Ho^{3+} taken at various times
 05 after the excitation source is stopped, excited beforehand 2 minutes by a 365 nm UV light. Each
 06 disk is 1 cm wide.

07 The afterglow intensity of $\text{Ba}_4\text{Si}_6\text{O}_{16}:\text{Eu}^{2+}$, Ho^{3+} drops by two orders of magnitude as soon as
 08 the excitation source is stopped FIG. 4. It is smaller by about 80 % than the one of the
 09 well-known $\text{SrAl}_2\text{O}_4:\text{Eu}^{2+}$, Dy^{3+} . Yang *et al.*¹⁰ reported a significantly higher afterglow
 10 intensity of $\text{Ba}_4\text{Si}_6\text{O}_{16}:\text{Eu}^{2+}$, Ho^{3+} , well above those of previously reported $\text{Ba}_4\text{Si}_6\text{O}_{16}:\text{Eu}^{2+}$, RE
 11 crystals and noticeably stronger than that of $\text{SrAl}_2\text{O}_4:\text{Eu}^{2+}$, Dy^{3+} .

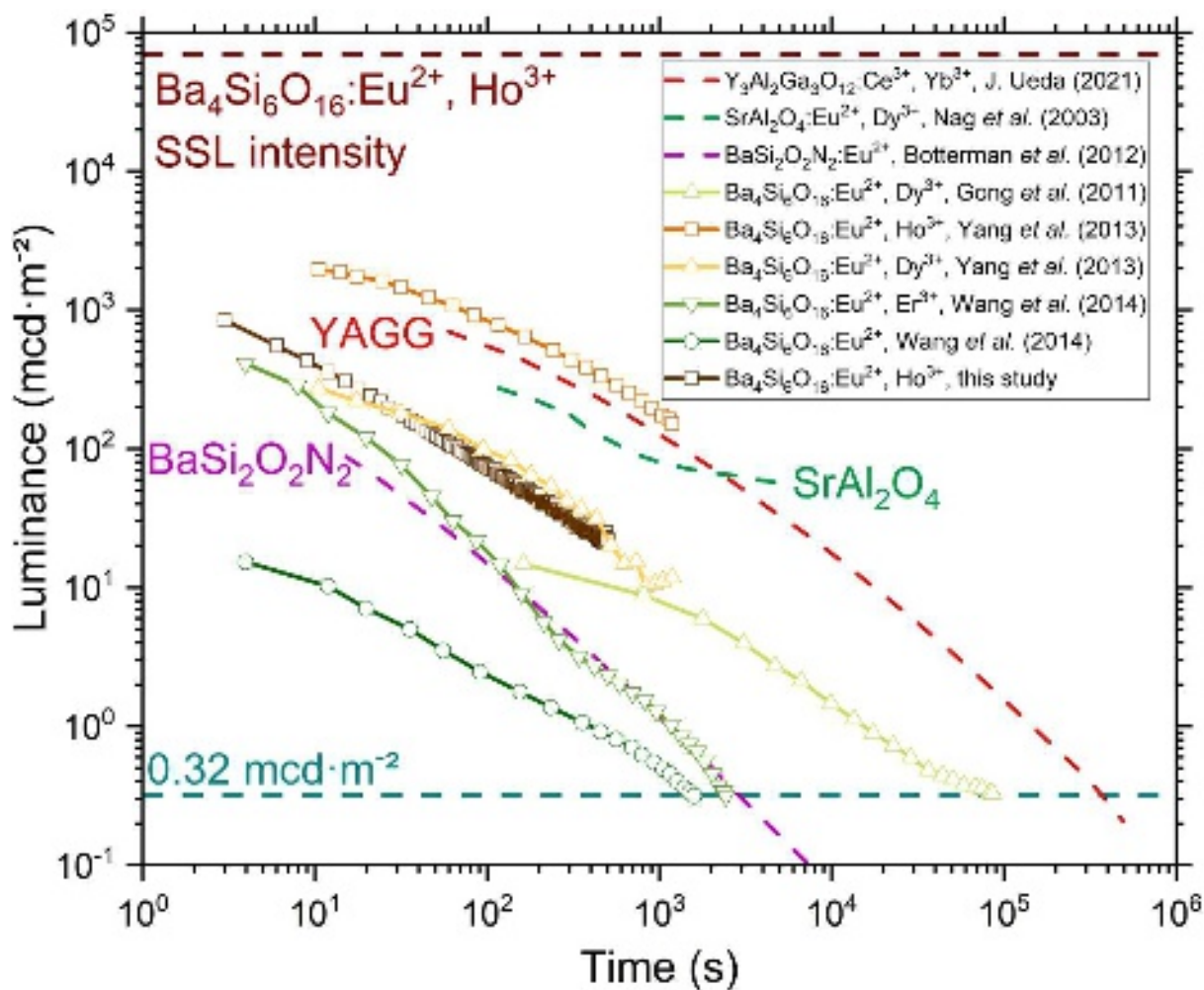

This is the author's peer-reviewed, accepted manuscript. However, the online version of record will be different from this version once it has been copyedited and typeset.
PLEASE CITE THIS ARTICLE AS DOI: 10.1063/5.0167222

13 **FIG. 4.** Luminance of $\text{Ba}_4\text{Si}_6\text{O}_{16}:\text{Eu}^{2+}$, *RE* crystals reported here or in the literature^{10 32 33}, as
14 well as that of well-known phosphors such as $\text{Y}_3\text{Al}_2\text{Ga}_3\text{O}_{12}:\text{Ce}^{3+}$, Yb^{3+} (YAGG)³⁵,
15 $\text{SrAl}_2\text{O}_4:\text{Eu}^{2+}$, Dy^{3+} ³⁶, $\text{BaSi}_2\text{O}_2\text{N}_2:\text{Eu}^{2+}$ ³⁷. The *SSL* intensity of $\text{Ba}_4\text{Si}_6\text{O}_{16}:\text{Eu}^{2+}$, Ho^{3+} is also
16 indicated.

17 *TSL* experiments provide key elements to better understand the *LLP* intensity and decay, such
18 as the trap depths and distributions. Trap depth E and concentration n_0 can be calculated from
19 the *TSL* intensity $I(T)$ according to³⁸:

$$20 \quad I(T) = \left[\left(\frac{(l-1)s}{\beta} \right) \times \int_{T_0}^T \exp\left(-\frac{E}{k_B T}\right) dT + 1 \right]^{-\frac{l}{l-1}} s n_0 \exp\left(-\frac{E}{k_B T}\right) \quad (2)$$

21 Where k_B is the Boltzmann constant, T the temperature, l the kinetic order, s the frequency
22 factor, and β the heating rate ($1 \text{ K}\cdot\text{s}^{-1}$). E , l and s were deduced according to previously
23 described methods^{39 40}. *TSL* curves are plotted in FIG. 5 (a).

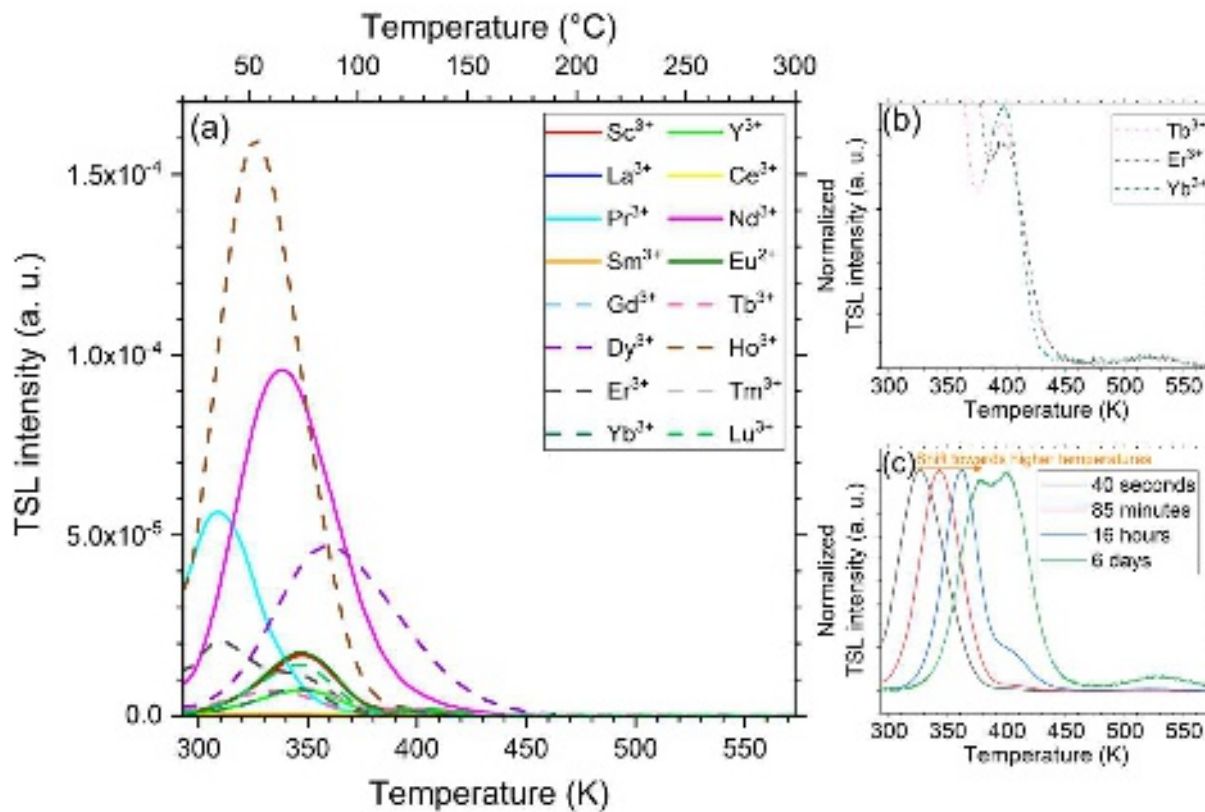

25 **FIG. 5.** (a) *TSL* measurements of $\text{Ba}_4\text{Si}_6\text{O}_{16}:\text{Eu}^{2+}$, *RE* crystals with a heating rate of $1 \text{ K}\cdot\text{s}^{-1}$.
26 (b) Zoom-in of the *TSL* measurements highlighting the recurring 398 and 523 K *TSL* peaks (c)
27 *TSL* measurements of $\text{Ba}_4\text{Si}_6\text{O}_{16}:\text{Eu}^{2+}$, Ho^{3+} carried out with various delay times.
28 In $\text{Ba}_4\text{Si}_6\text{O}_{16}:\text{Eu}^{2+}$, *RE* crystals, three recurring *TSL* peaks were observed FIG. 5 (a) and FIG. 5
29 (b). The first one lies in the 303-363 K region, while the second and third ones are
30 systematically located at temperatures of 398 K and 523 K respectively. The only exceptions
31 are i) $\text{RE} = \text{Dy}^{3+}$, for which the width of the first peak suggests two combined peaks ii) Er^{3+} ,
32 which also exhibits two peaks in the 303-363 K region, and iii) Tm^{3+} that exhibits a third peak
33 at 473 K. Such a recurrence in the peak position hints that the nature of those traps is similar
34 regardless of the *RE* co-doping. Further experiments would be required to elucidate the physical
35 and structural origins of these electron traps.

36 In addition, *TSL* experiments performed with different delay times with $\text{RE} = \text{Ho}^{3+}$ evidenced
37 a gradual shift from the first *TSL* peak towards higher temperatures FIG. 5 (c), which implies
38 that at least for this co-dopant there is actually a distribution of trap depths rather than a discrete
39 energy level. This is consistent with preliminary *DFT* calculations performed on the $\text{Ba}_4\text{Si}_6\text{O}_{16}$
40 crystal, which also show the presence of a distribution of energy levels arising from oxygen
41 vacancies ²⁸. This distribution of energies would extend from at least $E_{C_3} = 0.694$ to
42 $E_{C_1} = 0.924$ eV, where C_3 is the top and C_1 the bottom of the trap distribution. It is slightly
43 shallower than that reported by Yang *et al.* (which extended from 0.602 to 1.156 eV) ¹⁰, where
44 its deepness was possibly overestimated because of the close second *TSL* peak at 398 K. As a
45 matter of fact, short (< 500 s) and long time (up to 60000 s) luminescence decay measured at
46 the peak emission wavelength would suggest that this distribution is close to a gaussian form
47 FIG. 6 ^{41 42 43 44}. It is noteworthy that *RE* co-doping in $\text{Ba}_4\text{Si}_6\text{O}_{16}$ does not always lead to a

48 distribution of trap depths. For example, Dy^{3+} co-doping does not induce a shift of the first *TSL*
 49 peak position with increasing delay times ¹⁰.

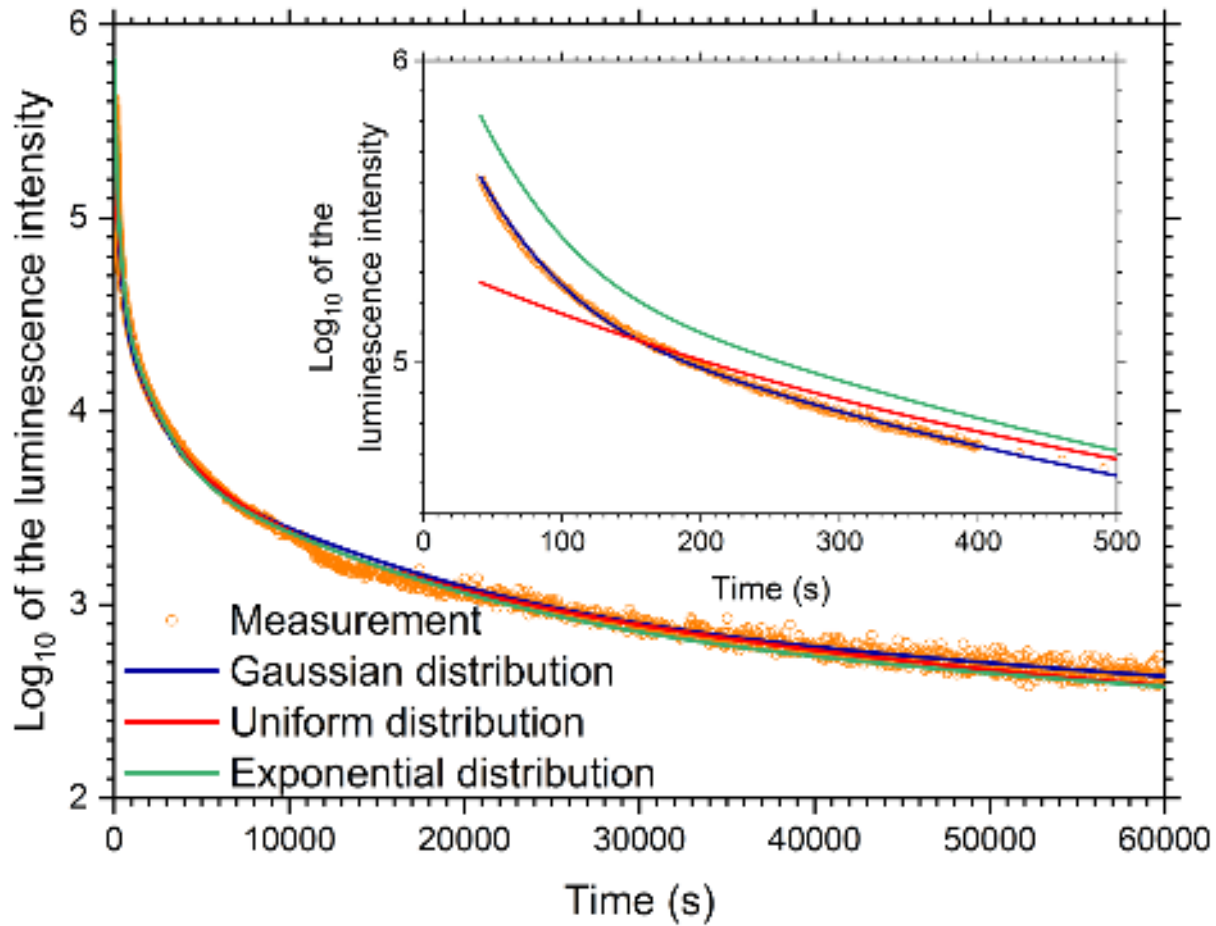

50 **FIG. 6.** *LLP* decay (< 60000 s) of $\text{Ba}_4\text{Si}_6\text{O}_{16}:\text{Eu}^{2+}, \text{Ho}^{3+}$ fitted with various distribution shapes.
 51 The inset shows the *LLP* decay at short times (< 500 s).
 52

53 In order to get more insight into the *LLP* behavior of $\text{Ba}_4\text{Si}_6\text{O}_{16}:\text{Eu}^{2+}$, *RE* crystals at the scale
 54 of a few minutes, only traps with a depth of 1 eV at most need to be considered, which
 55 correspond to the first peak in the 303-363 K region. Thus, the second and third peaks, which
 56 correspond to deeper traps are excluded from this study. The high sensitivity camera used for
 57 *LLP* experiments does not allow to quantify the luminescence intensity immediately after the
 58 excitation source is stopped. Therefore, the luminescence intensity at an arbitrarily chosen time
 59 of 250 s was used as a reflection of the *LLP* lifetime. As can be seen in FIG. 7, there is an

60 excellent agreement between the *LLP* behavior and the traps depths and concentrations as
 61 determined from the spectra in FIG. 5 by means of equation (2): the $\text{Ba}_4\text{Si}_6\text{O}_{16}:\text{Eu}^{2+}$, *RE* crystals
 62 with the strongest afterglow intensity are the ones with the largest concentrations of traps with
 63 depths ranging from 0.65 to 0.85 eV, a region where the relaxation kinetics to the fundamental
 64 state is of the order of a few minutes to several days.

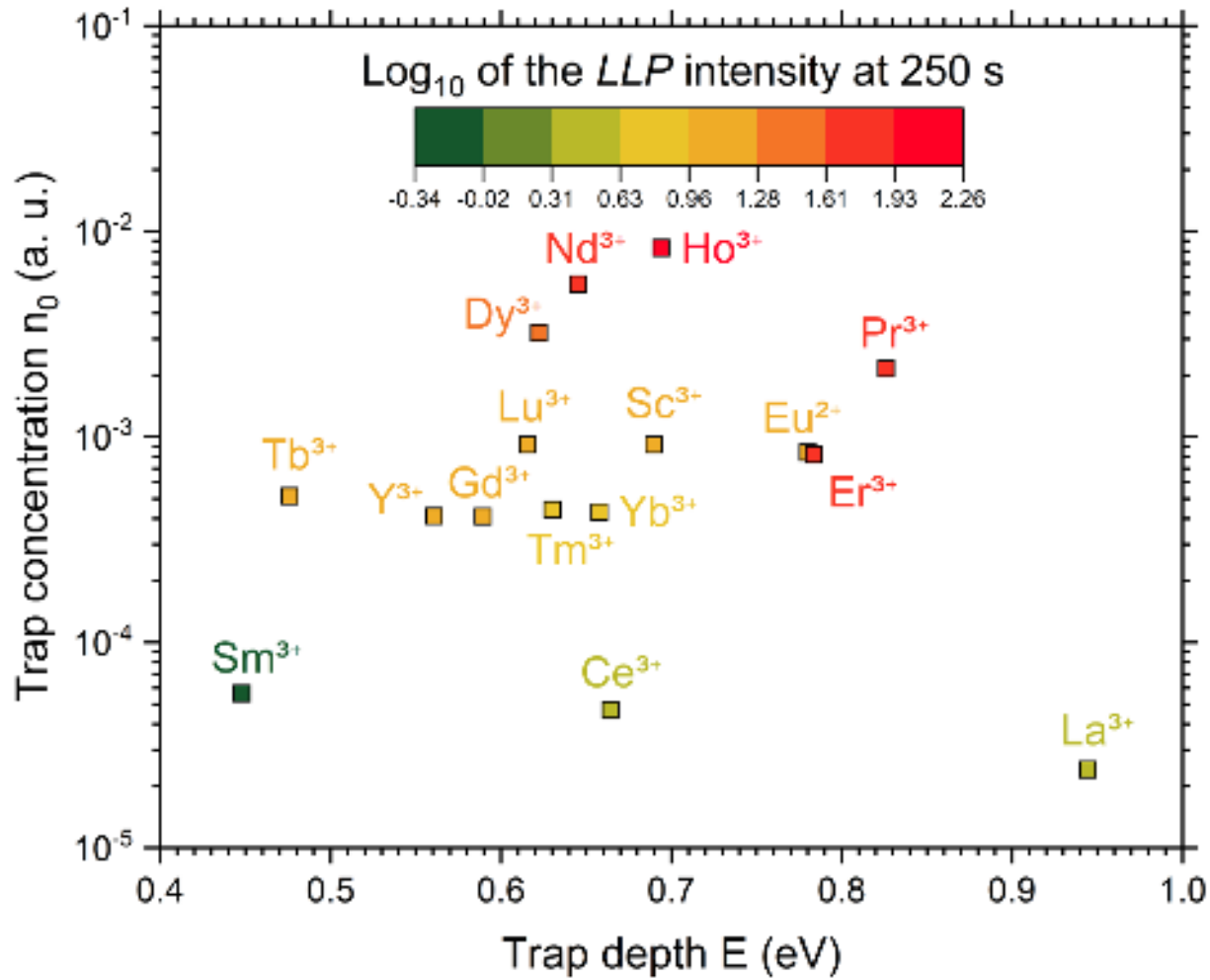

65 **FIG. 7.** Trap depth and concentration of the various $\text{Ba}_4\text{Si}_6\text{O}_{16}:\text{Eu}^{2+}$, *RE* crystals determined
 66 from equation (2).
 67

68 This is the author's peer reviewed, accepted manuscript. However, the online version of record will be different from this version once it has been copyedited and typeset.
 PLEASE CITE THIS ARTICLE AS DOI: 10.1063/5.0167222

69

3.2 Eu(1) and Eu(2) emission bands

70

As europium ions are incorporated in $\text{Ba}_4\text{Si}_6\text{O}_{16}$ crystals, Eu^{2+} will occupy the two non-equivalent Ba^{2+} sites. It was proposed that, because both Ba(1) and Ba(2) sites are coordinated by eight oxygen atoms²⁷, the two europium ions environments are relatively similar, in agreement with the fact that two broad emission bands with close emission maximum are observed^{7 10 32}. Indeed, while the 4f electrons of divalent europium are quite insensitive to their surroundings, this is not the case of the 5d electrons³². Consistently, the broad emission band could be deconvoluted into two bands at $\lambda_{max} = 500$ and 550 nm, corresponding to the two non-equivalent europium sites, namely Eu(1) and Eu(2)³². This is supported by i) a shift of the broad emission band maximum towards longer wavelength when the delay time increases, which suggests the existence of two different lifetimes for each site³², and ii) a significantly different excitation spectra when $\lambda_{em} = 500$ or 550 nm.

73

74

75

76

77

78

79

80

81

82

83

84

85

86

87

88

89

90

91

92

Thermoluminescence experiments performed in this work from 77 to 380 K support another interpretation. When the emission spectra are measured at temperatures as low as 77 K, one can observe a second emission band appearing at $\lambda_{max} = 439$ nm, in addition to the green emission band at $\lambda_{max} = 521$ nm FIG. 8 (a). The intensity of this blue emission band gradually decreases up to 200 K where it is no longer visible, while the thermal quenching of the green emission band starts at 160 K but is not yet completed at 380 K. Furthermore, excitation spectra collected at 77 K with $\lambda_{em} = 500$, 521, or 550 nm are identical FIG. 8 (b), but all-three were notably different from the one obtained with $\lambda_{em} = 439$ nm. Indeed, the latter is shifted towards shorter wavelengths and its behavior in the 330-400 nm region is clearly unlike. This is in contradiction with what was previously reported³². This suggests that i) the blue and green emission bands are of different nature, which is clearly outlined when $\lambda_{exc} = 312$ nm, and ii) the green emission band is not composed of two subsequent emission bands.

This is the author's peer-reviewed accepted manuscript. However, the final version of the manuscript will be different from this version. Please cite this article as: DOI: 10.1063/5.0167222

This is the author's peer-reviewed, accepted manuscript. However, the online version of record will be different from this version once it has been copyedited and typeset. PLEASE CITE THIS ARTICLE AS DOI: 10.1063/5.0167222

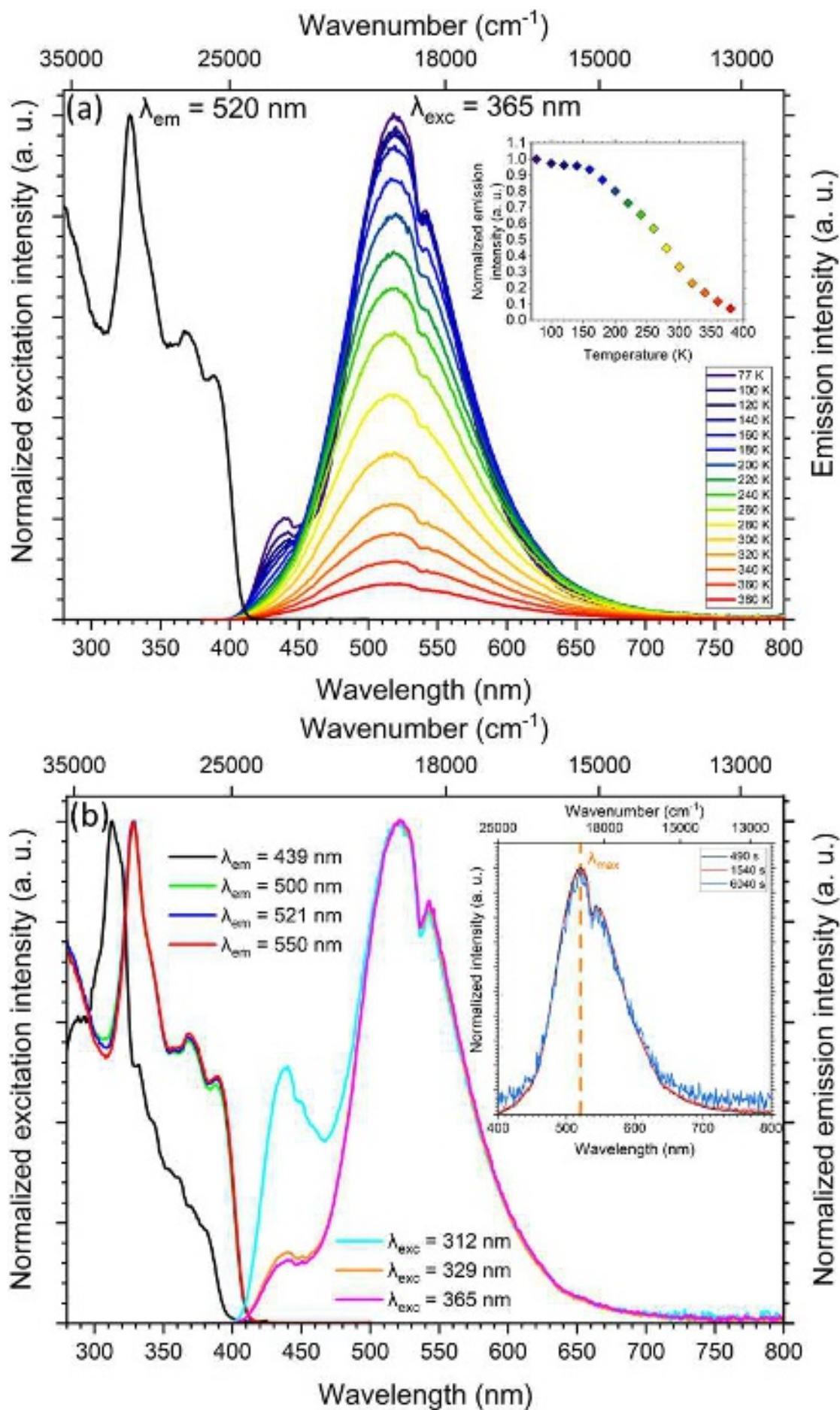

94 **FIG. 8.** (a) Excitation spectra measured at 77 K and emission spectra measured at various
95 temperatures (20 K steps) of $\text{Ba}_4\text{Si}_6\text{O}_{16}:\text{Eu}^{2+}, \text{Ho}^{3+}$. The inset shows the emission intensity at
96 various temperatures. (b) Excitation and emission spectra of $\text{Ba}_4\text{Si}_6\text{O}_{16}:\text{Eu}^{2+}, \text{Ho}^{3+}$ at 77 K. The
97 inset shows the *LLP* emission spectra at ambient temperature various times after the excitation
98 source is stopped.

99 The interpretation proposed in this work is supported by emission spectra measured at various
100 times after the excitation source is stopped, where no shift of the emission maximum was
101 observed FIG. 8 (b), which was already noted in another study⁴⁵. The previously observed shift
102 is likely resulting from the presence of $\beta\text{-BaSiO}_3$ as a secondary phase, which is revealed by
103 the presence of a peak on the *XRD* pattern at 26° FIG. 1. The persistent luminescence properties
104 of this crystal are known¹¹ and an emission maximum at $\lambda_{max} = 560$ nm was identified, which
105 explains the shift of the emission maximum towards longer wavelengths with time.

106 It is thus concluded that the two non-equivalent Eu^{2+} sites are sufficiently different to give birth
107 to two emission bands at low temperatures. Indeed, the Ba(1) polyhedron is more distorted than
108 the Ba(2) one²⁷, so that an 82 nm difference between the two emission bands maximum is
109 observed. It was proposed that the higher distortion degree of the Ba(1) polyhedra would result
110 in a weaker crystal field of Ba(1) than that of Ba(2)¹⁰, thus, the broad emission band of Eu(1)
111 would be in a shorter wavelength region than that of Eu(2)⁴⁶, *i. e.* the blue emission band would
112 correspond to Eu(1) and the green one to Eu(2). However, it is still not clear as to why the
113 thermal quenching of Eu(1) occurs at much lower temperatures than that of Eu(2).

114 The thermoluminescence behavior of $\text{Ba}_4\text{Si}_6\text{O}_{16}:\text{Eu}^{2+}, \text{Ho}^{3+}$ is very similar to that of monoclinic
115 $\text{SrAl}_2\text{O}_4:\text{Eu}^{2+}, \text{Dy}^{3+}$. In the latter, a blue emission band also appears at low temperatures
116 ($\lambda_{max} = 445$ nm) which arises from the presence of two non-equivalent Sr^{2+} sites in the crystal
117 structure⁴⁷. In addition, the asymmetric green emission band of $\text{Ba}_4\text{Si}_6\text{O}_{16}:\text{Eu}^{2+}, \text{Ho}^{3+}$ is shifted

18 to larger wavelengths just like the green emission band ($\lambda_{max} = 520$ nm) of strontium
19 aluminate. In this latter case, this was discussed by Botterman *et al.*⁴⁷ in terms of the centroid
20 shift and crystal field splitting.

21

22 **3.3 Mechanoluminescence properties of Ba₄Si₆O₁₆:Eu²⁺, RE**

23 The *EML* response of Ba₄Si₆O₁₆:Eu²⁺, RE/epoxy composites, obtained by subtracting the *LLP*
24 intensity as recorded at rest (*i. e.* at $\sigma = 0$ MPa) to the mechanically-loaded specimen, was
25 characterized by means of the diametral compression tests FIG. 9 (a). Each test was performed
26 with a 0.37 MPa·s⁻¹ stress rate. It is recalled that the *EML* intensity is proportional to both the
27 stress and the stress rate⁴⁸. In a similar way as with the previous *LLP* measurements, the *RE*
28 co-doping has a pronounced effect on the intensities of the *EML* signal. The largest intensities
29 are obtained with *RE* = Ho³⁺, Pr³⁺, Er³⁺, or Nd³⁺ FIG. 9 (b). The mechanical stress was applied
30 90 s after the excitation source was stopped, as longer delays resulted in smaller *EML* intensity.
31 This suggests that the charge carriers involved in the *EML* of Ba₄Si₆O₁₆:Eu²⁺, *RE* crystals
32 slowly recombine with the luminescent center with time, and are thus also participating in the
33 *LLP* at the scale of several minutes/hours.

34 There seems to be a strong connection between the *EML* intensity and the *LLP* intensity FIG. 9
35 (c). Various mechanisms were proposed to explain the mechanically-induced luminescence²⁹,
36 among which those involving piezoelectricity are the most popular. It is supposed that, as a
37 stress field is applied, the trap depths are changed thanks to piezoelectricity, ultimately altering
38 the charge carriers recombination kinetics. Although Ba₄Si₆O₁₆ is centrosymmetric (space
39 group *P2₁/c*) and should therefore not exhibit piezoelectricity, centrosymmetry might be broken
40 at the local scale by the presence of defects, so that piezoelectricity can subsequently be
41 observed²⁹. In Ba₂Si₂O₂N₂:Eu²⁺, the stress is assumed to induce a decrease of a trap depth

42 leading to an increased luminescence intensity²⁰. In the SrAl₂O₄:Eu²⁺, Dy³⁺ compound, a
 43 mechanism with three discrete traps allowed to explain an increase in the luminescence
 44 intensity both during the loading and the unloading stages⁴⁹. This correlation is therefore
 45 consistent with this latter mechanism: a larger trap concentration with depths ranging from 0.65
 46 to 0.85 eV is assumed i) to result in a stronger *LLP* intensity, but also ii) in a stronger *EML*
 47 intensity, as more charge carriers will be able to recombine with the luminescent center when
 48 the trap depth decreases.

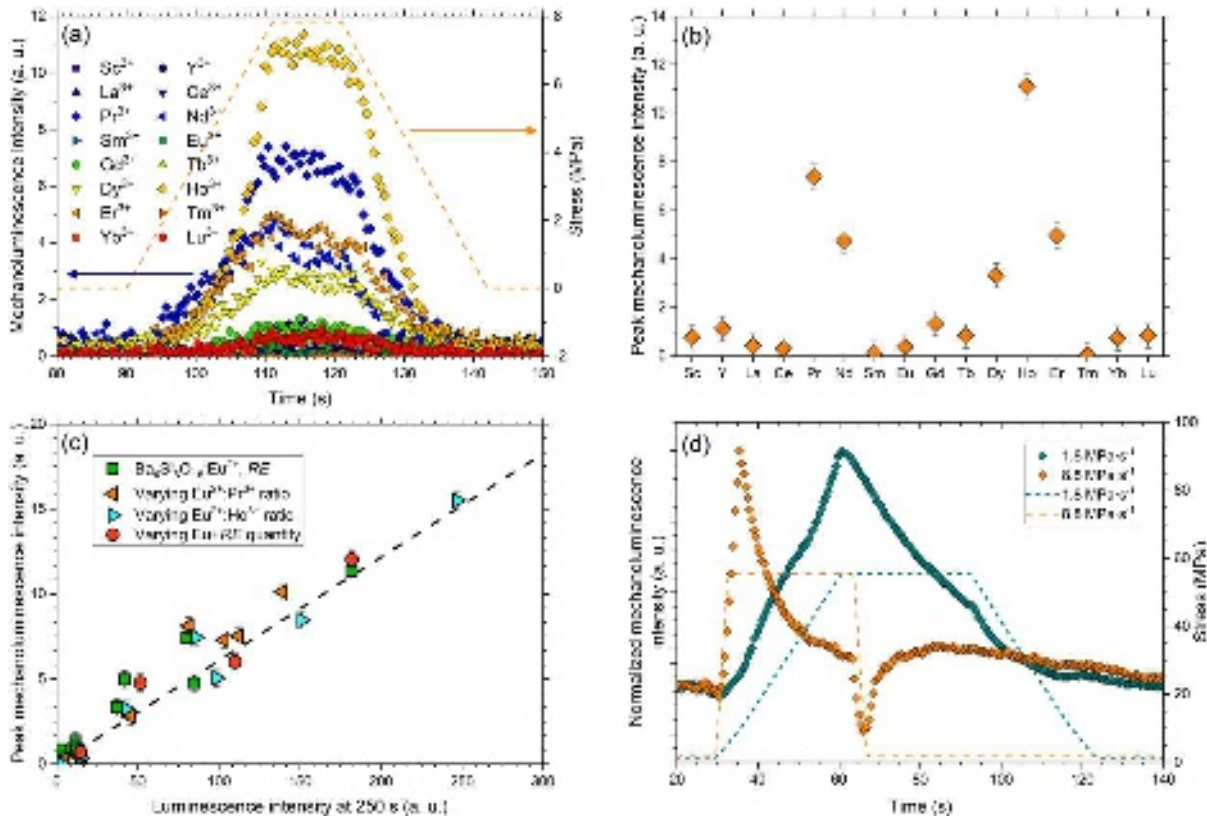

49
 50 **FIG. 9.** (a) *EML* intensity of Ba₄Si₆O₁₆:Eu²⁺, RE/epoxy composites (b) Peak *EML* intensity of
 51 Ba₄Si₆O₁₆:Eu²⁺, RE/epoxy composites (c) Peak *EML* intensity plotted as a function of the
 52 luminescence intensity at 250 s (d) *EML* intensity of Ba₄Si₆O₁₆:Eu²⁺, Ho³⁺/epoxy composite
 53 with stress rates of 1.8 and 8.8 MPa·s⁻¹.

54 Regarding the Ba₄Si₆O₁₆:Eu²⁺, Ho³⁺ compound, its *EML* behavior contrasts with the one of
 55 SrAl₂O₄:Eu²⁺, Dy³⁺. It is particularly outlined with high stress rates (here with 8.8 MPa·s⁻¹),

56 where *EML* is more intense and therefore better resolved FIG. 9 (d). It is noteworthy that the
57 *EML* behavior of the Ba₄Si₆O₁₆:Eu²⁺, Ho³⁺/epoxy composite is identical to that of a
58 mechanoluminescent glass-ceramic with the same cationic composition ²⁸. The mechanical
59 loading and its holding lead to an increase in the luminescence intensity, while the unloading
60 leads to a decrease of the luminescence intensity. Changes in irradiation time lead to an increase
61 in both the luminescence and the mechanoluminescence intensity.

62 In particular, *TSL* experiments provide insight into the *EML* mechanism. Based on the existence
63 of an electron trap distribution, we can propose an energy level scheme for
64 Ba₄Si₆O₁₆:Eu²⁺, Ho³⁺ FIG. 10. Although the identified charge carriers (holes and/or electrons)
65 involved in the afterglow of Ba₄Si₆O₁₆:Eu²⁺, *RE* phosphors are still unknown ³², it is assumed
66 that electrons are the key players. Traps corresponding to the 398 K and 523 K *TSL* peaks are
67 too deep to contribute to the *EML* effect. The Eu²⁺ ions electronic configuration changes from
68 the ground state 4f⁷ to the 4f⁶5d¹ excited state under UV light. Then, the electron can escape to
69 the conduction band and eventually reaches energy levels located in the band gap, leaving
70 behind Eu³⁺ ions. The main effect of the mechanical loading is to change the depth of the trap
71 distribution, *i. e.* the *C*₃ and/or the *C*₁ trap depth decreases (FIG. 10 illustrates the scenario
72 where the depth of the whole trap distribution decreases). The recombination probability is
73 therefore higher and an increase of the luminescence intensity follows. However, the
74 mechanical loading empties the stocked charge carriers at a much higher rate than it would have
75 at rest. As a matter of fact, a smaller luminescence intensity is observed after the stress is
76 relieved. This model provides an explanation to the observed *EML* during both mechanical
77 loading and unloading, in consistency i) with the *EML* mechanisms involving changes in trap
78 depths through piezoelectricity, and ii) the decrease in the *EML* intensity with long delays prior
79 to mechanical loading in Ba₄Si₆O₁₆:Eu²⁺, *RE* crystals.

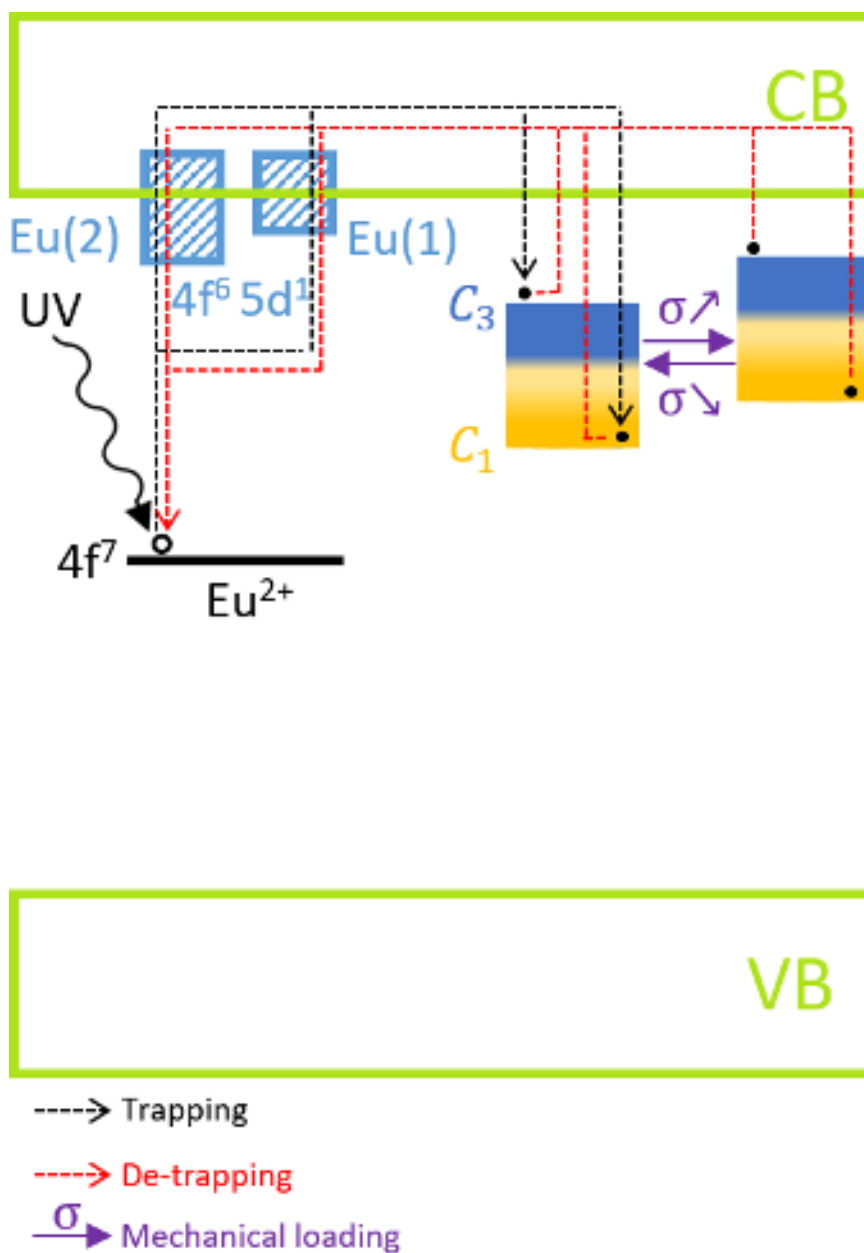

FIG. 10. Energy level scheme of $\text{Ba}_4\text{Si}_6\text{O}_{16}:\text{Eu}^{2+}$, Ho^{3+} under mechanical stress. For the sake of clarity, the trap distribution is shown as a continuous succession of trap depths.

4. CONCLUSION

The luminescence properties of $\text{Ba}_4\text{Si}_6\text{O}_{16}:\text{Eu}^{2+}$, RE crystals, as well as their EML properties, were studied. A change in the RE co-doping leads to small changes in the emission wavelength, but to dramatic changes in the LLP behavior and EML intensity. The incidence of the RE

88 co-doping was put into perspectives with trap depths and concentrations determined from *TSL*
89 measurements. Exact definition of co-doping and Eu^{2+} concentration allows to tune the
90 emission color and lifetime of $\text{Ba}_4\text{Si}_6\text{O}_{16}:\text{Eu}^{2+}$, *RE* phosphors. When $RE = \text{Ho}^{3+}$, the *LLP*
91 duration extends beyond a day.

92 Emission spectra measured at low temperatures revealed a second emission band
93 ($\lambda_{max} = 439$ nm) in addition to the green emission band ($\lambda_{max} = 521$ nm). They stem from Eu^{2+}
94 ions located in the two non-equivalent Ba^{2+} sites in $\text{Ba}_4\text{Si}_6\text{O}_{16}$, in a similar way as in
95 $\text{SrAl}_2\text{O}_4:\text{Eu}^{2+}$, Dy^{3+} .

96 *TSL* experiments unveiled a trap distribution from 0.694 to 0.924 eV in $\text{Ba}_4\text{Si}_6\text{O}_{16}:\text{Eu}^{2+}$, Ho^{3+}
97 that allowed, with *EML* experiments, to build an energy level scheme of the ongoing *EML*
98 mechanism. Mechanical loading decreases the depth of the trap distribution, resulting in a faster
99 release of the charge carriers and ultimately in an increase of the luminescence intensity. During
00 unloading, the trap distribution returns to its initial position but with significantly less charge
01 carriers, which is exhibited by a drop of the luminescence intensity *i. e.* by a negative *EML*
02 intensity.

04 ACKNOWLEDGEMENTS

05 We acknowledge financial support from Région Bretagne and from the European Research
06 Council (ERC Adv. Grant “DAMREG”).

08 AUTHOR DECLARATIONS

09 **Conflict of Interest**

10 The authors have no conflicts to disclose.

11

12 **Author Contributions**

13 **Alexis Duval:** Conceptualization (lead); Data curation (lead); Investigation (lead);
14 Methodology (lead); Writing – original draft (lead). **Yan Suffren:** Conceptualization (equal);
15 Data curation (lead); Investigation (equal); Methodology (equal); Writing – review & editing
16 (equal). **Mourad Benabdesselam:** Conceptualization (equal); Data curation (lead);
17 Investigation (equal); Methodology (equal); Writing – review & editing (equal). **Patrick**
18 **Houizot:** Conceptualization (equal); Investigation (equal); Methodology (equal); Supervision
19 (equal); Writing – review & editing (equal). **Tanguy Rouxel:** Conceptualization (equal);
20 Methodology (equal); Supervision (equal); Writing – review & editing (equal).

21
22 **DATA AVAILABILITY**

23 The data that support the findings of this study are available within the article and from the
24 corresponding author upon reasonable request.

25
26 **ORCID**

27 Alexis Duval iD <https://orcid.org/0000-0001-9192-2454>

28 Yan Suffren iD <https://orcid.org/0000-0001-6338-8274>

29 Mourad Benabdesselam iD <https://orcid.org/0000-0002-9207-2938>

30 Patrick Houizot iD <https://orcid.org/0000-0002-6360-6996>

This is the author's peer-reviewed, accepted manuscript. However, the only version of record for this version is the final version that has been peer-reviewed and accepted for publication. PLEASE CITE THIS ARTICLE AS DOI: 10.1063/5.0167222

31 Tanguy Rouxel iD <https://orcid.org/0000-0002-9961-245>

32

33 **REFERENCES**

34 ¹ X. Meng, H. Li, Z. Wang, Y. Li, H. Lin, S. Liu, and Y. He, *Mater. Lett.* **297**, 129928 (2021).

35 ² C. Donghua, W. Hui, W. Hongjun, and Y. Weiqiang, *J. Semicond.* **36**, (2015).

36 ³ R. Zhang, T. Maeda, R. Maruta, S. Kusaka, B. Ding, K. ichiro Murai, and T. Moriga, *J.*
37 *Solid State Chem.* **183**, 620 (2010).

38 ⁴ Z. Dong, Y. Qin, Y. Yang, D. Zhou, X. Xu, and J. Qiu, *J. Rare Earths* **34**, 453 (2016).

39 ⁵ P. Wang, X. Xu, D. Zhou, X. Yu, and J. Qiu, *Inorg. Chem.* **54**, 1690 (2015).

40 ⁶ I.S. Cho, D.K. Yim, C.H. Kwak, J.S. An, H.S. Roh, and K.S. Hong, *J. Lumin.* **132**, 375
41 (2012).

42 ⁷ Y. Li, Y. Fang, N. Hirosaki, R.J. Xie, L. Liu, T. Takeda, and X. Li, *Materials (Basel)*. **3**,
43 1692 (2010).

44 ⁸ M. Chen, Z. Xia, M.S. Molocheev, and Q. Liu, *J. Mater. Chem. C* **3**, 12477 (2015).

45 ⁹ W.-S. Song, H.-J. Kim, Y.-S. Kim, and H. Yang, *J. Electrochem. Soc.* **157**, J319 (2010).

46 ¹⁰ Z. Yang, Y. Hu, L. Chen, and X. Wang, *Opt. Mater. (Amst)*. **35**, 1264 (2013).

47 ¹¹ Y. Jia, W. Sun, R. Pang, T. Ma, D. Li, H. Li, S. Zhang, J. Fu, L. Jiang, and C. Li, *Mater.*
48 *Des.* **90**, 218 (2016).

49 ¹² X. Li, Y. Liang, F. Yang, Z. Xia, W. Huang, and Y. Li, *J. Mater. Sci. Mater. Electron.* **24**,
50 3199 (2013).

This is the author's pre-proof version of the manuscript. However, the online version of the article will differ from this version since it has been edited and typeset. PLEASE CITE THIS ARTICLE AS DOI: 10.1063/5.0167222

- 51 ¹³ M. Zhang, J. Wang, Q. Zhang, W. Ding, and Q. Su, **42**, 33 (2007).
- 52 ¹⁴ D. Kim, T.H. Kim, T.E. Hong, J. Bae, C.H. Kim, J. Kim, S. Kim, K. Jeon, and J. Park,
53 *Materials (Basel)*. **13**, 1859 (2020).
- 54 ¹⁵ K. Asami, J. Ueda, K. Yasuda, K. Hongo, R. Maezono, M.G. Brik, and S. Tanabe, *Opt.*
55 *Mater. (Amst)*. **84**, 436 (2018).
- 56 ¹⁶ M. Yamaga, Y. Masui, S. Sakuta, N. Kodama, and K. Kaminaga, *Phys. Rev. B - Condens.*
57 *Matter Mater. Phys.* **71**, 1 (2005).
- 58 ¹⁷ M. Yamaga, Y. Masui, and N. Kodama, *Opt. Mater. (Amst)*. **36**, 1776 (2014).
- 59 ¹⁸ J.K. Park, M.A. Lim, K.J. Choi, and C.H. Kim, *J. Mater. Sci.* **40**, 2069 (2005).
- 60 ¹⁹ S.H. Choi, S. Bin Kwon, U. Bin Humayoun, W.K. Park, K. Toda, M. Kakihana, T. Masaki,
61 W.S. Yang, Y.H. Song, and D.H. Yoon, *Dye. Pigment.* **148**, 460 (2018).
- 62 ²⁰ J. Botterman, K. Van Den Eeckhout, I. De Baere, D. Poelman, and P.F. Smet, *Acta Mater.*
63 **60**, 5494 (2012).
- 64 ²¹ H. Pan, D. Luo, L. Wang, and Y. Li, *Int. Conf. Manuf. Sci. Eng. (ICMSE 2015)* 690
65 (2015).
- 66 ²² B. Wang, J. Chen, Y. Xia, and Y. Liu, *J. Nanosci. Nanotechnol.* **16**, 3608 (2016).
- 67 ²³ P.F. Smet, J. Botterman, K. Van Den Eeckhout, K. Korthout, and D. Poelman, *Opt. Mater.*
68 (Amst). **36**, 1913 (2014).
- 69 ²⁴ F. Xiao, Y.N. Xue, and Q.Y. Zhang, *Spectrochim. Acta - Part A Mol. Biomol. Spectrosc.*
70 **74**, 758 (2009).
- 71 ²⁵ W. Peng-Jiu, X. Xu-Hui, Q. Jian-Bei, Z. Da-Cheng, L. Xue-E, and C. Shuai, *Acta Phys.*

- 72 Sin. **63**, 077804 (2014).
- 73 ²⁶ R.D. Shannon, Acta Crystallogr. Sect. A **32**, 751 (1976).
- 74 ²⁷ K.-F. Hesse and F. Liebau, Zeitschrift Für Krist. **153**, 3 (1980).
- 75 ²⁸ A. Duval, P. Houizot, X. Rocquefelte, and T. Rouxel, Appl. Phys. Lett. **123**, 011905
76 (2023).
- 77 ²⁹ A. Feng and P.F. Smet, Materials (Basel). **11**, 484 (2018).
- 78 ³⁰ C. Lara, M.J. Pascual, and A. Durán, J. Non. Cryst. Solids **348**, 149 (2004).
- 79 ³¹ N. Claussen and J. Jahn, Powder Metall. International **2**, 87 (1970).
- 80 ³² Y. Gong, Y. Wang, Y. Li, X. Xu, and W. Zeng, Opt. Express **19**, 4310 (2011).
- 81 ³³ P. Wang, X. Xu, J. Qiu, X. Yu, and Q. Wang, Opt. Mater. (Amst). **36**, 1826 (2014).
- 82 ³⁴ G.H. Dieke and H.M. Crosswhite, Appl. Opt. **2**, 675 (1963).
- 83 ³⁵ J. Ueda, Bull. Chem. Soc. Jpn. **94**, 2807 (2021).
- 84 ³⁶ A. Nag and T.R.N. Kutty, J. Alloys Compd. **354**, 221 (2003).
- 85 ³⁷ J. Botterman, K. Van den Eeckhout, A.J.J. Bos, P. Dorenbos, and P.F. Smet, Opt. Mater.
86 Express **2**, 341 (2012).
- 87 ³⁸ R. Chen and Y. Kirsh, Int. Ser. Sci. Solid State **15**, 17 (1981).
- 88 ³⁹ R. Chen, J. Electrochem. Soc. **116**, 1254 (1969).
- 89 ⁴⁰ M.S. Jahan, D.W. Cooke, W.L. Hults, J.L. Smith, B.L. Bennett, and M.A. Maez, J. Lumin.
90 **47**, 85 (1990).
- 91 ⁴¹ J.T. Randall and M.H.F. Wilkins, Proc. R. Soc. London. Ser. A. Math. Phys. Sci. **184**, 365

92 (1945).

93 ⁴² J.T. Randall and M.H.F. Wilkins, Proc. R. Soc. London. Ser. A. Math. Phys. Sci. **184**, 390

94 (1945).

95 ⁴³ W.F. Hornyak and R. Chen, J. Lumin. **44**, 73 (1989).

96 ⁴⁴ W.L. Medlin, Phys. Rev. **123**, 502 (1961).

97 ⁴⁵ X. Zhang, X. Xu, Q. He, J. Qiu, and X. Yu, ECS J. Solid State Sci. Technol. **2**, R225

98 (2013).

99 ⁴⁶ G. Blasse and B.C. Grabmaier, Springer (1994).

00 ⁴⁷ J. Botterman, J.J. Joos, and P.F. Smet, Phys. Rev. B - Condens. Matter Mater. Phys. **90**, 1

01 (2014).

02 ⁴⁸ M. Dubernet, Y. Gueguen, P. Houizot, F. Célarié, J.C. Sangleboeuf, H. Orain, and T.

03 Rouxel, Appl. Phys. Lett. **107**, 151906 (2015).

04 ⁴⁹ M. Dubernet, E. Bruyer, Y. Gueguen, P. Houizot, J.C. Hameline, X. Rocquefelte, and T.

05 Rouxel, Sci. Rep. **10**, 19495 (2020).

06

This is the author's peer reviewed, accepted manuscript. However, the online version of records will be different from this version as it has been copy edited and typeset.
PLEASE CITE THIS ARTICLE AS DOI: 10.1063/5.0167222