



HAL
open science

Degradation of Imidacloprid in Water by a DBD Plasma

Xin Liu, Junwei Guo, Xiaojiang Tang, Lianfeng Lin, Eric Robert, Feng Huang

► **To cite this version:**

Xin Liu, Junwei Guo, Xiaojiang Tang, Lianfeng Lin, Eric Robert, et al.. Degradation of Imidacloprid in Water by a DBD Plasma. Polish Journal of Environmental studies, 2023, 32 (2), pp.1277-1286. 10.15244/pjoes/155965 . hal-04258429

HAL Id: hal-04258429

<https://hal.science/hal-04258429v1>

Submitted on 26 Oct 2023

HAL is a multi-disciplinary open access archive for the deposit and dissemination of scientific research documents, whether they are published or not. The documents may come from teaching and research institutions in France or abroad, or from public or private research centers.

L'archive ouverte pluridisciplinaire **HAL**, est destinée au dépôt et à la diffusion de documents scientifiques de niveau recherche, publiés ou non, émanant des établissements d'enseignement et de recherche français ou étrangers, des laboratoires publics ou privés.

Degradation of Imidacloprid in Water by a DBD Plasma

Xin Liu¹, Junwei Guo², Xiaojiang Tang¹, Lianfeng Lin¹, Eric Robert³, Feng Huang^{2,3,4*}

¹College of Information and Electrical Engineering, China Agricultural University, Beijing 100083, China

²College of Science, China Agricultural University, Beijing 100083, China

³GREMI UMR7344 CNRS/Université d'Orléans, 45067 Orleans Cedex, France

⁴LE STUDIUM Loire Valley Institute for Advanced Studies, Centre-Val de Loire region, 45000 Orleans, France

Abstract

This paper mainly experimentally studies the imidacloprid degradation in an atmospheric dielectric barrier discharge (DBD) plasma. The effects of DBD discharge parameters, temperature and initial concentration on the degradation ratio were investigated with the help of high-performance liquid chromatography (HPLC). The analyses of HPLC-MS (mass spectrometry) and the comparison with database proved that after plasma treatment four new degradation products were generated. It shows that plasma treatment can effectively degrade imidacloprid and the degradation effect depends on the initial concentration of imidacloprid as well as discharge voltage and treatment time. Under the proper plasma parameters, the degradation ratio can be up to 98%. The increase in temperature caused by plasma discharge only affected the degradation ratio by a few percent, which is negligible compared to that by plasma itself. These results show that low temperature plasma has the potential to be an effective imidacloprid degradation method.

Keywords: imidacloprid, low temperature plasma, degradation

Introduction

Pesticides play an important role in preventing crop diseases, pests, rodents, etc., and promoting high-quality and high-yield crops. With the increase in the production and consumption of pesticides year by year, the exposure of pesticide leaves to the environment also increases, which inevitably leads to an increase in the risk of humans being harmed by pesticides. The common characteristics of pesticides are their stable

properties, high toxicity and biological aggregation [1-2]. Usually, the utilization ratio of pesticides is low, and most of the pesticides will remain in the environment and enter the soil and water through precipitation, surface runoff, soil leaching [3] and will accumulate in crops and aquatic organisms, and enter the human body through the food chain [4]. Thus, exploring the effective pesticide degradation methods is crucial for environmental protection and human health.

In recent years, there are two mainstream methods about pesticide degradation: physical adsorption and chemical oxidation. The former uses special adsorbents including granular activated carbon and amino functionalized silica nano hollow spheres which have

*e-mail: huangfeng@cau.edu.cn

large specific surface area and then pesticide will be removed from solution by solid-liquid separation [5]. The latter is relatively more efficient for the treatment of pesticide in water including chlorine oxidation process [6], photocatalytic degradation [7], fenton oxidation [8] and activated persulfate [9], but these methods may cause second pollution. In addition, some of the microbial degradation methods were also been reported [10], however, because of the difference between microbial medium and actual agriculture field's environment, these biodegradation methods are basically restricted in laboratory environment [11].

Low-temperature plasma technology is a new pollutant degradation technology that integrates physical and chemical methods with electrons, ions, free radicals and other active species, which interact with organic pollutant molecules and finally degrade them to non-toxic or less toxic small molecules. Spraying pesticide in the form of liquid aqueous solution is one of the common uses of pesticide. The degradation of pesticides in aqueous solution can be conducted by plasma treatment in atmospheric environment through the delivery to aqueous solution of the reactive species including various It should be RONS (reactive oxygen and nitrogen species), such as OH radicals, superoxide, O_2^- , H_2O_2 , atomic O, atomic N, O_3 , NO_x , HNO_x , UV radiation, etc. [12], which attack the chemical bonds of pesticide or reacts with pesticide ingredients. The type of degraded pesticide is highly dependent on the concentrations of plasma-generated ROS and RNS [13-16]. Plasma degradation of pesticide has the characteristics of short treatment time and good treatment effect. The study of Li et al. [17] showed that the degradation of phenol in wastewater by plasma can improve biodegradability of wastewater. The study [18] showed that plasma discharge can cause 82.7% degradation ratio of nitenpyram pesticide. The result [19] showed that 73.6% of the residues of phoxim in grape could be reduced by plasma activated water with improving the quality of grapes.

In various plasma discharge methods, DBD discharges can be conveniently operated in a simpler way than with other alternatives (such as low pressure discharges, fast pulsed high pressure discharges, etc.) over a wide temperature and pressure range. It is very flexible in the selection of geometrical configuration, operating medium and operating parameters. Efficient low cost power supplies are available up to very large powers [20]. A prominent feature is that condition optimized in laboratory experiments can easily scaled up large industrial installations [20, 21]. It can produce a large number of active substances in a large discharge area, which can significantly improve the pesticide degradation efficiency. In addition, wastewater treatment is also one of the important industrial applications of DBD plasma [22].

Imidacloprid is the commonly used pesticide in agricultural planting, which has the characteristics of high efficiency, easy absorption, long residual time,

potent contact killing and low biodegradability [23, 24], so it poses a great threat to human health [25-27]. Therefore, carrying out the degradation investigation of imidacloprid in water is essential to solve the problem of imidacloprid residue in agricultural planting. In this paper, the degradation of imidacloprid in water by DBD plasma is studied, the degradation ratio of imidacloprid is detected by high performance liquid chromatography (HPLC), and the degradation products are analyzed with the help of HPLC-MS measurement.

Experimental Method

The imidacloprid used in this experiment is from Shandong Fuyi Pharmaceutical Co., LTD. The imidacloprid water solutions were obtained with different concentrations (0.1-500 mg/L) for plasma treatment. The concentration of imidacloprid before and after plasma degradation was measured by HPLC (Shimadzu LC-20A). In this paper, 1.5 mL of the imidacloprid solution was taken, filtered with the 0.22 μ m aqueous filter, and then transferred into a chromatographic bottle for testing. The Oceanpak C18 column (250 mm \times 4.6 mm, 5 μ m) is from Tianjin Biaoshiqi Technology Development Co., LTD. The mobile phase is methanol, acetonitrile and ultrapure water (with the ratio of 55:20:25) in isocratic elution. The detection wavelength is 260 nm. The column temperature was 40°C. The injection volume was 20 μ L with the flow ratio 1mL/min.

Fig. 1 shows the DBD plasma device consisting of two circular aluminum plate electrodes with the thickness of 16 mm, the outer diameter of 56 mm and the spacing of 25 mm, and the lower electrode is grounded. A borosilicate container (with a diameter and height of 58 and 21 mm, respectively) with 20 mL imidacloprid aqueous solution is placed between the upper and lower electrodes with a cover to seal it during plasma treatment. An oscilloscope (Tektronix TBS 1102B) and a voltage probe (Tektronix TPP0101) were used to measure the discharge voltage. The discharge current waveform is measured through a resistor connected in a series with the ground electrode.

Fig. 2 is the discharge voltage and current waveforms with the V_{pp} of 30, 45 and 60 kV, respectively. The discharge voltage applied to the electrodes is a sine waveform with the frequency of 9.4 kHz. The current waveforms show the typical filamentary ac discharge and there are one or more discharges in half of the voltage cycle. The higher discharge voltage, the more and the stronger current peaks appear in the rise edge of voltage cycle. As the discharge voltage increases from 30, 45 to 60 kV, the discharge power increases from 21, 53 to 81 W with the measurement through Lissajous plot, by plotting the total charge on a sampling capacitor versus the applied voltage on electrodes.

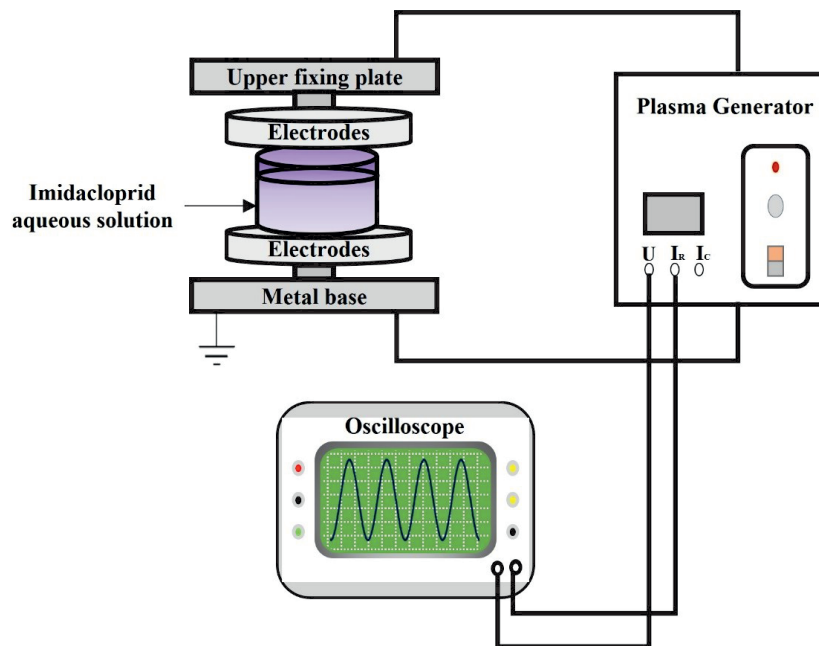

Fig. 1. Experimental setup.

Results and Discussion

Imidacloprid is a highly polar pesticide and has a certain solubility in water and can be retained on C18 chromatographic column with a discrimination peak shape in HPLC measurements. Fig. 3 shows the chromatogram peaks of different concentrations of

imidacloprid in HPLC measurements and the linear fitting of imidacloprid concentration and its peak areas. From Fig. 3a), one can see that imidacloprid has a characteristic peak at the retention time of 3.072 min, and for different concentrations of imidacloprid both the peak height and area are different. The linear fitting of imidacloprid concentration and its peak area is shown

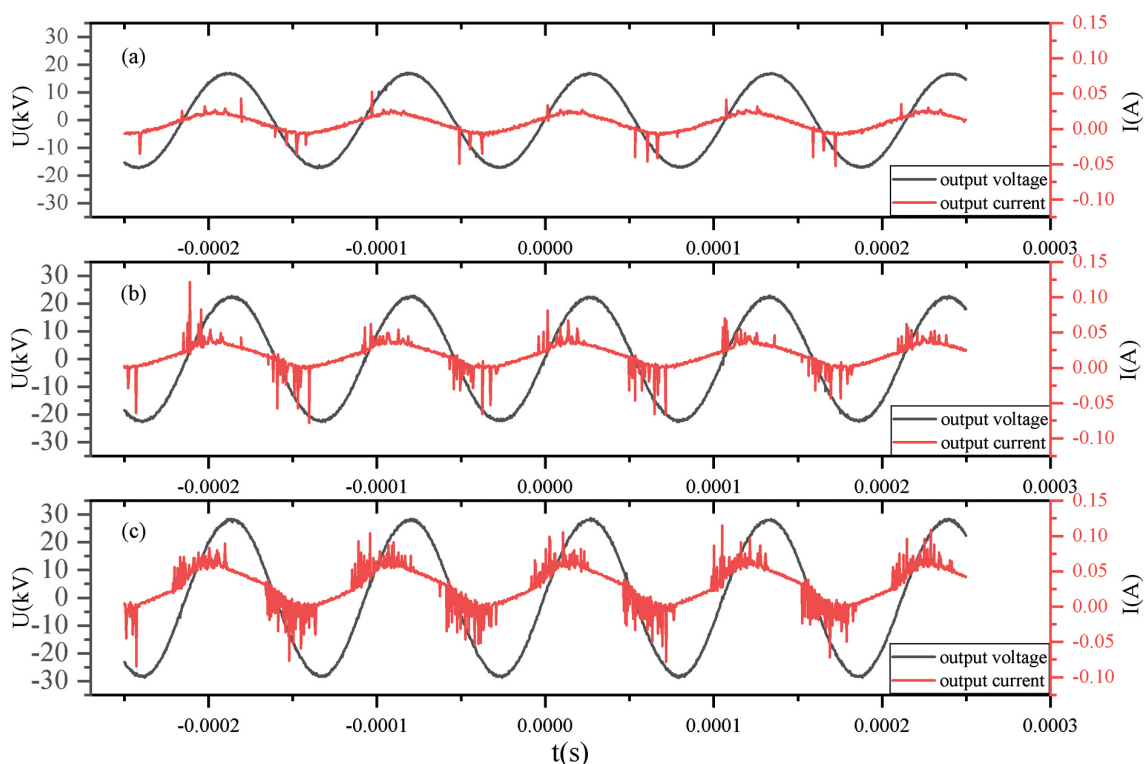

Fig. 2. The output voltage and current curve of a) 30 kV, b)45 kV and c)60 kV.

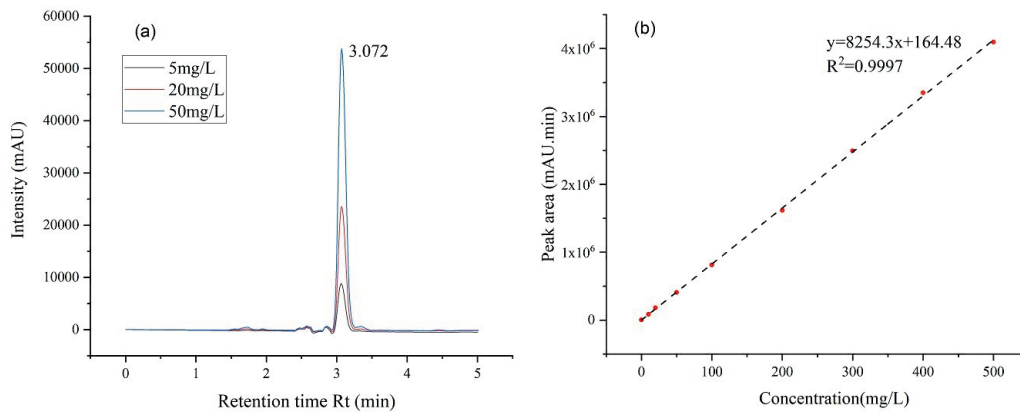

Fig. 3. The overlapping chromatogram peaks for different concentrations of imidacloprid a) and the linear fitting of imidacloprid concentration and its peak area b).

in Fig. 3b). The fitting line is through the zero point of coordinates with the correlation coefficient R^2 of 0.9997 (close to 1), showing a good linear distribution. This linear relationship will be used to measure the concentration change of imidacloprid in water before and after plasma treatment.

One should consider that during plasma treatment the temperature increases with discharge voltage and treatment time due to the energy fed into the treated solutions. Thus, the temperature of the solution before and after plasma treatment was measured with a thermometer inserted at the distance of 2 cm from the liquid surface. Table 1 shows the temperature increases with discharge voltage and treatment duration. In this experiment, temperature can rise from 17.5°C to 60.9°C with the following treatment parameters. Then a question needs to be addressed, that is, how does the increasing temperature affect the degradation effect of imidacloprid?

In order to verify whether the temperature increase would have an impact on the degradation ratio of

imidacloprid, we gradually increased the temperature in imidacloprid water solution without plasma treatment, which is shown in Table 2. It shows that as the increase of temperature from 20 to 60°C, the degradation ratio gradually increases, but the increase is small. For example, at 60°C the degradation ratio is only 6.55%, which indicates that during plasma treatment within the above discharge parameters, temperature only contributes a few percent to imidacloprid degradation ratio, showing the relative stability of imidacloprid at 20-60°C. This is in agreement with the studies on the hydrolysis kinetics of imidacloprid at different temperatures, showing that imidacloprid is stable in acidic and neutral water [28, 29]. Next, the research on the effect of plasma treatment on the degradation ratio of imidacloprid will be carried out with considering the effects of different discharge voltages, treatment time and initial concentrations.

First, the effect of plasma discharge voltage on degradation ratio was studied with the initial concentration and the treatment time kept as constant (68.79 mg/L and 3 min). Fig. 4 shows the change of the chromatogram peak, degradation ratio and pH value of the imidacloprid solution before and after plasma treatment for different discharge voltages. Fig. 4a) shows that the area and height of imidacloprid characteristic peak at the retention time $R_t = 3.072$ min gradually decrease versus discharge voltage. At the

Table 1. Temperature change under different plasma treatment parameters.

Concentration (mg/L)	Parameters		Temperature (°C)
0	Untreated		17.5
68.79	3 min	30 kV	29.8
		45 kV	42.1
		60 kV	60.9
	45 kV	1 min	34.9
		3 min	42.1
		5 min	54.2
141.14	45 kV	1 min	34.3
		3 min	55.6
		5 min	60

Table 2. The effect of temperature on the degradation ratio of imidacloprid.

Temperature (°C)	Concentration (mg/L)	Degradation ratio (%)	Standard deviation (%)
20	54.14	\	\
30	51.42	5.02	0.06
45	51.21	5.41	0.04
60	50.59	6.55	0.18

same time, as can be seen that there is obviously new peak appearing at the retention time $R_t = 2.685$ min, which was not present in the untreated imidacloprid solutions, and the new peak is associated with imidacloprid byproduct following plasma treatment. Fig. 4b) shows that the peak areas at $R_t = 3.072$ and 2.685 min exhibit completely opposite trends versus discharge voltage. Specifically, with 60 kV treatment for 3 min, the peak area of $R_t = 3.072$ min decreases from 6×10^5 to 3×10^4 , while that of the new peak at $R_t = 2.685$ min increases from 0 to 2.1×10^5 , showing new product formation accompanied by the degradation. According to the linear relationship of imidacloprid concentration and the peak area Fig. 3, the degradation ratio can be calculated. Fig. 4c) shows that the degradation ratio increases with discharge voltage. This is because that with the increase of voltage, DBD plasma will produce more active substances, which can more fully react with imidacloprid and reduce imidacloprid concentration [30-32]. Specifically, when the discharge voltage increases to 30 kV, the degradation ratio significantly increases to

62.15% , then the increasing slope becomes smaller from 30 to 60 kV. At 60 kV, the degradation ratio is about 95.38% . In addition, Fig. 4b) also shows that pH value decreases with the increase of discharge voltage. pH is the measure of hydrogen ion concentration in aqueous solution. The decrease of pH value is mainly due to the product of the acidification of aqueous liquids through plasma reaction, as the result of the generation of hydrogen, peroxides, nitric acid, and peroxyntrous acid [33]. In addition, during plasma treatment within 0 - 60 kV the temperature increases from 17.5 to 60.9°C and this temperature range contributes little (the maximum of being only a few percent) to imidacloprid degradation, which indicates that plasma itself is the main contributor to the degradation of imidacloprid.

Fig. 5 shows the effect of plasma treatment time on imidacloprid degradation at 45 kV and the initial concentration of 68.79 mg/L. Fig. 5a) shows that the characteristic peak at $R_t = 2.685$ min does not appear without plasma treatment, i.e., this new peak appears after plasma treatment. The longer the treatment time, the larger the area and the stronger the peak intensity

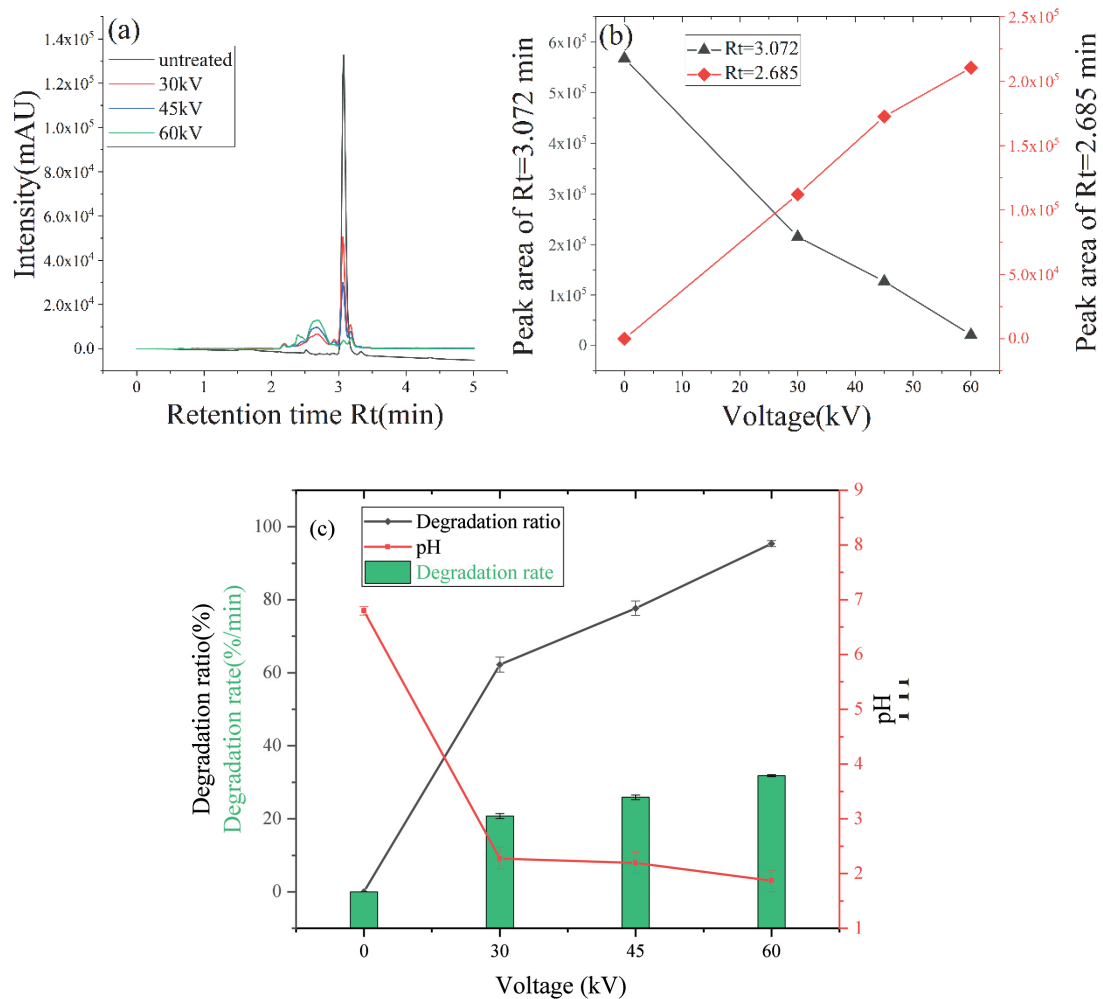

Fig. 4. Comparison of degradation ratio under different discharge voltages with 3 min and the initial concentration of 68.79 mg/L: a) the chromatograms peaks of imidacloprid at different discharge voltages; b) the peak areas of $R_t = 3.072$ and 2.685 s change as discharge voltage; c) the degradation ratio, degradation rate and pH value change as discharge voltage.

of the new peak, indicating that plasma treatment duration can influence the concentrations of imidacloprid and the degradation products. Fig. 5b) shows the detailed change of the peak areas of $R_t = 3.072$ and 2.685 min with treatment duration. Obviously, the two peak areas show the opposite trends versus the treatment duration. After 5 minutes of continuous treatment at 45 kV, the peak area of $R_t = 3.072$ min decreased to about 2% of the original. While that of 2.685 min gradually increase within 5 min.

Fig. 5c) shows the degradation ratio significantly increases with increase of the treatment duration time, which is due to that more active species can be produced by appropriately prolonging the treatment time of plasma, resulting in the enhanced interactions between the active species and the treated pesticides [34]. The degradation ratio is about 98% after 5 min treatment with 45 kV, which shows plasma degradation is highly efficient. In addition, as treatment is going on, within the same time interval, the gradually decreased total amount of imidacloprid causes the decreased degradation rate (shown by the green bars in Fig. 5c)). Fig. 5c) also shows that as the treatment duration going on, pH decreases rapidly to a low value in the first minute and then decreases slowly. The drastically decreased pH in the first treatment minute is

due to the quick formation of strong acids, i.e. the quick reactions taking place by the active species in plasma result in the quick acidification of the solution.

Initial concentration also can influence the degradation effect. Fig. 6 shows the comparison of imidacloprid degradation ratio under the initial concentrations of 68.79 and 141.14 mg/L at the treatment voltage of 45 kV under different treatment duration time. It is seen that with the same treatment duration time, the higher the initial concentration, the lower the degradation ratio. With the increase of treatment time, the difference between the two degradation ratios is getting smaller and smaller. For example, with 1 min treatment, the degradation ratio of 68.79 and 141.14 mg/L are 32.9% and 7.52% (decreased by 77.14%). For 3 min treatment, the two degradation ratios are 77.8% and 47.66% (decreased by 38.74%). When the treatment time increases to 5 min, the degradation ratios at these two concentrations are very close, that is 98.64% and 96.51% (only decreased by 2.16%). These results show that the lower the initial concentration, the faster the degradation. This is because when the discharge voltage is constant, the number of active species, which are generated by plasma discharge and contribute to imidacloprid degradation, is constant in a time unit. For the same treatment time, the lower the concentration of

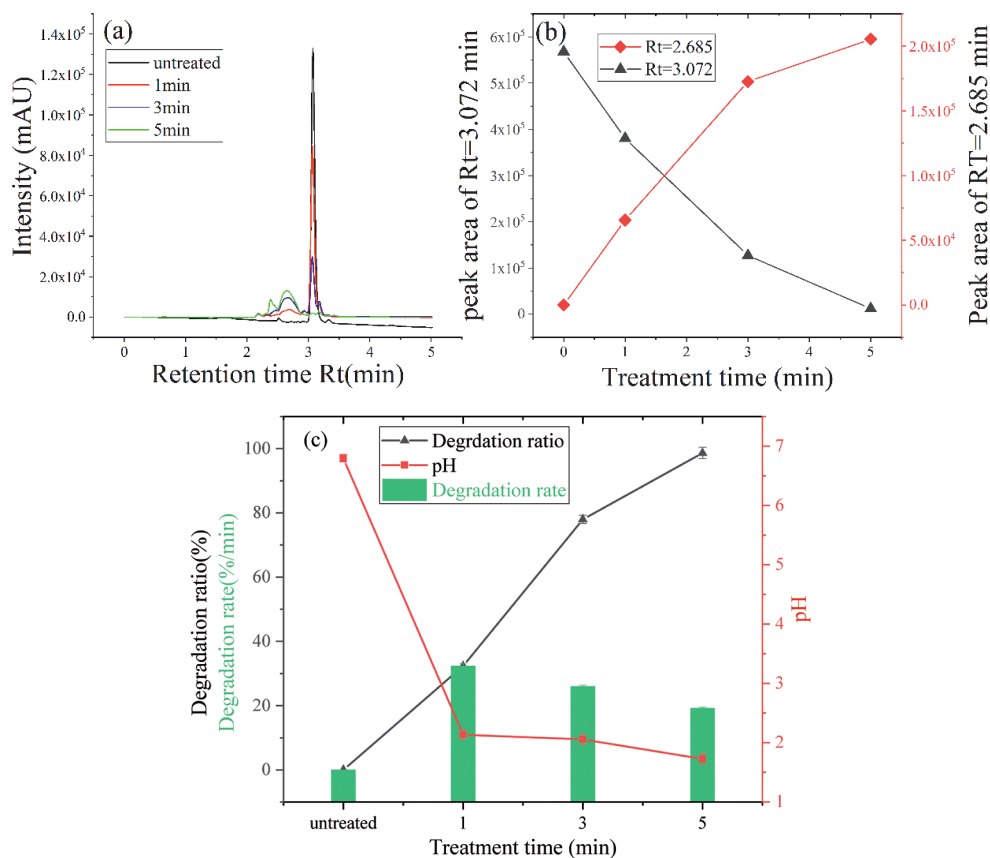

Fig. 5. Comparison of imidacloprid degradation ratio under different treatment times with the discharge voltage of 45 kV and the initial concentration of 68.79 mg/L: a) the chromatograms peaks; b) the peak areas of $R_t = 3.072$ and 2.685 ; c) the degradation ratio, degradation rate and pH value.

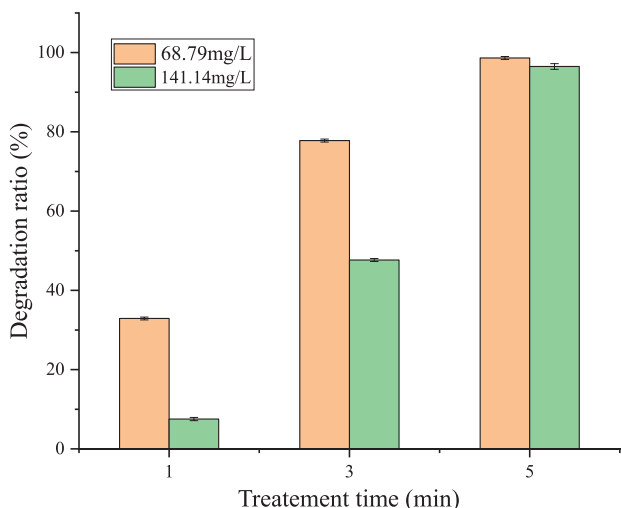

Fig. 6. Comparison of imidacloprid degradation ratio with 45 kV under different initial concentration of 68.79 mg/L and 141.14 mg/L.

imidacloprid, the more fully reaction of plasma active species and imidacloprid, so the higher the degradation ratio. In addition, as the treatment time increases, the number of plasma active species also increases. When the treatment time is sufficient, there are enough active species to degrade imidacloprid (even at high concentrations), resulting in high degradation ratio (or even 100%) at both low and high initial concentrations. It is why both the degradation ratios of 68.79 and 141.14 mg/L are higher and closer under the 5 min treatment than for shorter treatment duration.

According to the above results, it has been confirmed that plasma treatment leads to a high degradation ratio for imidacloprid, but when

comprehensively evaluating the degradation of plasma on imidacloprid in water, one cannot only focus on the degradation ratio, and degradation products should also be concerned. HPLC/MS is an analytical technique that combines liquid chromatography separation methods and mass spectrometry for more accurate quantitative and qualitative analysis. During the measurement, the imidacloprid sample is injected in the liquid chromatography system and separated by the chromatographic column. The separated components flowing out of the chromatograph enter the ion source of the MS instrument through the interface to be ionized, and then the ions are focused in the mass analyzer, separated according to the mass-to-charge ratio, and the separated ion signal is converted into an electrical signal, which is sent to the data processing system for qualitative and quantitative analysis. HPLC/MS embodies the complementary advantages of chromatography and mass spectrometry with providing relative molecular mass, molecular structural information, relative abundance, etc. for imidacloprid degradation product analysis. Therefore, HPLC/MS was selected to analyze imidacloprid degradation products in this paper. When the imidacloprid solutions under different plasma treatments were measured by HPLC/MS and the measurement conditions of HPLC/MS were kept the same, which ensured that the degradation products of imidacloprid were not affected by the measurement methods including the ion source of MS.

Fig. 7 shows the chromatogram peak comparison of imidacloprid solutions before a) and after plasma treatment at 45 kV and 3 min with 1 mg/L b). Fig. 7a) shows that the retention time of imidacloprid on the HPLC/MS measurement is about 6.13 min and the response value i.e. nominal level (NL) is 1.30E8. Here,

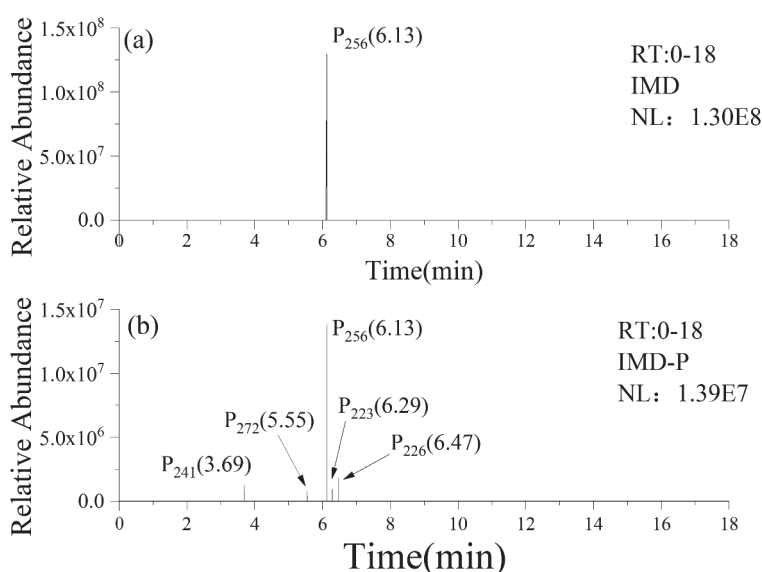

Fig. 7. Liquid chromatograms of imidacloprid a) before and b) after plasma degradation (45 kV with 3 min), figures in brackets indicate specific time.

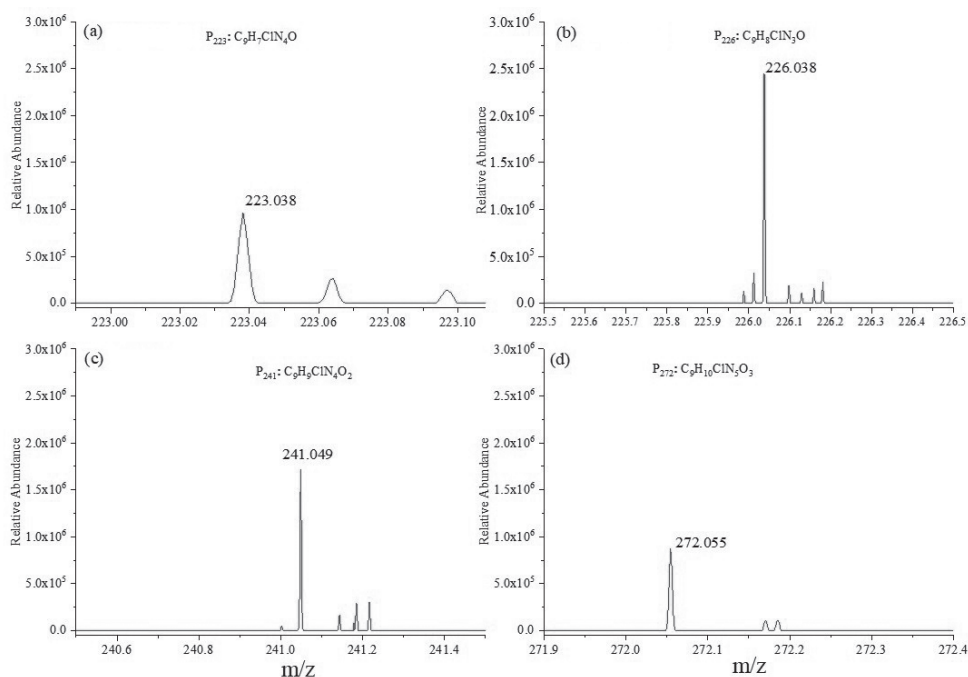

Fig. 8. Mass spectra of imidacloprid intermediates.

the different retention time from Fig. 4 and Fig. 6 is due to the different chromatography column and the flowing phase used in the measurement of HPLC/MS. After plasma degradation, the NL became 1.38E7. Comparing Fig.7(a,b), it can be found that after plasma treatment the four distinct chromatographic peaks appear at 3.691, 5.559, 6.295, and 6.472 min. According to the four retention times and from the Chemspider database, the relevant information (including the relative molecular mass, peak area, etc.) of the four degradation products was obtained. Then the corresponding mass spectra of the four degradation products were obtained, shown in Fig. 8. It is seen that the mass/charge (m/z) ratios of the four degradation products are 223.038, 226.038, 241.049 and 272.055 (named P_{223} , P_{226} , P_{241} and P_{272}), respectively. From Fig. 8, it was also found that the peak with strongest relative abundance is from P_{226} indicating that the mass/charge of plasma degradation product are mainly 226.038.

The main data by the HPLC/MS measurement on the imidacloprid degradation products are summarized

in Table 3. From the chromatograph peak area of before and after plasma treatment, it is easily known that the degradation ratio was nearly 90% indicating the effectiveness of plasma degradation. Table 3 also shows that the formation of the four degradation products (P_{223} , P_{226} , P_{241} , P_{272}) is from the lost or added atoms of H, N and O, which is mainly due to the fact that C-H, C-N, N-N chemical bonds are broken and the hydroxyl radical and oxygen free radicals replace the original H, N and other atoms during the degradation process by atmospheric plasma discharge of imidacloprid aqueous solution [35]. During the degradation, the use of oxygen, nitrogen and water to conduct atmospheric plasma discharge and the chemical reactions taking place during plasma discharge result in the formation of a number of RONS species [36, 37], among which hydroxyl radical and oxygen radical may play a major role in the degradation of imidacloprid [31, 32]. For example, during plasma discharge, when the C-H bond on some active sites in imidacloprid molecule is broken, the hydroxyl radical replaces the original

Table 3. The product list of imidacloprid degradation by plasma.

No	Retention time	Chemical Formula	m/z	Lost/Add Atom	Chromatograph peak area
0	6.138	$C_9H_{10}ClN_5O_2$	256.06	\	4.18E8 (before)
1	6.138	$C_9H_{10}ClN_5O_2$	256.06	\	4.46E7 (after)
2	6.295	$C_9H_7ClN_4O$	223.038	-(H ₃ N O)	3.18E6
3	6.472	$C_9H_8ClN_3O_2$	226.038	-(H ₂ N ₂)	7.26E5
4	3.691	$C_9H_9ClN_4O_2$	241.049	-(H N)	5.15E6
5	5.559	$C_9H_{10}ClN_5O_3$	272.055	+O	2.14E6

H to form the degradation product of P₂₇₂. When imidacloprid reacts with the combination of oxygen free radicals and water, and after hydrogen peroxide and nitrogen are removed, the degradation product of P₂₂₆ will be formed [30].

Conclusions

The degradation of imidacloprid in water by DBD plasma was studied in this paper and the degradation ratio was used to characterize the degradation effect of plasma. The concentrations of imidacloprid before and after plasma degradation were detected by high performance liquid chromatography. The results showed that the increase of temperature during plasma treatment contributes little to degradation ratio, and the higher discharge voltage with longer treatment time will cause the higher degradation ratio. Under the same plasma treatment parameters, the higher the initial concentration of imidacloprid, the lower the degradation ratio. The degradation products of imidacloprid were also analyzed by the HPLC/MS measurement. This research provides an experimental basis for plasma degradation of imidacloprid pesticides in water.

Conflict of Interest

The authors declare no conflict of interest.

References

1. HUA X.M., JIANG X.L. Characteristics and control countermeasures of pesticide pollution and its damage on environment in China. *Research of Environmental Sciences*. **13**, 40, **2000** [In Chinese].
2. FENIK J., TANKIEWICZ M., BIZIUK M. Properties and determination of pesticides in fruits and vegetables. *TrAC Trends in Analytical Chemistry*. **30**, 814, **2011**.
3. HE X., MA Y.F., ZHAO H.X., NIE X.J. Simultaneous determination of 24 pesticide residues in environmental water using solid-phase extraction and high performance liquid chromatography-tandem mass spectrometry. *Journal of Instrumental Analysis*. **36**, 1487, **2017** [In Chinese].
4. GOLGE O., KABAK B. Determination of 115 pesticide residues in oranges by high-performance liquid chromatography-triple-quadrupole mass spectrometry in combination with QuEChERS method. *Journal of Food Composition and Analysis*. **41**, 86, **2015**.
5. ELHUSSEIN E.A.A., ŞAHIN S., BAYAZIT Ş.S. Preparation of CeO₂ nanofibers derived from Ce-BTC metalorganic frameworks and its application on pesticide adsorption. *Journal of Molecular Liquids*, **255**, 10, **2018**.
6. YANG L., ZHANG Z. Degradation of six typical pesticides in water by VUV/UV/chlorine process: Evaluation of the synergistic effect. *Water Research*, **161**, 439, **2019**.
7. PATIL P.N., GOGATE P.R. *Handbook of ultrasonics and sonochemistry*, Springer, Singapore, 901, **2016**.
8. SAINI R., KUMAR M. M., KUMAR P. Fenton oxidation of pesticide methyl parathion in aqueous solution: kinetic study of the degradation. *Environmental Progress & Sustainable Energy*, **36**, 2, **2017**.
9. HAYAT W., ZHANG Y., HUSSAIN I., HUANG S., DU X. Comparison of radical and non-radical activated persulfate systems for the degradation of imidacloprid in water. *Ecotoxicology and Environmental Safety*, **188**, 109891, **2020**.
10. GUO L.L., DAI Z., GUO J.J., YANG W.L., GE F., DAI Y.J. Oligotrophic bacterium *hymenobacter latericoloratus* CGMCC 16346 degrades the neonicotinoid imidacloprid in surface water. *AMB Express*. **10**, 1, **2020**.
11. PANG S.M., LIN Z.Q., ZHANG Y.M., ZHANG W.P., NASSER A., SANDHYA M., PANKAJ B., CHEN S.H. Insights into the toxicity and degradation mechanisms of imidacloprid via physicochemical and microbial approaches. *Toxics*. **8**, 0065, **2020**.
12. BHAGIRATH G., GEON L., SOHAIL M., EUN C. Scavenging effects of ascorbic acid and mannitol on hydroxyl radicals generated inside water by an atmospheric pressure plasma jet. *AIP Advances*. **8**, 075021, **2018**.
13. DAVID M., CHRISTIAN R., MARTIN J., KARL L., JORG D., UWE H. Evaluation of advanced oxidation processes for water and wastewater treatment - A critical review. *Water Research*. **139**, 118, **2018**.
14. XU H.B., MA R.N., ZHU Y.P., DU M.R., ZHANG H., JIAO Z. A systematic study of the antimicrobial mechanisms of cold atmospheric-pressure plasma for water disinfection. *Science of the Total Environment*. **703**, 134965, **2020**.
15. NGUYEN V., HO Q., PHAM.V., NGUYEN V., KIM L. Treatment of surface water using cold plasma for domestic water supply. *Environmental Engineering Research*. **24**, 412, **2019**.
16. AZADEH B., ZOHREH D., PRADEEP L., NEHA K., EUN C., NAGENDRA K. Recent progress in applications of non-thermal plasma for water purification, bi-sterilization, and decontamination. *Applied Science*. **11**, 3372, **2021**.
17. LI H.J. Study on Phenol removal of wastewater by non-equation plasma. Guangdong University of Technology. **2006** [master thesis, in Chinese].
18. LI S.P., CUI J.J., JIANG Y.Y., FANG H.C. Study of using low-temperature plasma to degrade nitenpyram pesticide in aqueous solution. *High Voltage Engineering*. **37**, 10, **2011** [In Chinese].
19. ZHENG Y.P., WU S.J., DANG J., WANG S.F., LIU Z.X. FANG J., HAN P. ZHANG J. Reduction of phoxim pesticide residues from grapes by atmospheric pressure non-thermal air plasma activated water. *Journal of Hazardous Materials*. **377**, 98, **2019**.
20. KOGELSCHATZ U., ELIASSON B., EGLI W. Dielectric-barrier discharges: principle and applications. *Le Journal de Physique IV*. **7**, C4, **1997**.
21. KOGELSCHATZ U. Dielectric-barrier discharges: their history, discharge physics, and industrial applications. *Plasma Chemistry and Plasma Processing*. **23**, 1, **2003**.
22. MOK Y.S., JO J.O., WHITEHEAD J.C. Degradation of an azo dye Orange II using a gas phase dielectric barrier discharge reactor submerged in water. *Chemical Engineering Journal*. **142**, 1, **2008**.
23. PANKAJ P., SAYLI B., PARAG G. Degradation of imidacloprid using combined advanced oxidation processes based on hydrodynamic cavitation. *Ultrasonics Sonochemistry*. **21**, 1770, **2014**.

24. HALM P., RORTAIS A., ARNOLD G., TASÉI N., RAULT S. New risk assessment approach for systemic insecticides: the case of honey bees and imidacloprid (Gaucho). *Environmental Science & Technology*. **40**, 2448, **2006**.
25. CRISTINA S., CLAUDIO Z., H'ECTOR M., MAR'IA M. Imidacloprid oxidation by photo-Fenton reaction. *Journal of Hazardous Material*. **150**, 679, **2008**.
26. TATJANA T., ANITA J., BRANKA M., POLONCA T. Hazard identification of imidacloprid to aquatic environment. *Chemosphere*. **76**, 907, **2009**.
27. AMAR P., PANKAJ P., PARAG G. Degradation of imidacloprid containing wastewaters using ultrasound based treatment strategies. *Ultrasonics Sonochemistry*. **21**, 1778, **2014**.
28. ZHENG W., LIU W.P. Kinetics and mechanism of the hydrolysis of imidacloprid. *Pesticide Science*. **55**, 482, **1999**.
29. ZHANG X.D. Adsorption and hydrolysis behavior of three kinds of neonicotinoid insecticide on soil. Hunan Agricultural University. **2016** [master thesis, in Chinese].
30. SEYYEDEH M., SOHRAB I., DAVOUD D., KAMBIZ L., MAHMOUD S. Effect of cold plasma on degradation of organophosphorus pesticides used on some agricultural products. *Journal of Plant Protection Research*. **57**, 1, **2017**.
31. FENG J.W., ZHENG Z., SUN Y.B., LUAN J.F., WANG Z., WANG L.H., FENG J.F. Degradation of diuron in aqueous solution by dielectric barrier discharge. *Journal of Hazardous Materials*. **154**, 1081, **2008**.
32. ZHAO J., CHEN J.R., GAO J. Decolorization of azo dyes C.I. Acid Yellow 17 and C.I. Direct Red 31 by dielectric-barrier discharge air plasma. *IEEE Transactions on Plasma Science*. **38**, 3, **2010**.
33. ROHIT T., ANJINELYULU K., UDAY A., KALIRAMESH S., RENALD B., RUBEN G., VASILIS V. Plasma activated water (PAW): Chemistry, physico-chemical properties. Applications in Food and Agriculture. **77**, 21, **2018**.
34. HU Y.M., BAI Y.H., LI X.J., CHEN J.R. Application of dielectric barrier discharge plasma for degradation and pathways of dimethoate in aqueous solution. *Separation and Purification Technology*. **120**, 191, **2013**.
35. KE L.J., LU X.Y., WANG X.Q., LI B., CHEN Z.Z., LIN X.R., WANG Y.X., ZHANG Y.Y. Degradation of imidacloprid, acetamiprid and triazophos in aqueous solution by dielectric barrier discharge low-temperature plasma. *Science and Technology of Food Industry*. **43**, 7, **2022** [In Chinese with English abstract].
36. THIRUMDAS R., KOTHAKOTA A., ANNAPURE U., SILIVERU K., BLUNDELL R., GATT R., VALDRAMIDIS V.P. Plasma activated water (PAW): chemistry, physico-chemical properties, applications in food and agriculture. *Trends in Food Science & Technology*, **77**, 21, **2018**.
37. SARANGAPANI C., MISRA N.N., MILOSAVLJEVIC V., BOURKE P., O'REGAN F., CULLEN P.J. Pesticide degradation in water using atmospheric air cold plasma[J]. *Journal of Water Process Engineering*, **9**, 225, **2016**.