



**HAL**  
open science

## Fabrication of c-axis LiNbO<sub>3</sub> Thin Film for Surface Acoustic Wave Applications

Ngoc Kim Thanh Bui, Nikolay Smagin, Zakariae Oumekloul, Rahma Moalla, William Maudez, Estelle Wagner, Giacomo Benvenuti, Marc Duquennoy, Denis Remiens, Julien Carlier

► **To cite this version:**

Ngoc Kim Thanh Bui, Nikolay Smagin, Zakariae Oumekloul, Rahma Moalla, William Maudez, et al.. Fabrication of c-axis LiNbO<sub>3</sub> Thin Film for Surface Acoustic Wave Applications. Workshop for multi-functional materials: from synthesis to applications, Jun 2023, Valenciennes, France. hal-04256597

**HAL Id: hal-04256597**

**<https://hal.science/hal-04256597>**

Submitted on 24 Oct 2023

**HAL** is a multi-disciplinary open access archive for the deposit and dissemination of scientific research documents, whether they are published or not. The documents may come from teaching and research institutions in France or abroad, or from public or private research centers.

L'archive ouverte pluridisciplinaire **HAL**, est destinée au dépôt et à la diffusion de documents scientifiques de niveau recherche, publiés ou non, émanant des établissements d'enseignement et de recherche français ou étrangers, des laboratoires publics ou privés.

# Fabrication of c-axis LiNbO<sub>3</sub> Thin Film for Surface Acoustic Wave Applications



T. Bui<sup>1,2</sup>, N. Smagin<sup>1</sup>, Z. Oumekloul<sup>1</sup>, R. Moalla<sup>2,3</sup>, W. Maudez<sup>2</sup>, E. Wagner<sup>2</sup>, G. Benvenuti<sup>2</sup>, M. Duquennoy<sup>1</sup>, D. Remiens<sup>1</sup>, J. Carlier<sup>1</sup>

<sup>1</sup> IEMN- Site de Valenciennes - CNRS UMR 8520, Université Polytechniques Hauts de France (UPHF), 144 Rue Joseph-Louis Lagrange, Technopôle Transalley, 59300 Famars, France

<sup>2</sup> 3D-Oxides, 41 rue Henri Fabre, F-01630 Saint-Genis-Pouilly, France

<sup>3</sup> INL - Institut des Nanotechnologies de Lyon, Université de Lyon, Ecole Centrale de Lyon, CNRS, UMR5270, 69134 Ecully, France

## Objective

Lithium niobate (LN) is an important dielectric and ferroelectric materials, which are widely used in acoustics, optic, and optoelectrical devices. In this study, LN thin film was deposited by CBVD method. A SAW delay line and a one-port resonator were fabricated by an e-beam lithography process to investigate the acoustic properties.

## LN thin film deposition and Characterization

Sybilla deposition equipment from ABCD Technology company

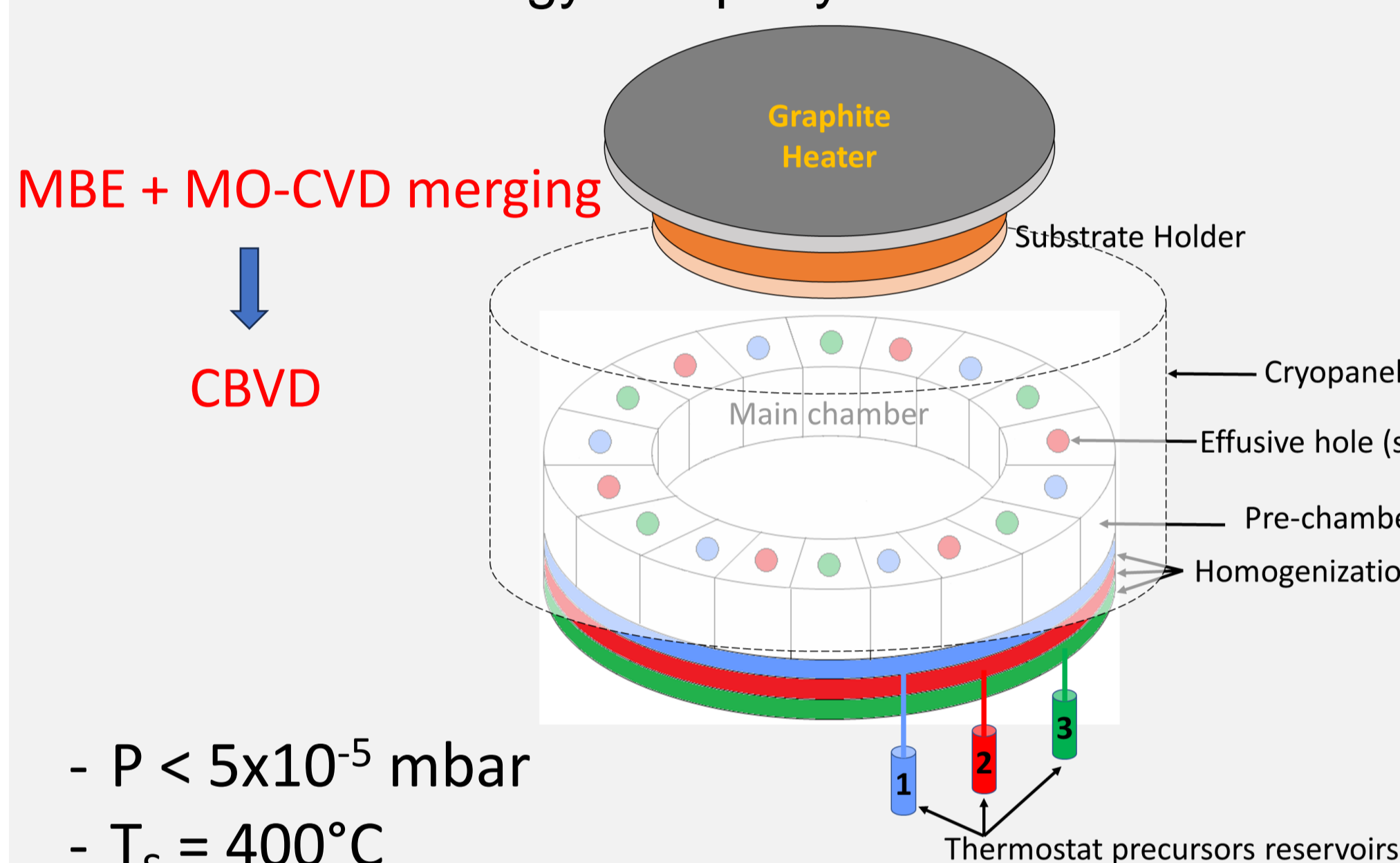

- P < 5x10<sup>-5</sup> mbar
- T<sub>S</sub> = 400°C
- Deposition time: 3 hours
- Al<sub>2</sub>O<sub>3</sub> (0001), 4 inches

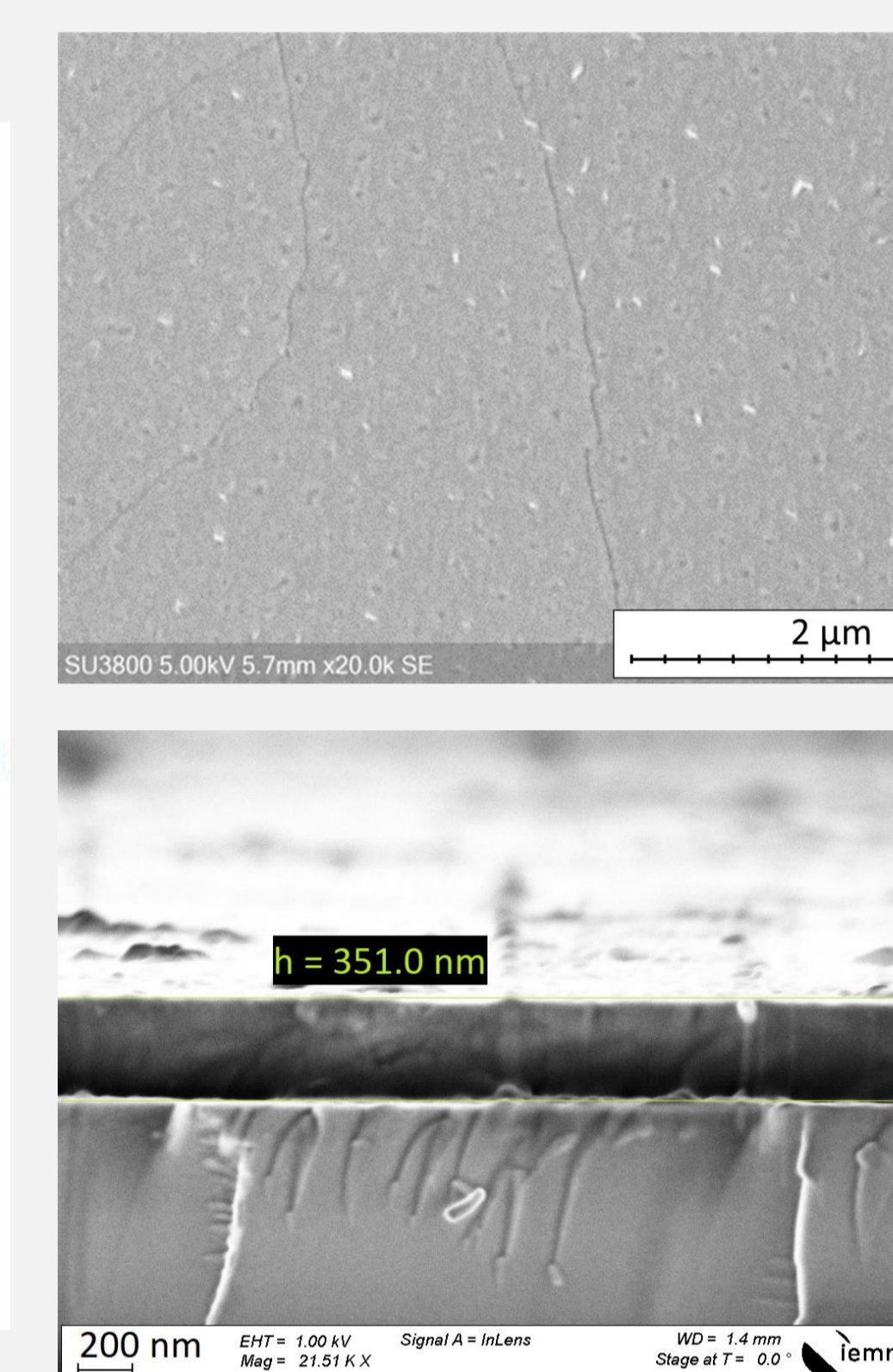
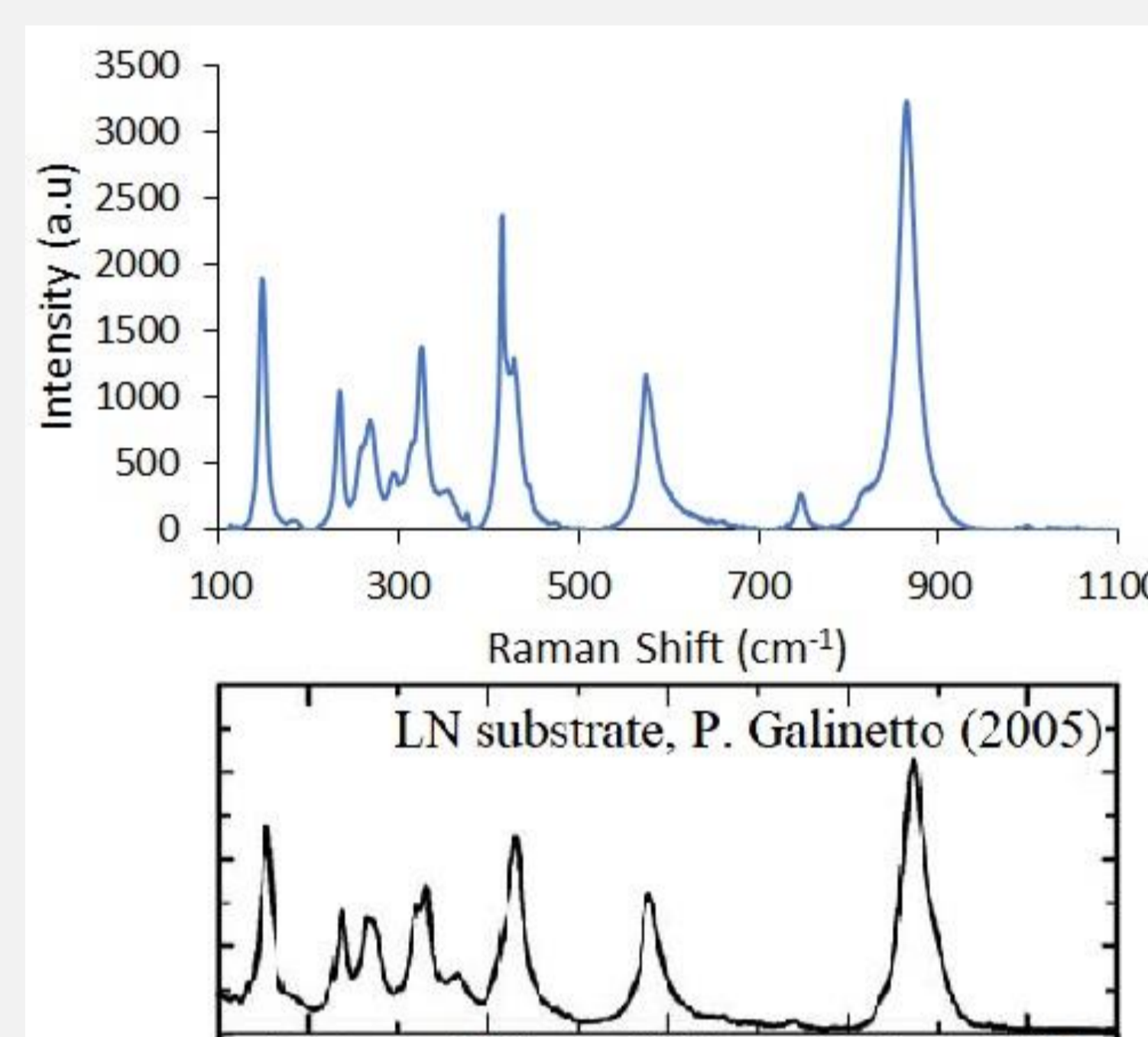
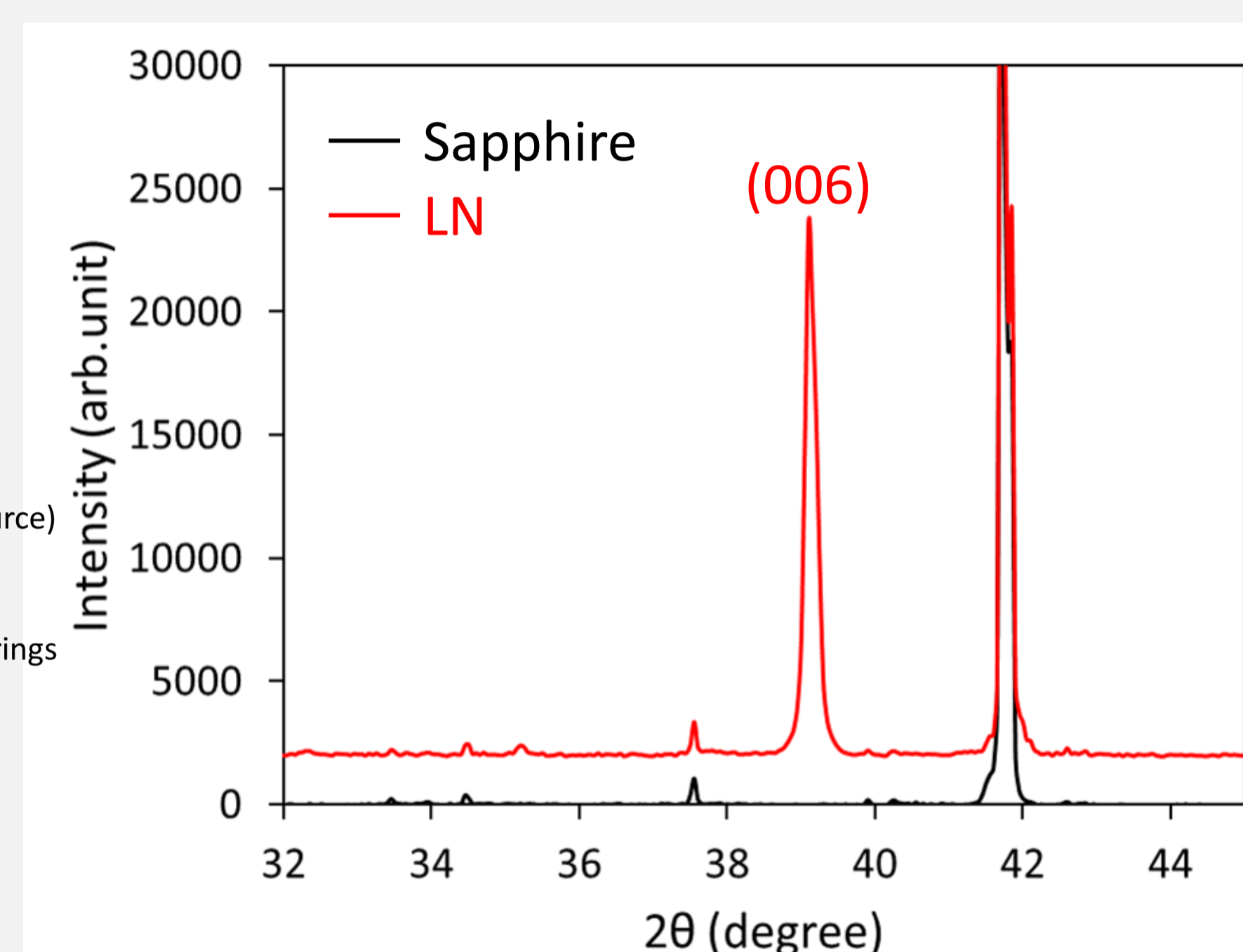

## Device Fabrication

## Acoustic Measurement

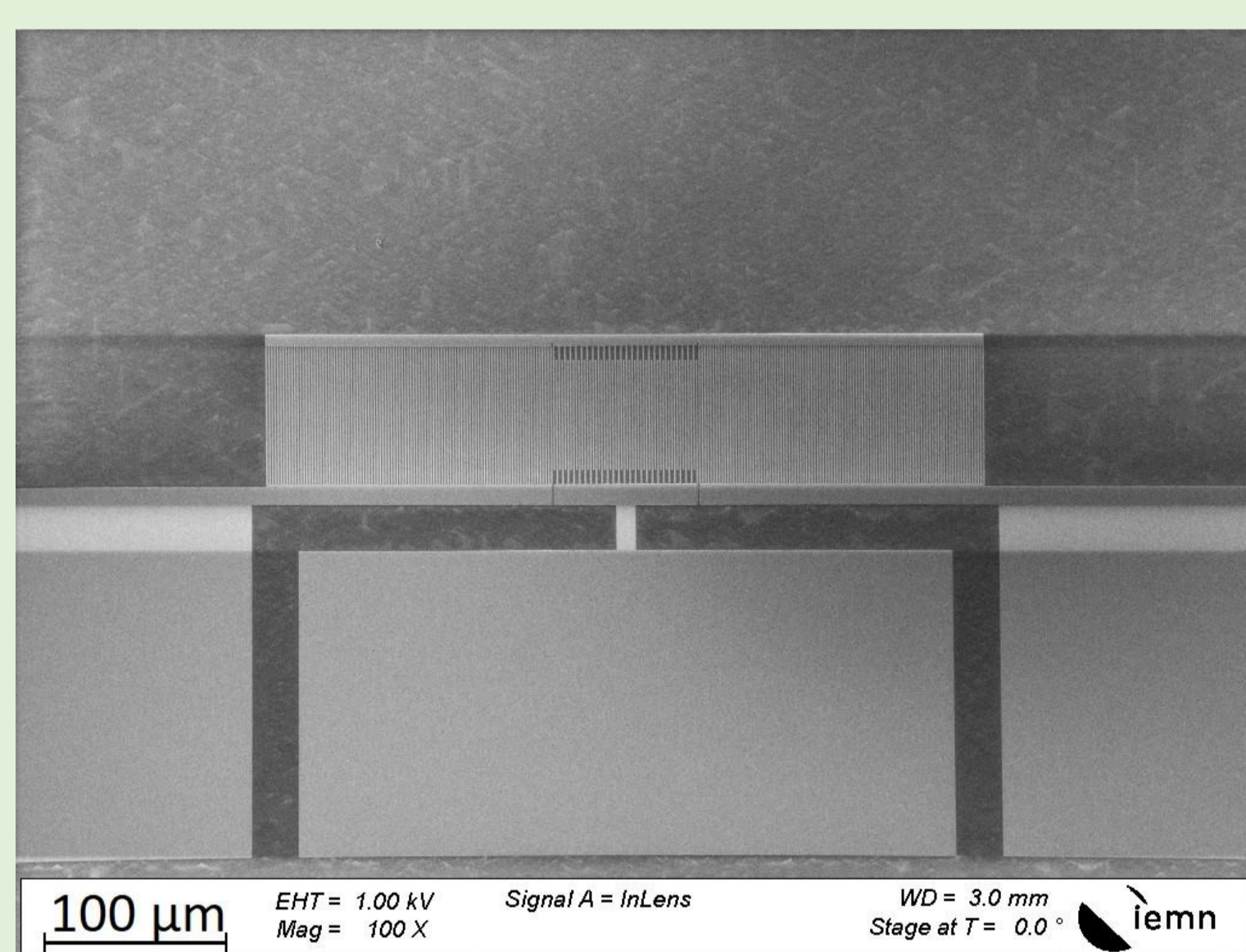
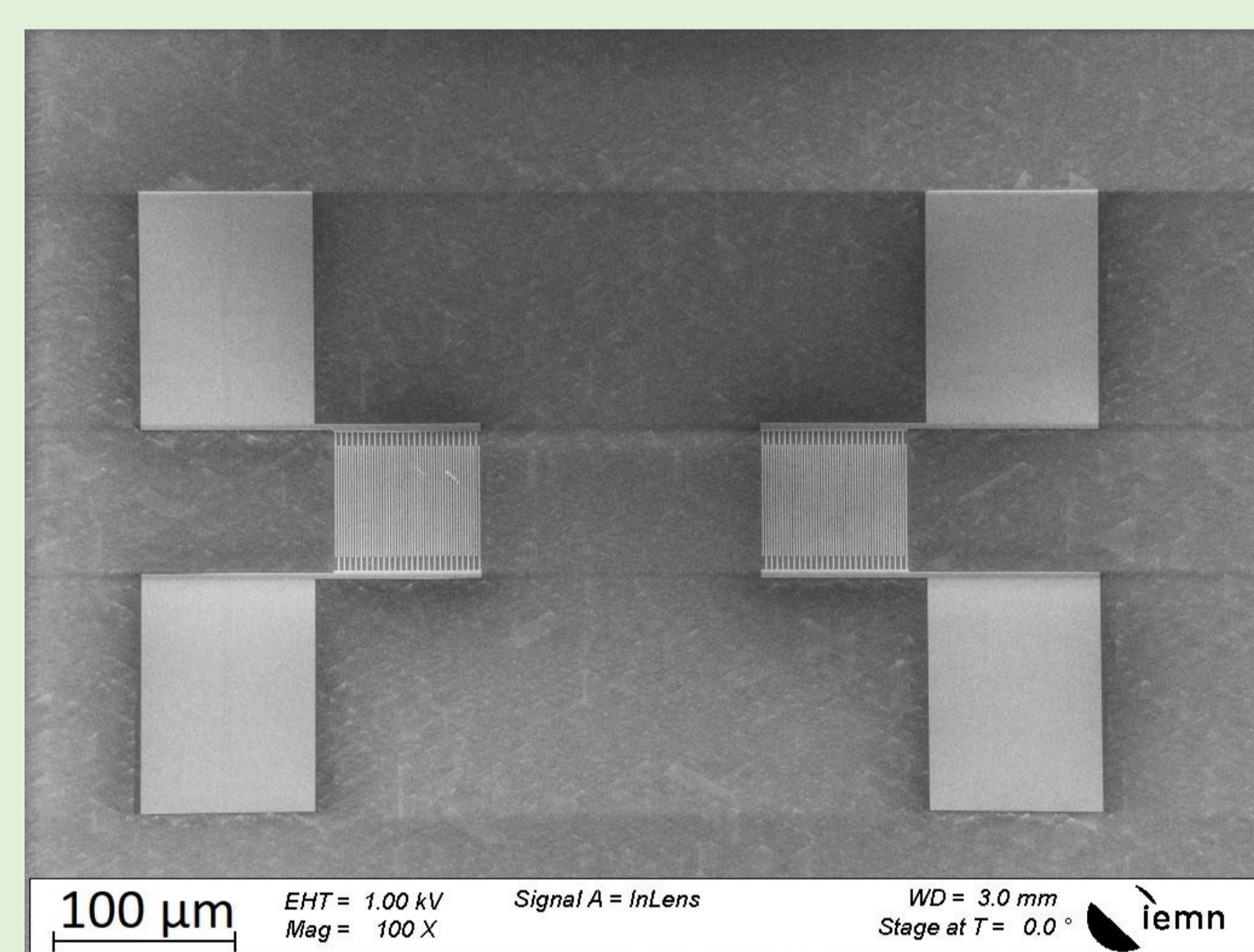
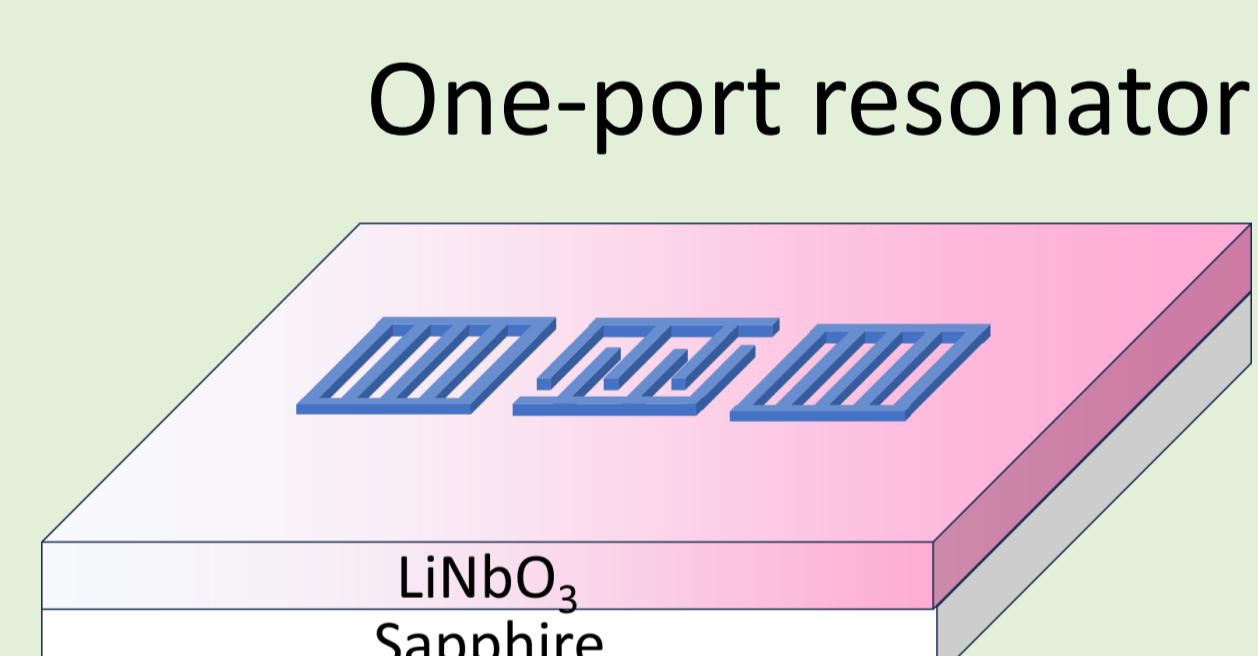
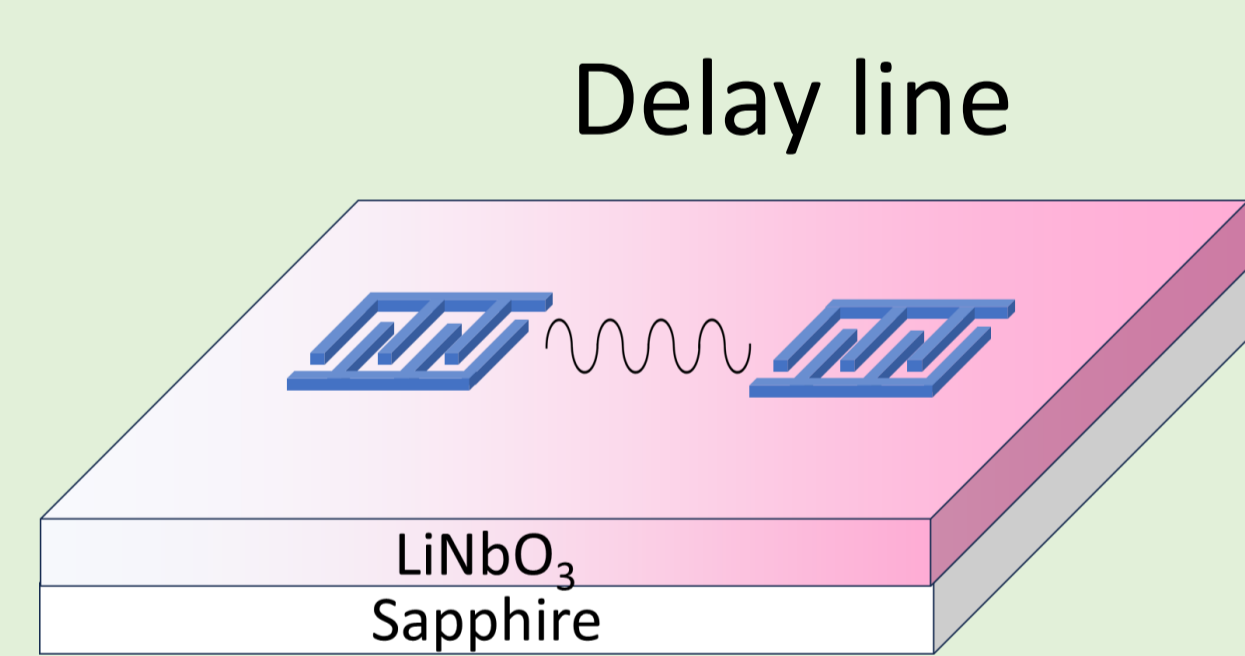

	Delay line	Resonator
t <sub>LN</sub> (nm)	350	350
W (μm)	0.75	0.75
λ (μm)	3	3
L (μm)	67.5	67.5
N <sub>i</sub> (pair)	26	26
N <sub>r</sub>		102
Electrode	Al	Al
t <sub>e</sub> (nm)	50	50

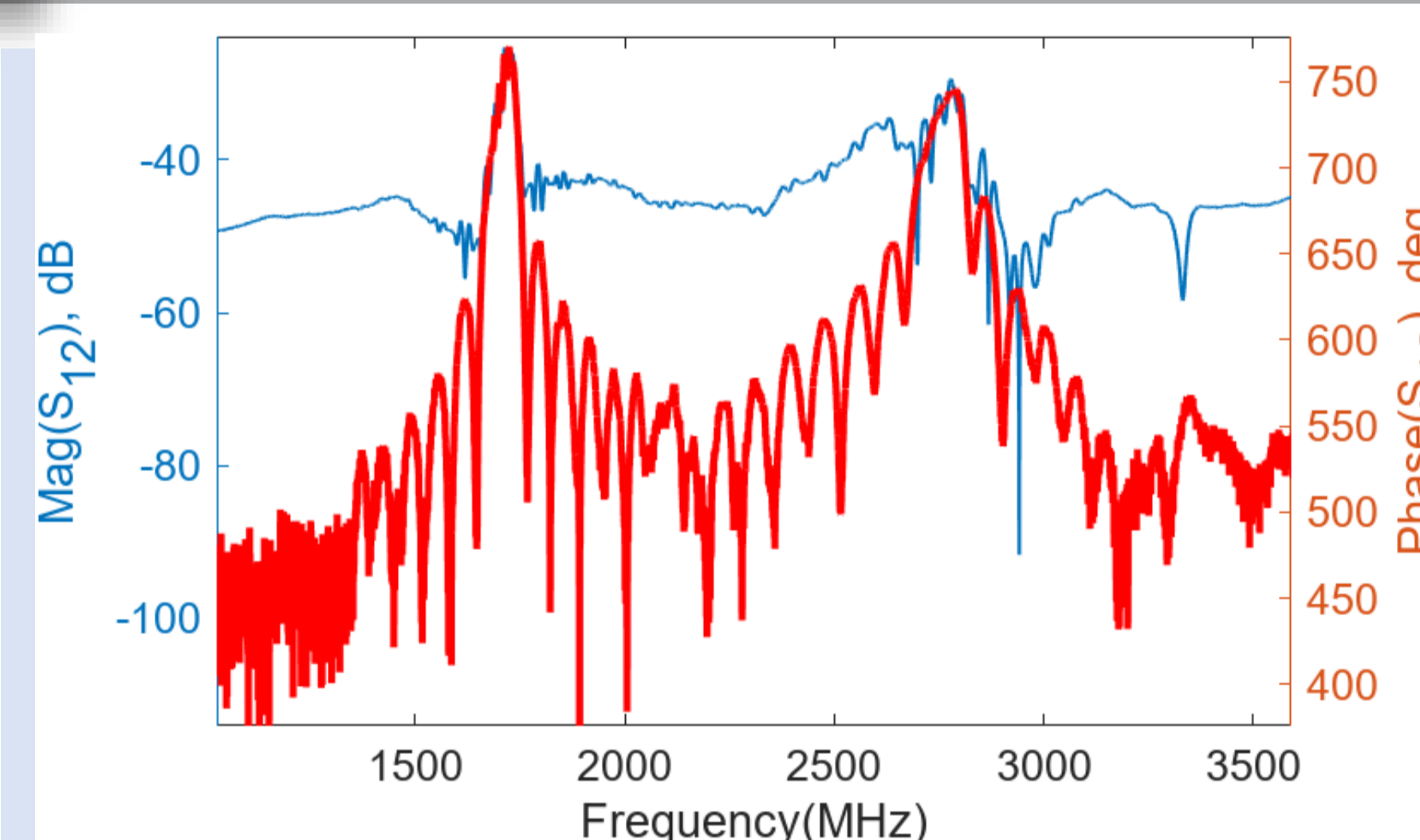
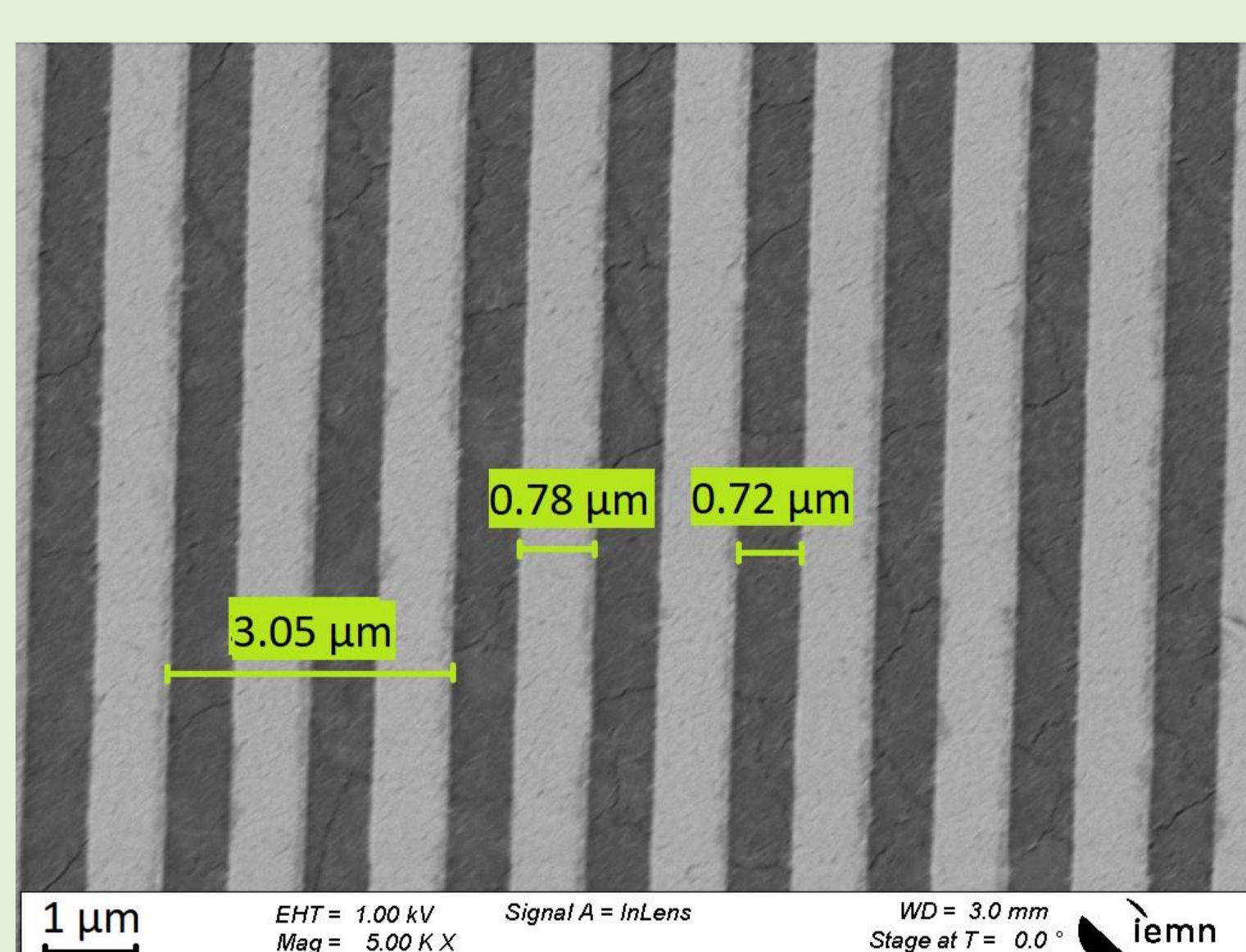

Good quality DLs  
(IL ~ -25 dB)

### Comparison of Experimental and COM simulation

RAYLEIGH mode:  $f = 1.7$  GHz,  $c = 5094$  m/s,  $K^2 = 0.3\%$ ,  $Q = 537$

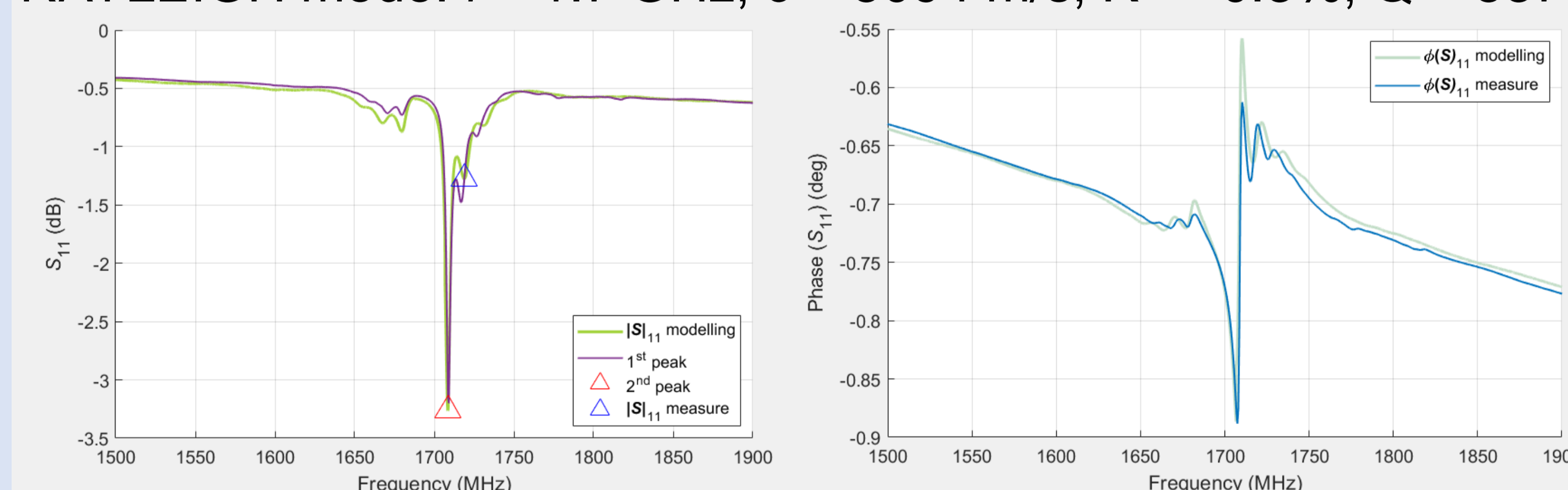

SEZAWA mode:  $f = 2.75$  GHz,  $c = 8250$  m/s,  $K^2 = 3\%$ ,  $Q = 48$

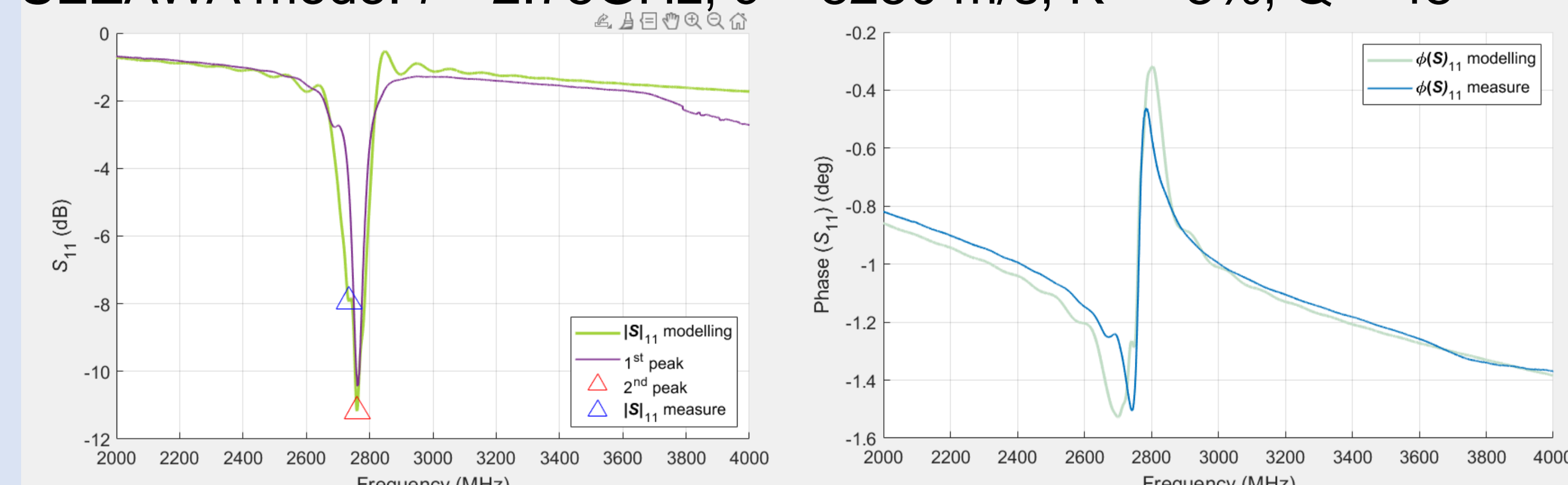

**Conclusion:** Preliminary results are promising for the RF surface acoustic wave (SAW) applications of LN thin film deposited by CBVD