



HAL
open science

About the role of the bottleneck/cork interface on O₂ transfer

Aurélie Lagorce-Tachon, Thomas Karbowiak, Jean-Marc Simon, Régis D. Gougeon, Jean-Pierre Bellat

► **To cite this version:**

Aurélie Lagorce-Tachon, Thomas Karbowiak, Jean-Marc Simon, Régis D. Gougeon, Jean-Pierre Bellat. About the role of the bottleneck/cork interface on O₂ transfer. Colloque international WAC 2017 : 4ème conférence sur les composés actifs du vin, Mar 2017, Beaune, France. 2017. hal-04255489

HAL Id: hal-04255489

<https://hal.science/hal-04255489>

Submitted on 24 Oct 2023

HAL is a multi-disciplinary open access archive for the deposit and dissemination of scientific research documents, whether they are published or not. The documents may come from teaching and research institutions in France or abroad, or from public or private research centers.

L'archive ouverte pluridisciplinaire **HAL**, est destinée au dépôt et à la diffusion de documents scientifiques de niveau recherche, publiés ou non, émanant des établissements d'enseignement et de recherche français ou étrangers, des laboratoires publics ou privés.

About the role of the bottleneck/cork interface on O₂ transfer

Aurélie LAGORCE-TACHON^{a,b}, Thomas KARBOWIAK^b, Jean-Marc SIMON^a,
Régis GOUGEON^{b,c} and Jean-Pierre BELLAT^a

^a Univ. Bourgogne Franche-Comté, ICB UMR-6303 CNRS, 9 av Alain Savary, 21078 Dijon cedex, France

^b Univ. Bourgogne Franche-Comté, Agrosup Dijon, UMR PAM A 02.102, 1 esplanade Erasme, 21078 Dijon, France

^c Univ. Bourgogne Franche-Comté, Institut Universitaire de la Vigne et du Vin, 1 rue Claude Ladrey, 21078 Dijon, France

Context

During post bottling aging of wine, oxygen transfer occurs through the stopper, but also through the glass/stopper interface, and can lead to oxidation reaction [1].



Objectives

To determine the role of glass/cork interface on oxygen transfer

1. Effect of cork stopper compression alone (without glass)
2. Contribution of the interface (with glass)

Materials & Methods

Cork stopper

- High quality (class 0)
- No washing
- No surface treatment

Permeation of oxygen

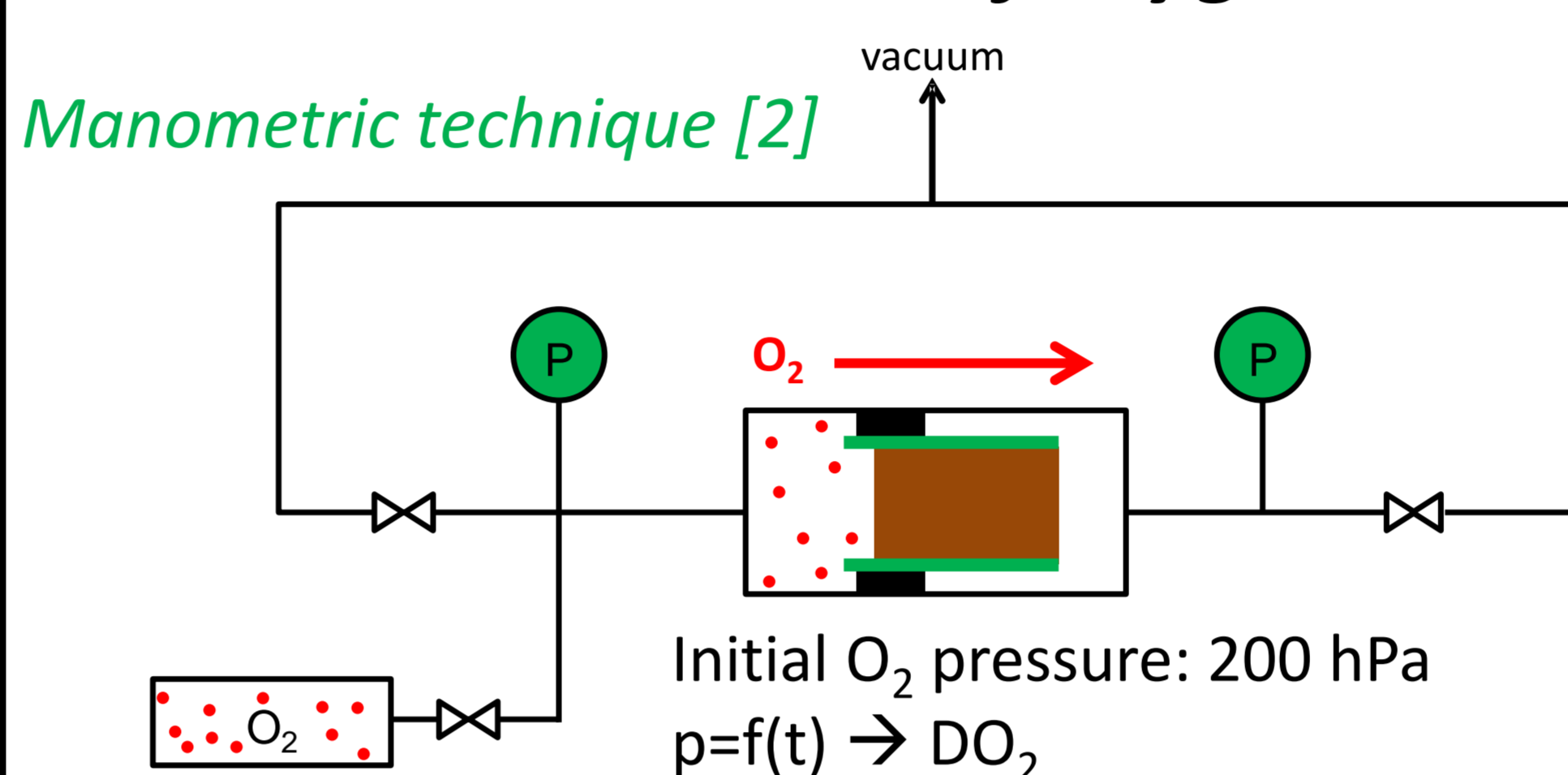

Sample preparation

Not compressed
wafer of 3 mm thick

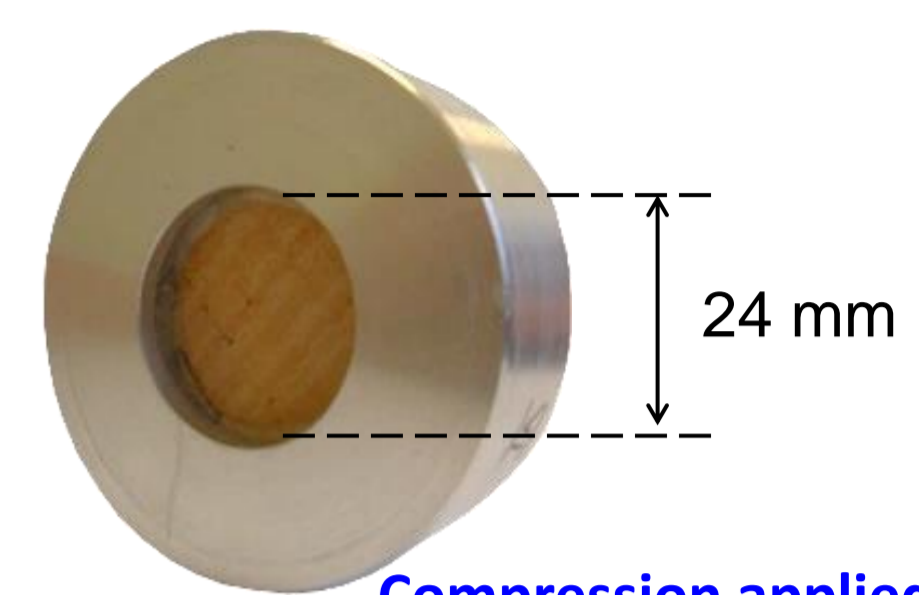

Compressed
(without interface)
wafer of 6 mm thick

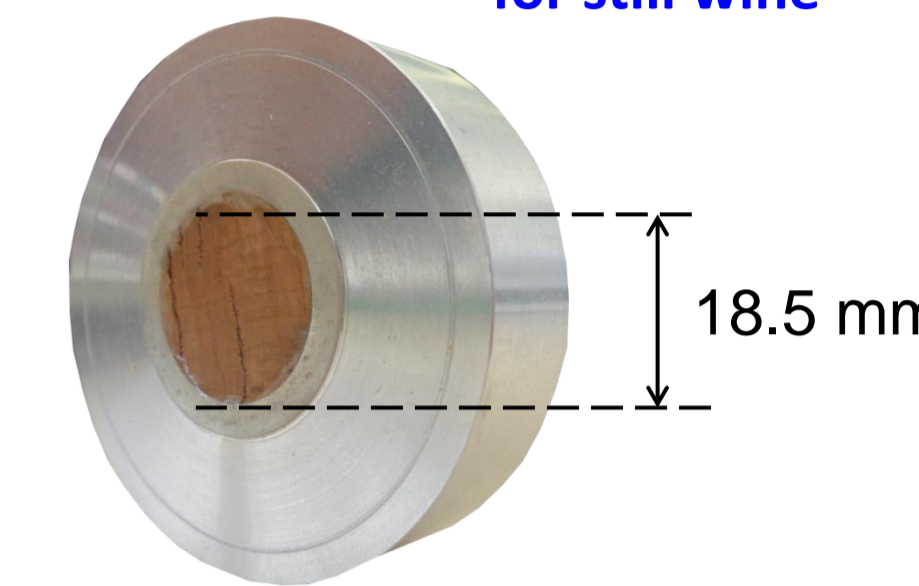

Compressed in
the bottleneck
(glass/cork interface)
whole stopper of 48 mm
length



Results

From wafer to a whole cork stopper

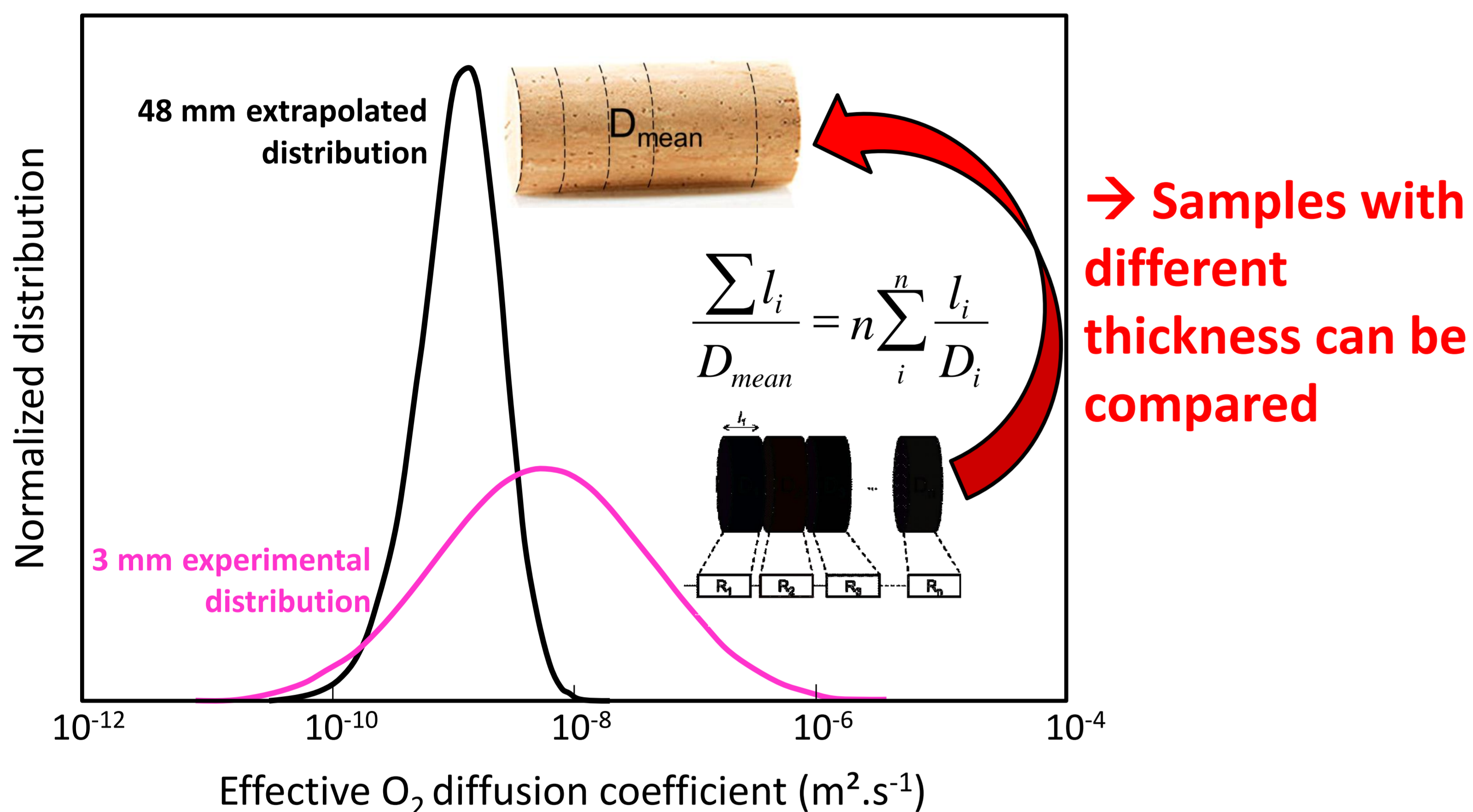

Effect of compression on oxygen transfer

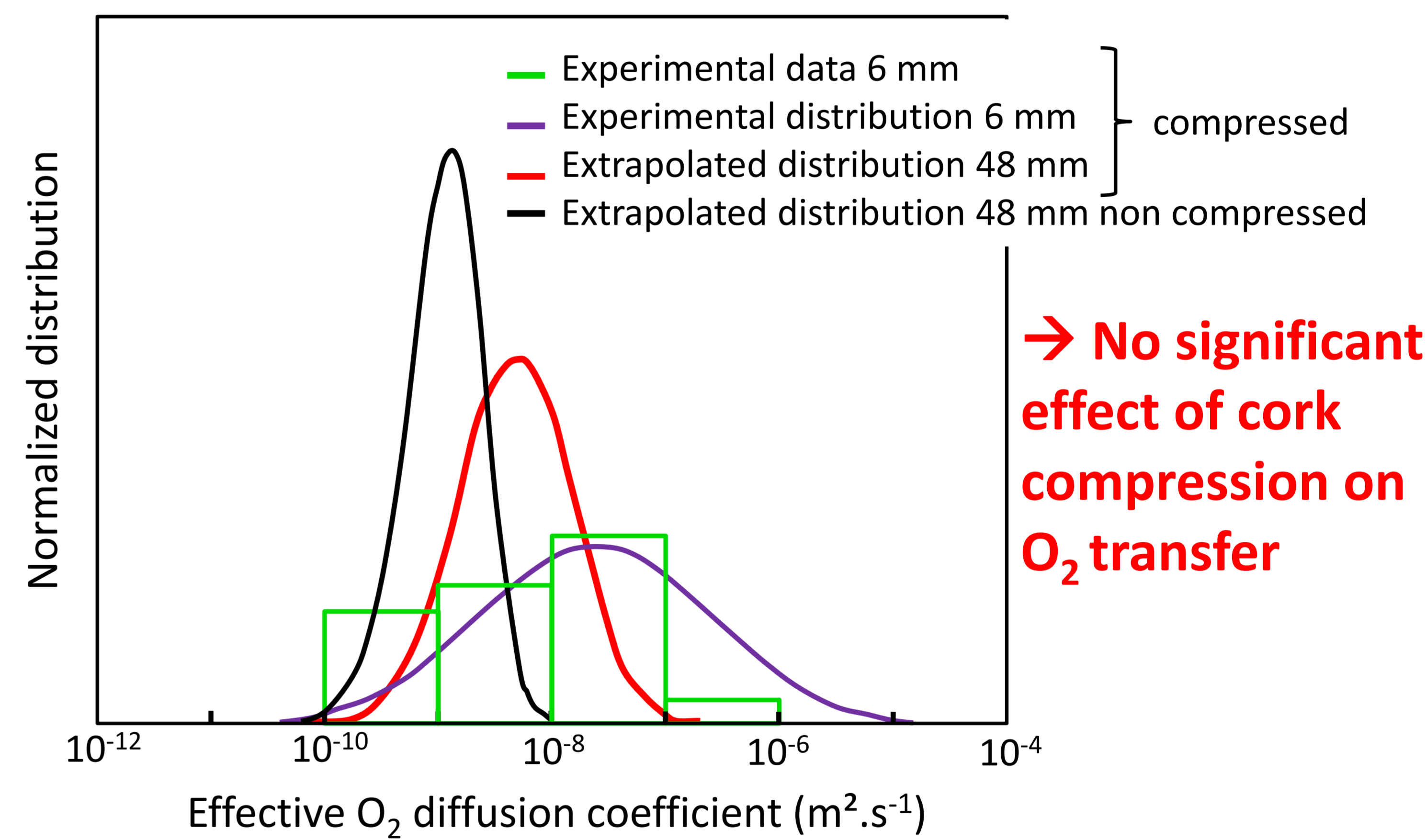

Role of the glass/cork interface

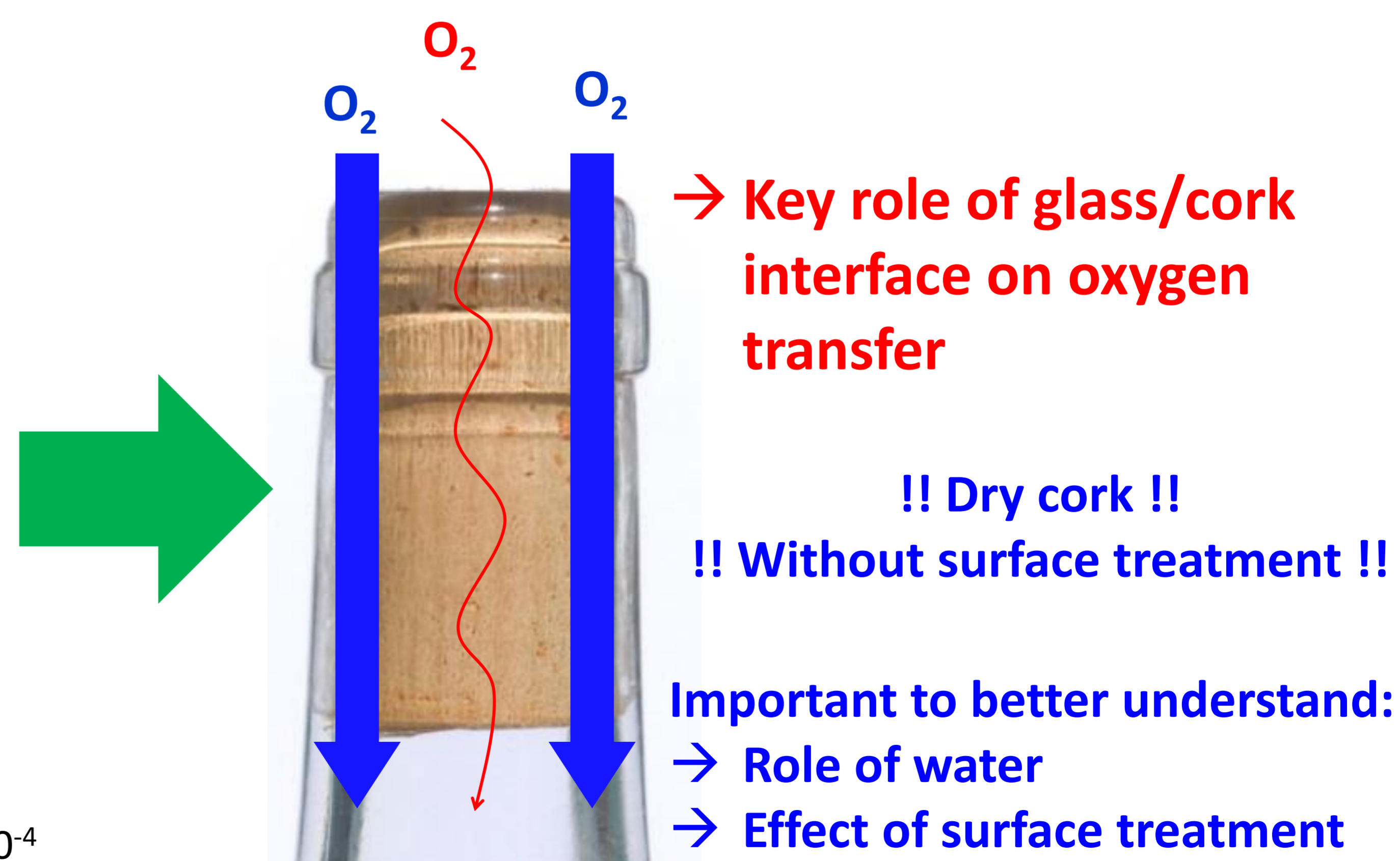
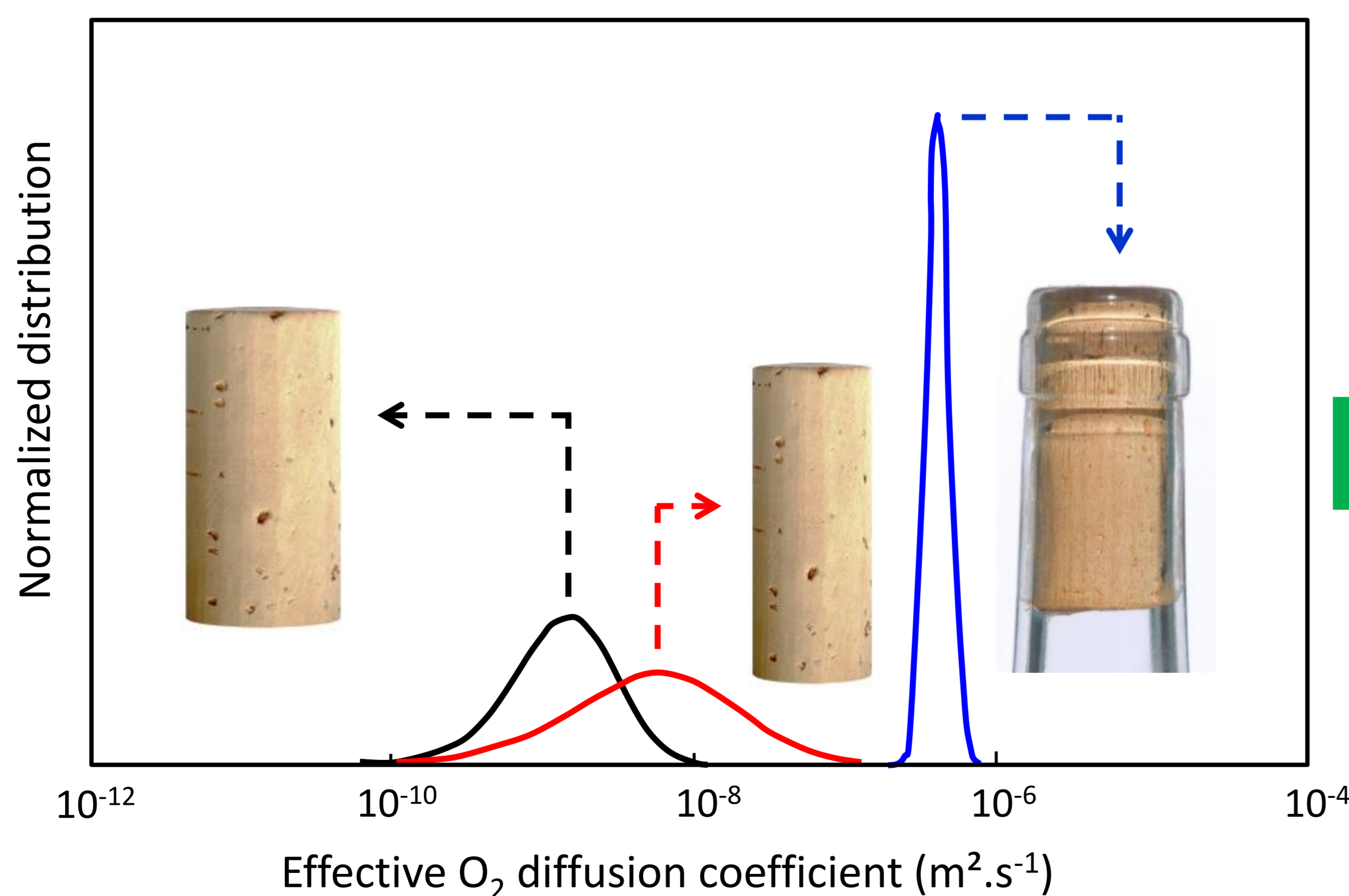

Conclusion

The compression does not significantly affect the effective diffusion coefficient of oxygen through crude cork. However, when considering the transfer of oxygen through cork stopper compressed in a glass bottleneck, the effective diffusion coefficient is 50 times higher. These results point out that the glass/cork interface may play a key role in the oxygen transfer [3].

References

- [1] Karbowiak, T., Gougeon, R.D., Alinc, J-B., Brachais, L., Debeaufort, F., Voilley, A., Chassagne, D. (2010). Wine oxidation and the role of cork. Crit. Rev. Food. Sci., 50 (1), 20-52
- [2] Lequin, S., Chassagne, D., Karbowiak, T., Simon, J-M., Paulin, C., Bellat, J-P. (2012). Diffusion of oxygen in cork. J. Agric. Food. Chem., 60 (13), 3348-3356.
- [3] Lagorce-Tachon, A., Karbowiak, T., Paulin, C., Simon, J-M., Gougeon, R.D., Bellat, J-P. (2016) About the role of the bottleneck/cork interface on oxygen transfer. J. Agric. Food. Chem., 64 (35), 6672-6675