



**HAL**  
open science

## Achieving ultrahigh fatigue resistance in AlSi10Mg alloy by additive manufacturing

Chengyi Dan, Yuchi Cui, Yi Wu, Zhe Chen, Hui Liu, Gang Ji, Yakai Xiao,  
Han Chen, Mingliang Wang, Jun Liu, et al.

► **To cite this version:**

Chengyi Dan, Yuchi Cui, Yi Wu, Zhe Chen, Hui Liu, et al.. Achieving ultrahigh fatigue resistance in AlSi10Mg alloy by additive manufacturing. *Nature Materials*, 2023, 22 (10), pp.1182-1188. 10.1038/s41563-023-01651-9 . hal-04255450

**HAL Id: hal-04255450**

**<https://hal.science/hal-04255450>**

Submitted on 24 Oct 2023

**HAL** is a multi-disciplinary open access archive for the deposit and dissemination of scientific research documents, whether they are published or not. The documents may come from teaching and research institutions in France or abroad, or from public or private research centers.

L'archive ouverte pluridisciplinaire **HAL**, est destinée au dépôt et à la diffusion de documents scientifiques de niveau recherche, publiés ou non, émanant des établissements d'enseignement et de recherche français ou étrangers, des laboratoires publics ou privés.

# Achieving Ultrahigh Fatigue Resistance in AlSi10Mg Alloy by Additive Manufacturing

Chengyi Dan<sup>1,2†</sup>, Yuchi Cui<sup>1†</sup>, Yi Wu<sup>2†</sup>, Zhe Chen<sup>1,2†\*</sup>, Hui Liu<sup>3</sup>, Gang Ji<sup>4</sup>, Yakai Xiao<sup>2</sup>, Han Chen<sup>2</sup>, Mingliang Wang<sup>1</sup>, Jun Liu<sup>2</sup>, Lei Wang<sup>2</sup>, Yang Li<sup>2</sup>, Ahmed Addad<sup>4</sup>, Ying Zhou<sup>2</sup>, Siming Ma<sup>2</sup>, Qiwei Shi<sup>2</sup>, Haowei Wang<sup>1,2</sup>, Jian Lu<sup>3\*</sup>

## Affiliations:

<sup>1</sup>State Key Laboratory of Metal Matrix Composites, Shanghai Jiao Tong University, Shanghai 200240, PR China

<sup>2</sup>School of Materials Science and Engineering, Shanghai Jiao Tong University, Shanghai 200240, PR China

<sup>3</sup>Department of Mechanical and Biomedical Engineering, City University of Hong Kong, Kowloon, Hong Kong, China

<sup>4</sup>Univ. Lille, CNRS, INRA, ENSCL, UMR 8207 - UMET - Unité Matériaux et Transformations, 59000 Lille, France

\*Corresponding author. Email: [zhe.chen@sjtu.edu.cn](mailto:zhe.chen@sjtu.edu.cn), [jianlu@cityu.edu.hk](mailto:jianlu@cityu.edu.hk).

† These authors contributed equally to this work.

**Abstract:** Since the first discovery of fatigue phenomenon in the late 1830s, the efforts to fight against fatigue failure have never been stopped by materials scientists and mechanical engineers. Here we report a fatigue immunisation phenomenon in nano-TiB<sub>2</sub> decorated AlSi10Mg (NTD-Al) enabled by additive manufacturing. This fatigue immunisation mechanism benefits from the 3D dual-phase cellular nanostructure, which acts as a strong volumetric 3D dislocation nanocage to prevent the localised damage accumulation, thus inhibiting fatigue crack initiation. The intrinsic fatigue strength limit of NTD-Al was proven to be close to its tensile strength through *in situ* fatigue test of a defect-free micro-sample, where sign of neither crack initiation nor accumulated fatigue damages was observed. To demonstrate the practical applicability of this mechanism, the printed bulk NTD-Al achieved

28 record high fatigue resistance tested by ASTM standard, which was more than double those of  
29 other additive manufacturing Al alloys and surpassed those of high-strength wrought Al alloys.  
30 A paradigm of achieving high fatigue resistance through additive manufacturing phase  
31 engineering has been established from nanoscale structural design to the fabrication of  
32 geometrically intricate industrial components, which will be extended to the design and  
33 development of other fatigue-resistant metals.  
34

35 **Main Text:**

36

37 Fatigue resistance is a critical design criterion of structural components, as it is estimated that  
38 over 80% of engineering failures are due to fatigue<sup>1</sup>. Insufficient fatigue strength of metals has  
39 remained an unsolved problem for almost two centuries, where conventional metals exhibit  
40 fatigue strength generally lower than half of their tensile strength. In particular for Al alloys,  
41 which are the second widely used metals in industry, the typical fatigue strength ratio (fatigue  
42 strength limit/tensile strength) is only about 1/3<sup>2</sup>. This leads to a very important fact, but seldom  
43 mentioned in industry that for all the moving Al components suffering from cyclic loads, the  
44 load efficiency of materials utilisation is roughly estimated to be less than 20%, considering  
45 the safety factors and the inhomogeneous stress distribution in engineering components.  
46 Despite the metallurgical defects introduced during manufacturing, the intrinsic mechanism for  
47 the lower fatigue resistance is the irreversible dislocation slips taking place in particular grains  
48 due to the severe heterogeneous strain distribution in polycrystalline metals, therefore enabling  
49 localised damage accumulation that initiates fatigue cracks. Recent efforts have shown that  
50 through microstructure design, fatigue resistance of metals can be dramatically enhanced, e.g.  
51 bone-like nano-laminated substructure arresting fatigue cracks in steel<sup>3</sup>, fatigue-induced  
52 precipitation strengthening weak grain boundaries in Al alloy<sup>2</sup> and highly oriented nanoscale  
53 twins constraining reversible cycling damages in copper<sup>4</sup>.

54 Laser powder bed fusion (LPBF), as one of the most widely used metal additive  
55 manufacturing (AM) techniques, is known for its capability of directly fabricating  
56 geometrically complex components with free topology optimisation design. It is worth more  
57 attention that the rapid cooling rate of LPBF also provides unrivaled material microstructure



58 designability down to nanoscale. Here we report a **fatigue immunisation mechanism** in  
59 AlSi10Mg alloy fabricated by LPBF AM. We demonstrate that continuous 3D dual-phase  
60 cellular nanostructure (3D-DPCN) of the LPBF AM AlSi10Mg alloy is immune to fatigue by  
61 inhibiting localised damage accumulation and fatigue crack initiation. This fatigue  
62 immunisation mechanism is distinct from the fatigue mechanisms of conventional metals that  
63 have been studied for over a century. Through an *in situ* micro-fatigue experiment, it is found  
64 that the intrinsic fatigue strength limit ( $> 10^7$  cycles) of a defect-free sample is close to its  
65 tensile strength, and the post-fatigue sample is observed to be crack-free and absent of localised  
66 fatigue damage accumulation, where a fatigue ratio of  $\sim 0.9$  is achieved. As a proof of the  
67 fatigue immunisation mechanism in bulk sample, we fabricated a record high fatigue-resistant  
68 nano-TiB<sub>2</sub>-decorated AlSi10Mg (NTD-Al) alloy through **optimizing printing defects**. The  
69 fatigue strength limit of the NTD-Al alloy, following ASTM standards, was the best among all  
70 Al alloys including the conventional high-strength wrought Al alloys with limited metallurgical  
71 defects, and more than double those of other reported AM Al alloys<sup>2,5-22</sup> (Fig. 1A and B). It is  
72 worth mentioning that the NTD-Al alloy has been applied to fabricate large thin-walled  
73 structures, including fan blades of aircraft engine designed by virtue of its high fatigue strength,  
74 and successfully passed the qualifying fatigue test (Fig. 1C). These findings not only provide  
75 a novel path to designing fatigue resistant alloys in metal research community, but also raise a  
76 new opportunity to weight reduction by increasing the materials load efficiency of moving  
77 components. Combined with the various advantages of 3D printing, such as topological  
78 optimisation (Fig. 1D), this work would have everlasting impacts on modern industry in terms

79 of component weight reduction, and influence future society in terms of low-carbon emission  
 80 from aircrafts and vehicles with the development and mass application of never-fatigue metals.  
 81

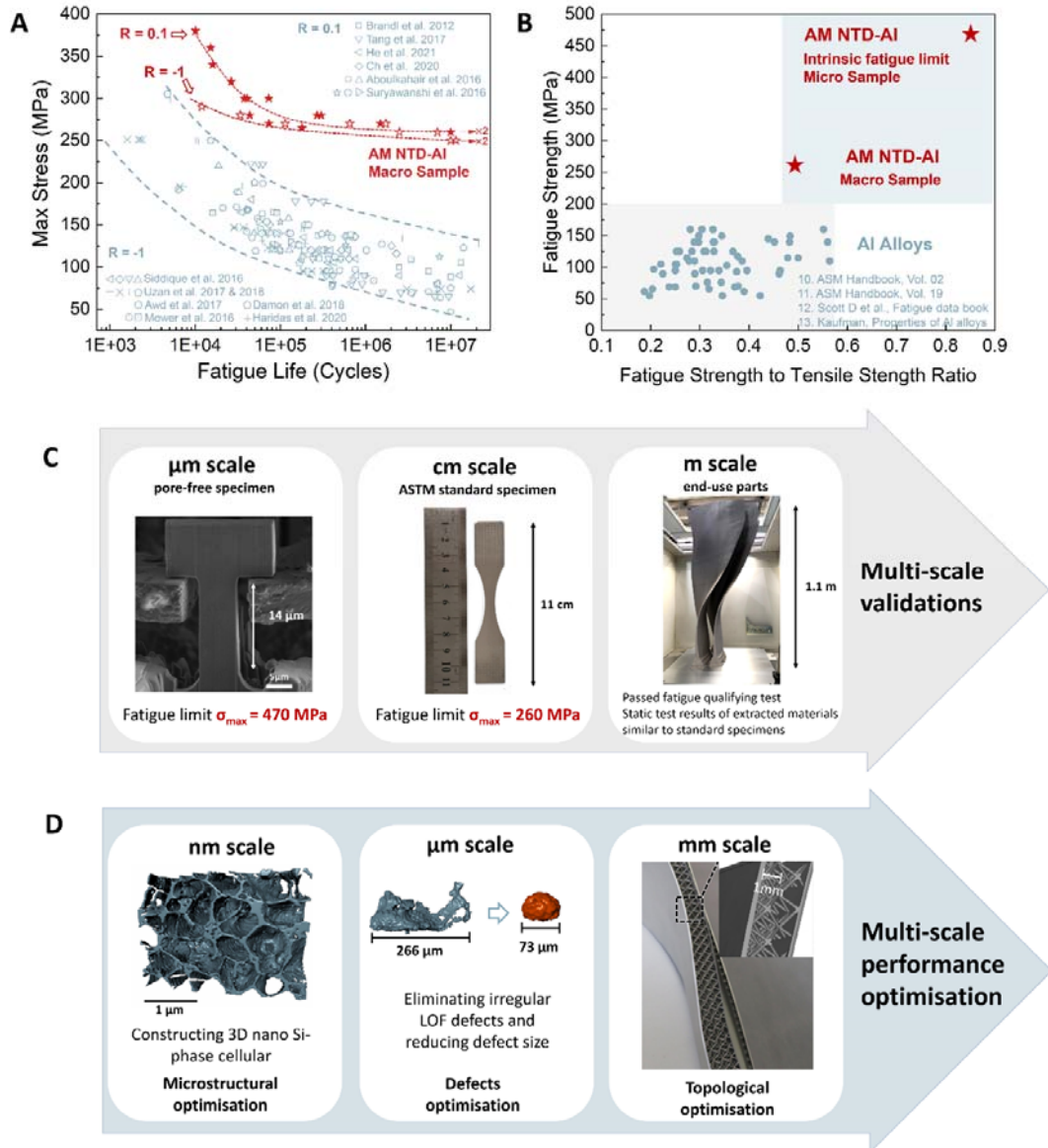

82  
 83 **Fig. 1 Achieving high fatigue strength of the AM NTD-Al alloy.** (A) Number of cycles to  
 84 failure plotted against the maximum stress of AM NTD-Al (stress ratio ( $R$ ) = 0.1 and -1),  
 85 compared with other reported AM AlSi10Mg and AlMgScZr alloys<sup>5-9,14-22</sup>. (B) Fatigue limit to  
 86 tensile strength ratio vs. fatigue strength of AM NTD-Al, compared with Al alloys,  $R = -1$ <sup>2,10-</sup>  
 87 <sup>13</sup>. (C) Multi-scale specimen validations for unprecedented fatigue performances. (D) Multi-  
 88 scale optimisation strategies for performance improvement.

89 We applied LPBF-AM to fabricate the samples using AlSi10Mg powders decorated with  
90 TiB<sub>2</sub> nanoparticles<sup>23</sup>, as demonstrated in Extended Data Fig. 1. Samples for standard fatigue  
91 tests were printed by ProX DMP 200 made by 3D Systems (Extended Data Fig. 2). The  
92 optimised powder chemical composition and printing parameters are given in Extended Data  
93 Table 1. Micro-computed tomography ( $\mu$ -CT) analysis was used to investigate the printing  
94 defects in the NTD-Al, where uniformly distributed nearly spherical pores were found  
95 throughout the sample (Fig. 2A). The widely reported detrimental defects in common AM  
96 AlSi10Mg, the irregular shaped lack of fusions (LOFs, often in size of hundreds of  
97 micrometers, Extended Data Fig. 3A and B), resulted from the improper fusion between  
98 successive tracks or layers due to insufficient energy density<sup>24</sup> were absent in our NTD-Al  
99 sample. Electron backscatter diffraction (EBSD) showed a quasi-equiaxed grain morphology  
100 with an average size of approximately 2–3  $\mu$ m (Fig. 2B). Further characterisation revealed a  
101 typical DPCN that consisted of a network of solidification cellular structure with an average  
102 diameter of  $\sim$  500 nm and  $\alpha$ -Al inside the cellular structure (Fig. 2C). Continuous 3D-DPCN  
103 were revealed by the tomographic reconstruction of backscattered electron (BSE) images from  
104 sections sliced by focused ion beam (FIB) (Fig. 2D). Close-up transmission electron  
105 microscopy (TEM) images showed that the cellular structure was composed of polycrystalline  
106 Si grains of several to tens of nanometers in size and random crystallographic orientations (Fig.  
107 2E and F). The main component of the 3D-DPCN was Si phases containing a few TiB<sub>2</sub>  
108 nanoparticles that could be observed in the energy dispersive spectroscopy (EDS) maps (Fig.  
109 2F and G). EOS M280 was also used to print NTD-Al samples, showing no notable difference

110 compared to ProX DMP 200 (Extended Data Fig. 3 and 4), validating the applicability of our  
111 design strategy in different printing scenarios.

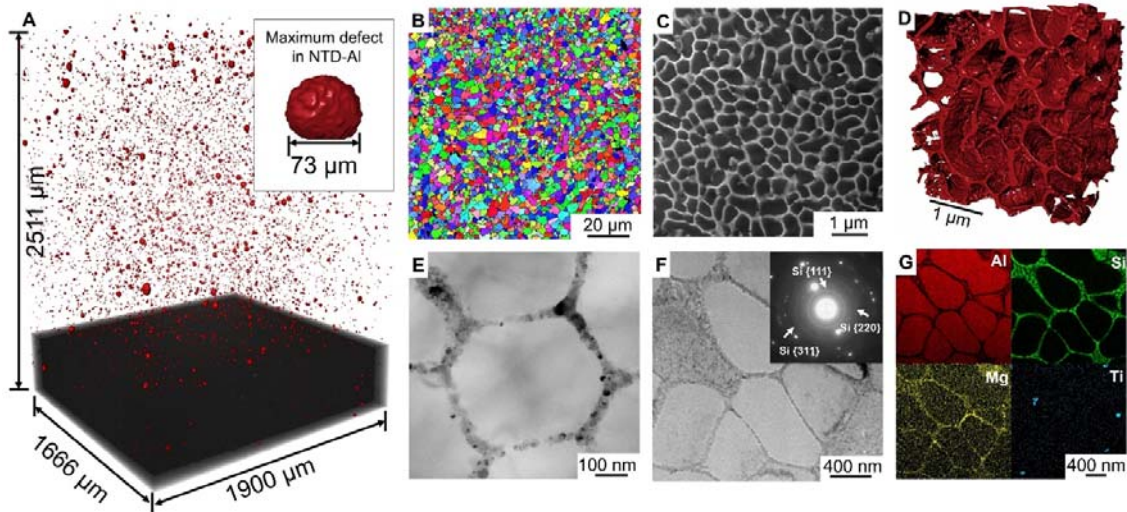

112 **Fig. 2 Microstructure of the AM NTD-Al alloy.** (A)  $\mu$ -CT analysis showing the spatial and  
113 size distributions of printing defects, where the largest defect is measured to be 73  $\mu\text{m}$ , only  
114 about 1/3 of the LOF defects in AM AlSi10Mg alloy without TiB<sub>2</sub> decoration (Extended Data  
115 Fig. 3A and B). (B) Grain morphology of the printed sample. (C) A network of solidification  
116 cellular structure with an average diameter of  $\sim 500$  nm. (D) Continuous 3D Si cellular structure  
117 revealed by BSE/FIB tomography. (E) Cellular structure consisting of nanosized Si phases  
118 revealed by TEM. (F-G) TEM image and Al, Si, Mg and Ti EDS maps illustrating that the  
119 distribution of Si coinciding with the cellular structure. Inset showing the selected area electron  
120 diffraction (SAED) pattern illustrating Si existing as nanosized phases with random  
121 orientations.  
122

123 Previous studies have demonstrated that the fatigue strength of conventional LPBF-AM  
124 AlSi10Mg is deteriorated by printing defects<sup>6,24,25</sup>. The printing defects induce stress  
125 concentration and thus are the key contributors to the inferior and scattered fatigue properties  
126 of metal AM parts compared to their wrought counterparts<sup>6,24-26</sup>. In order to rule out the  
127 complicated effects of printing defects and disclose the intrinsic fatigue strength limit related  
128 to the 3D-DPCN, *in situ* fatigue experiments were performed on micro-samples from pore-free  
129 areas. The 3D-DPCN, as a continuous integral network, is supposed to be the strongest  
130 obstacles to dislocation movements<sup>27,28</sup>, compared to other structural characters such as

131 element solutions, precipitations, grain boundaries et.al, and thus determines the intrinsic  
132 fatigue behaviour. The size of the micro-samples fabricated using FIB was chosen to be gauge  
133 length of  $\sim 14 \mu\text{m}$  and cross section of  $\sim 4 \times 4 \mu\text{m}^2$ , which contains around a thousand cellular  
134 nanostructures (Fig. 3A). Micro-tensile tests were first performed to find out the intrinsic  
135 mechanical response without the printing defects interference, where yield strength of  $\sim 470$   
136 MPa and ultimate tensile strength of  $\sim 550$  MPa were measured (Extended data Fig. 5D, the  
137 *in-situ* movie available in Supplementary Video 1). The micro-tensile samples exhibited ductile  
138 behaviour with significant necking accompanied by gradual reduction of the cross-sectional  
139 area, as shown in Supplementary Video 1. The stress-strain curve was smooth without any  
140 strain burst or sudden load drop. It should be noticed that the dislocation slip bands<sup>29</sup>  
141 conventionally appeared during the *in situ* micro-test of metallic materials were not observed  
142 (Extended Data Fig. 5D), indicating that localised dislocation slips were suppressed. According  
143 to the tensile test results, two series of fatigue tests were conducted, one with maximum stress  
144 at the yielding stress, the other near the ultimate tensile stress, with sinusoidal cyclic loading  
145 tests at 100 Hz (Fig 3A, inset) and stress ratio of  $R = 0.1$ . Surprisingly, neither sign of damage  
146 accumulation (such as the persistent slip bands, PSBs) nor crack initiation could be observed  
147 on the sample surface after  $10^7$  cycles loading at a maximum stress of 470 MPa (Fig. 3B, the  
148 *in situ* movie available in Supplementary Video 2). By contrast, when micro-sized Ni crystal  
149 was examined by a similar *in situ* fatigue test, slip band markings characteristic of PSB  
150 formation were observed<sup>30</sup>. The transmission Kikuchi diffraction (TKD) and local  
151 misorientation map of thin-section sample prepared from the fatigued area in Fig. 3C-E  
152 demonstrated that very limited residual strain was generated, indicating strain localisation was

153 totally restrained by the cell walls after long-term cyclic loading. These results suggest that the  
154 3D-DPCN possesses an ultrahigh intrinsic fatigue strength limit above 470 MPa, which is more  
155 than doubled the highest fatigue strength limit of reported Al Alloys. The corresponding fatigue  
156 strength/tensile strength ratio is above 0.85, which has never been reported in any other metals  
157 to the best of our knowledge (Fig. 1B). When the maximum stress was raised to 520 MPa,  
158 detectable strain accumulation damage gradually developed in the form of necking during the  
159 course  $10^5$  loading cycles (after which the test was stopped), while the intactness of the sample  
160 was still preserved (Fig. 3F and G, and see Supplementary Video 3). This result further proves  
161 that strain damage accumulation only generates in a reluctant manner at stress close to the  
162 tensile strength, which deserves future investigation. A same test was also conducted on LPBF-  
163 AM AlSi10Mg without TiB<sub>2</sub> decoration, where a fatigue strength limit ratio exceeding 0.85  
164 was verified (Fig. S1 and see Supplementary Video 4), confirming that the intrinsic fatigue  
165 performance arises from the 3D-DPCN. These findings reveal a new route to the design of  
166 fatigue immunisation metals through additive manufacturing phase engineering.



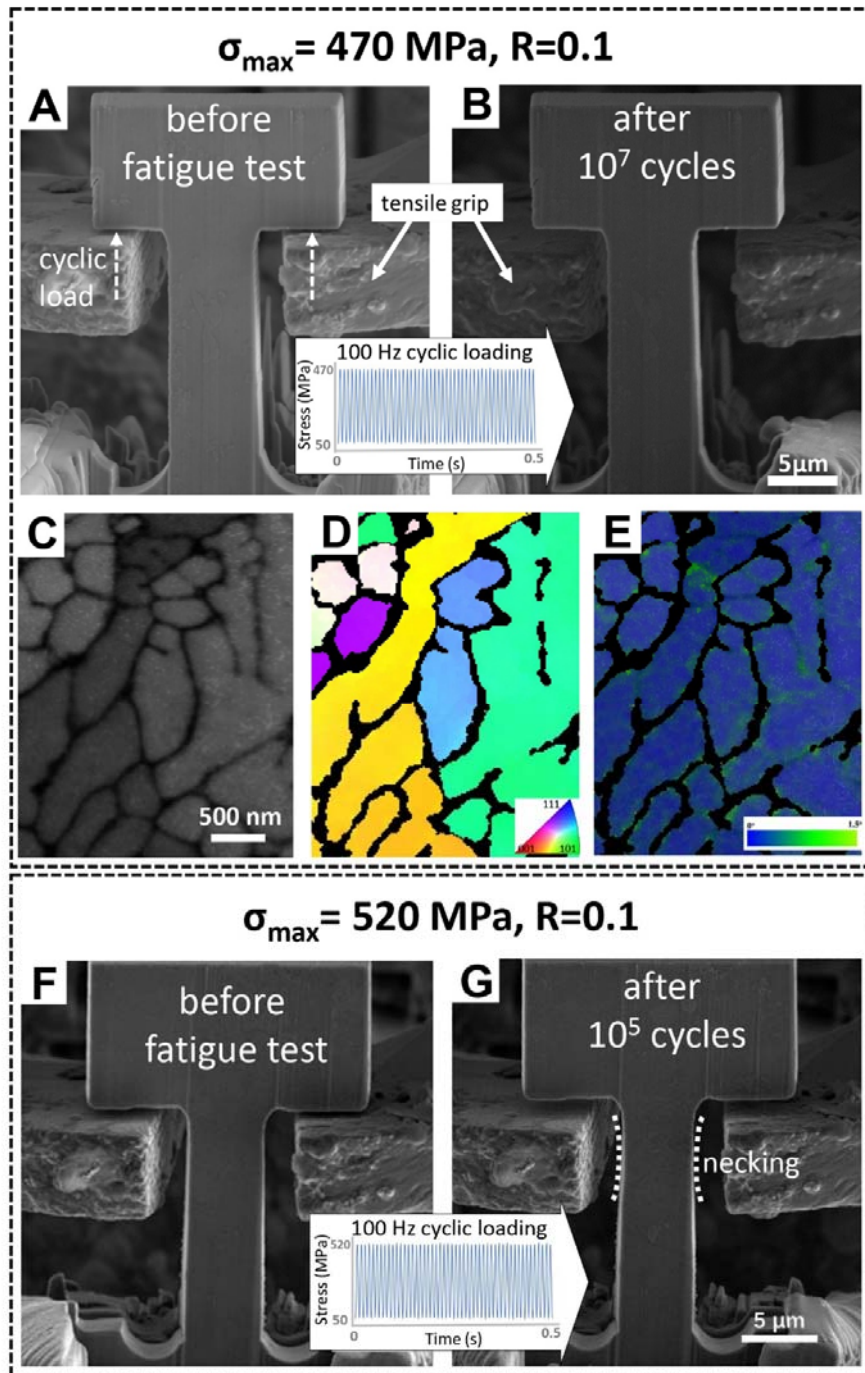

167

168 **Fig. 3 *In situ* micro-fatigue testing results.** SEM images of the micro-sample (A) before the  
 169 fatigue test and (B) after  $10^7$  loading cycles at the maximum stress of 470 MPa. Inset: loading  
 170 curve showing 50 cycles in 0.5s (part of the total loading curve as an example) of stress from  
 171  $\sim 50$  MPa to  $\sim 470$  MPa. (C) Band contrast image of the sample after the fatigue test, with (D)  
 172 TKD map and (E) local misorientation map. (F) SEM images of the micro-sample before the  
 173 fatigue test and (G) after  $10^5$  loading cycles at the maximum stress of 520 MPa. Inset: loading  
 174 curve showing 50 cycles in 0.5s of stress from  $\sim 50$  MPa to  $\sim 520$  MPa.

175 To validate the functioning of the fatigue immunisation mechanism in bulk NTD-Al,  
176 fatigue tests with ASTM/ISO standard specimens (Extended Data Fig. 2) were performed on  
177 the as-printed NTD-Al alloy. Despite the relatively low ductility of approximately 6%–8%  
178 (Extended Data Fig. 6) and the abundance of printing defects (Fig. 2A), the fatigue strength  
179 limits of the NTD-Al alloy reached 260 MPa (pull-pull fatigue testing, stress ratio  $R = 0.1$ ;  
180 printed by ProX DMP 200) and 250 MPa (rotary bending fatigue testing, stress ratio  $R = -1$ ;  
181 printed by M280), which were more than double those of reported AM AlSi10Mg and high-  
182 strength AM AlMgScZr alloys (Fig. 1A)<sup>5-9,14-22</sup>. The rotary bending fatigue strength limit of  
183 250 MPa ( $R = -1$ ) even exceeded those of conventional 2XXX, 6XXX and 7XXX series  
184 wrought Al alloys (Fig. 1B)<sup>2,10-13</sup>. These findings indicate the vast potential applicability of our  
185 alloy for the lightweight structures necessary in industries, where the fatigue property is the  
186 key design criterion. Furthermore, the intrinsic fatigue strength limit of defect-free samples  
187 almost doubled the macro-fatigue strength, denoting that there is plenty space for further  
188 enhancement of fatigue resistance as shown in Fig. 1B.

189 The fatigue testing results illustrate that the fatigue strength limit of the ASTM standard  
190 NTD-Al samples almost doubled those of traditional AM AlSi10Mg alloys but was still half  
191 lower than that of the defect-free micro-size NTD-Al sample. Previous literature has shown  
192 that the fatigue strength limit of macro-size 3D printing samples is strongly associated with the  
193 largest printing defects<sup>24,31</sup>.  $\mu$ -CT results showed that obvious LOF defects with irregular  
194 morphology were distributed throughout the AM AlSi10Mg alloys (Extended Data Fig. 3),  
195 while nearly spherical pores instead of LOF defects were uniformly distributed throughout the  
196 NTD-Al samples (Fig. 2A). Meanwhile, the size of the largest defect in AM NTD-Al alloys



197 was reduced to no more than one-third of that of the AM AlSi10Mg alloys (Extended Data Fig.  
198 3). As the stress concentration from the defects is a crucial factor related to the fatigue  
199 resistance, the stress concentration factors of the largest defects drawn from the  $\mu$ -CT results  
200 were estimated by the finite element method (FEM) in the AM NTD-Al and AM AlSi10Mg  
201 samples, respectively (Extended Data Fig. 7). The stress concentration factors of AM NTD-Al  
202 were generally between 2.2 and 3.0, while those of the irregular LOF defects in AM AlSi10Mg  
203 were 4.3 to 7.9. The greatly decreased pore sizes and the optimised porosity morphology are  
204 primarily responsible for the superior fatigue-resistance of AM NTD-Al compared with  
205 conventional AM AlSi10Mg.

206 We investigated the macro-specimens after  $10^7$  fatigue cycles at a maximum stress of 260  
207 MPa ( $R = 0.1$ ) to assess the microstructural features after high cycle fatigue test. The fatigued  
208 area of the sample ( $2 \text{ mm} \times 2 \text{ mm} \times 6 \text{ mm}$  in the middle of the specimen) was first characterised  
209 by  $\mu$ -CT (Fig. 4A). Compared with the initial sample (Fig. 2A), no detectable changes in the  
210 defect characteristics were found, including the size, morphology and distribution of pores.  
211 Notably, no obvious cracks were observed in the characterised region after fatigue testing (Fig.  
212 4A). However, as shown by the fracture surface of samples that failed at higher stress  
213 (Extended Data Fig. 8), the fatigue cracks usually initiate from the site of the largest defect  
214 near the surface of the sample, the size of which is in agreement with the  $\mu$ -CT results.  
215 Therefore, two of the largest pores (P1 and P2) near the sample surface and two of the largest  
216 pores in the middle of the sample (P3 and P4) were selected for high-resolution  $\mu$ -CT scanning  
217 of  $0.5 \mu\text{m}$  voxel size. No cracks emerged from these pores as shown in the insets of Fig. 4A,  
218 confirming that the crack initiation was entirely suppressed even around the largest pores. In

219 order to reveal the fatigue immunisation mechanism of our macro samples, two TEM thin foils  
220 were lifted out from the fatigued areas using FIB to characterise the fatigued microstructure.  
221 One was from a randomly chosen area and the other was from the stress concentration area  
222 next to P1, which was located and exposed by  $\mu$ -CT-guided laser polishing (Fig. 4B, details of  
223 the process can be found in Supplementary Information Fig. S2). The latter was lifted out at  
224 the edge of P1 on the plane parallel to the loading axis (Fig. 4C). Fig. 4D to F and Extended  
225 Data Fig. 9 showed that the Si cellular structure was not destroyed after fatigue loading. Even  
226 through the material at the edge of P1 was exposed to much larger cyclic loading due to the  
227 stress concentration effect, no notable changes were observed in the Si cellular structure (Fig.  
228 4D). Under the applied stress of 260 MPa (fatigue limit of macro-sized sample), stress  
229 concentration of over 500 MPa estimated by FEM (Extended Data Fig. 7D) would be  
230 developed around the spherical pores, indicating that the critical stress of fatigue immunisation  
231 without damage accumulation is around 500 MPa, in agreement with our micro-fatigue test  
232 results (sample passed fatigue test at maximum stress of 470 MPa and damage accumulation  
233 manifested at maximum stress of 520 MPa, Fig. 3B and G).

234

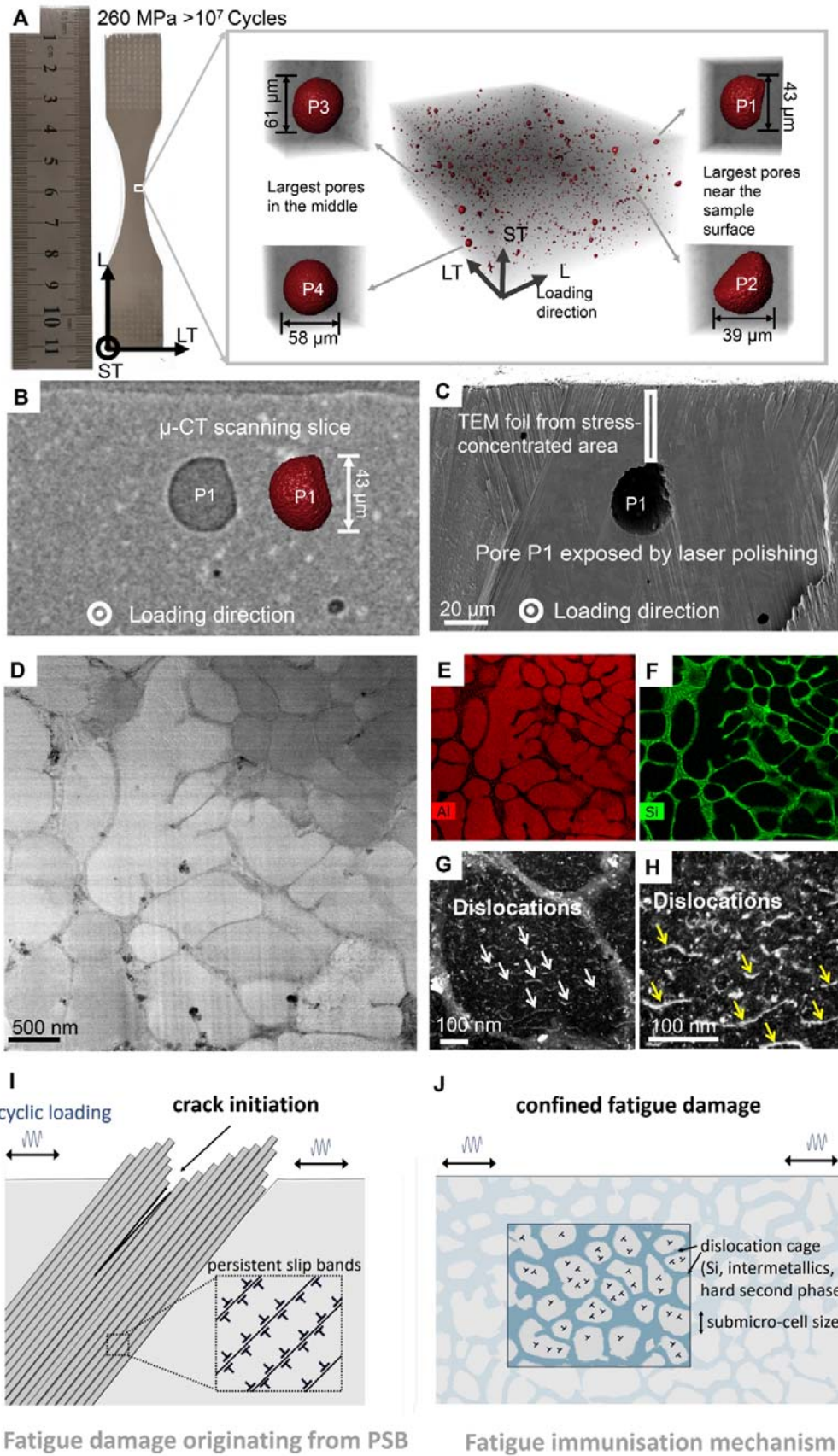

236 **Fig. 4 Fatigue mechanism investigation on the specimen after  $10^7$  fatigue cycles at a**  
237 **maximum stress of 260 MPa ( $R = 0.1$ ).** (A) No obvious cracks were observed in the specimen  
238 after fatigue testing; no cracks emerged from the largest pores (P1-P4); P1 and P2 were located  
239 close to the sample surface while P3 and P4 were in the middle of the sample. (B)  $\mu$ -CT  
240 scanning cross-section of P1. (C) Locating and exposing the cross-section of P1 by  $\mu$ -CT-  
241 guided laser polishing. (D) TEM characterisation of intact Si cellular structure in the region  
242 next to P1 (TEM foil lifted out from the rectangular region in Fig. 4C). (E-F) EDS maps  
243 illustrating the distribution Al and Si elements. (G-H) Individual dislocations distributed inside  
244 one Si nano-cellular structure. Schematics showing (I) the conventional fatigue damage  
245 originating from PSB and (J) the fatigue immunisation mechanism of 3D-DPCN structure.

246 The *in situ* fatigue test and the particular post-fatigue microstructure of the bulk sample  
247 prove a cyclic response totally immune to fatigue damage accumulation in our printed alloy.  
248 Based on the above analysis, we rationalised that the defects optimisation and 3D-DPCN were  
249 responsible for the high fatigue resistance of the LPBF-AM NTD-Al alloy. The 3D-DPCN  
250 hampers the conventional strain localisation associated with irreversible damage during fatigue  
251 loadings (Fig. 4I), such as persistent slip bands, veins, and dislocation cells, which were widely  
252 observed in various coarse-grained metals<sup>32,33</sup>. Instead, individual dislocations were observed  
253 inside the Si nano-cellular structure (Fig. 4G and H). This coincides with the results observed  
254 in copper film that as the grain reduced to below 1  $\mu\text{m}$ , the generation of dislocation  
255 substructures was inhibited and only individual dislocations were formed after fatigue test<sup>34</sup>.  
256 Similar microstructural fatigue features have also been observed in other ultrafine-grain  
257 alloys<sup>35</sup>, where the limited space for dislocation movement inhibits the formation of fatigue  
258 dislocation patterns, resulting in increased resistance to crack initiation and high fatigue  
259 resistance. For instance, an ultrafine-grained high-entropy alloy has been found to exhibit a  
260 high fatigue ratio of approximately 0.62 times its ultimate tensile strength<sup>36</sup>. Besides, A recent  
261 *in situ* TEM compression test on AM AlSi10Mg showed that during deformation, the  
262 dislocations generated were constrained inside the cells, where no obvious penetration through

263 the cell boundaries was observed<sup>28</sup>. These results provide microstructural evidence confirming  
264 that the 3D nano-cellular Si phase of approximately 500 nm in size acts as a strong volumetric  
265 3D dislocation barrier nanocage that traps dislocation movement inside during fatigue load. By  
266 this manner, long-range dislocation slips and dislocation reorganisation were strongly inhibited  
267 during fatigue loading, thereby preventing the formation of strain localisation fatigue damage  
268 (Fig. 4J). Thus, a fatigue strength limit close to its tensile strength can be guaranteed without  
269 fatigue damage accumulation and crack initiation.

270 The 3D-DPCN shows a characteristic fatigue response with no shearing or damage  
271 accumulation below the critical stress, which has significant advantages in industry compared  
272 with conventional alloys where the unpredictability of fatigue damage accumulation raises  
273 great uncertainty. Based on our work a paradigm of achieving high fatigue resistance through  
274 additive manufacturing phase engineering has been established from nanoscale microstructural  
275 design to the fabrication of geometrically intricate industrial components. Utilizing *in situ*  
276 micro-scale tests, the intrinsic fatigue strength limits of the 3D-DPCN can be measured, the  
277 results of which could be incorporated with defects distribution from the CT analysis and stress  
278 distribution from the simulation of industrial components, so that the fatigue response of an  
279 AM component can be predicted to assist performance-oriented processing optimisation. One  
280 such example of meter-scale engine blade design is given in Fig. 1C and D.

281 In this work, we reported a defect-optimised bulk AM NTD-Al alloy that has a record  
282 high fatigue strength that greatly surpassed that of previously reported AM Al alloys and  
283 conventional high-strength wrought Al alloys obtained by different thermal-mechanical  
284 processes. A novel fatigue immunisation mechanism was revealed in Al-alloys prepared by

285 LPBF-AM, where the inherent 3D-DPCN network resulted from the rapid solidification is able  
286 to confine fatigue damage via acting as a strong volumetric 3D dislocation barrier cage to  
287 prevent the localised irreversible damage accumulation during fatigue cyclic loading. Further  
288 enhancement of the fatigue resistance of NTD-Al is expected by decreasing the printing defect  
289 size to the sub-micron range or by eliminating defects through future technological innovations.  
290 Our anti-fatigue paradigm has also been validated in industry scale components, including  
291 aircraft door hinges and engine blades. Furthermore, this fatigue damage immunisation  
292 mechanism enabled by additive manufacturing phase engineering approach could also be  
293 extended to the design of other fatigue-resistant dual/multi-phase alloy systems (another  
294 example is given in supplemental materials) and to other additive manufacturing techniques  
295 including electron beam melting and directed energy deposition.  
296

297 **Methods**

298 **Powder fabrication**

299 The nano-TiB<sub>2</sub>-decorated AlSi10Mg powder was fabricated by an *in situ* salt-metal reaction  
300 method and gas atomisation<sup>14</sup>. Extended Data Fig. 1 shows the spherical morphology of our *in*  
301 *situ* synthesised powders, which ensures a much better flowability. The flowability of our  
302 powders was measured to be ~ 20 s/50 g through Hall flowmeter measurement. It can be  
303 observed from the magnified image of the cross section of powder that the *in situ* synthesised  
304 TiB<sub>2</sub> nanoparticles are homogeneously distributed in the powder (Extended Data Fig. 1B and  
305 C).

306 Previous works shows that TiB<sub>2</sub> particles can ameliorate the laser printing process through  
307 (a) increasing the average laser energy density<sup>14</sup>; (b) modifying the solidification path by  
308 promote grain nucleation and mitigate solidification defects<sup>23,37-39</sup>; and (c) stabilizing melt pool  
309 fluctuations and preventing liquid droplet coalesce, which result in the elimination of large  
310 spatters and the reduction of printing defects<sup>23,40</sup>. As shown in Extended Data Fig. 1E and F,  
311 the laser reflectivity of Al-Si-Mg alloy can be reduced by ~ 40% with 5% addition of TiB<sub>2</sub>,  
312 while the K-M absorption factor was raised by ~ 220%. With the addition of TiB<sub>2</sub> particles, the  
313 detrimental LOF defects have been eliminated (Fig. 2A and Extended Data Fig.3). The  
314 chemical composition is shown in Extended Data Table 1.

315 **Laser powder bed fusion additive manufacturing**

316 LPBF additive manufacturing of NTD-Al samples for standard fatigue test was performed  
317 using 3D Systems Prox DMP 200 and EOS M280 selective laser melting machines. The fan  
318 blades of aircraft engine were manufactured by a customised BLT-S500 selective laser melting

319 machine. An inert, high-purity ( $\geq 99.99\%$ ) argon gas atmosphere flow with an oxygen content  
320 of  $< 600$  ppm was used throughout the process to minimise oxidation. The AM processing was  
321 completed at room temperature without applying heat to the build plate. The printing  
322 parameters used in our work were listed in Extended Data Table 1. The samples consisted of 3  
323 mm  $\times$  21 mm  $\times$  105 mm and 12 mm  $\times$  28 mm  $\times$  130 mm blocks for the fatigue tests; 5 mm  $\times$   
324 5 mm blocks for microstructure characterisation; and 2 mm  $\times$  10 mm  $\times$  60 mm blocks for the  
325 tensile tests. Images of the as-printed samples are shown in Extended Data Fig. 2.

### 326 **Sectioning and sample preparation**

327 As-printed samples were removed from the build plates by wire electrical discharge machining.  
328 The fatigue samples were polished using 400, 800, 1200 and 2500 grit sandpaper consecutively  
329 and then with 5  $\mu$ m diamond suspensions, which ensured a deformation-free surface. The  
330 scanning electron microscopy (SEM) and EBSD samples were polished with 400, 800, 1200  
331 and 2500 grit sandpaper. Final polishing of these samples was conducted with the diamond  
332 suspensions, followed by ion polishing in a Leica EM TIC 3X. Some of the polished samples  
333 were etched using Keller's etchant to reveal the 3D cellular Si structure (Fig. 2C).

334 The TEM and TKD lamellas were prepared in a Tescan Lyra3 FIB/SEM microscope. A  
335 protective platinum layer was deposited at 30 kV and a current of 200 pA. FIB trenches were  
336 roughly milled under 30 kV and 10 nA. Cross-sections were finely polished using a 3 nA  
337 current. After lifting out the sample and welding it to a Cu TEM grid, the lamellas were thinned  
338 under 30 kV, with the current reduced in the sequence of 1 nA, 500 pA, 150 pA and 50 pA.  
339 Final polishing was conducted at 5 kV and a 50 pA current.

### 340 **Microstructure and defect characterisation**



341 The microstructures of the as-fabricated alloys were characterised with a SEM (Tescan Lyra3)  
342 equipped with EBSD (Oxford Nordlys Max3). The EBSD maps were recorded with step size  
343 of 0.1  $\mu\text{m}$ . The orientation evolution of the fatigued samples was characterised using TKD with  
344 step size of 30 nm (Oxford Nordlys Max3). TEM (FEI Tecnai G2 operating at 200 kV) was  
345 used to examine the Si cellular structure.

#### 346 **Reconstruction of printing defects**

347 X-ray  $\mu$ -CT was performed using Xradia 510 Versa (Zeiss) to analyse the printing defects  
348 inside the SLM-printed samples. A voxel size of 3.0  $\mu\text{m}$  was selected to allow the large  
349 specimen volumes (up to 2 mm  $\times$  2 mm  $\times$  6 mm) to be imaged. High-resolution  $\mu$ -CT scanning  
350 (0.5  $\mu\text{m}$  voxel size) was further performed on localised regions. Reconstruction of the scanned  
351 volumes was conducted using Dragonfly software. The defect population was resolved with  
352 respect to the position and volume.

#### 353 **Reconstruction of 3D dual-phase cellular nanostructure**

354 To obtain 3D volumes of the studied materials, SEM was coupled with the FIB milling  
355 technique (Lyra3 Tescan). The angle between the FIB and SEM columns was 55°. Before  
356 running the acquisition, a Pt layer (10  $\times$  10  $\times$  1  $\mu\text{m}$ ) was deposited on an area of interest by ion  
357 beam deposition (IBD) to smooth out the surface roughness and protect the target surface. A  
358 micropillar (10  $\times$  10  $\times$  20  $\mu\text{m}$ ) was prepared for the 3D acquisition. After acquiring an BSE  
359 image at the side surface of the micropillar, a 15 nm step of material was removed using FIB.  
360 Serial FIB sectioning was done with a current of 1 nA at 5 keV. The following BSE 2D image  
361 was acquired and this process was repeated several hundred times to obtain an 3D volume with

362 a resolution of 15 nm. The collected 2D images of the elemental-Si contrast were reconstructed  
363 by Dragonfly software.

### 364 **Tensile and Fatigue test**

365 Dog-bone tensile testing specimens were machined according to the ASTM-E8M standard.  
366 The tests were carried out on a Zwick/Roell Z100 testing machine at a constant strain rate of  
367  $10^{-4} \text{ s}^{-1}$ .

368 Fatigue testing specimens were machined according to the ASTM E466-21 standard for  
369 pull-pull fatigue test,  $R = 0.1$  (Extended Data Fig. 2C) and the ISO 1143-2008 for rotating  
370 bending fatigue test,  $R = -1$  (Extended Data Fig. 2D), respectively. High-frequency fatigue  
371 testing machines were used for the rotating bending fatigue test ( $R = -1$ ) (Giga Quad YRB200;  
372 Yamamoto Corporation, Japan) and the pull-pull fatigue test ( $R = 0.1$ ) (Changchun Qianbang  
373 Corporation, China). The cyclic loading followed a sinusoidal wave. A frequency of 80 Hz was  
374 used for both fatigue tests. The tests were conducted in air at room temperature (approximately  
375  $21 \text{ }^{\circ}\text{C}$  and 30% relative humidity). The high cycle fatigue tests were terminated after  $10^7$  cycles,  
376 with the surviving samples being identified as run-outs.

### 377 **Micro-sample fabrication**

378 For the *in situ* micro-tests, “T”-shaped micro-specimen geometry was fabricated as shown in  
379 Extended Data Fig. 5. The gauge regions were rectangular in cross-section with approximate  
380 dimensions of  $4 \times 4 \text{ }\mu\text{m}^2$ , while the gauge lengths were approximately  $14 \text{ }\mu\text{m}$ . The “T” head  
381 region was approximately  $15 \text{ }\mu\text{m}$  in width and the same thickness as the gauge section. During  
382 the test, the “T” head would be lifted from the underneath at two sides to induce tensile load at

383 the gauge region. Chamfering was introduced at the two ends of the gauge region to reduce  
384 local stress concentration.

385 The micro-specimens were fabricated at the top edge of the printed sample after  
386 mechanical surface polishing, so that the top and front views of micro-specimen could be  
387 exposed to laser and ion milling. The first step of fabrication was rough-milling the geometry  
388 using a Gemini2 (Zeiss) femtosecond laser operated at 4.5 W with a repetition rate of 1.0 kHz.  
389 After laser milling, FIB in Tescan Lyra3 SEM-FIB was used to obtain the final gauge  
390 geometry. Surface imperfections and curtaining, as well as tapering of the specimen, were  
391 minimised by performing a low-current final polishing step at 30 kV, 150 pA.

### 392 **Micro-testing methodology**

393 The micro-tensile and fatigue tests were performed utilizing an Alemnis Standard Assemble  
394 platform inside of a Tescan Lyra3 SEM. A customised diamond tensile grip was used to induce  
395 tensile load to the specimen (Extended Data Fig. 5A and B). During the FIB polishing of “T”-  
396 shape geometry, several adjustments were made to ensure full contact between the “T”-head  
397 and the tensile grip at the two sides, so that the tensile load will be applied along the gauge  
398 axis.

399 For the tensile test, a nominal strain rate of  $10^{-3} \text{ s}^{-1}$  was applied using the displacement-  
400 controlled mode. For the fatigue test, the cyclic loading was introduced through applying  
401 sinusoidal displacement signal at 100 Hz. The stress level was controlled by adjusting the input  
402 displacement value and amplitude to perform the R=0.1 fatigue test. The load and displacement  
403 data were tracked and recorded at 1kHz frequency. The displacement signal was recalibrated  
404 after each  $10^4$  loading cycles (100 s) to minimise the effect of mechanical drifting.

406 **References and Notes**

407

- 408 1 Suresh, S. *Fatigue of Materials*. 2 edn, (Cambridge University Press, 1998).
- 409 2 Zhang, Q., Zhu, Y., Gao, X., Wu, Y. & Hutchinson, C. Training high-strength aluminum alloys to  
410 withstand fatigue. *Nature Communications* **11**, 5198, doi:10.1038/s41467-020-19071-7 (2020).
- 411 3 Koyama, M. *et al.* Bone-like crack resistance in hierarchical metastable nanolaminate steels. *Science* **355**,  
412 1055, doi:10.1126/science.aal2766 (2017).
- 413 4 Pan, Q., Zhou, H., Lu, Q., Gao, H. & Lu, L. History-independent cyclic response of nanotwinned metals.  
414 *Nature* **551**, 214-217, doi:10.1038/nature24266 (2017).
- 415 5 Tang, M. & Pistorius, P. C. Oxides, porosity and fatigue performance of AlSi10Mg parts produced by  
416 selective laser melting. *International Journal of Fatigue* **94**, 192-201, doi:  
417 10.1016/j.ijfatigue.2016.06.002 (2017).
- 418 6 Ch, S. R., Raja, A., Jayaganthan, R., Vasa, N. J. & Raghunandan, M. Study on the fatigue behaviour of  
419 selective laser melted AlSi10Mg alloy. *Materials Science and Engineering: A* **781**, 139180,  
420 doi:<https://doi.org/10.1016/j.msea.2020.139180> (2020).
- 421 7 Brandl, E., Heckenberger, U., Holzinger, V. & Buchbinder, D. Additive manufactured AlSi10Mg samples  
422 using Selective Laser Melting (SLM): Microstructure, high cycle fatigue, and fracture behavior.  
423 *Materials & Design* **34**, 159-169, doi:<https://doi.org/10.1016/j.matdes.2011.07.067> (2012).
- 424 8 Aboulkhair, N. T., Maskery, I., Tuck, C., Ashcroft, I. & Everitt, N. M. Improving the fatigue behaviour  
425 of a selectively laser melted aluminium alloy: Influence of heat treatment and surface quality. *Materials*  
426 *& Design* **104**, 174-182, doi:<https://doi.org/10.1016/j.matdes.2016.05.041> (2016).
- 427 9 He, P. *et al.* Fatigue and dynamic aging behavior of a high strength Al-5024 alloy fabricated by laser  
428 powder bed fusion additive manufacturing. *Acta Materialia* **220**, 117312,  
429 doi:<https://doi.org/10.1016/j.actamat.2021.117312> (2021).
- 430 10 Committee, A. I. H. *Volume 02 - Properties and Selection: Nonferrous Alloys and Special-Purpose*  
431 *Materials*. (ASM International, 1990).
- 432 11 Committee, A. I. H. *Volume 19 - Fatigue and Fracture*. (ASM International, 1996).
- 433 12 Henry, S. D. *et al.* *Fatigue Data Book - Light Structural Alloys*. (ASM International, 1995).
- 434 13 Kaufman, J. G. *Properties of Aluminum Alloys - Fatigue Data and the Effects of Temperature, Product*  
435 *Form, and Processing*. (ASM International, 2008).
- 436 14 Mower, T. M. & Long, M. J. Mechanical behavior of additive manufactured, powder-bed laser-fused  
437 materials. *Materials Science and Engineering: A* **651**, 198-213, doi:10.1016/j.msea.2015.10.068 (2016).
- 438 15 Mishra, R. S. & Thapliyal, S. Design approaches for printability-performance synergy in Al alloys for  
439 laser-powder bed additive manufacturing. *Materials & Design* **204**, doi:10.1016/j.matdes.2021.109640  
440 (2021).
- 441 16 Uzan, N. E., Ramati, S., Shneck, R., Frage, N. & Yeheskel, O. On the effect of shot-peening on fatigue  
442 resistance of AlSi10Mg specimens fabricated by additive manufacturing using selective laser melting  
443 (AM-SLM). *Additive Manufacturing* **21**, 458-464, doi:10.1016/j.addma.2018.03.030 (2018).
- 444 17 Damon, J., Dietrich, S., Vollert, F., Gibmeier, J. & Schulze, V. Process dependent porosity and the  
445 influence of shot peening on porosity morphology regarding selective laser melted AlSi10Mg parts.  
446 *Additive Manufacturing* **20**, 77-89, doi:10.1016/j.addma.2018.01.001 (2018).

- 447 18 Bassoli, E., Denti, L., Comin, A., Sola, A. & Tognoli, E. Fatigue Behavior of As-Built L-PBF A357.0  
448 Parts. *Metals* **8**, doi:10.3390/met8080634 (2018).
- 449 19 Uzan, N. E., Shneck, R., Yeheskel, O. & Frage, N. Fatigue of AlSi10Mg specimens fabricated by additive  
450 manufacturing selective laser melting (AM-SLM). *Materials Science and Engineering: A* **704**, 229-237,  
451 doi:10.1016/j.msea.2017.08.027 (2017).
- 452 20 Siddique, S., Awd, M., Tenkamp, J. & Walther, F. High and very high cycle fatigue failure mechanisms  
453 in selective laser melted aluminum alloys. *Journal of Materials Research* **32**, 4296-4304,  
454 doi:10.1557/jmr.2017.314 (2017).
- 455 21 Awd, M. *et al.* Comparison of Microstructure and Mechanical Properties of Scalmetalloy((R)) Produced  
456 by Selective Laser Melting and Laser Metal Deposition. *Materials (Basel)* **11**, doi:10.3390/ma11010017  
457 (2017).
- 458 22 Suryawanshi, J. *et al.* Simultaneous enhancements of strength and toughness in an Al-12Si alloy  
459 synthesized using selective laser melting. *Acta Materialia* **115**, 285-294,  
460 doi:10.1016/j.actamat.2016.06.009 (2016).
- 461 23 Li, X. P. *et al.* Selective laser melting of nano-TiB<sub>2</sub> decorated AlSi10Mg alloy with high fracture strength  
462 and ductility. *Acta Materialia* **129**, 183-193, doi:10.1016/j.actamat.2017.02.062 (2017).
- 463 24 Sanaei, N. & Fatemi, A. Defects in additive manufactured metals and their effect on fatigue performance:  
464 A state-of-the-art review. *Progress in Materials Science* **117**, 100724,  
465 doi:<https://doi.org/10.1016/j.pmatsci.2020.100724> (2021).
- 466 25 Romano, S., Abel, A., Gumpinger, J., Brandão, A. D. & Beretta, S. Quality control of AlSi10Mg produced  
467 by SLM: Metallography versus CT scans for critical defect size assessment. *Additive Manufacturing* **28**,  
468 394-405, doi:10.1016/j.addma.2019.05.017 (2019).
- 469 26 Haridas, R. S., Thapliyal, S., Agrawal, P. & Mishra, R. S. Defect-based probabilistic fatigue life  
470 estimation model for an additively manufactured aluminum alloy. *Materials Science and Engineering: A*  
471 **798**, doi:10.1016/j.msea.2020.140082 (2020).
- 472 27 Zhang, X. X. *et al.* Evolution of microscopic strains, stresses, and dislocation density during in-situ  
473 tensile loading of additively manufactured AlSi10Mg alloy. *International Journal of Plasticity* **139**,  
474 doi:10.1016/j.ijplas.2021.102946 (2021).
- 475 28 Wu, J., Wang, X. Q., Wang, W., Attallah, M. M. & Loretto, M. H. Microstructure and strength of  
476 selectively laser melted AlSi10Mg. *Acta Materialia* **117**, 311-320,  
477 doi:<https://doi.org/10.1016/j.actamat.2016.07.012> (2016).
- 478 29 Reichardt, A. *et al.* In situ micro tensile testing of He<sup>+</sup>2 ion irradiated and implanted single crystal nickel  
479 film. *Acta Materialia* **100**, 147-154, doi:<https://doi.org/10.1016/j.actamat.2015.08.028> (2015).
- 480 30 Lavenstein, S., Gu, Y., Madisetti, D. & El-Awady, J. A. The heterogeneity of persistent slip band  
481 nucleation and evolution in metals at the micrometer scale. *Science* **370**, doi:10.1126/science.abb2690  
482 (2020).
- 483 31 Wu, Z. *et al.* The effect of defect population on the anisotropic fatigue resistance of AlSi10Mg alloy  
484 fabricated by laser powder bed fusion. *International Journal of Fatigue* **151**, 106317,  
485 doi:<https://doi.org/10.1016/j.ijfatigue.2021.106317> (2021).
- 486 32 Li, P., Li, S. X., Wang, Z. G. & Zhang, Z. F. Unified factor controlling the dislocation evolution of  
487 fatigued face-centered cubic crystals. *Acta Materialia* **129**, 98-111,  
488 doi:<https://doi.org/10.1016/j.actamat.2017.02.057> (2017).
- 489 33 Pineau, A., McDowell, D. L., Busso, E. P. & Antolovich, S. D. Failure of metals II: Fatigue. *Acta*  
490 *Materialia* **107**, 484-507, doi:<https://doi.org/10.1016/j.actamat.2015.05.050> (2016).

- 491 34 Zhang, G. P. *et al.* Length-scale-controlled fatigue mechanisms in thin copper films. *Acta Materialia* **54**,  
492 3127-3139, doi:<https://doi.org/10.1016/j.actamat.2006.03.013> (2006).
- 493 35 Vinogradov, A. & Hashimoto, S. Multiscale Phenomena in Fatigue of Ultra-Fine Grain Materials-an  
494 Overview. *Materials Transactions* **42**, 74-84 (2001).
- 495 36 Liu, K., Nene, S. S., Frank, M., Sinha, S. & Mishra, R. S. Extremely high fatigue resistance in an ultrafine  
496 grained high entropy alloy. *Applied Materials Today* **15**, 525-530, doi:10.1016/j.apmt.2019.04.001  
497 (2019).
- 498 37 Prasad, A. *et al.* Towards understanding grain nucleation under Additive Manufacturing solidification  
499 conditions. *Acta Materialia* **195**, 392-403, doi:<https://doi.org/10.1016/j.actamat.2020.05.012> (2020).
- 500 38 Fan, Z. *et al.* Grain refining mechanism in the Al/Al-Ti-B system. *Acta Materialia* **84**, 292-304,  
501 doi:<https://doi.org/10.1016/j.actamat.2014.10.055> (2015).
- 502 39 StJohn, D. H., Qian, M., Easton, M. A. & Cao, P. The Interdependence Theory: The relationship between  
503 grain formation and nucleant selection. *Acta Materialia* **59**, 4907-4921,  
504 doi:<https://doi.org/10.1016/j.actamat.2011.04.035> (2011).
- 505 40 Qu, M. *et al.* Controlling process instability for defect lean metal additive manufacturing. *Nature*  
506 *Communications* **13**, 1079, doi:10.1038/s41467-022-28649-2 (2022).

507  
508  
509  
510  
511  
512  
513  
514  
515  
516

517 **Acknowledgments:** We acknowledge L.A. Jiao and X.J. Cao from Carl Zeiss (Shanghai) for  
518 their aid in micro-CT analysis and micro-CT-guided laser polishing experiment, as well as W.  
519 Li from Tescan China for his support on FIB-SEM experiments.

520 **Funding:**

521 National Natural Science Foundation of China grant 51971137 (ZC)

522 National Natural Science Foundation of China grant 52101043 (CD)

523 National Natural Science Foundation of China grant 52101179 (JL)

524 Conseil Regional du Nord-Pas de Calais (GJ)

525 European Regional Development Fund (ERDF, GJ)

526 **Author contributions:**

527 Conceptualisation: ZC, JL

528 Methodology: YW, CD, HW, HL, MW, QS, SM, LW

529 Investigation: CD, YC, YW, HC, GJ, YX, AA, JL

530 Visualisation: CD, YL, HC, YZ, HL,

531 Funding acquisition: ZC, CD, GJ, HW

532 Project administration: ZC, CD, YW

533 Supervision: ZC, JL

534 Writing – original draft: ZC, CD

535 Writing – review & editing: ZC, JL, CD, YC

536 **Competing interests:** Authors declare that they have no competing interests.

537 **Data and materials availability:** All data are available in the main text or the supplementary  
538 materials. The data generated during and/or analysed during the current study are available  
539 from the corresponding author. Correspondence and requests for materials should be addressed  
540 to Zhe Chen.

541

## Extended data for

# Achieving Ultrahigh Fatigue-Resistant Al Alloys by Additive Manufacturing

Chengyi Dan<sup>1,2†</sup>, Yuchi Cui<sup>1†</sup>, Yi Wu<sup>2†</sup>, Zhe Chen<sup>1,2†\*</sup>, Hui Liu<sup>3</sup>, Gang Ji<sup>4</sup>, Yakai Xiao<sup>2</sup>, Han Chen<sup>2</sup>, Mingliang Wang<sup>1</sup>, Jun Liu<sup>2</sup>, Lei Wang<sup>2</sup>, Yang Li<sup>2</sup>, Ahmed Addad<sup>4</sup>, Ying Zhou<sup>2</sup>, Siming Ma<sup>2</sup>, Qiwei Shi<sup>2</sup>, Haowei Wang<sup>1,2</sup>, Jian Lu<sup>3\*</sup>

Correspondence to: [zhe.chen@sjtu.edu.cn](mailto:zhe.chen@sjtu.edu.cn), [jianlu@cityu.edu.hk](mailto:jianlu@cityu.edu.hk).

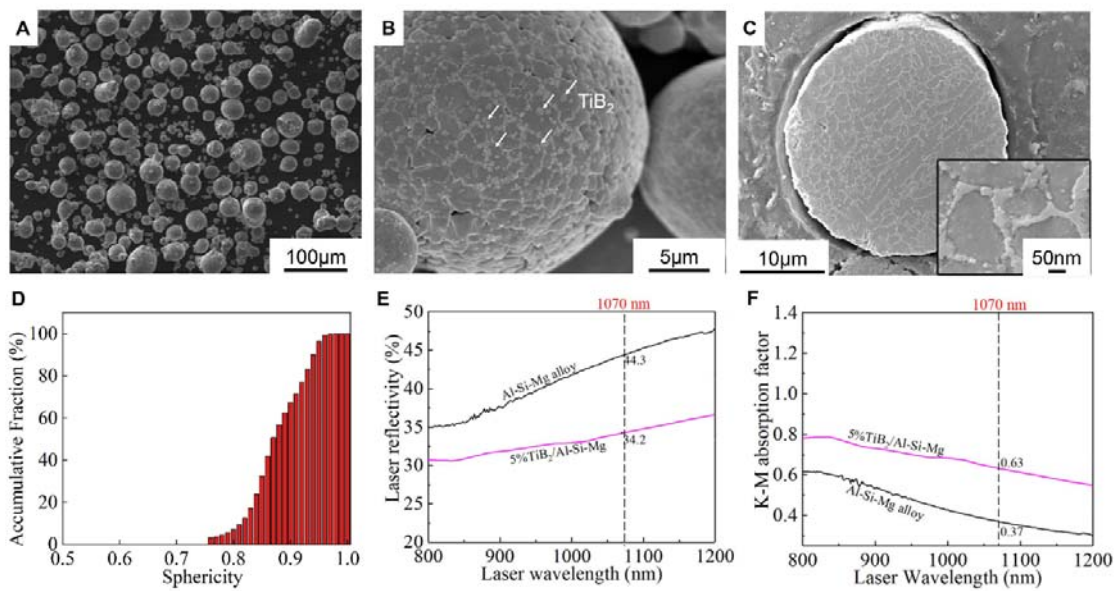

**Extended Data Fig. 1 AlSi10Mg powders decorated with TiB<sub>2</sub> nanoparticles. (A-B)**

TiB<sub>2</sub>/AlSi10Mg powders with spherical morphology. (C) Cross-section of powder showing the

homogeneously distributed Si cells and TiB<sub>2</sub> particles. (D) Statistic analysis of the sphericity

of TiB<sub>2</sub>/AlSi10Mg powders. The laser reflectivity (E) and K-M absorption factor (F) of the

AlSi10Mg and 5% TiB<sub>2</sub>/AlSi10Mg powders. The laser absorption rate of 5% TiB<sub>2</sub>/AlSi10Mg

powders have been significantly increased by introducing nano-TiB<sub>2</sub> particles.



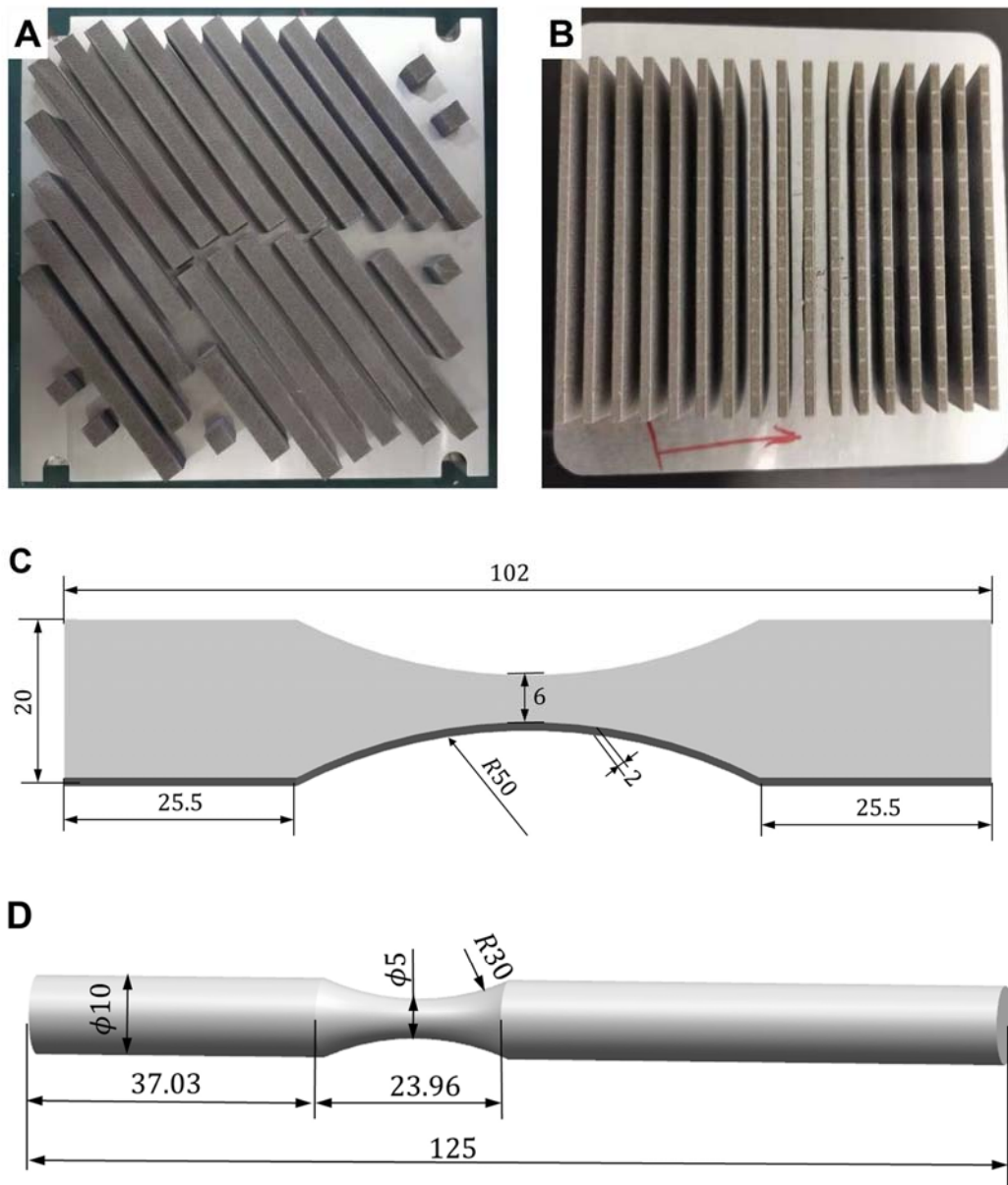

561

562 **Extended Data Fig. 2 As-printed NTD-Al alloy fatigue testing specimens.** (A) Samples  
 563 constructed by machine EOS M280. (B) Samples constructed by machine 3D Systems ProX  
 564 MP 200. **Schematics of fatigue testing specimen dimensions.** (C) Pull-pull fatigue test

565 sample geometry in mm,  $R = 0.1$  (ASTM E466-21). (D) Rotating bending fatigue test sample  
 566 geometry in mm,  $R = -1$  (ISO 1143-2008).  
 567

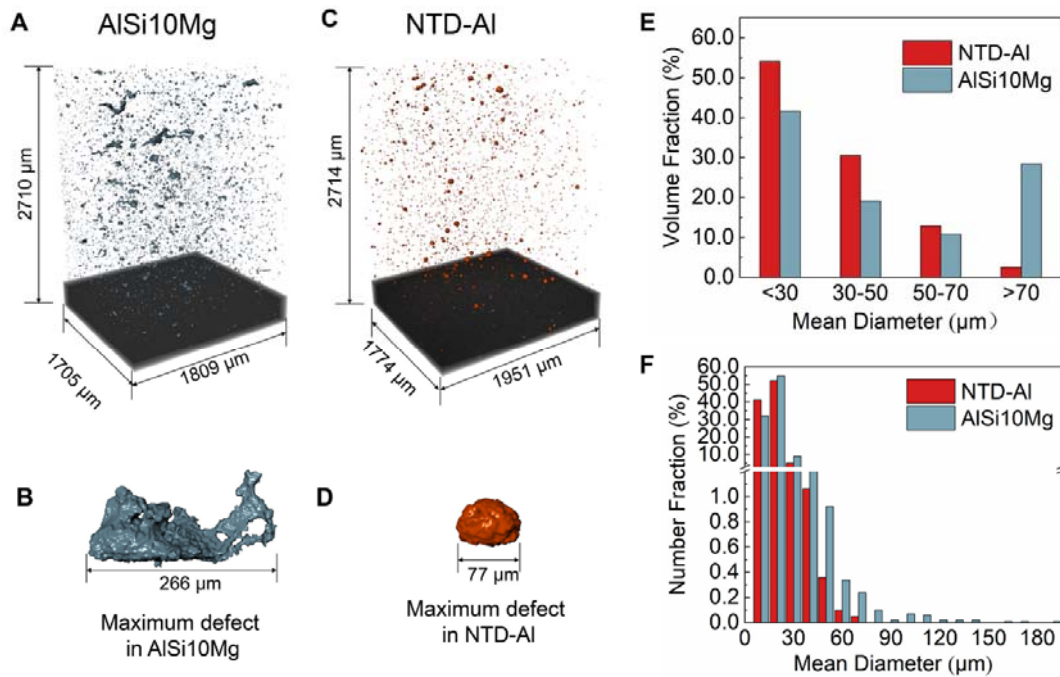

568  
 569 **Extended Data Fig. 3 μ-CT analysis showing the spatial and size distributions of defects.**  
 570 (A) Defects with irregular morphology in AM AlSi10Mg alloy. (B) The maximum defect in  
 571 the AlSi10Mg sample with the length about 266 μm. (C) Defects with near spherical  
 572 morphology in AM NTD-Al alloy manufactured by EOS M280. (D) The maximum defect in  
 573 the NTD-Al sample with the diameter about 77 μm. (E-F) Comparison of number and volume  
 574 fractions of defects in different size ranges.

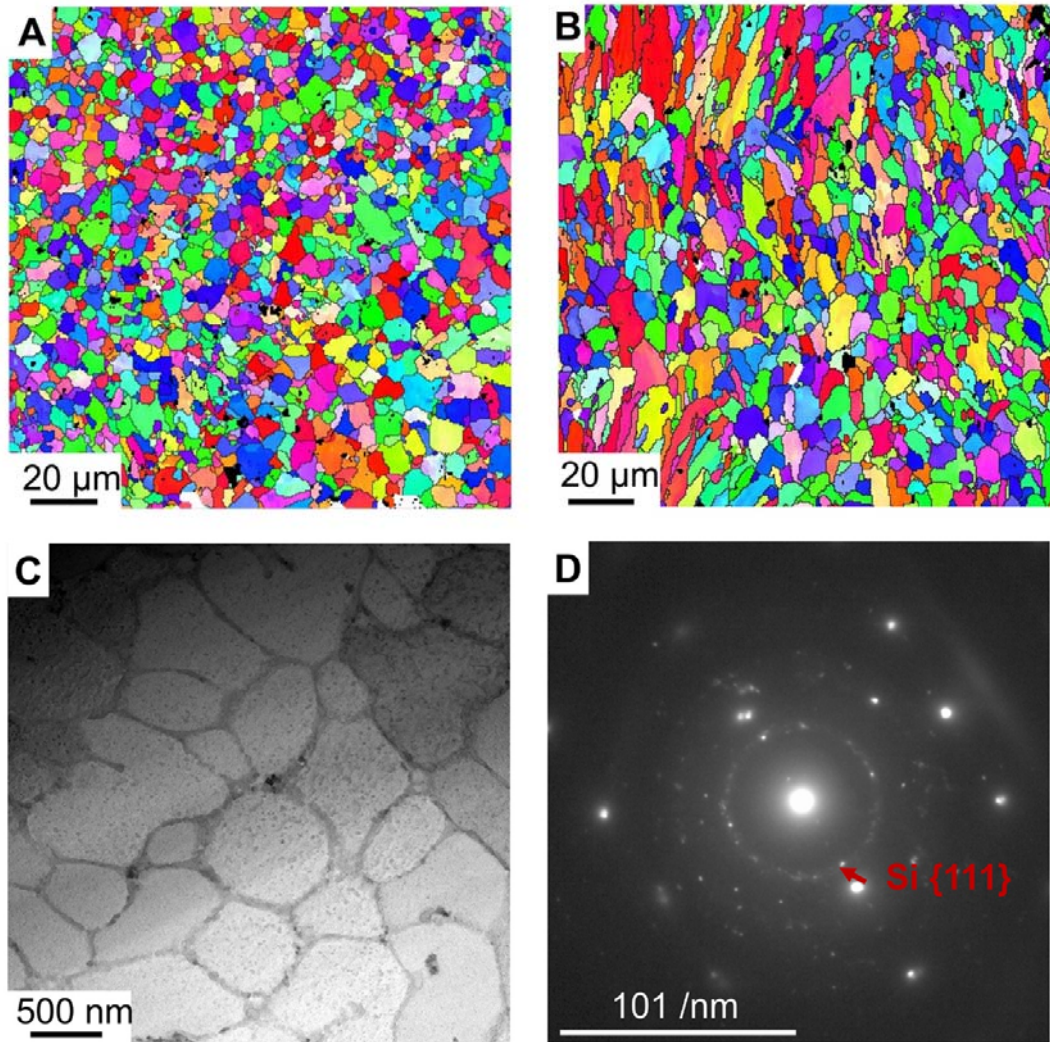

575

576 **Extended Data Fig. 4 Microstructure characterisation of the NTD-Al sample**

577 **manufactured by EOS M280.** (A) Grain morphology of the plane perpendicular to the

578 printing direction. (B) Grain morphology of the plane parallel to the printing direction. (C)

579 Network of solidification cellular structure with an average diameter of ~ 500 nm. (D) Selected-

580 area electron diffraction pattern indicating that Si existed as nanosized phases with random

581 orientations.

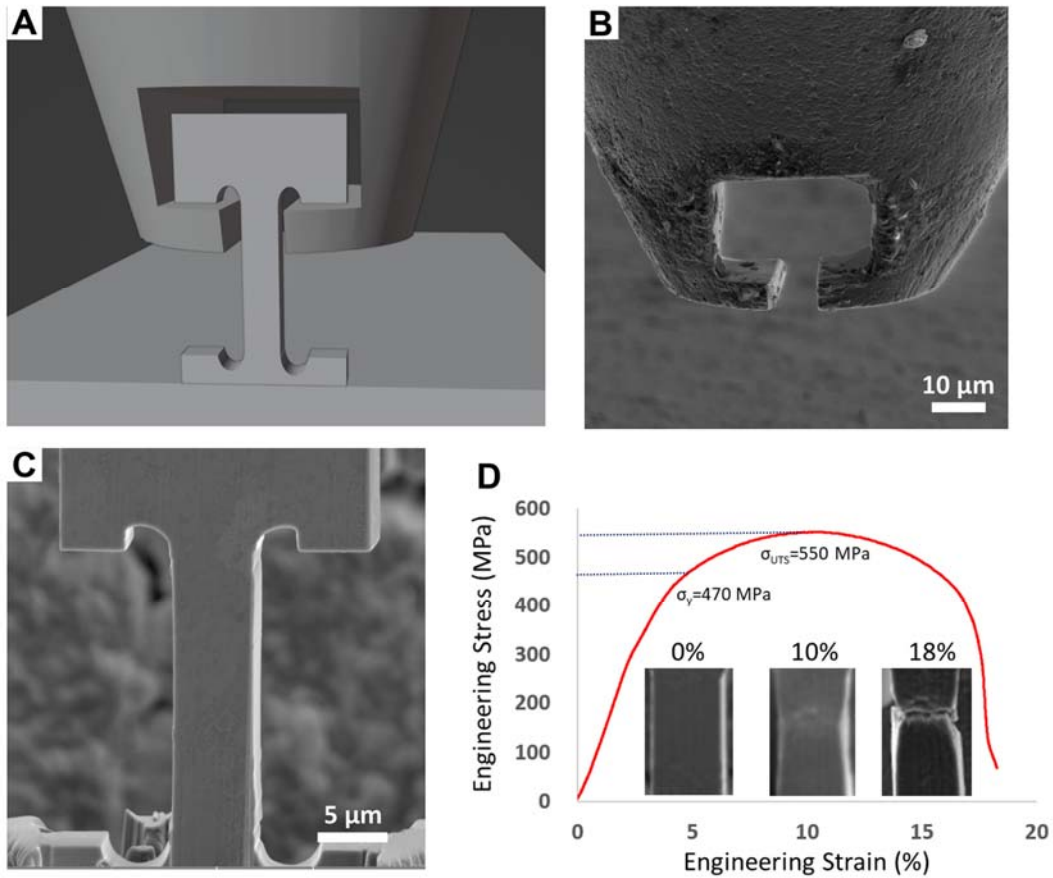

582

583 **Extended Data Fig. 5 *In situ* micro-mechanical testing.** (A) Geometry of the tensile grip  
 584 and micro-specimen. SEM images of (B) the customised diamond tensile grip and (C) the  
 585 micro-specimen. (D) Stress-strain curve measured from the *in situ* micro-tensile test, inset:  
 586 SEM images of the necked region at different strain levels.

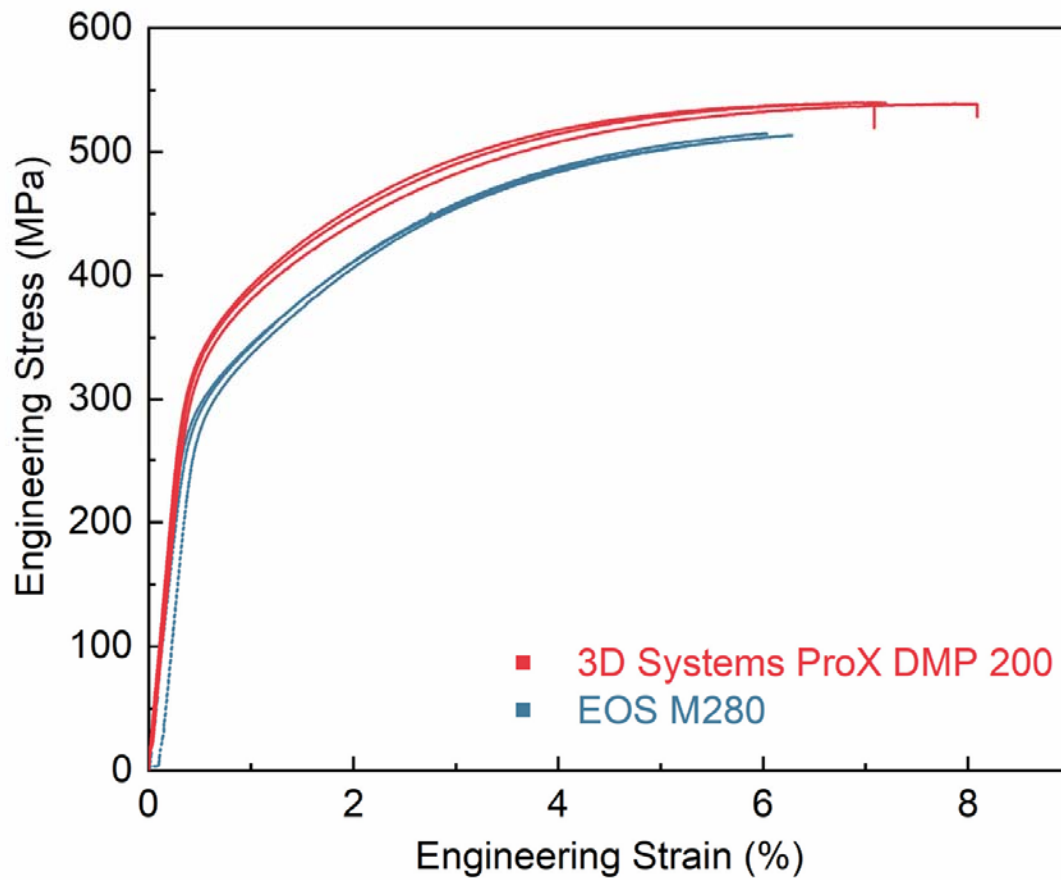

587

588 **Extended Data Fig. 6 Tensile Properties of as-printed NTD-Al.** Engineering stress–strain

589 curves of as-printed NTD-Al alloys by the two additive manufacturing machines.



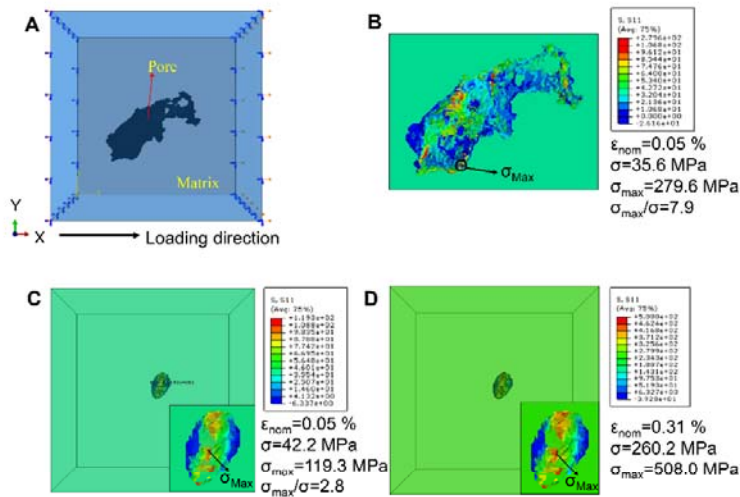

E	Defects in AlSi10Mg alloy									
	Stress concentration factor	7.9	6.1	7.3	6.2	5.2	7.8	7.7	7.0	
	Pores in NTD-Al alloy									
	Stress concentration factor	2.8	2.4	2.3	2.3	2.2	2.3	2.5	3.0	
		→ Loading direction								

590

591 **Extended Data Fig. 7 FEM simulation of the stress concentration caused by the internal**

592 **pores in the AM AlSi10Mg alloy and AM NTD-Al alloy. (A) An example of the FEM model**

593 **with an irregular LOF defect inside the AM AlSi10Mg alloy matrix. (B) Stress distribution**

594 **near the typical LOF defect surface in the AM AlSi10Mg alloy under a nominal strain of 0.05%.**

595 **(C) Stress distribution of a typical spherical pore in the AM NTD-Al alloy under a nominal**

596 **strain of 0.05%. (D) Stress distribution of the typical spherical pore under a nominal strain of**

597 **0.31% when the stress of the matrix is close to the fatigue strength (~ 260 MPa). € Stress**

598 **concentration factors of nine large irregular LOF defects in the AM AlSi10Mg sample and nine**

599 **typical pores in the AM NTD-Al sample.**

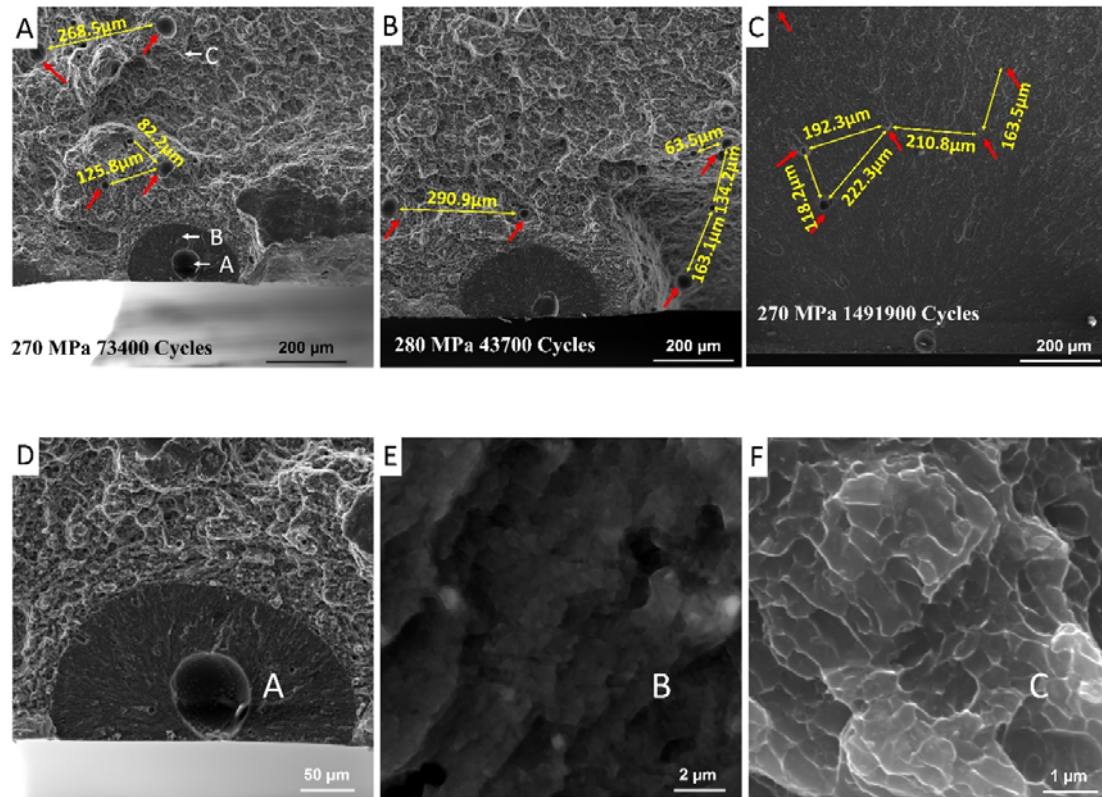

600

601 **Extended Data Fig. 8 Fractographic observations of fatigue failures in AM NTD-Al alloy.** (A-C) Fracture

602 surface of AM NTD-Al alloy at different fatigue loading strength,  $R=0.1$ ; (D-F) three typical regions pointed out

603 by white arrows in Extended Fig. 8A. The fatigue crack usually initiates at the largest pore next to the sample

604 surface. Many smaller defects were also found on the fracture surface. The interspacing between neighboring

605 defects ranges from tens to hundreds of microns. Obvious Si cellular boundaries were also found on the fracture

606 surface.

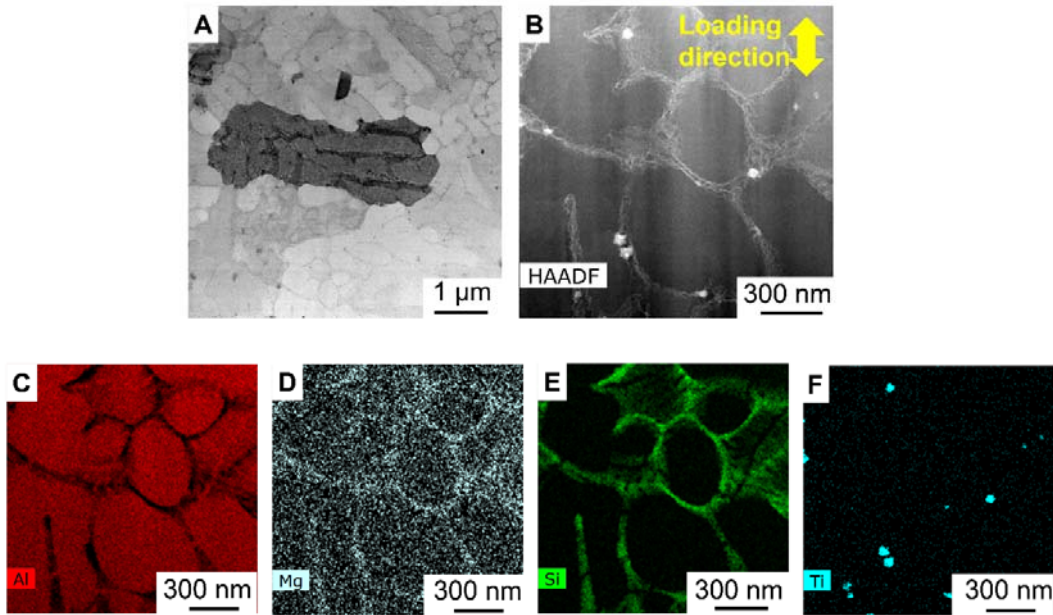

607

608 **Extended Data Fig. 9 Si cellular structure of the AM NTD-Al alloys after  $10^7$  fatigue**  
609 **testing cycles at a maximum stress of 260 MPa ( $R = 0.1$ ).** (A-B) HAADF STEM images  
610 showing the intact Si cellular structure. TEM samples were prepared from randomly selected  
611 area from the gauge section of the sample after fatigue testing. (C-F) EDS maps illustrating the  
612 distribution Al, Si, Mg and Ti elements.

613



614 **Extended Data Table 1 Chemical composition (wt.%) and additive manufacturing processing parameters**

615 **of NTD-Al and AlSi10Mg powders** (The corresponding weight and volume fractions of the TiB<sub>2</sub> nanoparticles

616 were ~ 5 wt.% and ~ 3.4 vol.%, respectively)

617

Element	Si	Mg	Cu	Mn	Ti	B	Al
NTD-Al	9.8	0.32	<0.03	<0.01	3.84	1.76	Balance
AlSi10Mg	10.1	0.32	<0.03	<0.01	/	/	Balance

Parameter	Laser power (W)	Laser diameter (μm)	Scanning speed (mm/s)	Layer thickness (μm)	Rotation angle (°)	Hatching space (μm)
AlSi10Mg ProX DMP 200	280	75	1000	30	66.7°	100
NTD-Al ProX DMP 200	280	75	1200	30	66.7°	100
NTD-Al EOS M280	320	75	1000	30	66.7°	100

618

619

620

621

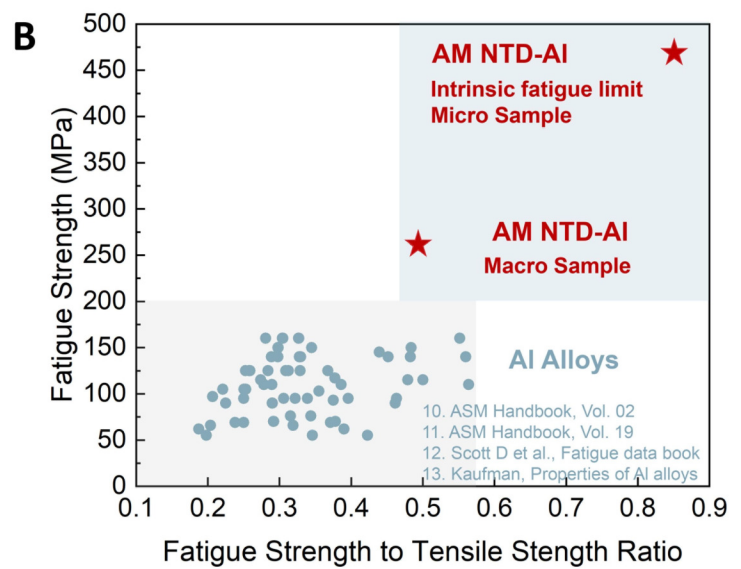
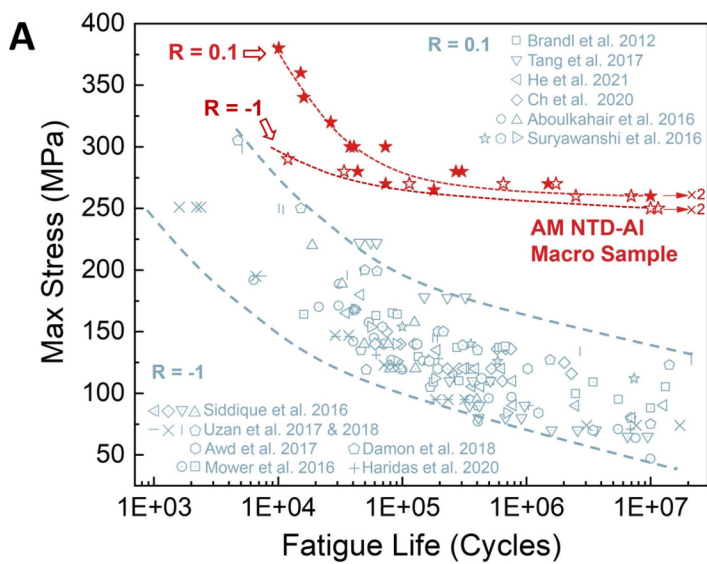

**C**

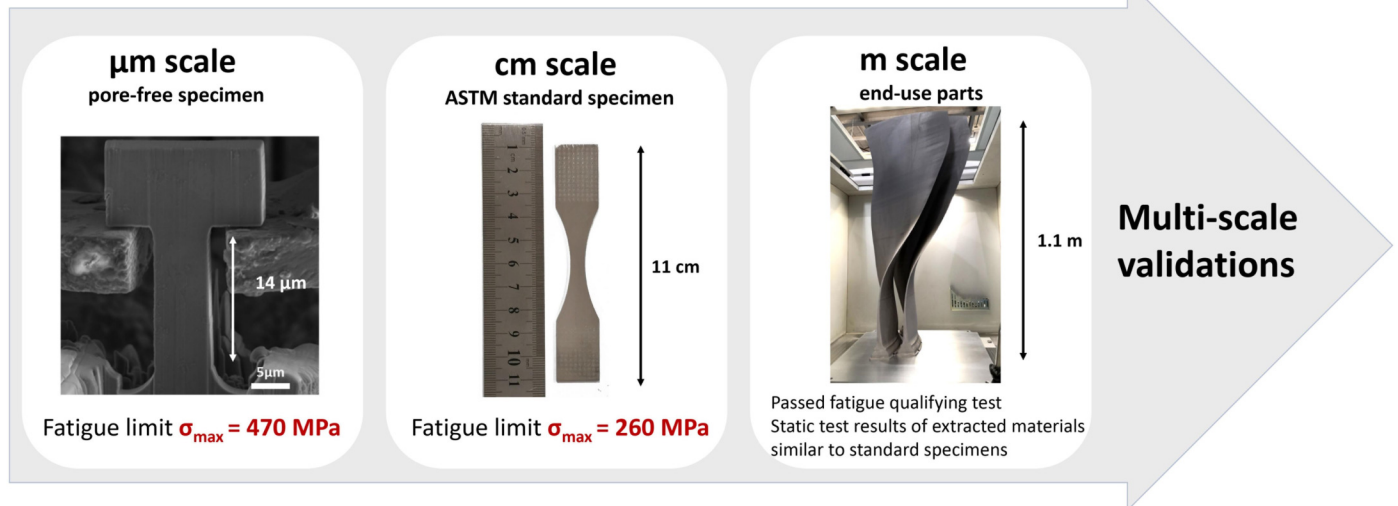

**D**

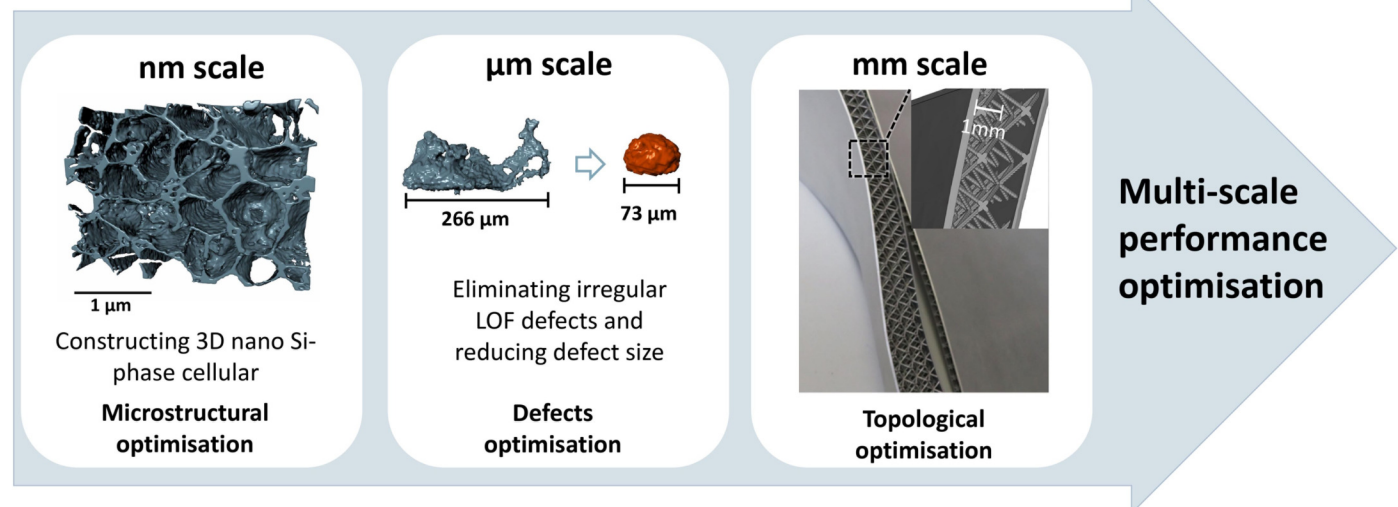

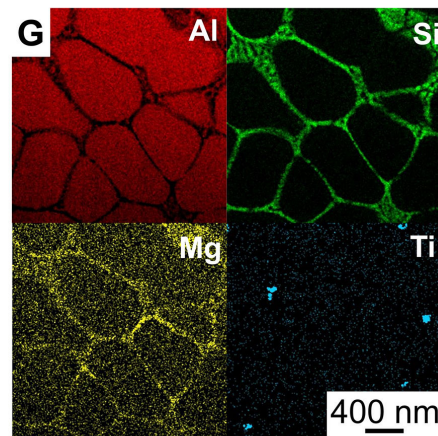
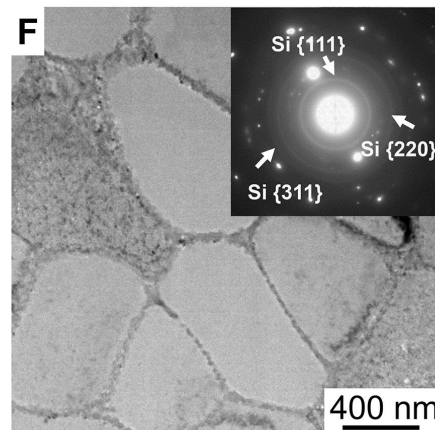
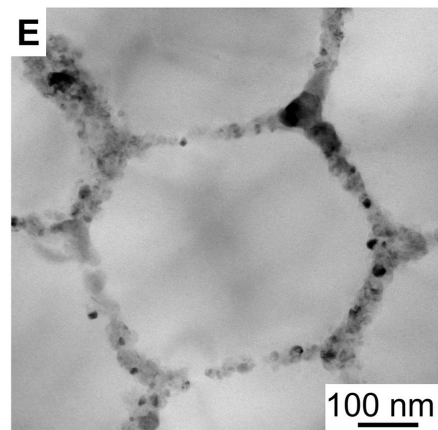
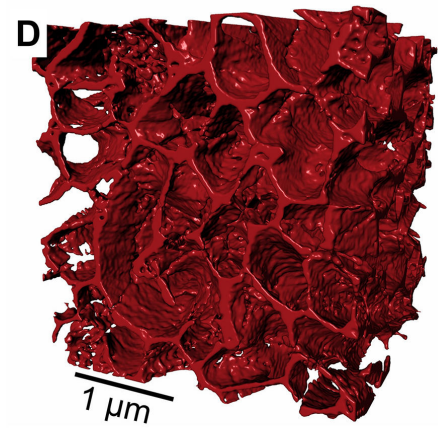
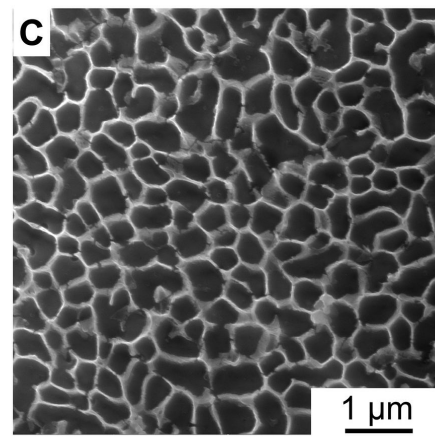
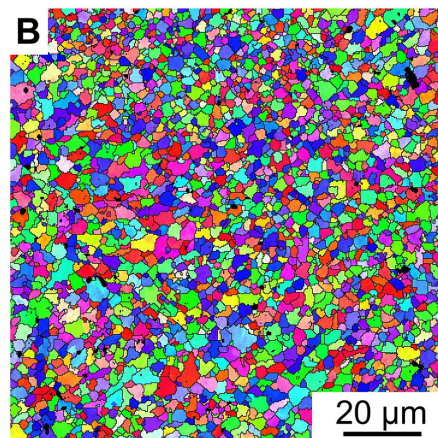
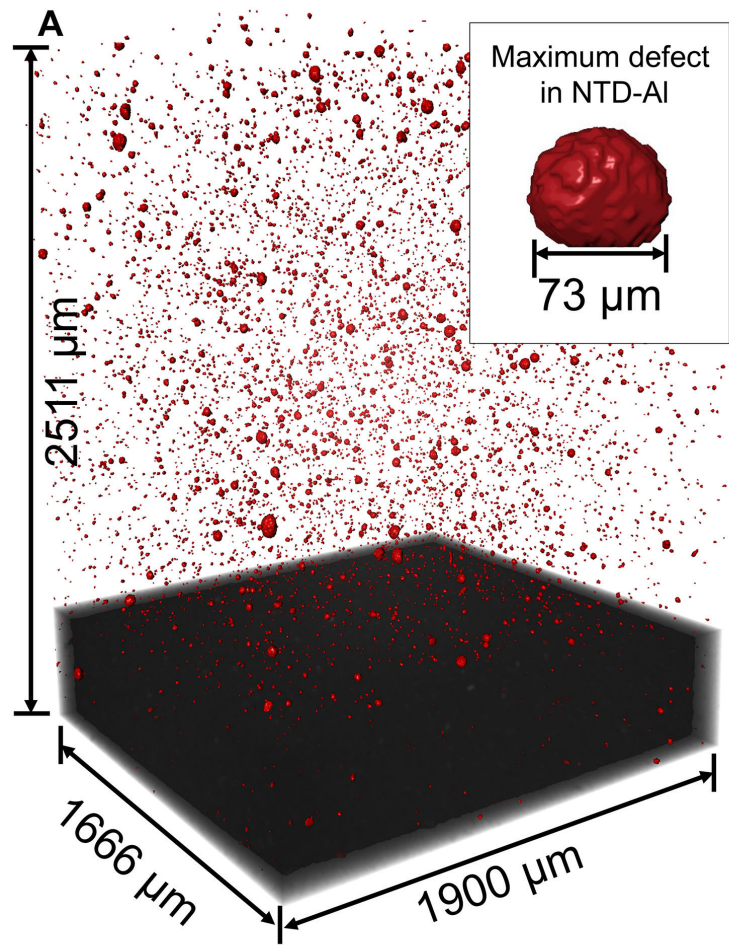



$\sigma_{\max} = 470 \text{ MPa}, R=0.1$

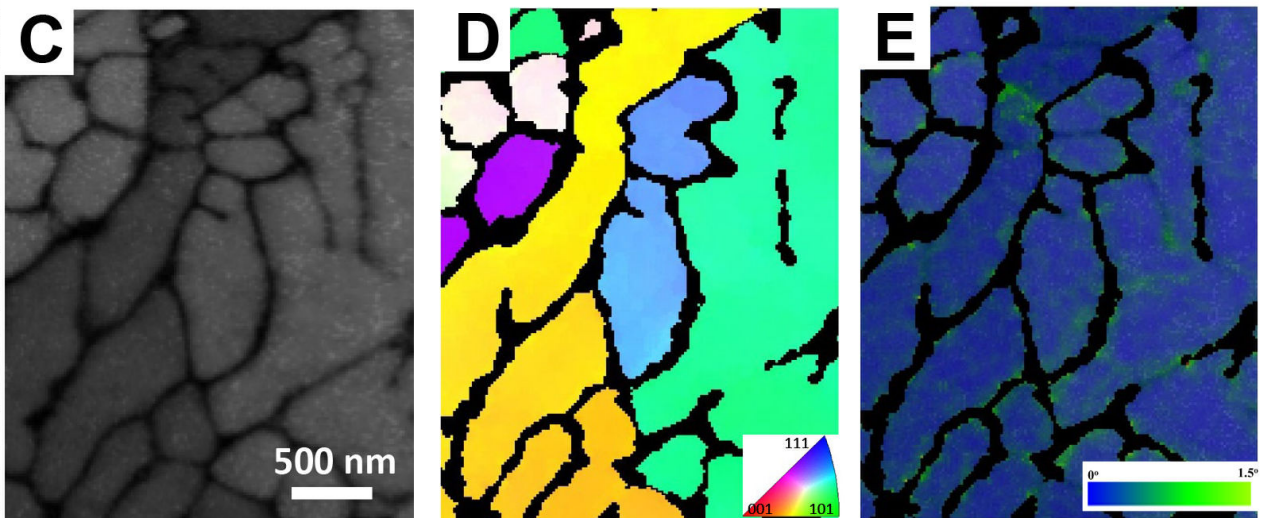
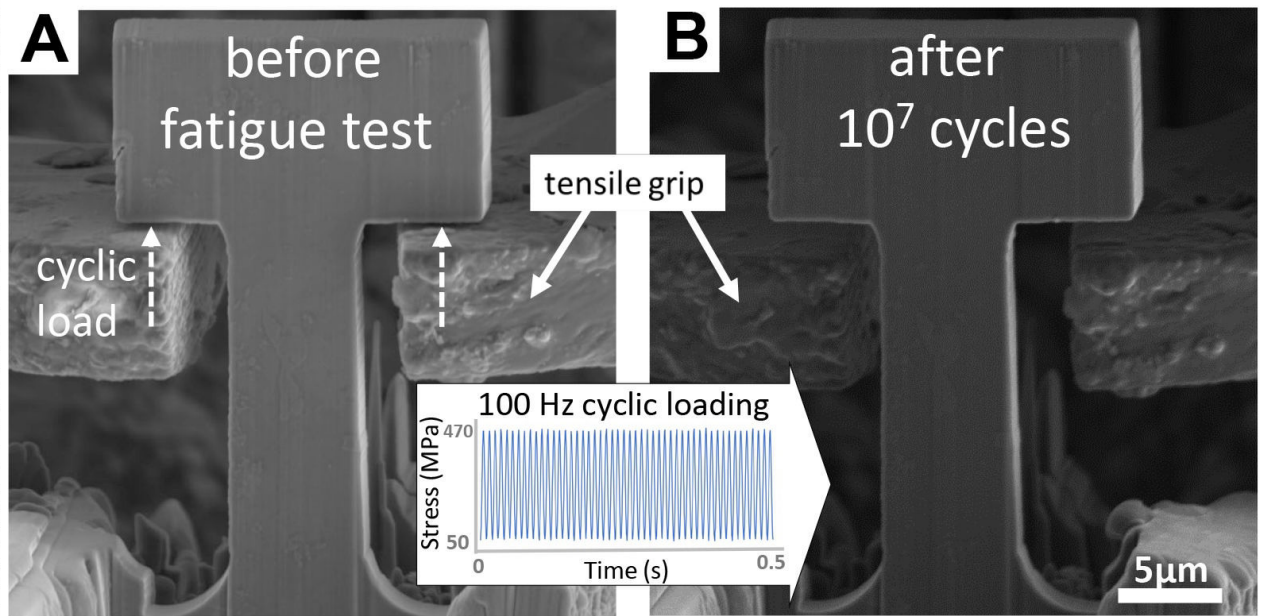

$\sigma_{\max} = 520 \text{ MPa}, R=0.1$

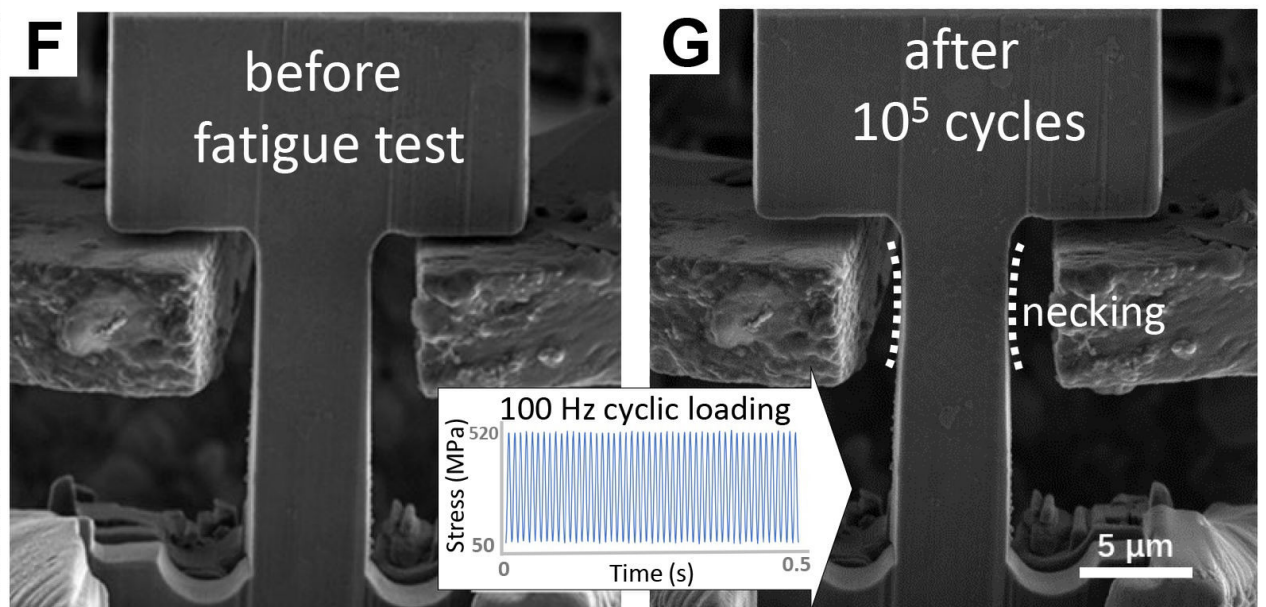



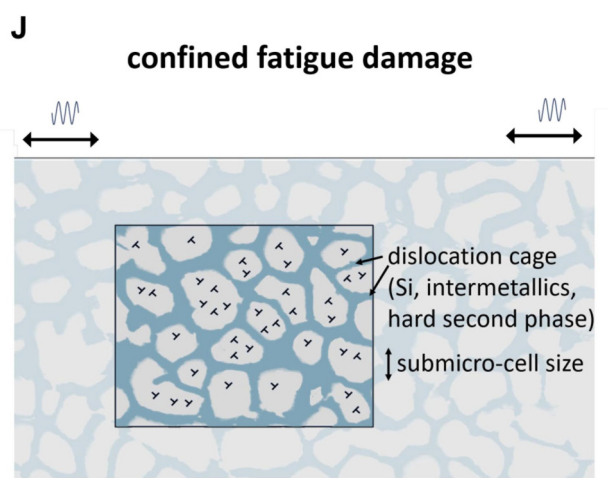
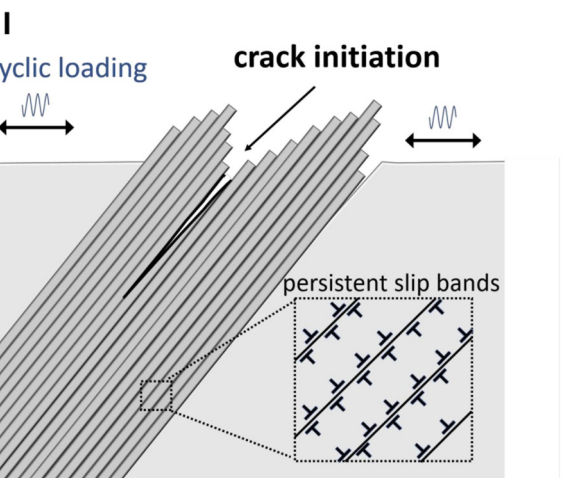
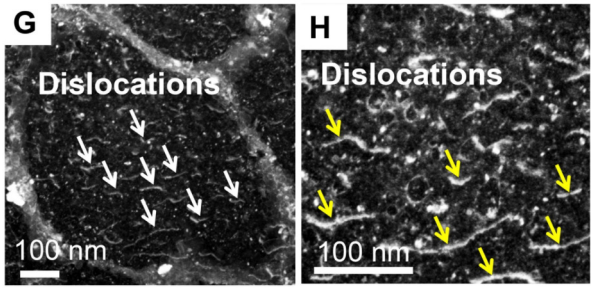
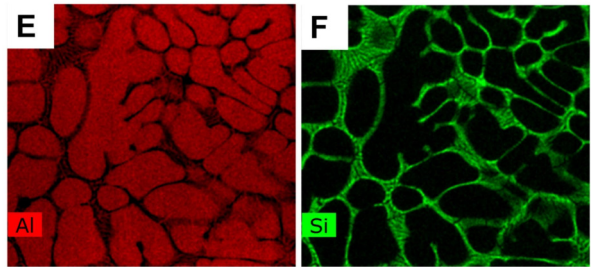
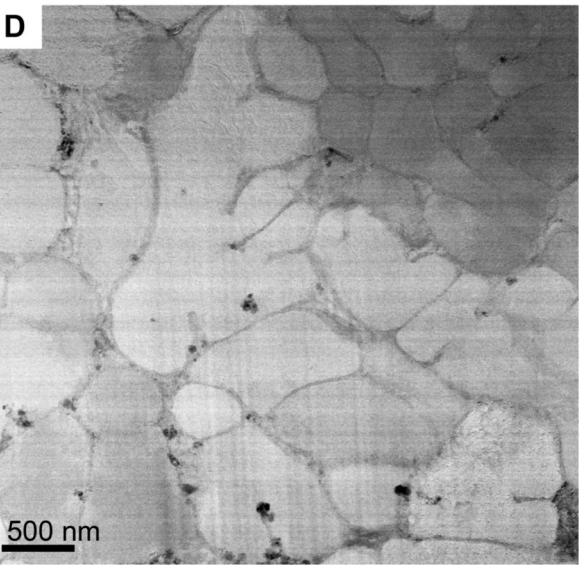
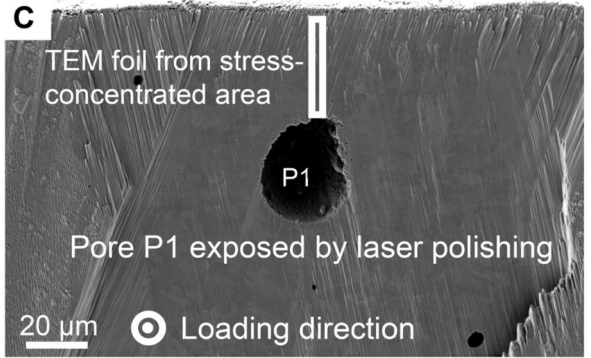
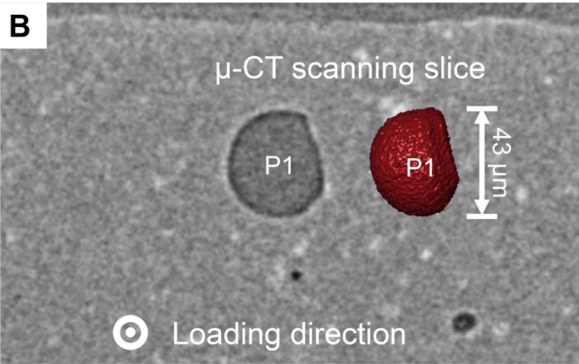
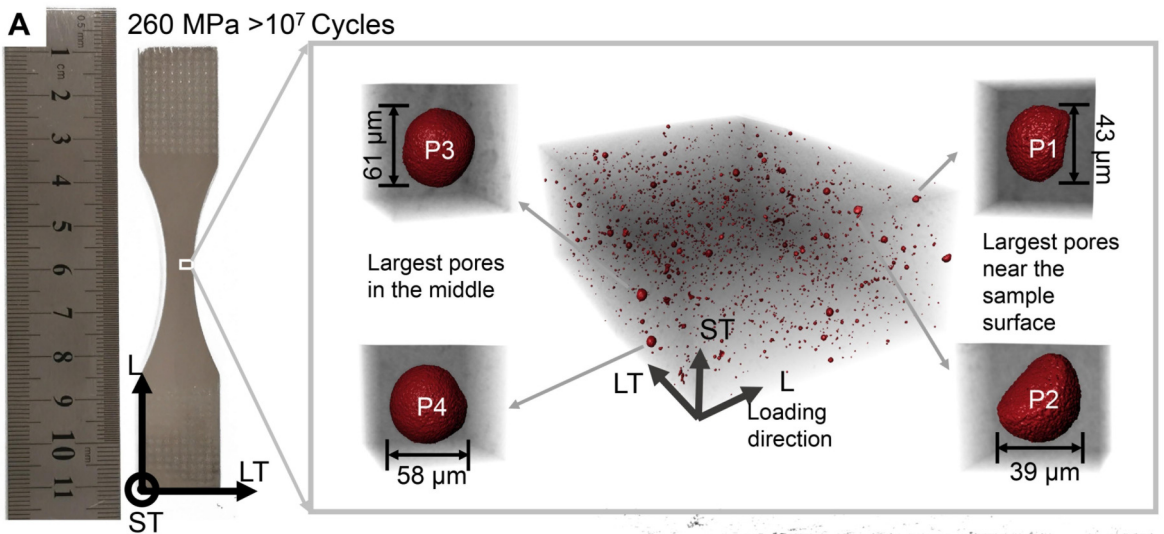

Fatigue damage originating from PSB

Fatigue immunisation mechanism

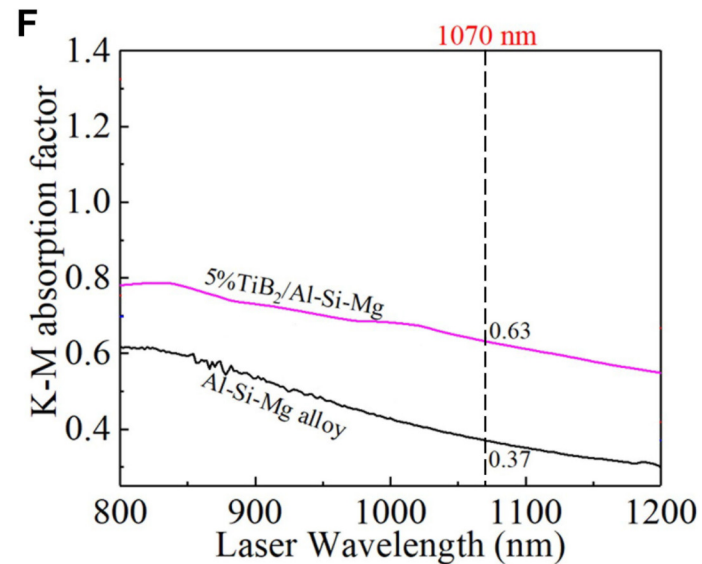
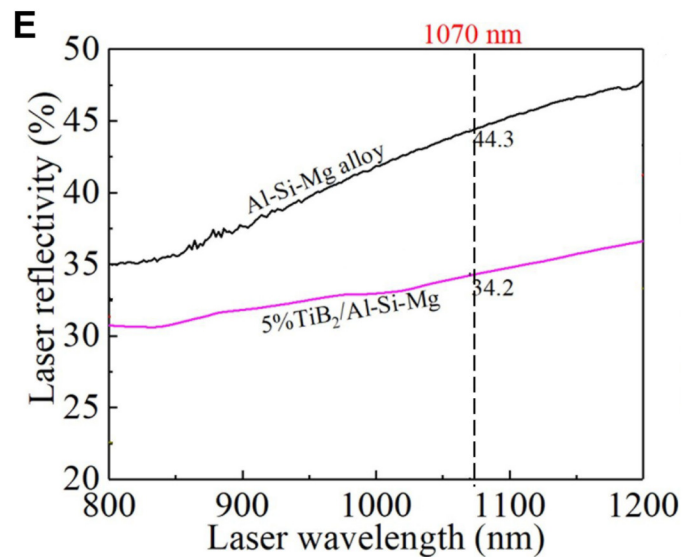
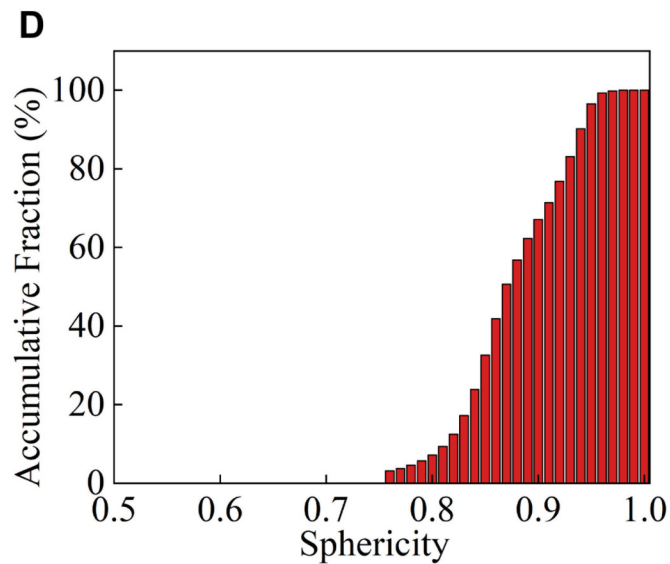
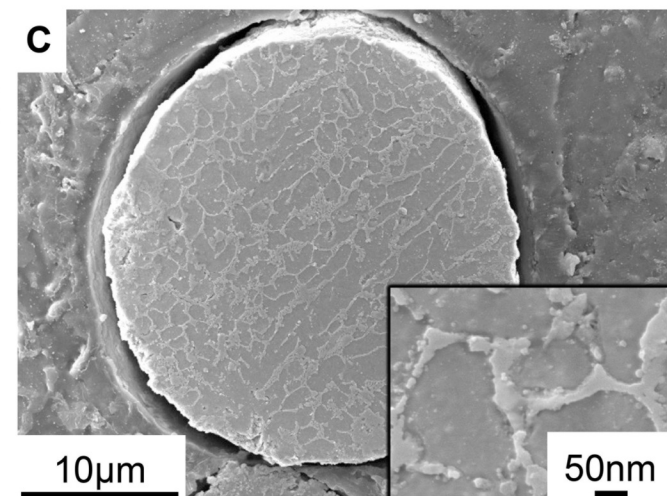
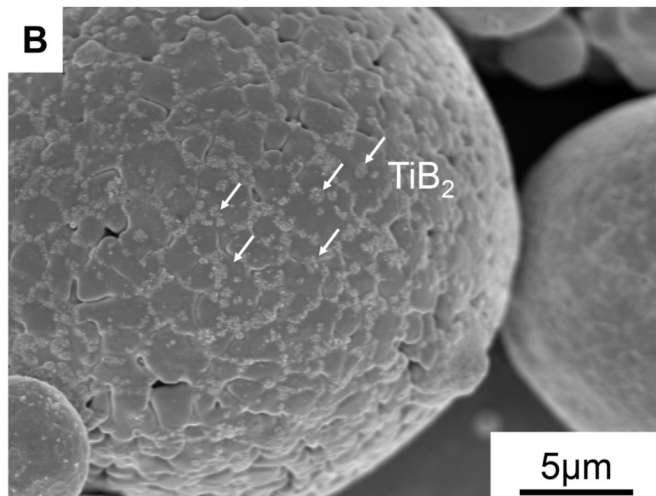
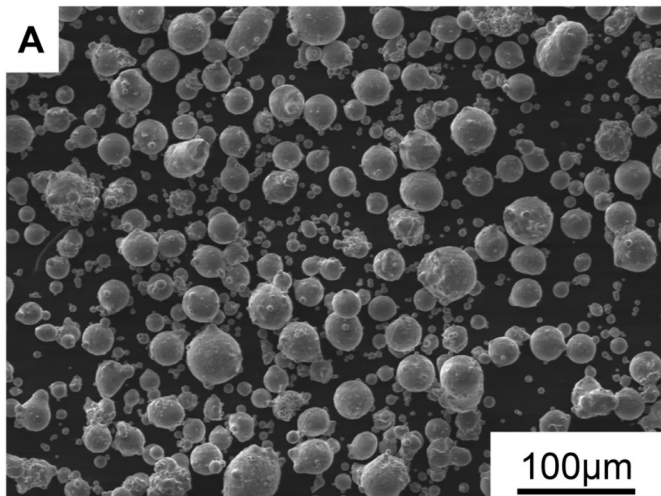



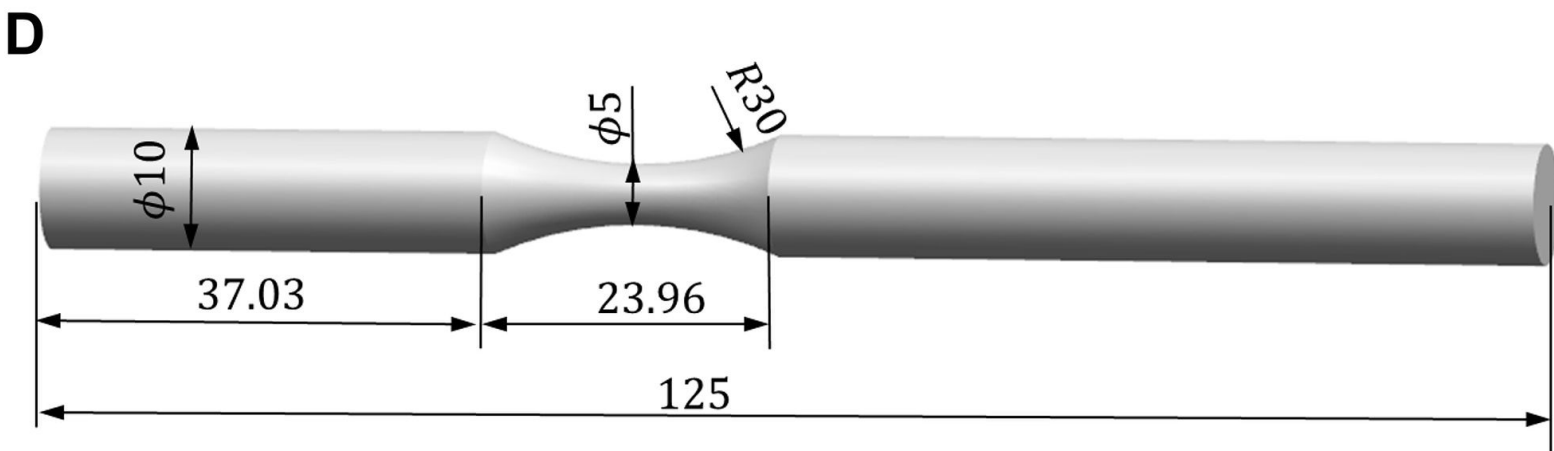
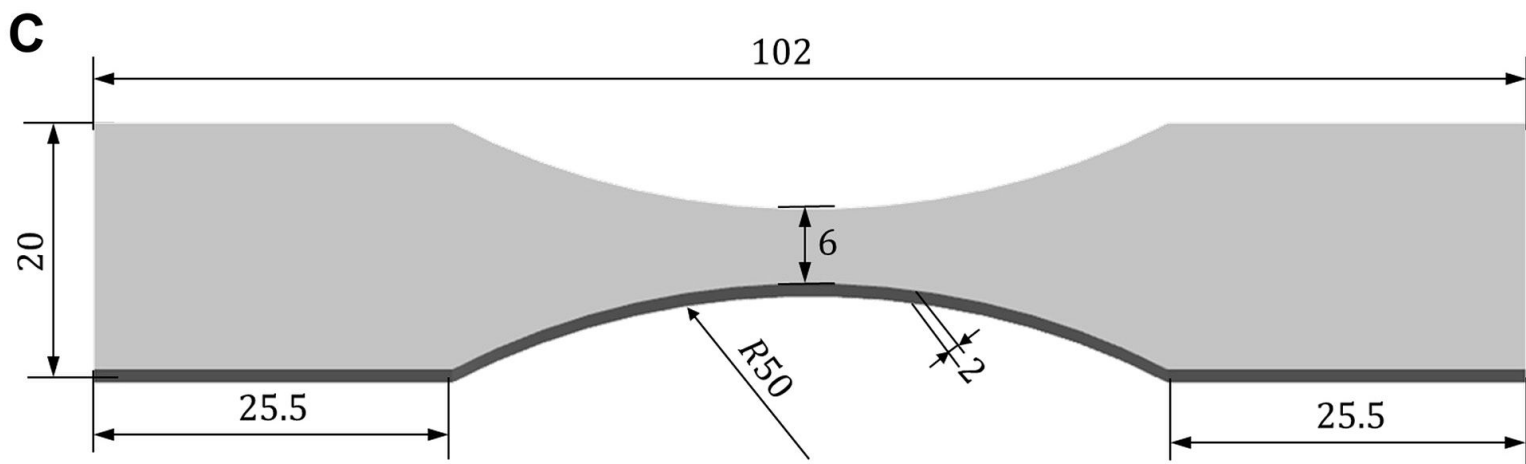
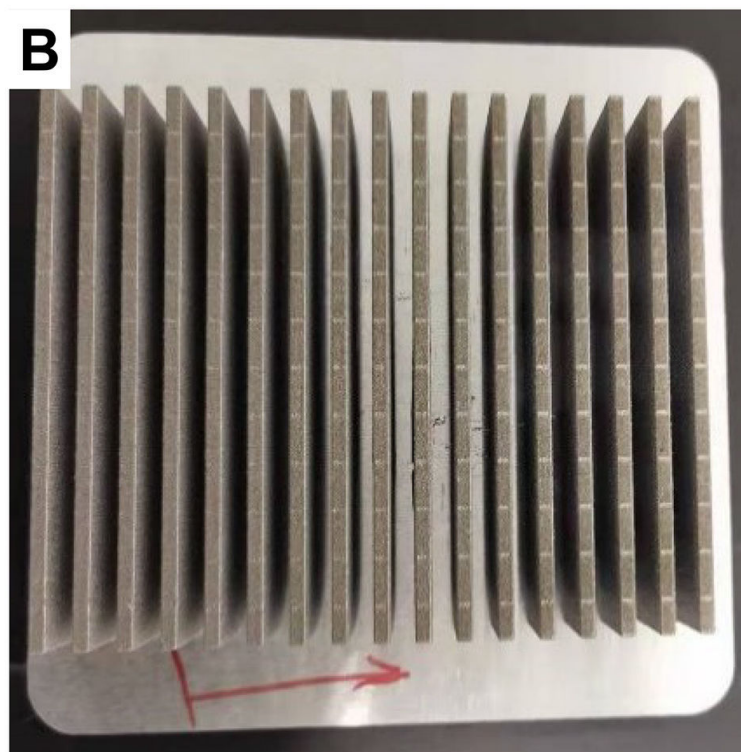
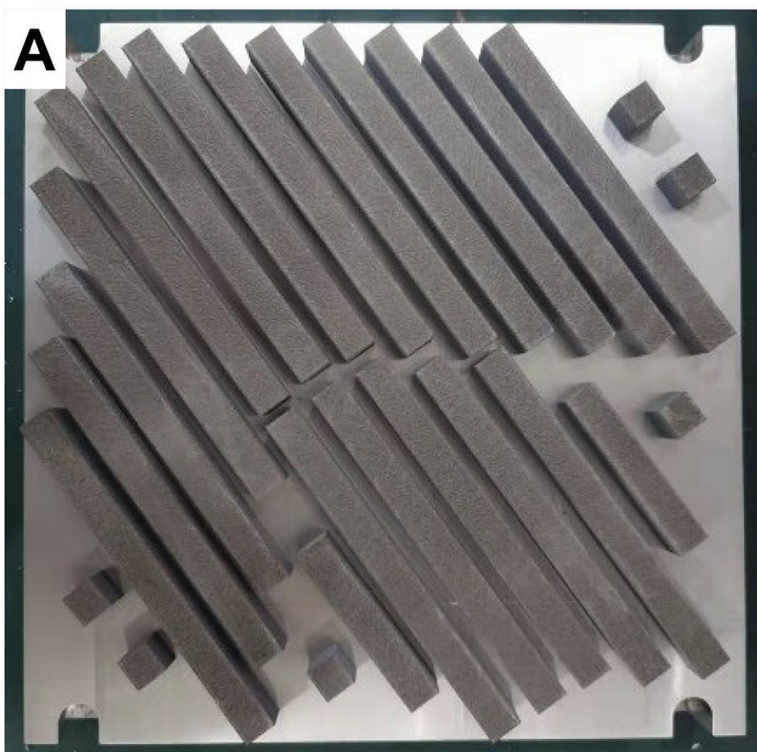

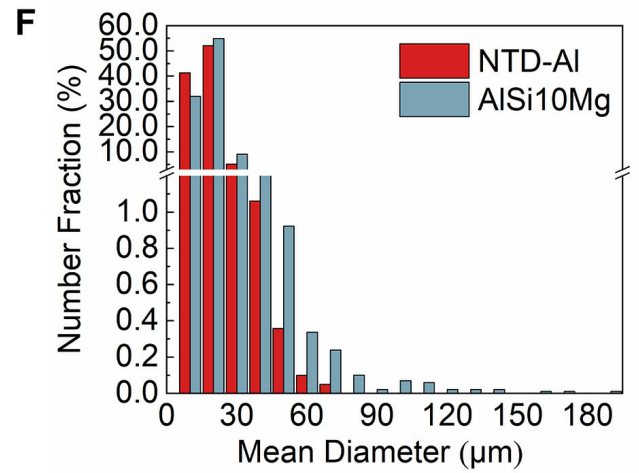
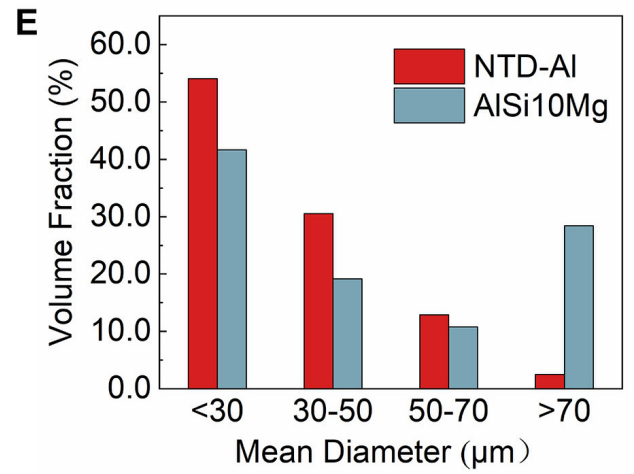
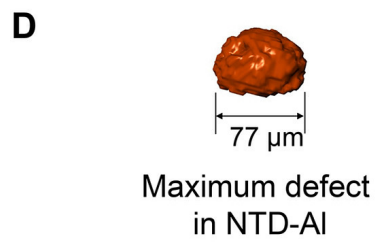
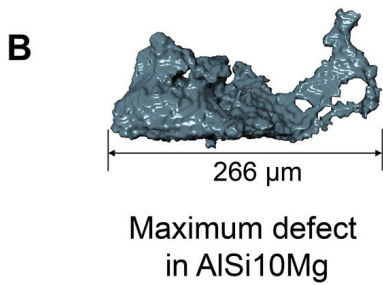
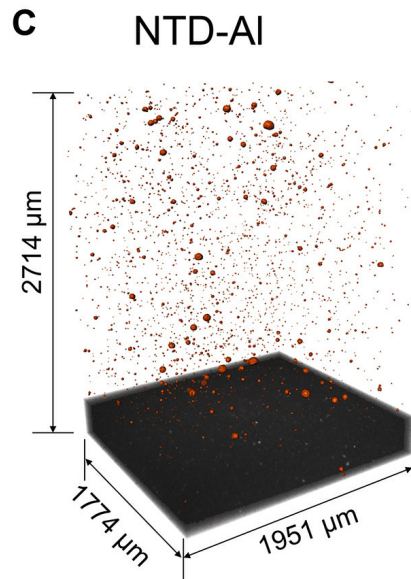
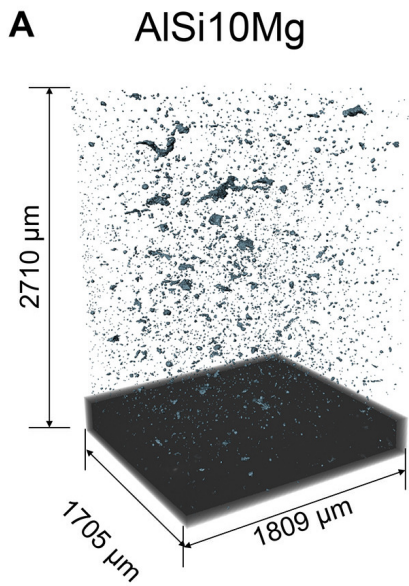



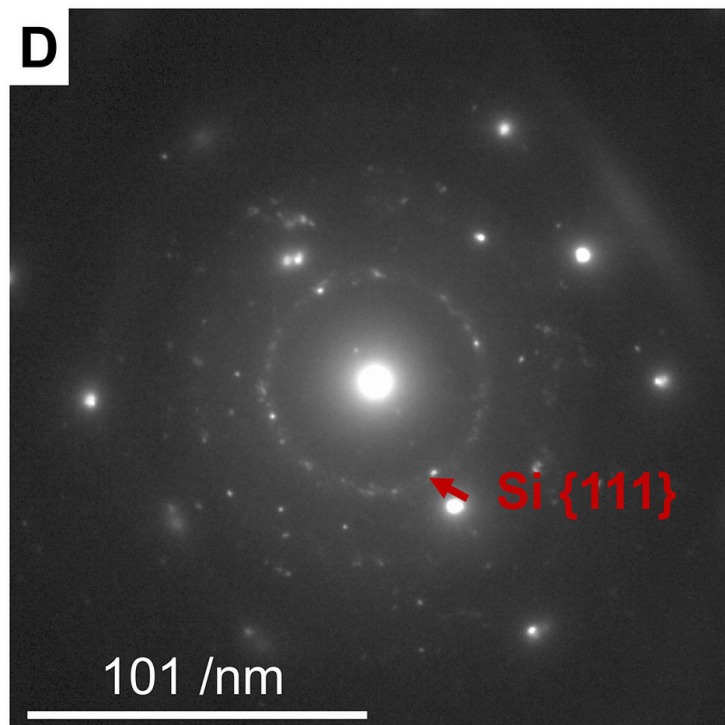
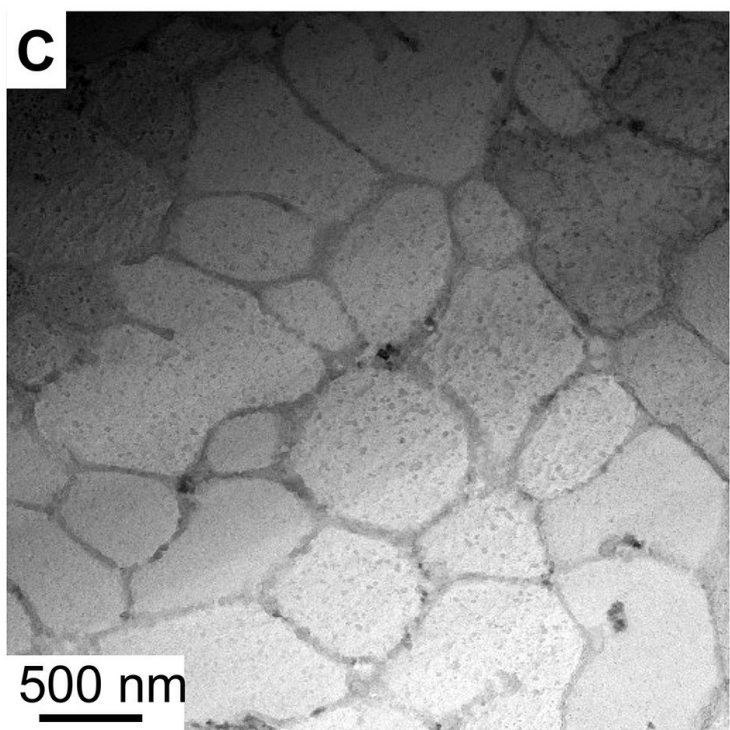
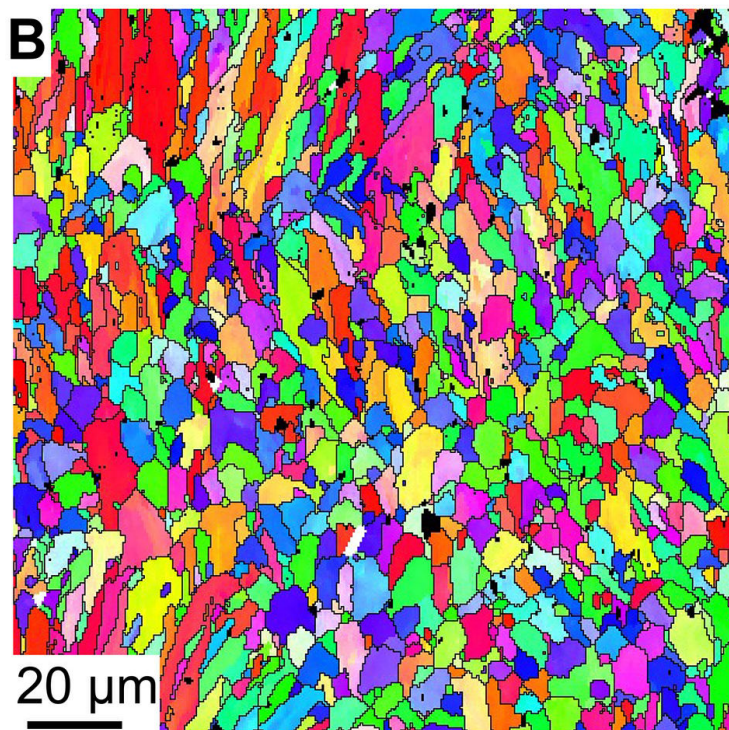
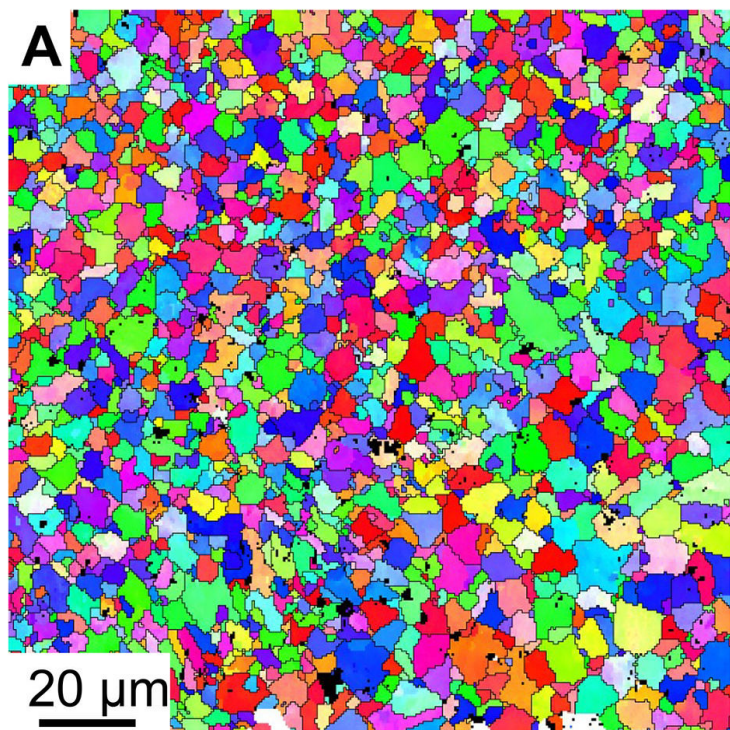



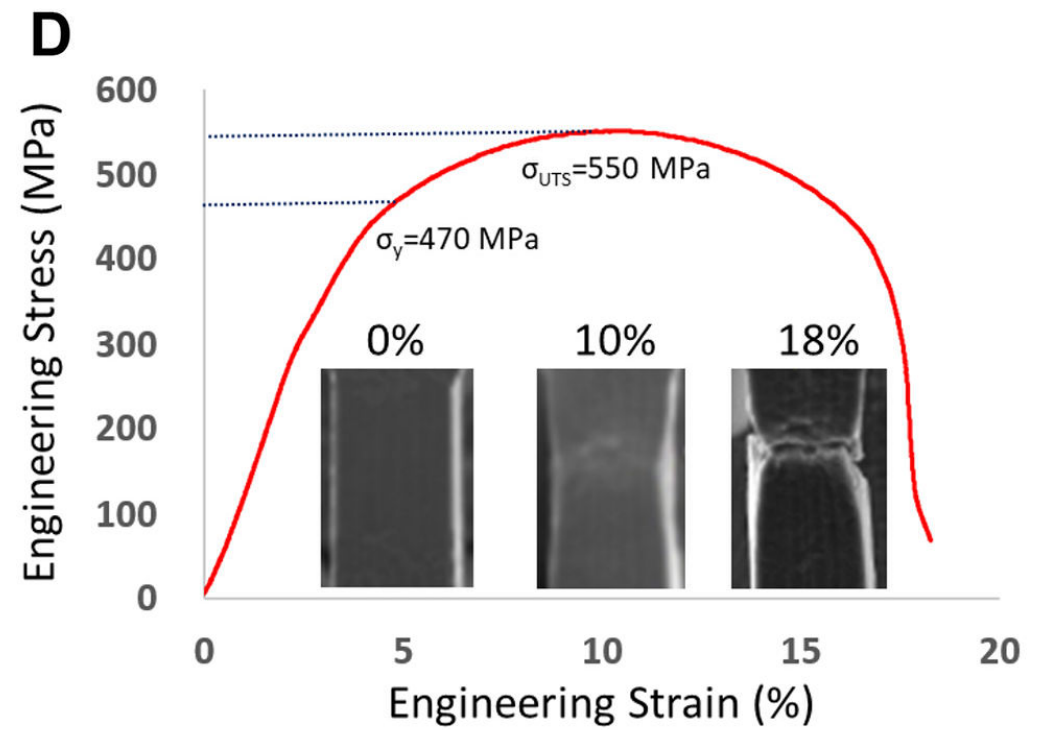
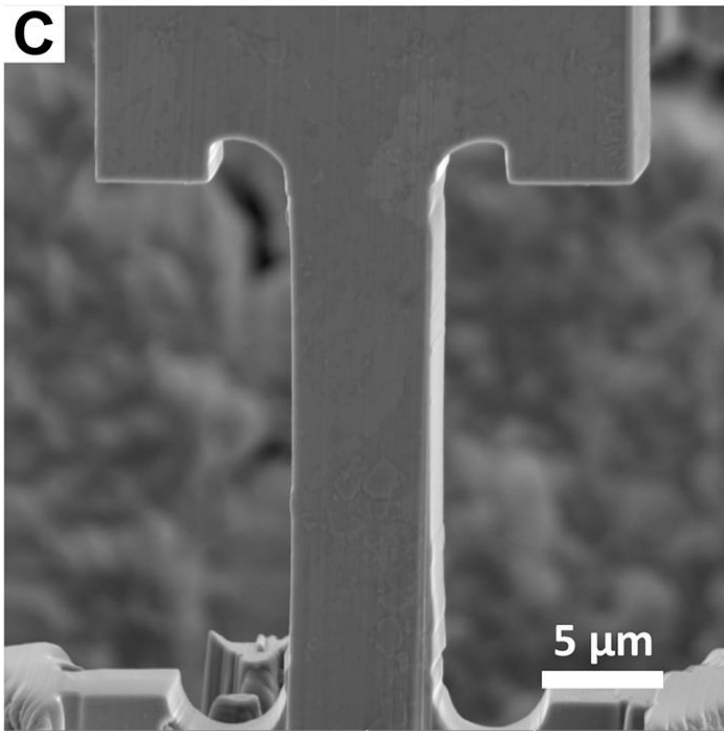
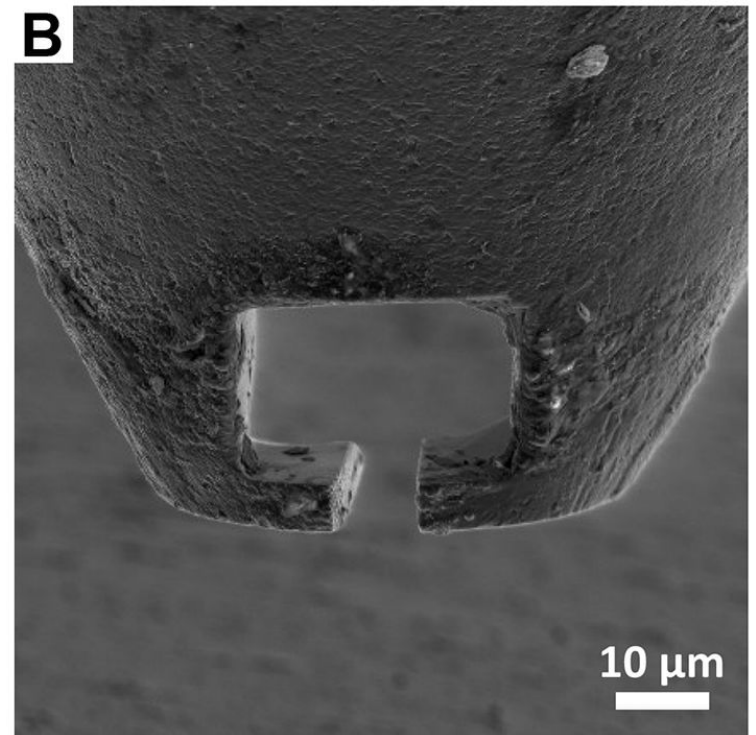
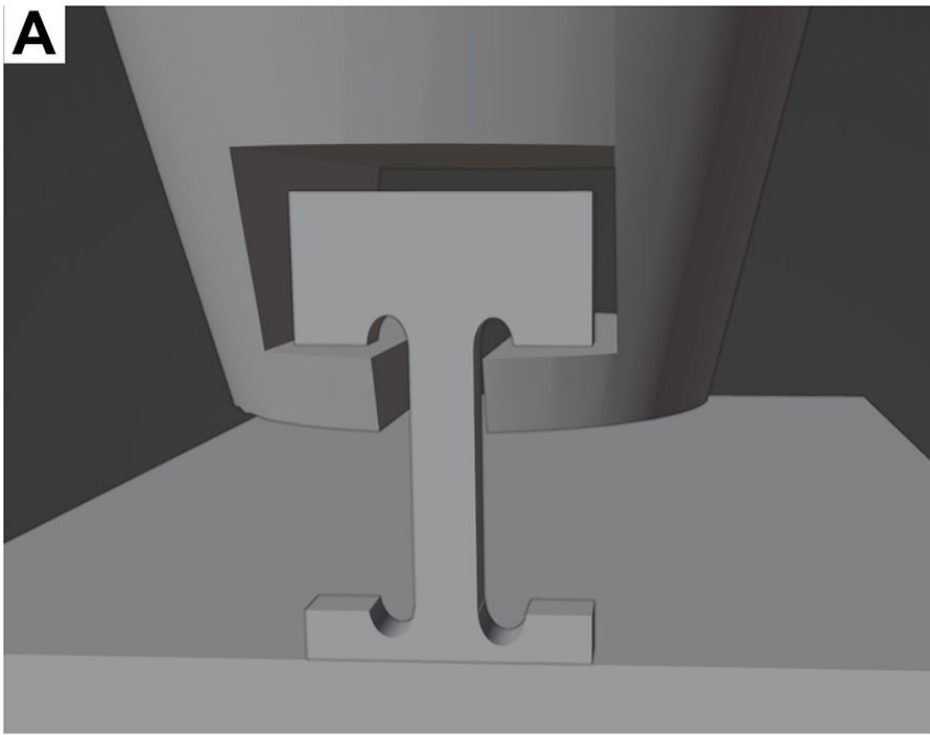

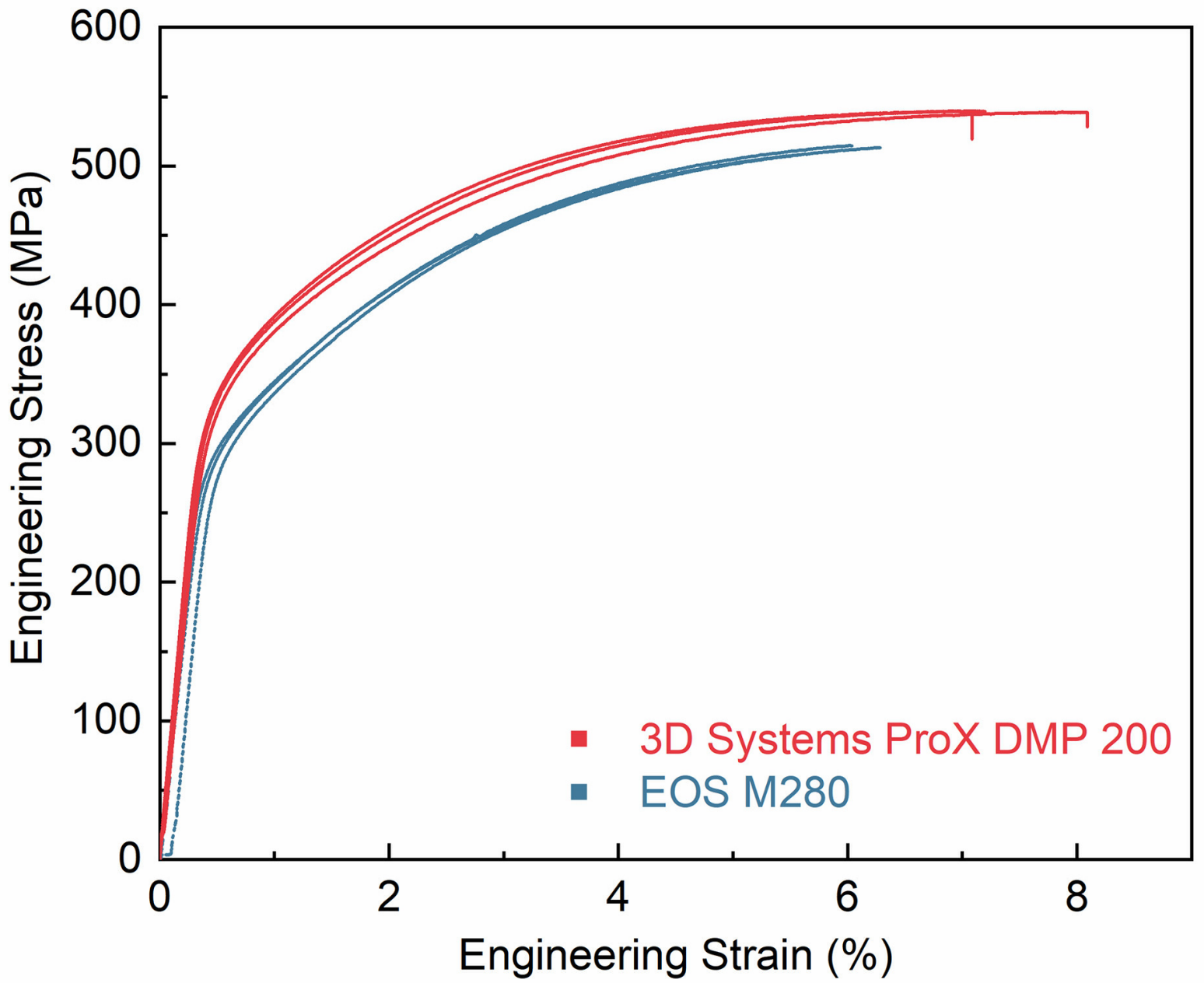

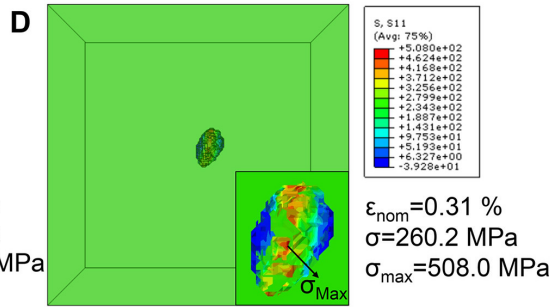
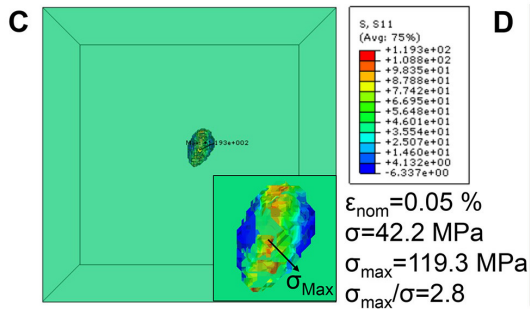
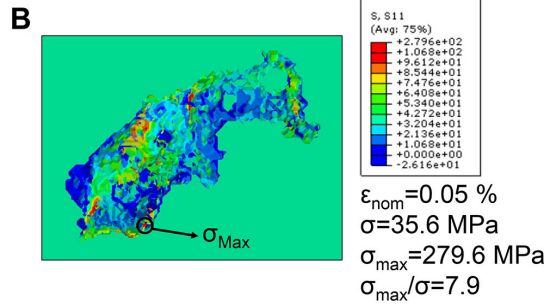
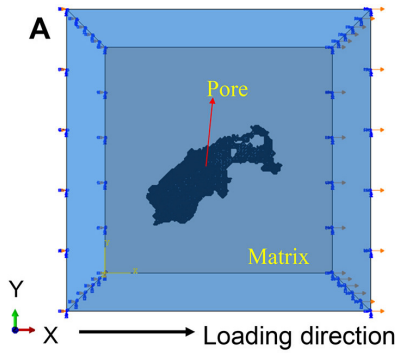

**E**

Defects in AISi10Mg alloy									
Stress concentration factor	7.9	6.1	7.3	6.2	5.2	7.8	7.7	7.0	4.3
Pores in NTD-Al alloy									
Stress concentration factor	2.8	2.4	2.3	2.3	2.2	2.3	2.5	3.0	2.8

→ Loading direction



