



**HAL**  
open science

## Predicting the oceanic input of organic carbon by continental erosion

Wolfgang Ludwig, Jean-Luc Probst, Stefan Kempe

► **To cite this version:**

Wolfgang Ludwig, Jean-Luc Probst, Stefan Kempe. Predicting the oceanic input of organic carbon by continental erosion. *Global Biogeochemical Cycles*, 1996, 10 (1), pp.23-41. 10.1029/95GB02925 . hal-04254436

**HAL Id: hal-04254436**

**<https://hal.science/hal-04254436v1>**

Submitted on 24 Oct 2023

**HAL** is a multi-disciplinary open access archive for the deposit and dissemination of scientific research documents, whether they are published or not. The documents may come from teaching and research institutions in France or abroad, or from public or private research centers.

L'archive ouverte pluridisciplinaire **HAL**, est destinée au dépôt et à la diffusion de documents scientifiques de niveau recherche, publiés ou non, émanant des établissements d'enseignement et de recherche français ou étrangers, des laboratoires publics ou privés.

Copyright

## Predicting the oceanic input of organic carbon by continental erosion

Wolfgang Ludwig and Jean-Luc Probst

Centre de Géochimie de la Surface, Centre National de la Recherche Scientifique, Strasbourg, France

Stefan Kempe

Geologisch-Paläontologisches Institut, Technische Hochschule Darmstadt, Darmstadt, Germany

**Abstract.** For a large set of major world rivers we established the empirical relations existing between the observed organic carbon fluxes and the climatic, biologic, and geomorphologic patterns characterizing the river basins. These characteristics were extracted from various ecological databases. The corresponding carbon fluxes were taken from the literature. Dissolved organic carbon fluxes are mainly related to drainage intensity, basin slope, and the amount of carbon stored in soils. Particulate organic carbon fluxes are calculated as a function of sediment fluxes, which depend principally upon drainage intensity, rainfall intensity, and basin slope. Although the drainage intensity is mainly related to the amount of precipitation and to mean temperature in the basin, slope is also retained as one of the controlling factors. Our empirical models result in a total organic carbon flux to the oceans of about 0.38 Gt per year globally. About 0.21 Gt carbon (Gt C) enter the oceans in dissolved form and about 0.17 Gt C in particulate form. We further regionalize fluxes with respect to major climates, different continents, and different ocean basins. About 45 % of the organic carbon is discharged from tropical wet regions. The major part of the dissolved organic carbon is discharged into the Atlantic Ocean, while the bulk of the particulate organic carbon is discharged into the Indian and Pacific Oceans.

### Introduction

The erosion of carbon from land to sea via rivers represents a major link in the global carbon cycle [Kempe, 1979a; Degens *et al.*, 1984]. It can be estimated that there is a permanent flux of 1 Gt of carbon going to the oceans every year, with about 60 % being transported as inorganic carbon and 40 % being transported as organic carbon (for a review see for example, Probst *et al.* [1994], Degens *et al.* [1991b], Meybeck [1993b]). The global fluxes of inorganic carbon have been discussed in detail elsewhere [Kempe, 1979a; Degens *et al.*, 1991b; Amiotte-Suchet, 1995; Amiotte-Suchet and Probst, 1993a, b, 1995; Probst *et al.*, 1995]. This paper is concerned with the fluxes of organic carbon only. Earlier estimates on the total amount of organic carbon transported by world rivers varied within 1 order of magnitude [e.g. Schlesinger and Mellack, 1981], but investigations during the last decade have improved our knowledge on fluvial carbon fluxes substantially [Degens, 1982; Degens *et al.*, 1983, 1985, 1987, 1988, 1991a; Kempe, 1982, 1984; Kempe *et al.*, 1993; Lewis and Saunders, 1989; Richey *et al.*, 1990]. More recent estimates range from 0.33 Gt C [Degens *et al.*, 1991b] to 0.37 Gt C [Meybeck, 1993a]. However, even if the global figures are more precise today, we still know little about the factors that control carbon fluxes. There exist a few studies that associated

the variability of the fluxes with major climate types [Meybeck, 1982, 1988; Thurman, 1985], but these studies are based exclusively on the selection of a few rivers under the assumption that each represents one climatic type, which is probably not true and may lead to errors.

In this study, we develop a different approach. We collected data of rivers that have been investigated for their loads of dissolved and particulate organic carbon (DOC and POC, respectively) and investigated then the empirical relations existing between the carbon fluxes and various ecologic, climatic, and geomorphologic patterns characterizing the river basins. Our main purpose was to determine the best possible regression models to describe the carbon river fluxes at a global scale. The advantage of this method is that one can predict the specific fluxes for each site over the continents, if the controlling parameters are available. This allows not only the refinement of the global budget but also the coupling of erosion to biosphere and/or ocean models in the scope of global change research. In a further step it is planned to combine the empirical modeling of both the organic and inorganic carbon fluxes to generate a carbon erosion model at a global scale. There is an increasing need for geochemical investigations to quantify river carbon fluxes worldwide [International Geosphere Biosphere Program (IGBP), 1993]. It has been shown recently by Sarmiento and Sundquist [1992] that the global riverine carbon flux, even if it is small compared with the bulk fluxes between the atmosphere/biosphere and atmosphere/ocean interfaces, cannot be neglected if one wants to understand the fate of the anthropogenic released CO<sub>2</sub>.

Copyright 1996 by the American Geophysical Union.

Paper number 95GB02925.  
0886-6236/96/95GB-02925\$10.00

## Material and Methods

### River Data

For this study we used the database of *Pinet and Souriau* [1988], which consists of a set of digitized contours of major world river basins. We extended this database by the further digitalization of several additional river basins to a set of 60 drainage basin contours. Moreover, the contours of the endoreic basins of the continents and the continental divides for the different ocean basins were added. Together, the 60 drainage basins cover about 50 % of the total exoreic continental area. The basin contours allow the determination of the environmental basin characteristics from several global ecological databases. The databases are described below. We calculated one area weighted mean value for each basin and for each parameter. Table 1 lists the overall river basins as well as their major environmental characteristics.

For 32 of these rivers, mean annual DOC and POC fluxes ( $F_{\text{DOC}}$  and  $F_{\text{POC}}$ , respectively) are actually available. These fluxes are listed in Table 2. Many of the carbon data come from the SCOPE/ UNEP program Transport of Carbon and Minerals in Major World Rivers carried out under the leadership of the Institute for Biogeochemistry and Marine Chemistry of the University of Hamburg. Most of the data were published [Degens, 1982; Degens *et al.* 1983, 1985, 1987, 1988, 1991a; Kempe *et al.*, 1993], but in the cases where there exist unpublished data, we included them in our calculations with the agreement of the scientist who carried out the individual field studies. It is the first time that the entire SCOPE data have been used for a modeling approach. Other carbon data were taken from literature. For each river we determined the mean discharge weighted DOC and POC concentrations, on the basis of carbon fluxes and discharge values corresponding to the individual record periods. These average values were then multiplied with

**Table 1.** World River Basins and Their Average Environmental Characteristics

River	A, 10 <sup>6</sup> km <sup>2</sup>	Q, mm	$F_{\text{TSS}}$ , t km <sup>-2</sup> yr <sup>-1</sup>	Elev, m	Slope, radian	SoilH, cm	APPT, mm	AT, °C	VegC, kg/m <sup>2</sup>	SoilC, kg/m <sup>3</sup>	NPP, kg/m <sup>2</sup>	CultA, %	PopD, h/km <sup>2</sup>
Amazon	5.903	1000	190	455	0.0434	226	2084	24.4	11.7	13.3	0.669	0.9	2
Zaire	3.704	340	11	775	0.0370	310	1520	24	8.4	12.5	0.603	3.5	15
Mississippi	3.243	150	120	646	0.0497	214	776	10.3	3.1	11.1	0.487	38.4	27
Ob	3.109	130	6	305	0.0345	216	393	-0.6	4.4	20.0	0.406	12.6	7
Paraná	2.860	165	30	503	0.0443	228	1155	21.5	3.3	15.0	0.424	15.1	14
Yenisei	2.567	220	5	769	0.0855	93	356	-4.5	7.6	12.6	0.377	2.7	2
Lena	2.465	205	5	608	0.0857	49	337	-8.6	6.0	12.9	0.318	1.6	1
Amur	1.924	180	28	571	0.0699	137	479	-1.6	6.9	12.7	0.472	7.5	29
Nile	1.874	30	40	892	0.0577	221	944	24.3	2.8	8.0	0.454	17.8	28
Changjiang	1.817	460	250	1527	0.1321	196	1074	14.4	5.3	10.4	0.457	25.5	205
Ganges/ Brahmap.	1.648	581 <sup>a</sup>	668	1406	0.1353	153	1443	20.3	3.7	11.0	0.477	37.9	193
Mackenzie	1.615	170	23	634	0.0964	184	339	-4.2	8.2	12.4	0.375	0.2	1
Niger	1.540	160	33	377	0.0303	294	1068	27.4	3.1	8.8	0.467	9.5	43
Zambesi	1.404	157 <sup>a</sup>	35	994	0.0450	249	930	21.6	5.4	7.7	0.522	12.0	21
Murray	1.131	21	29	272	0.0337	161	469	18.5	4.0	7.8	0.444	20.5	6
St. Lawrence	1.112	435	4	274	0.0407	210	837	4.4	5.8	10.9	0.519	24.1	25
Orinoco	1.023	1100	150	347	0.0549	228	2359	26.1	8.2	11.2	0.592	2.1	13
Tigris/ Euphrates	0.921	45	57 <sup>a</sup>	625	0.0933	200	282	18.6	1.6	5.5	0.332	23.2	46
Indus	0.912	203 <sup>b</sup>	260	1671	0.1476	92	506	18.5	2.2	9.3	0.331	19.6	121
Mekong	0.846	590	200	854	0.0858	210	1644	22.5	8.1	10.5	0.609	16.2	59
Yukon	0.843	230	71	748	0.1468	219	337	-4.9	4.2	14.7	0.251	0.0	0
Huanghe	0.823	77	1400	1838	0.1196	179	485	9.2	2.0	8.5	0.367	29.8	157
Danube	0.766	250	83	514	0.1250	154	766	9.1	4.1	10.7	0.577	56.0	125
Orange	0.716	100	100	1255	0.0484	160	362	18.1	1.4	4.8	0.318	5.3	9
Colorado	0.708	32	190	1505	0.1718	176	283	11.7	4.2	6.6	0.322	2.1	6
Columbia	0.664	375	22	1336	0.2197	232	482	7	8.5	10.7	0.442	10.1	16
Kolyma	0.659	140	9	590	0.1195	24	267	-10.9	3.7	12.8	0.246	0.0	0
Sao Francisco	0.618	150	9	627	0.0449	261	1141	23.1	4.0	6.1	0.468	5.7	45
Si Kiang	0.456	651 <sup>a</sup>	149 <sup>a</sup>	598	0.0805	198	1501	19.8	2.8	6.8	0.463	30.4	199
Irawaddy	0.419	995	620	745	0.1477	242	1825	22.4	8.5	9.7	0.631	15.3	39
Don	0.413	68 <sup>b</sup>	18	138	0.0147	234	434	6.2	1.2	8.4	0.500	73.2	37
Senegal	0.369	48	8	223	0.0216	133	706	28.4	2.7	5.7	0.466	10.5	6
Indagirka	0.358	150	39	738	0.1261	37	230	-14.5	3.6	13.1	0.241	0.0	0
Limpopo	0.339	13	80	795	0.0498	189	645	21	3.2	6.8	0.434	14.0	11
Northern Dvina	0.329	330	13	127	0.0141	342	474	0	8.1	14.4	0.466	0.5	1
Godavari	0.302	270	550	399	0.0433	154	1132	26.3	3.8	8.6	0.568	44.2	260
Magdalena	0.285	990	920	1224	0.2527	194	1934	23.7	5.3	12.2	0.548	7.5	21
Fraser	0.248	510	91	1173	0.2555	178	606	4.5	14.2	12.0	0.585	2.4	1
Yana	0.243	130	14	746	0.1290	30	129	-14.8	3.5	13.5	0.235	0.0	0
Liao He	0.188	35	240	488	0.0698	166	617	5.6	3.6	10.7	0.503	45.5	203
Rufiji	0.174	50	95	864	0.0963	248	1130	22.3	4.2	6.3	0.496	12.3	52
Mahandi	0.172	515	430	318	0.0497	147	1430	26.1	4.7	10.0	0.590	50.0	412
Rio Negro (Arg.)	0.168	300	140	697	0.0773	178	505	13.4	1.7	6.5	0.264	4.2	14

Table 1. (continued)

River	A, 10 <sup>6</sup> km <sup>2</sup>	Q, mm	F <sub>TSS</sub> , t km <sup>-2</sup> yr <sup>-1</sup>	Elev, m	Slope, radian	SoilH, cm	APPT, mm	AT, °C	VegC, kg/m <sup>2</sup>	SoilC, kg/m <sup>3</sup>	NPP, kg/m <sup>2</sup>	CultA, %	PopD, h/km <sup>2</sup>
Rhine	0.156	190	4	580	0.1372	189	914	8.2	5.3	11.0	0.539	44.6	190
Hungho	0.151	1000	1100	897	0.1315	306	1597	21	7.7	9.2	0.605	13.3	133
Brazos	0.127	65	140	438	0.0255	256	741	17.8	2.5	8.3	0.471	24.7	24
Loire	0.107	245	13	305	0.0667	161	790	10.8	3.3	10.4	0.569	50.8	135
Rhône	0.097	530	340	805	0.2443	127	946	8.4	3.7	11.1	0.513	33.2	103
Tana	0.083	135	1000	403	0.0383	316	725	26.5	4.7	6.7	0.473	11.1	31
Garonne	0.079	320	44	483	0.1211	139	901	11.2	4.7	10.5	0.540	36.0	71
Po	0.065	670	280	501	0.1903	161	998	10.8	3.5	9.2	0.492	53.1	167
Gambia	0.063	110 <sup>d</sup>	10 <sup>d</sup>	223	0.0336	172	1269	27.9	2.3	6.0	0.501	23.7	9
Fly	0.058	1300	1500	197	0.0714	234	3120	26.7	12.6	34.9	0.512	0.0	9
Susitna	0.057	800	500	790	0.1899	186	491	-1.3	4.1	15.0	0.226	0.0	1
Purari	0.040	2500	2600	1176	0.2276	177	2897	27.1	15.1	18.5	0.706	0.0	22
Rioni	0.016	948 <sup>c</sup>	630	1421	0.3093	23	1021	7.6	2.0	8.1	0.486	28.3	26
Tiber	0.016	450	350	437	0.2542	111	998	13.5	4.4	13.0	0.533	0.0	62
Severn	0.013	380	65	153	0.0584	165	778	8.8	1.0	7.9	0.600	100.0	389
Waikato	0.012	838 <sup>c</sup>	12 <sup>c</sup>	433	0.0922	140	1463	13.2	7.4	13.0	0.590	0.0	3
Ems	0.009	373 <sup>c</sup>	27 <sup>c</sup>	113	0.0391	213	790	8.5	1.6	8.9	0.580	80.0	169

A, basin area; Q, drainage intensity; F<sub>TSS</sub>, sediment flux; Elev, basin elevation; Slope, basin slope; SoilH, soil depth; APPT, annual precipitation total; AT, annual temperature; VegC, biomass density; SoilC, organic soil carbon; NPP, annual net primary production; CultA, percentage of cultivated area; PopD, population density. The parameters are calculated from various databases (see text). F<sub>TSS</sub> values refer to natural conditions, meaning that effects by river damming are not taken into account.

A was calculated in this study. Q and F<sub>TSS</sub> are from Milliman and Syvitski [1992] with the following exceptions:

<sup>a</sup> Pinet and Souriau [1988],

<sup>b</sup> Degens et al. [1991b],

<sup>c</sup> Meybeck [1984], and

<sup>d</sup> Lesack et al. [1984].

average discharge literature values recorded for longer periods to obtain the mean average fluxes.

For POC, one can also obtain the average flux by coupling the POC content (POC%) in the total suspended solids (TSS) to the mean annual sediment transport. In our data, only the POC fluxes for the Ganges/ Brahmaputra, Indus, Chiangjiang and Huanghe rivers were calculated with the latter method, because no other data are available for these rivers. For the other rivers, we preferred an extrapolation with the discharge, but we added in Table 2 the POC% values if both the POC and the TSS concentrations had been measured simultaneously (note that the POC% values correspond thus only to the observation period of the field studies). TSS-extrapolated POC-fluxes can be obtained by a simple multiplication of the POC% values with the average sediment fluxes (F<sub>TSS</sub>) from Table 1. The sediment method gives normally greater values than the discharge method. A striking example is the Amazon, where a POC% derived F<sub>POC</sub> value results in a fourfold larger value than the discharge derived F<sub>POC</sub> value (11.57 t km<sup>-2</sup> yr<sup>-1</sup> in comparison to 2.83 t km<sup>-2</sup> yr<sup>-1</sup>).

One of the main constraints for a study as we present it here are the differences in the quality of the river data. For a certain number of rivers, the DOC and POC fluxes are calculated on the background of intensive field studies during one or several years with short sampling time intervals. For others, the fluxes are only determined on the basis of few measurements, which possibly do not include the seasonal variations occurring over 1 hydrological year. Furthermore, in some cases the record periods coincided with unusual dry or wet years (e.g., the Paraná River, Depetris and Kempe [1990]), which makes extrapolation of results to average discharge conditions difficult. Another problem is the

differences in the analytical techniques used for the measurements of DOC and POC concentrations. For these reasons, we assigned to the rivers listed in Table 2 an index for the quality of the river data. A low data quality index can either indicate less extensive field studies or that the measurements were done with a different analytical technique in comparison to the technique applied in most of the other studies (this is the case for the rivers of the former Soviet Union). Our data quality index reflects the comparability of the data with regard to the bulk of the other studies and it denotes nothing about the quality of the studies itself.

### Ecological Databases

As climatic parameter we used mean annual temperatures (AT), mean annual precipitation (APPT), and mean monthly temperatures and precipitation of Legates and Willmott [1992]. These data are distributed as spatially interpolated gridded data sets with a resolution of 0.5° longitude/ latitude on CD-ROM. Information on vegetation was taken from the digitized vegetation map of Olson [Olson et al., 1983, 1985], which exists in a resolution of 0.5° longitude/ latitude at the Carbon Dioxide Information Analysis Center (CDIAC), Oak Ridge, Tennessee. The vegetation units were transferred to figures for biomass (VegC) and net primary production (NPP) according to the values given in the original publications. The data result in a global biomass of 575 Gt C and a global NPP of 53 Gt C/yr, which is close to other estimates (Bolin et al. [1979]: 592 Gt C for biomass and 63 Gt C for NPP; Esser [1991]: 650 Gt C for biomass and 45 Gt C for NPP). For the organic carbon stored in

**Table 2.** Fluxes of Dissolved Organic Carbon (FDOC) and of Particulate Organic Carbon (FPOC) of Some World Rivers

River	Abreviation	Dq	F <sub>DOC</sub> , t km <sup>-2</sup> yr <sup>-1</sup>	F <sub>POC</sub> , t km <sup>-2</sup> yr <sup>-1</sup>	POC%, % TSS	DOC, mg/L	POC, mg/L	Source
Amazon	Amz	3	4.461	2.826	6.09	4.46	2.83	Richey et al. [1990]
Zaire	Zai	2	2.465	0.680	7.00	7.25	2.00	N'Koukou & Probst [1987]
Mississippi	Mis	2	1.319	0.320	-	8.79	2.14	Leenheer [1982]
Ob	Ob	1	1.182	0.115	-	9.09	0.88	Romankevitch and Artemyev [1985]
Paraná	Par	3	1.432	0.279	2.64	8.68	1.69	Depetris and Cascante [1985]
Nile	Nil	3	0.089	0.116	-	2.95	3.85	Abu el Ella [1993]
Changjiang	Yts	1	5.690	6.144	2.52	12.37	13.36	Gan Wei-Bin et al. [1983] <sup>a</sup>
Ganges/ Brahmap.	GaBra	1	2.215	5.222	-	3.87	9.13	Saftullah et al. [1987] <sup>b</sup>
Mackenzie	Mac	3	0.838	0.855	2.95	4.93	5.03	Telang et al. [1991]
Niger	Nig	3	0.593	0.414	3.27	3.71	2.59	Martins and Probst [1991]
St. Lawrence	SLa	3	1.632	0.326	5.98	3.75	0.75	Telang et al. [1991]
Orinoco	Ori	3	4.824	1.590	1.82	4.39	1.45	Lewis and Saunders [1989]
Indus	Ind	2	2.929	1.794	0.46	14.4	8.82	Arain [1987] <sup>b</sup>
Yukon	Yuk	2	0.953	0.307	0.32	4.14	1.33	Telang et al. [1991]
Huanghe	Hua	2	0.481	14.678	0.70	6.25	190.63	Zhang et al. [1992]
Orange	Org	3	0.250	0.106	2.18	2.50	1.06	Hart [1987]
Columbia	Col	3	0.795	0.098	-	2.12	0.26	Dahm et al. [1981]
Don	Don	1	0.600	0.252	-	8.81	3.69	Romankevitch and Artemyev [1985]
Senegal	Sen	3	-	0.072	-	-	1.50	Degens et al. [1991b]
Northern Dvina	NDi	1	4.498	0.197	-	13.63	0.60	Romankevitch and Artemyev [1985]
Rhine	Rhi	2	1.013	0.575	5.60	5.33	3.03	Eisma et al. [1982]
Brazos	Brz	3	0.243	0.281	0.82	3.74	4.32	Malcom and Durum [1976]
Loire	Loi	3	1.379	0.733	7.91	5.63	2.99	Meybeck et al. [1988]
Rhône	Rho	3	0.885	0.440	-	1.67	0.83	Kempe et al. [1991]
Garonne	Gar	3	0.892	1.001	3.60	2.79	3.13	Etcheber unpublished
Po	Po	1	2.065	0.881	-	3.08	1.31	Pettine et al. [1985]
Gambia	Gam	3	0.262	0.117	2.38	2.39	1.07	Lesack et al. [1984]
Rioni	Rio	1	0.994	1.835	-	1.05	1.94	Romankevitch and Artemyev [1985]
Tiber	Tib	1	1.788	0.616	-	3.97	1.37	Pettine et al. [1985]
Severn	Sev	3	2.001	-	-	5.27	-	Mantoura and Woodward [1983]
Waikato	Wai	3	4.576	1.132	10.11	5.46	1.35	ARA unpublished <sup>c</sup>
Ems	Ems	1	3.026	0.970	7.03	8.12	2.60	Cadée [1987]

Dq is an index for the data quality (see text).

<sup>a</sup> FPOC value from Milliman et al [1984], and

<sup>b</sup> FPOC value from Subramanian and Ittekkot [1991].

<sup>c</sup> Auckland Regional Authority, New Zealand.

soils (SoilC), there is actually no global data set available, even though several approaches exist to predict its spatial distribution using climate and/ or soil types [e.g., Post et al., 1985; Eswaran et al., 1993]. For this study we derive the SoilC indirectly from the ground vegetation type. We followed mainly the assignment published by Adams et al. [1990], including some other literature values. The advantage of this method is that the authors assigned SoilC values to the major vegetation types of Olson. One can thus create a SoilC map on the basis of the Olson vegetation map. This assignment assumes that all organic carbon in soils is concentrated in the first meter of the soil profile. The values we calculated in Table 1 refer therefore to the amount of carbon stored in a pedon of a surface cubic meter. From the resulting SoilC map the global amount of carbon stored in the soils is estimated to be 1360 Gt C, which is in agreement with previous estimates (Post [1993]: 1300 Gt C without wetlands; Eswaran et al. [1993]: 1576 Gt C).

We included also the mean soil depth (SoilH) of Staub and Rosenzweig [1992] as another controlling soil parameter. Their data are based on the Food and Agriculture Organisation (FAO) Soil Map of the World digitized by Zabler [1986]. The data are originally distributed in a spatial resolution of 1° longitude/

latitude, and we interpolated them linearly to a resolution of 0.5° longitude/ latitude. For the characterization of the drainage basin morphology, we took the mean modal elevation (Elev) of the Fleet Numerical Oceanography Center (FNOC) [1992] and the mean slope (Slope) of Moore and Mark [1986] from the U.S. Geological Survey, Menlo Park, California. The first data set exists in a spatial resolution of 10' longitude/ latitude, and the second exists in a resolution of 5' longitude/ latitude. We reduced both data sets to a resolution of 0.5° longitude/ latitude. The mean population density (PopD) and the percentage of the cultivated area (CultA) in each basin were used to illustrate human impact on the river basins. The first parameter was taken from a data set developed at the "Institut für Energieforschung", Graz (Austria) [Ahamer et al., 1992]. The latter parameter was calculated from the Olson vegetation map by grouping all agricultural types together and calculating the percentage of the area that they cover with respect to the total basin area.

### Empirical Modeling

For the multiple regression analysis, the best regression model was selected by testing all possible combinations of a set of

independent variables against a dependent variable and the best model is retained following the adjusted  $r^2$  and the statistical  $C_p$  coefficient of Mallows [1973].  $C_p$  is a measure of the total squared error for a subset model containing  $p$  independent variables, and the model with  $C_p$  closest to  $p + 1$  can be considered as the best model to predict the dependent variable. This procedure suffers from the difficulties in selecting parameters because some parameters can show strong correlation among each other. For example, Tardy *et al.* [1989] pointed out the strong correlation between average precipitation and average drainage ( $Q$ ) on a global scale. This makes the introduction of both variables into one model problematic. Our data show that correlation exist mainly among the hydroclimatic parameters and between the hydroclimatic parameters and the biospheric parameters (see Figures 1a and 1b). This is not surprising as, for example, NPP depends directly upon precipitation. The simultaneous use of all parameters for the regression analyses was normally not possible. Therefore we grouped the parameters in all possible combinations in a way that minimized the effects of multicollinearity, following the suggestions of SAS [1986]. Then all parameter combinations were tested individually to identify the best models.

For all models, the rivers were also grouped into subgroups according to the data quality indices of Table 2, and the regressions were repeated in each subgroup. This was done to test whether the results can be influenced by the data quality or not. However, such classifications are always subjective. A more rigorous selection of the data by excluding rivers with lower data quality indices may increase the statistical significance of the results, while, on the other hand, this holds the risk to bias the results by omitting certain ecosystems in the regression calculations. For our work, we tried to find the best possible regression models in conjunction with a maximal river number rather than

to obtain the greatest correlation coefficients. Nevertheless, in some cases, the omission of one or two rivers from the regressions could improve the regression coefficients considerably without changing the significance of the retained parameters in the models. These rivers may be an exception of the general trend or the data may be misleading in understanding the factors that control the organic carbon fluxes. If we found indications that this is true, then we excluded them from the calculations and we used the equations with the more significant coefficients for our models. These exceptions will be discussed in the text.

## Bioclimatic Classification and Climatic Variability

Before extrapolating statistical results obtained from a set of river data worldwide, one has to ensure that the selected rivers represent the major ecosystems on Earth. This can be done, for example, by the application of a simple bioclimatic classification for river basins. Another advantage of such a classification is that it can be useful in understanding the regional particularities of the carbon fluxes, and may allow an easy prediction of the erosion of organic carbon in different scenarios of changing climate. The drainage basins may be classified on the basis of their average situation, but this is not without problems because some basins are very large and belong to several climate zones, while others stay nearly exclusively within one zone. This is also important for the interpretation of the average values that can be calculated from the ecological databases. For most of the rivers the values should be helpful to identify the control parameters for the observed carbon fluxes, but they may be misleading if the river hydrology and the related carbon fluxes are strongly influenced by a particular part of the basin that has quite different environmental characteristics in comparison to the rest of the

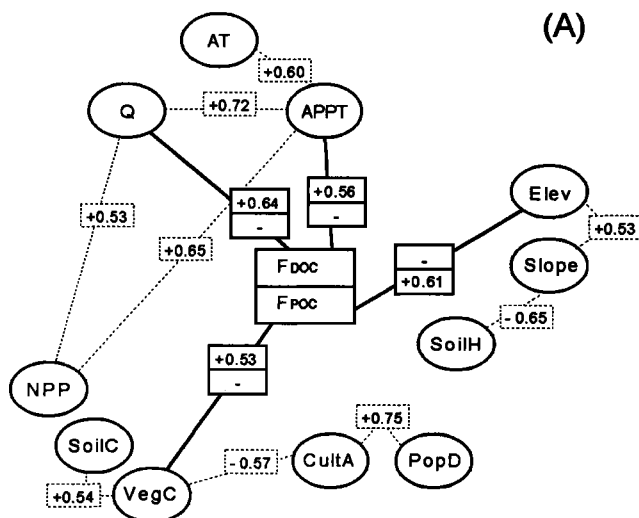

**Figure 1a.** Correlation between fluxes of dissolved organic carbon ( $F_{DOC}$ , upper boxes and solid lines), fluxes of particulate organic carbon ( $F_{POC}$ , lower boxes and solid lines), and environmental patterns characterizing the basins (dashed boxes and dashed lines) for all rivers of Table 2. Only correlation coefficients  $< -0.5$  and  $> +0.5$  are depicted. See Table 1 for abbreviations.

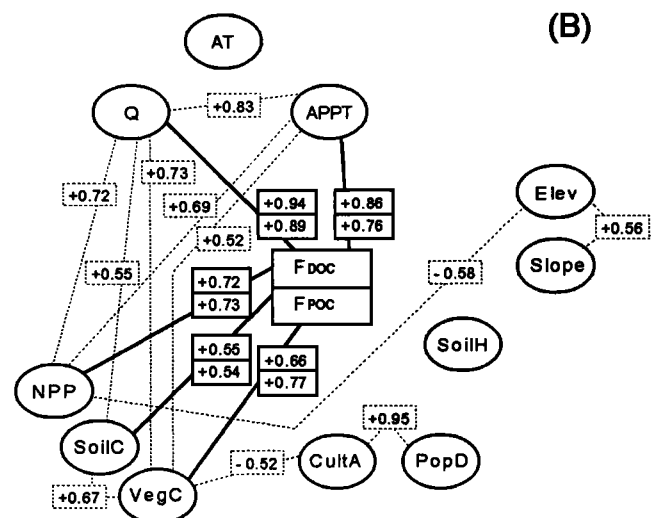

**Figure 1b.** Correlation between fluxes of dissolved organic carbon ( $F_{DOC}$ , upper boxes and solid lines), fluxes of particulate organic carbon ( $F_{POC}$ , lower boxes and solid lines), and environmental patterns characterizing the basins (dashed boxes and dashed lines) for the rivers of Table 2 with the highest data quality index. Only correlation coefficients  $< -0.5$  and  $> +0.5$  are depicted. See Table 1 for abbreviations.

drainage area. Therefore it is not only the average climatic situation of the river basins, but also the climatic variability in these basins, which is important for a study like ours.

For these reasons, we used the Holdridge Life Zone classification [Holdridge, 1947] to identify the climatic variability covered by the drainage basins and to test the representativity of these basins with regards to the major bioclimates on Earth. The Holdridge Life Zone diagram was originally proposed to relate the character of natural vegetation associations to climatic indices, and it has been shown that this classification produces a reasonable representation of present-day ecosystems [Henderson-Sellers, 1993; Prentice, 1990]. The life zones are depicted by a series of hexagons formed by intersecting intervals of climate variables on logarithmic axes in a triangular coordinate system (Figure 2a). Two variables, the average biotemperature (ABT) (which is the average annual temperature with negative values set to zero), and the mean annual precipitation total (APPT), uniquely determine the classification. The third variable in the diagram, the annual potential evapotranspiration ratio (APETR), is the ratio of the potential evapotranspiration (APE) over the precipitation. Since the APE is calculated as a simple function of temperature, the APETR depends upon the two primary variables ABT and APPT. Figure 2b illustrates the climatic variability for 0.5° x 0.5° grid elements for the Mackenzie Basin in comparison with the Indus Basin in the Holdridge Triangle: the Mackenzie is much more homogeneous in comparison to the Indus, even if its basin is nearly as twice as great.

We simplified the Holdridge diagram further to an eightfold classification and calculated for each basin the percentage of the total basin area falling in each class, rather than calculating an average climate for the entire basin. The results are shown in Table 3. The following classes were generated (using the hexagon lines and not the straight intersect lines as boundary lines): (I) polar, with ice:  $ABT \leq 1.5^\circ\text{C}$  and under permanent ice cover; (II) polar, without ice:  $ABT \leq 1.5^\circ\text{C}$  and without permanent ice cover; (III) tundra and taiga: bioclimates with  $1.5^\circ\text{C} < ABT \leq 6.0^\circ\text{C}$ ; (IV) temperate dry: bioclimates with  $6.0^\circ\text{C} < ABT \leq 17.0^\circ\text{C}$  and  $4.0 \geq APETR > 1.0$ ; (V) temperate wet: bioclimates with  $6.0^\circ\text{C} < ABT \leq 17.0^\circ\text{C}$  and  $APETR \leq 1.0$ ; (VI) tropical dry: bioclimates with  $ABT > 17^\circ\text{C}$  and  $4.0 \geq APETR > 1.0$ ; (VII) tropical wet: bioclimates with  $ABT > 17^\circ\text{C}$  and  $APETR \leq 1.0$ ; (VIII) deserts: bioclimates with  $APETR > 4.0$ .

Among all rivers the Indus, the Nile, the Changjiang, and the Ganges/ Brahmaputra are the rivers that combine the greatest climatic variability in their watersheds. This means that the averages for these rivers, which we calculated from our databases, are probably less significant for carbon export in comparison to the other basins. The rivers of high latitudes (Mackenzie, North Dvina, Yukon) are characterized by a relative low variability. A relative low variability is also found for most of the tropical rivers (Amazon, Orinoco) and naturally for the small rivers. Table 3 shows also that the river basins stretch over all bioclimatic types and that the percentage the overall basin cover in each type is comparable to the general representation of

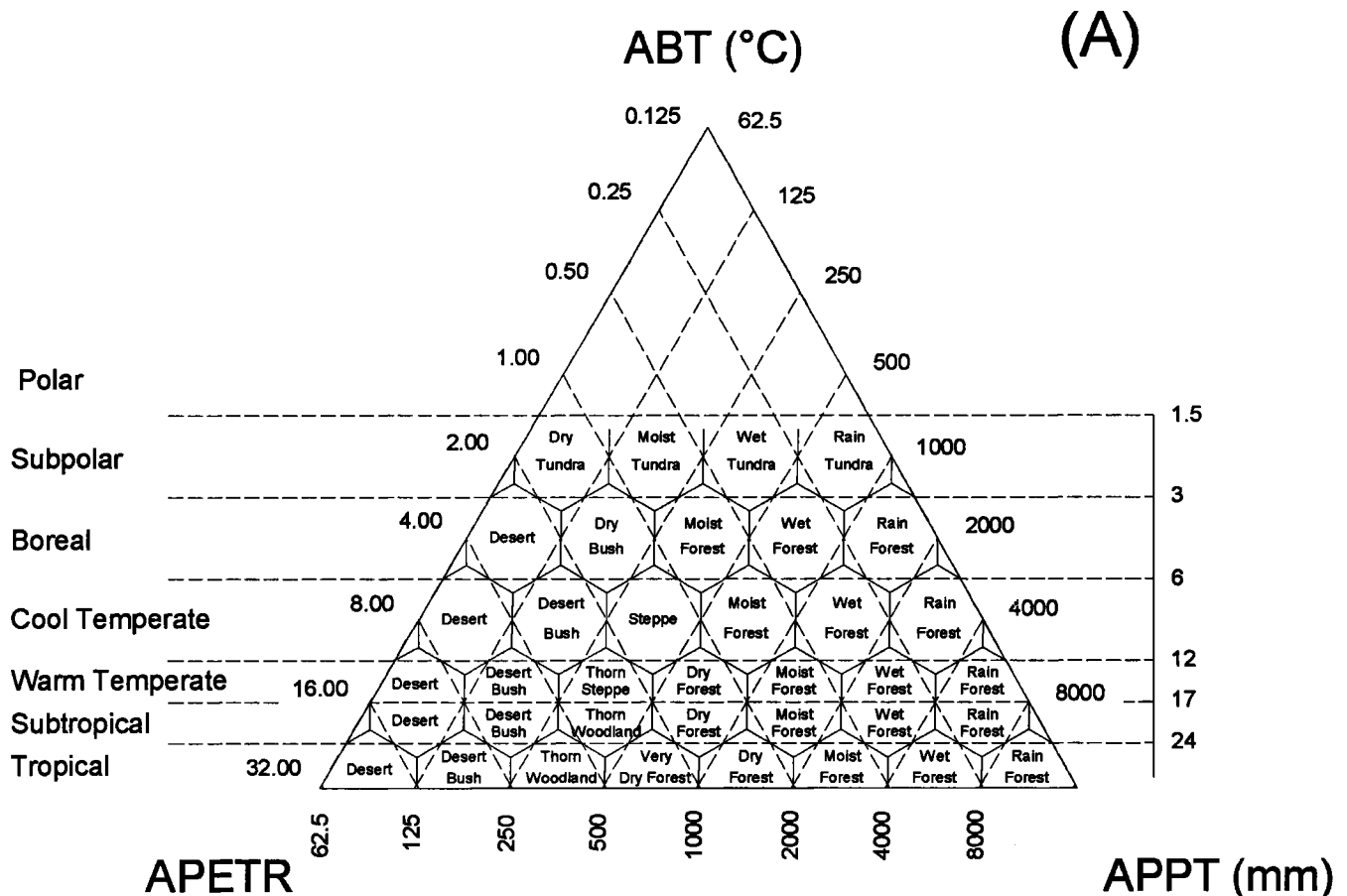
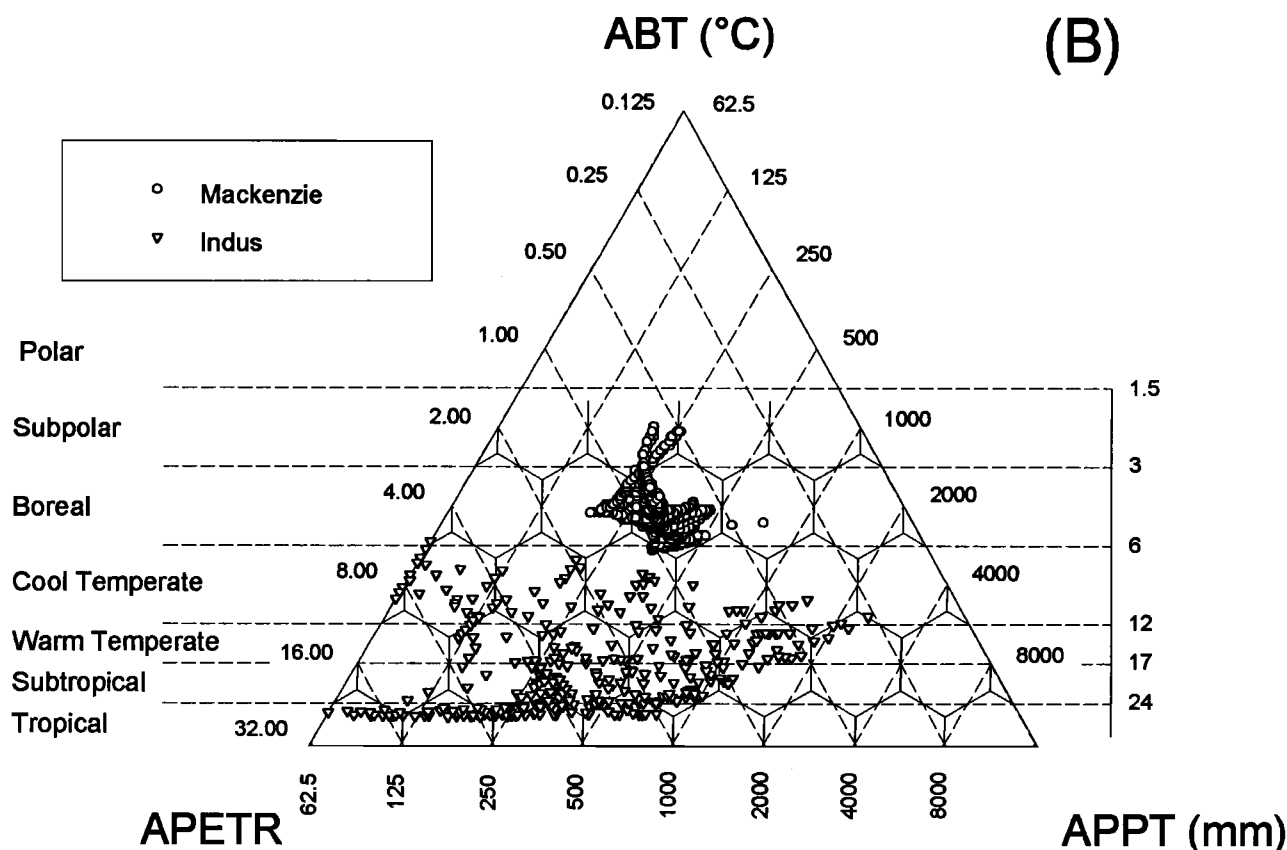

Figure 2a. The Holdridge Life-Zone Classification System.



**Figure 2b.** Distribution of all  $0.5^\circ \times 0.5^\circ$  longitude/latitude grid elements of the Mackenzie River Basin and of the Indus River Basin in the Holdridge Triangle.

each bioclimate over the continents. Only deserts and polar regions are underrepresented.

### Factors Controlling DOC Fluxes

Figures 1a and 1b show that the best single variable model to predict the fluxes of dissolved organic carbon is a model based on the discharge ( $r = 0.64$  for all rivers). Other variables with a high correlation with  $F_{\text{DOC}}$  are APPT and VegC. The multicorrelation analyses reveal that the model performance is significantly improved if one introduces Slope and SoilC as additional parameters. On the basis of a set of 29 rivers, (1) is the best linear model to estimate DOC flux:

$$F_{\text{DOC}} = 0.0040 Q - 8.76 \text{ Slope} + 0.095 \text{ SoilC} \quad (1)$$

$r = 0.90, \quad P > 0.001, \quad n = 29$

The units of the parameters are as follows:  $F_{\text{DOC}}$ , tons per square kilometer per year;  $Q$ , millimeter; Slope, radian; and SoilC, kilograms per cubic meter;  $r$  is the correlation coefficient,  $P$  is the significance level, and  $n$  is the number of rivers considered in the equation. The two rivers of Table 2 that are not taken into consideration in (1) are the Indus and the Changjiang rivers (see below). All parameters are significant at  $P > 0.01$ . Results are similar if regressions are calculated by omitting rivers with lower data quality. If one takes only the group of 17 rivers

with the highest data quality index, the best model remains still a model based on  $Q$ , Slope, and SoilC, and it shows very similar coefficients to those of (1). The correlation coefficient rises up to a value of  $r = 0.98$ , while the influence of  $Q$  in the model increases (Figure 1b).

The results of the regression analyses indicate that drainage, the steepness of morphology, and the amount of carbon in soils are the main factors which control DOC fluxes globally. We did not find any influence of basin area on DOC fluxes. This means that the model may be applicable also to local and regional scales. The DOC fluxes become greater with increasing drainage intensities, flatter morphologies, and larger carbon reservoirs in the soils. Dissolved organic carbon inputs to rivers are generally subdivided into allochthonous carbon produced by the terrestrial biosphere on land and autochthonous carbon produced by the phytoplankton in lakes and in the river itself. Our results suggest that soils are globally the major contributors to riverine DOC, which is in good agreement with most of the studies on this topic [e.g., Spitzly and Leenheer, 1991; Degens et al., 1991b; Kempe and Depetris, 1992]. The importance of basin morphology in controlling organic carbon fluxes has been already hypothesized elsewhere [Rasmussen et al., 1989; Eckhardt and Moore, 1990; Clair et al., 1994]. Clair et al. [1994] reported recently for a group of small watersheds in Canada that the export of organic carbon is inversely correlated with basin slope. One has to mention that they do not distinguish between DOC and POC



**Table 3.** Percentage of Abundant Climates With Respect to the Total Basin Area for the River Basins of Table 2

	Area, 10 <sup>6</sup> km <sup>2</sup>	Polar Ice, %	Polar No Ice, %	Tundra and Taiga, %	Temperate Dry, %	Temperate Wet, %	Tropical Dry, %	Tropical Wet, %	Desert, %
Amazon	5.903	-	-	-	2.9	3.9	12.2	81.0	-
Zaire	3.704	-	-	-	-	0.2	36.5	63.3	-
Mississippi	3.243	-	-	1.0	39.5	53.0	0.1	6.4	-
Ob	3.109	-	-	66.8	30.6	2.6	-	-	-
Paraná	2.860	-	-	-	3.9	1.5	50.0	44.6	-
Nile	1.874	-	-	-	1.3	4.2	60.2	17.0	17.4
Changjiang	1.817	-	-	2.0	25.6	43.5	3.3	25.6	-
Ganges/ Brahmaputra	1.648	-	-	-	0.7	28.6	37.1	33.6	-
Mackenzie	1.615	-	-	99.7	0.3	-	-	-	-
Niger	1.540	-	-	-	-	-	73.7	10.1	16.1
St. Lawrence	1.112	-	-	24.8	-	75.2	-	-	-
Orinoco	1.023	-	-	-	-	-	25.1	74.9	-
Indus	0.912	-	-	0.3	16.2	12.4	28.5	2.6	40.0
Yukon	0.843	-	1.2	98.8	-	-	-	-	-
Huanghe	0.823	-	-	0.9	86.7	12.1	-	-	0.3
Orange	0.716	-	-	-	30.4	0.4	50.1	-	19.1
Columbia	0.664	-	-	16.6	55.4	27.3	-	-	0.7
Don	0.413	-	-	-	86.4	13.6	-	-	-
Senegal	0.369	-	-	-	-	-	92.8	1.6	5.6
Northern Dvina	0.329	-	-	97.1	-	2.9	-	-	-
Rhine	0.156	-	-	2.5	-	97.5	-	-	-
Brazos	0.127	-	-	-	22.0	-	59.2	18.8	-
Loire	0.107	-	-	-	1.9	98.1	-	-	-
Rhône	0.097	-	-	11.1	6.9	82.0	-	-	-
Garonne	0.079	-	-	-	11.2	88.8	-	-	-
Po	0.065	-	-	-	27.0	73.0	-	-	-
Gambia	0.063	-	-	-	-	-	85.6	14.4	-
Rioni	0.016	-	-	-	-	100.0	-	-	-
Tiber	0.016	-	-	-	71.3	28.7	-	-	-
Severn	0.013	-	-	-	-	100.0	-	-	-
Waikato	0.012	-	-	-	-	100.0	-	-	-
Ems	0.009	-	-	-	-	100.0	-	-	-
All rivers, Table 1	53.032	-	0.2	23.5	12.9	13.2	22.1	24.5	3.6
All rivers, Table 2	35.891	-	-	15.0	13.8	14.9	22.1	31.0	3.1
WORLD	152.350	9.5	3.0	16.8	11.2	9.9	18.3	15.7	15.6

See text for definition of the climates.

fluxes in their models, but because the investigated rivers are poor in POC, their values represent mostly DOC. An explanation for the great importance of slope on DOC flux could be that a steep basin morphology results in a higher share of surface runoff with respect to total runoff [Probst and Sigha, 1989]. Because of the restricted contact with the soils, these waters are less concentrated in DOC [Kempe, 1979b]. On the other hand, the water in a basin with a flat morphology may have a longer average residence time than the water in a basin with a steep morphology. Leaching processes can therefore be more intense, which should enrich soil and runoff waters in DOC.

The most striking exceptions to this trend are the Indus and the Changjiang rivers. Both have high average DOC concentrations, but SoilC values of these two rivers are low to medium and their basin morphologies are steep. It is remarkable that both of these river drainage basins are characterized by a great climatic variability (Table 3). This is mainly the reason why we did not include them in the regression in (1), even if this does not change the results substantially. Note that 40 % of the Indus watershed is

desert. This is certainly responsible for the low average SoilC that we found for the Indus, but on the other hand this region should have practically no importance for its DOC export. In the parts of the basin from which discharge is mainly derived, SoilC values can be expected to be much greater. Another explanation for the high DOC concentrations can be the extreme seasonal variability of the discharge in the Indus. Because it has been found that most of the rivers show a strong flushing effect, that is, increasing DOC concentrations with increasing discharge [e.g., Malcom and Durum, 1976; Martins, 1982; Mantoura and Woodward, 1983; Moore, 1989; Depetris and Kempe, 1990; Depetris and Paolini, 1991], the seasonal variability of the river hydrograph plays an important role in the DOC export. Finally, it is also possible that the high concentrations of both the Indus and the Changjiang rivers are partly the result of a strong anthropogenic input. This may be especially true for the Changjiang River, around which the population density is very great.

The Rioni and the Rhône rivers in Europe display the lowest

average DOC concentrations (1.1 and 1.7 mg/L, respectively). They have low to moderate values for SoilC, but feature, together with the Tiber, the steepest basin morphologies of all rivers (Table 1). The only slightly higher concentrations of the Gambia and the Orange River (2.4 and 2.5 mg/L, respectively) can be related to their very low SoilC values, while the high concentration of the Zaire River of 7.3 mg/L may be a good example for the combination of a low relief together with a high soil carbon pool. Nevertheless, it is important to note that discharge is the major factor that controls the fluxes of dissolved organic carbon on a global scale, as it has been shown previously by *Esser and Kohlmaier* [1991]. This is not surprising because  $Q$  is generally more variable than DOC concentration. The value for average DOC concentration in Table 2 lies between 1.1 and 14.4 mg/L, with more than 50 % of the values lying in the range of 3–8 mg/L, while  $Q$  is scattering over a much wider range, that is, 30 mm/yr (Nile) to 1100 mm/yr (Orinoco).

### Factors Controlling POC Fluxes

For particulate organic carbon, variability of the specific fluxes is greater than for dissolved organic carbon. No clear correlation with one or several of the climatic, biospheric, or geomorphologic parameters can be detected for the set of all river basins. Figure 1a suggests that there is a good correlation of  $F_{\text{POC}}$  with Elev, but this effect is caused by only a few rivers in our data set. These rivers are the Ganges/ Brahmaputra, Indus, Chiangjiang, and Huanghe rivers, which are all situated in the south and southeast of Asia. Taking again only the group of the 17 rivers with the largest data quality index, the results are completely different. Here, the best correlation with the  $F_{\text{POC}}$  occurs with  $Q$  (Figure 1b) and the correlation coefficient with Elev is almost zero. However, it would be misleading to predict global POC fluxes by coupling them to discharge, as *Esser and Kohlmaier* [1991] proposed. *Milliman and Meade* [1983] estimated that up to 70 % of the world sediment transport to the oceans occurs from southern Asia and the larger islands of Oceania. One risks to bias the results if one excludes the rivers from this region from the regressions. Note also that  $Q$  has much larger correlation coefficients with bioclimatic parameters in Figure 1b than in Figure 1a. This indicates that the rivers with the greatest data quality index are more uniform with regard to their hydroclimatic and bioclimatic characteristics than the set of all river basins. The reduced river set is thus less suitable for representing major ecosystems globally.

There are several reasons that explain the great variability of the POC fluxes. Generally, overall mechanical erosion rates are more variable than those for chemical erosion, ranging over 3 or more orders of magnitude rather than 2 as in the case of chemical erosion [*Summerfield and Hulton*, 1994]. The weak correlation and the difficulties of relating the fluxes to other parameters should also reflect the more variable nature of the POC in comparison to the DOC in river waters. Contrary to the DOC, the autochthonous contribution to the total POC is not always negligible and can be important in some rivers. This contribution is added to the POC fluxes released by erosion of soil and vegetation debris. Moreover, a certain POC contribution can arise from erosion of sedimentary rocks rich in organic carbon. *Meybeck* [1993b] suggested that an important example for this may be the Huanghe River, where a considerable part its POC

may originate from the organic matter content of the loess covering the basin.

We find that among all the factors that may control the export of organic carbon on a global scale, it is the total sediment flux that shows the most significant relationship with the POC flux. Because of extrapolation problems that arise in determining reliable average  $F_{\text{POC}}$  and  $F_{\text{TSS}}$  that correspond to each other, this relation of organic carbon export and total sediment flux becomes most evident if one looks only at the observed fluxes without extrapolating them to long-term averages. This reduces to some extent the number of rivers because for all given POC fluxes it is not known to which  $Q$  and  $F_{\text{TSS}}$  the observations correspond. Figure 3 shows the nature of the relationship on the basis of the data of the 19 rivers in Table 2 for which both  $F_{\text{POC}}$  and  $F_{\text{TSS}}$  have been measured simultaneously. In spite of the large scatter, one can see that the POC% in the suspended solids generally decreases with increasing TSS concentrations ( $c\text{TSS}$ ) following a nonlinear relationship. This is the case for both the individual measurements and the river means, suggesting that this relationship is fundamentally similar for seasonal and spatial scales. The following equation, calculated only with the annual means, is the best mathematical fit to describe the relationship in Figure 3:

$$\text{POC}\% = -0.160 \log(c\text{TSS}^3) + 2.83 \log(c\text{TSS}^2) - 13.6 \log(c\text{TSS}) + 20.3 \quad (2)$$

$$r = 0.83; \quad P > 0.001, \quad n = 19$$

The unit of  $c\text{TSS}$  is milligrams per liter. Other authors have found similar relations between the POC% and the TSS concentrations, both for seasonal variations [*Probst*, 1992] and for annual means [*Meybeck*, 1982; *Ittekkot*, 1988]. The equation has a minimum for a TSS concentration of 2250 mg/L, corresponding to a POC% value of 0.5. This is in good agreement with the observation that POC% in TSS falls rarely below this level in rivers.

There are two different processes that can account for the observed POC% -  $c\text{TSS}$  relationship. First, the decreasing POC% in the suspended matter with increasing TSS concentrations can reflect the variable contribution of the autochthonous carbon produced by riverine phytoplankton in the different rivers. Large sediment loads restrict the in situ production because of the reduced availability of light in river water. This means that elevated POC% values result as an offset of the riverine carbon production to the carbon mobilized from the soil and litter pools, and that the fluxes of this allochthonous carbon are probably more or less coupled linearly to the intensity of the mechanical erosion in the river basins (of course, this is not true to the extent to which there occurs sediment storage in the basin). Second, the inverse POC% -  $c\text{TSS}$  relationship may result from an increasing dilution of the riverine POC with mineral matter in highly turbid rivers caused by differences in the processes controlling the mechanical erosion. In the basins of highly turbid rivers, gully and landslide erosion may be more active than linear erosion, leading to a higher portion of mineral matter in TSS. If the first process is dominant globally, then POC export from the terrestrial biosphere will be lower than the observed river fluxes and the oceanic input would not necessarily equal the terrestrial output. If the second process is dominant, then riverine POC

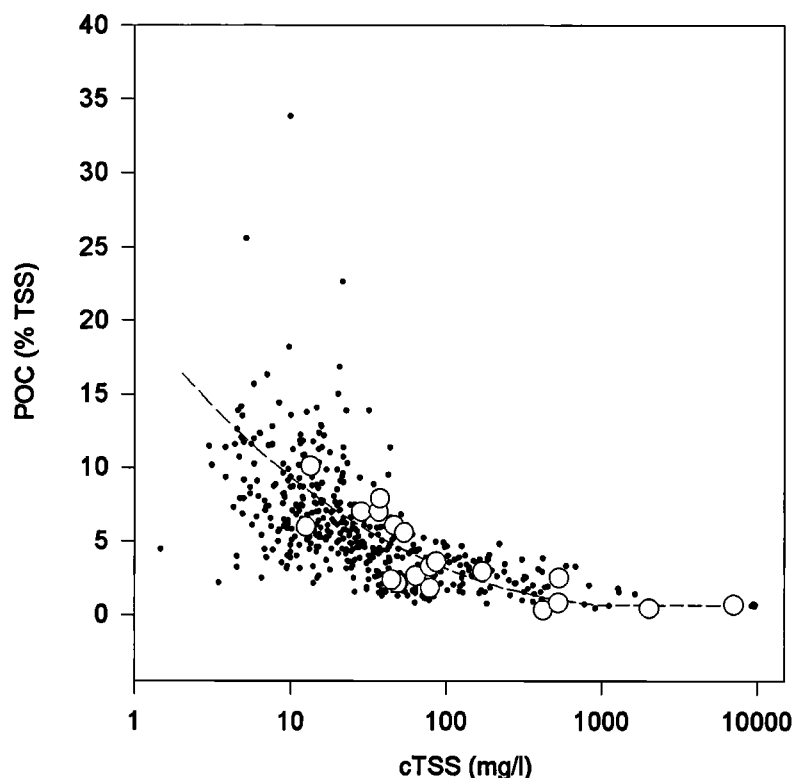

**Figure 3.** Plot of POC percentage in TSS versus TSS concentration. The circles are the discharge weighted annual means for the following rivers (in the order of increasing TSS concentrations): SLa, Wai, Zai, Ems, Loi, Gam, Amz, Org, Rhi, Par, Nig, Ori, Gar, Mac, Yuk, Brz, Yts, Ind, Hua. The dots represent about 450 individual measurements from the following rivers: Brz, Hua, Gar, Ind, Mac, Nig, Org, Par, SLa, Wai. See Table 2 for abbreviations.

should originate mostly from the terrestrial pools and the oceanic input should equal the terrestrial output, not considering here the losses of POC by oxidation during river transport and/ or in estuaries.

In our data the average POC% values vary between 0.3 % and 10.1 %, but values above 1.5 % are only observed in rivers with TSS concentrations lower than 300 mg/L. The only exception is the Changjiang River. This river was sampled in its outer estuary and the calculated fluxes are probably influenced by the primary production in the estuary itself [Milliman *et al.*, 1984]. Cauwet and Mackenzie [1993] have shown in a later study on the Changjiang estuary that primary production in the estuary leads to considerably greater POC% values in the suspended matter. The greatest POC% value in our data is observed for the Waikato River in New Zealand (10.1 %). Other rivers with elevated values are the Loire River (7.9 %), the Zaire River (7.0 %), and the Ems River (7.0 %). These rivers may have a considerable or even major autochthonous share in their POC fluxes. On the basis of chlorophyll measurements, Meybeck *et al.* [1988] found for the Loire an autochthonous POC contribution of about 60 %, and Kempe [1982] showed that in summer low  $p\text{CO}_2$  values indicate strong autochthonous production.

However, most of the rivers have POC% values between 0.5 % and 5.0 %. Lewis and Saunders [1989] determined for the Orinoco an autochthonous POC contribution of only 2 % of the total flux, which is in good agreement with the relative low POC% value of 1.8 % found for this river. It is a striking feature

that there is a similarity between the shape of our curve in Figure 3 and the profiles of the vertical organic carbon distribution normally found in soils where total carbon density rapidly decreases with increasing depth, especially at high temperature [Desjardins *et al.*, 1991]. Thus Figure 3 may reflect simply the intensity of mechanical erosion for different moments and different sites. Low mechanical erosion intensity occurs mainly at the uppermost soil horizon and the POC% in the river water will be characterized by elevated values. More intense mechanical erosion will cut also into deeper horizons and lead to lower POC% values in the mobilized material. Seasonally, the decreasing POC% values with increasing TSS concentrations can be also explained by the remobilization of mineral matter in the river bed during the rising hydrograph.

In Table 1 soil organic carbon storage varies between 4.8  $\text{kg/m}^3$  for the Orange River Basin and 20  $\text{kg/m}^3$  for the Don Basin. Assuming that the soil has a mean density of 1.6  $\text{g/cm}^3$  [Carvalho, 1988], the resulting percentage of organic carbon lies between 0.3 % and 1.3 %. These figures do not take into account carbon stored in litter on top of the soil profile. Nevertheless, they are very close to the POC percentages in river suspensions if one considers that erosion occurs mainly at the surface soil horizons where the organic carbon density is much greater and litter pools act as an additional source for POC. Cumulative carbon storage down to 20 cm can account for 50 % of the total soil carbon [Zinke *et al.*, 1986]. Moreover, most of the investigated rivers have C/N ratios of about 10 in their total suspended solids

[Ittekkot, 1988], which is very close to the C/N averages found in soils [e.g., Kempe and Depetris, 1992]. This indicates that the observed POC% - cTSS relationship may result mainly from the dilution of the POC with mineral matter in highly turbid rivers and that the bulk of riverine POC is derived from soil erosion. On a global scale, autochthonous POC apparently plays a minor role only. Compositional characterizations of particulate organic matter in rivers are scarce, but the few existing investigations confirm this. For example, Hedges *et al.* [1986] showed for the Amazon river system that fine POC that forms the bulk fraction in the total POC [Richey *et al.*, 1990] derives primarily from soils, while coarse POC is composed of tree leaf debris and wood which is typical for litter.

There remains some uncertainty about the amount of fossil carbon in riverine POC. Meybeck [1993a, b] pointed out that the POC% value of 0.5 which seems to be a lower limit for organic carbon in river sediments is close to the organic carbon content commonly found in shales. He concluded therefore that an important part of the particulate organic matter in rivers may be of fossil origin and estimated this flux globally to be about 0.08 Gt C/yr [Meybeck, 1993b]. However, in this consideration he did not account for the net oxidation of rock organic matter, that has been estimated to range from 0.03 to 0.26 Gt C/yr [Kramer, 1994]. Selecting an intermediate value of 0.1 Gt C/yr [Sarmiento and Sundquist, 1992], one finds that net oxidation is at least in the same range as Meybeck's [1993b] estimated fluvial transport of fossil POC. This is not necessarily the same material, but since the organic matter oxidation is strongly related to rock granulation during soil formation [Kramer, 1994], one can assume that it normally precedes the mobilization of the material. We consider, therefore, fossil POC to be of very small importance in the total POC budget.

### Factors Controlling Discharge and Sediment Fluxes

The previous sections have shown that drainage and sediment fluxes are the principal factors that control the fluxes of organic carbon to the oceans. Using average values of river basins, we tested whether both parameters are related to other climatic, biologic, and geomorphologic patterns that can be determined from the databases. For discharge, a model including APPT, ABT, and Slope best predicts the observed values according to the following equation:

$$Q = 0.81 \text{ APPT} - 44.4 \text{ ABT} + 1.36 (\text{Slope} * \text{APPT}) \quad (3)$$

$$r = 0.93, \quad P > 0.001, \quad n = 60$$

The units of the parameters are as follows:  $Q$ , millimeters; APPT, millimeters; ABT, °C; and Slope, radian. All parameters are significant at the  $P > 0.001$  level. The strongest correlation of  $Q$  exists with APPT ( $r = 0.80$ ). It is not surprising that APPT and ABT are retained in the model because evapotranspiration is first of all a function of temperature and both parameters can thus characterize the water balance in the river basins. It is interesting to note, however, that Slope is linked significantly to  $Q$ . This indicates that in a steep basin, drainage will be greater than in a similar basin with a flat morphology because a greater percentage of precipitation escapes evaporation and can run off superficially.

Consequently, Slope is also retained in the best model to predict the runoff ratio, which is the ratio of drainage over precipitation in river basins. This best model is described by the following equation:

$$Q/\text{APPT} = 0.0039 (\text{APPT}/\text{ABT}) + 13.3 (\text{Slope}/\text{ABT}) \quad (4)$$

$$r = 0.80, \quad P > 0.001, \quad n = 60$$

The units are the same as in (3). Both the ratio APPT/ABT and the ratio Slope/ABT are significant in the equation at the  $P > 0.001$  level.

Mechanical erosion on the continents is more difficult to estimate. Several empirical models have been proposed to predict the sediment fluxes to the ocean [Fournier, 1960; Jansen and Painter, 1974; Pinet and Souriau, 1988; Probst and Sigha, 1989; Probst, 1992], but the retained parameters vary considerably between the models and the correlation are often weak. On the basis of our data we find that the following equation is the best model to predict the TSS fluxes on a global scale:

$$F_{\text{TSS}} = 0.0176 (Q * \text{Slope} * I_{\text{Four}}) + 45.0 \quad (5)$$

$$r = 0.90, \quad P > 0.001, \quad n = 58$$

Of all rivers listed in Table 1, two rivers were not included in the regression. These are Huanghe River in China and the Tana River in Kenya (see below).  $F_{\text{TSS}}$  is in tons per square kilometer per year,  $Q$  in millimeters, and Slope in radian.  $I_{\text{Four}}$  is an index originally proposed by Fournier [1960] to characterize rainfall variability. Large values relate to great variability, and low values characterize sites with an evenly distributed rainfall. For this study, we used a modified version of the Fournier Index [Corine, 1992], which was calculated as following:

$$I_{\text{Four}} = \frac{12}{\sum_{i=1}^{12} (PP_i^2 / \text{APPT})} \quad (6)$$

$PP_i$  is the precipitation total (millimeters) in month  $i$ , and the unit of APPT is again millimeters. Equation (5) explains sediment fluxes as a product of parameters. This is necessary to account for the highly variable TSS fluxes observed for the different river basins. The form is similar to the universal soil loss equation (USLE) developed by Wischmeier *et al.* [1958], which was designed as a means of computing local scale assessments of soil loss by rainfall from agricultural land. As in our equation, the USLE also includes rainfall intensity and Slope as the principal factors that control soil erosion. In addition, other parameters (that is, soil erodibility as a function of soil properties such as soil texture; density and structure of the vegetation cover) are included in the USLE as well.

There is no doubt that the intensity of mechanical erosion and, related to this, specific sediment fluxes may depend upon various factors, and more detailed investigations are needed to better understand the controlling factors for sediment fluxes at the global scale [Ludwig and Probst [1996]]. For example, Probst and Amiotte-Suchet [1992] pointed out the role of the lithology for the fluvial sediment transport in North Africa, and Probst [1992] showed that this may be also globally the case. A very erodible lithology is probably also the reason why the Huanghe

and the Tana rivers do not fit well with our  $F_{TSS}$  model. These rivers have relatively low to moderate specific runoff values, but very large sediment loads. For both rivers, the sediment loads can be related to specific, very erodible regions within the basins [Dai, 1988; Charania, 1988]. For example, 85 % of the sediment transported within the lower Huanghe River is derived from the loess region of the middle river [Dai, 1988], making it the river with the highest sediment load worldwide. Including both rivers in the regression does not change the significance of the retained parameter, but decreases the value of the regression coefficient considerably ( $r = 0.80$ ).

However, our results are in good agreement with the study of Phillips [1990], who examined the relative influence of different climatic, topographic, hydrographic, soil erodibility, and surface cover factors on global variations in soil loss. He used a theoretical soil loss model together with hypothetical extreme conditions to determine the contribution of each factor to the maximum expected variation in soil erosion. He revealed that slope gradient, runoff, and precipitation factors together should account by far for most of the global variation in soil erosion rates.

### River Input to the Ocean

In order to establish global and regional budgets for the export of organic carbon to the oceans, we applied the discussed relationships to the total continental area. This requires first of all the creation of digitized data sets for drainage and sediment yield, if possible in a similar spatial resolution as available in the other data sets. We did this by combining the empirical models already presented with the observed river averages listed in Table 1. The advantage of this method is that the resulting maps take

into account not only the principal factors, that control the variability for the considered parameters, but they also summarize the observations for numerous major rivers that together cover about half of the exoreic area. Regional particularities caused by factors not included in the empirical models are hence respected as well. This is especially important for sediment fluxes. Therefore, such maps should give realistic figures at least on a regional scale.

The map for the drainage intensity over the continents was created by calculating a theoretical specific drainage value ( $Q_{th}$ ) for all grid elements in a resolution of  $0.5^\circ$  longitude/latitude following the relationship for the runoff ratio in (4). The runoff ratios were then multiplied by the precipitation data. Ratios lower than 0 or higher than 1 were set to 0 and 1, respectively. On basis of the average values for the 60 river basins, the correlation between  $Q$  and  $Q_{th}$  is as great that found for (1) ( $r = 0.92$ ), but with this method, all individual drainage values are less than, or at most equal to, the corresponding APPT values of the grid elements. In a second step, we corrected the individual  $Q_{th}$  values for all grid cells within the borders of river basins by a multiplication with the ratio formed by the basin averages  $Q/Q_{th}$ . For the grid elements that do not fall into one of the basins, the  $Q$  values were obtained by a triangular interpolation between the next basin values. Also here, the interpolation was coupled to the calculated  $Q_{th}$  values. With this method we find a good agreement for the values when two or several basins border directly to each other.

Figure 4a shows the resulting drainage map. Total continental runoff to the oceans amounts to  $38170 \cdot 10^9 \text{ m}^3/\text{yr}$ , not including the runoff from polar regions under permanent ice cover. This is very close to the figure of  $39700 \cdot 10^9 \text{ m}^3/\text{yr}$  given in the work of Baumgartner and Reichel [1975], which, however, includes run-

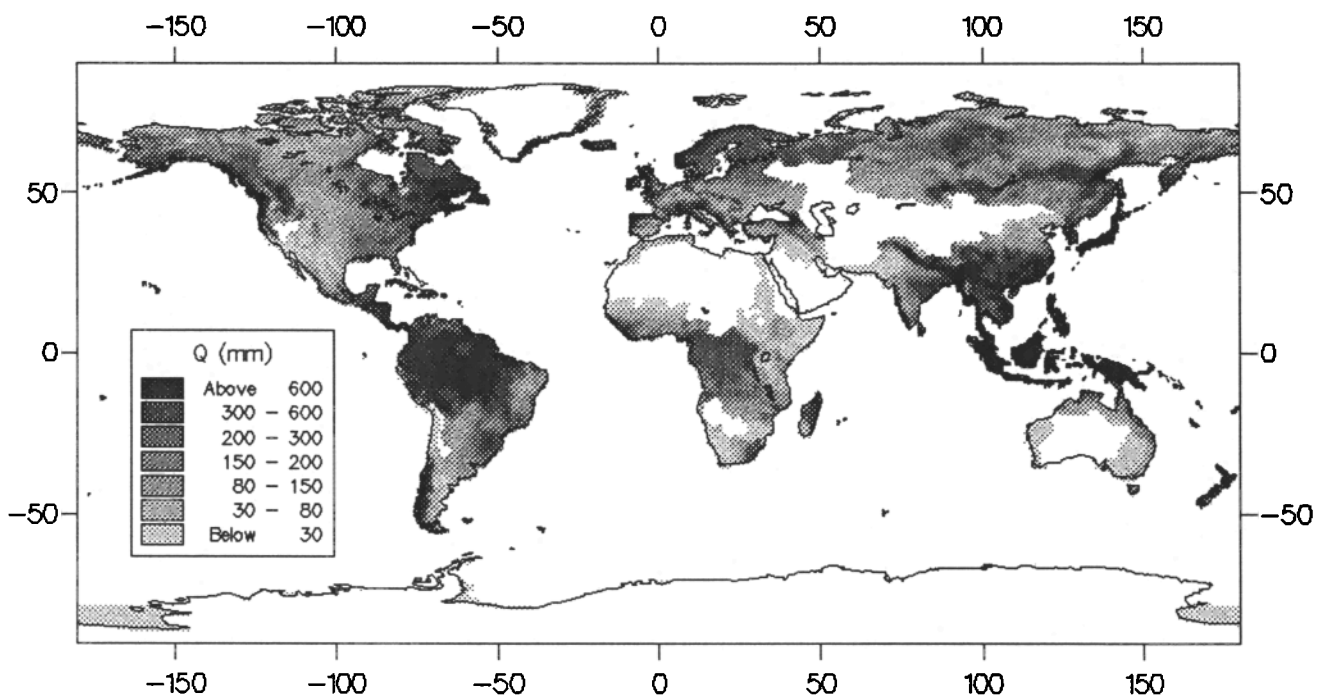

**Figure 4a.** Estimated continental drainage intensity (millimeters) Endoreic basins and glaciated regions are omitted

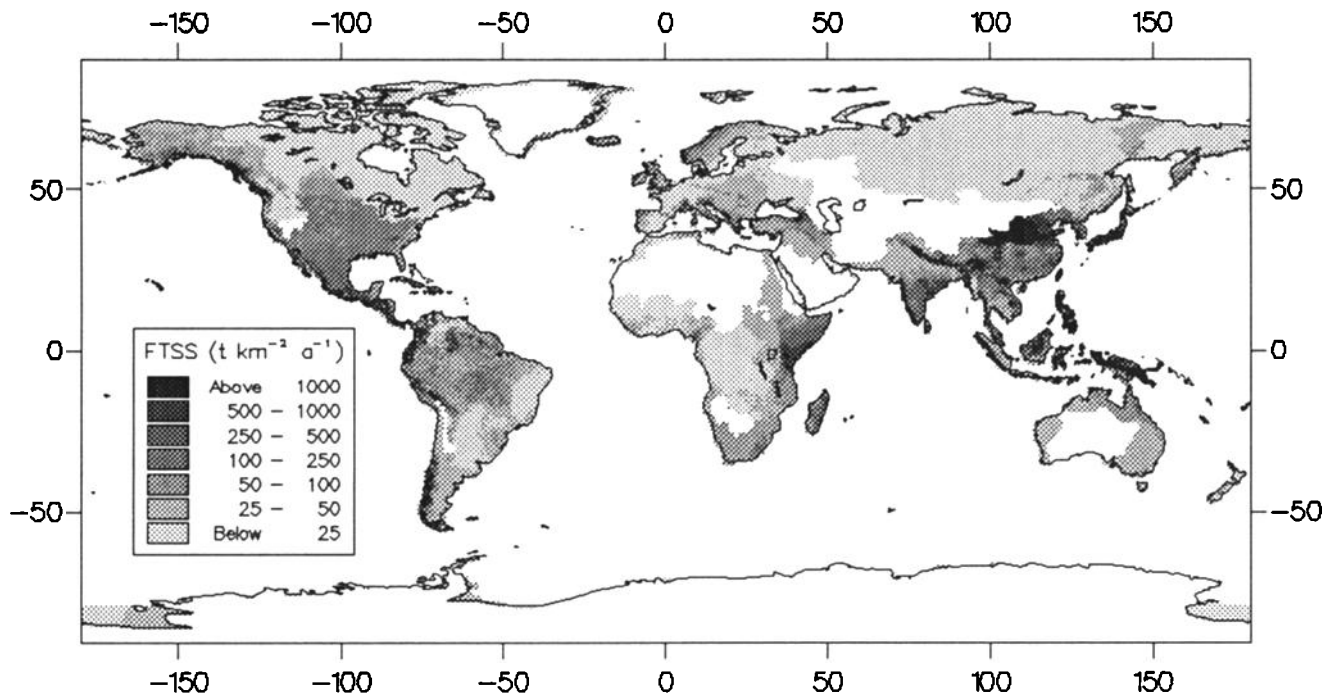

**Figure 4b.** Estimated sediment yield from the continents (tons per square kilometers per year). Endoreic basins and glaciated regions are omitted.

off from glaciated regions. Also for most of the continents, our values lie within 10 % of their estimates.

The data set for sediment fluxes was derived in a similar way. For a spatial resolution of  $0.5^\circ$  longitude/ latitude we calculated a theoretical TSS flux ( $F_{TSS-th}$ ) following (5) and we corrected the theoretical values with the observed river data in the same way as was done for discharge. Figure 4b shows our  $F_{TSS}$  map. By far the larger values are assigned to the mountainous regions, which is in good agreement with field studies. In many rivers most of the sediment is derived from the mountains where the river originates, while the lowlands are often characterized by sedimentation processes [Milliman and Syvitski, 1992]. For example, Gibbs [1967] and Meade *et al.* [1985] reported for the Amazon Basin that at least 80 % of the sediments originate from the Andes. We find with our map that 55 % of the total sediment load transported by the Amazon comes from regions with altitudes  $> 500$  m. These regions cover only about 10 % of the total basin area and represent mainly the Andes. Our method suffers from the shortcoming that it cannot account for sediment storage in the basins, which may at least partly explain the discrepancy between the observations and our method. Because of the smoothing character of the method (when there is storage in one part of the basin, the more must be eroded in the other part of the basin to yield the average sediment flux observed at the river mouth) the map certainly underestimates specific fluxes in some parts of the basins.

For the total sediment flux to the oceans, we calculate a quantity of 18.1 Gt/yr. This is considerably greater than the early estimate of Milliman and Meade [1983] of 13.5 Gt/yr (a figure that was already influenced by dam retention of sediments) and it is closer to the more recent estimate of Milliman and Syvitski [1992], who supposed that global TSS flux may be as high as 20

Gt/yr. One has also to mention here that our method tends to underestimate the global figure because it cannot account for the effect on basin size on sediment yields. The map is mainly based on the observations for large river basins where sediment storage is normally more important than in small basins, but the parts of the continents which do not fall in one of our basins (and where specific sediment fluxes were obtained by an interpolation between next basin values) consist mainly of small watersheds. Here specific sediment yields should be greater on average [Milliman and Syvitski, 1992].

The organic carbon fluxes can then be obtained by applying equations (1) and (2) to the corresponding data sets. For the POC, we calculated the average cTSS for each grid element by combining the  $Q$  and  $F_{TSS}$  data sets and by multiplying the resulting POC% from (2) with the corresponding  $F_{TSS}$  values. According to the minimum in equation (2), all POC% values were limited to a minimum of 0.5 %. For DOC fluxes, negative values, which can result from (1), were set to zero. This occurred, however, only for a few grid elements and did not influence the global results much. The resulting maps for the specific DOC and POC export are shown in Figure 5a and 5b, respectively. In order to point out regional particularities of the organic carbon transport to the oceans, the carbon fluxes are further detailed for the different continents, the different ocean basins, and for the major climatic zones on the basis of our climatic classification mentioned above (Table 4). The corresponding runoff and TSS fluxes are listed as well. Note that the values represent natural averages, which do not account for human impact, including reservoir retention (POC retention in reservoir is, for example, discussed by Meybeck [1993b]) Present-day  $F_{TSS}$  and  $F_{POC}$  may be considerably lower because of damming of rivers

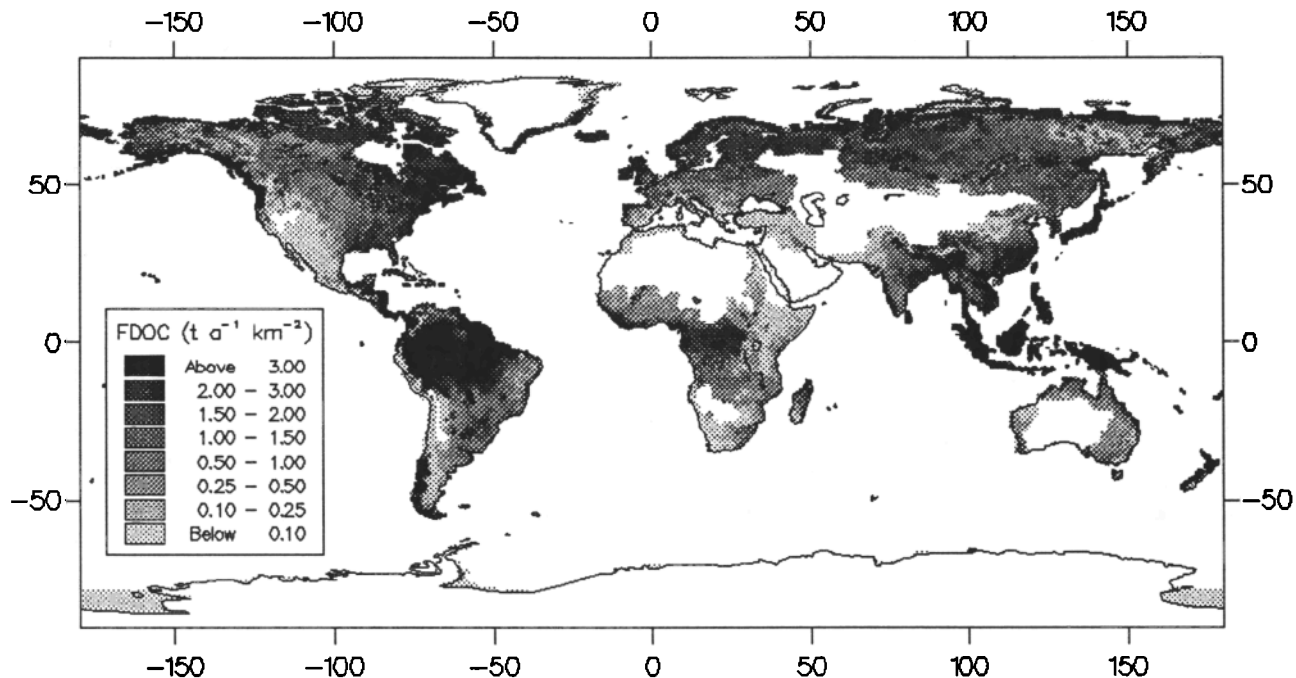

**Figure 5a.** Estimated continental DOC fluxes (tons per square kilometers per year). Endoreic basins and glaciated regions are omitted.

We find that 0.378 Gt of organic carbon are transported to the oceans every year. About 55 % of this carbon enters the oceans in dissolved form and about 45 % in particulate form. These figures are very close to previous estimates. *Meybeck* [1993a] calculated transports of 0.198 Gt DOC/yr and of 0.170 Gt

POC/yr (i.e., nearly identical with our values). On a regional scale, however, we find large differences to *Meybeck's* figures. He estimated, for example, that about 65 % of the global DOC flux originates from the wet tropics [*Meybeck* 1982; 1988, 1993b], while our calculations yield only about 45 %.

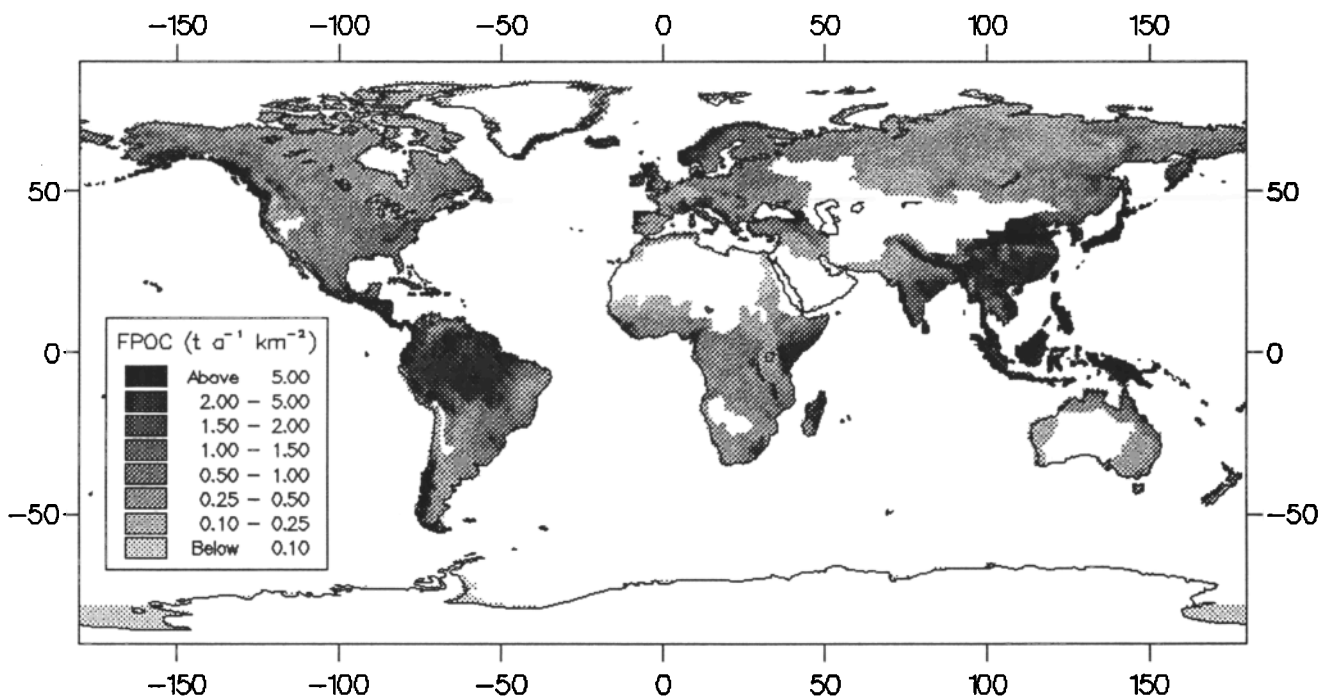

**Figure 5b.** Estimated continental POC fluxes (tons per square kilometers per year) Endoreic basins and glaciated regions are omitted

**Table 4.** Estimated Fluxes of Water, Sediment, DOC, and POC to the Oceans

	Area, 10 <sup>3</sup> km <sup>2</sup>	Q, 10 <sup>9</sup> m <sup>3</sup> /yr	F <sub>rss</sub> , 10 <sup>12</sup> g/yr	F <sub>DOC</sub> , 10 <sup>12</sup> g/yr	F <sub>POC</sub> , 10 <sup>12</sup> g/yr	Average DOC, mg/L	Average POC, mg/L	DOC/ POC
Polar	4527	665	62	6.79	1.45	10.21	2.18	4.7
Tundra and Taiga	23633	7071	893	47.31	18.15	6.69	2.57	2.6
Temperate Dry	11958	1667	2493	7.92	16.10	4.75	9.66	0.5
Temperate Wet	13919	6165	3031	27.34	28.91	4.43	4.69	0.9
Tropical Wet	23633	18439	8015	90.24	81.09	4.89	4.40	1.1
Tropical Dry	22932	4036	3001	23.92	23.93	5.93	5.93	1.0
Desert	5724	127	636	1.29	3.30	10.18	25.96	0.4
Total	106326	38170	18132	204.81	172.94	5.37	4.53	1.2
Arctic Ocean	16982	3139	199	28.28	6.92	9.01	2.20	4.1
North Atlantic	27300	14115	3387	76.69	46.77	5.43	3.31	1.6
South Atlantic	16959	4181	648	26.90	13.03	6.43	3.12	2.1
Pacific	21025	11580	8542	49.46	69.17	4.27	5.97	0.7
Indian Ocean	16594	4217	4861	19.06	32.21	4.52	7.64	0.6
Mediterranean	6739	928	480	4.40	4.81	4.74	5.19	0.9
Antarctic Ocean	728	11	17	0.03	0.03	3.09	3.01	1.0
Total	106326	38170	18132	204.81	172.94	5.37	4.53	1.2
Africa	18288	3201	1547	20.11	14.35	6.28	4.48	1.4
Europe	9564	2892	630	14.69	10.48	5.08	3.62	1.4
North America	23020	7047	2920	41.18	27.62	5.84	3.92	1.5
South America	17732	11226	2969	56.11	41.73	5.00	3.72	1.3
Asia	32518	13196	9840	69.01	76.40	5.23	5.79	0.9
Australia	4476	596	209	3.67	2.32	6.16	3.89	1.6
Antarctis	728	11	17	0.03	0.03	3.09	3.01	1.0
Total	106326	38170	18132	204.81	172.94	5.37	4.53	1.2

Fluxes are detailed for major climates, different ocean basins, and different continents. Differences in figures are caused by rounding.

obtained his estimates by selecting one or few river as fully representative of one climatic type. The average concentrations for these rivers were then multiplied by an estimated runoff value attributed to each climate. As we showed above, this is problematic because big river systems rarely fall exclusively in one climate zone. Moreover, the reported concentrations for rivers from similar climates often vary considerably, and selecting only one river is always subjective. *Meybeck* [1988] considered an average DOC concentration of 8 mg/L to be representative of the wet tropics. This is exclusively based on the value found for the Zaire River, while the values of the Amazon and the Orinoco are both below 4.5 mg/L (see Table 2).

It is interesting to compare *Meybeck's* average concentrations for different climates with the mean concentrations derived from our results (Table 4). Both classifications are not identical, but are similar in the distinction of the major climates represented on Earth. For all of our concentration values given in Table 4, one has to keep in mind that they are calculated as the sum of the fluxes of all grid elements falling into one of the climatic types divided by the runoff of these grid elements. It would be misleading to associate the values to individual rivers belonging to one of the climates because, as we showed above, for both DOC and POC export, the morphologies of river basins play an important role. *Meybeck* [1988] assumed low DOC concentrations for the semiarid (1.0 mg/L) and dry tropical regions (3.0 mg/L), intermediate to elevated DOC concentrations for the temperate zones (4.0 mg/L) and for the tundra and taiga (6.0 mg/L), and great DOC values for the wet tropics (8.0 mg/L). His work is in general agreement with our findings for the temperate zones and for the tundra and taiga. For the other values, however,

our results show the contrary. Going from dry climates to wet climates, DOC concentrations clearly diminish, and for the wet tropics we calculate one of the lower concentrations of all climates. This is not a surprising feature. Neglecting the morphological effects on the organic carbon export, which can be supposed to be averaged out over the major climates, the variation of the concentrations should principally be a function of the variation of drainage intensity together with the variation of the soil carbon pool. Consequently, on a global scale, the latter varies much less than does the drainage intensity, it is mainly the drainage intensity that determines not only specific flux rates but also average concentrations.

For the tundra and taiga, we have large SoilC values together with still large *Q* values, leading to elevated DOC concentrations. This is in good agreement with field data [*Romankevich and Artemyev*, 1985; *Clair et al.*, 1994]. On the basis of data for small Canadian rivers, *Clair et al.* [1994] extrapolated for the boreal climate a median organic carbon export rate (DOC + POC) of 2.7 t km<sup>-2</sup> yr<sup>-1</sup>. Our models yield a figure of 2.8 t km<sup>-2</sup> yr<sup>-1</sup> for the tundra and taiga climate. For the wet tropics, our relative low DOC concentration of 4.89 mg/L is close to the values found for the Amazon and the Orinoco rivers and can be explained as an effect of dilution caused by intensive drainage. The high concentrations in dry climates are the result of a very low drainage intensity together with low, but still considerable SoilC values. For POC concentrations, the trend is similar to that of the DOC concentrations. For most of the continental area, the DOC/POC ratio is close to one, with a global value of 1.2. The increase of POC concentrations in desert climates is greater than for the DOC. This is explained by the high mechanical



erodibility observed in these zones. Here the DOC/POC ratio drops to 0.4. Contrary to DOC, the POC concentration for tundra and taiga is low, reflecting the low  $F_{TSS}$  typical of this region. This may also be the result of a reduced erosivity of precipitation, because a considerable part of runoff occurs as snowmelt. In tundra and taiga, the DOC transport exceeds the POC transport nearly by a factor of 3.

For the different oceans, one can note that the major part of the global DOC flux is discharged to the Atlantic (51 %), while the bulk of the POC discharges into Pacific and Indian Ocean (59 %). This discrepancy reflects the large sediment yield from the southern and southeastern part of the Asian continent. We calculated that 74 % of the global TSS load is eroded from the continental area that is drained to the Pacific and Indian Ocean, but is mobilized by only 41 % of the global runoff. For the two hemispheres, we estimate that one quarter to one third of the fluxes are going to the oceans in the southern hemisphere. Naturally, these figures do not account for the sedimentation and respiration processes taking place in river estuaries, which restricts the further offshore transport of fluvial organic matter to the coastal zone [Eisma and Cadée, 1991]. South America has the highest specific erosion rate of organic carbon. The rate for this continent is about three times greater than that of Africa and about 4 times greater than that of Australia, the continents with the lowest erosion rates of organic carbon (not including Antarctica).

## Conclusions

Numerous field studies carried out recently in major world rivers have led to a considerable body of data on transport of organic carbon. Most of these studies have tried to explain the seasonal variation of fluxes with the variation of the river hydrograph. We show for the first time that it is also possible to relate the variability of annual carbon fluxes with the environmental variability of river basins. Our statistical approach using average river basin values allows only a very general view, but it can identify the principal factors that control the organic carbon fluxes globally. The retained parameters in our empirical models agree well with field results, and our global carbon fluxes are close to previous estimates.

Drainage intensity and specific sediment fluxes are the most important factors that control the transport of organic carbon to the oceans. Both parameters can be related further to basic climatic and morphologic parameters, namely precipitation, rainfall intensity, temperature, and steepness of basin morphology. For dissolved organic carbon, fluxes are also controlled by the amount of carbon stored in soils, supporting the general assumption that SoilC is the major source for DOC in river waters. Precise figures for the spatial distribution of SoilC are still not available, and the average values that we calculated for the river basins are only crude estimates. However, such estimates give an idea about the regional variability of this parameter. In fact, the variability between the river basins is relative low, which may explain the low variability of average DOC concentration found in most of the rivers. There are strong indications that SoilC is also the main source for riverine POC (as shown by Hedges *et al.* [1986] for the Amazon). However, the close relationship of POC fluxes with TSS fluxes together with the great variability of mechanical erosion rates over the continents makes it difficult to

identify other parameters than  $F_{TSS}$  that may influence POC fluxes on a global scale. This does not mean that POC has always the same origin as the sedimentary particles. More information is needed, for example, about the amount of autochthonous POC coming from lakes and floodplains in certain river systems.

It is interesting that Slope enters the equations in nearly all our empirical models. Even though climate is the main factor determining organic carbon fluxes, in individual rivers Slope may be more important. Therefore, it is not suitable to extrapolate the carbon flux of an entire climate region from one river. For DOC fluxes, basin morphology has two opposite effects: A steep morphology increases drainage intensity, but at the same time it should also reduce the average DOC concentration because Slope is correlated negatively with  $F_{DOC}$ . According to our equations, the latter effect dominates and a steeper morphology leads to lower specific DOC fluxes. For POC, a steep morphology generates both more runoff and increased sediment loads, and the POC concentration itself increases with slope even if the POC% in the TSS is decreasing.

For further studies, our models can be applied to simulate continental carbon erosion and carbon transfer to oceans in response to different climate or land use change scenarios, or to any other natural or anthropogenic perturbation. To improve predictions in such scenarios, however, more information about the interactions of soil organic matter accumulation, respiration, and erosion is needed. This concerns also inorganic carbon fluxes because  $CO_2$  consumption by mineral dissolution may be controlled essentially by elevated  $pCO_2$  resulting from biological respiration of organic matter in soils. Another important question is the ultimate fate of the organic matter eroded from the biosphere. Erosion causes a permanent input of organic carbon to the oceans and little is known about the percentage that returns to the atmosphere by marine respiration or that is lost to the lithosphere by sedimentation [Smith and Hollibough, 1992; Kempe, 1995]. Further river field studies, which should focus on the origin and nature of organic matter transported by rivers, are needed to understand the role of erosion in the global carbon cycle.

**Acknowledgments.** This work was supported by a funding of the Commission of the European Communities within the project The Global Carbon Cycle and its Perturbation by Man and Climate II - Terrestrial Biosphere, (ESCOBA, contract EV5V CT 92 0119). We thank all participants of the SCOPE/ UNEP project Transport of Carbon and Minerals in Major World Rivers, who agreed with us to use some of their still unpublished data. Organic carbon fluxes for the Garonne River were obtained within the French INSU/ CNRS program DBT I/ Fleuves et Erosion. Most of the data used in this study were supplied to the IGBP/ LOICZ river database, and will be published in a special LOICZ report. We are very grateful to John Milliman and an anonymous reviewer for their reviews of the manuscript, and to P. Boudreau and C. Swezey for their insightful comments on earlier drafts of it.

## References

- Abu el Ella, E.M., Preliminary studies on the geochemistry of the Nile river basin, Egypt, in *Transport of Carbon and Minerals in Major World Rivers*, vol. 6, Mitt. Geol.-Paläont. Inst. Univ. Hamburg, SCOPE/UNEP Sonderbd. 74, edited by S. Kempe, D Eisma, and E.T. Degens, pp. 115-134, Universität Hamburg, Hamburg, 1993.
- Adams, J.M., H. Faure, L. Laure-Denard, J.M. McGlade, and F.I. Woodward, Increases in terrestrial carbon storage from the last glacial maximum to the present, *Nature*, 348, 711-714, 1990.

- Ahamer, G., J. Spitzer, C.O. Weiss, and G. Fankhauser, Der Einfluss einer verstärkten energetischen Biomassennutzung auf die CO<sub>2</sub>-Konzentration in der Atmosphäre, *Final Rep. 1992*, Inst. for Energy Res., Joanneum Res., Graz, 1992.
- Amiotte-Suchet, P., Cycle du carbone, érosion chimique des continents et transferts vers les océans, *Sci. Geol. Mém., Strasbourg*, 97, 1-156, 1995.
- Amiotte-Suchet, P., and J.L. Probst, Modeling of atmospheric CO<sub>2</sub> consumption by chemical weathering of rocks: Application to the Garonne, Congo and Amazon basins, *Chem. Geol.*, 107, 205-210, 1993a.
- Amiotte-Suchet, P., and J.L. Probst, J.-L. Flux de CO<sub>2</sub> consommé par altération chimique continentale: Influence du drainage et de la lithologie, *C. R. Acad. Sci. Paris*, 317, 615-622, 1993b.
- Amiotte-Suchet, P., and J.L. Probst, A global model for present day atmospheric/ soil CO<sub>2</sub> consumption by chemical erosion of continental rocks (GEM-CO<sub>2</sub>), *Tellus 47B*, 273-280, 1995.
- Arain, R., Persisting trends in carbon and mineral transport monitoring of the Indus River, in *Transport of Carbon and Minerals in Major World Rivers*, vol. 4, Mitt. Geol.-Paläont. Inst. Univ. Hamburg, SCOPE/UNEP Sonderbd. 64, edited by E.T. Degens, S. Kempe, and Gan Wei-Bin, pp. 417-421, Universität Hamburg, Hamburg, 1987.
- Baumgartner, A., and E. Reichel (Eds.), *The World Water Balance*, 179 pp., Elsevier, New York, 1975.
- Bolin, B., E.T. Degens, P. Duvigneaud, and S. Kempe, The global biogeochemical carbon cycle, in *The Global Carbon Cycle*, SCOPE Rep. 13, edited by B. Bolin, E.T. Degens, S. Kempe, and P. Ketner, pp. 1-56, John Wiley, New York, 1979.
- Cadée, G.C., Organic carbon in the Ems River and estuary: A comparison of summer and winter conditions, in *Transport of Carbon and Minerals in Major World Rivers*, vol. 4, Mitt. Geol.-Paläont. Inst. Univ. Hamburg, SCOPE/UNEP Sonderbd. 64, edited by E.T. Degens, S. Kempe, and Gan Wei-Bin, pp. 359-374, Universität Hamburg, Hamburg, 1987.
- Carvalho, N.D., Sediment yield in the Velhas River basin (Minas Gerais, Brazil), in *Sediment Budgets, Proceedings on the Porto Alegre Symposium*, IAHS Publ., 174, edited by M.P. Bordas, and D. Walling, pp. 369-375, IAHS Press, Wallingford, UK, 1988.
- Cauwet, G., and F.T. Mackenzie, Carbon inputs and distribution in estuaries of turbid rivers: The Yang Tse and Yellow rivers (China), *Mar. Chem.* 43, 235-246, 1993.
- Charania, S.H., A strategy for organizing a sediment data collection network based on the available hydrological records for a catchment in Kenia, in *Sediment Budgets, Proceedings on the Porto Alegre Symposium*, IAHS Publ., 174, edited by M.P. Bordas, and D. Walling, pp. 181-195, IAHS Press, Wallingford, UK, 1988.
- Clair, T.A., T.L. Pollock, and J.M. Ehrman, Exports of carbon and nitrogen from river basins in Canada's Atlantic Provinces, *Global Biogeochem. Cycles*, 8, 441-450, 1994.
- Corine, Soil erosion risk and important land resources in the southern regions of the European Community, *Rep. EUR 13233*, pp. 99, Off. for Official Publ. of the Euro. Commun., Brussels, Luxembourg, 1992.
- Dahn, C.N., S.V. Gregory, and P.K. Park, Organic carbon transport in the Columbia River, *Estuarine Coastal Shelf Sci.*, 13, 645-658, 1981.
- Dai, S., Analysis of sediment yields during the historic period in the loess region of the Yellow River basin, in *Sediment Budgets, Proceedings on the Porto Alegre Symposium*, IAHS Publ., 174, edited by M.P. Bordas, and D. Walling, pp. 377-380, IAHS Press, Wallingford, UK, 1988.
- Degens, E.T. (Ed.), *Transport of Carbon and Minerals in Major World Rivers*, vol. 1, Mitt. Geol.-Paläont. Inst. Univ. Hamburg, SCOPE/UNEP Sonderbd. 52, 766 pp., Universität Hamburg, Hamburg, 1982.
- Degens, E.T., S. Kempe, and S. Soliman (Eds.), *Transport of Carbon and Minerals in Major World Rivers*, vol. 2, Mitt. Geol.-Paläont. Inst. Univ. Hamburg, SCOPE/UNEP Sonderbd. 55, 535 pp., Universität Hamburg, Hamburg, 1983.
- Degens, E.T., S. Kempe, and A. Spitzky, Carbon dioxide: A biogeochemical portrait, in *The Handbook of Environmental Chemistry*, vol. 1, edited by C.O. Hutzing, pp. 127-215, Springer-Verlag, Berlin, 1984.
- Degens, E.T., S. Kempe, and R. Herrera (Eds.), *Transport of Carbon and Minerals in Major World Rivers*, vol. 3, Mitt. Geol.-Paläont. Inst. Univ. Hamburg, SCOPE/UNEP Sonderbd. 58, 645 pp., Universität Hamburg, Hamburg, 1985.
- Degens, E.T., S. Kempe, and Gan Wei-Bin (Eds.), *Transport of Carbon and Minerals in Major World Rivers*, vol. 4, Mitt. Geol.-Paläont. Inst. Univ. Hamburg, SCOPE/UNEP Sonderbd. 64, 512 pp., Universität Hamburg, Hamburg, 1987.
- Degens, E.T., S. Kempe, and A.S. Naidu (Eds.), *Transport of Carbon and Minerals in Major World Rivers*, vol. 5, Mitt. Geol.-Paläont. Inst. Univ. Hamburg, SCOPE/UNEP Sonderbd. 66, 422 pp., Universität Hamburg, Hamburg, 1988.
- Degens, E.T., S. Kempe, and J.E. Richey (Eds.), *Biogeochemistry of Major World Rivers*, 356 pp., SCOPE Rep. 42, John Wiley, New York, 1991a.
- Degens, E.T., S. Kempe, and J.E. Richey, Summary: Biogeochemistry of major world rivers, in *Biogeochemistry of Major World Rivers*, SCOPE Rep. 42, edited by E.T. Degens, S. Kempe, and J.E. Richey, pp. 323-347, John Wiley, New York, 1991b.
- Depetris, P.J., and E.A. Cascante, Carbon transport in the Paraná River, in *Transport of Carbon and Minerals in Major World Rivers*, vol. 3, Mitt. Geol.-Paläont. Inst. Univ. Hamburg, SCOPE/UNEP Sonderbd. 58, edited by E.T. Degens, S. Kempe, and R. Herrera, pp. 299-304, Universität Hamburg, Hamburg, 1985.
- Depetris, P.J., and S. Kempe, The impact of the EL Niño 1982 event on the Paraná River, its discharge and carbon transport, *Palaeogeogr. Palaeoclimatol. Palaeoecol.*, 89, 239-244, 1990.
- Depetris, P.J., and J. Paolini, Biogeochemical aspects of South American rivers: The Paraná and the Orinoco, in *Biogeochemistry of Major World Rivers*, SCOPE Rep. 42, edited by E.T. Degens, S. Kempe, and J.E. Richey, pp. 105-125, John Wiley, New York, 1991.
- Desjardins, T., B. Volkoff, F. Andreux, and C. Cerri, Distribution du carbone total et de l'isotope <sup>13</sup>C dans les sols ferrallitiques du Brésil, *Sci. Sol.*, 29, 175-187, 1991.
- Eckhardt, B.W., and T.R. Moore, Controls on dissolved organic carbon concentrations in streams, southern Québec, *Can. J. Fish. Aquat. Sci.*, 47, 1537-1544, 1990.
- Eisma, D., and G.C. Cadée, Particulate matter processes in estuaries, in *Biogeochemistry of Major World Rivers*, SCOPE Rep. 42, edited by E.T. Degens, S. Kempe, and J.E. Richey, pp. 283-296, John Wiley, New York, 1991.
- Eisma, D., G.C. Cadée, and R. Laane, Supply of suspended matter and particulate and dissolved organic carbon from the Rhine to the coastal North Sea, in *Transport of Carbon and Minerals in Major World Rivers*, vol. 1, Mitt. Geol.-Paläont. Inst. Univ. Hamburg, SCOPE/UNEP Sonderbd. 52, edited by E.T. Degens, pp. 483-506, Universität Hamburg, Hamburg, 1982.
- Esser, G., Osnabrück Biosphere Model: Structure, construction, results, in *Modern Ecology*, edited by G. Esser and D. Overdieck, pp. 679-709, Elsevier, New York, 1991.
- Esser, G., and G.H. Kohlmaier, Modeling terrestrial sources of nitrogen, phosphorus, sulphur and organic carbon to rivers, in *Biogeochemistry of Major World Rivers*, SCOPE Rep. 42, edited by E.T. Degens, S. Kempe, and J.E. Richey, pp. 297-322, John Wiley, New York, 1991.
- Eswaran, H., E. Van Den Berg, and P. Reich, Organic carbon in soils of the world, *Soil Sci. Soc. Am. J.*, 57, 192-194, 1993.
- Fleet Numerical Oceanography Center (FNOC), Global elevation, terrain, and surface characteristics, Digital raster on a 10 minute geographic (lat/long) 1080x2160 grid, in *Global Ecosystems Database, Version 1.0 Disc (CD-ROM)*, edited by NOAA National Geophysical Data Center, A. Boulder, Colo., 1992.
- Fournier, F. (Ed.), *Climat et érosion*, 201 pp., Presses Universitaires de France, Paris, 1960.
- Gan Wei-Bin, Chen Hui-Min, and Han Yun-Fang, Carbon transport by the Yangtze (at Nanjing) and Huanghe (at Jinan) rivers, Peoples Republic of China, in *Transport of Carbon and Minerals in Major World Rivers*, vol. 2, Mitt. Geol.-Paläont. Inst. Univ. Hamburg, SCOPE/UNEP Sonderbd. 55, edited by E.T. Degens, S. Kempe, and S. Soliman, pp. 459-470, Universität Hamburg, Hamburg, 1983.
- Gibbs, R.J., The geochemistry of the Amazon river system, the factors that control the salinity and composition and concentration of suspended solids, *Geol. Soc. Am. Bull.*, 78, 1203-1232, 1967.
- Hart, R.C., Carbon transport in the upper Orange River, in *Transport of Carbon and Minerals in Major World Rivers*, vol. 4, Mitt. Geol.-

- Paläont. Inst. Univ. Hamburg, SCOPE/UNEP Sonderbd. 64, edited by E.T. Degens, S. Kempe, and Gan Wei-Bin, pp. 509-512, Universität Hamburg, Hamburg, 1987.
- Hedges, J.L., W.A. Clark, P.D. Quay, J.E. Richey, A.H. Devol, and U.d.M. Santos, Composition and fluxes of particulate organic material in the Amazon River, *Limnol. Oceanogr.*, 31, 717-738, 1986.
- Holdridge, L.R., Determination of world plant formations from simple climatic data, *Science*, 105, 367-368, 1947.
- Henderson-Sellers, A., Continental vegetation as a dynamic component of a global climate model: A preliminary assessment, *Clim. Change*, 23, 337-377, 1993.
- International Geosphere Biosphere Program (IGBP), *Land-Ocean Interactions in the Coastal Zone*, IGBP Rep. No. 25, edited by P.M. Holligan and H. de Bois, Stockholm, 1993.
- Ittekkot, V., Global trends in the nature of organic matter in river suspensions, *Nature*, 332, 436-438, 1988.
- Jansen, J.M.L., and R.B. Painter, Predicting sediment yield from climate and topography, *J. Hydrol.*, 21, 371-380, 1974.
- Kempe, S., Carbon in the rock cycle, in *The Global Carbon Cycle*, SCOPE Rep. 13, edited by B. Bolin, E.T. Degens, S. Kempe, and P. Ketner, pp. 343-377, John Wiley, New York, 1979a.
- Kempe, S., Carbon in the freshwater cycle, in *The Global Carbon Cycle*, SCOPE Rep. 13, edited by B. Bolin, E.T. Degens, S. Kempe, and P. Ketner, pp. 317-342, John Wiley, New York, 1979b.
- Kempe, S., Long-term records of the CO<sub>2</sub> pressure fluctuations in fresh water, in *Transport of Carbon and Minerals in Major World Rivers*, vol. 1, Mitt. Geol.-Paläont. Inst. Univ. Hamburg, SCOPE/UNEP Sonderbd. 52, edited by E.T. Degens, pp. 91-332, Universität Hamburg, Hamburg, 1982.
- Kempe, S., Sinks of the anthropogenically enhanced carbon cycle in surface fresh waters, *J. Geophys. Res.*, 89 (D3), 4657-4676, 1984.
- Kempe, S., Are coastal zones a source of CO<sub>2</sub> to the atmosphere?, *in press*, 1995.
- Kempe, S., M. Pettine, and G. Cauwet, Biogeochemistry of European rivers, in *Biogeochemistry of Major World Rivers*, SCOPE Rep. 42, edited by E.T. Degens, S. Kempe, and J.E. Richey, pp. 169-211, John Wiley, New York, 1991.
- Kempe, S. D. Eisma, and E.T. Degens (Eds.), *Transport of Carbon and Minerals in Major World Rivers*, vol. 6, Mitt. Geol.-Paläont. Inst. Univ. Hamburg, SCOPE/UNEP Sonderbd. 74, 319 pp., Universität Hamburg, Hamburg, 1993.
- Kempe, S., and P.J. Depetris, Factors controlling the concentration of particulate carbohydrates and amino acids in the Paraná River, *Hydrobiologia*, 242, 175-183, 1992.
- Kramer, J.R., Old sediment carbon in global budgets, in *Soil Responses to Climate Change*, NATO ASI Seri., 123, edited by M.D.A. Rounsevell and P.J. Loveland, pp. 169-183, Springer-Verlag, New York, 1994.
- Leenheer, J., United States Geological Survey data information service, in *Transport of Carbon and Minerals in Major World Rivers*, vol. 1, Mitt. Geol.-Paläont. Inst. Univ. Hamburg, SCOPE/UNEP Sonderbd. 52, edited by E.T. Degens, pp. 355-356, Universität Hamburg, Hamburg, 1982.
- Legates, D.R., and C.J. Willmott, Monthly average surface air temperature and precipitation: Digital raster on a 30 minute geographic (lat/long) 360x720 grid, in *Global Ecosystems Database, Version 1.0 Disc (CD-ROM)*, edited by NOAA National Geophysical Data Center, A. Boulder, Colo., 1992.
- Lesack, L.R., Hecky, R.E., and J.M. Melack, Transport of carbon, nitrogen, phosphorus, and major solutes in the Gambia River, West Africa, *Limnol. Oceanogr.*, 29, 816-830, 1984.
- Lewis, W.M., and J.F. Saunders III, Concentration and transport of dissolved and suspended substances in the Orinoco River, *Biogeochemistry*, 7, 203-240, 1989.
- Ludwig, W., and J.L. Probst, A global model for the climatic and geomorphologic control of river sediment discharges to the oceans, in *Erosion and Sediment Yield: Global and Regional Perspectives*, Proceedings on the Exeter Symposium, IAHS Publ., IAHS Press, Wallingford, UK, *in press*, 1996.
- N'Kounkou, R.R., and J.L. Probst, Hydrology and geochemistry of the Congo river system, in *Transport of Carbon and Minerals in Major World Rivers*, vol. 4, Mitt. Geol.-Paläont. Inst. Univ. Hamburg, SCOPE/UNEP Sonderbd. 64, edited by E.T. Degens, S. Kempe, and Gan Wei-Bin, pp. 483-508, Universität Hamburg, Hamburg, 1987.
- Malcom, R.L., and W.H. Durum, Organic carbon and nitrogen concentrations and annual organic carbon load of six selected rivers of the United States, *U.S. Geological Survey Water-Supply Paper*, 1817F, 1-21, 1976.
- Mallows, C.P., Some comments on C<sub>p</sub>, *Technometrics*, 15, 661-675, 1973.
- Mantoura, R.F.C., and E.M.S. Woodward, Conservative behaviour of riverine dissolved organic carbon in the Severn Estuary: Chemical and geochemical implications, *Geochim. Cosmochim. Acta*, 47, 1293-1309, 1983.
- Martins, O., Geochemistry of the Niger River, in *Transport of Carbon and Minerals in Major World Rivers*, vol. 1, Mitt. Geol.-Paläont. Inst. Univ. Hamburg, SCOPE/UNEP Sonderbd. 52, edited by E.T. Degens, pp. 397-418, Universität Hamburg, Hamburg, 1982.
- Martins, O., and J.L. Probst, Biogeochemistry of major African rivers: Carbon and mineral transport, in *Biogeochemistry of Major World Rivers*, SCOPE Rep. 42, edited by E.T. Degens, S. Kempe, and J.E. Richey, pp. 127-155, John Wiley, New York, 1991.
- Meade, R.H., T. Dunne, J.E. Richey, U.d.M. Santos, and E. Salati, Storage and remobilization of suspended sediment in the lower Amazon River of Brazil, *Science*, 228, 488-490, 1985.
- Meybeck, M., Carbon, nitrogen and phosphorus transport by world rivers, *Am. J. Sci.*, 282, 401-450, 1982.
- Meybeck, M., Les fleuves et le cycle géochimique des éléments, *Thèse Sciences*, 558 pp., Univ. Paris VI, 1984.
- Meybeck, M., How to establish and use world budgets of river material, in *Physical and Chemical Weathering in Geochemical Cycles*, edited by A. Lerman, and M. Meybeck, pp. 247-272, Kluwer, Norwell, Mass. 1988.
- Meybeck, M., C, N, P, and S in rivers: From sources to global inputs, in *Interactions of C, N, P and S, Biogeochemical Cycles and Global Change*, edited by R. Wollast, F.T. Mackenzie, and L. Chou, pp. 163-193, Springer-Verlag, New York, 1993a.
- Meybeck, M., Riverine transport of atmospheric carbon: Sources, global typology and budget, *Water, Air, and Soil Pollut.*, 70, 443-463, 1993b.
- Meybeck, M., G. Cauwet, S. Dessery, M. Somville, D. Gouleau, and G. Billen, Nutrients (organic C, P, N, Si) in the eutrophic river Loire and its estuary, *Estuarine Coastal Shelf Sci.*, 27, 595-624, 1988.
- Milliman, J.D., and R.H. Meade, World-wide delivery of river sediment to the oceans, *J. Geol.*, 91, 1-21, 1983.
- Milliman, J.D., Xie Qinhun, and Yang Zuocheng, Transfer of particulate organic carbon and nitrogen from the Yangtze River to the ocean, *Am. J. Sci.*, 284, 824-834, 1984.
- Milliman, J.D., and J.P.M. Syvitski, Geomorphic/ tectonic control of sediment discharge to the ocean: the importance of small mountainous rivers, *J. Geol.*, 100, 525-544, 1992.
- Moore, J.G., and R.K. Mark, World slope map, *Eos Trans. AGU*, 67, 48, 1353-1356, 1986.
- Moore, T.R., Dynamics of dissolved organic carbon in forested and disturbed catchments, Westland, New Zealand, 1, Maimai, *Water Resour. Res.*, 25, 1321-1330, 1989.
- Olson, J.S., J.A. Watts, and L.J. Allison, Carbon in live vegetation of major world ecosystems, *Rep. ORNL-5862*, Oak Ridge Nat. Lab., Oak Ridge, Tenne., 1983.
- Olson, J.S., J.A. Watts, and L.J. Allison, Major world ecosystem complexes ranked by carbon in live vegetation: A database, *Rep. NDP-017*, Carbon Dioxide Information Analysis Center, Oak Ridge Nat. Lab., Oak Ridge, Tenne., 1985.
- Pettine, M., T. La Noce, R. Pagnotta, and A. Puddu, Organic and trophic load of major Italian rivers, in *Transport of Carbon and Minerals in Major World Rivers*, vol. 3, Mitt. Geol.-Paläont. Inst. Univ. Hamburg, SCOPE/UNEP Sonderbd. 58, edited by E.T. Degens, S. Kempe, and R. Herrera, pp. 417-429, Universität Hamburg, Hamburg, 1985.
- Phillips, J.D., Relative importance of factors influencing fluvial soil loss at a global scale, *Am. J. Sci.*, 290, 547-568, 1990.
- Pinet, P., and M. Souriau, Continental erosion and large scale relief, *Tectonics*, 7, 563-582, 1988.
- Post, W.M., P. Pastor, P.J. Zinke, and A.G. Stangenberger, Global patterns of soil nitrogen storage, *Nature*, 317, 613-616, 1985.

- Post, W.M., Organic carbon in soil and the global carbon cycle, in *The Global Carbon Cycle. NATO ASI Ser. I., vol. 15.*, edited by M. Heimann, 599 pp., Springer-Verlag, New York, 1993.
- Prentice, K.C., Bioclimatic distribution of vegetation for general circulation model studies, *J. Geophys. Res.*, *95*, (D8), 11 811-11 830, 1990.
- Probst, J.L., Géochimie et hydrologie de l'érosion continentale, Mécanismes, bilan global actuel et fluctuations au cours des 500 derniers millions d'années, *Sci. Geol. Mém.*, *94*, Strasbourg, 1-161, 1992.
- Probst, J.L., and N. Sigha, Estimation de l'écoulement superficiel et de sa charge en suspension sur quelques grands bassins fluviaux du monde, *C. R. Acad. Sci. Paris*, *309*, II, 357-363, 1989.
- Probst, J.L., and P. Amiotte-Suchet, Fluvial suspended sediment transport and mechanical erosion in the Maghreb (North Africa), *Hydrol. Sci. J.*, *37*, 621-637, 1992.
- Probst, J.L., J. Moratti, and Y. Tardy, Carbon river fluxes and weathering CO<sub>2</sub> consumption in the Congo and Amazon river basins, *Appl. Geochem.*, *9*, 1-13, 1994.
- Probst, J.L., P. Amiotte-Suchet, and W. Ludwig, Continental erosion and river transports of carbon to oceans, in: *Trends in Hydrology*, edited by S. G. Pandalai, Research Trends, Council of Sci. Info., Trivandrum, New Delhi, in press, 1995.
- Rasmussen, J.B., L. Godbout, and M. Schallenberg, The humic content of lake water and its relationship to watershed and lake morphology, *Limnol. Oceanogr.*, *34*, 1336-1343, 1989.
- Richey, J.E., J.I. Hedges, A.H. Devol, and P.D. Quay, Biogeochemistry of carbon in the Amazon River, *Limnol. Oceanogr.*, *35*, 352-371, 1990.
- Romankevitch, E.A., and V.E. Artyemyev, Input of organic carbon into seas and oceans bordering the territory of the Soviet Union, in *Transport of Carbon and Minerals in Major World Rivers, vol. 3*, *Mitt. Geol.-Paläont. Inst. Univ. Hamburg, SCOPE/UNEP Sonderbd. 58*, edited by E.T. Degens, S. Kempe, and R. Herrera, pp. 459-469, Universität Hamburg, Hamburg, 1985.
- Safiullah, S., M. Mofizuddin, S.M. Iqbal-Ali, and S. Enamul-Kabir, Biogeochemical cycles of carbon in the rivers of Bangladesh, in *Transport of Carbon and Minerals in Major World Rivers, vol. 4*, *Mitt. Geol.-Paläont. Inst. Univ. Hamburg, SCOPE/UNEP Sonderbd. 64*, edited by E.T. Degens, S. Kempe, and Gan Wei-Bin, pp. 435-442, Universität Hamburg, Hamburg, 1987.
- Sarmiento, J.L., and E.T. Sundquist, Revised budget for the oceanic uptake of anthropogenic carbon dioxide, *Nature*, *356*, 589-593, 1992.
- SAS Institute Inc. (Ed.), *SAS system for regression, 1986 edition*, 164 pp, SAS Institute Inc., Cary, N.C., 1986.
- Schlesinger, W.H., and J.M. Melack, Transport of organic carbon in the world's rivers, *Tellus*, *31*, 172-187, 1981.
- Smith, S.V., and G.T. Hollibough, Coastal metabolism and the oceanic organic carbon balance, *Rev. Geophys.*, *31*, 75-89, 1992.
- Spitzly, A., and J. Leenheer, Dissolved organic carbon in rivers, in *Biogeochemistry of Major World Rivers, SCOPE Rep. 42*, edited by E.T. Degens, S. Kempe, and J.E. Richey, pp. 213-232, John Wiley, New York, 1991.
- Staub, B., and C. Rosenzweig, Global Zoller soil type, soil texture, surface slope, and other properties, Digital raster on a 1 degree geographic (lat/long) 180x360 grid, in *Global Ecosystems Database, Version 1.0 Disc (CD-ROM)*, edited by NOAA National Geophysical Data Center, A. Boulder, Colo., 1992.
- Subramanian, V., and V. Ittekkot, Carbon transport by the Himalayan rivers, in *Biogeochemistry of Major World Rivers, SCOPE Rep. 42*, edited by E.T. Degens, S. Kempe, and J.E. Richey, pp. 157-168, John Wiley, New York, 1991.
- Summerfield, M.A., and N.J. Hulton, Natural controls of fluvial denudation rates in major world drainage basins, *J. Geophys. Res.*, *99*, (B7), 13 871-13 883, 1994.
- Tardy, Y., R. N'Koukou, and J.L. Probst, The global water cycle and continental erosion during phanerozoic time, *Am. J. Sci.*, *289*, 455-483, 1989.
- Telang, S.A., R. Pocklington, A.S. Nadu, E.A. Romanketitch, I.I. Gitelson, and M.I. Gladyshev, Carbon and mineral transport in major North American, Russian Arctic, and Siberian rivers: The St. Lawrence, the Mackenzie, the Yukon, the Arctic Alaskan rivers, the Arctic basin rivers in the Soviet Union, and the Yenisei, in *Biogeochemistry of Major World Rivers, SCOPE Rep. 42*, edited by E.T. Degens, S. Kempe, and J.E. Richey, pp. 75-104, John Wiley, New York, 1991.
- Thurman, E.M. (Ed.), *Organic Geochemistry of Natural Waters*, 497 pp., Martinus Nijhoff, Dordrecht, 1985.
- Wischmeier, W.H., D.D. Smith, and R.E. Uhland, Evaluation of factors in the soil loss equation, *Agric. Eng.*, *39*, 458-474, 1958.
- Zhang, S., Gan Wei-Bin, and V. Ittekkot, Organic matter in large turbid rivers: The Huanghe and its estuary, *Mar. Chem.*, *38*, 53-68, 1992.
- Zinke, P.J., A.G. Stangenberger, W.M. Post, W.R. Emanuel, and J.S. Olson, Worldwide organic soil carbon and nitrogen data, *Rep. ORNL/CDIC-18*, 136 pp., Oak Ridge Nat. Lab., Oak Ridge, Tenne., 1986.
- Zobler, L., A world soil file for global climate modeling, *NASA Technical Memorandum*, 87802, 1986.

S. Kempe, Geologisch-Paläontologisches Institut, Technische Hochschule Darmstadt, Schnittspahnstraße 9, D-64281 Darmstadt, Germany.

W. Ludwig and J.-L. Probst, Centre de Géochimie de la Surface, CNRS, 1, rue Blessig, 67084 Strasbourg, Cedex, France. (e-mail: wludwig@illite.u-strasbg.fr, jlprobst@illite.u-strasbg.fr)

(Received April 13, 1995; revised September 12, 1995; accepted September 20, 1995.)