



HAL
open science

Burling graphs revisited, part III: Applications to χ -boundedness

Pegah Pournajafi, Nicolas Trotignon

► **To cite this version:**

Pegah Pournajafi, Nicolas Trotignon. Burling graphs revisited, part III: Applications to χ -boundedness. *European Journal of Combinatorics*, 2024, 116, pp.103850. 10.1016/j.ejc.2023.103850. hal-04253858

HAL Id: hal-04253858

<https://hal.science/hal-04253858v1>

Submitted on 6 Dec 2024

HAL is a multi-disciplinary open access archive for the deposit and dissemination of scientific research documents, whether they are published or not. The documents may come from teaching and research institutions in France or abroad, or from public or private research centers.

L'archive ouverte pluridisciplinaire **HAL**, est destinée au dépôt et à la diffusion de documents scientifiques de niveau recherche, publiés ou non, émanant des établissements d'enseignement et de recherche français ou étrangers, des laboratoires publics ou privés.

Burling graphs revisited, part III: Applications to χ -boundedness

Pegah Pournajafi* and Nicolas Trotignon*

October 22, 2023

Abstract

The Burling sequence is a sequence of triangle-free graphs of unbounded chromatic number. The class of Burling graphs consists of all the induced subgraphs of the graphs of this sequence.

In the first and second parts of this work, we introduced derived graphs, a class of graphs, equal to the class of Burling graphs, and proved several geometric and structural results about them.

In this third part, we use those results to find some Burling and non-Burling graphs, and we see some applications of this in the theory of χ -boundedness. Specifically, we show that several graphs, like K_5 , some series-parallel graphs that we call necklaces, and some other graphs are not weakly pervasive.

1 Introduction

The chromatic number of a graph G , denoted by $\chi(G)$, is the smallest number k such that we can partition the vertex set of G into k stable sets. The clique number of G , denoted by $\omega(G)$, is the maximum number of mutually adjacent vertices in G . For every graph G , we have $\chi(G) \geq \omega(G)$, but the converse inequality is false in general. It was known even from the early days of graph theory that there are triangle-free graphs with arbitrarily large chromatic number. For instance, Tutte's construction (for the definition and more examples see Section 2 of [11]). The study of the

*Univ Lyon, EnsL, UCBL, CNRS, LIP, F-69342, LYON Cedex 07, France. Partially supported by the LABEX MILYON (ANR-10-LABX-0070) of Université de Lyon, within the program "Investissements d'Avenir" (ANR-11-IDEX-0007) operated by the French National Research Agency (ANR) and by Agence Nationale de la Recherche (France) under research grant ANR DIGRAPHS ANR-19-CE48-0013-01.

graphs satisfying several variants of the converse inequality was the object of many researches, and led to defining perfect graphs (see [13] for more details), and a generalization, χ -bounded classes (see [4]). A class \mathcal{C} of graphs is called χ -bounded with a *binding function* f if for every $G \in \mathcal{C}$, and for every induced subgraph H of G we have $\chi(H) \leq f(\omega(H))$. A function f is a χ -binding function for a class \mathcal{C} of graphs if for every $G \in \mathcal{C}$, and for every induced subgraph H of G , $\chi(H) \leq f(\omega(H))$. A class \mathcal{C} is called χ -bounded if there is a χ -binding function for it.

It is in particular interesting to study the χ -boundedness of specific classes of graphs. For a graph H , a graph not including H as an induced subgraph is called H -free, and one can ask whether the class of all H -free graphs is χ -bounded for a given graph H . Erdős showed in [3] that for any given integers g and k , there are graphs with girth larger than g and chromatic number larger than k . Therefore for any given H with cycles, we can find graphs of arbitrary large chromatic number and with girth larger than the size of the biggest cycle in H . Hence if the class of all H -free graphs is a χ -bounded class, then H must be a forest. Gyárfás [4], and Sumner [12] conjectured the inverse: they conjectured that the class of F -free graphs is χ -bounded for every forest F . It is possible to reduce this conjecture to the case that F is a tree (see Section 3 of [11]).

In [10], Scott proved a weakening of the Gyárfás-Sumner conjecture. A subdivision of a graph H is a graph obtained from H by replacing some of its edges by paths of length at least 1. (Hence, every graph is a subdivision of itself.) We denote by $\text{Forb}^*(H)$ the class of all graphs which do not contain any subdivisions of H as an induced subgraph. Scott proved that for every tree T , the class $\text{Forb}^*(T)$ is χ -bounded. (Theorem 1 of [10].) Notice that if H has cycles, then subdivisions of H can have arbitrary large cycles, and therefore the previous idea cannot be applied here. In fact, $\text{Forb}^*(H)$ might be χ -bounded even if H is not a tree. In [10], Scott conjectured (Conjecture 8) that $\text{Forb}^*(H)$ is χ -bounded for every graph H .

Pawlik, Kozik, Krawczyk, Lasoń, Micek, Trotter, and Walczak disproved Scott's conjecture in [7]. But even after that, it remained an interest to know for which graphs H , $\text{Forb}^*(H)$ is χ -bounded. A graph H is called *weakly pervasive* if $\text{Forb}^*(H)$ is χ -bounded. There still exists not even a good conjecture for the characterization of weakly pervasive graphs, and it is of interest to find examples of graphs that are or are not weakly pervasive.

One method for finding graphs that are not weakly pervasive, which is the core of all the researches so far in finding these graphs, is using some appropriate classes of graphs: suppose that you have a class \mathcal{C} of graphs which is not χ -bounded, and moreover does not contain any subdivision

of some given graph H . This shows that $\mathcal{C} \subseteq \text{Forb}^*(H)$ and thus H is not a weakly pervasive graph. The class of Burling graphs, introduced by Burling [1] in 1965, is not χ -bounded, and moreover, there are many graphs which are not in the class. So, the class of Burling graphs is a tool for finding graphs that are not weakly pervasive.

In [7], where Pawlik, Kozik, Krawczyk, Lasoń, Micek, Trotter, and Walczak disproved Scott's conjecture, they found Burling graphs as a subclass of *line segment graphs*, and then they showed that some graphs (e.g. 1-subdivision of any non-planar graph) are not line segment graphs. In [2] also, Chalopin, Esperet, Li, and Ossona de Mendez used the same technique, and proved that Burling graphs are a subclass of *restricted frame graphs* (as already suggested in [5]), and then found many graphs which are not restricted frame graphs and neither are their subdivisions. All these suggest that understanding Burling graphs is of great importance in the field of χ -boundedness.

In [8], the first part of this work, with the goal of understanding Burling graphs better, we defined many classes of graphs, all equal to Burling graphs. In particular, we defined the class of *derived* graphs, and we studied their structure in details in [9], the second part of this work. In the next section, we give a summary of some of the results of the previous parts that we are going to use in this article. Then, in the rest of the article, we use those results to find several examples of new graphs that are not weakly pervasive:

- K_5 and thus any K_n for $n \geq 5$, in Section 3,
- Specific necklaces in Section 4,
- Some examples of dumbbell graphs, which contain vertex cuts, in Section 5,
- Some graphs of different kinds in Section 6.

2 Summary of results from Parts I and II

In this section, we summarize the previous results on Burling graphs, mainly from [8] and [9], that we need for the next sections. We do not recall the most classical notation.

Derived graphs

A *Burling tree* is a 4-tuple (T, r, ℓ, c) in which:

- (i) T is a rooted tree and r is its root,

- (ii) ℓ is a function associating to each vertex v of T which is not a leaf, one child of v which is called the *last-born* of v ,
- (iii) c is a function defined on the vertices of T : if v is a non-last-born vertex of T other than the root, then c associates to v the vertex-set of a (possibly empty) branch in T starting at the last-born of the parent of v . If v is a last-born or the root of T , then we define $c(v) = \emptyset$. We call c the *choice function* of T .

By abuse of notation, we often use T to denote the 4-tuple.

The oriented graph G *fully derived* from the Burling tree T is the oriented graph whose vertex-set is $V(T)$ and $uv \in A(G)$ if and only if v is a vertex in $c(u)$. A non-oriented graph G is *fully derived* from T if it is the underlying graph of the oriented graph fully derived from T .

A graph (resp. oriented graph) G is *derived* from a Burling tree T if it is an induced subgraph of a graph (resp. oriented graph) fully derived from T . The oriented or non-oriented graph G is called a *derived graph* if there exists a Burling tree T such that G is derived from T . See Figure 5.

For more about the definition of derived graphs and their basic properties, see Section 3 of [8].

Because of the theorem below, we do not repeat the definition of Burling graphs here. For their definition see Definition 4.1 of [8]. We just remind that the class of Burling graphs have unbounded chromatic number. It is first proved by Burling in [1], but the proof can be find in many references, for example, see [7] or [8].

Theorem 2.1 ([8], Theorem 4.9). *The class of non-oriented derived graphs is the same as the class of Burling graphs.*

By Theorem 2.1, we may interchangeably use the words derived graph and Burling graph.

In this article, following the style of the first two parts of this work, for drawing the derived graph representation of graphs, we show the last-born of a vertex of the Burling tree as its right-most child. Also, we show the edges of the Burling tree with black and the arcs of the graph derived from it with red. Finally, we denote the vertices of the Burling tree which are in the graph derived from it with black, and the rest of its vertices (the *shadow vertices*) with white.

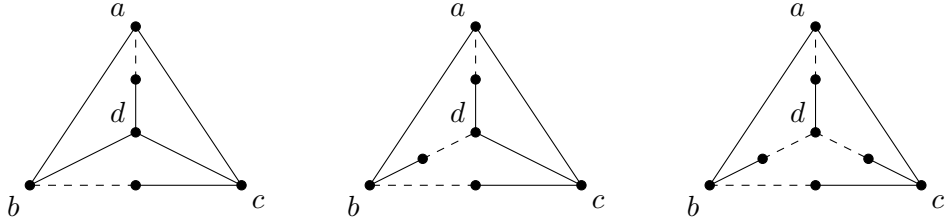

Figure 1: Subdivisions of K_4 , in order from left to right: type 2, type 3, and type 4. Only dashed edges can be subdivided.

Subdivisions of K_4 and wheels

The following lemma characterizes the subdivisions of K_4 which are Burling graphs.

Lemma 2.2 ([9], Theorem 7.3). *Let G be a non-oriented graph obtained from K_4 by subdividing edges. Then G is a Burling graph if and only if G contains four vertices $a, b, c,$ and d of degree 3 such that $ab, ac \in E(G)$ and $ad, bc \notin E(G)$.*

Let G be a subdivision of K_4 , which is a Burling graph. We say that G is of type i , for $i = 2, 3, 4$, if exactly i edges of the K_4 are properly subdivided to obtain G . Notice that by Lemma 2.2, up to symmetry, there is only one possibility for the choice of the edges to subdivide for each type. See Figure 1.

A *wheel* consists of a hole C and a vertex v which has at least 3 neighbors in C . As explained in [9] (Theorem 7.2), wheels are not Burling graphs.

Star cutsets

A *full in-star cutset* in an oriented graph G is a set $S = N^-[v]$ for some vertex $v \in V(G)$ such that $G \setminus S$ is disconnected. In such case, we say that the star cutset is *centered* at v .

An *in-tree* is any oriented graph obtained from a rooted tree (T, r) by orienting every edge towards the root. Formally, $e = uv$ is oriented from u to v if and only if v is on the unique path of T from u to r . Notice that in an in-tree, every vertex but the unique sink, has a unique out-neighbor. An *in-forest* is an oriented forest whose connected components are in-trees. A *leaf* in an in-tree is a source with exactly one out-neighbor (so, by definition, the root is not a leaf, even if it has degree 1).

An *oriented chandelier* is any oriented graph G obtained from an in-tree G' with at least 2 leaves by adding a vertex v and all arcs uv where u is a leaf of G' . Observe that v is a sink and all its neighbors are sources of degree 2. We call here *non-oriented chandelier* the underlying graph of an oriented chandelier. Note that in [2], *chandelier* has a slightly different meaning.

Theorem 2.3 ([9], Theorem 5.5). *If G is an oriented Burling graph, then G has a full in-star cutset, or G is an oriented chandelier or G contains a vertex of degree at most 1.*

Observe that in any chandelier (oriented or not), there exist a vertex (v in the definition above) which is contained in every cycle of the graph. The following is observed in [9], as a direct consequence of the definition of *k-sequential graphs*. See Section 4 of [9]. In fact, chandeliers are 2-sequential graphs, a subclass of Burling graphs.

Lemma 2.4. *Every (non-oriented) chandelier is a Burling graphs.*

Holes

A *hole* in a graph G is a chordless cycle of length at least 4. A hole of an oriented graph is any hole of its underlying graph. In oriented derived graphs, not only the orientations of holes are specific, but also they interact in a constrained way. As explained in [9] section 6, every hole H in a graph derived from a Burling tree T has four *special* vertices that we here describe:

- two sources called the *antennas*,
- one common neighbor of the antennas that is also an ancestor in T of all the vertices but the antennas, called the *pivot*,
- one sink distinct from the pivot, called the *bottom*.

Each of the other vertices lie one of the directed paths of H from an antenna to the bottom. A *subordinate* vertex of a hole is any vertex distinct from its pivot and antennas (in particular, the bottom is subordinate and is therefore a descendant of the pivot). An *extremum* of a hole is any sink or source of it, and a *transitive vertex* of a hole is any vertex of it with one in-neighbor and one out-neighbor. So every vertex of a hole is either a transitive vertex or an extremum. We often refer to the following sum up.

Lemma 2.5. *Every hole in an oriented derived graph has exactly two sinks and two sources, and the two sources have a common neighbor (which is one of the sinks).*

Now we can summarize some theorems about the interaction of holes in oriented derived graphs. In what follows, by connecting two vertices by a path of length 0, we mean identifying the two vertices.

A *dumbbell* is a graph made of path $P = x \dots x'$ (possibly $x = x'$), a hole H that goes through x and a hole H' that goes through x' . Moreover $V(H) \cap V(P) = \{x\}$, $V(H) \cap V(P') = \{x'\}$, $V(H) \cap V(H') = \{x\} \cap \{x'\}$, and there are no edges other than the edges of the path and the edges of the holes. Intuitively, a dumbbell consists of two holes H and H' where one specific vertex of H is connected by a path P of length at least 0 to one specific vertex of H' .

Lemma 2.6 ([9], Lemma 6.2). *Suppose a dumbbell with holes H , H' and path $P = x \dots x'$ as in the definition is the underlying graph of some oriented derived graph G . Then in G , either x is not a subordinate vertex of H , or x' is not a subordinate vertex of H' .*

A *domino* is a graph made of one edge xy and two holes H_1 and H_2 that both go through xy . Moreover $V(H_1) \cap V(H_2) = \{x, y\}$ and there are no other edges than the edges of the holes. Intuitively, a domino consists of two holes H_1 and H_2 which have a common edge xy .

Lemma 2.7 ([9], Lemma 6.3). *Suppose a domino with holes H_1 , H_2 and edge xy as in the definition is the underlying graph of some oriented derived graph G . Then for some $z \in \{x, y\}$ and some $i \in \{1, 2\}$, z is the pivot of H_i and z is a subordinate vertex of H_{3-i} .*

A *theta* is a graph made of three internally vertex-disjoint paths of length at least 2, each linking two vertices u and v called the *apexes* of the theta (and such that there are no other edges than those of the paths). A *long theta* is a theta such that all the paths between the two apexes of the theta have length at least 3.

Lemma 2.8 ([9], Lemma 6.4). *If G is a derived graph whose underlying graph is a long theta with apexes u and v , then exactly one of u and v is the pivot of every hole of G .*

Subdivision and contraction of edges of derived graphs

Let G be an oriented graph derived from a Burling tree T . An arc uv of G is a *top arc with respect to T* if v is the out-neighbor of u that is closest (in T) to the root of T . An arc uv of G is a *bottom arc with respect to T* if v is the out-neighbor of u that is furthest (in T) from the root of T .

Lemma 2.9 ([9], Lemma 3.8). *Let G be an oriented graph derived from a Burling tree T . Any graph obtained from G after performing the following operations, any number of times and in any order, is an oriented derived graph:*

- (i) *Replacing some bottom arcs uv by a path of length at least 1, directed from u to v .*
- (ii) *Replacing some top arcs uv such that u is a source of G by an arc wv and a path of length of length at least 1 from w to u .*

The two operations in Lemma 2.9 are respectively called *subdivision* of arc uv , and *top-subdivision* of arc uv .

Contraction of an edge uv of a (non-oriented) graph G is to remove the edge uv and identify the two vertices u and v . Contraction of an arc in an oriented graph is the contraction of the same edge in the underlying graph.

Lemma 2.10 ([9], Lemma 3.9). *Let G be an oriented derived graph, and let uv be an arc such that u is the only in-neighbor of v and v is the only out-neighbor of u , i.e. $N^+(u) = \{v\}$ and $N^-(v) = \{u\}$. Then the graph G' obtained by contracting uv is also a derived graph and the top-arcs (resp. bottom-arcs) of G but uv are the top-arcs (resp. bottom-arcs) of G' .*

Finding graphs that are not weakly pervasive

The following lemma enables us to use Burling graphs to find new graphs that are not weakly pervasive.

Lemma 2.11. *Let H be a graph. If no subdivision of H is a Burling graph, then H is not a weakly pervasive graph.*

Proof. The class of Burling graphs is contained in $\text{Forb}^*(H)$. Thus, $\text{Forb}^*(H)$ is not χ -bounded. Hence, H is not weakly pervasive. \square

3 Complete graphs

The graph K_3 is a weakly pervasive graph, since $\text{Forb}^*(K_3)$ is the class of all forests. In [6], Lévêque, Maffray, and Trotignon proved that K_4 is also a weakly pervasive graph. In this section, we prove that K_5 is not a weakly pervasive graph, and thus is not any K_n for $n \geq 5$.

Lemma 3.1. *Let G be a triangle-free subdivision of K_5 . If all the subdivisions of K_4 in it are of types 2, 3, and 4, then G has one of the following forms:*



Figure 2: Subdivisions of K_5 , type A subdivision on the left and type B subdivision on the right. Only dashed edges can be subdivided.

- (i) *type A: edges of a 4-cycle in G are not subdivided at all, and any other edge is subdivided at least once.*
- (ii) *type B: edges of a 5-cycle in G are not subdivided at all, and any other edge is subdivided at least once.*

See Figure 2.

Proof. Let $M = \{a, b, c, d, e\}$ be the set of vertices of G of degree 4. For $x \in M$, we denote by H_x the subdivision of K_4 containing $M \setminus \{x\}$ in G . By Lemma 2.2, for all $x \in M$, H_x is a type 2, 3, or 4 subdivision of K_4 . In particular, consider H_e . There are three cases:

Case 1. H_e is of type 2. Without loss of generality, let ac and bd be the subdivided edges of H_e . Let $v \in \{a, b, c, d\}$. If $ev \in E(G)$, then v is the center of a wheel in G , a contradiction. Thus, ev is subdivided, and G is a type A subdivision of K_5 .

Case 2. H_e is of type 3. Without loss of generality, let ab , ac , and bd be the subdivided edges of H_e . So, $ad, cd, bc \in E(G)$. If ce is not subdivided in G , then H_a is a wheel centered at c , a contradiction. Thus, ce is subdivided in G . Similarly, one can prove that de must be subdivided. Now, because H_d must be of type 2, 3, or 4, $be \in E(G)$. Then, because H_c must be of type 2, 3, or 4, $ae \in E(G)$. So, G is a type B subdivision of K_5 .

Case 3. H_e is of type 4. Without loss of generality, let ab , ac , ad , and bd be the subdivided edges of H_e . First of all, ce must be subdivided, otherwise H_a will be a wheel centered at c . Secondly, because H_b should be of type 2, 3, or 4, we must have $de \in E(G)$. In the same way, because H_d should be of type 2, 3, or 4, we must have $be \in E(G)$. Finally, ae must be subdivided, otherwise H_c will be a wheel centered at e . So, in this case, G is a type A subdivision of K_5 . \square

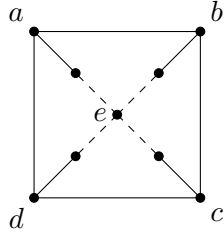

Figure 3: A subgraph of a type A subdivision of K_5 .

Lemma 3.2. *If G is a type A subdivision of K_5 , then it is not a derived graph.*

Proof. Let $\{a, b, c, d, e\}$ be the set of vertices of degree 4 in G . Without loss of generality, assume that $ab, bc, cd, da \in E(G)$. The graph H shown in Figure 3 is an induced subgraph of G .

Notice that H has no start cutset, it has no vertex of degree 1, and it is not a chandelier (because in H , for every vertex there is a cycle not containing it). Hence, by Theorem 2.3, H is not a derived graph, and thus, G is not a derived graph neither. \square

Lemma 3.3. *If G is a type B subdivision of K_5 , then it is not a derived graph.*

Proof. Let $M = \{a, b, c, d, e\}$ be the set of degree 4 vertices of G . Without loss of generality, we may assume that $ab, bc, cd, de, ea \in E(G)$. For $u, v \in M$, $u \neq v$, let P_{uv} denote the degree 2 vertices of the path replacing the edge uv when subdividing it. In particular $u, v \notin P_{uv}$. For simplicity in writing, we denote a hole of G by only naming the vertices of M in that hole, if there is no confusion.

For the sake of contradiction, suppose that G is a derived graph. So there is an orientation of G such that G is an oriented derived graph. From now on, consider G with this orientation. We denote the arcs of G in this orientation by $A(G)$.

Consider the hole $abcdea$ in G . Without loss of generality, by Lemma 2.5, we may assume that a and c are its sources, and b and e are its sinks.

Now, consider the hole $ecde$. Vertex d is neither a sink nor a source for this hole, and c also cannot be a sink of it because $cd \in A(G)$. Therefore, the two sinks of $ecde$ are among $P_{ce} \cup \{e\}$. Call them t_1 and t_2 , and without loss of generality assume $t_1 \in P_{ce}$.

Then, consider the hole $abca$. For this hole, a and c cannot be sinks because $ab, cd \in A(G)$, and b is a sink. So, there is exactly one sink in P_{ac} ,

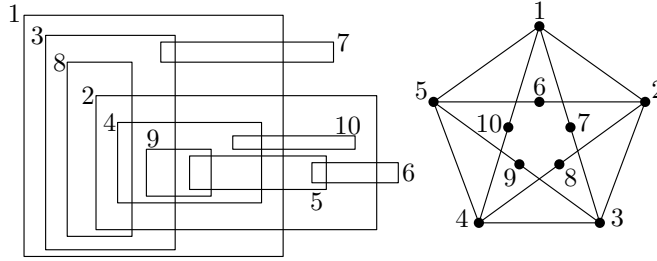

Figure 4: A type B subdivision of K_5 and its representation as a restricted frame graph.

call it t_3 .

Finally, consider the hole $acea$. Notice that t_1 and t_3 are the two sinks of $acea$. If $t_2 \in P_{ce}$ then it will be a third sink for $acea$, a contradiction. If $t_2 = e$, let $f \in P_{ce}$ be the neighbor of e on the subdivided edge between c and e . Then $fe \in A(G)$, and since we also have $ae \in A(G)$, then again e will be a third sink for $acea$, a contradiction. So G is not a Burling graph. \square

Remark 3.4. Lemma 3.2 follows also from Theorem 3.3 of [2]. In fact, by the mentioned theorem, one can see that a type A subdivision of K_5 is not even a restricted frame graphs, and because Burling graphs are restricted frame graphs, it is not a Burling graphs (or equivalently derived graph) neither.

A type B subdivision of K_5 on the other hand, can be represented as a restricted frame graph. See Figure 4.

For the definition of restricted frame graphs, see Definition 2.2 in [2], or see Section 6 of [8].

Theorem 3.5. The class of derived graphs includes no subdivision of K_5 .

Proof. Let G be a subdivision of K_5 . If it has a triangle, then it is not a derived graph. So, we may assume that G is triangle-free. If G includes a subdivision of K_4 as an induced subgraph, this subdivision of K_4 must be of type 2, 3, or 4, otherwise, by Lemma 2.2, G cannot be a derived graph. Thus, by Lemma 3.1, G is either a type A or a type B subdivision of K_5 . So, the result follows from Lemmas 3.2 and 3.3. \square

Corollary 3.6. If G is a complete graph on n vertices, where $n \geq 5$, then it is not a weakly pervasive graph.

Proof. For $n = 5$, the result follows from Theorem 3.5, using Theorem 2.11. For $n \geq 5$ it is enough to notice that G includes a subdivision of K_5 as an induced subgraph. \square

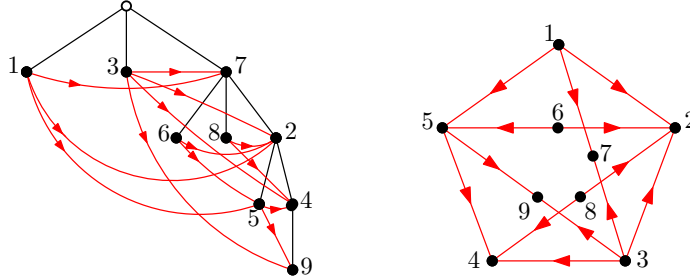

Figure 5: A type B subdivision of K_5 minus one vertex, shown as a derived graph

Remark 3.7. Let G be the graph shown in Figure 4. This graph is minimally non-Burling: if one removes one vertex of it, it becomes a Burling graph. By deleting a vertex of degree 4 (e.g. vertex 1), one obtains a type 3 subdivision of K_4 which is a Burling graph, and by deleting a vertex of degree 2 (e.g. vertex 10) one obtains a graph isomorphic to the underlying graphs of the derived graph represented in Figure 5.

4 Necklace graphs

We remind that connecting two vertices by a path of length 0 means identifying the two vertices.

Let B_1, B_2, \dots, B_m , ($m \geq 2$), be cycles of length at least 4. For $1 \leq i \leq m$, let a_i and b_i be two non-adjacent vertices of B_i . For $1 \leq i \leq m$, connect b_i and a_{i+1} by a path of length at least 0 (where $a_{m+1} = a_1$). The resulting graph G is called an m -necklace. A necklace graph is a graph which is an m -necklace for some $m \geq 2$. Each B_i is called a *bead* of G . We say that B_i is a *short* bead, if a_i and b_i have a common neighbor. Notice that necklaces are triangle-free graphs. See Figure 6.

In this section, we characterize the necklaces which are Burling graph. Table 1 shows a summary of the results of this section.

Lemma 4.1. *A necklace graph G has a star cutset if and only if it has a short bead.*

Proof. If G has a short bead B_i , the common neighbor of a_i and b_i is the center of a star cutset. On the other hand, if G has no short bead, then it is easy to see that it does not have a star cutset. \square

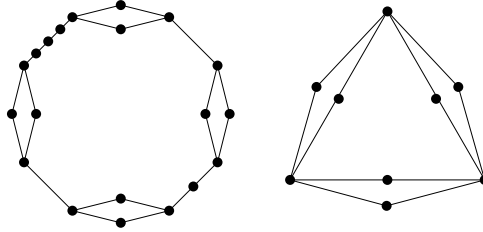

Figure 6: A 4-necklace (left) and a 3-necklace (right). Any edge of the two graphs can be subdivided.

	without star cutset	with star cutset
$m = 2$	Burling graph \Leftrightarrow the two beads have a common vertex (Lemma 4.2)	always Burling graph (Lemma 4.2)
$m = 3$	never Burling graph (Lemma 4.3)	Burling graph \Leftrightarrow there exists a short bead such that the two other beads have a common vertex (Lemma 4.3)
$m \geq 4$	never Burling graph (Lemma 4.4)	

Table 1: m -Necklaces and the class of Burling graphs

Lemma 4.2. *A 2-necklace graph G is a derived graph if and only if it has a star cutset or its two beads have a common vertex.*

Proof. First, suppose that G is a derived graph. If it has a star cutset, we are done. Otherwise, because it has no vertex of degree 1, by Theorem 2.3, it should be a chandelier. In particular, there exists a vertex v in G which is contained in all cycles of G . So, the two beads of G both contain v .

Conversely, if the beads of G have a common vertex, then G is a chandelier (with the pivot being a common vertex of the two beads). So, it is a Burling graph by Lemma 2.4. If the beads of G do not have a common vertex, then G has a star cutset, and thus by Lemma 4.1, it has a short bead. Therefore, G can be obtained from the underlying graph of the graph shown in Figure 7 (right) by subdividing some (possibly none) of the dashed arcs. In Figure 7, a presentation of the graph on the right as a derived graph is shown. Notice that all the dashed arcs are either a top-arc starting in a source of G or a bottom-arc of G , so by Lemma 2.9, we may subdivide them. So, every 2-necklace with a short bead is a derived graph. \square

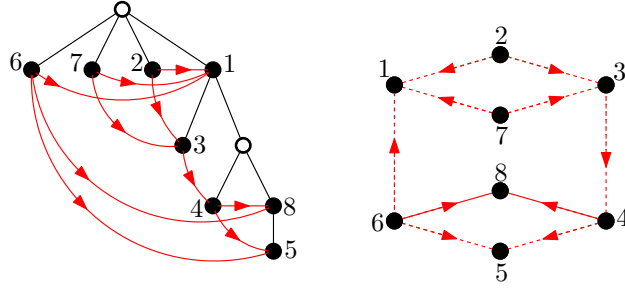

Figure 7: A 2-necklace presented as a derived graph

Lemma 4.3. *Let G be a 3-necklace. The graph G is a derived graph if and only if it has at least one short bead B and the two other beads have a vertex in common.*

In particular, if G has no star cutset, then it is not a derived graph.

Proof. First assume that G is a derived graph and let B_i , $1 \leq i \leq 3$ be its beads. There is an orientation of G such that G with this orientation is an oriented derived graph. For each bead B_i , let P_i and Q_i denote the internal vertices of the two paths between a_i and b_i in B_i . We call a vertex of a hole an *extremum* if it is a sink or source in that hole. Notice that each B_i is a hole in G , so by Lemma 2.5 it should have four extrema, and thus there is at least one of P_i and Q_i , say P_i , which contains at least one extremum of B_i . Denote this extremum by x_i . Let C be the cycle in G obtained by removing the vertices of Q_1 , Q_2 , and Q_3 . Notice that C is a hole in G , and that x_1 , x_2 , and x_3 are extrema for it. Let x_4 be the fourth extremum of C . Notice that three of the extrema of C should be consecutive vertices, and that no two vertices among x_1 , x_2 , and x_3 are neighbors. So, x_4 should be the common neighbor of two of x_1 , x_2 , and x_3 , and x_4 cannot be inside Q_i 's or P_i 's. We assume without loss of generality that x_4 is a common neighbor of x_1 and x_2 . So, B_1 and B_2 have a common vertex which is $a_2 = b_1$. Thus, x_4 is the common vertex of B_1 and B_2 . This implies that x_1 and x_2 are the antennas of the hole C . So, C cannot have another antenna. In particular, P_3 contains no source. Also, Q_3 contains no source, because we can repeat the same argument by exchanging the role of P_3 and Q_3 . Thus, the antennas of B_3 should be a_3 and b_3 . Hence, they should have a common neighbor, and therefore B_3 is a short bead.

Now, suppose that G has two beads B_1 and B_2 with a common vertex, and a short bead B_3 . In such case an orientation of G can be obtained

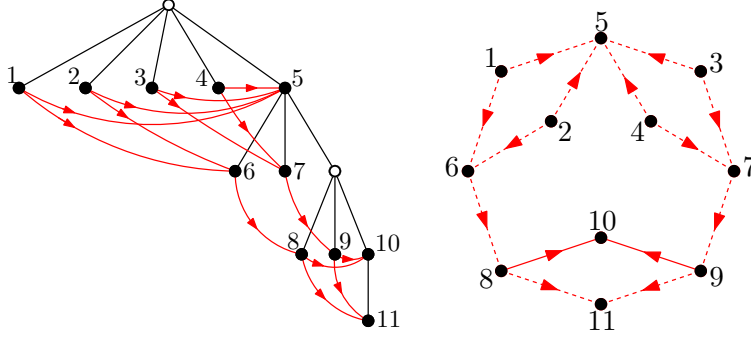

Figure 8: A 3-necklace presented as a derived graph

from the graph in Figure 8 by first possibly contracting arc 6-8 or both arcs 6-8 and 7-9, and then subdividing some of the dashed arcs (including 6-8 and 7-9, if they are not contracted). By Lemma 2.10, we can contract one or both arcs 6-8 and 7-9, preserving the top-arcs and bottom-arcs. Then, all the dashed edges (including 6-8 and 7-9, if they are not contracted) are top-arcs starting at a source of the graph or bottom-arcs of the graph. So, we can subdivide them as many times as needed. So G is a derived graph.

Finally, notice that if G has no star cutset, then by Lemma 4.1 it cannot have a short bead, so it is not a derived graph. \square

Lemma 4.4. *Let G be an m -necklace graph. If $m \geq 4$, then G is not a derived graph.*

Proof. Assume for the sake of contradiction that G is a derived graph. So, it is the underlying graph of an oriented derived graph. Consider this orientation on G . Let B_1, B_2, \dots, B_m be the beads of G . Let P_i and Q_i be the internal vertices of the two paths between a_i and b_i on the bead B_i , $1 \leq i \leq m$. Each B_i is a hole in G and thus by Lemma 2.5, it has four extrema. In particular, at least one of P_i and Q_i , say P_i , has at least one extremum. Let C be the cycle in G obtained by removing the vertices of $Q_i, 1 \leq i \leq m$, and notice that C is a hole in G . An extremum in P_i for B_i is also an extremum for C . But C should have exactly four extrema, so $m \leq 4$, and hence $m = 4$, and each P_i has exactly one extremum, and the extrema on P_i 's are exactly the extrema of C . Now, notice that three of the extrema of C should be consecutive vertices, which is not possible because no vertex of P_i is a neighbor of a vertex of P_j if $i \neq j$. This is a contradiction. So, G

is not a Burling graph. \square

We can summarize all the lemmas above in the following theorem.

Theorem 4.5. *Let G be an m -necklace.*

- (i) *If $m = 2$, then G is a Burling graph if and only if either it has a star cutset or the two beads of G have a common neighbor.*
- (ii) *If $m = 3$, then G is a Burling graph if and only if there exists a short bead such that the two other beads have a common vertex.*
- (iii) *If $m \geq 4$, then G is not a Burling graph.*

See Table 1.

Proof. Follows directly from Lemmas 4.2, 4.2, 4.3, and 4.4, and the fact that Burling graphs are equal to derived graphs (Theorem 2.1). \square

Corollary 4.6. *Let G be an m -necklace graph. If any of the followings happens, then G is not a weakly pervasive graph:*

- (i) *$m = 2$, G has no star cutset, and the beads do not share a vertex,*
- (ii) *$m = 3$ and G has no star cutset,*
- (iii) *$m = 3$ and for every short bead B of G , the two other beads have no common vertex.*
- (iv) *$m \geq 4$.*

Proof. Let G be in one of the above four forms. Notice that a subdivision of G will also be in one of the above forms. So, by Theorem 4.5, neither G nor any of its subdivisions are Burling graph. Notice that we have used the fact that having a short bead and having a star cutset are equivalent in necklaces (Lemma 4.1). So, G is not a weakly pervasive graph. \square

Remark 4.7. *Let G be a necklace. If G does not have a star cutset, then G is not even a restricted frame graph. This follows from Theorem 3.3 of [2]. But if G has a star cutset, then it might be a restricted frame graph. See Figure 9 for an example of a non-Burling necklace which is a restricted frame graph.*

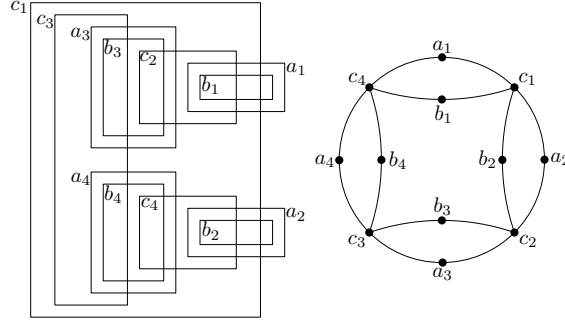

Figure 9: A 4-necklace, presented as a frame graph

5 Dumbbells

Let G be a non-oriented derived graph. We call a vertex v a *global subordinate* vertex of G if for any oriented derived graph \tilde{G} for which G is the underlying graph, v is a subordinate vertex of some hole in \tilde{G} .

Given two graphs G_1 and G_2 and two vertices $x_1 \in V(G_1)$ and $x_2 \in V(G_2)$, one can build a graph D as follows: first take the disjoint union of G_1 and G_2 and then connect x_1 and x_2 by a path of length at least 0, to obtain D . Any graph D built as above is called a *dumbbell* of G_1 and G_2 with respect to x_1 and x_2 . See Figure 11 for some examples.

Lemma 5.1. *Let G_1 and G_2 be two derived graphs, and let $x_1 \in V(G_1)$ and $x_2 \in V(G_2)$. If x_i is a global subordinate vertex of G_i , for $i = 1, 2$, then any dumbbell D of G_1 and G_2 with respect to x_1 and x_2 is not a derived graph.*

Proof. Assume that D is a derived graph. By definition of global subordinate vertex, for $i = 1, 2$, there is a hole H_i in G_i for which x_i is a subordinate vertex. So, the dumbbell built by holes H_1 and H_2 and the path between x_1 and x_2 is an induced subgraph of D , and thus is a derived graph, a contradiction with Lemma 2.6. \square

Remark 5.2. *Notice that if one of G_1 or G_2 is not a derived graph, then the dumbbell of G_1 and G_2 with respect to any two vertices is not a derived graph, because Burling graphs are closed under taking induced subgraphs.*

In this section, Lemma 5.1 is essentially what enables us to find a new family of graphs that are not weakly pervasive, all of which have vertex cuts.

Lemma 5.3. *Let G be an oriented derived graph whose underlying graph is a type 4 subdivision of K_4 . If x is the common end-point of the two*

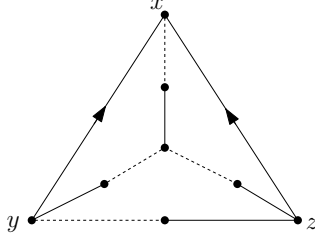

Figure 10: The vertex x is the unique center of an in-star cutset in G .

non-subdivided arcs, then x is the unique center of an in-star cutset in G . In particular, the two non-subdivided arcs are oriented toward x . See Figure 10.

Proof. First, G has an in-star cutset due to Theorem 2.3 because it is not a chandelier and has no vertex of degree 1.

Moreover, if a vertex v is the center of an in-star cutset in G , then v is the center of a star cutset in the underlying graph of G . Since any vertex other than x cannot be the center of a star cutset in the underlying graph of G , x is the unique center of an in-star cutset in G . \square

Lemma 5.4. *Let G be a type 4 subdivision of K_4 . Let x be the common end-point of the two non-subdivided edges of G , and let y and z be its degree 3 neighbors. For any subdivision G^* of G which is a derived graph, $yx, zx \in E(G^*)$, and for any $w \in \{y, z\}$, x is the pivot of exactly one of the two holes going through xw , and is a subordinate vertex of the other. In particular, x is a global subordinate vertex of G^* .*

Proof. If either of xy or xz are not edges of G^* , then by Lemma 2.2, G^* is not a derived graph and there is nothing to prove. So, suppose that $yx, zx \in E(G^*)$, and hence G^* is a derived graph, meaning that it is the underlying graph of an oriented derived graph. Consider this orientation on G^* . By Lemma 5.3, x is the only center of an in-star cutset in G^* . So, x is not the antenna of any hole in G^* . Consider the two holes passing through the arc xw in G^* and call them H_1 and H_2 . They form a domino, so by Lemma 2.7, for some $u \in \{x, w\}$ and for some $i \in \{1, 2\}$, u is the pivot of H_i and u is a subordinate vertex of H_{3-i} . Because the arc wx is oriented from w to x , then w cannot be the pivot of any of the two holes. Thus in G^* , the vertex x is the pivot of one of the two holes, and the subordinate vertex of another. \square

Lemma 5.5. *Let G be a long theta with apexes u and v . If x is a vertex of degree 2 in G such that its two neighbors are also of degree 2, then x is a global subordinate vertex in any subdivision of G .*

Proof. By Lemma 2.8, for any derived graph \tilde{G} for which G is an underlying graph, there is $w \in \{u, v\}$ such that w is the pivot of all holes of \tilde{G} , and thus the antennas of all holes are among the neighbors of w . By assumptions, $x \neq w$ and is not one of its neighbors. Thus, x is a global subordinate vertex of G . \square

Theorem 5.6. *Let G_1 be a type 4 subdivision of K_4 , and let x_1 be the common end-point of its two non-subdivided edges. Let G_2 be a long theta, and let x_2 be a vertex of degree 2 in G_2 whose neighbors are also of degree 2. Choose i and j in $\{1, 2\}$ (i and j can be possibly equal). If D is a dumbbell of G_i and G_j with respect to x_i and x_j , then no subdivision of D is a Burling graph. In particular, D is not weakly pervasive. See Figure 11.*

Proof. If a subdivision of G_i is not a Burling graph, then neither is the dumbbell containing it. Otherwise, the result follows from Lemma 5.4 and Lemma 5.5 by applying Lemma 5.1.

The second part follows from Lemma 2.11. \square

Remark 5.7. *Notice that the technique used in this section can help us to obtain more graphs that are not weakly pervasive. In particular, any graph having an induced subgraph isomorphic to D as described in Theorem 5.6, is not weakly pervasive. Thus the graph in Figure 12, in which G is any arbitrary connected graph, has D as an induced subgraph, and is not weakly pervasive.*

6 Miscellaneous

First example

Theorem 6.1. *Let G be the graph shown in Figure 13. No subdivision of G is a derived graph. In particular, G is not weakly pervasive.*

Proof. Let G^* be a subdivision of G . The graph G^* contains two subdivisions of K_4 as induced subgraphs: one whose degree 4 vertices are exactly $\{u, x, y, z\}$ and does not contain v and w , which we denote by H_l , and the other whose degree 4 vertices are exactly $\{v, x, y, w\}$ and does not contain u and z , which we denote by H_r .

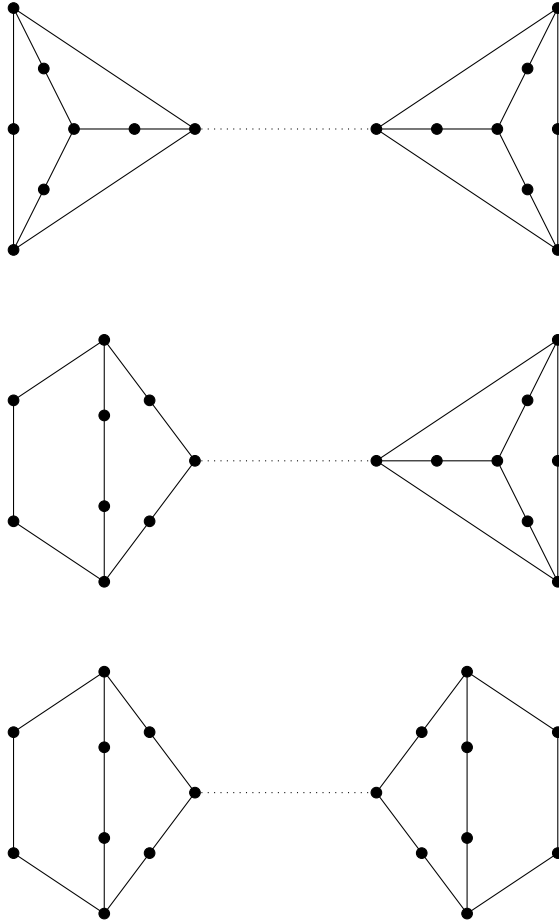

Figure 11: Some graphs that are not weakly pervasive. One can subdivide any edge, or contract the dotted edges, and still have a graph that is not weakly pervasive.

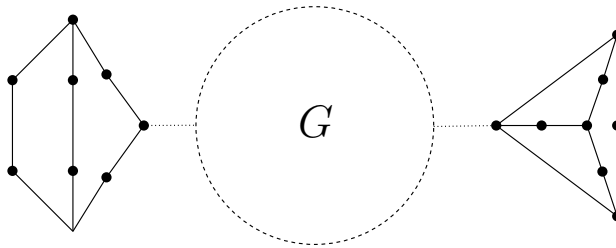

Figure 12: More graph that are not weakly pervasive graphs based on dumbbells. Here, G is any arbitrary connected graph.

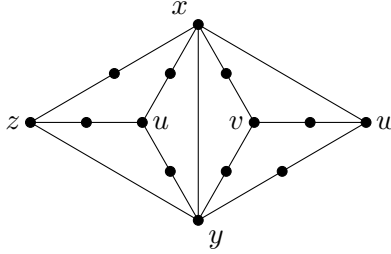

Figure 13: A graph that is not weakly pervasive. Theorem 6.1.

If in constructing G^* , any of the edges xy , zy , or xw is subdivided, then G^* contains a subdivision of K_4 which, by Lemma 2.2, is not a Burling graph, so G^* is not a Burling graph. Hence, we may assume that $xy, zy, xw \in E(G^*)$.

For the sake of contradiction, assume that G^* is a derived graph, and consider its orientation as an oriented derived graph. Notice that H_l and H_r are also derived graph. But neither of H_r and H_l are chandeliers, so by Theorem 2.3, each of them should have an in-star cutset. Now by Lemma 5.3, the center of the in-star cutset of H_l can only be y , so the edge xy should be oriented from x to y in G^* . On the other hand, again by Lemma 5.3, the center of the in-star cutset of H_r can only be x , so the edge xy should be oriented from y to x in G^* . This contradiction shows that G^* is not a Burling graph.

The second part of the theorem follows directly from Lemma 2.11. \square

Remark 6.2. *Theorem 6.1 provides an example for the fact that the class of Burling graphs is not closed under gluing along one edge. The graph in Figure 13 is not a derived graph and is obtained by gluing H_r and H_l (in the proof of Theorem 6.1) along one edge, and both of H_r and H_l are derived graphs, as shown in Figure 8 of [9].*

Second example

Theorem 6.3. *Let G be the graph shown in Figure 14. No subdivision of G is a derived graph. In particular, G is not weakly pervasive.*

Proof. Let G^* be a subdivision of G . If any of the edges x_1y_1 , x_1z , x_2y_2 , and x_2z are subdivided in G^* , then by Lemma 2.2, it contains a non-Burling subdivision of K_4 and thus is not a derived graph. So, we may assume that all those 4 edges are edges of G^* , in which case, if $x_1x_2 \in E(G^*)$, then G^*

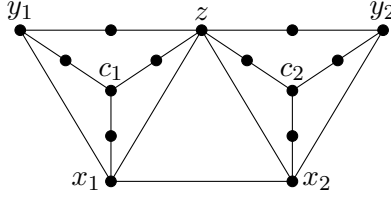

Figure 14: A graph that is not weakly pervasive. Theorem 6.3.

has a triangle and thus is not a Burling graph. So, we may also assume that x_1x_2 is subdivided in G^* .

For the sake of contradiction, consider any orientation on G^* which makes it an oriented derived graph, and let $A(G^*)$ be the set of the arcs of G^* . Let $i \in \{1, 2\}$. By Lemma 5.4, $y_ix_i, zx_i \in A(G^*)$. Also, by Lemma 5.4, x_i is the pivot of exactly one of the following two holes containing the edge zx_i : the hole containing the paths obtained by subdividing x_ic_i and c_iz , and the hole containing x_iy_i and the path obtained by subdividing the y_iz . Denote this hole by H_i . Now consider the hole H formed by zx_1, zx_2 , and the path obtained by the subdivision of the edge x_1x_2 . The two holes H and H_i form a domino. Therefore, by Lemma 2.7, for some $u \in \{x_i, z\}$, u is a subordinate vertex of one of the holes and the pivot of the other. Notice that u cannot be z because $zx_i \in A(G^*)$. Thus $u = x_i$, and as x_i is the pivot of H_i , it is a subordinate vertex of H .

Therefore, in H , the vertex z is a source and both its neighbors, namely x_1 and x_2 , are subordinate vertices of H . This contradicts Lemma 2.5. Thus, G^* is not a derived graph.

The second part of the theorem follows directly from Lemma 2.11. \square

Third example

Theorem 6.4. *Let G be the graph shown in Figure 15. No subdivision of G is a derived graph. In particular, G is not weakly pervasive.*

Proof. Let G^* be a subdivision of G . If any of the edges x_1y_1, x_1z_1, x_2y_2 , and x_2z_2 are subdivided in G^* , then by Lemma 2.2, it contains a non-Burling subdivision of K_4 and thus is not a derived graph. So, we may assume that all those 4 edges are edges of G^* .

For the sake of contradiction, consider any orientation on G^* which makes it an oriented derived graph, and let $A(G^*)$ be the set of the arcs

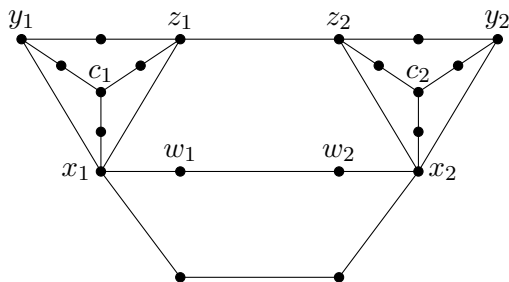

Figure 15: A graph that is not weakly pervasive. Theorem 6.4.

of G^* . Let $i \in \{1, 2\}$. By Lemma 5.4, $y_i x_i, z_i x_i \in A(G^*)$. Again By Lemma 5.4, x_i is the pivot of exactly one of the following two holes containing the edge $z_i x_i$: the hole containing the paths obtained by subdividing $x_i c_i$ and $c_i z_i$, and the hole containing $x_i y_i$ and the path obtained by subdividing the $y_i z_i$. Denote this hole by H_i . Now consider the hole H passing through $z_1 x_1, z_2 x_2$, the path obtained by the subdivision of the edge $z_1 z_2$, and the path $x_1 w_1 \dots w_2 x_2$. The two holes H and H_i form a domino. Therefore, by Lemma 2.7, for some $u \in \{x_i, z_i\}$, u is the subordinate vertex of one of the holes and the pivot of the other. Notice that u cannot be z because $z_i x_i \in A(G^*)$. Thus $u = x_i$, and as x_i is the pivot of H_i , it is a subordinate vertex of H . But by Lemma 2.8, either x_1 or x_2 should be pivot of every hole in the long theta in G^* . This contradiction completes the proof.

The second part of the theorem follows directly from Lemma 2.11. \square

References

- [1] James Perkins Burling. On coloring problems of families of polytopes (PhD thesis). *University of Colorado, Boulder*, 1965.
- [2] J er mie Chalopin, Louis Esperet, Zhentao Li, and Patrice Ossona de Mendez. Restricted frame graphs and a conjecture of Scott. *Electron. J. Comb.*, 23(1):P1.30, 2016.
- [3] Paul Erdős. Graph theory and probability. *Canadian Journal of Mathematics*, 11:34–38, 1959.
- [4] Andr as Gy arf as. Problems from the world surrounding perfect graphs. *Applicaciones Mathematicae*, 19(3-4):413–441, 1987.

- [5] Tomasz Krawczyk, Arkadiusz Pawlik, and Bartosz Walczak. Coloring triangle-free rectangle overlap graphs with $o(\log \log n)$ colors. *Discrete & Computational Geometry*, 53(1):199–220, nov 2014.
- [6] Benjamin Lévêque, Frédéric Maffray, and Nicolas Trotignon. On graphs with no induced subdivision of K_4 . *Journal of Combinatorial Theory, Series B*, 102(4):924–947, 2012.
- [7] Arkadiusz Pawlik, Jakub Kozik, Tomasz Krawczyk, Michał Lasoń, Piotr Micek, William T. Trotter, and Bartosz Walczak. Triangle-free intersection graphs of line segments with large chromatic number. *J. Comb. Theory, Ser. B*, 105:6–10, 2014.
- [8] Pegah Pournajafi and Nicolas Trotignon. Burling graphs revisited, part I: New characterizations. *European Journal of Combinatorics*, 110:103686, 2023. arXiv:2104.07001.
- [9] Pegah Pournajafi and Nicolas Trotignon. Burling graphs revisited, part II: Structure. *arXiv:2106.16089*, 2021.
- [10] Alex Scott. Induced trees in graphs of large chromatic number. *Journal of Graph Theory*, 24:297–311, 1997.
- [11] Alex Scott and Paul D. Seymour. A survey of χ -boundedness. *J. Graph Theory*, 95(3):473–504, 2020.
- [12] David P. Sumner. Subtrees of a graph and chromatic number. *The theory and applications of graphs*, pages 557–576, 1981.
- [13] Nicolas Trotignon. Perfect graphs: a survey. *CoRR*, abs/1301.5149, 2013.