



HAL
open science

Genome editing of a rice CDP-DAG synthase confers multipathogen resistance

Gan Sha, Peng Sun, Xiaojing Kong, Xinyu Han, Qiping Sun, Laetitia Fouillen, Juan Zhao, Yun Li, Lei Yang, Yin Wang, et al.

► **To cite this version:**

Gan Sha, Peng Sun, Xiaojing Kong, Xinyu Han, Qiping Sun, et al.. Genome editing of a rice CDP-DAG synthase confers multipathogen resistance. *Nature*, 2023, 618 (7967), pp.1017 - 1023. 10.1038/s41586-023-06205-2 . hal-04249822

HAL Id: hal-04249822

<https://hal.science/hal-04249822>

Submitted on 24 Oct 2023

HAL is a multi-disciplinary open access archive for the deposit and dissemination of scientific research documents, whether they are published or not. The documents may come from teaching and research institutions in France or abroad, or from public or private research centers.

L'archive ouverte pluridisciplinaire **HAL**, est destinée au dépôt et à la diffusion de documents scientifiques de niveau recherche, publiés ou non, émanant des établissements d'enseignement et de recherche français ou étrangers, des laboratoires publics ou privés.

1
2
3
4
5
6
7
8
9
10
11
12
13
14
15
16
17
18
19
20
21
22
23
24
25
26
27
28
29
30
31
32
33
34

Genome editing of a rice CDP-DAG synthase confers multi-pathogen resistance

Gan Sha ^{1, 13}, Peng Sun ^{1, 13}, Xiaojing Kong ¹, Xinyu Han ¹, Qiping Sun ¹, Laetitia Fouillen ², Juan Zhao ¹, Yun Li ¹, Lei Yang ¹, Yin Wang ¹, Qiuwen Gong ¹, Yaru Zhou ¹, Wenqing Zhou ¹, Rashmi Jain ^{3, 4}, Jie Gao ⁵, Renliang Huang ⁶, Xiaoyang Chen ^{1, 12}, Lu Zheng ¹, Wanying Zhang ¹, Ziting Qin ¹, Qi Zhou ⁷, Qingdong Zeng ⁸, Kabin Xie ⁵, Jiandi Xu ⁹, Tsan-Yu Chiu ⁷, Liang Guo ⁵, Jenny C. Mortimer ^{4, 10}, Yohann Boutté ², Qiang Li ⁵, Zhensheng Kang ⁸, Pamela C. Ronald ^{3, 4, 11, *}, Guotian Li ^{1, 3, 4, *}

¹State Key Laboratory of Agricultural Microbiology, Hubei Hongshan Laboratory, Hubei Key Laboratory of Plant Pathology, The Center of Crop Nanobiotechnology, Huazhong Agricultural University, Wuhan, 430070, China

²Laboratoire de Biogenèse Membranaire, Univ. Bordeaux, CNRS, Villenave d'Ornon, France

³Department of Plant Pathology and the Genome Center, University of California, Davis, Davis, CA 95616, USA

⁴The Joint BioEnergy Institute, Lawrence Berkeley National Laboratory, Emeryville, CA 94608, USA

⁵National Key Laboratory of Crop Genetic Improvement, Huazhong Agricultural University, Wuhan, 430070, China

⁶National Engineering Research Center of Rice (Nanchang), Key Laboratory of Rice Physiology and Genetics of Jiangxi Province, Rice Research Institute, Jiangxi Academy of Agricultural Sciences, Nanchang, 330200, China

⁷BGI-Shenzhen, Shenzhen, Guangdong, 518083, China

⁸State Key Laboratory of Crop Stress Biology for Arid Areas, Northwest A&F University, Yangling, 712100, China

⁹Institute of Wetland Agriculture and Ecology, Shandong Academy of Agricultural Sciences, Jinan 250100, China

¹⁰School of Agriculture, Food and Wine, University of Adelaide, Glen Osmond, SA, Australia

¹¹Innovative Genomics Institute, University of California, Berkeley, Berkeley, CA 94704, USA

¹²Present address: College of Plant Protection, Anhui Agricultural University, Hefei, 230036, China

¹³These authors contributed equally: Gan Sha and Peng Sun.

*Address correspondence to pcronald@ucdavis.edu (Pamela C. Ronald) and li4@mail.hzau.edu.cn (Guotian Li).

35 The discovery and application of genome editing introduce a new era of plant breeding, giving
36 researchers efficient tools for the precise engineering of crop genomes¹. Here, we demonstrate
37 the power of genome editing for engineering broad-spectrum disease resistance in rice (*Oryza*
38 *sativa*). We first isolated a lesion mimic mutant (LMM) from a mutagenized rice population,
39 demonstrated that a 29-bp deletion in a gene we named *RESISTANCE TO BLAST1 (RBL1)*
40 caused this phenotype and showed that this mutation caused a ca. 20-fold reduction in yield.
41 *RBL1* encodes a cytidine diphosphate diacylglycerol (CDP-DAG) synthase required for
42 phospholipid biosynthesis². Mutation of *RBL1* results in reduced levels of phosphatidylinositol
43 (PI) and its derivative PI(4,5)P₂. Rice PI(4,5)P₂ is enriched in cellular structures specifically
44 associated with effector secretion and fungal infection, suggesting a role as a disease
45 susceptibility factor³. Using targeted mutagenesis, we obtained an allele of *RBL1*, named *RBL12*,
46 which confers broad-spectrum resistance but does not decrease yield in a model rice variety as
47 assessed in small-scale field trials. Our study has demonstrated the usefulness of editing of an
48 LMM gene, a strategy relevant to diverse LMM genes and crops.

49 Main text

50 Genome editing has been widely used in functional studies of genes but its potential for crop
51 improvement has not yet been broadly utilized⁴. Plant diseases cause severe losses in agriculture,
52 threatening global food security⁵. Rice blast alone, caused by the fungal pathogen *Magnaporthe oryzae*,
53 results in annual yield losses that are sufficient to feed more than 60 million people worldwide⁶. Given
54 this cost, cultivating crops with resistance to diseases, particularly broad-spectrum resistance, is highly
55 desirable⁷. Despite the importance of this goal, only a limited number of broad-spectrum resistance
56 genes have been cloned and used in the field, such as rice *Xa21* (ref.⁸), *bsr-d1* (ref.⁹), *Pigm*¹⁰, *IPA1*
57 (ref.¹¹), *ROD1* (ref.¹²), *UMP1* (ref.¹³), wheat *Lr34* (ref.¹⁴) and *PsIPK1* (ref.¹⁵), and barley *mlo*^{16,17}.

58 LMMs form hypersensitive response-like lesions (a form of programmed cell death) in the absence of
59 pathogens¹⁸. LMMs often confer durable and broad-spectrum resistance, representing a potential
60 source for breeding resistance to diseases. However, LMMs are usually associated with reduced yield,
61 and therefore the use of the genes conferring LMM phenotypes (hereafter referred to as LMM genes)
62 has not been fully exploited in plant breeding due to the lack of useful alleles.

63 Phospholipids are essential components of biological membranes and are involved in various biological
64 processes, including development and response to biotic and abiotic stress¹⁹. In phospholipid
65 biosynthesis (Extended Data Fig. 1), phosphatidic acid (PA) and cytidine triphosphate (CTP) are
66 converted to CDP-DAG by CDP-DAG synthases (CDSs). CDP-DAG and *Myo*-inositol are used to
67 produce PI by phosphatidylinositol synthases (PISs)²⁰. PI is added to by a varied number of phosphate
68 groups to synthesize different phosphatidylinositolphosphates (PIPs), including PI3P, PI4P and PIP₂. In

69 particular, plant PI(4,5)P₂ has been demonstrated to be a disease susceptibility factor^{3,21}. The role of
70 phospholipids in rice immunity is largely unknown.

71 **Mutant *rb1* shows enhanced immunity**

72 To identify new LMM genes, we visually screened over 1,500 whole-genome sequenced fast-neutron
73 mutagenized lines in the rice variety Kitaake²². One of the six identified LMMs, named *rb1*, was of
74 particular interest because it showed enhanced resistance to both *Xanthomonas oryzae* pv. *oryzae* (*Xoo*)
75 and *M. oryzae* (Fig. 1a-f), though low in fertility (Extended Data Fig. 2a). The infection rate (3.4%) of *M.*
76 *oryzae* appressoria in *rb1* is significantly reduced compared to that (79.8%) Kitaake infected plants (Fig.
77 1g). Fungal hyphae spread restrictively in *rb1* compared to Kitaake at 72 hours post-inoculation (hpi),
78 possibly because the fungus triggers the accumulation of reactive oxygen species (ROS) in *rb1* (Fig. 1h,
79 i). Similarly, *rb1* showed significant upregulation of ROS, salicylic acid accumulation, and plant defense-
80 related genes (Extended Data Fig. 2b-d). These responses have previously been observed in other
81 LMMs, including *EBR1* (ref.²³), *spl-D*²⁴ and *oscul3a*²⁵.

82 Genetic analysis of a segregating M3 population of *rb1* revealed that the lesion mimic phenotype is
83 controlled by a recessive locus (Extended Data Fig. 2e). Subsequently, we whole-genome sequenced
84 pooled DNA from three lesioned M3 segregants using Illumina²² and identified a 29-bp deletion in *RBL1*
85 (LOC_Os01g55360) (Fig. 1j). The deletion cosegregated with the LMM phenotype. The deletion
86 overlaps the ninth exon-intron junction in gene *RBL1* and causes an inframe deletion of the ninth exon,
87 resulting in a 19-amino acid truncation at the conserved C-terminus of RBL1 (ref.²⁶) (Fig. 1k, l). The
88 truncation overlaps the CDS signature motif for ion-binding²⁷, likely resulting in loss of function for RBL1.
89 The genetic complementation assays confirmed that *RBL1* is the causative gene (Fig. 1m-p, and
90 Extended Data Fig. 2f-g). Additionally, *RBL1* is transcribed in all examined tissues with the highest level
91 in leaf, and its expression was induced by *M. oryzae* infection (Extended Data Fig. 3).

92 **RBL1 synthesizes CDP-DAG, a PI precursor**

93 As *RBL1* homologs are well conserved (Extended Data Fig. 4a-c), we used heterologous expression to
94 study its biochemical function using the yeast *cds1* mutant (Fig. 2a). The *RBL1* gene driven by a
95 galactose-inducible promoter was transformed into the *cds1* mutant. The resultant yeast strain *cdsC*
96 grew well on the galactose-containing media but not glucose-containing media, and RBL1 forms a
97 homodimer in yeast (Fig. 2b). Using lipidomics analysis, we detected higher levels of PA and DAG, and
98 reduced levels of PI and phosphatidylglycerol (PG) in the yeast cells cultured in the glucose-containing
99 media compared to those in the galactose-containing media (Fig. 2c). These results suggest that RBL1
100 functions as a CDP-DAG synthase.

101 We next used lipidomics technology to investigate the function of *RBL1* in rice. Levels of PA and DAG in
102 *rb1* are higher than levels observed in Kitaake. In contrast, levels of PI and PG were reduced

103 significantly by 71% and 49%, respectively (Fig. 2d). The reduction in PI is the most striking result of the
104 phospholipid alterations (Fig. 2e). To test whether exogenous supplementation of phospholipids could
105 rescue the LMM phenotype, we performed chemical complementation assays and observed that
106 exogenous supplementation of the media with PI but not PG, or PI(4,5)P₂ postponed lesion formation in
107 *rb1*, whereas PA accelerated lesion formation (Extended Data Fig. 5a-d). As respiratory burst oxidase
108 homolog (RBOH) proteins are important for ROS generation²⁸, we applied the RBOH inhibitor-
109 diphenyleneiodonium chloride (DPI) to *rb1*. We observed that DPI could alleviate the LMM phenotype
110 (Extended Data Fig. 5e).

111 To test whether increased production of PI could rescue the LMM phenotype, we overexpressed
112 *OsPIS1* in *rb1*. These *OsPIS1* overexpression lines (*OPIS1::rb1*) accumulated 60- to 400-fold higher
113 levels of *OsPIS1* transcript than in *rb1* (Supplementary Fig. 1). Compared to *rb1*, lesion formation in the
114 *OPIS1::rb1* lines was alleviated (Fig. 2f-h). Consistent with these results, *PR* gene expression and
115 resistance to *M. oryzae* in the *OPIS1::rb1* plants are lower than levels observed in *rb1* but higher than
116 levels in Kitaake (Fig. 2i, j). The PI content of the *OPIS1::rb1* plants (0.817 nmol mg⁻¹ DW) was restored
117 to 80% of that in Kitaake (1.017 nmol mg⁻¹ DW), a significant increase from the *rb1* line (0.319 nmol
118 mg⁻¹ DW, *P* < 0.01). We further analyzed PIP and PIP₂ content and observed that their levels were fully
119 restored in *OPIS1::rb1* lines from the reduced levels in *rb1*, though the disease susceptibility was only
120 partially restored (Fig. 2k). Similarly, we overexpressed the PA phosphohydrolase-encoding gene
121 *OsPAH2* in *rb1* (Fig. 2l). However, the *OPAH2::rb1* line, while restored in PA content, only shows a
122 minor reduction in the expression levels of *PR* genes and no alteration in lesion formation or resistance
123 to *M. oryzae* (Fig. 2m-o), indicating that elevated PA levels in *rb1* only contribute to enhanced immunity
124 in a limited way. Thus, we focused on PI derivatives in subsequent studies.

125 **PI(4,5)P₂ in infection-specific structures**

126 Using lipid blotting with PIP₂-specific antibodies, we showed the reduction of membrane PI(4,5)P₂ in *rb1*
127 (Fig. 3a, b). To further analyze the spatiotemporal changes of PI(4,5)P₂ *in situ* during fungal infection,
128 we generated stable transgenic rice lines expressing the PI(4,5)P₂ biosensor. PI(4,5)P₂ distributes
129 evenly along the plasma membrane in Kitaake. In contrast, PI(4,5)P₂ shows weak signals in the plasma
130 membrane and is present in unknown intracellular vesicles in *rb1* (Fig. 3c). Consistent with the western
131 blotting results, membrane PI(4,5)P₂ is reduced in *rb1* compared to Kitaake based on fluorescence
132 signals (Fig. 3d, e). Upon infection by *M. oryzae*, PI(4,5)P₂ quickly aggregates at the invasive hyphal tip
133 like a cap (Fig. 3f). As fungal infection progresses, PI(4,5)P₂ is recruited to the extra-invasive hyphal
134 membrane (EIHM) that encapsulates fungal infectious hyphae (Fig. 3g, h). Specifically, PI(4,5)P₂ is
135 enriched in an infection-specific structure called the biotrophic interfacial complex (BIC)-indicated by the
136 fluorescent cytoplasmic effector Pwl2 (Fig. 3i), which is important for effector secretion and fungal

137 infection²⁹. PI(4,5)P₂ was hardly observed in the cytoplasm of *rb1*. The BIC formation rate is only 16.7%
138 in *rb1* in contrast to 93.3% in Kitaake (Fig. 3j). Taken together, these results suggest that PI(4,5)P₂
139 could play a role in fungal-rice interactions (Fig. 3k).

140 **RBL12 balances growth and immunity**

141 The *rb1* line displays broad-spectrum resistance but shows a ca. 20-fold reduction in yield (Extended
142 Data Fig. 2a). To further evaluate the effects of different *RBL1* alleles on plant yield and immunity, we
143 designed guide RNAs by targeting multiple sites in *RBL1* using a multiplexing genome editing strategy
144 (Fig. 4a and Extended Data Fig. 6a-d). We obtained a total of 57 T0 edited lines; 38 of these showed
145 obvious LMM phenotypes and reduced seed sets, similar to *rb1*. Nineteen of the edited lines displayed
146 no or fewer lesions and varied seed sets in the greenhouse (Fig. 4b). Notably, the *RBL12* line with a 12-
147 bp deletion, which only showed tiny hypersensitive response-like lesions starting at the booting stage
148 (Fig. 4c, Extended Data Fig. 7a and Supplementary Fig. 2), produced a normal seed set (Fig. 4d).

149 Detailed infection assays revealed that *RBL12* conferred resistance to 10 *M. oryzae* field strains, 5 *Xoo*
150 strains, and 2 rice false smut *Ustilaginoidea virens* strains (Fig. 4e-j). Accordingly, levels of mycotoxins
151 in infected spikelets by *U. virens* are reduced by 66.2% in *RBL12* compared to that in Kitaake (Fig.4i).

152 We next carried out small-scale field trials aimed at assessing the usefulness of *RBL12* with transgene-
153 free seeds (Extended Data Fig. 6e-g). The grain yield of *RBL12* was evaluated in four fields in three
154 provinces (18°41'-30°47' N), primary rice production areas of China, where no or little *M. oryzae* was
155 present. Multiple key agronomic traits including plant height, tiller number per plant, seed setting rate,
156 thousand-grain weight, and grain yield were assessed. We found that, except for plant height, all
157 measured traits were similar between *RBL12* and Kitaake (Extended Data Fig. 6h). *RBL12* yielded 1.66
158 kg of grains per hundred plants, compared to 1.70 kg of grains for Kitaake (Fig. 4k). In a fifth location
159 (Enshi) with a high incidence of *M. oryzae*, the *RBL12* plants displayed robust resistance to both leaf
160 and panicle blast. The panicle blast severity of *RBL12* was 15.8%, much lower than that of Kitaake,
161 which was 90.3%. Regarding yield, we found that *RBL12* yielded 5.3-fold more grains than the control
162 Kitaake plants that were severely damaged by blast (0.75 vs. 0.12 kg per hundred plants) (Fig. 4l, m).
163 Taken together, these results demonstrate that the *RBL12* allele in Kitaake confers robust broad-
164 spectrum disease resistance with no reduction in yield in a small-scale field trial.

165 We next analyzed the *RBL12* allele in detail. The four amino acids truncated in *RBL12* are conserved in
166 plants (Extended Data Fig. 7b). The increased level of ROS in *RBL12* when challenged with chitin is
167 within the range of other rice cultivars (Extended Data Fig. 7c). The 12-bp deletion causes a significant
168 reduction in gene expression, though no alteration in protein thermostability and subcellular localization
169 was observed (Extended Data Fig. 7d-i). *RBL1* complements the *RBL12* line but the *RBL12* allele does
170 not complement *rb1* (Extended Data Fig. 7j-l). The complementation result was confirmed in the F2

171 population derived from Kitaake crossed with *RBL12*, which also indicates that the *RBL1* locus
172 contributes to resistance in a reverse dosage-dependent manner (Extended Data Fig. 7m-o). The PIP₂
173 levels and BIC formation rate are reduced in the *RBL12* line compared with Kitaake (Extended Data Fig.
174 7p-s). These results indicate that the *RBL12* allele results in a four-amino acid truncation and a
175 reduction in *RBL12* gene expression. We have also generated *RBL1* edited lines in two other rice
176 cultivars, Nipponbare and Zhonghua11, and observed enhanced resistance to *M. oryzae* and normal
177 growth, similar to *RBL12* (Extended Data Fig. 8).

178 Discussion

179 These results reveal a connection between rice phospholipid metabolism and rice immunity. They
180 further indicate important functions of RBL1, a CDP-DAG synthase, in the control of programmed cell
181 death and immunity via the regulation of PI biosynthesis. In Arabidopsis, the knockdown *cds* mutants
182 show enhanced immunity (Extended Data Fig. 4d-i)³⁰. These results suggest that *RBL1* homologs play
183 conserved roles in immunity. A recent study shows that mutation of *OsCDS5* enhances tolerance of rice
184 to hyperosmotic stress³¹. Taken together, these results suggest that CDSs play broad roles in plant
185 biotic and abiotic stress responses. PI derivatives play crucial roles in biology³². Of the PI derivatives,
186 the PI(4,5)P₂ level is reduced both in *rb11* and *RBL12*. Recently, PIP and PIP₂ were demonstrated to be
187 involved in plant and animal immunity³³⁻³⁵. Our results specifically show that PI(4,5)P₂ is enriched in the
188 BIC and EIHM (Fig. 3i), structures involved in effector secretion and *M. oryzae* infection²⁹. This
189 observation is consistent with studies that report PI(4,5)P₂ serves as a disease susceptibility factor that
190 is recruited to infection sites to facilitate infection^{3,21}. The exact role of PI(4,5)P₂ and PIP in fungal
191 effector secretion, rice immunity, and the relevant regulatory mechanisms³⁶ need further investigation.
192 Through genome editing, the *RBL12* allele in a model rice variety confers broad-spectrum resistance but
193 does not reduce yield in small-scale field trials. The results reported here suggest that fine-tuning of host
194 factors involved in formation of infection-specific structures is a strategy for balancing immunity and yield.
195 Our observations of the performance of the *RBL12* plants are promising. Multi-year field trials are
196 needed to evaluate the performance of the *RBL12* allele in elite, locally adapted rice varieties.
197 Like the atypical *R* genes *Lr34* and *mlo*, *RBL1* was isolated from LMMs. *Lr34* and *mlo* are well
198 conserved and have been applied to multiple crops for disease resistance^{37,38}. Similarly, the *RBL1*
199 homologs in other crops are worthy of further investigation. LMM genes, often encoding negative
200 regulators of immunity, represent an important class of genes conferring broad-spectrum resistance^{7,39}.
201 Negative regulators are particularly compatible with genome editing technologies that can efficiently
202 create complete or partial loss-of-function alleles^{40,41}. With continued advances of genome editing
203 technologies¹, the strategy demonstrated in this study becomes increasingly valuable to diverse LMM
204 genes and crops.

205 **References**

- 206 1 Gao, C. Genome engineering for crop improvement and future agriculture. *Cell* **184**, 1621-1635
207 (2021).
- 208 2 Liu, X., Yin, Y., Wu, J. & Liu, Z. Structure and mechanism of an intramembrane liponucleotide
209 synthetase central for phospholipid biosynthesis. *Nat. Commun.* **5**, 4244 (2014).
- 210 3 Qin, L. *et al.* Specific recruitment of phosphoinositide species to the plant-pathogen interfacial
211 membrane underlies *Arabidopsis* susceptibility to fungal infection. *Plant Cell* **32**, 1665-1688 (2020).
- 212 4 Zhu, H., Li, C. & Gao, C. Applications of CRISPR-Cas in agriculture and plant biotechnology. *Nat.*
213 *Rev. Mol. Cell Biol.* **21**, 661-677 (2020).
- 214 5 Chen, K., Wang, Y., Zhang, R., Zhang, H. & Gao, C. CRISPR/Cas genome editing and precision
215 plant breeding in agriculture. *Annu. Rev. Plant Biol.* **70**, 667-697 (2019).
- 216 6 Sakulkoo, W. *et al.* A single fungal MAP kinase controls plant cell-to-cell invasion by the rice blast
217 fungus. *Science* **359**, 1399-1403 (2018).
- 218 7 Li, W., Chern, M., Yin, J., Wang, J. & Chen, X. Recent advances in broad-spectrum resistance to
219 the rice blast disease. *Curr. Opin. Plant Biol.* **50**, 114-120 (2019).
- 220 8 Song, W. Y. *et al.* A receptor kinase-like protein encoded by the rice disease resistance gene, *Xa21*.
221 *Science* **270**, 1804-1806 (1995).
- 222 9 Li, W. *et al.* A natural allele of a transcription factor in rice confers broad-spectrum blast resistance.
223 *Cell* **170**, 114-126.e115 (2017).
- 224 10 Deng, Y. *et al.* Epigenetic regulation of antagonistic receptors confers rice blast resistance with
225 yield balance. *Science* **355**, 962-965 (2017).
- 226 11 Wang, J. *et al.* A single transcription factor promotes both yield and immunity in rice. *Science* **361**,
227 1026-1028 (2018).
- 228 12 Gao, M. *et al.* Ca²⁺ sensor-mediated ROS scavenging suppresses rice immunity and is exploited
229 by a fungal effector. *Cell* **184**, 5391-5404.e5317 (2021).
- 230 13 Hu, X. H. *et al.* A natural allele of proteasome maturation factor improves rice resistance to multiple
231 pathogens. *Nat. Plants* **9**, 228-237 (2023).
- 232 14 Krattinger, S. G. *et al.* A putative ABC transporter confers durable resistance to multiple fungal
233 pathogens in wheat. *Science* **323**, 1360-1363 (2009).
- 234 15 Wang, N. *et al.* Inactivation of a wheat protein kinase gene confers broad-spectrum resistance to
235 rust fungi. *Cell* **185**, 2961-2974.e2919 (2022).
- 236 16 Büschges, R. *et al.* The barley *Mlo* gene: a novel control element of plant pathogen resistance. *Cell*
237 **88**, 695-705 (1997).
- 238 17 Li, S. *et al.* Genome-edited powdery mildew resistance in wheat without growth penalties. *Nature*

239 **602**, 455-460 (2022).

240 18 Lorrain, S. Lesion mimic mutants: keys for deciphering cell death and defense pathways in plants?
241 *Trends Plant Sci.* **8**, 263-271 (2003).

242 19 Xing, J., Zhang, L., Duan, Z. & Lin, J. Coordination of phospholipid-based signaling and membrane
243 trafficking in plant immunity. *Trends Plant Sci.* **26**, 407-420 (2021).

244 20 Liu, L., Waters, D. L., Rose, T. J., Bao, J. & King, G. J. Phospholipids in rice: significance in grain
245 quality and health benefits: a review. *Food Chem.* **139**, 1133-1145 (2013).

246 21 Shimada, T. L. *et al.* Enrichment of phosphatidylinositol 4,5-bisphosphate in the extra-invasive
247 hyphal membrane promotes colletotrichum infection of *Arabidopsis thaliana*. *Plant Cell Physiol.* **60**,
248 1514-1524 (2019).

249 22 Li, G. *et al.* The sequences of 1504 mutants in the model rice variety Kitaake facilitate rapid
250 functional genomic studies. *Plant Cell* **29**, 1218-1231 (2017).

251 23 You, Q. *et al.* An E3 ubiquitin ligase-BAG protein module controls plant innate immunity and broad-
252 spectrum disease resistance. *Cell Host Microbe* **20**, 758-769 (2016).

253 24 Zhao, X. *et al.* A novel glycine-rich domain protein, GRDP1, functions as a critical feedback
254 regulator for controlling cell death and disease resistance in rice. *J. Exp. Bot.* **72**, 608-622 (2021).

255 25 Liu, Q. *et al.* OsCUL3a negatively regulates cell death and immunity by degrading OsNPR1 in rice.
256 *Plant Cell* **29**, 345-359 (2017).

257 26 Zhou, Y. *et al.* Extraplasmidial cytidinediphosphate diacylglycerol synthase activity is required for
258 vegetative development in *Arabidopsis thaliana*. *Plant J.* **75**, 867-879 (2013).

259 27 Blunsom, N. J. & Cockcroft, S. CDP-diacylglycerol synthases (CDS): gateway to
260 phosphatidylinositol and cardiolipin synthesis. *Front. Cell Dev. Biol.* **8**, 63 (2020).

261 28 Li, J. & Wang, X. Phospholipase D and phosphatidic acid in plant immunity. *Plant Sci.* **279**, 45-50
262 (2019).

263 29 Khang, C. H. *et al.* Translocation of *Magnaporthe oryzae* effectors into rice cells and their
264 subsequent cell-to-cell movement. *Plant Cell* **22**, 1388-1403 (2010).

265 30 Du, X. Q., Yao, H. Y., Luo, P., Tang, X. C. & Xue, H. W. Cytidinediphosphate diacylglycerol
266 synthase-mediated phosphatidic acid metabolism is crucial for early embryonic development of
267 *Arabidopsis*. *PLoS Genet.* **18**, e1010320 (2022).

268 31 Hong, Y., Yuan, S., Sun, L., Wang, X. & Hong, Y. Cytidinediphosphate-diacylglycerol synthase 5 is
269 required for phospholipid homeostasis and is negatively involved in hyperosmotic stress tolerance. *Plant*
270 *J.* **94**, 1038-1050 (2018).

271 32 Di Paolo, G. & De Camilli, P. Phosphoinositides in cell regulation and membrane dynamics. *Nature*
272 **443**, 651-657 (2006).

- 273 33 Kale, S. D. *et al.* External lipid PI3P mediates entry of eukaryotic pathogen effectors into plant and
 274 animal host cells. *Cell* **142**, 284-295 (2010).
- 275 34 Liu, L. *et al.* The *Xanthomonas* type III effector XopAP prevents stomatal closure by interfering with
 276 vacuolar acidification. *J Integr Plant Biol* **64**, 1994-2008 (2022).
- 277 35 Wang, H. *et al.* A plant virus hijacks phosphatidylinositol-3,5-bisphosphate to escape autophagic
 278 degradation in its insect vector. *Autophagy* **19**, 1128-1143 (2023).
- 279 36 Marković, V. & Jaillais, Y. Phosphatidylinositol 4-phosphate: a key determinant of plasma
 280 membrane identity and function in plants. *New Phytol.* **235**, 867-874 (2022).
- 281 37 Boni, R. *et al.* Pathogen-inducible *Ta-Lr34res* expression in heterologous barley confers disease
 282 resistance without negative pleiotropic effects. *Plant Biotechnol. J.* **16**, 245-253 (2018).
- 283 38 Gruner, K. *et al.* Evidence for allele-specific levels of enhanced susceptibility of wheat *mlo* mutants
 284 to the hemibiotrophic fungal pathogen *Magnaporthe oryzae* pv. *Triticum*. *Genes (Basel)* **11** (2020).
- 285 39 Li, W., Deng, Y., Ning, Y., He, Z. & Wang, G. L. Exploiting broad-spectrum disease resistance in
 286 crops: from molecular dissection to breeding. *Annu Rev Plant Biol* **71**, 575-603 (2020).
- 287 40 Oliva, R. *et al.* Broad-spectrum resistance to bacterial blight in rice using genome editing. *Nat.*
 288 *Biotechnol.* **37**, 1344-1350 (2019).
- 289 41 Lu, Y. *et al.* Targeted, efficient sequence insertion and replacement in rice. *Nat. Biotechnol.* **38**,
 290 1402-1407 (2020).

291 **Figure legends**

292 **Fig.1 | Cloning of the *RBL1* gene from the lesion mimic mutant *rb11*, which has enhanced**
 293 **immunity.**

294 **a**, *rb11* mutant and wild-type (WT, KitaakeX) plants at 40 days post sowing (dps). Bar, 10 cm. **b**,
 295 Spontaneous lesions. Bar, 1 cm, which is the same for other panels without specifications. **c**, Inoculation
 296 of rice lines with *Xoo* at 14 days post-inoculation (dpi) and lesion length (**d**). **e**, Punch inoculation with *M.*
 297 *oryzae* at 14 dpi. The dashed lines indicate the leaf area covered by aluminum foil before spontaneous
 298 lesions appeared. **f**, Lesion area and relative fungal biomass. **g**, Fungal infection rates at 72 hours post-
 299 inoculation (hpi). **h**, Rice sheath cells infected by eGFP-tagged *M. oryzae* strain ZB25. Bars, 25 μ m. **i**,
 300 ROS generation in rice plants challenged with chitin and water (mock). **j**, Screenshot of the 29-bp
 301 deletion in *rb11*. **k**, Gene structure of *RBL1*. The gray box indicates the exon skipped in *rb11*. The
 302 sequence of the deletion is shown, and the intron sequence is italic with the intron recognition site “GT”
 303 underlined. **l**, The predicted secondary structure of RBL1. The red box indicates the truncation. The
 304 CDS signature motif is shown at the bottom. **m**, 10-week-old WT, *rb11*, and complemented (CoR1)
 305 plants. Bar, 10 cm. **n**, Leaves of the lines in (**m**). **o**, qRT-PCR assays of *RBL1*. **p**, Infected leaves, lesion
 306 area and relative fungal biomass of rice lines with *M. oryzae* at 14 dpi. Data are displayed as box and

307 whisker plots with individual data points: center line, median; box limits, 25th and 75th percentiles.
308 Asterisks indicate significant differences using the unpaired Student's *t*-test (***P* < 0.01, ****P* < 0.001,
309 *****P* < 0.0001). Significant differences indicated by different letters in (o) and (p) were calculated using
310 the Duncan's new multiple range test.

311 **Fig.2 | RBL1 functions as a CDP-DAG synthase.**

312 a, *RBL1* rescues the growth defect of the yeast *cds1* mutant. WT, yeast strain BY4741; *cdsC*, yeast
313 mutant *cds1* expressing *RBL1*. b, Immunoblotting analysis of the RBL1-6×His fusion protein (monomeric
314 and dimeric states). CBB, Coomassie brilliant blue. c, Lipidomics assays of yeast strains cultured in
315 YPGal or YPD. d, Lipidomic analysis of the 4-week-old wild-type (WT, Kitaake) and *rb1* lines. DW, dry
316 weight. e, Fatty acid species of PI. No alterations were detected between WT and *rb1* for fatty acid
317 species 36:1 to 36:6. f, 8-week-old T1 plants of the *OsPIS1* overexpression OPIS1::*rb1* lines. Bar, 10
318 cm. g, Lesions on new rice leaves. Bar, 1 cm. h, Lesion area of the lines in (g). i, qRT-PCR assays of
319 genes in the OPIS1::*rb1* line. j, Punch inoculation with *M. oryzae* and relative fungal biomass at 14 dpi.
320 Bar, 1 cm. k, PI, PIP, and PIP₂ assays. l, 8-week-old plants. OPAH2::*rb1*, the *rb1* line overexpressing
321 *OsPAH2*. Black bar, 1 cm; white bar, 10 cm. m, qRT-PCR assays. n, Punch inoculation with *M. oryzae*
322 and the lesion area at 14 dpi. Bar, 1 cm. o, Lipidomics assays of different rice lines. The box plot
323 elements are: center line, median; box limits, 25th and 75th percentiles. Bars in (c), (h), (i), and (k)
324 indicate standard deviations, and asterisks in (d), (e), (h), and (i) indicate significant differences using
325 the unpaired Student's *t*-test (**P* < 0.05, ***P* < 0.01, ****P* < 0.001, *****P* < 0.0001). Significant differences
326 indicated by different letters in (c), (i), (j), (k), (m), (n), and (o) were calculated using the Duncan's new
327 multiple range test.

328 **Fig. 3 | PI(4,5)P₂, enriched in infection-specific structures, is reduced in *rb1* plants.**

329 a, Dot blotting of membrane PIP₂ in the wild-type (WT, Kitaake) and *rb1* lines. b, The relative levels of
330 membrane PIP₂. c, Epidermal cells of rice lines expressing the PI(4,5)P₂ biosensor. Bar, 25 μm. d,
331 Relative fluorescence intensity of the PI(4,5)P₂ biosensor in (c). The box plot elements are: center line,
332 median; box limits, 25th and 75th percentiles. e, Immunoblotting of the PI(4,5)P₂ biosensor in (c). PLC,
333 the biosensor; RBC, ribulose-1,5-bis-phosphate carboxylase/oxygenase. f, PI(4,5)P₂ aggregates around
334 the infectious hyphal tip of *M. oryzae* at 22 hpi. AP, appressorium; IH, invasive hyphae. Pwl2 is a
335 cytoplasmic effector, a biomarker for the biotrophic interfacial complex (BIC). Bar, 10 μm. g, Rice cells
336 of the WT expressing the PI(4,5)P₂ biosensor infected by the *M. oryzae* strain expressing the apoplastic
337 effector Bas4 tagged with the mCherry protein at 27 hpi. EIHM, extra-invasive hyphal membrane. Bar,
338 10 μm. h, Fluorescence intensity of the plasma membrane (PM) and EIHM shown in (g). i, PI(4,5)P₂ and
339 Pwl2 at the BIC at 32 hpi. The inset shows the enlarged BIC. Bars, 5 μm. j, BIC formation in different
340 rice lines. Bar, 10 μm. The numbers represent the BIC formation rates from 150 infected cells. k,

341 Working model of RBL1 in rice resistance to *M. oryzae*. RBL1 is important for the biosynthesis of PI and
342 PIPs including PI(4,5)P₂. As *M. oryzae* invades, PI(4,5)P₂ is recruited to the EIHM and enriched in BIC.
343 Accumulation of PA is a minor factor of enhanced immunity of *rb1*. Other unknown factors also
344 contribute to enhanced immunity of *rb1*. Bars in (b) and (h) indicate standard deviations, and asterisks
345 indicate significant differences using the unpaired Student's *t*-test (*****P* < 0.0001).

346 **Fig.4 | RBL12 confers broad-spectrum resistance with no observed yield penalty in field trials.**

347 a, Guide RNA sites, indicated by dots, for genome editing of *RBL1*. The asterisk indicates the edited site
348 in *RBL12*. b, *RBL1* edited lines. WT, Kitaake. Bar, 1 cm, which is the same for other panels without
349 specifications. c, 8-week-old plants in the greenhouse. Bar, 10 cm. d, Agronomic traits. e, Lesions with
350 *M. oryzae* at 14 dpi. f, Lesions with *Xoo* at 14 dpi. g, *In planta* bacterial growth of *Xoo* strain PXO99. h,
351 Infected panicles with *U. virens*. Rice false smut balls were counted at 17 dpi. i, Quantitative assays of
352 ustiloxins in infected panicles. FW, fresh weight. j, Infected spikelets with *U. virens*. Arrows indicate
353 invasive hyphae. an, anther; pa, palea; sf, stamen filament; st, stigma. Bars, 100 μm. k, Rice grain yield
354 in the "Normal" field trials with low incidence of rice blast. l, Field assessment of blast resistance in the
355 blast nursery. Representative panicles are shown on the left. Disease severity is indicated by the
356 percentage of necrotic panicles for each plant caused by *M. oryzae*. m, Grain yield of plants grown in
357 the blast nursery. Seeds per plant are shown on the left. The box plot elements are: center line, median;
358 box limits, 25th and 75th percentiles. Asterisks in (h), (i), (l), and (m) indicate significant differences
359 using the unpaired Student's *t*-test (**P* < 0.05, ****P* < 0.001, *****P* < 0.0001). Significant differences
360 indicated by different letters in (d-g) were calculated using the Duncan's new multiple range test.

361 **Online content**

362 Any methods, additional references, Nature Research reporting summaries, source data, supplementary
363 information, acknowledgements, peer review information; details of author contributions and competing
364 interests; and statements of data and code availability are available at <https://doi.org/>.

365 **Methods**

366 **Plant materials, strains, and growth conditions**

367 The *rb1* mutant (FN398) was identified from the FN-induced mutant population generated in the model
368 *Japonica* rice (*Oryza sativa*) line KitaakeX⁴². The genome sequence of KitaakeX is available online
369 (<https://phytozome.jgi.doe.gov/pz/portal.html>)⁴³. The segregating M3 population derived from the *rb1*
370 line was used in sequencing and cosegregation assays. For infection assays and other phenotype
371 characterizations, rice seeds were surface-sterilized and germinated on 1/2 Murashige and Skoog (MS)
372 media. After a week in the growth chamber, plants were transferred to the greenhouse with a
373 photoperiod (12/12 h) at 28°C. The Arabidopsis plants were cultivated in the potting soil mixture (peat
374 soil/rich soil/vermiculite =1:1:1, v/v/v) in growth chamber at 21°C, 60% humidity, the day/night period

375 16/8 h, with an intensity of $80 \mu\text{mol m}^{-2} \text{s}^{-1}$ (ref.^{30,44}). The *Xanthomonas oryzae* pv. *oryzae* (*Xoo*) strain
376 was grown on nb plates at 28°C for 3 days before use⁴⁵. The *Magnaporthe oryzae* strains were cultured
377 on oatmeal agar plates under light at room temperature^{46,47}. The *Ustilaginoidea virens* strains were
378 routinely grown on PSA plates and were grown in the PSB medium at 28°C, 160 rpm for 7 days for
379 conidiation⁴⁸. The *Phytophthora capsica* strain was cultured on PDA plates at 25°C for 3-4 days in dark
380 before use⁴⁹.

381 **Generation of *M. oryzae* strains tagged with different fluorescence proteins**

382 Fungal protoplast preparation and transformation were performed as previously described⁵⁰. Briefly, the
383 GFP overexpression plasmid RP27-GFP, the apoplastic effector Bas4-mCherry vector that was used to
384 indicate the extra-invasive hyphal membrane (EIHM), and the cytoplasmic effector Pw12-mCherry vector
385 that was used to indicate the biotrophic interfacial complex (BIC), were transformed into *M. oryzae* strain
386 ZB25 (ref.^{29,51}). The resultant transformants were selected on TB3 plates with 500 $\mu\text{g/ml}$ geneticin
387 (GLP BIO). The neomycin-resistant transformants were verified using PCR and examined under a laser
388 scanning confocal microscopy.

389 **Plant infection assays**

390 The leaf-clipping method was used in *Xoo* infection of rice plants at the booting stage⁵². The *Xoo* culture
391 of strains PXO71, PXO99, PXO341, ZHE173 and GX01 (ref.⁵³) was suspended in distilled water and the
392 bacterial suspension concentration was adjusted to $\text{OD}_{600} \approx 0.5$. A pair of sterilized scissors were
393 dipped into the bacterial suspension and cut the leaves at 5 cm from the leaf tip. The infected plants
394 were transferred to the greenhouse. The setting for the greenhouse was the day/night period (12/12 h),
395 temperature ($\sim 28^\circ\text{C}$), and relative humidity (80%). Water-soaked lesions were scored at 14 days post-
396 inoculation (dpi) or as indicated. At least three plants were inoculated for each assay. The ΔraxST *Xoo*
397 strain that can overcome the XA21-mediated immunity was used to infect the KitaakeX line carrying the
398 *Xa21* gene⁵³.

399 The *M. oryzae* strains ZB25, LN3, LN13, LN14, ES18, ES24, ES28, ES36, ES76, and ES80 used in
400 infection assays were isolated from the rice fields in Enshi (ES) and Liaoning (LN), China and stored in
401 the laboratory. The punch inoculation was conducted as previously described⁵⁴. Briefly, spores were
402 freshly collected from 10-day-old oatmeal agar cultures and the concentration was adjusted to 1×10^5
403 spores/ml with 0.025% Tween-20. Fully extended rice leaves at 30 days post-sowing (dps) were
404 wounded with a punch and inoculated with 10 μl spore suspension. The punched area was sealed with
405 clear Scotch tapes. Inoculated plants were transferred to the greenhouse. Symptoms were scored at 14
406 dpi and relative fungal biomass abundance was measured using the qPCR approach²⁵. Primers used in
407 the assay are listed in Supplementary Table 1.

408 For microscopic analysis of *M. oryzae* infection, the ZB25-eGFP strain stably expressing the GFP was
409 used to inoculate detached rice sheaths of 5-week-old rice plants. The spore concentration was
410 adjusted to approximately 1.5×10^6 conidia/ml. The fungal infection rate in each plant line was analyzed
411 from five replicates at 72 hpi, and at least 30 appressoria for each replicate were examined for invasive
412 hyphae growth in the rice sheath cells under a laser scanning confocal microscopy (Leica TCS SP8).
413 For false smut infection with *U. virens* strains HWD2 and JS60 (ref.⁵⁵), panicles of rice plants at the
414 booting stage were inoculated with 1 ml of a mixture of spores and homogenized mycelia with a syringe.
415 Infected plants were kept at $\sim 25^\circ\text{C}$ with $\sim 85\%$ relative humidity in the greenhouse. The number of smut
416 balls per panicle was counted at 17 dpi. For scanning electron microscope (SEM), spikelet was sampled
417 from the Kitaake and *RBL12* lines inoculated at 36 h, 72 h, and 7 d, and directly examined with SEM
418 (JSM-6390/LV) using the protocol previously described⁵⁶.
419 Infection assays on Arabidopsis with *Phytophthora capsica* were conducted as previously described with
420 minor modifications⁴⁹. Briefly, the *P. capsici* strain LT263 was cultured on PDA plates for 3 days at 25°C
421 in dark. Detached leaves of Arabidopsis at 30 dps were placed on the 0.8% water-agar plates and
422 inoculated with 3 mm x 3 mm blocks of the *P. capsica* culture. The samples were kept at room
423 temperature in darkness. The inoculated leaves were photographed under UV light, and the lesion area
424 and relative pathogen biomass were measured at 36 hpi.

425 **DAB staining**

426 To visualize hydrogen peroxide (H_2O_2) in the plant tissue, rice leaves were collected at 40 dps and
427 immediately immersed in the 3, 3'-diaminobenzidine (DAB) staining solution (1 mg/ml) in 15 ml tubes.
428 The tube was covered with aluminum foil and incubated with shaking at 80-100 rpm at room
429 temperature for 8 h. Samples were decolorized with 95% ethanol in a boiling water bath for 10 min and
430 bleached for another 48 h in fresh 95% ethanol until the chlorophyll had been mostly removed from the
431 sample. The cleared leaves were then visualized for DAB staining.

432 **Measurement of reactive oxygen species**

433 Measurement of ROS following chitin treatment was conducted as previously described²⁵. Briefly, rice
434 plants were grown on 1/2 MS media in the growth chamber for 12 days. Leaves of the seedlings were
435 cut into disks (3 mm x 3 mm) and then submerged in distilled water in a 96-well plate under light
436 overnight. The distilled water was pipetted out and replaced with 100 μl mixed solution for each well,
437 which contains 50 μM luminol (Wako), 10 $\mu\text{g/ml}$ horseradish peroxidase and 8 nM chitin (GLP BIO),
438 using a multiple-channel pipette. The chemiluminescence was measured at 500-ms intervals over a
439 period of 40 min in a SPARK-10M microplate reader (TECAN). Three biological replicates, each of
440 which contains eight technical replicates, were used for each sample. Distilled water was used as the
441 mock control.

442 **Quantitation of total salicylic acid in leaf**

443 For total salicylic acid (SA) measurement, plants were grown on 1/2 MS media in the growth chamber
444 for 12 days, and leaf tissues were harvested and freeze dried. About 20 mg dried tissues were ground in
445 liquid nitrogen. The sample powder was mixed with 1 ml 80% (v/v) methanol using an ultrasonic cleaner
446 at 70°C for 15 min. The mixture was centrifuged at 7,000×g at 4°C, and the supernatant was collected
447 and filtered (Φ 0.22 μm). SA in the samples and serial dilutions of the SA standard were analyzed
448 together using the high-performance liquid chromatography-tandem mass spectrometry (HPLC-MS)
449 system. The SA content of each sample was calculated by comparing with the calibration curve of the
450 SA standard.

451 **RNA extraction, and reverse-transcription quantitative PCR analysis**

452 Rice leaves as indicated were sampled into liquid nitrogen. RNA was isolated with TRIzol (CWBIO).
453 Residual DNA was eliminated with DNase I (Thermo Scientific). Purified RNA was examined using
454 agarose gel electrophoresis before complementary DNA (cDNA) synthesis, which was performed using
455 the HiScript II 1st Strand cDNA Synthesis Kit (Vazyme). qRT-PCR was performed on a Bio-Rad CFX96
456 Real-Time System coupled to a C1000 Thermal Cycler (Bio-Rad) using the SYBR Green Mix (Vazyme).
457 The 2^{-ΔΔCT} method was used to calculate the expression level of target genes⁵⁷. Three biological
458 replicates for each of which included three technical replicates were used for each sample. The rice
459 *Actin* gene (LOC_Os03g50885, NM_001058705) was used as the internal control. See Supplementary
460 Table 1 for primers used.

461 **Cloning of *RBL1* and genetic complementation**

462 The *rb11* mutant was crossed with Kitaake and the F1 plants were used to examine whether the
463 spontaneous lesion phenotype was controlled in a recessive/dominant manner. DNA was isolated from
464 pooled samples of three M3 plants showing spontaneous lesions of the *rb11* line. Genomic sequencing
465 performed on the HiSeq 2500 next-generation sequencing system (Illumina) and mutation identification
466 using the established bioinformatic pipeline were conducted as described²². InDel markers for identified
467 homozygous mutations were used in the cosegregation assay (Supplementary Table 1). Primers
468 RBL1cDNAF/R were used to amplify the coding sequence of *RBL1* from cDNA of Kitaake and the *rb11*
469 mutant and the resultant products were sequenced. To complement the *rb11* mutant, the entire ORF of
470 the *RBL1* gene including its native promoter, 2-kb sequence upstream of the start codon ATG, was
471 amplified using PCR with primers CoRBL1F/R (Supplementary Table 1). The PCR product was purified
472 and then cloned into the binary vector pCAMBIA2300 using a HiFi DNA Assembly Master Mix (NEB).
473 The resultant construct was confirmed using Sanger sequencing. The following *Agrobacterium*-mediated
474 transformation and transformant selection were performed at BioRun BioScience Co., Ltd. (Wuhan,
475 China). The positive transformants were examined using the Cleaved Amplified Polymorphic Sequences

476 (CAPS) marker (Supplementary Table 1). *RBL1* expression and fungal infection assays were done as
477 described above.

478 **Yeast mutant complementation and protein purification**

479 The *RBL1* ORF was amplified from Kitaake cDNA with primers YCF1/R1 (Supplementary Table 1) and
480 cloned into plasmid pYES2-His as pYES2-*RBL1*-His. Competent cells of the yeast strain BY4741 (*MATa*
481 *his3 leu2 met15 ura3*) (WT) were prepared and transformed with the pYES2-*RBL1*-His construct using
482 the Super Yeast Transformation Kit (Coolaber). The Ura⁺ transformant was confirmed using PCR and
483 then used in knocking out the yeast endogenous *CDS1* gene using a homologous recombination
484 approach⁵⁸. The resultant strains were confirmed using PCR and assayed for growth on YPD and
485 YPGal plates at 30°C. To analyze the RBL1 protein expression in yeast, the total protein was isolated
486 from the complementation and WT strains, and the His-tagged RBL1 protein was detected using
487 western blotting with anti-His-tag antibody (1:5,000 dilution; CST). Functional complementation assays
488 with the RBL1-GFP fusion protein were performed similarly.

489 For protein expression and purification, total proteins were isolated from yeast strains BY4741, and
490 transformants carrying pYES2-*RBL1*-His and pYES2-*RBL12*-His. The His-tagged RBL1 and RBL12
491 proteins were purified from total proteins using the Ni-NTA protein purification system according to a
492 method described previously². The thermostability assays of the fusion proteins were performed using
493 the differential scanning calorimeter (DSC) as previously described⁵⁹. Briefly, the temperature range
494 was set from -100°C to 150°C, and the scan rate was 60°C/h.

495 **Yeast lipidomics assays**

496 To analyze functions of RBL1 in yeast, the WT and complementation yeast strains were cultured in
497 YPGal to reach OD₆₀₀ ≈ 0.6, and the yeast cells were harvested using brief centrifugation and rinsed
498 with sterile water once. The yeast cells were then resuspended in YPD or YPGal and cultured at 30°C,
499 220 rpm for up to 4, 8, and 20 h before harvesting for phospholipid isolation. The yeast cells were then
500 homogenized with acid-washed glass beads, and 1 ml extraction buffer chloroform/methanol/formic acid
501 (10:10:1, v/v/v) was added to the homogenized yeast cells and vortexed for 3 min and centrifuged at
502 4°C, 1,000×g for 6 min to collect the supernatant. The extraction was repeated once with
503 chloroform/methanol/water (5:5:1, v/v/v). The supernatant was combined and mixed well with 3 ml buffer
504 (0.2 M H₃PO₄, 1 M KCl). The mixture was centrifuged at 4°C, 1,000×g for 10 min. The lower organic
505 phase was collected and dried under the nitrogen gas. The dried sample was dissolved in 300 μl
506 chloroform, and lipid extracts were analyzed using liquid chromatography-mass spectrometry (LC-
507 MS/MS) as previously described⁶⁰.

508 **Protein subcellular localization analysis**

509 The full-length coding sequence of *RBL1* was amplified with primers SLRBL1F/R (Supplementary Table
510 1) and fused with the enhanced green fluorescent protein (eGFP) sequence in vector pEarleyGate101
511 under control of the CaMV 35S promoter⁴⁴. The resultant constructs were confirmed using Sanger
512 sequencing and transformed into *Nicotiana benthamiana* leaves with/without related marker constructs.
513 For *N. benthamiana* transient expression, constructs were transformed into *Agrobacterium* strain
514 GV3101 and then the resultant strain was infiltrated into leaves of 30-day-old *N. benthamiana* plants.
515 The fluorescence signal was observed with laser scanning confocal microscopy (Leica TCS SP8) 72 h
516 after infiltration.

517 **GUS histochemical assay**

518 For the β -glucuronidase (GUS) activity assay, the 2-kb genomic region upstream of the start codon of
519 *RBL1* was PCR amplified from rice genomic DNA with primers ProRBL1-F/R (Supplementary Table 1)
520 and cloned into the pGreenII 0179-GUS vector⁴⁴. The resultant construct pRBL1-GUS was confirmed
521 using Sanger sequencing and transformed into rice calli using the *Agrobacterium*-mediated approach.
522 Plants containing pRBL1-GUS were genotyped before GUS staining. For GUS staining, rice plant
523 tissues were stained in the Ready-to-use GUS Staining Solution (PHYGENE) at 37°C overnight. The
524 stained plant tissues were rinsed with water and incubated in 70% ethanol for 24 h to remove the
525 chlorophyll. Photomicrographs were taken using the stereoscopic microscope (Nikon SMZ1000).

526 **Lipid extraction and analysis**

527 Leaf samples from 5-week-old plants were used for the total phospholipid extraction as described³¹.
528 Briefly, more than 10 mg fresh weight (FW) rice leaf tissue was harvested and immediately immersed in
529 preheated isopropanol (75°C) with 0.01% butylated hydroxytoluene (BHT) and incubated for 15 min.
530 After cooling to room temperature, chloroform was added to the sample and incubated with shaking at
531 room temperature for 1 h. The lipid extracts were transferred to new glass tubes to repeat the extraction
532 procedure until the leaf sample became bleached. The lipid extracts were combined and evaporated
533 under the nitrogen gas, and then redissolved in chloroform. The lipidomics analysis was performed by a
534 method described by Lu et al.⁶¹ using a TripleTOF mass spectrometer (TripleTOF-MS/MS) instrument
535 with an electrospray ionization (ESI) source in the positive ion mode. Lipids in each class were
536 quantified by comparison with internal standards (Avanti).
537 Phosphoinositides were extracted as previously described⁶². Briefly, lipids from dried leaf samples of the
538 Kitaake, *rb11*, *RBL12*, and OPIS1 lines were extracted with 750 μ l of MeOH/CHCl₃/1M HCl (2:1:0.1, v/v/v)
539 and 150 μ l of H₂O in the presence of internal standards. Lipids were modified with TMS-diazomethane
540 for 10 min. LC-MS/MS (multiple-reaction-monitoring mode) analyses were performed with a mass
541 spectrometer QTRAP 6500 (ABSciex) mass spectrometer coupled with a liquid chromatography system
542 (1290 UPLC Infinity II, Agilent). Analyses were achieved in the positive ion mode. Reverse-phase

543 separations were carried out on a Jupiter C4 column (50×1 mm; particle size, 5 µm; Phenomenex).
544 Eluent A was H₂O and 0.1% formic acid, and eluent B was acetonitrile and 0.1% formic acid. The
545 gradient elution program was as follows: 0-2 min, 45% eluent B; 27 min, 100% eluent B; and 27-30 min,
546 100% eluent B. The flow rate was 100 µl/min; 10 µl sample volumes were injected. The area of LC
547 peaks was determined using MultiQuant software (ABSciex) for relative quantification to the area of the
548 internal standard, and values are expressed in arbitrary unit by quantity (AU/mg DW).

549 **Chemical supplementation and overexpression of the *OsPIS1* and *OsPAH2* genes**

550 Phospholipids PI, PG, PI(4,5)P₂, and diphenyleneiodonium chloride (DPI) were added to DMSO, and
551 incubated at 42°C for 30 min and treated in the ultrasonic homogenizer for 10 min to facilitate the
552 dissolving. The mixture was filter-sterilized (Φ 0.22 µm). For chemical supplementation assays, Kitaake
553 and *rb11* plants were grown on 1/2 MS media with PI (0, 10, 50, and 100 µM), PG (0, 10, and 100 µM),
554 PI(4,5)P₂ (0, 50, and 100 nM), PA (0, 0.1, 1, and 10 µM), or DPI (0, 0.1, 0.5, and 1 µM) in the growth
555 chamber for 6~10 days. The leaf was then examined for lesions for a successive of 10 days. To
556 overexpress *OsPIS1* and *OsPAH2* genes, genomic regions of these two genes were cloned into vector
557 pRGV under control of the maize *Ubiquitin10* promoter⁶³, respectively. The resultant constructs were
558 sequenced and transformed into the *rb11* mutant. The overexpression lines were genotyped, analyzed
559 using qRT-PCR and examined for lesions. Plant infection assays and related qRT-PCR assays of the
560 overexpression line were performed as described above.

561 **Plasma membrane extraction and lipid blotting assay**

562 The plasma membrane enrichment and purification were performed using aqueous two-phase
563 partitioning as described previously⁶⁴. Briefly, rice leaves (20 g) were homogenized in liquid nitrogen,
564 and were immediately added to 120 ml ice-cold buffer (50 mM Tris-Me (pH 8.0), 0.25 M sucrose, 3 mM
565 EDTA, 0.6% PVP, 10% glycerol, 10 mM DTT, 1 mM PMSF, 1×protease inhibitor cocktail). When the
566 homogenized tissues were obtained, one small portion of the sample was used to extract proteins for
567 the loading control; the remaining sample was used to extract membrane lipids. The samples were
568 centrifuged at 60,000×g for 30 min to pellet plasma membrane vesicles. The plasma membrane was
569 then mixed with 1 ml of chloroform/methanol/concentrated HCl (1:2:0.02, v/v/v) solution, and the lipid
570 components were separated using 300 µl of chloroform and 300 µl of KCl (2 M).

571 In the subsequent lipid dot blotting, the organic phase was applied to the nitrocellulose filter membrane,
572 and PIP₂ was detected with the mouse anti-PIP₂ antibody 2C11 (Abcam), which were conducted
573 following a previously described method⁶⁵. ImageJ software was used to quantify the content of PIP₂ on
574 the blotted membrane.

575 **Subcellular localization and fluorescence intensity assays of rice PIP and PIP₂**

576 A set of vectors genetically encoding biosensors for PIP and PIP₂ were ordered from the Nottingham
577 Arabidopsis Stock Centre, including mCIT-2×FYVE^{HRS} for PI3P, mCIT-2×PH^{FAPP1} for PI4P, and mCIT-
578 1×PH^{PLCΔ1} for PI(4,5)P₂ (ref.⁶⁶). To analyze the subcellular localization of PIP in rice protoplasts, we
579 cloned the 1×FYVE^{HRS}, 1×PH^{FAPP1}, and 1×PH^{PLCΔ1} fragments into the pM999-eGFP vector under control
580 of the CaMV 35S promoter. The resultant constructs were confirmed using Sanger sequencing and
581 transformed into rice protoplasts. Rice protoplast preparation and transformation were performed as
582 described⁶⁷. Fluorescence intensity of PIP was quantified using ImageJ based on the methods
583 described previously⁶². The ratio of the total fluorescence signals to the signals at the plasma
584 membrane was calculated.

585 To generate rice lines stably expressing genetically encoded biosensors for PI(4,5)P₂, we cloned the
586 1×PH^{PLCΔ1} fragment into the pRGV-eGFP vector under control of the maize *Ubiquitin10* promoter⁶³. The
587 resultant vector was verified by sequencing and transformed into Kitaake and *RBL12*, which was further
588 crossed with *rb11*. Confocal laser scanning microscopy was performed using the laser scanning confocal
589 microscopy (Leica TCS SP8). Intactness of the PI(4,5)P₂ biosensor in rice was examined using western
590 blotting as described⁶⁸. Briefly, rice leaf tissues were ground to fine powder with a mortar and pestle in
591 liquid nitrogen and solubilized in the extraction buffer (50 mM Tris-HCl pH 7.5; 150 mM NaCl; 1 mM
592 EDTA; 1% Tritonx-100; 0.5 mM PMSF; 1% protease inhibitor cocktail). The protein extracts were
593 centrifuged at 12,000×g at 4°C, and the supernatant was cleared through a filter (Φ 0.45 μm). We mixed
594 70 μl protein extracts, 10 μl 0.4 M DTT, 20 μl 5×SDS loading buffer and 1 μl β-mercaptoethanol and took
595 20 μl mixed sample to run 10% SDS-PAGE. The blotting was performed on the PVDF membrane (Bio-
596 Rad). The primary antibody was anti-GFP (1:1,000, Cell Signaling Technology) and western blotting was
597 following the manufacturer's instructions. Coomassie brilliant blue (CBB) staining of rice ribulose
598 biphosphate carboxylase/oxygenase (Rubisco) was used as the internal control⁶⁹.

599 To analyze the subcellular localization of rice PI(4,5)P₂ during *M. oryzae* infection, the verified T2 plants
600 were used to observe subcellular locations of PI(4,5)P₂ in rice sheath cells⁷⁰, inoculated with the *M.*
601 *oryzae* ZB25 strains expressing Pwl2-mCherry or Bas4-mCherry. The fluorescence signal was detected
602 using the confocal microscope Nikon N-STORM with the following settings of excitation/emission
603 wavelengths: GFP (488/505 to 530 nm) and mCherry (561/587 to 610 nm).

604 **Genome editing**

605 Genome editing of *RBL1* was conducted using a previously described method⁷¹. Briefly, guide RNAs
606 (gRNAs) for genome editing were selected assisted by an online program CRISPR-Plant⁷². Related
607 primers were designed (Supplementary Table 1) and the gRNA cassette was assembled into vector
608 pBER32 as described⁷¹. After being confirmed using Sanger sequencing, the binary constructs were
609 transformed into embryogenic calli of Kitaake, Nipponbare, and Zhonghua11 using *Agrobacterium-*

610 mediated transformation. The resultant transformants were genotyped using Sanger sequencing, and
611 the sequence was analyzed using DSDecodeM⁷³. The confirmed edited lines were analyzed for plant
612 growth, *RBL* expression, and plant immunity phenotypes.

613 **Field trials of the edited lines**

614 Field yield and resistance to blast were assessed at the experimental stations (Hainan, Hubei, and
615 Jiangxi) with “normal field” (low incidence of rice blast) and blast nursery (high incidence of rice blast) in
616 the summer season, respectively. Enshi (Hubei) was selected because this mountainous area has a
617 high incidence of rice blast disease each year¹⁰. Design of the field plots was conducted following the
618 strategy established by the International Rice Research Institute (IRRI)⁷⁴. For each field trial, plants
619 were grown with either 10 (Hainan) or 5 (Hubei and Jiangxi) replicate plots for each line, and each plot
620 contained 100 plants that were 20 cm apart. Diseased plantlets of the blast susceptible line
621 Lijiangxintuanheigu (LTH) were used as a source of inoculum for spreading the disease⁷³. One row of
622 LTH was sown for every 10 rows of test accessions, and disease was allowed to spread naturally via
623 wind dispersal. In the “normal field”, we did not include spreader row. Rice blast resistance of different
624 lines was evaluated according to the IRRI evaluation system, and the percentage of necrotic panicles
625 due to blast was calculated⁷⁴.

626 **Data availability**

627 Sequencing data for the pooled M3 plants derived from the *rb1* line (FN398) are available at the
628 National Center for Biotechnology Information under the accession number of SRR4096918. Other
629 sequences can be accessed under the following numbers: *RBL1* (LOC_Os01g55360, NP_001044302.1),
630 *OsPIS1* (LOC_Os02g03110, NC_029257.1) and *OsPAH2* (LOC_Os11g40080, XP_015617116.1).

631 **References**

- 632 42 Li, G. *et al.* Genome-wide sequencing of 41 rice (*Oryza sativa* L.) mutated lines reveals diverse
633 mutations induced by fast-neutron irradiation. *Mol Plant* **9**, 1078-1081 (2016).
- 634 43 Jain, R. *et al.* Genome sequence of the model rice variety KitaakeX. *BMC Genom.* **20**, 905 (2019).
- 635 44 Tang, J. *et al.* GDSL lipase occluded stomatal pore 1 is required for wax biosynthesis and stomatal
636 cuticular ledge formation. *New Phytol.* **228**, 1880-1896 (2020).
- 637 45 Park, C. J. & Ronald, P. C. Cleavage and nuclear localization of the rice XA21 immune receptor.
638 *Nat. Commun.* **3**, 920 (2012).
- 639 46 Zhou, X. *et al.* Loss of function of a rice TPR-domain RNA-binding protein confers broad-spectrum
640 disease resistance. *Proc. Natl. Acad. Sci. USA* **115**, 3174-3179 (2018).
- 641 47 Li, G. *et al.* *MST50* is involved in multiple MAP kinase signaling pathways in *Magnaporthe oryzae*.
642 *Environ. Microbiol.* **19**, 1959-1974 (2017).
- 643 48 Li, G. B. *et al.* Overproduction of OsRACK1A, an effector-targeted scaffold protein promoting

644 OsRBOHB-mediated ROS production, confers rice floral resistance to false smut disease without yield
645 penalty. *Mol Plant* **15**, 1790-1806 (2022).

646 49 Li, Q. *et al.* A *Phytophthora capsici* effector targets ACD11 binding partners that regulate ROS-
647 mediated defense response in *Arabidopsis*. *Mol Plant* **12**, 565-581 (2019).

648 50 DeZwaan, T. M., Carroll, A. M., Valent, B. & Sweigard, J. A. *Magnaporthe grisea* Pth11p is a novel
649 plasma membrane protein that mediates appressorium differentiation in response to inductive substrate
650 cues. *Plant Cell* **11**, 2013-2030 (1999).

651 51 Jones, K. *et al.* Disruption of the interfacial membrane leads to *Magnaporthe oryzae* effector re-
652 location and lifestyle switch during rice blast disease. *Front. Cell Dev. Biol.* **9**, 681734 (2021).

653 52 Chen, X. *et al.* An ATPase promotes autophosphorylation of the pattern recognition receptor XA21
654 and inhibits XA21-mediated immunity. *Proc. Natl. Acad. Sci. USA* **107**, 8029-8034 (2010).

655 53 Luu, D. D. *et al.* Biosynthesis and secretion of the microbial sulfated peptide RaxX and binding to
656 the rice XA21 immune receptor. *Proc. Natl. Acad. Sci. USA* **116**, 8525-8534 (2019).

657 54 Fan, J. *et al.* The monocot-specific receptor-like kinase SDS2 controls cell death and immunity in
658 rice. *Cell Host Microbe* **23**, 498-510.e495 (2018).

659 55 Chen, X. *et al.* The 'pears and lemons' protein UvPal1 regulates development and virulence of
660 *Ustilagoideae virens*. *Environ. Microbiol.* **22**, 5414-5432 (2020).

661 56 Fan, J. *et al.* The false smut pathogen *Ustilagoideae virens* requires rice stamens for false smut
662 ball formation. *Environ. Microbiol.* **22**, 646-659 (2020).

663 57 Livak, K. J. & Schmittgen, T. D. Analysis of relative gene expression data using real-time
664 quantitative PCR and the $2^{-\Delta\Delta CT}$ method. *Methods* **25**, 402-408 (2001).

665 58 Haselier, A., Akbari, H., Weth, A., Baumgartner, W. & Frentzen, M. Two closely related genes of
666 *Arabidopsis* encode plastidial cytidinediphosphate diacylglycerol synthases essential for
667 photoautotrophic growth. *Plant Physiol.* **153**, 1372-1384 (2010).

668 59 Durowoju, I. B., Bhandal, K. S., Hu, J., Carpick, B. & Kirkitadze, M. Differential scanning
669 calorimetry - a method for assessing the thermal stability and conformation of protein antigen. *J Vis Exp*
670 (2017).

671 60 Li, Q. *et al.* Understanding the biochemical basis of temperature-induced lipid pathway adjustments
672 in plants. *Plant Cell* **27**, 86-103 (2015).

673 61 Lu, S., Liu, H., Jin, C., Li, Q. & Guo, L. An efficient and comprehensive plant glycerolipids analysis
674 approach based on high-performance liquid chromatography-quadrupole time-of-flight mass
675 spectrometer. *Plant Direct* **3**, e00183 (2019).

676 62 Ito, Y. *et al.* Sphingolipids mediate polar sorting of PIN2 through phosphoinositide consumption at
677 the trans-Golgi network. *Nat. Commun.* **12**, 4267 (2021).

- 678 63 He, F., Zhang, F., Sun, W., Ning, Y. & Wang, G. L. A versatile vector toolkit for functional analysis of
679 rice genes. *Rice (N Y)* **11**, 27 (2018).
- 680 64 Santoni, V. Plant plasma membrane protein extraction and solubilization for proteomic analysis.
681 *Methods Mol. Biol.* **355**, 93-109 (2007).
- 682 65 Yang, H. *et al.* Pore architecture of TRIC channels and insights into their gating mechanism.
683 *Nature* **538**, 537-541 (2016).
- 684 66 Colin, L. *et al.* Imaging the living plant cell: From probes to quantification. *Plant Cell* **34**, 247-272
685 (2022).
- 686 67 Tang, N. *et al.* MODD mediates deactivation and degradation of OsbZIP46 to negatively regulate
687 ABA signaling and drought resistance in rice. *Plant Cell* **28**, 2161-2177 (2016).
- 688 68 Zhai, K. *et al.* NLRs guard metabolism to coordinate pattern- and effector-triggered immunity.
689 *Nature* **601**, 245-251 (2022).
- 690 69 Gutteridge, S. & Gatenby, A. A. Rubisco synthesis, assembly, mechanism, and regulation. *Plant*
691 *Cell* **7**, 809-819 (1995).
- 692 70 Simon, M. L. *et al.* A multi-colour/multi-affinity marker set to visualize phosphoinositide dynamics in
693 Arabidopsis. *Plant J.* **77**, 322-337 (2014).
- 694 71 Xie, K., Minkenberg, B. & Yang, Y. Boosting CRISPR/Cas9 multiplex editing capability with the
695 endogenous tRNA-processing system. *Proc. Natl. Acad. Sci. USA* **112**, 3570-3575 (2015).
- 696 72 Minkenberg, B., Zhang, J., Xie, K. & Yang, Y. CRISPR-PLANT v2: an online resource for highly
697 specific guide RNA spacers based on improved off-target analysis. *Plant Biotechnol. J.* **17**, 5-8 (2019).
- 698 73 Xie, X. *et al.* CRISPR-GE: a convenient software toolkit for CRISPR-based genome editing. *Mol*
699 *Plant* **10**, 1246-1249 (2017).
- 700 74 I.R.R.I. Standard evaluation system for rice (SES). *pp*, 17-18 (2002).

701 **Acknowledgements**

702 We thank G. Wang (Ohio State University) and Y. Ning (Chinese Academy of Agricultural Sciences) for
703 pRGV and pRHV vectors, and X. Chen (Sichuan Agricultural University) for *M. oryzae* stains, and Z.
704 Wang (Fujian Agriculture and Forestry University) for PwI2-mCherry marker, and W. Zhao (China
705 Agricultural University) and L. Cao (China National Rice Research Institute) for rice *spl-D* and *cul3a*
706 mutants, respectively, and H. Xue (Shanghai Jiao Tong University) for Arabidopsis *cds* mutants, and P.
707 Fei (Huazhong University of Science and Technology) for technical support on confocal imaging, and G.
708 Ren (Sichuan Academy of Agricultural Sciences) for field trials. At Huazhong Agricultural University, we
709 thank H. Hu for the pEarleyGate101 vector and HDEL-mCherry markers, D. Duanmu for the pYES2-
710 NTA vectors, and W. Chen for total salicylic acid (SA) analysis, and C. Luo, M. Yuan, and Z. Lai for *U.*
711 *virens* and *Xoo* strains and Arabidopsis lines. The phospholipid analysis was performed on the

712 lipidomics platform of the National Key Laboratory of Crop Genetic Improvement. Phosphoinositides
713 measurements were performed on the Bordeaux Metabolome Facility-MetaboHUB (ANR-11-INBS-
714 0010). Confocal laser scanning microscope data were acquired at the State Key Laboratory of
715 Agricultural Microbiology Core Facility, and we would be grateful to Z. Hu and X. Shen for their supports
716 for data acquisition and analysis. The computation in this paper was run on the bioinformatics computing
717 platform of the National Key Laboratory of Crop Genetic Improvement. We thank J. Zhou (CAS Institute
718 of Genetics and Developmental Biology), X. Chen, Z. He (CAS Center for Excellence in Molecular Plant
719 Sciences), X. Wang (Northwest A&F University), and J.R. Xu (Purdue University) for discussion. This
720 work was supported by National Key R&D Program of China (2022YFA1304402), Natural Science
721 Foundation of China (32172373, 31801723), Fundamental Research Funds for the Central Universities
722 (2662020ZKPY006) and the Open Research Fund of State Key Laboratory of Hybrid Rice (Wuhan
723 University) (KF202202) to G.L. J.C.M. is supported by the Joint Bioenergy Institute funded by the US
724 Department of Energy (no. DE-AC02-05CH11231). Research in the Ronald Laboratory was supported
725 by the National Science Foundation, the National Institutes of Health (GM122968 and GM55962), and
726 the Joint Bioenergy Institute funded by the US Department of Energy (no. DE-AC02-05CH11231).

727 **Author contributions**

728 G.L., G.S., P.S., and P.C.R. designed the experiments. G.S., P.S., X.K., X.H., Q.S., L.F., Y.B., J.Z., Y.L.,
729 L.Y., Y.W., Q.G., Y.Z., W.Z., J.G., R.H., X.C., W.Z., Z.Q., and Q.Z. performed the experiments. G.L.,
730 G.S., P.S., X.K., X.H., L.Y., L.Z., K.X., Q.Z., T.C., J.X., R.J., J.G., Q.L., L.G., J.C.M., L.F., Y.B., and Z.K.
731 analyzed the data. G.L. and G.S. drafted the manuscript, and G.L., G.S., P.S., L.F., L.Z., L.G., K.X.,
732 J.C.M., Q.L., Y.B., Z.K., and P.C.R. revised the manuscript. All authors read and approved the final
733 manuscript.

734 **Competing interests**

735 G.L., G.S. and X.H. are inventors on a provisional patent application 202111041400.3 that covers *rb1*
736 and *RBL12* lines.

737 **Reporting summary**

738 Further information on research design is available in the Nature Research Reporting Summary linked
739 to this article.

740 **Additional information**

741 **Supplementary information** is available for this paper at <https://>

742 **Correspondence and requests for materials** should be addressed to P.C.R. and G.L.

743 **Reprints and permissions information** is available at www.nature.com/reprints.

744

745

746 **Extended data figure legends**

747 **Extended Data Fig. 1 | The plant glycerolipid metabolic pathway related to cytidinediphosphate-**
748 **diacylglycerol synthase 1 (CDS1).**

749 Rice RBL1 is homologous to yeast Cds1. CDP-DAG, cytidinediphosphate-diacylglycerol; DAG,
750 diacylglycerol; PA, phosphatidic acid; PAH, phosphatidic acid phosphohydrolase; PC,
751 phosphatidylcholine; PE, phosphatidylethanolamine; PG, phosphatidylglycerol; PGPS,
752 phosphatidylglycerol phosphate synthase; PI, phosphatidylinositol; PI4K, phosphatidylinositol 4-kinases;
753 PI4P, phosphatidylinositol 4-phosphate; PI4P5K, phosphatidylinositol 4-phosphate 5-kinase; PI(4,5)P₂,
754 phosphatidylinositol-4,5-bisphosphate; PIS, phosphatidylinositol synthase; PS, phosphatidylserine; PSS,
755 phosphatidylserine synthase.

756 **Extended Data Fig. 2 | Expression of plant defense-related genes, yield, and genetic**
757 **complementation of the *rb1* line.**

758 **a**, Panicles and seeds of the *rb1* and WT lines. Bars, 1 cm. Grain yield of the *rb1* and WT lines. Data
759 are displayed as box and whisker plots with individual data points. The box plot elements are: center line,
760 median; box limits, 25th and 75th percentiles. **b**, *In situ* detection of reactive oxygen species (ROS) in
761 the *rb1* mutant and wild-type (WT, KitaakeX) leaves using 3,3'-diaminobenzidine (DAB) staining. Bar,
762 1 cm. **c**, The total salicylic acid (SA) level is increased in the *rb1* mutant. Total SA was isolated from
763 leaves of 2-week-old seedlings. **d**, qRT-PCR assays of marker genes of plant immunity. Total RNA was
764 extracted from leaves of 4-week-old plants. Gene *Actin* was used as the internal control. **e**, A 29-bp
765 deletion cosegregates with the lesion mimic phenotype in the M3 population of line *rb1*. PCR results of
766 InDel markers targeting the 29-bp deletion: one short band, homozygous; one large band, wild-type
767 alleles; two bands, heterozygous. "+" indicates lesions on the leaf of the M3 plant and "-" no lesion. A χ^2
768 test of the phenotypic ratio revealed that the actual value 26: 92 of lesioned plants to normal plants is
769 statistically similar to the expected value 1: 3 ($\chi^2 = 0.213$, P-value = 0.644 > 0.05). **f**, Complementation
770 assays. Genotyping of the T0 lines using Cleaved Amplified Polymorphic Sequences (CAPS) markers.
771 Leaves were photographed at 21 days post sowing (dps). For results of agarose gel electrophoresis,
772 one band indicates the *rb1* mutant and three bands a complementation line. Bar, 1 cm. **g**, qRT-PCR
773 assays of *RBL1* in the WT, *rb1*, and complementation lines. Complementation line 10 was used as
774 CoR1 in Figure 1. Gene *Actin* was used as the internal control. Bars in **(c)**, **(d)**, and **(g)** indicate standard
775 deviations, and asterisks indicate significant differences compared to the WT using the unpaired
776 Student's *t*-test (**P* < 0.05, ***P* < 0.01, ****P* < 0.001, *****P* < 0.0001).

777 **Extended Data Fig. 3 | Expression assays of *RBL1*.**

778 **a**, qRT-PCR assays of *RBL1* in different tissues of the wild-type (WT, Kitaake) plants at the flowering
779 stage. **b**, qRT-PCR assays of *RBL1* in response to rice blast at the seedling stage of Kitaake. Kitaake

780 plants spray-inoculated with *M. oryzae* strain ZB25 were used in the assay. **c**, Tissue-specific
781 expression of *RBL1* visualized by staining for the β -glucuronidase (GUS) activity under control of the
782 *RBL1* promoter in the reporter line. For numbers: 1, seedling; 2 and 3, root; 4, stem; 5, shoot apical
783 meristem; 6, leaf; 7, stamen; 8, pistil; 9, premilk stage; 10, panicle; 11, maturity stage. Bars in 1, 4, and 7,
784 5 mm; bars in 2, 3, 5, 6, and 8 to 11, 1 mm. Bars indicate standard deviations. Significant differences
785 indicated by different letters were calculated using the Duncan's new multiple range test.

786 **Extended Data Fig. 4 | The *Arabidopsis thaliana cds* mutants show enhanced resistance to**
787 ***Phytophthora capsica*.**

788 **a**, Phylogenetic analysis of RBL1 homologs from plants and other organisms. The phylogenetic tree was
789 constructed using MEGA10. Accession numbers for different RBL1 homologs: *Arabidopsis thaliana*
790 (NP_176433.2), *Beta vulgaris subsp. vulgaris* (XP_010694835.1), *Brachypodium distachyon*
791 (XP_003564318.1), *Brassica rapa* (RID78417.1), *Chenopodium quinoa* (XP_021731901.1),
792 *Chlamydomonas reinhardtii* (PNW85433.1), *Glycine max* (XP_003556374.1), *Gossypium barbadense*
793 (KAB2026876.1), *Homo sapiens* (NP_001254.2), *Hordeum vulgare* (KAE8818711.1), *Mus musculus*
794 (NP_775546.2), *Oryza sativa* (NC_029256.1), *Saccharomyces cerevisiae* (AJQ02739.1),
795 *Schizosaccharomyces pombe* (NP_596416.1), *Sorghum bicolor* (KAG0539475.1), *Triticum aestivum*
796 (KAF7023922.1), and *Zea mays* (NP_001132909.1). **b**, Protein domain analysis of RBL1 homologs from
797 various organisms. Conserved domains in RBL1 homologs were predicted using the Evolve program.
798 CTP_transf_1, phosphatide cytidyltransferase. **c**, Amino acid alignment of the 19 residues that are
799 truncated in the *rb1* line. The consensus is shown at the bottom. **d**, The *cds* mutant and the wild-type
800 (WT, Col-0, *A. thaliana*) plants at 28 days post sowing (dps). Bar, 1 cm. **e**, qRT-PCR assays. Total RNA
801 was extracted from leaves of 4-week-old plants. **f**, Leaf length of the WT and *cds* mutant lines at 28 dps.
802 **g-i**, Infected leaves (**g**), lesion area (**h**), and relative quantification of pathogen biomass (**i**) of inoculated
803 WT and *cds* lines at 36 hours post-inoculation (hpi) with *Phytophthora capsica* strain LT263. Bar, 1 cm.
804 Data are displayed as box and whisker plots with individual data points. The box plot elements are:
805 center line, median; box limits, 25th and 75th percentiles. Significant differences indicated by different
806 letters were calculated using the Duncan's new multiple range test.

807 **Extended Data Fig. 5 | Exogenous supplementation of PI delays lesion formation in *rb1*.**

808 **a**, Lesion formation was suppressed in the *rb1* but not *cul3a* or *spl-D* mutants. Plants were grown on the
809 1/2 MS media supplemented with PI. WT, the wild-type Kitaake. Photographs were taken from 12-day-
810 old *rb1*, 2-week-old *cul3a*, and 2-week-old *spl-D* plants with corresponding control lines. Bar, 1 cm. **b**,
811 Lesion formation in the *rb1* mutant was not affected by application of exogenous PG. Plants were grown
812 on the 1/2 MS media supplemented with PG. Photographs were taken from 12-day-old plants. Bar, 1 cm.
813 **c**, Lesion formation in the *rb1* mutant was enhanced with exogenous application of PI(4,5)P₂. Plants

814 were grown on the 1/2 MS media supplemented with PI(4,5)P₂. Photographs were taken from 10-day-
815 old plants. Bar, 1 cm. **d**, Exogenous PA enhances lesion formation in *rb1* and leaf tip necrosis in WT.
816 Bar, 1 cm. **e**, Lesion formation in *rb1* was suppressed by exogenous diphenyleneiodonium chloride
817 (DPI). Plants were grown on the 1/2 MS media supplemented with DPI. Photographs were taken of 10-
818 day-old plants. Bar, 1 cm. Bars indicate standard deviations, and asterisks indicate significant
819 differences compared to the mock using the unpaired Student's *t*-test (**P* < 0.05, ***P* < 0.01, ****P* <
820 0.001, *****P* < 0.0001).

821 **Extended Data Fig. 6 | Design of gRNA multiplexing in genome editing of *RBL1* and field trials.**

822 **a**, Gene structure of *RBL1* and the site targeted by each numbered guide RNA (gRNA) for genome
823 editing. **b**, Map and cloning sites of the CRISPR/Cas9 vector pRGEB32 used in genome editing (left);
824 vectors with different gRNAs (right). **c**, Sequences of gRNAs designed using CRISPR-P 2.0. Purple
825 letters indicate protospacer-adjacent motif sites (PAMs). **d**, A schematic diagram of co-transformation of
826 different constructs and genotyping of T0 lines. Edited sites in each T0 plant were identified using
827 Sanger sequencing and agarose gel electrophoresis. WT, the wild-type Kitaake. **e**, Design of the normal
828 field plots. **f**, Design of the field plots in the rice blast nursery. WT, the wild-type Kitaake; *RBL12*, the
829 edited line; LTH, the very susceptible rice variety Lijiangxintuanheigu, which was used as the spreader
830 line for rice blast. Each plot contains 100 plants 0.2 m apart. **g**, Identification of transgene-free T1 plants
831 of *RBL12*. Primers specific to the *Cas9*, *hph* and *Actin* genes, respectively, were used in genotyping.
832 The *hph* gene encoding a hygromycin B phosphotransferase confers hygromycin resistance for rice
833 transgenic lines. The amplicon of the *Actin* gene was used as the DNA quality control. WT, Kitaake. **h**.
834 Agronomic traits of the *RBL12* and Kitaake lines. Data for each agronomic trait were collected from 50
835 plants for each line that was grown in the normal paddy field. In the box and whisker plots, dots indicate
836 individual data points, and the error bars represent maximum and minimum values. Center line, median;
837 box limits, 25th and 75th percentiles. Asterisks indicate significant differences using the unpaired
838 Student's *t*-test (****P* < 0.001).

839 **Extended Data Fig. 7 | Systematic characterization of the *RBL12* line and the allele.**

840 **a**, Sanger sequencing of the edited site indicated by the arrow in the *RBL12* line with the wild-type (WT,
841 Kitaake) as the reference. The PAM site was shown in blue, and the dashed line represents the 12-bp
842 deletion. **b**, Amino acid sequence alignment of RBL1 homologs around the four residues (underlined)
843 that are truncated in the *RBL12* line. Highlighted are conserved residues in the RBL1 homologs. **c**, ROS
844 generation in the WT, *RBL12*, Nipponbare (Nip), LTH, and R498 rice plants challenged with chitin at the
845 booting stage. RLU, relative light unit. **d**, qRT-PCR assays of *RBL1* expression in different tissues of the
846 WT, *RBL12*, and *rb1* plants at the flowering stage. **e**, qRT-PCR assays of heterologous expression of
847 *RBL1* in yeast. Yeast 18s rRNA was used as the internal control. **f**, Immunoblotting analysis of RBL1-,

848 *rb1*-, and RBL12-6×His fusion proteins in yeast. Ponceau S staining indicates the protein loading. WT,
849 yeast strain BY4741; other strains are transformants of the yeast *cds1* mutant carrying pYES2-*RBL1*,
850 pYES2-*rb1*, and pYES2-*RBL12*, respectively. **g**, Stability of the RBL1- and RBL12-6×His fusion proteins
851 analyzed using differential scanning calorimetry (DSC). **h**, Subcellular localization of the RBL1- and
852 RBL12-GFP fusion proteins transiently expressed in *Nicotiana benthamiana* leaf epidermal cells,
853 analyzed together with the endoplasmic reticulum marker HDEL-mCherry. Bars, 25 μm. **i**, RBL1-GFP
854 rescues the growth defect of yeast *cds1*. WT, yeast strain BY4741; R1G, the yeast *cds1* mutant carrying
855 pYES2-*RBL1*-GFP. Strains were cultured on YPGal or YPD plates at 30°C for 3 days before sampling.
856 Immunoblotting analysis of the RBL1-GFP fusion protein in the yeast strain R1G that forms a
857 homodimer. CBB staining indicates the protein loading. **j**, 9-week-old WT, *RBL12*, and complemented
858 T1 plants. The white asterisk indicates the spontaneous lesion in the insets. Bar, 10 cm. Shown on the
859 right are qRT-PCR assays of *RBL1* in the WT, *RBL12*, and CoR1-*RBL12* lines. Gene *Actin* was used as
860 the internal control. **k**, Punch inoculation of the WT, *RBL12*, and CoR1-*RBL12* lines with *M. oryzae*. The
861 lesion area was measured at 14 dpi. Bar, 1 cm. **l**, Leaves of 3-week-old WT, *rb1*, *RBL12*, and F1 plants
862 of *rb1* crossed with *RBL12*. Bar, 1 cm. **m**, The WT, *RBL12*, and F2 plants derived from the WT line
863 crossed with *RBL12* at 60 dps. Spontaneous lesions-indicated by white asterisks-formed on the top
864 leaves of homozygous *RBL12* lines. Bars, 10 cm. **n**, Punch inoculation assays of the WT, *RBL12*, and
865 F2 plants with *M. oryzae*. The lesion area was measured at 14 dpi. Bar, 1 cm. **o**, qRT-PCR assays of
866 *RBL1* in the WT, *RBL12* and F2 plants at the tillering stage. **p**, WT and *RBL12* transgenic plants
867 expressing the PI(4,5)P₂ biosensor at 32 hpi with *M. oryzae* strain ZB25 expressing the cytoplasmic
868 effector Pwl2 tagged with mCherry. BIC, biotrophic interfacial complex; EIHM, extra-invasive hyphal
869 membrane; IH, invasive hyphae. Bar, 10 μm. **q**, BIC formation in plants shown in **(r)**. **r**, Membrane lipid
870 composition analysis of the WT, *RBL12*, and *rb1* lines. DW, dry weight. **s**, PIP and PIP₂ content in the
871 WT, *RBL12*, and *rb1* lines. The box plot elements are: center line, median; box limits, 25th and 75th
872 percentiles. Bars in **(e)**, **(j)**, **(q)**, **(r)**, and **(s)** indicate standard deviations, and asterisks in **(e)** and **(q)**
873 indicate significant differences using the unpaired Student's *t*-test (***P* < 0.01). Significant differences
874 indicated by different letters in **(d)**, **(j)**, **(k)**, **(n)**, **(o)**, **(r)**, and **(s)** were calculated using the Duncan's new
875 multiple range test.

876 **Extended Data Fig. 8 | Genome editing of *RBL1* enhances disease resistance in two other rice**
877 **cultivars.**

878 **a**, Lesion mimic phenotypes and enhanced resistance to *M. oryzae* in *RBL1*-edited Nipponbare (Nip)
879 lines. Infected leaves and lesion area of punch-inoculated *RBL1*-edited lines with *M. oryzae* at 14 dpi.
880 Bar, 1 cm. **b**, 12-week-old *RBL1*-edited Nipponbare lines. Bar, 10 cm. **c**, qRT-PCR assays of *RBL1* and
881 plant defense-related genes *OsPR8* and *OsPR10* in the *RBL1*-edited Nipponbare lines. Total RNA was

882 extracted from 4-week-old leaves. The *Actin* gene was used as the internal control. **d-f**, Similar assays
883 as shown in (**a-c**) were performed on one local rice cultivar Zhonghua11 (ZH11). **g**, Sanger sequencing
884 of the edited sites, indicated by arrows, in *nr-7* and *zr-7* lines, with the wild-type (WT, Kitaake) as the
885 reference. The mutated nucleotides are shown in gray (deletion) and blue (insertion). **h**, Amino acid
886 sequence alignment of the region mutated in lines *nr-7* and *zr-7*. The four amino acids truncated in
887 RBL12 are indicated by asterisks. Shaded are conserved residues in the RBL1 homologs. Two amino
888 acids are truncated in *nr-7*, with the first one overlapping the truncated region in RBL12. An 84-bp
889 frameshift mutation caused by a 1-bp deletion followed by a 1-bp insertion alters the sequence of 28
890 amino acids (gray) in *zr-7*, with the first two overlapping the truncated region in RBL12. Bars indicate
891 standard deviations, and asterisks indicate significant differences compared to the WT using the
892 unpaired Student's *t*-test ($***P < 0.001$, $****P < 0.0001$). Significant differences indicated by different
893 letters in (**c**) and (**f**) were calculated using the Duncan's new multiple range test.

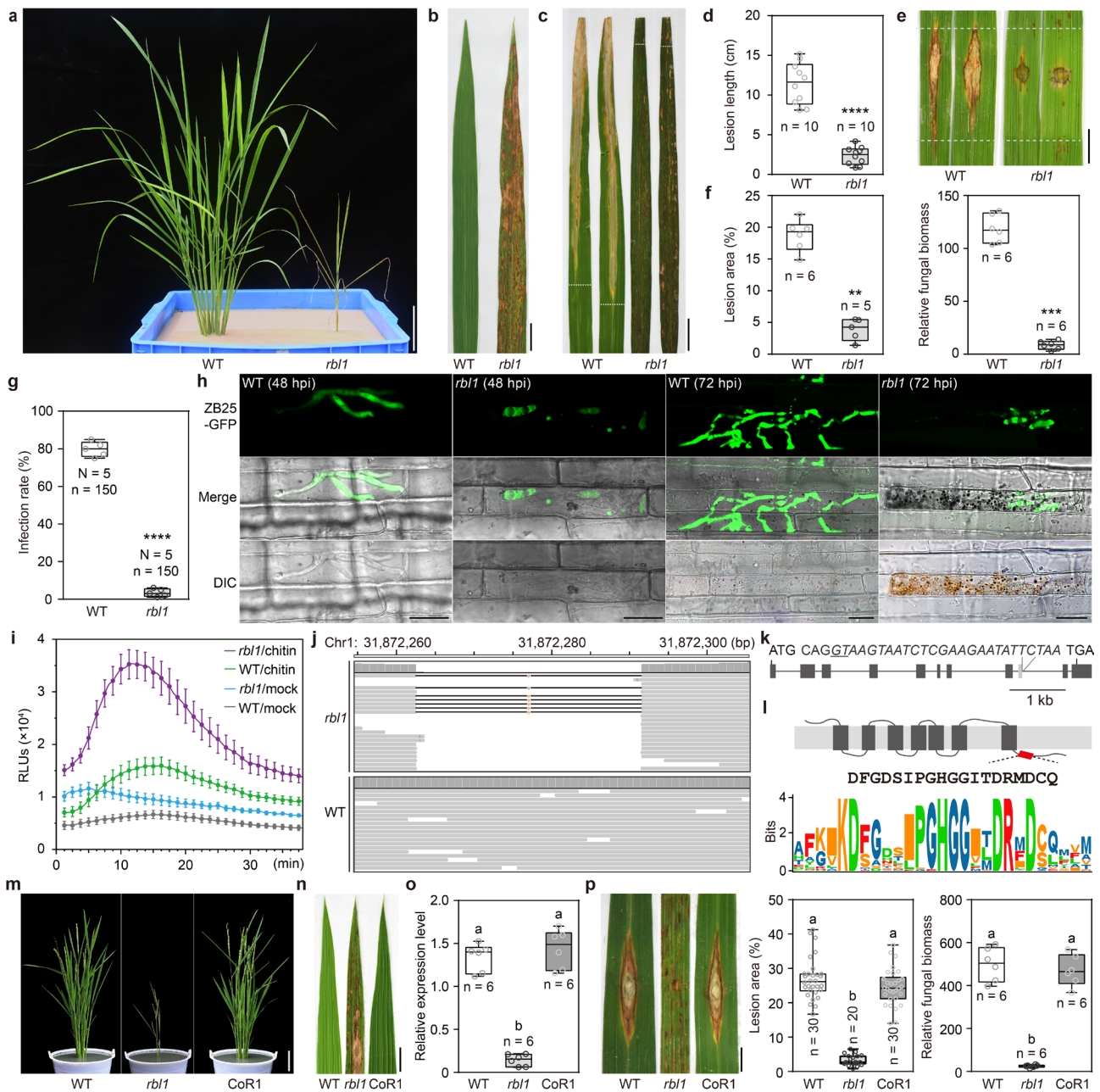

Fig.1 | Cloning of the *RBL1* gene from the lesion mimic mutant *rbl1*, which has enhanced immunity.

a, *rbl1* mutant and wild-type (WT, KitaakeX) plants at 40 days post sowing (dps). Bar, 10 cm. **b**, Spontaneous lesions. Bar, 1 cm, which is the same for other panels without specifications. **c**, Inoculation of rice lines with *Xoo* at 14 days post-inoculation (dpi) and lesion length (**d**). **e**, Punch inoculation with *M. oryzae* at 14 dpi. The dashed lines indicate the leaf area covered by aluminum foil before spontaneous lesions appeared. **f**, Lesion area and relative fungal biomass. **g**, Fungal infection rates at 72 hours post-inoculation level. **h**, Rice sheath cells infected by eGFP-tagged *M. oryzae* strain ZB25. Bars, 25 μ m. **i**, ROS generation in rice plants challenged with chitin and water (mock). **j**, Screenshot of the 29-bp deletion in *rbl1*. **k**, Gene structure of *RBL1*. The gray box indicates the exon skipped in *rbl1*. The sequence of the deletion is shown, and the intron sequence is italic with the intron recognition site "GT" underlined. **l**, The predicted secondary structure of *RBL1*. The red box indicates the truncation. The CDS signature motif is shown at the bottom. **m**, 10-week-old

12 WT, *rb11*, and complemented (CoR1) plants. Bar, 10 cm. **n**, Leaves of the lines in **(m)**. **o**, qRT-PCR assays of *RBL1*. **p**,
13 Infected leaves, lesion area and relative fungal biomass of rice lines with *M. oryzae* at 14 dpi. Data are displayed as box
14 and whisker plots with individual data points: center line, median; box limits, 25th and 75th percentiles. Asterisks indicate
15 significant differences using the unpaired Student's *t*-test (***P* < 0.01, ****P* < 0.001, *****P* < 0.0001). Significant differences
16 indicated by different letters in **(o)** and **(p)** were calculated using the Duncan's new multiple range test.

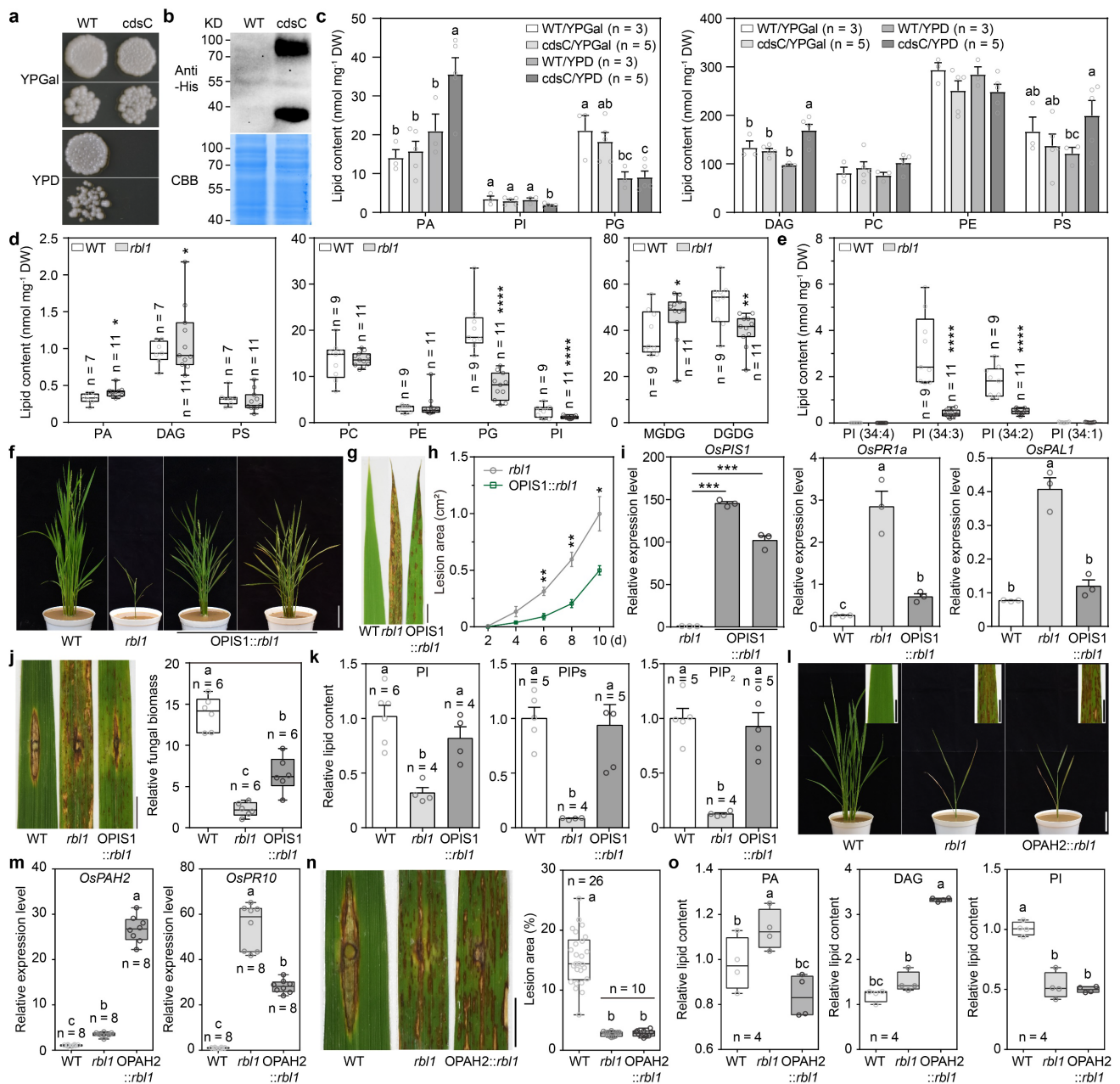
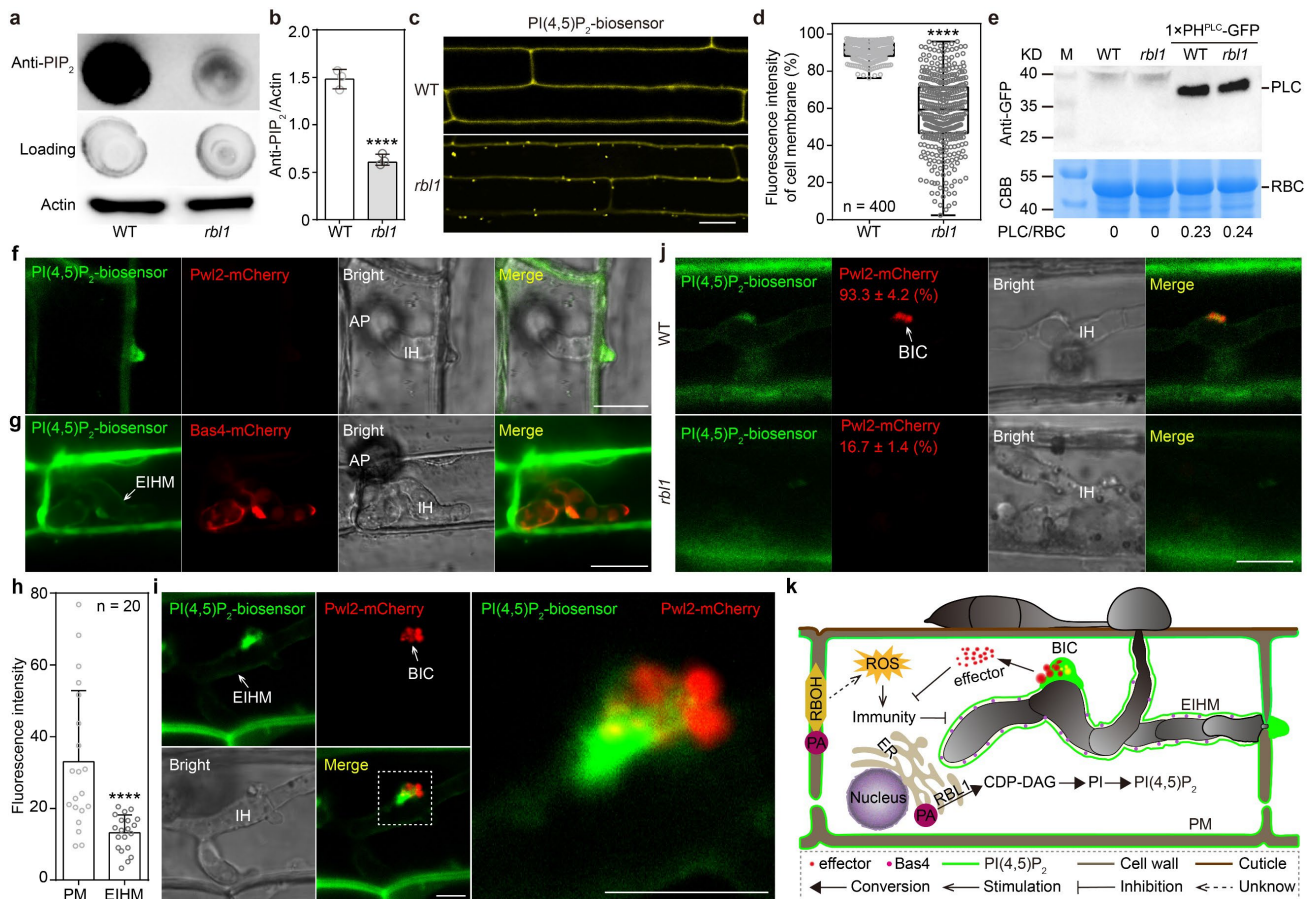

Fig.2 | RBL1 functions as a CDP-DAG synthase.

a, *RBL1* rescues the growth defect of the yeast *cds1* mutant. WT, yeast strain BY4741; *cdsC*, yeast mutant *cds1* expressing *RBL1*. **b**, Immunoblotting analysis of the *RBL1*-6×His fusion protein (monomeric and dimeric states). CBB, Coomassie brilliant blue. **c**, Lipidomics assays of yeast strains cultured in YPGal or YPD. **d**, Lipidomic analysis of the 4-week-old wild-type (WT, Kitaake) and *rbl1* lines. DW, dry weight. **e**, Fatty acid species of PI. No alterations were detected between WT and *rbl1* for fatty acid species 36:1 to 36:6. **f**, 8-week-old T1 plants of the *OsPIS1* overexpression *OPIS1::rbl1* lines. Bar, 10 cm. **g**, Lesions on new rice leaves. Bar, 1 cm. **h**, Lesion area of the lines in (**g**). **i**, qRT-PCR assays of genes in the *OPIS1::rbl1* line. **j**, Punch inoculation with *M. oryzae* and relative fungal biomass at 14 dpi. Bar, 1 cm. **k**, PI, PIP, and PIP₂ assays. **l**, 8-week-old plants. *OPAH2::rbl1*, the *rbl1* line overexpressing *OsPAH2*. Black bar, 1 cm; white bar, 10 cm. **m**, qRT-PCR assays. **n**, Punch inoculation with *M. oryzae* and the lesion area at 14 dpi. Bar, 1 cm. **o**,

28 Lipidomics assays of different rice lines. The box plot elements are: center line, median; box limits, 25th and 75th
29 percentiles. Bars in (c), (h), (i), and (k) indicate standard deviations, and asterisks in (d), (e), (h), and (i) indicate
30 significant differences using the unpaired Student's *t*-test (**P* < 0.05, ***P* < 0.01, ****P* < 0.001, *****P* < 0.0001). Significant
31 differences indicated by different letters in (c), (i), (j), (k), (m), (n), and (o) were calculated using the Duncan's new
32 multiple range test.
33



34

35 **Fig. 3 | PI(4,5)P₂, enriched in infection-specific structures, is reduced in *rbl1* plants.**

36 **a**, Dot blotting of membrane PIP₂ in the wild-type (WT, Kitaake) and *rbl1* lines. **b**, The relative levels of membrane PIP₂. **c**,
37 Epidermal cells of rice lines expressing the PI(4,5)P₂ biosensor. Bar, 25 μm. **d**, Relative fluorescence intensity of the
38 PI(4,5)P₂ biosensor in (c). The box plot elements are: center line, median; box limits, 25th and 75th percentiles. **e**,
39 Immunoblotting of the PI(4,5)P₂ biosensor in (c). PLC, the biosensor; RBC, ribulose-1,5-bis-phosphate
40 carboxylase/oxygenase. **f**, PI(4,5)P₂ aggregates around the infectious hyphal tip of *M. oryzae* at 22 hpi. AP, appressorium;
41 IH, invasive hyphae. Pwl2 is a cytoplasmic effector, a biomarker for the biotrophic interfacial complex (BIC). **g**, Rice cells
42 of the WT expressing the PI(4,5)P₂ biosensor infected by the *M. oryzae* strain expressing the apoplastic effector Bas4
43 tagged with the mCherry protein at 27 hpi. EIHM, extra-invasive hyphal membrane. Bar, 10 μm. **h**, Fluorescence intensity
44 of the plasma membrane (PM) and EIHM shown in (g). **i**, PI(4,5)P₂ and Pwl2 at the BIC at 32 hpi. The inset shows the
45 enlarged BIC. Bars, 5 μm. **j**, BIC formation in different rice lines. Bar, 10 μm. The numbers represent the BIC formation
46 rates from 150 infected cells. **k**, Working model of RBL1 in rice resistance to *M. oryzae*. RBL1 is important for the
47 biosynthesis of PI and PIPs including PI(4,5)P₂. As *M. oryzae* invades, PI(4,5)P₂ is recruited to the EIHM and enriched in
48 BIC. Accumulation of PA is a minor factor of enhanced immunity of *rbl1*. Other unknown factors also contribute to
49 enhanced immunity of *rbl1*. Bars in (b) and (h) indicate standard deviations, and asterisks indicate significant differences
50 using the unpaired Student's *t*-test (*****P* < 0.0001).

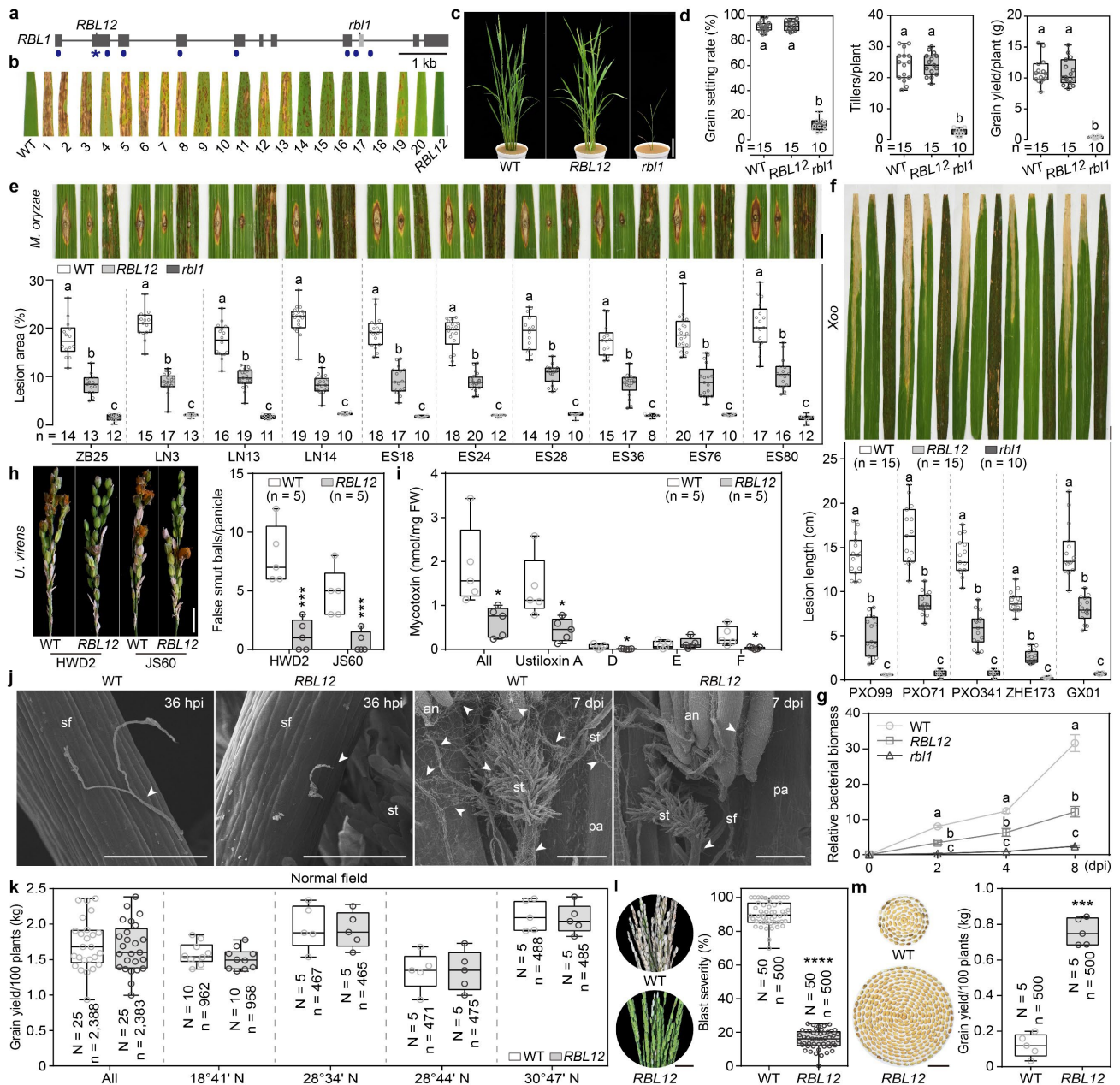

51

52

Fig.4 | *RBL12* confers broad-spectrum resistance with no observed yield penalty in field trials.

53

a, Guide RNA sites, indicated by dots, for genome editing of *RBL1*. The asterisk indicates the edited site in *RBL12*. **b**,

54

RBL1 edited lines. WT, Kitaake. Bar, 1 cm, which is the same for other panels without specifications. **c**, 8-week-old plants

55

in the greenhouse. Bar, 10 cm. **d**, Agronomic traits. **e**, Lesions with *M. oryzae* at 14 dpi. **f**, Lesions with *Xoo* at 14 dpi. **g**, *In*

56

planta bacterial growth of *Xoo* strain PXO99. **h**, Infected panicles with *U. virens*. Rice false smut balls were counted at 17

57

dpi. **i**, Quantitative assays of ustiloxins in infected panicles. FW, fresh weight. **j**, Infected spikelets with *U. virens*. Arrows

58

indicate invasive hyphae. an, anther; pa, palea; sf, stamen filament; st, stigma. Bars, 100 μ m. **k**, Rice grain yield in the

59

"Normal" field trials with low incidence of rice blast. **l**, Field assessment of blast resistance in the blast nursery.

60

Representative panicles are shown on the left. Disease severity is indicated by the percentage of necrotic panicles for

61

each plant caused by *M. oryzae*. **m**, Grain yield of plants grown in the blast nursery. Seeds per plant are shown on the left.

62 The box plot elements are: center line, median; box limits, 25th and 75th percentiles. Asterisks in **(h)**, **(i)**, **(l)**, and **(m)**
63 indicate significant differences using the unpaired Student's *t*-test ($*P < 0.05$, $***P < 0.001$, $****P < 0.0001$). Significant
64 differences indicated by different letters in **(d-g)** were calculated using the Duncan's new multiple range test.
65

66 **Extended Data**

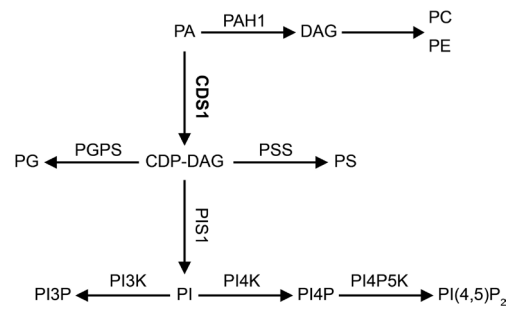

67

68 **Extended Data Fig. 1 | The plant glycerolipid metabolic pathway related to cytidinediphosphate-diacylglycerol**
69 **synthase 1 (CDS1).**

70 Rice RBL1 is homologous to yeast Cds1. CDP-DAG, cytidinediphosphate-diacylglycerol; DAG, diacylglycerol; PA,
71 phosphatidic acid; PAH, phosphatidic acid phosphohydrolase; PC, phosphatidylcholine; PE, phosphatidylethanolamine;
72 PG, phosphatidylglycerol; PGPS, phosphatidylglycerol phosphate synthase; PI, phosphatidylinositol; PI4K,
73 phosphatidylinositol 4-kinases; PI4P, phosphatidylinositol 4-phosphate; PI4P5K, phosphatidylinositol 4-phosphate 5-
74 kinase; PI(4,5)P₂, phosphatidylinositol-4,5-bisphosphate; PIS1, phosphatidylinositol synthase; PS, phosphatidylserine;
75 PSS, phosphatidylserine synthase.

76

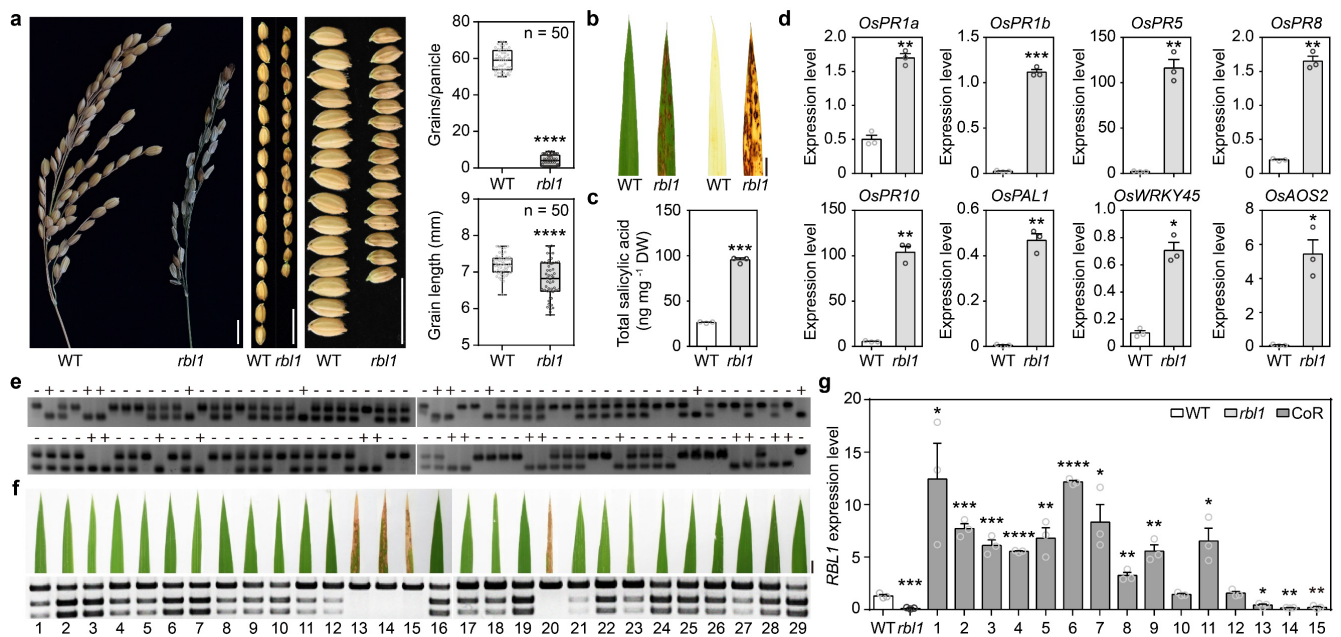

77

78

Extended Data Fig. 2 | Expression of plant defense-related genes, yield, and genetic complementation of the *rbl1* line.

79

80

a, Panicles and seeds of the *rbl1* and WT lines. Bars, 1 cm. Grain yield of the *rbl1* and WT lines. Data are displayed as box and whisker plots with individual data points. The box plot elements are: center line, median; box limits, 25th and 75th percentiles. **b**, *In situ* detection of reactive oxygen species (ROS) in the *rbl1* mutant and wild-type (WT, KitaakeX) leaves using 3,3'-diaminobenzidine (DAB) staining. Bar, 1 cm. **c**, The total salicylic acid (SA) level is increased in the *rbl1* mutant. Total SA was isolated from leaves of 2-week-old seedlings. **d**, qRT-PCR assays of marker genes of plant immunity. Total RNA was extracted from leaves of 4-week-old plants. Gene *Actin* was used as the internal control. **e**, A 29-bp deletion cosegregates with the lesion mimic phenotype in the M3 population of line *rbl1*. PCR results of InDel markers targeting the 29-bp deletion: one short band, homozygous; one large band, wild-type alleles; two bands, heterozygous. "+" indicates lesions on the leaf of the M3 plant and "-" no lesion. A χ^2 test of the phenotypic ratio revealed that the actual value 26: 92 of lesioned plants to normal plants is statistically similar to the expected value 1: 3 ($\chi^2 = 0.213$, P -value = 0.644 > 0.05). **f**, Complementation assays. Genotyping of the T0 lines using Cleaved Amplified Polymorphic Sequences (CAPS) markers. Leaves were photographed at 21 days post sowing (dps). For results of agarose gel electrophoresis, one band indicates the *rbl1* mutant and three bands a complementation line. Bar, 1 cm. **g**, qRT-PCR assays of *RBL1* in the WT, *rbl1*, and complementation lines. Complementation line 10 was used as CoR1 in Figure 1. Gene *Actin* was used as the internal control. Bars in (c), (d), and (g) indicate standard deviations, and asterisks indicate significant differences compared to the WT using the unpaired Student's *t*-test (* $P < 0.05$, ** $P < 0.01$, *** $P < 0.001$, **** $P < 0.0001$).

96

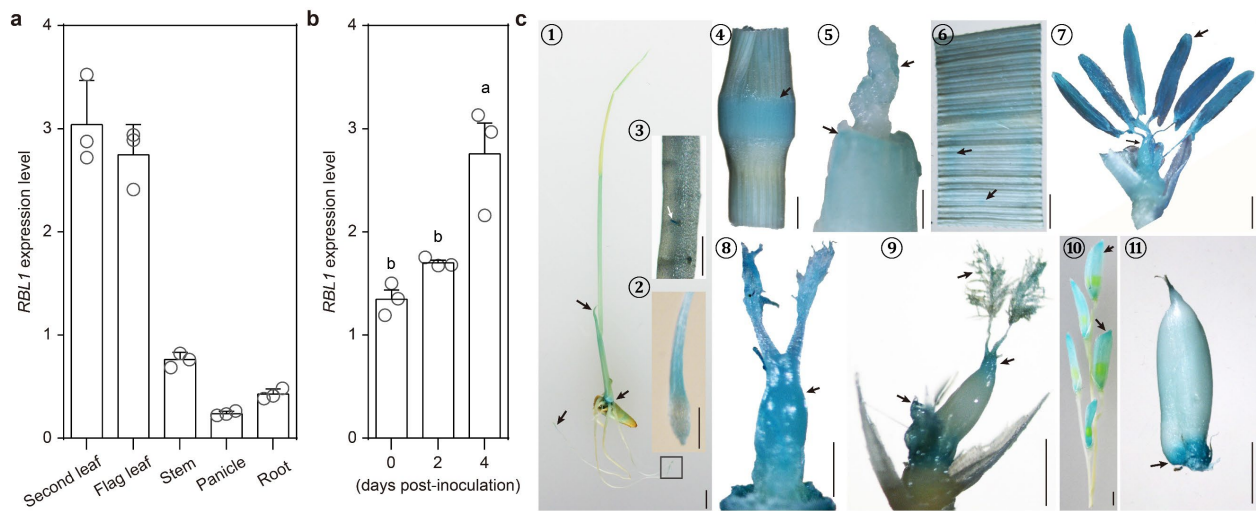

97

98

Extended Data Fig. 3 | Expression assays of *RBL1*.

99

a, qRT-PCR assays of *RBL1* in different tissues of the wild-type (WT, Kitaake) plants at the flowering stage. **b**, qRT-PCR assays of *RBL1* in response to rice blast at the seedling stage of Kitaake. Kitaake plants spray-inoculated with *M. oryzae* strain ZB25 were used in the assay. Significant differences indicated by different letters were calculated using the Duncan's new multiple range test. **c**, Tissue-specific expression of *RBL1* visualized by staining for the β -glucuronidase (GUS) activity under control of the *RBL1* promoter in the reporter line. For numbers: 1, seedling; 2 and 3, root; 4, stem; 5, shoot apical mistem; 6, leaf; 7, stamen; 8, pistil; 9, premilk stage; 10, panicle; 11, maturity stage. Bars in 1, 4, and 7, 5 mm; bars in 2, 3, 5, 6, and 8 to 11, 1 mm.

105

106

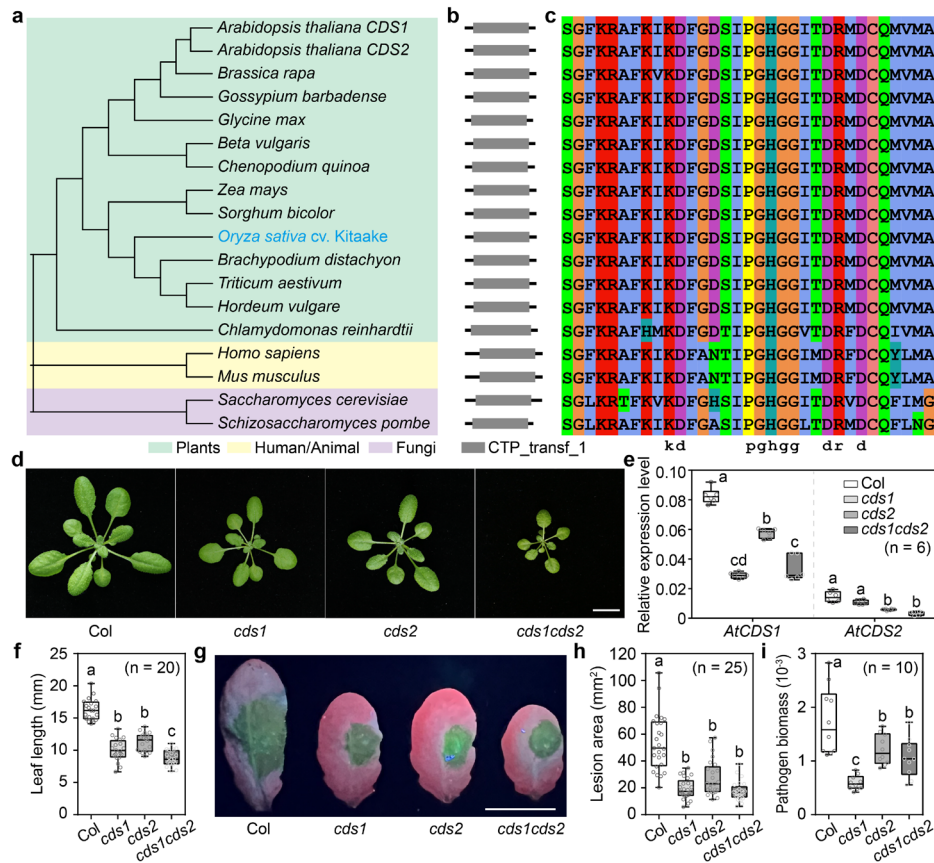

107

108 **Extended Data Fig. 4 | The *Arabidopsis thaliana* cds mutants show enhanced resistance to *Phytophthora capsica*.**

109 **a**, Phylogenetic analysis of RBL1 homologs from plants and other organisms. The phylogenetic tree was constructed
 110 using MEGA10. Accession numbers for different RBL1 homologs: *Arabidopsis thaliana* (NP_176433.2), *Beta vulgaris*
 111 *subsp. vulgaris* (XP_010694835.1), *Brachypodium distachyon* (XP_003564318.1), *Brassica rapa* (RID78417.1),
 112 *Chenopodium quinoa* (XP_021731901.1), *Chlamydomonas reinhardtii* (PNW85433.1), *Glycine max* (XP_003556374.1),
 113 *Gossypium barbadense* (KAB2026876.1), *Homo sapiens* (NP_001254.2), *Hordeum vulgare* (KAE8818711.1), *Mus*
 114 *musculus* (NP_775546.2), *Oryza sativa* (NC_029256.1), *Saccharomyces cerevisiae* (AJQ02739.1), *Schizosaccharomyces*
 115 *pombe* (NP_596416.1), *Sorghum bicolor* (KAG0539475.1), *Triticum aestivum* (KAF7023922.1), and *Zea mays*
 116 (NP_001132909.1). **b**, Protein domain analysis of RBL1 homologs from various organisms. Conserved domains in RBL1
 117 homologs were predicted using the Evolve program. CTP_transf_1, phosphatide cytidyltransferase. **c**, Amino acid
 118 alignment of the 19 residues that are truncated in the *rbl1* line. The consensus is shown at the bottom. **d**, The *cds* mutant
 119 and the wild-type (WT, Col-0, *A. thaliana*) plants at 28 days post sowing (dps). Bar, 1 cm. **e**, qRT-PCR assays. Total RNA
 120 was extracted from leaves of 4-week-old plants. **f**, Leaf length of the WT and *cds* mutant lines at 28 dps. **g-i**, Infected
 121 leaves (**g**), lesion area (**h**), and relative quantification of pathogen biomass (**i**) of inoculated WT and *cds* lines at 36 hours
 122 post-inoculation (hpi) with *Phytophthora capsica* strain LT263. Bar, 1 cm. Data are displayed as box and whisker plots with
 123 individual data points. The box plot elements are: center line, median; box limits, 25th and 75th percentiles. Significant
 124 differences indicated by different letters were calculated using the Duncan's new multiple range test.

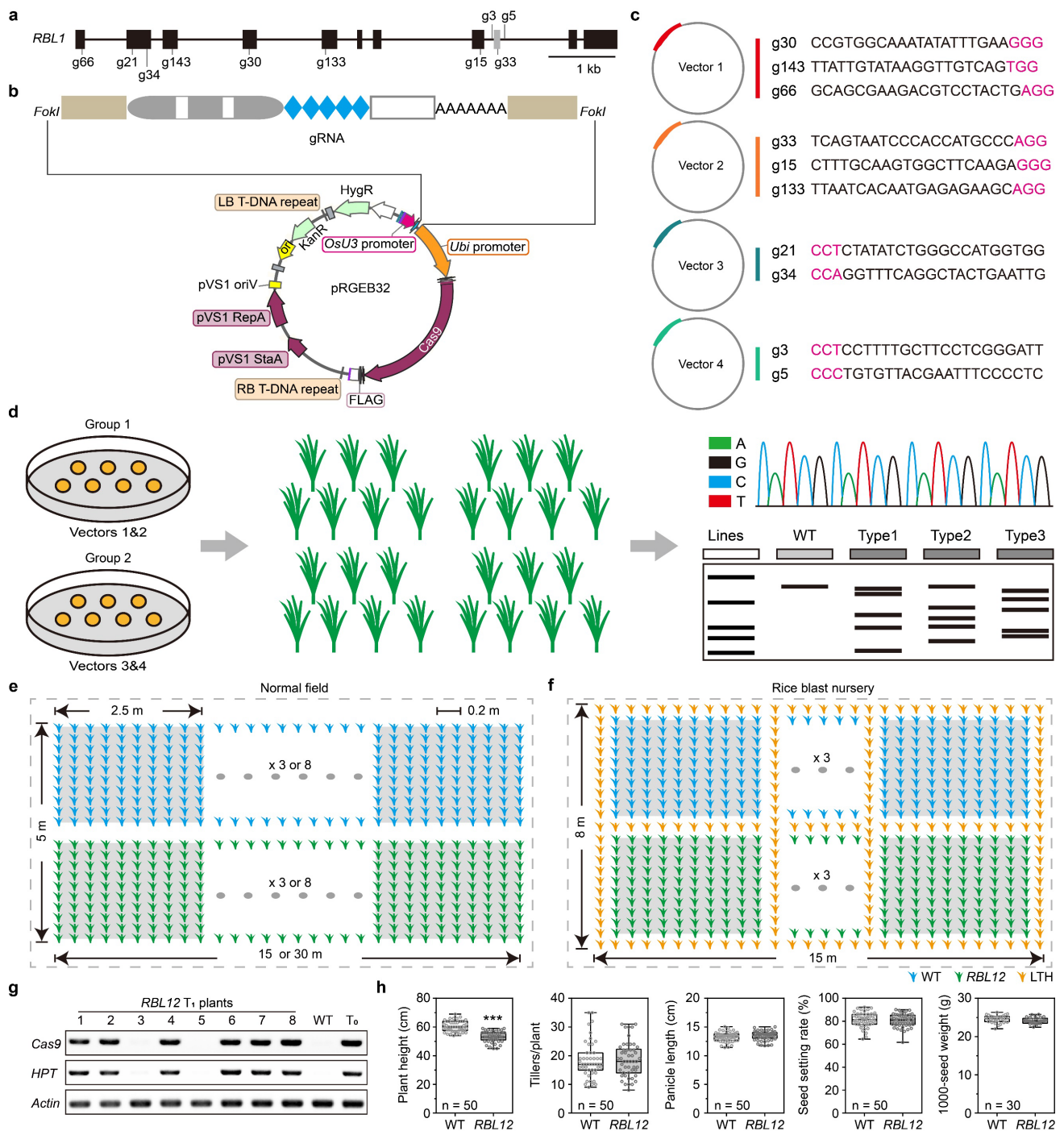

137

138

Extended Data Fig. 6 | Design of gRNA multiplexing in genome editing of *RBL1* and field trials.

139

a, Gene structure of *RBL1* and the site targeted by each numbered guide RNA (gRNA) for genome editing. **b**, Map and

140

cloning sites of the CRISPR/Cas9 vector pRGE32 used in genome editing (left); vectors with different gRNAs (right). **c**,

141

Sequences of gRNAs designed using CRISPR-P 2.0. Purple letters indicate protospacer-adjacent motif sites (PAMs). **d**, A

142

schematic diagram of co-transformation of different constructs and genotyping of T0 lines. Edited sites in each T0 plant

143

were identified using Sanger sequencing and agarose gel electrophoresis. WT, the wild-type Kitaake. **e**, Design of the

144

normal field plots. **f**, Design of the field plots in the rice blast nursery. WT, the wild-type Kitaake; *RBL12*, the edited line;

145

LTH, the very susceptible rice variety Lijiangxintuanheigu, which was used as the spreader line for rice blast. Each plot

146 contains 100 plants 0.2 m apart. **g**, Identification of transgene-free T1 plants of *RBL12*. Primers specific to the *Cas9*, *hph*
147 and *Actin* genes, respectively, were used in genotyping. The *hph* gene encoding a hygromycin B phosphotransferase
148 confers hygromycin resistance for rice transgenic lines. The amplicon of the *Actin* gene was used as the DNA quality
149 control. WT, Kitaake. **h**. Agronomic traits of the *RBL12* and Kitaake lines. Data for each agronomic trait were collected
150 from 50 plants for each line that was grown in the normal paddy field. In the box and whisker plots, dots indicate individual
151 data points, and the error bars represent maximum and minimum values. Center line, median; box limits, 25th and 75th
152 percentiles. Asterisks indicate significant differences using the unpaired Student's *t*-test ($***P < 0.001$).

153

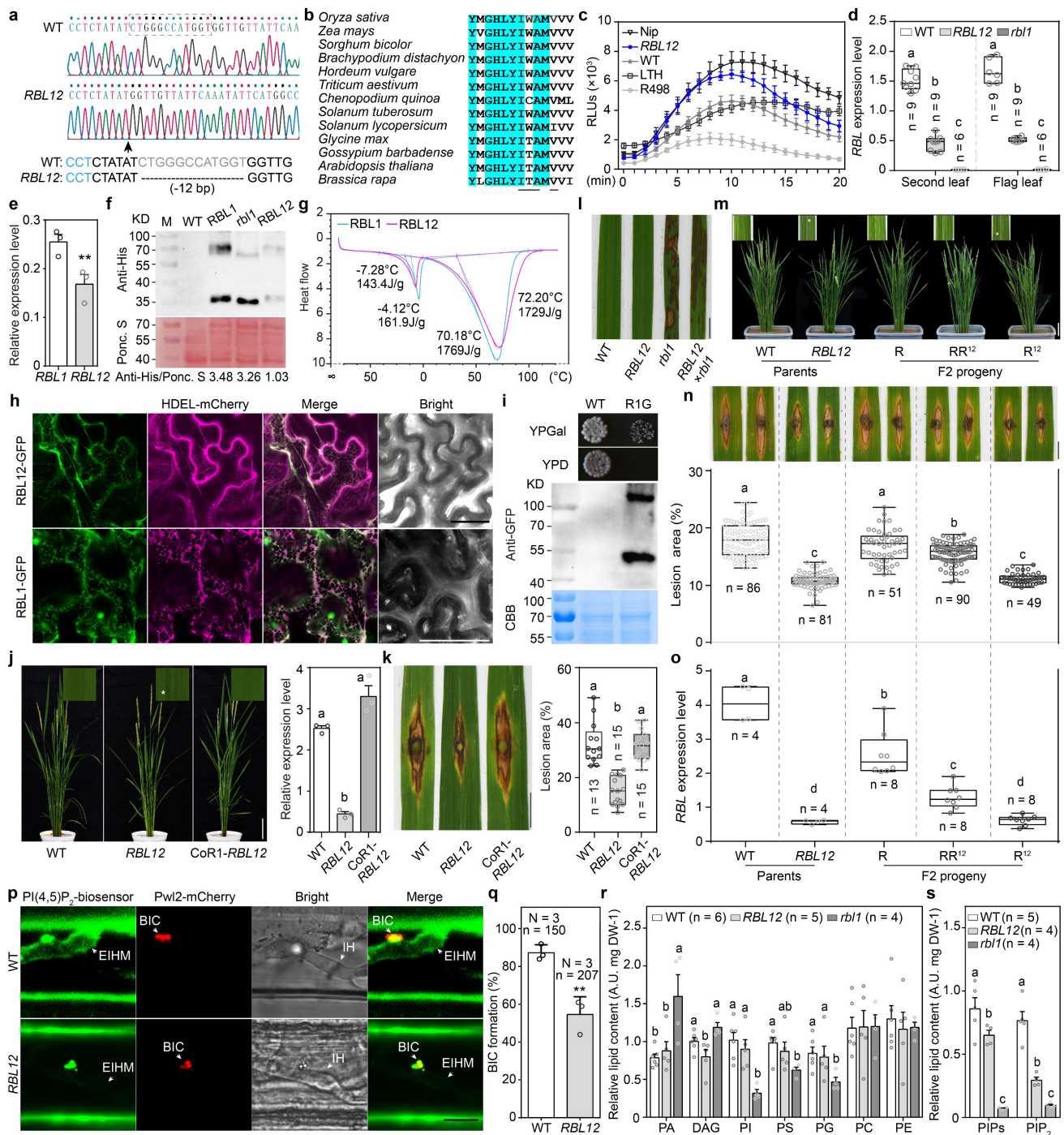

154

155 **Extended Data Fig. 7 | Systematic characterization of the *RBL12* line and the allele.**

156 **a**, Sanger sequencing of the edited site indicated by the arrow in the *RBL12* line with the wild-type (WT, Kitaake) as the
 157 reference. The PAM site was shown in blue, and the dashed line represents the 12-bp deletion. **b**, Amino acid sequence
 158 alignment of RBL1 homologs around the four residues (underlined) that are truncated in the *RBL12* line. Highlighted are
 159 conserved residues in the RBL1 homologs. **c**, ROS generation in the WT, *RBL12*, Nipponbare (Nip), LTH, and R498 rice
 160 plants challenged with chitin at the booting stage. RLU, relative light unit. **d**, qRT-PCR assays of *RBL1* expression in
 161 different tissues of the WT, *RBL12*, and *rbl1* plants at the flowering stage. **e**, qRT-PCR assays of heterologous expression
 162 of *RBL1* in yeast. Yeast 18s rRNA was used as the internal control. **f**, Immunoblotting analysis of RBL1-, *rbl1*-, and

163 RBL12-6×His fusion proteins in yeast. Ponceau S staining indicates the protein loading. WT, yeast strain BY4741; other
164 strains are transformants of the yeast *cds1* mutant carrying pYES2-*RBL1*, pYES2-*rb1*, and pYES2-*RBL12*, respectively.
165 **g**, Stability of the RBL1- and RBL12-6×His fusion proteins analyzed using differential scanning calorimetry (DSC). **h**,
166 Subcellular localization of the RBL1- and RBL12-GFP fusion proteins transiently expressed in *Nicotiana benthamiana* leaf
167 epidermal cells, analyzed together with the endoplasmic reticulum marker HDEL-mCherry. Bars, 25 μm. **i**, RBL1-GFP
168 rescues the growth defect of yeast *cds1*. WT, yeast strain BY4741; R1G, the yeast *cds1* mutant carrying pYES2-*RBL1*-
169 GFP. Strains were cultured on YPGal or YPD plates at 30°C for 3 days before sampling. Immunoblotting analysis of the
170 RBL1-GFP fusion protein in the yeast strain R1G that forms a homodimer. CBB staining indicates the protein loading. **j**, 9-
171 week-old WT, *RBL12*, and complemented T1 plants. The white asterisk indicates the spontaneous lesion in the insets.
172 Bar, 10 cm. Shown on the right are qRT-PCR assays of *RBL1* in the WT, *RBL12*, and CoR1-*RBL12* lines. Gene *Actin* was
173 used as the internal control. **k**, Punch inoculation of the WT, *RBL12*, and CoR1-*RBL12* lines with *M. oryzae*. The lesion
174 area was measured at 14 dpi. Bar, 1 cm. **l**, Leaves of 3-week-old WT, *rb1*, *RBL12*, and F1 plants of *rb1* crossed with
175 *RBL12*. Bar, 1 cm. **m**, The WT, *RBL12*, and F2 plants derived from the WT line crossed with *RBL12* at 60 dps.
176 Spontaneous lesions-indicated by white asterisks-formed on the top leaves of homozygous *RBL12* lines. Bars, 10 cm. **n**,
177 Punch inoculation assays of the WT, *RBL12*, and F2 plants with *M. oryzae*. The lesion area was measured at 14 dpi. Bar,
178 1 cm. **o**, qRT-PCR assays of *RBL1* in the WT, *RBL12* and F2 plants at the tillering stage. **p**, WT and *RBL12* transgenic
179 plants expressing the PI(4,5)P₂ biosensor at 32 hpi with *M. oryzae* strain ZB25 expressing the cytoplasmic effector Pwl2
180 tagged with mCherry. BIC, biotrophic interfacial complex; EIHM, extra-invasive hyphal membrane; IH, invasive hyphae.
181 Bar, 10 μm. **q**, BIC formation in plants shown in (**r**). **r**, Membrane lipid composition analysis of the WT, *RBL12*, and *rb1*
182 lines. DW, dry weight. **s**, PIP and PIP₂ content in the WT, *RBL12*, and *rb1* lines. The box plot elements are: center line,
183 median; box limits, 25th and 75th percentiles. Bars in (**e**), (**j**), (**q**), (**r**), and (**s**) indicate standard deviations, and asterisks in
184 (**e**) and (**q**) indicate significant differences using the unpaired Student's *t*-test (***P* < 0.01). Significant differences indicated
185 by different letters in (**d**), (**j**), (**k**), (**n**), (**o**), (**r**), and (**s**) were calculated using the Duncan's new multiple range test.
186

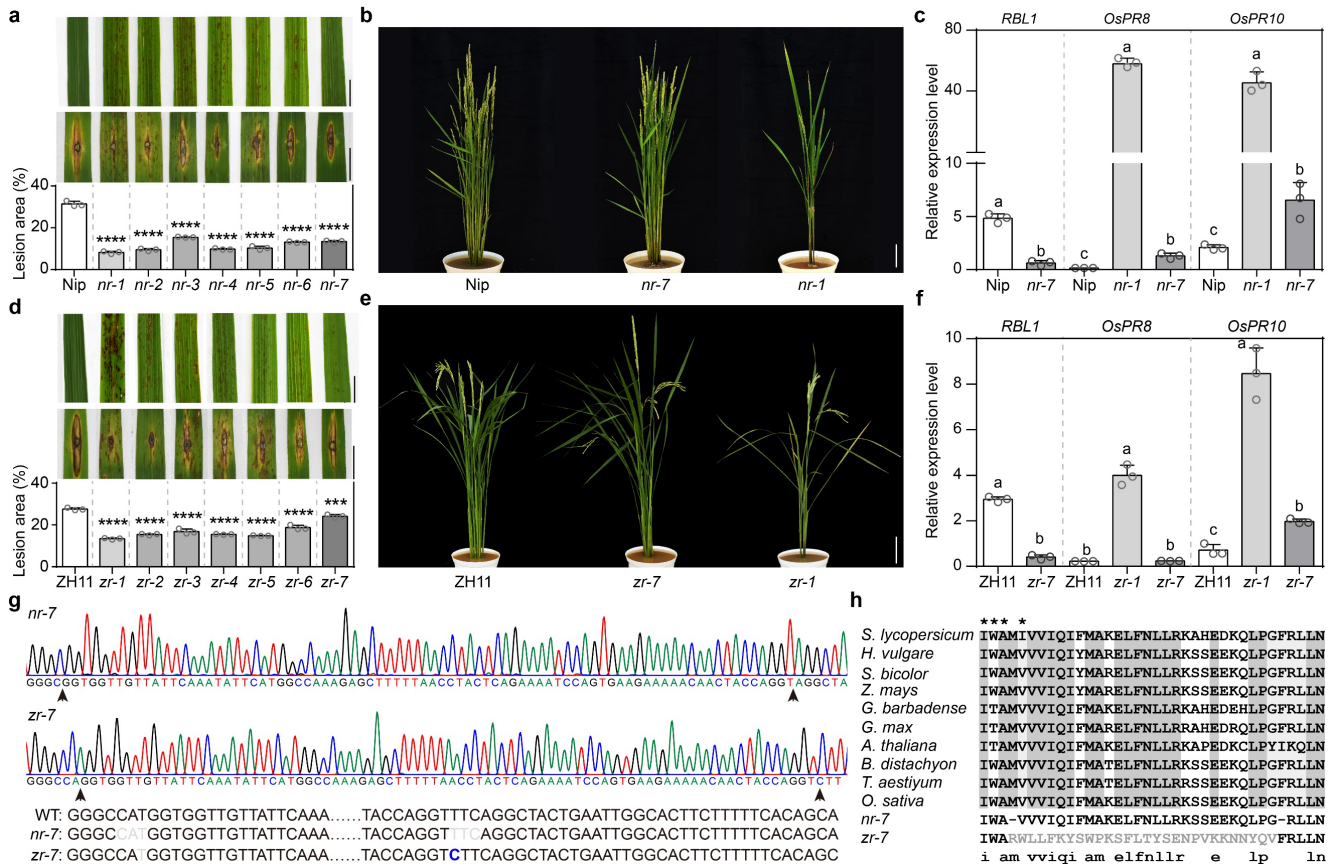

187

188

Extended Data Fig. 8 | Genome editing of *RBL1* enhances disease resistance in two other rice cultivars.

189

a, Lesion mimic phenotypes and enhanced resistance to *M. oryzae* in *RBL1*-edited Nipponbare (Nip) lines. Infected leaves

190

and lesion area of punch-inoculated *RBL1*-edited lines with *M. oryzae* at 14 dpi. Bar, 1 cm. **b**, 12-week-old *RBL1*-edited

191

Nipponbare lines. Bar, 10 cm. **c**, qRT-PCR assays of *RBL1* and plant defense-related genes *OsPR8* and *OsPR10* in the

192

RBL1-edited Nipponbare lines. Total RNA was extracted from 4-week-old leaves. The *Actin* gene was used as the internal

193

control. **d-f**, Similar assays as shown in (a-c) were performed on one local rice cultivar Zhonghua11 (ZH11). **g**, Sanger

194

sequencing of the edited sites, indicated by arrows, in *nr-7* and *zr-7* lines, with the wild-type (WT, Kitaake) as the

195

reference. The mutated nucleotides are shown in gray (deletion) and blue (insertion). **h**, Amino acid sequence alignment

196

of the region mutated in lines *nr-7* and *zr-7*. The four amino acids truncated in RBL12 are indicated by asterisks. Shaded

197

are conserved residues in the RBL1 homologs. Two amino acids are truncated in *nr-7*, with the first one overlapping the

198

truncated region in RBL12. A 84-bp frameshift mutation caused by a 1-bp deletion followed by a 1-bp insertion alters the

199

sequence of 28 amino acids (gray) in *zr-7*, with the first two overlapping the truncated region in RBL12. Bars indicate

200

standard deviations, and asterisks indicate significant differences compared to the WT using the unpaired Student's *t*-test

201

(*** $P < 0.001$, **** $P < 0.0001$). Significant differences indicated by different letters in (c) and (f) were calculated using the

202

Duncan's new multiple range test.