



HAL
open science

Crystal structure of dibenzylammonium hydrogen (4-aminophenyl)arsonate monohydrate

Bocar Traoré, Waly Diallo, Mamadou Sidibé, Libasse Diop, Laurent
Plasseraud, Hélène Cattey

► **To cite this version:**

Bocar Traoré, Waly Diallo, Mamadou Sidibé, Libasse Diop, Laurent Plasseraud, et al.. Crystal structure of dibenzylammonium hydrogen (4-aminophenyl)arsonate monohydrate. *Acta crystallographica Section E: Crystallographic communications* [2015-..], 2023, 79 (11), 10.1107/S205698902300837X . hal-04243609

HAL Id: hal-04243609

<https://hal.science/hal-04243609>

Submitted on 16 Oct 2023

HAL is a multi-disciplinary open access archive for the deposit and dissemination of scientific research documents, whether they are published or not. The documents may come from teaching and research institutions in France or abroad, or from public or private research centers.

L'archive ouverte pluridisciplinaire **HAL**, est destinée au dépôt et à la diffusion de documents scientifiques de niveau recherche, publiés ou non, émanant des établissements d'enseignement et de recherche français ou étrangers, des laboratoires publics ou privés.

Crystal structure of dibenzylammonium hydrogen (4-aminophenyl)arsonate monohydrate

Bocar Traoré,^a Waly Diallo,^{a*} Mamadou Sidibé,^a Libasse Diop,^a Laurent Plasseraud^b and Hélène Cattey^{b*}

^aLaboratoire de Chimie Minérale et Analytique (LACHIMIA), Département de Chimie, Faculté des Sciences et Techniques, Université Cheikh Anta Diop, Dakar, Senegal, and ^bICMUB UMR 6302, Université de Bourgogne (UB), Faculté des Sciences, 9 avenue Alain Savary, 21000 DIJON, France. *Correspondence e-mail: waly.diallo@ucad.edu.sn, hcattey@u-bourgogne.fr

The title salt, $C_{14}H_{16}N^+ \cdot C_6H_7AsNO_3^- \cdot H_2O$ or $[(C_6H_5CH_2)_2NH_2][H_2NC_6H_4As(OH)O_2] \cdot H_2O$, (**I**), was synthesized by mixing an aqueous solution of (4-aminophenyl)arsonic acid with an ethanolic solution of dibenzylamine at room temperature. Compound **I** crystallizes in the monoclinic $P2_1/c$ space group. The three components forming **I** are linked *via* $N-H \cdots O$ and $O-H \cdots O$ intermolecular hydrogen bonds, resulting in the propagation of an infinite zigzag chain. Additional weak interactions between neighbouring chains, such as $\pi-\pi$ and $N-H \cdots O$ contacts, involving phenyl rings, $-NH_2$ and $-As(OH)O_3$ functions, and H_2O , respectively, lead to a three-dimensional network.

1. Chemical context

Organoarsenic compounds have been known for a long time and sparked great interest when they were discovered. Tetramethyldiarsine ($Me_2As-AsMe_2$), commonly known as *Cacodyl*, was isolated in the middle of the 18th century by Cadet de Glaussicourt (Garje & Jain, 1999). During the next century, in 1859, Antoine Béchamp reported the synthesis of *p*-arsanilic acid sodium salt (named *Atoxyl*) by reacting aniline with arsenic acid. This compound was employed for pharmaceutical applications, in particular against trypanosomal infection. Subsequently, in the early 20th century, Paul Ehrlich was inspired by this work to develop a new organoarsenic derivative, called *Arsphenamine* or *Salvarsan* (Ehrlich & Bertheim, 1907). This molecule has proved particularly effective in the treatment of syphilis and sleeping sickness (African Trypanosomiasis) and is considered as being the first chemotherapeutic agent (Williams, 2009). The use of organoarsenicals as medicines was subsequently abandoned in favour of penicillin, as they were found to be highly toxic to humans, causing significant side effects (including blindness). However, they have continued to be used, until recently, as feed additives and veterinary drugs, particularly in the livestock and poultry breeding industry, but with serious negative effects on the environment. Soil and groundwater contamination resulting from the excessive use of aromatic organoarsenic compounds is now a major environmental concern (Fei *et al.*, 2018). Current investigations involving academics focus on improving analytical detection (Depalma *et al.*, 2008; Yang *et al.*, 2018) and remediation methods (Jun *et al.*, 2015; Chen *et al.*, 2022).

From a structural point of view, the crystal structure of phenylarsonic acid was first solved in the early 1960s (refcode ARSACP; Shimada, 1960). Since then, the X-ray structure for

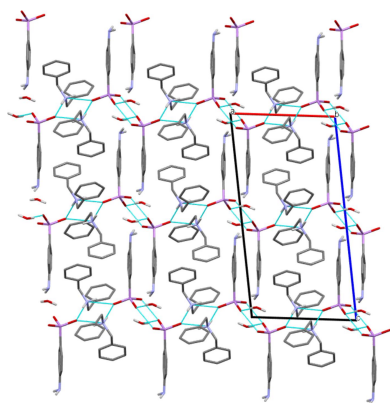

the zwitterionic form of *p*-arsanilic acid (*p*-ammonio-phenyl-arsonate) has been determined (CUDSEZ: Shimada, 1961; CUDSEZ01: Nuttall & Hunter, 1996) as well as of the hydrated ammonium and sodium salt hydrates of 4-aminophenylarsonic acid (KOKWOY, KOKWUE: Smith & Wermuth, 2014). We report herein the structure of a new salt of 4-aminophenylarsonate, isolated from a mixture of (4-aminophenyl)arsonic acid and dibenzylamine and characterized as dibenzylammonium hydrogen (4-aminophenyl) arsonate monohydrate, $[(C_6H_5CH_2)_2NH_2][H_2NC_6H_4As(OH)O_2] \cdot H_2O$ (**I**).

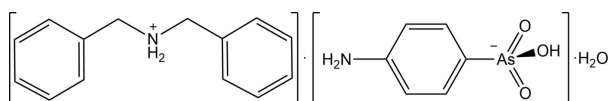

2. Structural commentary

The asymmetric unit of the title salt, which is depicted in Fig. 1, comprises one dibenzylammonium cation $[(C_6H_5CH_2)_2NH_2]^+$, one hydrogen (4-aminophenyl)arsonate anion $[H_2NC_6H_4As(OH)O_2]^-$ and one water molecule of solvation. The three components of **I** are linked together through intermolecular N—H...O and O—H...O hydrogen bonds. The As atom of the anion is bonded to three O atoms and one carbon atom of the phenyl ring, describing a slightly distorted tetrahedral geometry [O1—As—C1 = 103.71 (6)°, O2—As—C1 = 110.47 (6)°, O3—As—C1 = 111.73 (6)°, O2—As—O1 = 110.71 (5)°, O3—As—O1 = 108.46 (5)°, O3—As—O2 = 111.48 (5)°]. The As—O bonds exhibit two distinct lengths: As—O1 = 1.7267 (10) Å, and As—O2 = 1.6730 (10) Å and As—O3 = 1.6699 (10) Å, which can be considered to be identical. The As—O1 distance is consistent with the presence of a hydroxyl group (Yang *et al.*, 2002), while

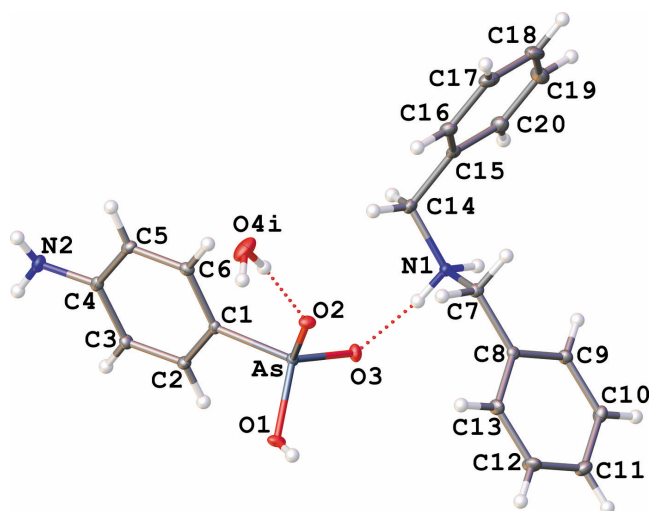

Figure 1
The molecular structure of **I** with displacement ellipsoids at the 30% probability level. The water molecule was found to be disordered over two positions, the minor part was omitted and the major part is represented with the following symmetry code: (i): $-1 + x, y, z$. Dotted lines indicate hydrogen bonds.

Table 1
Hydrogen-bond geometry (Å, °).

| D—H...A | D—H | H...A | D...A | D—H...A |
|----------------------------|----------|----------|-------------|------------|
| N2—H2A...O4 ⁱ | 0.84 (2) | 2.37 (2) | 3.165 (2) | 158.0 (18) |
| N2—H2B...O1 ⁱⁱ | 0.83 (2) | 2.25 (2) | 3.0769 (17) | 175.6 (18) |
| N1—H1A...O3 | 0.91 | 1.78 | 2.6842 (16) | 172 |
| N1—H1B...O3 ⁱⁱⁱ | 0.91 | 1.89 | 2.7260 (15) | 151 |
| O1—H1...O2 ^{iv} | 0.83 (3) | 1.73 (3) | 2.5445 (15) | 170 (3) |
| O4—H4A...O2 ^v | 0.87 | 1.95 | 2.8074 (18) | 169 |

Symmetry codes: (i) $-x + 1, y - \frac{1}{2}, -z + \frac{1}{2}$; (ii) $-x, y + \frac{1}{2}, -z + \frac{1}{2}$; (iii) $-x + 1, -y + 1, -z + 1$; (iv) $-x, -y + 1, -z + 1$; (v) $x + 1, y, z$.

the As—O2 and As—O3 distances, which are shorter, reflect rather a double-bond character. In the literature, based on a comparison of structural examples, the average length of the As—O bond is defined as 1.77 Å and that of the As=O bond as 1.67 Å (Nuttall & Hunter, 1996). The nature of the As=O2 and As=O3 double bonds implies that the negative charge is delocalized on the arsonate. The three oxygen atoms of the arsonate function are engaged in hydrogen bonding, the O1 and O2 atoms being linked head-to-tail [O1—H...O2^{iv}, $D...A = 2.5444$ (15) Å; symmetry code: (iv) $-x, -y + 1, -z + 1$, Table 1]. The length of the As—C1 bond [1.8955 (13) Å] is within the range of values measured for related compounds such as ammonium 4-nitrophenylarsonate (Yang *et al.*, 2002) and guanidinium phenylarsonate (Smith & Wermuth, 2010). An amino group is positioned on the phenyl ring in the *para* position to the arsonate function. Both functional groups are contained in the plane of the phenyl ring. The negative charge of $[H_2NC_6H_4As(OH)O_2]^-$ is compensated by the presence of one dibenzylammonium cation, $[(C_6H_5CH_2)_2NH_2]^+$, whose NH₂⁺ group is hydrogen bonded to the oxygen atom O3 of the arsonate function [N1—H1A...O3, $D...A = 2.6842$ (16) Å, N1—H1B...O3ⁱⁱⁱ, $D...A = 2.7260$ (15) Å; symmetry code: (iii) $-x + 1, -y + 1, -z + 1$]. Moreover, the dibenzylammonium cation shows a *syn-anti* conformation, displaying C—C—N—C torsion angles of 57.65 (16)° and -178.14 (11)°, which are in the range of previous examples of X-ray structures involving $[(C_6H_5CH_2)_2NH_2]^+$ (Trivedi & Dastidar, 2006). A water molecule (co-solvent of the reaction) participates in a hydrogen-bond interaction with the oxygen atom O2 of $-As(OH)O_2^-$ [O4—H4A...O2^v, $D...A = 2.8074$ (18) Å; symmetry code: (v) $1 + x, y, z$] completes the composition of salt **I**. From a spectroscopic point of view, the infrared spectrum of **I** (ATR mode) highlights $\nu(As-C)$ and $\nu(As-O)$ absorption bands, which are characteristic of the arsonate function (Cowen *et al.*, 2008), at 1096 cm⁻¹ and between 925–690 cm⁻¹, respectively. The percentages of C, H, N and O determined by elemental analysis support the chemical composition of **I**, but show that the salt is partially dehydrated (see the *Synthesis and crystallization* section).

3. Supramolecular features

At the supramolecular stage, two levels of organization can be observed in the crystal structure of **I**:

(i) The propagation of one-dimensional zigzag chains along the *a*-axis direction resulting from the hydrogen-bonding

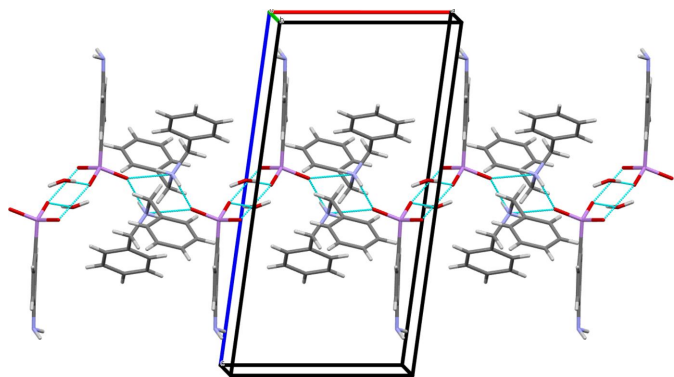
Figure 2

Mercury representation (Macrae *et al.*, 2020; colour code: C = grey, N = blue, O = red, As = pink, H = white) of the infinite chain structure of **I** propagating along the *a*-axis direction *via* hydrogen bonds (dotted cyan lines).

interactions (Fig. 2). The NH₂ groups of two dibenzylammonium cations are involved in two independent hydrogen bonds, oriented perpendicularly [$O3 \cdots N1 \cdots O3 = 92.63(5)^\circ$], with the oxygen atoms O3 of two arsonate moieties [$N1-H1A \cdots O3$ and $N1-H1B \cdots O3^{iii}$, Table 1]. This leads to the formation of a tetrameric unit describing a four-membered ring (Fig. 3). These units are linked together by two additional and parallel hydrogen bonds involving two hydrogen (4-aminophenyl)arsonate anions [$O1-H1 \cdots O2^{iv}$, Table 1]. This creates a six-membered ring. In addition, the water molecule contained in **I** is also in hydrogen-bonding interaction with the oxygen atom O2 of the arsonate group [$O4-H4A \cdots O2^v$, Table 1]. The 4-aminophenyl groups can be viewed as perpendicular to the chain axis and positioned alternately on either side of it.

(ii) The association of chains leading to a three-dimensional network and resulting from a combination of weak interactions (Fig. 4). Two types of π - π stacking interactions

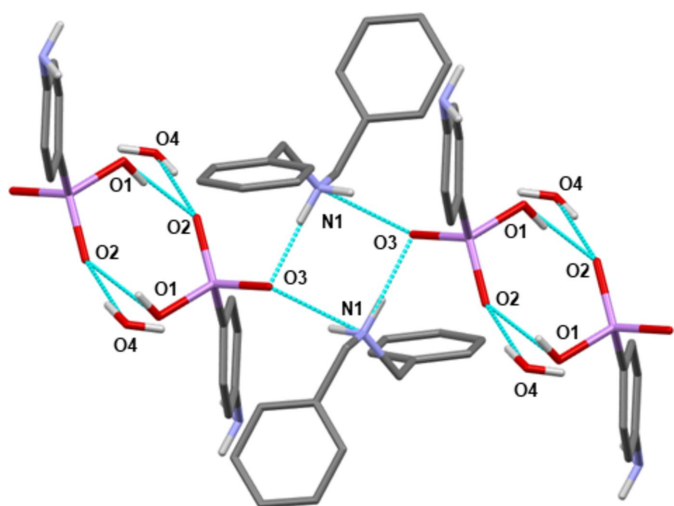
Figure 3

Mercury representation (Macrae *et al.*, 2020; colour code: C = grey, N = blue, O = red, As = pink, H = white) highlighting the hydrogen-bonding network (cyan dotted lines) involving the components of **I** (the benzyl H atoms have been omitted for clarity).

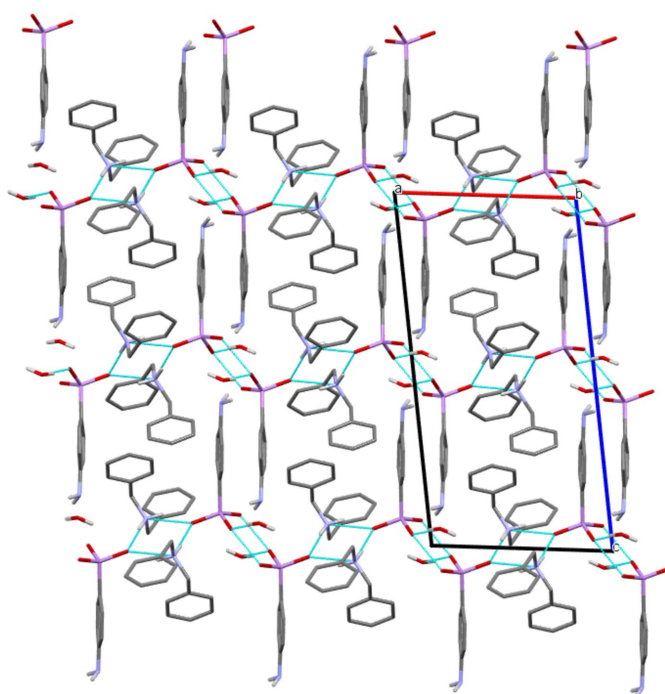
Figure 4

Arrangement of the chains in the crystal of **I** and along the *b*-axis, leading to a three-dimensional network (Mercury representation; Macrae *et al.*, 2020; colour code: C = grey, N = blue, O = red, As = pink, H = white). H atoms of phenyl and benzyl groups are omitted for clarity. The hydrogen bonds propagating the infinite chains are represented by dotted cyan lines.

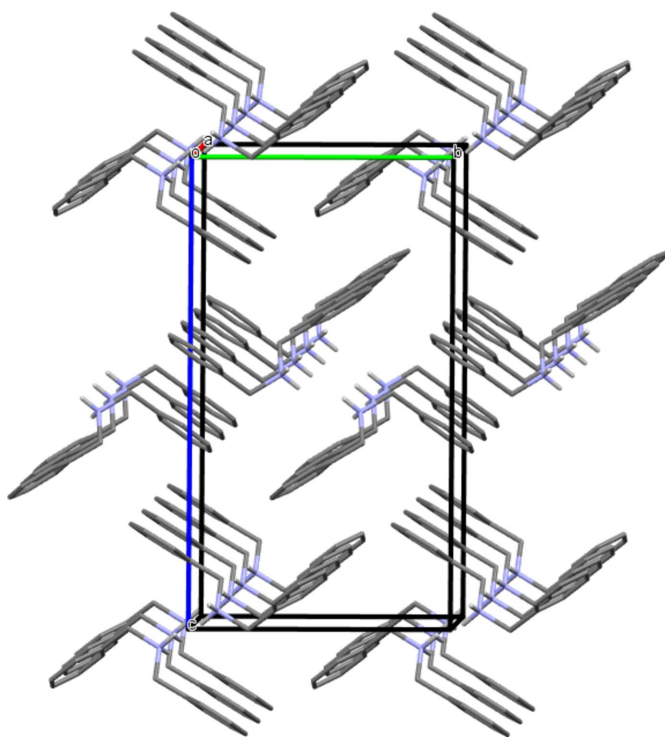
Figure 5

View of the π - π stacking interactions between phenyl rings of the dibenzylammonium cations of **I** [along the *a*-axis, Mercury representation (Macrae *et al.*, 2020); colour code: C = grey, N = blue, H = white). H atoms of phenyl rings, anions and water molecules have been omitted for clarity.

involving the phenyl rings of the dibenzylammonium cations can be described (Fig. 5): (a) centroid(C15–C20)–centroid(C15ⁱ–C20ⁱ) = 3.9384 (10) Å, interplanar distance = 3.4310 (18) Å, slip angle (angle between the normal to the plane and the centroid–centroid vector) = 29.4, corresponding to a slippage distance of 1.933 Å; symmetry code: (i) 1 – x, 2 – y, 1 – z; (b) centroid(C8–C13)–centroid(C15ⁱⁱ–C20ⁱⁱ) = 4.0178 (10) Å, interplanar distance = 3.5093 (6) Å, slip angle = 29.1°, corresponding to a slippage distance of 1.957 Å; symmetry code: (ii) 1 – x, –½ + y, ¾ – z. In addition, the NH₂ groups located in the *para* position of C₆H₄As(OH)O₂, interact *via* hydrogen bonding with a water molecule [N2–H2A···O4ⁱ = 3.165 (2) Å] and the O1 oxygen atom of an adjacent –As(OH)O₂ function [N2–H2B···O1ⁱⁱ = 3.0769 (17) Å] (symmetry codes as in Table 1).

4. Database survey

A search of the Cambridge Structural Database (WebCSD update 11/2022; Groom *et al.*, 2016), revealed that, to date, there are relatively few X-ray structures exhibiting the isolated hydrogen phenylarsonate moiety, C₆H₅As(OH)O₂[–]. To our knowledge, eleven examples including this fragment have already been identified: ammonium 4-nitrophenylarsonate (AHILAE: Yang *et al.*, 2002), guanidinium phenylarsonate guanidine dihydrate (DUSCIE: Smith & Wermuth, 2010), *p*-aminophenylarsonic acid (CUDSEZ: Shimada, 1961; CUDSEZ01: Nuttall & Hunter, 1996), ammonium hydrogen (4-aminophenyl)arsonate monohydrate (KOKWOY: Smith & Wermuth, 2014), 1-(4-hydroxy-2-methylphenyl)-2,4,6-triphenylpyridinium hydrogen *o*-arsanilate monohydrate (PAZRIS: Wojtas *et al.*, 2006), tetrabutylammonium hydrogen phenylarsonate–phenylarsonic acid (QECBEH: Reck & Schmitt, 2012), 3-ammonio-4-hydroxyphenylarsonate (ROBDAO: Lloyd *et al.*, 2008), hexaaquamanganese(II) bis[hydrogen (4-aminophenyl)arsonate] tetrahydrate (UBURIV: Smith & Wermuth, 2016a), hexaaqua-magnesium bis-(hydrogen (4-aminophenyl)arsonate) tetrahydrate (UDAPIB: Smith & Wermuth, 2017a), 2,3-dimethoxy-10-oxostyrychnidin-19-ium hydrogen (4-aminophenyl)arsonate tetrahydrate (ULIROY: Smith & Wermuth, 2016b), 2,4-diamino-5-(3,4,5-trimethoxybenzyl)pyrimidinium 4-hydroxy-3-nitrophenylarsonate monohydrate (XEMZIZ: Pan *et al.*, 2006). In coordination chemistry, phenylarsonic acid and its derivatives constitute also suitable ligands to generate coordination polymers and heteropolyoxometalates in the presence of transition metals (Lesikar-Parrish *et al.*, 2013), main-group metals (Xie *et al.*, 2008), alkali metals (Smith & Wermuth, 2017a) and alkali-earth metal precursors (Smith & Wermuth, 2017b). Regarding the dibenzylammonium cation, [(C₆H₅CH₂)₂NH₂]⁺, 117 hits incorporating such an entity were found in the Cambridge Structural Database.

5. Synthesis and crystallization

All chemicals were purchased from Sigma-Aldrich (Germany) and used without any further purification. (4-Aminophenyl)

Table 2

Experimental details.

| | |
|---|--|
| Crystal data | |
| Chemical formula | C ₁₄ H ₁₆ N ⁺ ·C ₆ H ₇ AsNO ₃ [–] ·H ₂ O |
| <i>M_r</i> | 432.34 |
| Crystal system, space group | Monoclinic, <i>P</i> 2 ₁ / <i>c</i> |
| Temperature (K) | 100 |
| <i>a</i> , <i>b</i> , <i>c</i> (Å) | 9.8242 (5), 10.6574 (6), 19.2507 (11) |
| β (°) | 97.7500 (18) |
| <i>V</i> (Å ³) | 1997.15 (19) |
| <i>Z</i> | 4 |
| Radiation type | Mo <i>K</i> α |
| μ (mm ^{–1}) | 1.73 |
| Crystal size (mm) | 0.5 × 0.25 × 0.18 |
| Data collection | |
| Diffractometer | Bruker D8 VENTURE |
| Absorption correction | Multi-scan (<i>SADABS</i> ; Krause <i>et al.</i> , 2015) |
| <i>T</i> _{min} , <i>T</i> _{max} | 0.610, 0.746 |
| No. of measured, independent and observed [<i>I</i> > 2 σ (<i>I</i>)] reflections | 67932, 4584, 4119 |
| <i>R</i> _{int} | 0.037 |
| (<i>sin</i> θ / λ) _{max} (Å ^{–1}) | 0.650 |
| Refinement | |
| <i>R</i> [<i>F</i> ² > 2 σ (<i>F</i> ²)], <i>wR</i> (<i>F</i> ²), <i>S</i> | 0.022, 0.054, 1.07 |
| No. of reflections | 4584 |
| No. of parameters | 261 |
| H-atom treatment | H atoms treated by a mixture of independent and constrained refinement |
| $\Delta\rho_{\max}$, $\Delta\rho_{\min}$ (e Å ^{–3}) | 0.42, –0.21 |

Computer programs: *APEX2* (Bruker, 2014), *SAINT* (Bruker, 2013), *SHELXT* (Sheldrick, 2015a), *SHELXL* (Sheldrick, 2015b) and *OLEX2* (Dolomanov *et al.*, 2009).

arsonic acid [H₂NC₆H₄As(OH)₂O] was prepared according to a previous work (Lewis & Cheetham, 1923), by reacting aniline (C₆H₅NH₂) and arsenic acid (As(OH)₃O). The title salt was obtained by neutralization of an aqueous solution (20 mL) of (4-aminophenyl)arsonic acid (2.15 g, 9.90 mmol) with dibenzylamine ((C₆H₅CH₂)₂NH) (3.90 g, 19.80 mmol) dissolved in 20 mL of ethanol. The mixture was stirred for about two h at room temperature (301 K). After three days of slow solvent evaporation, colourless prism-shaped crystals of [(C₆H₅CH₂)₂NH₂][H₂NC₆H₄As(OH)₂O]·H₂O (5.25 g, 64% yield), suitable for an X-ray crystallographic analysis, were collected from the solvent (m.p. 393 K). FT–IR (ATR, Bruker Alpha FTIR spectrometer, cm^{–1}): 3447, 3304, 3187, 1595, 1501, 1454, 1096, 923, 878, 825,752, 735, 695. Elemental analysis (Elemental Analyser, ThermoFisher FlashSmart CHNS/O) – analysis calculated for C₂₀H₂₃N₂O₃As·0.25H₂O (418.83), salt **I** partially dehydrated: C, 57.35; H, 5.66; N, 6.69; O, 12.41; found: C, 57.82; H, 5.61; N, 6.62; O, 12.37%.

6. Refinement details

Crystal data, data collection and structure refinement details are summarized in Table 2. The asymmetric unit contains the dibenzylammonium hydrogen (4-aminophenyl)arsonate monohydrate. The water molecule was found disordered over two main positions with occupancy factors that converged to 0.94:0.06. Hence, the minor part of the water molecule was refined only isotropically and without the hydrogen atoms.

The hydrogen atoms for the major component of the water molecule were refined geometrically as a rigid group (O–H = 0.87 Å) with $U_{\text{iso}}(\text{H}) = 1.5U_{\text{eq}}(\text{O})$. C-bound hydrogen atoms were placed at calculated positions [C–H = 0.95 Å (aromatic) or 0.99 Å (methylene group)] and H atoms of the NH₂ and OH terminal groups were placed geometrically (N–H = 0.83–0.84 Å, O–H = 0.83 Å) and refined as riding with $U_{\text{iso}}(\text{H}) = 1.2U_{\text{eq}}(\text{N}, \text{C})$.

Acknowledgements

The authors are grateful for general and financial support from the University Cheikh Anta Diop-Dakar (Senegal), the University of Bourgogne-Dijon (France) and the Centre National de la Recherche Scientifique (CNRS-France). They would like to thank in particular Ms T. Régnier for elemental analysis measurements.

References

- Bruker (2013). *SAINT*. Bruker AXS Inc., Madison, Wisconsin, USA.
- Bruker (2014). *APEX2*. Bruker AXS Inc., Madison, Wisconsin, USA.
- Chen, H., Liu, W., Cheng, L., Meledina, M., Meledin, A., Van Deun, R., Leus, K. & Van Der Voort, P. (2022). *Chem. Eng. J.* **429**, 132162.
- Cowen, S., Duggal, M., Hoang, T. & Al-Abadleh, H. A. (2008). *Can. J. Chem.* **86**, 942–950.
- Depalma, S. S. C. O. T. T., Cowen, S., Hoang, T. & Al-Abadleh, H. A. (2008). *Environ. Sci. Technol.* **42**, 1922–1927.
- Dolomanov, O. V., Bourhis, L. J., Gildea, R. J., Howard, J. A. K. & Puschmann, H. (2009). *J. Appl. Cryst.* **42**, 339–341.
- Ehrlich, P. & Bertheim, A. (1907). *Ber. Dtsch. Chem. Ges.* **40**, 3292–3297.
- Fei, J., Wang, T., Zhou, Y., Wang, Z., Min, X., Ke, Y., Hu, W. & Chai, L. (2018). *Chemosphere*, **207**, 665–675.
- Garje, S. S. & Jain, V. K. (1999). *Main Group Met. Chem.* **22**, 45–58.
- Groom, C. R., Bruno, I. J., Lightfoot, M. P. & Ward, S. C. (2016). *Acta Cryst.* **B72**, 171–179.
- Jun, J. W., Tong, M., Jung, B. K., Hasan, Z., Zhong, C. & Jung, S. H. (2015). *Chem. Eur. J.* **21**, 347–354.
- Krause, L., Herbst-Irmer, R., Sheldrick, G. M. & Stalke, D. (2015). *J. Appl. Cryst.* **48**, 3–10.
- Lesikar-Parrish, L. A., Neilson, R. H. & Richards, A. F. (2013). *J. Solid State Chem.* **198**, 424–432.
- Lewis, W. L. & Cheetham, H. C. (1923). *Org. Synth.* **3**, 13–16.
- Lloyd, N. C., Morgan, H. W., Nicholson, B. K. & Ronimus, R. S. (2008). *J. Organomet. Chem.* **693**, 2443–2450.
- Macrae, C. F., Sovago, I., Cottrell, S. J., Galek, P. T. A., McCabe, P., Pidcock, E., Platings, M., Shields, G. P., Stevens, J. S., Towler, M. & Wood, P. A. (2020). *J. Appl. Cryst.* **53**, 226–235.
- Nuttall, R. H. & Hunter, W. N. (1996). *Acta Cryst.* **C52**, 1681–1683.
- Pan, T.-T., Liu, B.-X. & Xu, D.-J. (2006). *Acta Cryst.* **E62**, m2198–m2199.
- Reck, L. & Schmitt, W. (2012). *Acta Cryst.* **E68**, m1212–m1213.
- Sheldrick, G. M. (2015a). *Acta Cryst.* **A71**, 3–8.
- Sheldrick, G. M. (2015b). *Acta Cryst.* **C71**, 3–8.
- Shimada, A. (1960). *Bull. Chem. Soc. Jpn.* **33**, 301–304.
- Shimada, A. (1961). *Bull. Chem. Soc. Jpn.* **34**, 639–643.
- Smith, G. & Wermuth, U. D. (2010). *Acta Cryst.* **E66**, o1893–o1894.
- Smith, G. & Wermuth, U. D. (2014). *Acta Cryst.* **C70**, 738–741.
- Smith, G. & Wermuth, U. D. (2016a). *IUCrData*, **1**, x161985.
- Smith, G. & Wermuth, U. D. (2016b). *Acta Cryst.* **E72**, 751–755.
- Smith, G. & Wermuth, U. D. (2017a). *Acta Cryst.* **E73**, 203–208.
- Smith, G. & Wermuth, U. D. (2017b). *Acta Cryst.* **C73**, 61–67.
- Trivedi, D. R. & Dastidar, P. (2006). *Cryst. Growth Des.* **6**, 2115–2121.
- Williams, K. J. (2009). *J. R. Soc. Med.* **102**, 343–348.
- Wojtas, Ł., Milart, P. & Stadnicka, K. (2006). *J. Mol. Struct.* **782**, 157–164.
- Xie, Y.-P., Yang, J., Ma, J.-F., Zhang, L.-P., Song, S.-Y. & Su, Z.-M. (2008). *Chem. Eur. J.* **14**, 4093–4103.
- Yang, J., Ma, J.-F., Liu, Y.-C., Zheng, G.-L., Li, L., Liu, J.-F., Hu, N.-H. & Jia, H.-Q. (2002). *Acta Cryst.* **C58**, m613–m614.
- Yang, T., Wang, L., Liu, Y., Jiang, J., Huang, Z., Pang, S.-Y., Cheng, H., Gao, D. & Ma, J. (2018). *Environ. Sci. Technol.* **52**, 13325–13335.

supporting information

Acta Cryst. (2023). E79 [https://doi.org/10.1107/S205698902300837X]

Crystal structure of dibenzylammonium hydrogen (4-aminophenyl)arsonate monohydrate

Bocar Traoré, Waly Diallo, Mamadou Sidibé, Libasse Diop, Laurent Plasseraud and Hélène Cattey

Computing details

Data collection: *APEX2* V8.34A (Bruker, 2014); cell refinement: *S SAINT* V8.34A (Bruker, 2013); data reduction: *S SAINT* V8.34A (Bruker, 2013); program(s) used to solve structure: *SHELXT* (Sheldrick, 2015a); program(s) used to refine structure: *SHELXL* (Sheldrick, 2015b); molecular graphics: *Olex2* 1.5 (Dolomanov *et al.*, 2009); software used to prepare material for publication: *Olex2* 1.5 (Dolomanov *et al.*, 2009).

Dibenzylammonium hydrogen (4-aminophenyl)arsonate monohydrate

Crystal data

$C_{14}H_{16}N^+ \cdot C_6H_7AsNO_3^- \cdot H_2O$

$M_r = 432.34$

Monoclinic, $P2_1/c$

$a = 9.8242$ (5) Å

$b = 10.6574$ (6) Å

$c = 19.2507$ (11) Å

$\beta = 97.7500$ (18)°

$V = 1997.15$ (19) Å³

$Z = 4$

$F(000) = 896$

$D_x = 1.438$ Mg m⁻³

Mo $K\alpha$ radiation, $\lambda = 0.71073$ Å

Cell parameters from 9824 reflections

$\theta = 2.8$ – 27.5 °

$\mu = 1.73$ mm⁻¹

$T = 100$ K

Prism, clear light colourless

$0.5 \times 0.25 \times 0.18$ mm

Data collection

Bruker D8 VENTURE
diffractometer

Radiation source: X-ray tube, Siemens KFF Mo
2K-90C

TRIUMPH curved crystal monochromator

Detector resolution: 1024 x 1024 pixels mm⁻¹

φ and ω scans

Absorption correction: multi-scan
(SADABS; Krause *et al.*, 2015)

$T_{\min} = 0.610$, $T_{\max} = 0.746$

67932 measured reflections

4584 independent reflections

4119 reflections with $I > 2\sigma(I)$

$R_{\text{int}} = 0.037$

$\theta_{\max} = 27.5$ °, $\theta_{\min} = 2.8$ °

$h = -12 \rightarrow 12$

$k = -13 \rightarrow 13$

$l = -24 \rightarrow 25$

Refinement

Refinement on F^2

Least-squares matrix: full

$R[F^2 > 2\sigma(F^2)] = 0.022$

$wR(F^2) = 0.054$

$S = 1.07$

4584 reflections

261 parameters

0 restraints

Primary atom site location: dual

Hydrogen site location: mixed

H atoms treated by a mixture of independent
and constrained refinement

$w = 1/[\sigma^2(F_o^2) + (0.0228P)^2 + 1.3431P]$

where $P = (F_o^2 + 2F_c^2)/3$

$$(\Delta/\sigma)_{\max} = 0.001$$

$$\Delta\rho_{\max} = 0.42 \text{ e } \text{\AA}^{-3}$$

$$\Delta\rho_{\min} = -0.21 \text{ e } \text{\AA}^{-3}$$

Special details

Geometry. All esds (except the esd in the dihedral angle between two l.s. planes) are estimated using the full covariance matrix. The cell esds are taken into account individually in the estimation of esds in distances, angles and torsion angles; correlations between esds in cell parameters are only used when they are defined by crystal symmetry. An approximate (isotropic) treatment of cell esds is used for estimating esds involving l.s. planes.

Fractional atomic coordinates and isotropic or equivalent isotropic displacement parameters (\AA^2)

| | <i>x</i> | <i>y</i> | <i>z</i> | $U_{\text{iso}}^*/U_{\text{eq}}$ | Occ. (<1) |
|-----|--------------|--------------|-------------|----------------------------------|-----------|
| As | 0.15165 (2) | 0.51188 (2) | 0.42563 (2) | 0.01186 (5) | |
| O1 | 0.04372 (11) | 0.38487 (9) | 0.42927 (6) | 0.0184 (2) | |
| O2 | 0.09995 (10) | 0.63317 (9) | 0.47065 (5) | 0.0167 (2) | |
| O3 | 0.31128 (10) | 0.46779 (10) | 0.45696 (5) | 0.0176 (2) | |
| N2 | 0.08041 (14) | 0.62660 (14) | 0.11336 (7) | 0.0208 (3) | |
| H2A | 0.062 (2) | 0.565 (2) | 0.0867 (10) | 0.025* | |
| H2B | 0.043 (2) | 0.694 (2) | 0.1009 (10) | 0.025* | |
| C1 | 0.13469 (13) | 0.55046 (13) | 0.32872 (7) | 0.0126 (3) | |
| C2 | 0.13667 (14) | 0.45347 (13) | 0.27999 (7) | 0.0152 (3) | |
| H2 | 0.149937 | 0.369445 | 0.295952 | 0.018* | |
| C3 | 0.11956 (15) | 0.47831 (14) | 0.20880 (7) | 0.0164 (3) | |
| H3 | 0.121018 | 0.411363 | 0.176326 | 0.020* | |
| C4 | 0.10001 (14) | 0.60216 (14) | 0.18428 (7) | 0.0150 (3) | |
| C5 | 0.10337 (14) | 0.69966 (13) | 0.23332 (8) | 0.0166 (3) | |
| H5 | 0.094757 | 0.784146 | 0.217604 | 0.020* | |
| C6 | 0.11920 (14) | 0.67391 (13) | 0.30476 (7) | 0.0150 (3) | |
| H6 | 0.119468 | 0.740721 | 0.337450 | 0.018* | |
| O4 | 0.94231 (17) | 0.85325 (13) | 0.45149 (7) | 0.0389 (3) | 0.94 |
| H4A | 0.999317 | 0.790435 | 0.455138 | 0.058* | 0.94 |
| H4B | 0.870836 | 0.825432 | 0.468917 | 0.058* | 0.94 |
| N1 | 0.43532 (12) | 0.63057 (11) | 0.55144 (6) | 0.0142 (2) | |
| H1A | 0.391629 | 0.570678 | 0.522995 | 0.017* | |
| H1B | 0.523283 | 0.604491 | 0.564385 | 0.017* | |
| C7 | 0.36565 (15) | 0.64208 (13) | 0.61550 (7) | 0.0156 (3) | |
| H7A | 0.268703 | 0.667011 | 0.601690 | 0.019* | |
| H7B | 0.411155 | 0.708549 | 0.646221 | 0.019* | |
| C8 | 0.37054 (14) | 0.52036 (13) | 0.65533 (7) | 0.0134 (3) | |
| C9 | 0.49603 (15) | 0.46656 (14) | 0.68231 (8) | 0.0167 (3) | |
| H9 | 0.579319 | 0.506225 | 0.674660 | 0.020* | |
| C10 | 0.50021 (15) | 0.35571 (14) | 0.72019 (8) | 0.0194 (3) | |
| H10 | 0.586162 | 0.319539 | 0.738161 | 0.023* | |
| C11 | 0.37894 (16) | 0.29743 (15) | 0.73190 (8) | 0.0227 (3) | |
| H11 | 0.381734 | 0.221469 | 0.757878 | 0.027* | |
| C12 | 0.25392 (16) | 0.35050 (15) | 0.70557 (9) | 0.0251 (3) | |
| H12 | 0.170863 | 0.311054 | 0.713808 | 0.030* | |
| C13 | 0.24933 (15) | 0.46135 (15) | 0.66711 (8) | 0.0200 (3) | |
| H13 | 0.163208 | 0.496855 | 0.648829 | 0.024* | |

| | | | | | |
|------|--------------|--------------|--------------|------------|------|
| C14 | 0.43754 (16) | 0.75047 (14) | 0.51084 (8) | 0.0194 (3) | |
| H14A | 0.342130 | 0.775473 | 0.493084 | 0.023* | |
| H14B | 0.486851 | 0.736507 | 0.469927 | 0.023* | |
| C15 | 0.50659 (15) | 0.85489 (14) | 0.55510 (8) | 0.0182 (3) | |
| C16 | 0.42794 (16) | 0.94873 (15) | 0.57986 (8) | 0.0220 (3) | |
| H16 | 0.330863 | 0.947490 | 0.568182 | 0.026* | |
| C17 | 0.49027 (19) | 1.04468 (15) | 0.62169 (9) | 0.0277 (4) | |
| H17 | 0.435865 | 1.108628 | 0.638562 | 0.033* | |
| C18 | 0.6313 (2) | 1.04676 (17) | 0.63861 (9) | 0.0322 (4) | |
| H18 | 0.673979 | 1.112232 | 0.667157 | 0.039* | |
| C19 | 0.71081 (18) | 0.95354 (18) | 0.61403 (10) | 0.0323 (4) | |
| H19 | 0.807876 | 0.955423 | 0.625699 | 0.039* | |
| C20 | 0.64919 (16) | 0.85748 (16) | 0.57247 (9) | 0.0249 (3) | |
| H20 | 0.703946 | 0.793541 | 0.555854 | 0.030* | |
| H1 | 0.002 (3) | 0.386 (3) | 0.4638 (14) | 0.062 (8)* | |
| O4B | 0.729 (2) | 0.7346 (18) | 0.4434 (10) | 0.026 (4)* | 0.06 |

Atomic displacement parameters (Å²)

| | U^{11} | U^{22} | U^{33} | U^{12} | U^{13} | U^{23} |
|-----|-------------|-------------|-------------|--------------|-------------|--------------|
| As | 0.01149 (7) | 0.01330 (7) | 0.01092 (7) | −0.00011 (5) | 0.00195 (5) | −0.00127 (5) |
| O1 | 0.0235 (5) | 0.0140 (5) | 0.0192 (5) | −0.0066 (4) | 0.0084 (4) | −0.0043 (4) |
| O2 | 0.0200 (5) | 0.0125 (5) | 0.0187 (5) | −0.0005 (4) | 0.0070 (4) | −0.0030 (4) |
| O3 | 0.0143 (5) | 0.0226 (5) | 0.0150 (5) | 0.0041 (4) | −0.0009 (4) | −0.0025 (4) |
| N2 | 0.0233 (7) | 0.0235 (7) | 0.0151 (6) | 0.0019 (6) | 0.0010 (5) | 0.0037 (5) |
| C1 | 0.0096 (6) | 0.0163 (6) | 0.0119 (6) | −0.0005 (5) | 0.0018 (5) | 0.0004 (5) |
| C2 | 0.0157 (7) | 0.0132 (6) | 0.0164 (7) | 0.0004 (5) | 0.0011 (5) | 0.0009 (5) |
| C3 | 0.0179 (7) | 0.0164 (7) | 0.0147 (7) | 0.0000 (5) | 0.0013 (5) | −0.0022 (5) |
| C4 | 0.0097 (6) | 0.0198 (7) | 0.0158 (7) | 0.0003 (5) | 0.0026 (5) | 0.0029 (5) |
| C5 | 0.0149 (7) | 0.0140 (6) | 0.0211 (7) | 0.0016 (5) | 0.0035 (5) | 0.0042 (5) |
| C6 | 0.0127 (6) | 0.0147 (6) | 0.0179 (7) | −0.0005 (5) | 0.0035 (5) | −0.0018 (5) |
| O4 | 0.0569 (10) | 0.0308 (7) | 0.0304 (7) | 0.0169 (7) | 0.0104 (7) | 0.0108 (6) |
| N1 | 0.0149 (6) | 0.0140 (6) | 0.0132 (6) | −0.0003 (4) | 0.0007 (4) | 0.0000 (4) |
| C7 | 0.0170 (7) | 0.0144 (6) | 0.0160 (7) | 0.0009 (5) | 0.0045 (5) | −0.0008 (5) |
| C8 | 0.0143 (6) | 0.0137 (6) | 0.0123 (6) | −0.0003 (5) | 0.0023 (5) | −0.0020 (5) |
| C9 | 0.0129 (6) | 0.0194 (7) | 0.0181 (7) | −0.0015 (5) | 0.0031 (5) | 0.0003 (6) |
| C10 | 0.0160 (7) | 0.0223 (7) | 0.0198 (7) | 0.0047 (6) | 0.0016 (6) | 0.0031 (6) |
| C11 | 0.0253 (8) | 0.0182 (7) | 0.0247 (8) | 0.0005 (6) | 0.0043 (6) | 0.0059 (6) |
| C12 | 0.0172 (7) | 0.0229 (8) | 0.0354 (9) | −0.0053 (6) | 0.0044 (7) | 0.0068 (7) |
| C13 | 0.0119 (7) | 0.0214 (7) | 0.0260 (8) | −0.0005 (5) | −0.0001 (6) | 0.0028 (6) |
| C14 | 0.0230 (8) | 0.0187 (7) | 0.0161 (7) | −0.0018 (6) | 0.0010 (6) | 0.0048 (6) |
| C15 | 0.0204 (7) | 0.0173 (7) | 0.0169 (7) | −0.0042 (6) | 0.0022 (6) | 0.0057 (6) |
| C16 | 0.0226 (8) | 0.0191 (7) | 0.0246 (8) | −0.0032 (6) | 0.0050 (6) | 0.0045 (6) |
| C17 | 0.0409 (10) | 0.0180 (7) | 0.0256 (8) | −0.0041 (7) | 0.0095 (7) | 0.0018 (6) |
| C18 | 0.0434 (10) | 0.0244 (8) | 0.0276 (9) | −0.0172 (8) | 0.0004 (8) | 0.0012 (7) |
| C19 | 0.0237 (8) | 0.0356 (10) | 0.0358 (10) | −0.0118 (7) | −0.0023 (7) | 0.0051 (8) |
| C20 | 0.0207 (8) | 0.0257 (8) | 0.0283 (8) | −0.0022 (6) | 0.0037 (6) | 0.0044 (7) |

Geometric parameters (Å, °)

| | | | |
|------------|-------------|-------------|-------------|
| As—O1 | 1.7267 (10) | C7—C8 | 1.5044 (19) |
| As—O2 | 1.6730 (10) | C8—C9 | 1.395 (2) |
| As—O3 | 1.6699 (10) | C8—C13 | 1.392 (2) |
| As—C1 | 1.8955 (13) | C9—H9 | 0.9500 |
| O1—H1 | 0.83 (3) | C9—C10 | 1.386 (2) |
| N2—H2A | 0.84 (2) | C10—H10 | 0.9500 |
| N2—H2B | 0.83 (2) | C10—C11 | 1.389 (2) |
| N2—C4 | 1.3776 (19) | C11—H11 | 0.9500 |
| C1—C2 | 1.3978 (19) | C11—C12 | 1.385 (2) |
| C1—C6 | 1.3957 (19) | C12—H12 | 0.9500 |
| C2—H2 | 0.9500 | C12—C13 | 1.392 (2) |
| C2—C3 | 1.384 (2) | C13—H13 | 0.9500 |
| C3—H3 | 0.9500 | C14—H14A | 0.9900 |
| C3—C4 | 1.406 (2) | C14—H14B | 0.9900 |
| C4—C5 | 1.401 (2) | C14—C15 | 1.506 (2) |
| C5—H5 | 0.9500 | C15—C16 | 1.387 (2) |
| C5—C6 | 1.391 (2) | C15—C20 | 1.396 (2) |
| C6—H6 | 0.9500 | C16—H16 | 0.9500 |
| O4—H4A | 0.8696 | C16—C17 | 1.391 (2) |
| O4—H4B | 0.8701 | C17—H17 | 0.9500 |
| N1—H1A | 0.9100 | C17—C18 | 1.380 (3) |
| N1—H1B | 0.9100 | C18—H18 | 0.9500 |
| N1—C7 | 1.4939 (17) | C18—C19 | 1.386 (3) |
| N1—C14 | 1.4995 (18) | C19—H19 | 0.9500 |
| C7—H7A | 0.9900 | C19—C20 | 1.387 (2) |
| C7—H7B | 0.9900 | C20—H20 | 0.9500 |
| O1—As—C1 | 103.71 (6) | C13—C8—C7 | 120.22 (13) |
| O2—As—O1 | 110.71 (5) | C13—C8—C9 | 119.09 (13) |
| O2—As—C1 | 110.47 (6) | C8—C9—H9 | 119.7 |
| O3—As—O1 | 108.46 (5) | C10—C9—C8 | 120.55 (13) |
| O3—As—O2 | 111.48 (5) | C10—C9—H9 | 119.7 |
| O3—As—C1 | 111.73 (5) | C9—C10—H10 | 120.0 |
| As—O1—H1 | 113.0 (19) | C9—C10—C11 | 120.09 (14) |
| H2A—N2—H2B | 116.7 (18) | C11—C10—H10 | 120.0 |
| C4—N2—H2A | 116.7 (13) | C10—C11—H11 | 120.1 |
| C4—N2—H2B | 116.7 (13) | C12—C11—C10 | 119.73 (14) |
| C2—C1—As | 119.52 (10) | C12—C11—H11 | 120.1 |
| C6—C1—As | 121.39 (10) | C11—C12—H12 | 119.8 |
| C6—C1—C2 | 119.08 (13) | C11—C12—C13 | 120.33 (14) |
| C1—C2—H2 | 119.6 | C13—C12—H12 | 119.8 |
| C3—C2—C1 | 120.83 (13) | C8—C13—H13 | 119.9 |
| C3—C2—H2 | 119.6 | C12—C13—C8 | 120.20 (14) |
| C2—C3—H3 | 119.8 | C12—C13—H13 | 119.9 |
| C2—C3—C4 | 120.33 (13) | N1—C14—H14A | 109.2 |
| C4—C3—H3 | 119.8 | N1—C14—H14B | 109.2 |

| | | | |
|----------------|--------------|-----------------|--------------|
| N2—C4—C3 | 120.31 (13) | N1—C14—C15 | 111.83 (12) |
| N2—C4—C5 | 120.99 (13) | H14A—C14—H14B | 107.9 |
| C5—C4—C3 | 118.69 (13) | C15—C14—H14A | 109.2 |
| C4—C5—H5 | 119.7 | C15—C14—H14B | 109.2 |
| C6—C5—C4 | 120.62 (13) | C16—C15—C14 | 119.86 (14) |
| C6—C5—H5 | 119.7 | C16—C15—C20 | 119.40 (14) |
| C1—C6—H6 | 119.8 | C20—C15—C14 | 120.73 (14) |
| C5—C6—C1 | 120.37 (13) | C15—C16—H16 | 119.8 |
| C5—C6—H6 | 119.8 | C15—C16—C17 | 120.45 (15) |
| H4A—O4—H4B | 104.5 | C17—C16—H16 | 119.8 |
| H1A—N1—H1B | 107.7 | C16—C17—H17 | 120.1 |
| C7—N1—H1A | 108.8 | C18—C17—C16 | 119.86 (16) |
| C7—N1—H1B | 108.8 | C18—C17—H17 | 120.1 |
| C7—N1—C14 | 113.62 (11) | C17—C18—H18 | 119.9 |
| C14—N1—H1A | 108.8 | C17—C18—C19 | 120.13 (16) |
| C14—N1—H1B | 108.8 | C19—C18—H18 | 119.9 |
| N1—C7—H7A | 109.4 | C18—C19—H19 | 119.9 |
| N1—C7—H7B | 109.4 | C18—C19—C20 | 120.25 (16) |
| N1—C7—C8 | 111.30 (11) | C20—C19—H19 | 119.9 |
| H7A—C7—H7B | 108.0 | C15—C20—H20 | 120.0 |
| C8—C7—H7A | 109.4 | C19—C20—C15 | 119.91 (16) |
| C8—C7—H7B | 109.4 | C19—C20—H20 | 120.0 |
| C9—C8—C7 | 120.67 (13) | | |
| As—C1—C2—C3 | 177.66 (11) | N1—C14—C15—C20 | 74.49 (17) |
| As—C1—C6—C5 | -178.33 (10) | C7—N1—C14—C15 | 57.65 (16) |
| O1—As—C1—C2 | -44.30 (12) | C7—C8—C9—C10 | 178.70 (13) |
| O1—As—C1—C6 | 135.23 (11) | C7—C8—C13—C12 | -178.27 (14) |
| O2—As—C1—C2 | -162.96 (10) | C8—C9—C10—C11 | -0.3 (2) |
| O2—As—C1—C6 | 16.57 (13) | C9—C8—C13—C12 | 0.3 (2) |
| O3—As—C1—C2 | 72.32 (12) | C9—C10—C11—C12 | 0.0 (2) |
| O3—As—C1—C6 | -108.15 (11) | C10—C11—C12—C13 | 0.4 (3) |
| N2—C4—C5—C6 | 178.11 (13) | C11—C12—C13—C8 | -0.6 (2) |
| C1—C2—C3—C4 | 0.1 (2) | C13—C8—C9—C10 | 0.2 (2) |
| C2—C1—C6—C5 | 1.2 (2) | C14—N1—C7—C8 | -178.14 (11) |
| C2—C3—C4—N2 | -178.78 (13) | C14—C15—C16—C17 | 179.01 (14) |
| C2—C3—C4—C5 | 2.3 (2) | C14—C15—C20—C19 | -179.17 (15) |
| C3—C4—C5—C6 | -3.0 (2) | C15—C16—C17—C18 | 0.1 (2) |
| C4—C5—C6—C1 | 1.3 (2) | C16—C15—C20—C19 | -0.1 (2) |
| C6—C1—C2—C3 | -1.9 (2) | C16—C17—C18—C19 | 0.0 (3) |
| N1—C7—C8—C9 | 60.72 (17) | C17—C18—C19—C20 | -0.2 (3) |
| N1—C7—C8—C13 | -120.76 (14) | C18—C19—C20—C15 | 0.2 (3) |
| N1—C14—C15—C16 | -104.55 (16) | C20—C15—C16—C17 | 0.0 (2) |

Hydrogen-bond geometry (Å, °)

| <i>D</i> —H... <i>A</i> | <i>D</i> —H | H... <i>A</i> | <i>D</i> ... <i>A</i> | <i>D</i> —H... <i>A</i> |
|--------------------------|-------------|---------------|-----------------------|-------------------------|
| N2—H2A...O4 ⁱ | 0.84 (2) | 2.37 (2) | 3.165 (2) | 158.0 (18) |

| | | | | |
|----------------------------|----------|----------|-------------|------------|
| N2—H2B···O1 ⁱⁱ | 0.83 (2) | 2.25 (2) | 3.0769 (17) | 175.6 (18) |
| N1—H1A···O3 | 0.91 | 1.78 | 2.6842 (16) | 172 |
| N1—H1B···O3 ⁱⁱⁱ | 0.91 | 1.89 | 2.7260 (15) | 151 |
| O1—H1···O2 ^{iv} | 0.83 (3) | 1.73 (3) | 2.5445 (15) | 170 (3) |
| O4—H4A···O2 ^v | 0.87 | 1.95 | 2.8074 (18) | 169 |

Symmetry codes: (i) $-x+1, y-1/2, -z+1/2$; (ii) $-x, y+1/2, -z+1/2$; (iii) $-x+1, -y+1, -z+1$; (iv) $-x, -y+1, -z+1$; (v) $x+1, y, z$.