



HAL
open science

Inter-regional correlation estimators for functional magnetic resonance imaging

Sophie Achard, Jean-François Coeurjolly, Pierre Lafaye de Micheaux, Hanâ Lbath, Jonas Richiardi

► **To cite this version:**

Sophie Achard, Jean-François Coeurjolly, Pierre Lafaye de Micheaux, Hanâ Lbath, Jonas Richiardi. Inter-regional correlation estimators for functional magnetic resonance imaging. *NeuroImage*, 2023, 282, pp.120388. 10.1016/j.neuroimage.2023.120388 . hal-04242995

HAL Id: hal-04242995

<https://hal.science/hal-04242995>

Submitted on 15 Oct 2023

HAL is a multi-disciplinary open access archive for the deposit and dissemination of scientific research documents, whether they are published or not. The documents may come from teaching and research institutions in France or abroad, or from public or private research centers.

L'archive ouverte pluridisciplinaire **HAL**, est destinée au dépôt et à la diffusion de documents scientifiques de niveau recherche, publiés ou non, émanant des établissements d'enseignement et de recherche français ou étrangers, des laboratoires publics ou privés.



Distributed under a Creative Commons Attribution 4.0 International License

1 Inter-regional correlation estimators for functional
2 magnetic resonance imaging

3 Sophie Achard^a, Jean-François Coeurjolly^a, Pierre Lafaye de Micheaux^{b,c,d},
4 Hanâ Lbath^a, Jonas Richiardi^e

5 ^a*Univ. Grenoble Alpes, CNRS, Inria, Grenoble-INP, LJK, 38000 Grenoble, France*

6 ^b*AMIS, Université Paul Valéry Montpellier 3, France*

7 ^c*PreMeDICaL - Precision Medicine by Data Integration and Causal Learning, Inria*
8 *Sophia Antipolis, France*

9 ^d*Desbrest Institute of Epidemiology and Public Health, Univ Montpellier, INSERM,*
10 *Montpellier, France*

11 ^e*Department of Radiology, Lausanne University Hospital and University of Lausanne,*
12 *Switzerland*

13 **Abstract**

14 Functional magnetic resonance imaging (fMRI) functional connectivity be-
15 tween brain regions is often computed using parcellations defined by func-
16 tional or structural atlases. Typically, some kind of voxel averaging is per-
17 formed to obtain a single temporal correlation estimate per region pair. How-
18 ever, several estimators can be defined for this task, with various assumptions
19 and degrees of robustness to local noise, global noise, and region size.

20 In this paper, we systematically present and study the properties of 9
21 different functional connectivity estimators taking into account the spatial
22 structure of fMRI data, based on a simple fMRI data spatial model. These
23 include 3 existing estimators and 6 novel estimators. We demonstrate the em-
24 pirical properties of the estimators using synthetic, animal, and human data,
25 in terms of graph structure, repeatability and reproducibility, discriminabil-
26 ity, dependence on region size, as well as local and global noise robustness.

27 We prove analytically the link between regional intra-correlation and
28 inter-region correlation, and show that the choice of estimator has a strong in-
29 fluence on inter-correlation values. Some estimators, including the commonly
30 used *correlation of averages* (CA), are positively biased, and have more depen-
31 dence to region size and intra-correlation than robust alternatives, resulting
32 in spatially-dependent bias. We define the new *local correlation of averages*
33 estimator with better theoretical guarantees, lower bias, significantly lower
34 dependence on region size (Spearman correlation 0.40 vs 0.55, paired t-test
35 $T=27.2$, $p = 1.1e^{-47}$), at negligible cost to discriminative power, compared
36 to the CA estimator.

37 The difference in connectivity pattern between the estimators is not dis-
38 tributed uniformly throughout the brain, but rather shows a clear ventral-
39 dorsal gradient, suggesting that region size and intra-correlation plays an
40 important role in shaping functional networks defined using the CA estima-
41 tor, and leading to non-trivial differences in their connectivity structure. We
42 provide an open source R package and equivalent Python implementation
43 to facilitate the use of the new estimators, together with preprocessed rat
44 time-series.

45 *Keywords:* functional connectivity, correlation, aggregated data, familial
46 correlations, serial correlations

47 1. Introduction

48 Functional connectivity of the brain is estimated from observations using
49 non invasive techniques such as electroencephalography (EEG), magnetoen-
50 cephalography (MEG) or functional Magnetic Resonance Imaging (fMRI).

51 Each recording provides time series associated to spatial locations within re-
52 gions of the brain. Functional connectomes, that is, graphs representing the
53 estimated connectivity, are then constructed by computing dependence mea-
54 sures between the time series. These connectomes are used in fundamental
55 neuroscience, for example to study development (Fan et al., 2021; Tooley
56 et al., 2021), and in clinical neuroscience, to characterize psychiatric (For-
57 nito et al., 2017) or neurological (Fornito et al., 2015) disorders. They form
58 a compact yet expressive representation of brain activity that can be used
59 for downstream analysis tasks such as diagnosis (Castellanos et al., 2013)
60 or more generally machine learning approaches (Richiardi et al., 2013; Dadi
61 et al., 2019).

62 For graph construction, typically, each region of the brain, defined by a
63 structural or functional parcellation, is associated to a given set of voxels
64 amongst the thousands for which a signal is recorded. The idea is then to
65 extract a representative of the set of voxels to attach one time series to each
66 region. When structural atlases are used, the most common approach is to
67 take the average of the voxel time series at each time point. Indeed, almost
68 70% of papers on PubMed that used the Human Connectome Project dataset
69 to conduct functional-connectivity-related studies in the last five years (e.g.,
70 Ogawa (2021); Figueroa-Jimenez et al. (2021); Bolt et al. (2017); Zhang et al.
71 (2016)) use this method (cf. Appendix Appendix A). While there are nu-
72 merous other approaches to connectivity estimation (including the related
73 techniques for estimating parcellation from connectivity, see, e.g., Eickhoff
74 et al. (2015), or using regional medians (Braun et al., 2012) or eigenvec-
75 tors (Büchel and Friston, 1997; Braun et al., 2012) instead of means), we

76 focus on correlations between averaged regional time-courses, and argue that
77 this technique introduces bias in the estimation of the functional connec-
78 tomes.

79

80 The choice of acquisition sequence and hardware, physiological noise (Caballero-
81 Gaudes and Reynolds, 2017), preprocessing (Braun et al., 2012), and sub-
82 ject motion all impact correlation estimators. Acquisition effects are site-
83 dependent, causing heterogeneity problems in multi-site studies, although
84 various harmonization techniques have been proposed as mitigation Cas-
85 trillon et al. (2014); ?. In addition, it has been shown that computation
86 of connectomes is affected by three main parameters: the length of the
87 acquisition (Whitlow et al., 2011; Van Dijk et al., 2010), the number of
88 regions (Stanley et al., 2013; Cao et al., 2019) and the chosen frequency
89 band (Cordes et al., 2001; Salvador et al., 2005; Braun et al., 2012; Chen and
90 Glover, 2015). Finally, sample size will also play a role in terms of group
91 comparisons (Termenon et al., 2016).

92 Aggregation across voxels is often used because one wishes to increase
93 the signal to noise ratio. This approach is also common in other areas of
94 statistical analysis, for instance because the data are collected in different
95 groups, organizations, or regions. However, difficult challenges arise due to
96 the presence of correlations within the collected datasets.

97 *Measurement errors* can impact inter-region correlations. They have been
98 well studied in fMRI, and are related to both the hardware and the sub-
99 ject (Greve et al., 2013). They are known to impart correlation structure
100 to the data that is not linked to neural activity (Jo et al., 2010; Murphy

101 et al., 2013), at various spatial scales. This problem is also common in other
102 areas of statistical analysis. For example, Ostroff (1993) studied correlations
103 between the score variables *job satisfaction* and *technology* (i.e., perception
104 of the amount of standardization of tasks performed) both at the individ-
105 ual and organizational levels (individuals grouped into organizations such as
106 companies). When organization-level estimates of correlation (i.e., correla-
107 tions based on aggregated data) are obtained by averaging individual-level
108 estimates of correlations, they showed that the ratio of individual to orga-
109 nizational correlations varied widely depending on measurement errors as
110 well as other factors. This is an instance of the *fallacy of the wrong level*,
111 when “correlations at a more macro level are used to make inference about
112 individuals, or vice versa” Ostroff (1993).

113 *Region size* can also influence inter-region correlations. In fMRI, the de-
114 pendence of inter-region correlations on brain region size has been noted (Achard
115 et al., 2011), showing a positive relationship between region size and correla-
116 tion values to the rest of the brain. This is particularly problematic because
117 many atlases have some dependency between region size and spatial location
118 (e.g. some deep gray matter structure may be parcellated into smaller re-
119 gions or subregions than cortical structures). It has also been shown that
120 temporal autocorrelation increases with region size, both for volume-based
121 and surface-based parcellation (Afyouni et al., 2019), and that at a small
122 scale regional homogeneity (Zang et al., 2004) – also called local connectivity
123 and measured by the Kendall correlation coefficient of small neighbourhood
124 time series – is larger for 9-voxel than for 27-voxels neighbourhoods (Jiang
125 and Zuo, 2016).

126 In studies of familial data (Rosner et al., 1977), specific characteristics
127 are obtained for different families with different sizes: *correlation between the*
128 *children and parents* and the *average of correlations between all children and*
129 *parents* are not equal in the majority of cases, due to differing number of
130 children per family.

131 Finally, the *spatial aspect* of the data also complicates correlation estima-
132 tion, in particular due to spatial autocorrelation between voxels (more simply
133 named spatial correlation in the rest of the paper). Spatial correlation means
134 that observations in neighbouring voxels are not independent . However, in-
135 dependence is an assumption many statistical estimators rely on to simplify
136 hypothesis testing by enabling the application of the central limit theorem,
137 leading to false positives and artificially low p -values. Spatial correlation has
138 been identified to be present in fMRI data previously, in particular in activa-
139 tion studies. Even if the methods to take into account the spatial correlation
140 are different from the functional connectivity, it is worth detailing these spe-
141 cific approaches here. The common point between our problem in this paper
142 and the activation studies is that spatial correlation has an impact on the
143 design of the methodological approaches. Indeed, two classical approaches
144 in fMRI activation studies are to either assume voxel independence, or con-
145 versely to smooth the data (Hartvig and Jensen, 2000). Smoothing itself can
146 lead to location and amplitude mis-estimation (Descombes et al., 1998); al-
147 ternatively, estimating smoothness from data allows adjusting effective num-
148 ber of degrees of freedom and reducing false positives, but can itself lead to
149 variability in p -values from hypothesis tests (Poline et al., 1995). Spatial cor-
150 relation has also been shown to deflate p -values in structural imaging (Burt

151 et al., 2020), and has long been recognized as an issue in functional con-
152 nectivity, for instance with early voxelwise (PET) connectivity approaches
153 removing correlation “between neighbouring voxels which can be attributed
154 to spatial correlation” (Cao and Worsley, 1999). More recently, methods from
155 spatial statistics have been applied for clustering fMRI data (Ye et al., 2009,
156 2011), and spatial correlation-preserving null models have been proposed to
157 compare functional network maps (Alexander-Bloch et al., 2018; Markello
158 and Misic, 2021) and thus avoid [deflated](#) p -values due to spatial correlation.
159 Computing correlations is also common when geostatistics is applied to ecol-
160 ogy, geography, climate studies, and more. The data collected in these fields
161 are attached to a spatial position and usually with spatial correlation. The
162 problem was first reported by Student (1914), and studied in (Clifford et al.,
163 1989) for two spatial processes. Applications of these methods can be found
164 for example in the study of meteorological data (Gunst, 1995).

165 In all these fields of application, the main difficulty is to take into account
166 spatial correlation when the goal is to construct estimators of correlation and
167 to build testing procedures when the averaged variables are not independent.

168
169 In light of the above, preferable inter-correlation estimators should exhibit
170 at least four properties i) face validity, ii) high repeatability, iii) preservation
171 of the differences between individuals (discriminative power), and iv) inde-
172 pendence from region size. In this paper, we question the default choice of
173 using correlations of averages of voxel timecourses, and examine in details
174 the assumptions of various methods and their robustness to various types of
175 noise. We propose first a simple definition of a spatial model of fMRI with

176 intra-correlations within brain regions. Then, computations of correlations
 177 are described and we show the potential bias in the estimators. Based on
 178 simulations, we illustrate the good behaviour of the newly introduced esti-
 179 mators. Finally, we conclude with results on human data and rat data.

180 2. Proposed estimators of correlation

181 2.1. Definition of the proposed spatial model for fMRI data

Let $\mathcal{C} \subset \mathbb{Z}^d$, $d \in \mathbb{N}^*$, be a finite compact set of multi-indices. In the context of our application, $d = 3$ and \mathcal{C} contains all 3-tuples indexing the voxels of a three-dimensional image of a brain. Each brain is virtually partitioned into J regions of interest which are represented through their subsets of voxels \mathcal{R}_j of cardinality $\#\mathcal{R}_j = N_j$, $j = 1, \dots, J$. We thus have

$$\mathcal{C} = \cup_{j=1}^J \mathcal{R}_j \text{ and } \#\mathcal{C} = \sum_{j=1}^J N_j.$$

182 For any d -tuple $i \in \mathcal{C}$, a signal $Y_i(\cdot)$ sampled at times $t = 1, \dots, T$ is
 183 observed and we assume that it can be decomposed as follows

$$Y_i(t) = X_i(t) + \varepsilon_i(t) + e(t), \tag{1}$$

184 where $X_i(\cdot)$ is an unobserved signal of interest, $\varepsilon_i(\cdot)$ is a *local noise* con-
 185 taminating locally the signal $X_i(\cdot)$, and $e(\cdot)$ is a *global noise* corrupting in
 186 the same way the signal measured in each voxel indexed by an element of \mathcal{C} .
 187 This can be, e.g., a consequence of thermal or background noise (Lazar, 2008;
 188 Greve et al., 2013), which at high field strength has been shown to explain a
 189 high proportion of noise variance (Greve et al., 2011).

190 We make a few assumptions on these different components. First, we
191 assume that all random variables are centered. We also assume that the
192 signals $X_i(\cdot)$, $\varepsilon_i(\cdot)$ and $e(\cdot)$ are mutually independent and independent in
193 time. This is not an overly restrictive assumption as for the applications pre-
194 sented in Section 3 we preprocess the data by applying a wavelet transform.
195 And it is now well-known (Moulines et al., 2007), that if a random time se-
196 ries has short or long memory characteristics, after a wavelet decomposition,
197 this signal can be approximated to be decorrelated in time for large wavelet
198 scales. In addition, assuming that the X_i 's are centered is coherent as it is
199 a well-known fact that a wavelet decomposition based on a wavelet mother
200 with K vanishing moments cancels out every polynomial trend with degree
201 $K - 1$. Assuming that the local and global noises are homoskedastic with
202 a variance denoted respectively by σ_ε and σ_e is also not restrictive. Finally,
203 we will be assuming (again following the literature Lazar (2008); Greve et al.
204 (2011, 2013)) that the local noise ε is not too strongly spatially dependent
205 and more precisely that two voxels far away have uncorrelated local noise.
206 This is made more precise in Section 2.2.

207 *2.2. Spatial correlation structure induced by model (1)*

208 Let $i, i' \in \mathcal{C}$, $j, j' = 1, \dots, J$ ($j \neq j'$) and for all $t = 1, \dots, T$, we assume
209 that there exists $\sigma_j > 0$, $\sigma_\varepsilon \geq 0$, $r_{jj'} \in [-1, 1]$, $\rho_{ii'} \in (0, 1]$, $\eta_{ii'} \in [-1, 1]$ such
210 that

$$E[X_i(t)X_{i'}(t)] = \begin{cases} \sigma_j\sigma_{j'}r_{jj'} & \text{if } i \in \mathcal{R}_j, i' \in \mathcal{R}_{j'}, j \neq j', \\ \sigma_j^2\rho_{ii'} & \text{if } i, i' \in \mathcal{R}_j \end{cases}$$

211 and

$$E[\varepsilon_i(t)\varepsilon_{i'}(t)] = \sigma_\varepsilon^2\eta_{ii'} \text{ if } i, i' \in \mathcal{R}_j.$$

212 The parameter $r_{jj'}$ represents the correlation between two (unobserved) sig-
 213 nals of two different regions \mathcal{R}_j and $\mathcal{R}_{j'}$ and is called inter-correlation be-
 214 tween regions \mathcal{R}_j and $\mathcal{R}_{j'}$ in the following. This is the parameter of interest
 215 we focus on in the rest of the paper. The parameter $\rho_{ii'}$ represents the
 216 intra-correlation between two (unobserved) signals inside a common region.
 217 Moreover, the parameter $\eta_{ii'}$ represents the spatial correlation between two
 218 local noises inside a common region. We assume that inside each region, the
 219 signals of interest have positive intra-correlation. This is supported by liter-
 220 ature (Uddin et al., 2008; Tomasi and Volkow, 2010; Jiang and Zuo, 2016).
 221 We also assume that for each time t and for $j = 1, \dots, J$, $\{X_i(t), i \in \mathcal{R}_j\}$
 222 (resp. $\{\varepsilon_i(t), i \in \mathcal{C}\}$) is a second-order stationary and isotropic (with respect
 223 to the uniform norm) random field defined over \mathcal{R}_j (resp. \mathcal{C}). This means in
 224 particular that both the correlations $\rho_{ii'}$ (for any $i, i' \in \mathcal{R}_j$ for some j) and
 225 $\eta_{ii'}$ (for $i, i' \in \mathcal{C}$) depend only on the (uniform) distance (that is the usual
 226 distance on the lattice, e.g. Gaetan et al. (2010)) between the two voxels i
 227 and i' . For brevity, we still denote $\rho_{|i'-i|}$ by $\rho_{ii'}$ and $\eta_{|i'-i|}$ by $\eta_{ii'}$ where for
 228 $x \in \mathbb{Z}^d$, the notation $|x|$ stands for the uniform norm. Our a priori hypothesis
 229 is that the intra-correlation ρ_δ is close to 1 for moderate distances δ , meaning
 230 that close neighbours are strongly (positively) correlated. Finally, we assume
 231 that the local noise is p -dependent, i.e., $\eta_\delta = 0$ for any $\delta > p$. Without loss of
 232 generality, we also intrinsically assume that for all $i \in \mathcal{R}_j$ and $i' \in \mathcal{R}_{j'}$, $\varepsilon_i(t)$
 233 and $\varepsilon_{i'}(t)$ are uncorrelated. This simplifies the presentation in the next sec-
 234 tions. Furthermore, in the sequel, employing a slight abuse of language, we
 235 refer to the correlation between two voxels instead of the correlation between
 236 the signals originating from those voxels.

237 Hence, this results in the following (spatial) correlation structure for the
 238 signals Y_i and $Y_{i'}$ at time t :

$$E[Y_i(t)Y_{i'}(t)] = \begin{cases} \sigma_j\sigma_{j'}r_{jj'} + \sigma_e^2 & \text{if } i \in \mathcal{R}_j, i' \in \mathcal{R}_{j'}, j \neq j', \\ \sigma_j^2\rho_{|i-i'|} + \sigma_\varepsilon^2\eta_{|i-i'|} + \sigma_e^2 & \text{if } i, i' \in \mathcal{R}_j \text{ and } |i - i'| \leq p \\ \sigma_j^2\rho_{|i-i'|} + \sigma_e^2 & \text{if } i, i' \in \mathcal{R}_j \text{ and } |i - i'| > p. \end{cases}$$

239

240 Given a parcellation of the brain, the objective is to estimate inter-
 241 correlations $r_{jj'}$ for each pair of regions of interest, independently of the
 242 parameters $\sigma_j, \sigma_{j'}, \sigma_\varepsilon, \sigma_e, \rho_{ii'}, \eta_{ii'}$ which are viewed as nuisance parameters.
 243 We do not model the distribution of Y_i but only its second-order properties
 244 (through X_i, ε_i, e). As said before, we consider the intra-correlations, the
 245 correlation of the local noise and the different variances as nuisance parame-
 246 ters that we do not want to estimate. In the next section, we present various
 247 estimators of $r_{jj'}$ built in order to address one (or several) of the following
 248 cases: (1) the regions of interest \mathcal{R}_j and $\mathcal{R}_{j'}$ may contain a different number
 249 of voxels; (2) the intra-correlation may deviate strongly from 1 (especially
 250 for large regions); (3) there may be a non negligible local noise ε_i affecting
 251 the signal in each region; (4) there may be a global noise affecting all regions.

252 *2.3. Inter-correlation: notation and properties*

253 Let $\mathbf{Y}_1 = (Y_1(1), \dots, Y_1(T))$ and $\mathbf{Y}_2 = (Y_2(1), \dots, Y_2(T))$ denote two
 254 voxel time-series of length T . The notation $\widehat{\text{Cov}}(\mathbf{Y}_1, \mathbf{Y}_2)$, $\widehat{\text{Cor}}(\mathbf{Y}_1, \mathbf{Y}_2)$ and
 255 $\widehat{\sigma}^2(\mathbf{Y}_1)$ stand for the sample covariance between \mathbf{Y}_1 and \mathbf{Y}_2 , the sample
 256 correlation between \mathbf{Y}_1 and \mathbf{Y}_2 and the sample variance of \mathbf{Y}_1 , respectively.
 257 For any $j = 1, \dots, J$, we define a ν -neighbourhood and denote it by \mathcal{V} as a
 258 subset of $n_\nu := (2\nu + 1)^d$ indices, all of which are at a distance less than or

259 equal to ν from the center j of the neighbourhood. For any set of indices
 260 E (which could be a ν -neighborhood or a region of interest) and any spatio-
 261 temporal field $Z_i(t)$ (which could be $Y_i, X_i, \varepsilon_i, \dots$) we denote by $\bar{Z}_E(t)$ for
 262 $t = 1, \dots, T$ the time series spatially averaged over E , that is

$$\bar{Z}_E(t) = \frac{1}{\#E} \sum_{i \in E} Z_i(t).$$

To sum up, we reserve the bold notation to mainly denote a vector of length T , the notation $\hat{\cdot}$ to denote an average over time while $\bar{\cdot}$ will denote an average over space. Hence, for instance $\hat{\sigma}^2(\bar{\mathbf{Y}}_E)$ denotes the sample variance of the vector with components $(\#E)^{-1} \sum_{i \in E} Y_i(t)$ for $t = 1, \dots, T$. We also let

$$\bar{\rho}_E = \frac{1}{(\#E)^2} \sum_{i, i' \in E} \rho_{ii'} \quad \text{and} \quad \bar{\eta}_E = \frac{1}{(\#E)^2} \sum_{i, i' \in E} \eta_{ii'}. \quad (2)$$

263 The quantity $\bar{\rho}_E$ represents the (spatial) average intra-correlation inside the
 264 set E . If E corresponds to a ν -neighborhood with moderate ν , we may
 265 expect $\bar{\rho}_\nu$ to be close to 1. Such an observation is probably less realistic
 266 when $E = \mathcal{R}_j$ especially for large regions. The quantity $\bar{\eta}_E$ is related to the
 267 (spatial) correlation structure of the local noise. By assuming this noise to
 268 be p -dependent (that is $\eta_\delta = 0$ when $\delta \geq p$), it is clear that the larger $\#E$
 269 the smaller $\bar{\eta}_E$.

Using the assumption given in Section 2.1, for any $E \subseteq \mathcal{R}_j$ and $E' \subseteq \mathcal{R}_{j'}$, we deduce

$$\text{Cov}[\bar{Y}_E(t), \bar{Y}_{E'}(t)] = \begin{cases} \sigma_j \sigma_{j'} r_{jj'} + \sigma_e^2, & \text{if } j \neq j', \\ \sigma_j^2 \bar{\rho}_{E, E'} + \sigma_e^2, & \text{if } j = j', \end{cases}$$

where

$$\bar{\rho}_{E,E'} = \frac{1}{(\#E)(\#E')} \sum_{i \in E, i' \in E'} \rho_{|i-i'|}.$$

The variance can also be deduced as follows:

$$\text{Var}[\bar{Y}_E(t)] = \sigma_j^2 \bar{\rho}_E + \sigma_\varepsilon^2 \bar{\eta}_E + \sigma_e^2.$$

270 The detail of this result is given in Proposition Appendix C.1.

271 To lighten the expression of estimators proposed in the next sections, we
 272 define for $j, j' \in \{1, \dots, J\}$

$$\sigma_{\varepsilon,j} = \frac{\sigma_\varepsilon}{\sigma_j}, \quad \sigma_{e,j} = \frac{\sigma_e}{\sigma_j}, \quad \text{and} \quad \sigma_{e,jj'} = \frac{\sigma_e}{\sqrt{\sigma_j \sigma_{j'}}}. \quad (3)$$

273 In the next sections, we set j, j' and thus aim to estimate $r_{jj'}$ independently
 274 of the other parameters. The definition of standard estimators as well as
 275 novel estimators may look complicated due to the large amount of notation
 276 induced by the spatio-temporal correlation structure of Y and the methods
 277 themselves. However, we have postponed as much as possible theoretical
 278 contents to Appendix and present the estimation methods from an intuitive
 279 point of view in Figures 1-2 in order to make next sections readable and
 280 reproducible.

281 2.4. Existing inter-correlation estimators

282 We first review existing inter-regional correlation estimators using a uni-
 283 fied notation throughout¹. Results on consistency of the estimators are pro-
 284 vided in Appendix C-Appendix G.4.

¹In a previous study (Achard et al., 2011), we already described three of the estimators discussed here (CA, AC, ℓ CA), but not with a unified notation, as well as a fourth estimator which is only discussed in the appendix of the present paper

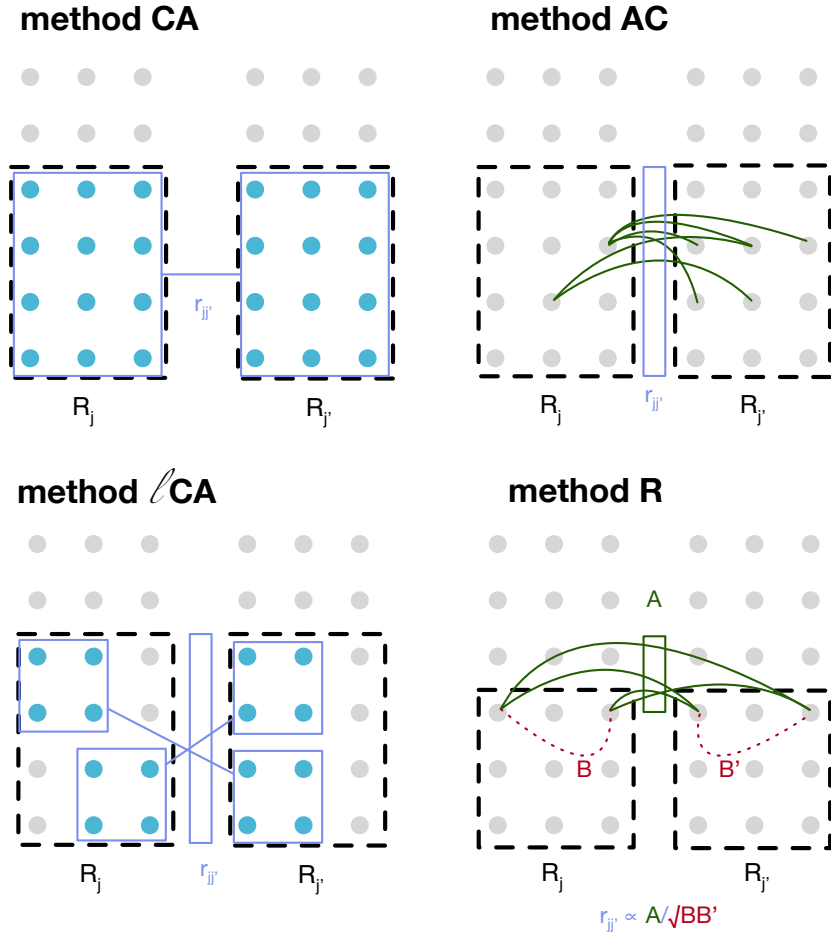

Figure 1: Graphical overview of the inter-regional correlation estimators CA, AC, ℓ CA, and R discussed in this paper. Gray dots represents voxels. Dashed black lines represent brain regions. Edges between voxels represent voxel-voxel temporal correlations. Blue rectangles show the region and level of aggregation (voxels or correlations). $r_{jj'}$ shows quantities involved in the computation of the inter-regional correlations. Illustrations are approximate, please refer to the relevant equations for the exact definition. Neighbourhood versions of the estimators (starting with ℓ) use the same principles but involve aggregating in small neighbourhoods within regions.

285 *2.4.1. Correlation of averages (method CA)*

286 In order to increase the signal-to-noise ratio, the most standard method in
 287 fMRI is to average (or sometimes convolve with a Gaussian kernel) the signal
 288 in space (in each region of interest). The aggregated correlation estimator
 289 corresponds to the standard estimator (see Section 1) considered for example
 290 in Achard et al. (2006), Bolt et al. (2017) or Ogawa (2021):

$$\widehat{r}_{jj'}^{\text{CA}} = \frac{\widehat{\text{Cov}}(\bar{\mathbf{Y}}_{\mathcal{R}_j}, \bar{\mathbf{Y}}_{\mathcal{R}_{j'}})}{\widehat{\sigma}(\bar{\mathbf{Y}}_{\mathcal{R}_j})\widehat{\sigma}(\bar{\mathbf{Y}}_{\mathcal{R}_{j'}})}. \quad (4)$$

291 This estimator, illustrated in Figure 1 was designed to reduce the local
 292 noise. Indeed, in the absence of global noise ($\sigma_e^2 = 0$), this estimator tends
 293 to $r_{jj'}/\sqrt{(\bar{\rho}_{\mathcal{R}_j} + \sigma_{\varepsilon,j}^2\bar{\eta}_{\mathcal{R}_j})(\bar{\rho}_{\mathcal{R}_{j'}} + \sigma_{\varepsilon,j'}^2\bar{\eta}_{\mathcal{R}_{j'}})}$. The interest of averaging before
 294 computing correlations is clear: the local noise is smoothed, thus $\bar{\eta}_{\mathcal{R}_j} =$
 295 $\mathcal{O}(1/N_j)$ is probably very small. However, even in absence of noise ($\sigma_e =$
 296 $\sigma_e = 0$), $\widehat{r}_{jj'}^{\text{CA}}$ has a serious drawback since it estimates $r_{jj'}/\sqrt{\bar{\rho}_{\mathcal{R}_j}\bar{\rho}_{\mathcal{R}_{j'}}$ which
 297 is highly dependent on intra-correlation. Just to give an example, assume
 298 $r_{jj'} = 1/2$, $N_j = N_{j'} = 2$, $\rho_1 = 0$ then $\bar{\rho}_{\mathcal{R}_j} = \bar{\rho}_{\mathcal{R}_{j'}} = 1/2$ then $\widehat{r}_{jj'}^{\text{CA}}$ will
 299 converge towards 1 and not 1/2. This is a caricature but illustrates what
 300 may happen for large regions when some of the signals X_i are not enough
 301 positively intra-correlated. That fact was already pointed out by Achard
 302 et al. (2011).

303 *2.4.2. Average of correlations (method AC)*

304 Instead of evaluating correlation of spatial averages, it is natural to per-
 305 form the (spatial) average of correlations. This estimator, illustrated in Fig-

306 ure 1, is given by:

$$\widehat{r}_{jj'}^{\text{AC}} = \frac{1}{N_j N_{j'}} \sum_{i \in \mathcal{R}_j, i' \in \mathcal{R}_{j'}} \widehat{\text{Cor}}(\mathbf{Y}_i, \mathbf{Y}_{i'}). \quad (5)$$

307 As seen from Table 1, in absence of global noise ($\sigma_e^2 = 0$) and when the
 308 variances are equal to 1, this estimator estimates the quantity $r_{jj'}/(1 + \sigma_\varepsilon^2)$
 309 which makes this estimator robust to large regions (for which $\bar{\rho}_{\mathcal{R}_j}$ may be far
 310 from 1) but more sensitive to local noise than the estimator $\widehat{r}_{jj'}^{\text{CA}}$.

311 2.4.3. Replicates for correlations (method R)

312 In order to cancel out the effect of local noise, we introduce to fMRI a
 313 slight adaptation of the estimator introduced by Bergholm et al. (2010), in
 314 the context of image analysis. This is based on the concept of replicates
 315 within the same region, and denoted by \widehat{r}^{R} (R for replicates). The idea
 316 is to take two samples within each region, called replicates, to be able to
 317 compute correlation using these replicates to cancel out the local noise. These
 318 replicates can be chosen randomly a certain number of times denoted B . This
 319 estimator, illustrated in Figure 1, is then obtained as a Monte-Carlo mean
 320 (or bootstrap) over different random replicates

$$\widehat{r}_{jj'}^{\text{R}} = \frac{1}{B} \sum_{b=1}^B \frac{\frac{1}{4} \sum_{\alpha, \beta=1}^2 \widehat{\text{Cor}}(\mathbf{Y}_{i_\alpha^{(b)}}, \mathbf{Y}_{i'_\beta^{(b)}})}{\sqrt{|\widehat{\text{Cor}}(\mathbf{Y}_{i_1^{(b)}}, \mathbf{Y}_{i_2^{(b)}}) \widehat{\text{Cor}}(\mathbf{Y}_{i'_1^{(b)}}, \mathbf{Y}_{i'_2^{(b)}})|}} \quad (6)$$

321 where for $b = 1, \dots, B$, $i_1^{(b)}, i_2^{(b)} \in \mathcal{R}_j$ are such that $|i_2^{(b)} - i_1^{(b)}| = \delta \geq p$. In
 322 the same way, $i'_1^{(b)}, i'_2^{(b)} \in \mathcal{R}_{j'}$ are such that $|i'_2^{(b)} - i'_1^{(b)}| = \delta \geq p$. Under equal
 323 variances and absence of global noise, $\widehat{r}_{jj'}^{\text{R}}$ estimates $1/|\rho_\delta|$ which is clearly
 324 independent of σ_ε^2 and may be expected to be close to one if δ is small.

325 *2.5. Novel estimators: discarding the effect of global and/or local noise*

326 *2.5.1. Use of a priori uncorrelated regions (method D based on differences)*

327 We now present an estimator which handles the problem of global noise.
 328 To achieve this task, we assume that among the regions where the signal is
 329 recorded there are at least two regions say \mathcal{R}_k and $\mathcal{R}_{k'}$ which are uncorrelated
 330 between themselves and from all the other ones. With a slight abuse of
 331 notation, k, k' will be used for the indices of these two regions, while j, j' will
 332 be used when we are interested in the inter-correlation between regions \mathcal{R}_j
 333 and $\mathcal{R}_{j'}$ (hence $r_{jk} = r_{jk'} = r_{j'k} = r_{j'k'} = 0$). This assumption is realistic in
 334 the context of fMRI data where we are interested in the correlations between
 335 cortical regions. Indeed, the field of view is typically larger than the brain
 336 itself, and the definition of extra regions is possible, for instance using air
 337 voxels or muscle voxels. The estimator is illustrated in Figure 2.

338 We propose the following strategy: for $b = 1, \dots, B$ let $i^{(b)}, i'^{(b)}, k^{(b)}$ and
 339 $k'^{(b)}$ be voxels of $\mathcal{R}_j, \mathcal{R}_{j'}, \mathcal{R}_k$ and $\mathcal{R}_{k'}$.

$$\hat{r}_{jj'}^D = \frac{1}{B} \sum_{b=1}^B \widetilde{\text{Cor}}(\mathbf{Y}_{i^{(b)}}, \mathbf{Y}_{i'^{(b)}}; \mathbf{Y}_{k^{(b)}}, \mathbf{Y}_{k'^{(b)}}), \quad (7)$$

340 where for four vectors $\mathbf{Y}_1, \mathbf{Y}_2, \mathbf{Y}_3$ and \mathbf{Y}_4 (with same length)

$$\widetilde{\text{Cor}}(\mathbf{Y}_1, \mathbf{Y}_2; \mathbf{Y}_3, \mathbf{Y}_4) = \frac{\widehat{\text{Cov}}(\mathbf{Y}_1 - \mathbf{Y}_3, \mathbf{Y}_2 - \mathbf{Y}_4)}{\widehat{s}(\mathbf{Y}_1, \mathbf{Y}_3, \mathbf{Y}_4) \widehat{s}(\mathbf{Y}_2, \mathbf{Y}_3, \mathbf{Y}_4)} \quad (8)$$

341 and where for three vectors \mathbf{U}, \mathbf{V} and \mathbf{W} with same length

$$\widehat{s}^2(\mathbf{U}, \mathbf{V}, \mathbf{W}) = (\widehat{\sigma}^2(\mathbf{U} - \mathbf{V}) + \widehat{\sigma}^2(\mathbf{U} - \mathbf{W}) - \widehat{\sigma}^2(\mathbf{V} - \mathbf{W})) / 2.$$

342 The intuition of this estimator is quite simple. Assume that the local noise
 343 has zero variance. Since the noise $e(\cdot)$ is global, subtracting from $Y_{i^{(b)}}(t)$ the

344 value $Y_{k^{(b)}}(t)$ and from $Y_{j^{(b)}}(t)$ the value $Y_{k^{(b)}}(t)$ discards the global noise.
 345 And since the regions \mathcal{R}_k and $\mathcal{R}_{k'}$ are not correlated and not correlated to
 346 the other ones, the numerator (for each b) is an estimate of $\sigma_j \sigma_{j'} r_{jj'}$. Then,
 347 we just have to divide by estimates of σ_j (and $\sigma_{j'}$). We observe that this
 348 cannot be done using simply $\hat{\sigma}^2(\mathbf{Y}_{j^{(b)}} - \mathbf{Y}_{k^{(b)}})$ which estimates $\sigma_j^2 + \sigma_k^2 + 2\sigma_\varepsilon^2$.
 349 This justifies the introduction of \hat{s}^2 .

350 Note that $\hat{r}_{jj'}^D$ is still biased with respect to local noise (see Table 1).

351 An illustration of estimator D is provided in Figure 2, and a more formal
 352 proposition and proof for this estimator are provided in Appendix E.

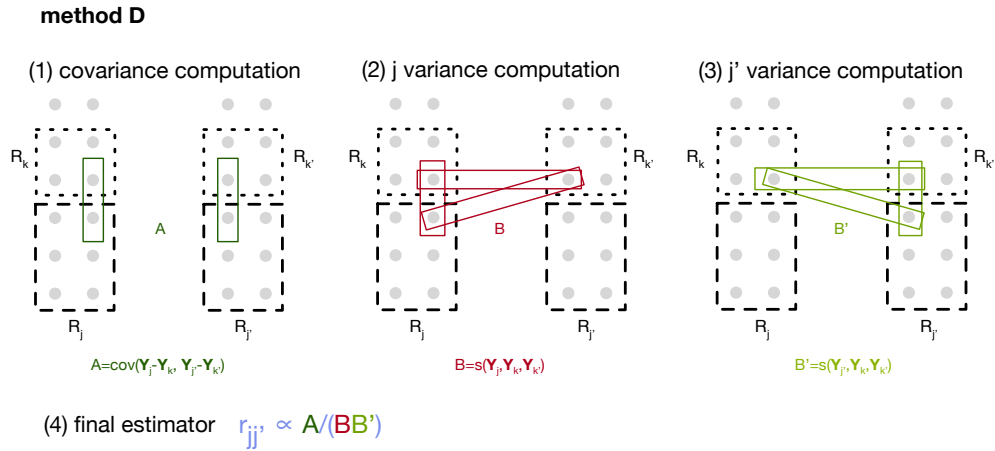

Figure 2: Main steps involved in computing the inter-regional correlation estimator D. Dashed black lines represent brain regions of interest \mathcal{R}_j and $\mathcal{R}_{j'}$. Dotted black lines represent a priori uncorrelated region (e.g. air or muscle voxels) \mathcal{R}_k and $\mathcal{R}_{k'}$. Colored rectangles show the voxels involved in the computation. The final inter-regional correlation estimator $r_{jj'}$ is defined in terms of the intermediate quantities computed in these three steps. See Figure 1 for more details and other estimators.

353 *2.5.2. Replicates and use of a priori disconnected regions: method RD*

354 Combining replicates and the idea based on differences motivates us to
 355 propose the following estimator (see Sections 2.4.3 and 2.5.1 for notation)

$$\hat{r}_{jj'}^{\text{RD}} = \frac{1}{B} \sum_{b=1}^B \frac{\frac{1}{4} \sum_{\alpha, \beta=1}^2 \widetilde{\text{Cor}}(\mathbf{Y}_{i_\alpha^{(b)}}, \mathbf{Y}_{i'_\beta^{(b)}}; \mathbf{Y}_{k^{(b)}}, \mathbf{Y}_{k'^{(b)}})}{\sqrt{|\widetilde{\text{Cor}}(\mathbf{Y}_{i_1^{(b)}}, \mathbf{Y}_{i_2^{(b)}}; \mathbf{Y}_{k^{(b)}}, \mathbf{Y}_{k'^{(b)}}) \widetilde{\text{Cor}}(\mathbf{Y}_{i'_1^{(b)}}, \mathbf{Y}_{i'_2^{(b)}}; \mathbf{Y}_{k^{(b)}}, \mathbf{Y}_{k'^{(b)}})|}} \quad (9)$$

356 It is worth pointing out that $r_{jj'}^{\text{RD}}$ is independent of σ_ε and σ_e and equals the
 357 unknown $r_{jj'}$ if ρ_δ is close to 1. A more formal proposition and proof for this
 358 estimator are provided in Appendix F.

359 *2.6. Localized versions of inter-correlation estimators*

360 As mentioned previously, when noisy signals are averaged, the signal to
 361 noise ratio increases. A very popular method in neuroimaging analyses is
 362 to apply a Gaussian smoothing on the fMRI volumes (Worsley et al., 1992,
 363 1996; Poline et al., 1997). However, applying a large kernel width may have
 364 dramatic effect on brain connectivity (Triana et al., 2020). Some earlier work
 365 on PET connectivity used a local neighbourhood centered around voxels of
 366 interest to smooth the signal in each region prior to connectivity estima-
 367 tion (Köhler et al., 1998). We introduce in this section estimators using local
 368 neighborhoods to control the smoothing effect on correlation estimations.

369 *2.6.1. Local correlation of averages (method ℓCA)*

370 Motivated by the first two estimators, we propose to estimate $r_{jj'}$ using
 371 an empirical average of local spatial averages. For $b = 1, \dots, B$, let $\mathcal{V}_j^{(b)}$ (resp.

372 $\mathcal{V}_{j'}^{(b)}$) be a ν -neighborhood of \mathcal{R}_j (resp. $\mathcal{R}_{j'}$). We define

$$\widehat{r}_{jj'}^{\ell\text{CA}} = \frac{1}{B} \sum_{b=1}^B \widehat{\text{Cor}}(\bar{\mathbf{Y}}_{\mathcal{V}_j^{(b)}}, \bar{\mathbf{Y}}_{\mathcal{V}_{j'}^{(b)}}). \quad (10)$$

373 *2.6.2. Local average of replicates (method ℓR)*

374 This estimator consists in replacing single indices by neighborhoods in (6).
 375 For $b = 1, \dots, B$, let $\mathcal{V}_{j_1}^{(b)}$ and $\mathcal{V}_{j_2}^{(b)}$ (resp. $\mathcal{V}_{j'_1}^{(b)}$ and $\mathcal{V}_{j'_2}^{(b)}$) be two ν -neighborhoods
 376 in \mathcal{R}_j (resp. $\mathcal{R}_{j'}$) such that for any $i_1^{(b)} \in \mathcal{V}_{j_1}^{(b)}$, $i_2^{(b)} \in \mathcal{V}_{j_2}^{(b)}$, $|i_1^{(b)} - i_2^{(b)}| = \delta \geq p$
 377 (resp. $|i'_1{}^{(b)} - i'_2{}^{(b)}| = \delta \geq p$ for any $i'_1{}^{(b)} \in \mathcal{V}_{j'_1}^{(b)}$, $i'_2{}^{(b)} \in \mathcal{V}_{j'_2}^{(b)}$). The local average
 378 of replicates based estimator is defined by

$$\widehat{r}_{jj'}^{\ell\text{R}} = \frac{1}{B} \sum_{b=1}^B \frac{\frac{1}{4} \sum_{\alpha, \beta=1}^2 \widehat{\text{Cor}}(\bar{\mathbf{Y}}_{\mathcal{V}_{j_\alpha}^{(b)}}, \bar{\mathbf{Y}}_{\mathcal{V}_{j'_\beta}^{(b)}})}{\sqrt{|\widehat{\text{Cor}}(\bar{\mathbf{Y}}_{\mathcal{V}_{j_1}^{(b)}}, \bar{\mathbf{Y}}_{\mathcal{V}_{j_2}^{(b)}}) \widehat{\text{Cor}}(\bar{\mathbf{Y}}_{\mathcal{V}_{j'_1}^{(b)}}, \bar{\mathbf{Y}}_{\mathcal{V}_{j'_2}^{(b)}})|}}}. \quad (11)$$

379 *2.6.3. Local averages and use of disconnected regions (method ℓD)*

380 We use in particular notation introduced in Sections 2.6.2 and 2.5.1 to
 381 propose the estimator $\widehat{r}_{jj'}^{\ell\text{D}}$ given by

$$\widehat{r}_{jj'}^{\ell\text{D}} = \frac{1}{B} \sum_{b=1}^B \widetilde{\text{Cor}}(\bar{\mathbf{Y}}_{\mathcal{V}_j^{(b)}}, \bar{\mathbf{Y}}_{\mathcal{V}_{j'}^{(b)}}; \bar{\mathbf{Y}}_{\mathcal{V}_k^{(b)}}, \bar{\mathbf{Y}}_{\mathcal{V}_{k'}^{(b)}}). \quad (12)$$

382 *2.6.4. Replicates, local averages and use of a priori disconnected regions*
 383 *(method ℓRD)*

384 This estimator is a local version of $\widehat{r}_{jj'}^{\text{RD}}$ and is defined by

$$\widehat{r}_{jj'}^{\ell\text{RD}} = \frac{1}{B} \sum_{b=1}^B \frac{\frac{1}{4} \sum_{\alpha, \beta=1}^2 \widetilde{\text{Cor}}(\bar{\mathbf{Y}}_{\mathcal{V}_{j_\alpha}^{(b)}}, \bar{\mathbf{Y}}_{\mathcal{V}_{j'_\beta}^{(b)}}; \bar{\mathbf{Y}}_{\mathcal{V}_k^{(b)}}, \bar{\mathbf{Y}}_{\mathcal{V}_{k'}^{(b)}})}{\sqrt{\widetilde{\text{Cor}}(\bar{\mathbf{Y}}_{\mathcal{V}_{j_1}^{(b)}}, \bar{\mathbf{Y}}_{\mathcal{V}_{j_2}^{(b)}}; \bar{\mathbf{Y}}_{\mathcal{V}_k^{(b)}}, \bar{\mathbf{Y}}_{\mathcal{V}_{k'}^{(b)}}) \widetilde{\text{Cor}}(\bar{\mathbf{Y}}_{\mathcal{V}_{j'_1}^{(b)}}, \bar{\mathbf{Y}}_{\mathcal{V}_{j'_2}^{(b)}}; \bar{\mathbf{Y}}_{\mathcal{V}_k^{(b)}}, \bar{\mathbf{Y}}_{\mathcal{V}_{k'}^{(b)}})}}}. \quad (13)$$

385 *2.7. Summary of estimators*

386 We have formalised 9 estimators for inter-region correlation in fMRI, 6
 387 of which are novel to the best of our knowledge. They vary in terms of their
 388 theoretical sensitivity to three factors: differences in region sizes and region
 389 intra-correlations ($\bar{\rho}_{\mathcal{R}_j} \ll 1$), local noise (σ_ε), and global noise (σ_e). Table 1
 390 summarises estimators properties qualitatively using $-$ for estimators that
 391 are sensitive to these factors, $+$ for estimators that are insensitive, and \pm
 392 for those that are in-between. The CA, ℓ CA, AC, and R estimators are
 393 sketched in Figure 1 and the D estimator is illustrated in Figure 2.

394 As an example, let us interpret the properties of CA shown in Table 1 in
 395 terms of these factors. First, we observe that the limit of $\widehat{r}_{jj'}^{\text{CA}}$ strongly depends
 396 on the region size. Indeed, even in absence of noise this limit is $r_{jj'}/\sqrt{\bar{\rho}_{\mathcal{R}_j}\bar{\rho}_{\mathcal{R}_{j'}}}$,
 397 which can be quite far from $r_{jj'}$ especially for very large regions (so the
 398 estimator is sensitive to local noise and denoted $-$ in the corresponding
 399 column). Now imagine that $\bar{\rho}_{\mathcal{R}_j}\bar{\rho}_{\mathcal{R}_{j'}} = 1$ and that $\sigma_e^2 = 0$ then the limit
 400 becomes $r_{jj'}/\sqrt{(1 + \sigma_{\varepsilon,j}^2\bar{\eta}_{\mathcal{R}_j})(1 + \sigma_{\varepsilon,j'}^2\bar{\eta}_{\mathcal{R}_{j'}})}$. Since it is expected that $\bar{\eta}_E$ is
 401 small (see (C.3)), especially for large sets E , this limit should be quite close
 402 to $r_{jj'}$ in this situation ($+$). Finally, if $\bar{\rho}_{\mathcal{R}_j}\bar{\rho}_{\mathcal{R}_{j'}} = 1$ and $\sigma_e^2 = 0$, and assume
 403 for simplicity that $\sigma_j = \sigma_{j'} = 1$, then $\widehat{r}_{jj'}^{\text{CA}}$ would converge towards $(r_{jj'} +$
 404 $\sigma_e^2)/(1 + \sigma_e^2)$ which can significantly deviate from $r_{jj'}$ when the global noise
 405 is strong ($-$).

406 This does not describe at all finite sample properties of the different esti-
 407 mators. Obviously, we could be tempted to always use the last two estimators
 408 (methods RD and ℓ RD) which seem to be the most robust to additional noises.
 409 However, these last estimators will be less robust to small sample size. We

410 propose to investigate these finite sample properties in a simulation study
411 (Section 3.1) and real datasets (Sections 3.2 and 3.3).

412 We note that evaluating asymptotic variances of the different estimators
413 would add too much notation, assumptions and technicalities, and is left for
414 future work.

Estimator	Limit $r_{jj'}$	Sensitivity to $\bar{\rho}_{\mathcal{R}_j} \ll 1$	σ_ε	σ_e
\hat{r}^{CA} (see (4))	$\frac{r_{jj'} + \sigma_{e, jj'}^2}{\sqrt{(\bar{\rho}_{\mathcal{R}_j} + \sigma_{\varepsilon, j}^2 \bar{\eta}_{\mathcal{R}_j} + \sigma_{e, j}^2)(\bar{\rho}_{\mathcal{R}_j} + \sigma_{\varepsilon, j}^2 \bar{\eta}_{\mathcal{R}_j} + \sigma_{e, j}^2)}}$	—	+	—
\hat{r}^{AC} (see (5))	$\frac{r_{jj'} + \sigma_{e, jj'}^2}{\sqrt{(1 + \sigma_{\varepsilon, j}^2 + \sigma_{e, j}^2)(1 + \sigma_{\varepsilon, j'}^2 + \sigma_{e, j'}^2)}}$	+	—	—
$\hat{r}^{\ell\text{CA}}$ (see (10))	$\frac{r_{jj'} + \sigma_{e, jj'}^2}{\sqrt{(\bar{\rho}_\nu + \sigma_{\varepsilon, j}^2 \bar{\eta}_\nu + \sigma_{e, j}^2)(\bar{\rho}_\nu + \sigma_{\varepsilon, j'}^2 \bar{\eta}_\nu + \sigma_{e, j'}^2)}}$	+	\pm	—
\hat{r}^{R} (see (6))	$\frac{r_{jj'} + \sigma_{e, jj'}^2}{\sqrt{(\rho_\delta + \sigma_{e, j}^2)(\rho_\delta + \sigma_{e, j'}^2)}}$	+	+	—
$\hat{r}^{\ell\text{R}}$ (see (11))	$\frac{r_{jj'} + \sigma_{e, jj'}^2}{\sqrt{(\bar{\rho}_\nu, \nu, \delta + \sigma_{e, j}^2)(\bar{\rho}_\nu, \nu, \delta + \sigma_{e, j'}^2)}}$	+	+	—
\hat{r}^{D} (see (7))	$\frac{r_{jj'}}{\sqrt{(1 + \sigma_{\varepsilon, j}^2)(1 + \sigma_{\varepsilon, j'}^2)}}$	+	—	+
$\hat{r}^{\ell\text{D}}$ (see (12))	$\frac{r_{jj'}}{\sqrt{(\bar{\rho}_\nu + \sigma_{\varepsilon, j}^2 \bar{\eta}_\nu)(\bar{\rho}_\nu + \sigma_{\varepsilon, j'}^2 \bar{\eta}_\nu)}}$	+	\pm	+
\hat{r}^{RD} (see (9))	$\frac{1}{ \rho_\delta }$	+	+	+
$\hat{r}^{\ell\text{RD}}$ (see (13))	$\frac{1}{ \bar{\rho}_\nu, \nu, \delta }$	+	+	+

Table 1: Expected limits and properties for existing and novel estimators of inter-correlation $r_{jj'}$, under the model (1). We refer the reader to Section 2.3 for details on notation. In particular $\sigma_{e, j}^2$, $\sigma_{e, j'}^2$ and $\sigma_{e, jj'}^2$ are given by (3) while $\bar{\rho}_E$, $\bar{\eta}_E$ and $\bar{\rho}_{E, E'}$ for two sets of indices E, E' are given by (2) and (C.7). Sensitivity of estimators to three factors are reported: differences in region sizes and region intra-correlations ($\bar{\rho}_{\mathcal{R}_j} \ll 1$), local noise (σ_ε), and global noise (σ_e). Estimators that are sensitive to these factors are denoted — those that are insensitive are denoted + and those in-between are denoted \pm .

415 3. Description of simulated and real datasets

416 We employed three distinct datasets to assess the performance of our
417 estimators. These datasets encompassed a simulated dataset, a dataset in-
418 volving rats that comprised both deceased and living animals, and a dataset
419 from a healthy human subject, which included test-retest data.

420 3.1. Simulated data

421 The paper being focused on pairwise spatial (auto)correlation estimation,
422 it is sufficient to investigate the finite sample properties of our estimators for
423 just two regions, say \mathcal{R}_j and $\mathcal{R}_{j'}$ (whose sizes are set here to 20 and 40
424 voxels, respectively). Also, to save time and memory, we restrict ourselves,
425 w.l.o.g., to one-dimensional regions ($d = 1$, regions are simply intervals so
426 they are simply made of 'voxels' along a line). For the estimators based on
427 differences (methods \mathcal{D} , $\ell_{\mathcal{D}}$, ℓ_{RD}), we consider two extra regions, say \mathcal{R}_k and
428 $\mathcal{R}_{k'}$, that are disconnected (i.e., $r_{jk} = r_{jk'} = r_{kk'} = r_{j'k} = r_{j'k'} = 0$). We
429 consider two scenarios: the “relatively strong inter-correlation case” ($r_{jj'} =$
430 0.6) and the “no inter-correlation case” ($r_{jj'} = 0$). The intra-correlation for
431 any given region is modelled (alike within any region $\mathcal{R}_j, \mathcal{R}_{j'}, \mathcal{R}_k, \mathcal{R}_{k'}$) using
432 the following spatial model

$$\rho_{ii'} = 1 - (1 - \nu) \left(1 - \frac{|i - i'|}{40} \right) \quad (14)$$

433 which only depends on the distance $|i - i'|$ between two voxels, say i and
434 i' , belonging to the same region. We selected either the value $\nu = 0.8$ or
435 $\nu = 0$, and designated accordingly the region as strongly or weakly intra-
436 correlated. Hence, when $\nu = 0$, the two voxels furthest apart in the region

437 of size 40 are uncorrelated, i.e., $\rho_{ii'} = 0$ when $|i - i'| = 40$. When $\nu = 0.8$,
 438 they are highly correlated with $\rho_{ii'} = 0.8$. Figure 3 represents the correlation
 439 structure of (14), as well as the quantity $\bar{\rho}_E$ for sets of indices $E \subseteq \{1, \dots, 40\}$
 440 with increasing size $\#E$, for both intra-correlation models. We generated
 441 independently 500 series of length $T = 1000$ according to model (1), and
 442 used 500 replicates for the method `R` and also 500 (Monte-Carlo or bootstrap)
 443 replications of choices of neighborhoods for methods `lCA`, `lR`, `lD`, `lRD` (where
 444 we set the length of the neighborhood to 3). The local noises $\varepsilon_i(t)$ and $\varepsilon_{i'}(t)$
 445 are assumed to be uncorrelated, so for some set of indices E , $\bar{\eta}_E = \sigma_e / \#E$.
 446 This is also represented in Figure 3.

447 Finally, we chose two values for the variance of the global noise, $\sigma_\varepsilon^2 = 0$
 448 and $\sigma_\varepsilon^2 = 0.1$, and two values for the variance of the local noise, $\sigma_\varepsilon^2 = 0$ and
 449 $\sigma_\varepsilon^2 = 0.1$. Results consist of 500 estimates for 9 methods, 2 intra-correlation
 450 models, 2 values for σ_ε^2 and 2 values for σ_ε^2 , that is 16 different scenarii
 451 (involving each time the 9 methods). They are presented and discussed
 452 in Section 6.1.

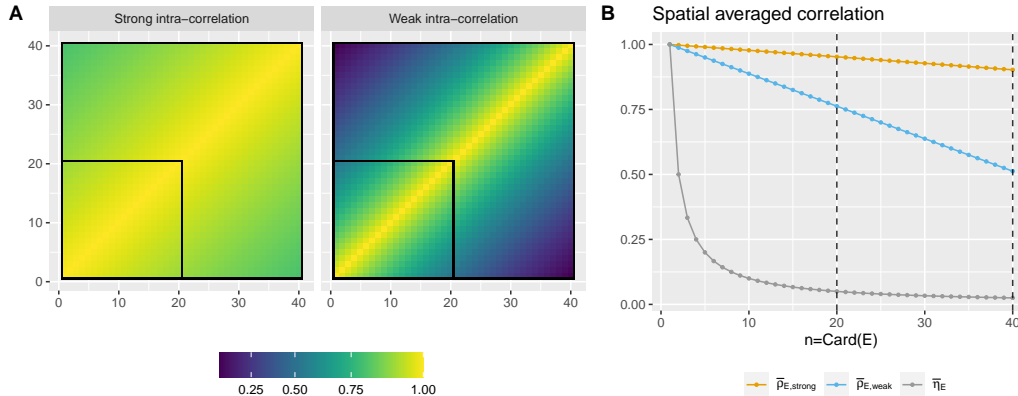

Figure 3: Simulation setup and results. (A) The two simulated one-dimensional regions (one with 40 “voxels”, the other with 20 “voxels”, shown as an inset) and their intra-correlation structure. Intra-correlation $\rho_{ii'}$ is given by (14) (with $\nu = 0.8$ for the strong intra-correlation and $\nu = 0$ for the weak intra-correlation) and decays with distance. (B) Intra-correlation (vertical axis) as a function of the size of region E (horizontal axis). From top to bottom: $\bar{\rho}_E$ (orange): average intra-correlation of signal in the strong case; $\bar{\rho}_E$ (blue): average intra-correlation of signal in the weak case; $\bar{\eta}_E$ (black): average intra-correlation of noise. Average noise intra-correlation decays sharply with region size.

453 3.2. Rats data

454 Using a 9.4T machine (Paravision 6.0.1, Bruker, Ettlingen, Germany),
 455 fMRI data were acquired for both dead and alive rats in Pawela et al. (2008).
 456 Twenty-five rats were scanned and identified in 4 different groups: DEAD,
 457 ETO-L (Etomidate), ISO-W (Isoflurane) and MED-L (Medetomidine). The
 458 first group contains dead rats and the three last groups correspond to different
 459 anesthetics. In this paper, we show results with data from three rats, one
 460 dead and two alive with different anesthetics (ETO-L, ISO-W).

461 The duration of the scanning was 30 minutes, using single-shot echo-
 462 planar imaging with $TR / TE = 500 / 20$ ms, so that 3600 time points were

463 available at the end of experiment. The resolution was $0.47 \times 0.47 \times 1.00$
464 mm, slice gap 0.1 mm, 9 slices. After preprocessing as explained in Becq
465 et al. (2020b), 51 brain regions for each rat were extracted using an in-house
466 atlas. Sufficiently large regions are needed to be able to use the R estimator.
467 We hence discarded regions that contained fewer than 40 voxels, and were
468 left with 18 brain regions: The anterior cingulate cortex (ACC), bilateral
469 Insular cortex (Ins_r and Ins_l), bilateral primary motor cortex (M1_r and
470 M1_l), bilateral somatosensory 1 (S1_r and S1_l), bilateral somatosensory 1
471 barrel field (S1BF_r and S1BF_l), bilateral auditory cortex (AU_r and AU_l),
472 bilateral caudate-putamen (striatum) (CPu_r and CPu_l), bilateral thalamus
473 (Th_r and Th_l), bilateral basal forebrain region (BF_r and BF_l), bilateral
474 hippocampus (HIP_r and HIP_l).

475 Voxel time series were wavelet-filtered using Daubechies orthonormal
476 compactly supported wavelet of length 8.

477 3.3. Human Connectome Project data

478 We also evaluated our estimators on a subset of the Human Connectome
479 Project (HCP) Young Adult 1200 Subjects release, WU-Minn Consortium
480 pre-processed (Glasser et al., 2013) (connectome db data package *Resting*
481 *State fMRI 1/2 Preprocessed*). We selected 100 subjects with two rs-fMRI
482 acquisitions on different days. The TR was 720 ms and the duration of
483 acquisition was 14 min and 24s.

484 The preprocessed fMRI data was segmented into 89 regions with SPM
485 *New Segment* using a modified AAL template: merging some of the regions,
486 reducing the parcellation to 89 regions. Merged regions are: frontal medial
487 orbital and rectus (one region for left and one for right hemisphere); oc-

488 ciptal superior, middle and inferior (one region for left and one for right
489 hemisphere); temporal pole superior and medial (one region for left and one
490 for right hemisphere); the cerebral crus (one region for left and one for right
491 hemisphere); areas III, IV, V and VI of cerebellum (one region for left and
492 one for right hemisphere); areas VII, VIII, IX, X of cerebellum (one region for
493 left and one for right hemisphere) and finally, the vermis (one single region
494 for both hemispheres). Other details are available in Termenon et al. (2016).

495 Voxel time series were wavelet filtered using Daubechies orthonormal com-
496 pactly supported wavelet of length 8.

497 **4. Evaluation and metrics**

498 First, on *simulated data*, we qualitatively inspected the bias and variance
499 of the distribution of correlation values with respect to known ground truth
500 for various levels of global and local noise.

501 Then, using *rat data*, we performed a face validity analysis of the estima-
502 tors, with the premise that dead rats should show no functional connectivity
503 (the correlation distribution should be centered at zero). In order to quantify
504 the differences between correlation values obtained for dead and live rats, we
505 computed the Wasserstein distance between the correlation distributions of
506 each anesthetized rat in comparison to that of a dead rat. A low value of the
507 Wasserstein distance indicates that correlations values of live and dead rats
508 are comparable and counts negatively in the evaluation of an estimator.

509 To evaluate the repeatability of the proposed estimators on the rat dataset,
510 we split the time series in two equal parts. We computed the correlations
511 on each part using the whole range of proposed estimators, and computed

512 the Concordance Correlation Coefficient (CCC) (Lin, 1989) between splits to
513 provide a scaled measure of agreement, where 1 is perfect agreement and 0
514 is no agreement. A preferable estimator should be more repeatable and have
515 higher CCC.

516 To quantify the similarity of connectivity graphs between estimators, we
517 computed the number of common edges between graphs obtained from each
518 estimator. To this end we used a sparsity threshold equal to 20% of the total
519 number of edges (i.e., 27 edges in our case with 18 regions).

520 For *human data*, we used rs-fMRI sessions from different days, in order to
521 evaluate reproducibility of correlation coefficients. This was analysed using
522 CCC, again with a preferable estimator being more reproducible and having
523 higher CCC.

524 We also evaluated the reproducibility of graph metrics between sessions.
525 To this end we used a sparsity threshold equal to 20% of the total number
526 of edges, keeping only edges with the highest correlation (i.e., 783 edges in
527 our case with 89 regions), and binarized the edges. In order to compute
528 graph metrics, we forced the graph to be connected by applying a minimum
529 spanning tree (Alexander-Bloch et al., 2010). Then we computed classical
530 graph metrics: betweenness centrality, transitivity, global and local efficiencies
531 using package iGraph. Reproducibility was evaluated using the CCC.

532 We also summarized the differences of connectivity graphs between esti-
533 mators, by computing the number of common edges between graphs obtained
534 from *CA* and *lCA* using thresholding at the 20th percentile (i.e., 783 edges
535 with 89 regions), and visualized the difference qualitatively by taking abso-
536 lute values of correlation values for each estimator, rank-transforming, and

537 computing median difference in ranks across all subjects,

538 Additionally, we also evaluated discriminative power of the various es-
539 timators via three metrics: inter vs intra-subject graph distance, a non-
540 parametric test of the same, and identification rate using functional connec-
541 tome fingerprinting (Finn et al., 2015). A desirable estimator should provide
542 estimates that preserve inter-individual differences.

543 We defined the intra-subject distance as the distance between the graph
544 representing the first rs-fMRI session and the graph representing the second
545 rs-fMRI session. The inter-subject distance was computed between each sub-
546 ject’s first session and all other subject’s first sessions. Separation between
547 the intra-subject distances and the inter-subject distances was quantified by
548 mean and standard deviation of the distributions, and by a Wilcoxon rank-
549 sum test on multiple random splits of subject data, to avoid having multiple
550 measurements of the same subjects. Here, we repeated 10 times the follow-
551 ing procedure for each estimator of interest: first, split the subjects into two
552 disjoint sets - one used to compute intra-distances (50 subjects), and one
553 to compute inter-distances (50 subjects). Within the inter-distances set, 25
554 subject pairs were formed randomly. We tested the null hypothesis of no dif-
555 ference between inter- and intra-distances, against the alternative hypothesis
556 that intra-subject distance $<$ inter-subject distance, based on the assumption
557 that subjects are more similar to themselves than to other subjects. Given
558 the relatively narrow age range of our sample of HCP subjects (all 22-35
559 except one 36+), and given that our goal was to compare estimators using
560 fixed splits, we did not adjust for covariates or match samples across splits
561 We used a one-sided Wilcoxon rank-sum test, yielding a W statistic and a p -

562 value for each of the 10 runs. We then computed the average W value across
563 runs, as well as the harmonic mean p -value (Wilson, 2019) across runs, a pro-
564 cedure with strong family-wise error rate (FWER) control even for positively
565 dependent tests.

566 To compute identification rate, functional connectome fingerprinting rep-
567 resent each subject’s graph g as a vectorized version \mathbf{a} of the upper-triangular
568 (or lower-triangular) part of the full inter-region correlation matrix (whose
569 entries are $r_{ii'}$), and computes the fingerprinting distance between graphs as
570 $d(g_1, g_2) = 1 - \widehat{\text{Cor}}(\mathbf{a}_1, \mathbf{a}_2)$, where Cor denotes Pearson correlation. From the
571 (intra, inter) fingerprinting distance distributions, the identification counts as
572 correct if the intra-subject distance is lower than all inter-subject distances.
573 This is equivalent to a top-1 recognition rate. We note there are many other
574 possibilities to compute distances between such brain graphs (Richiardi et al.,
575 2013; Ng et al., 2016; Dadi et al., 2019), including computing distances be-
576 tween graph embeddings, which could substantially alter results.

577 Finally, we evaluated the dependence on region size by computing Spear-
578 man correlations between atlas region size and the average of correlations in
579 which the region is involved (itself averaged across subjects). A preferable
580 estimator should minimize dependence to region size, and show lower Spear-
581 man correlation. We tested differences between estimators using a paired
582 t-test between these Spearman correlations.

583 **5. Data and Code Availability**

584 R and Python code implementing all estimators, to generate simulated
585 data, and to extract the time-series from the preprocessed HCP data is avail-

586 able at <https://gitlab.inria.fr/q-func/ireco4fmri>.

587 The pre-extracted, wavelet-filtered time series for the rat data are avail-
588 able at <https://dx.doi.org/10.5281/zenodo.7254133>. Human Conne-
589 ctome Project data is available at <https://www.humanconnectome.org/>

590 6. Results

591 6.1. Evaluation on simulated data

592 Simulation setup is described in Section 3.1. Figure 4 shows boxplots of
593 estimates of $r_{jj'} = 0.6$ for all methods and different intra-correlation models,
594 and different levels of local and global noise. In terms of bias, overall, the
595 method ℓ_{RD} is the best, but it is also the one with the highest variance. In the
596 strong intra-correlation case, and when $\sigma_\epsilon = 0$, all methods are almost unbi-
597 ased. When σ_ϵ is increased to 0.1, the estimators $_{AC}$, ℓ_{CA} , $_D$, and ℓ_D clearly
598 lose this property. In the weak intra-correlation case, only the estimators $_{AC}$,
599 ℓ_R and ℓ_{RD} are unbiased, or close to, with ℓ_{RD} being the best overall for
600 this criterion, while still being the more variable. Figure 5 shows boxplots of
601 estimates of $r_{jj'} = 0$ for all methods and different intra-correlation models,
602 and different levels of local and global noise. When $\sigma_\epsilon = 0$ all estimators are
603 unbiased, both in the strong and weak intra-correlation case. This property
604 remains true when σ_ϵ is increased to 0.1 only for the estimators $_D$, ℓ_D and
605 $_{RD}$. Here again, the estimator ℓ_{RD} is the more variable. We can also notice
606 that when $\sigma_\epsilon = 0.1$, the estimator $_{AC}$ exhibits very good properties, while
607 ℓ_{RD} is the worst.

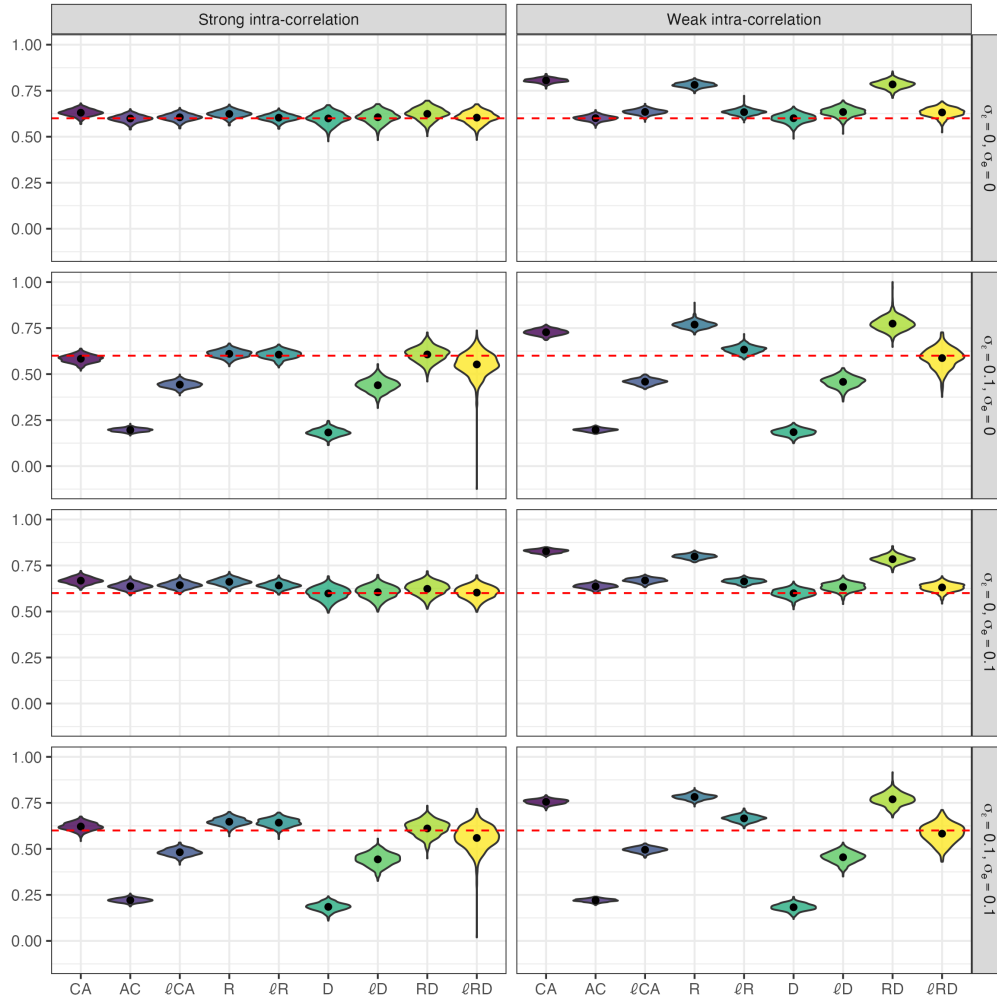

Figure 4: Estimates of the inter-correlation parameter $r_{jj'} = 0.6$ between two regions, based on 500 simulation runs of the general model (1). Situations for two intra-correlation models and situations with no noise, local noise and/or global noise are considered. The true inter-correlation is depicted by a red dashed line.

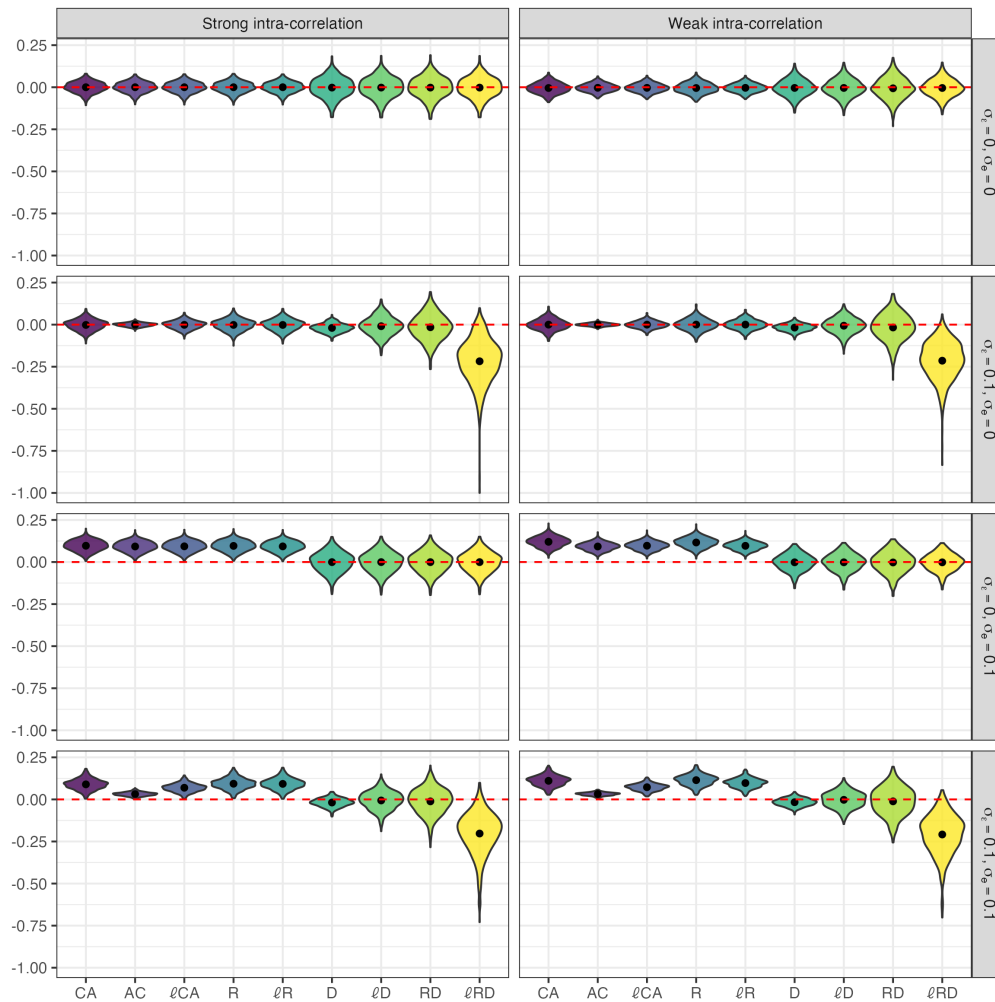

Figure 5: Estimates of the inter-correlation parameter $r_{jj'} = 0$ between two regions, based on 500 simulation runs of the general model (1). Situations for two intra-correlation models and situations with no noise, local noise and/or global noise are considered. The true inter-correlation is depicted by a red dashed line.

608 *6.2. Evaluation on rat data*

609 Figure 6(A) shows the correlation values obtained on rats for all pairs of
 610 brain regions, 153 in our case. For this data set, we know that for the dead

611 rat we are under the full null hypothesis as no legitimate functional activity
612 should be detected. Thus the estimated correlations should be close to zero.
613 This is the case for estimators AC, R, ℓ_{CA} , D and ℓ_D . However, the other
614 estimators showcase a clear bias towards positive values. The method CA
615 namely yields unexpectedly high values of correlations. These correlations
616 correspond to regions that are close together (Becq et al., 2020a). In order
617 to validate these methods, we also apply our estimators to live rats. The
618 results of two live rats is shown in Figure 6 (A, right). As expected, due to
619 the local noise, the methods AC and D do not provide satisfactory results as
620 the correlation values are very close to zero. One of the best method in this
621 case is ℓ_{CA} , where sufficient non-zero correlations are obtained. Wasserstein
622 distance computations (Figure 6 (C)) show that AC, D, and RD have the low-
623 est Wasserstein distance values, indicating that the correlation distribution
624 of the live rats resemble that of a dead rat.

625 Figure 6(B) shows Concordance Correlation Coefficient results. Consis-
626 tent with the all-noise nature of the data, the dead rat exhibited very low
627 repeatability, with ℓ_{CA} providing the highest at 0.22. On the live Eto-L rat,
628 estimators had approximately the same repeatability, with RD showing the
629 lowest CCC at 0.62 and AC tied with ℓ_{CA} for highest at 0.87. For the Iso-W
630 rat, ℓ_R had the lowest CCC at 0.46, CA the second lowest at 0.54, and ℓ_D
631 the highest at 0.73.

632 Combining all of these results, ℓ_{CA} , R and ℓ_D hence seem to be the most
633 adequate correlation estimators. However, as shown in formula (G.4), the
634 estimator ℓ_D is difficult to implement. Indeed, it requires the definition of
635 two other regions uncorrelated with the main brain regions of the parcellation

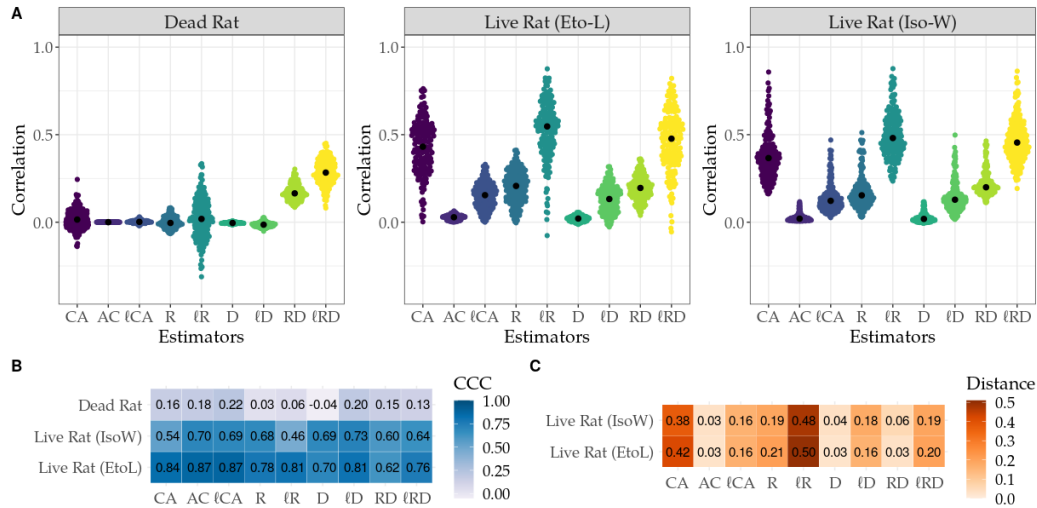

Figure 6: Rat data results. **A.** Empirical distribution of the correlation estimators for all pairs of brain regions for a dead and two anesthetized rats, for all proposed estimators. In the dead rat, the correlation of averages (CA) estimator is providing high values where null correlations should be observed. For the live rat the average of correlation estimator (AC) is providing very low values where non null correlations should be observed. **B.** The Concordance Correlation Coefficient (CCC) for the repeatability of the different estimators for all rats, calculated between the first and second half of the BOLD time series. Higher CCC corresponds to a more repeatable estimator. **C.** Wasserstein distances between the correlation distribution of each anesthetized rat and that of the dead rat, for all estimators. AC, D, RD have a very low distance, indicating that correlation values are similar between dead and live rats for these estimators.

636 and uncorrelated with themselves. Moreover, R cannot be estimated when
637 regions are too small, which is often the case in rat data. From now on, we
638 will hence focus on estimator ℓ_{CA} .

639 We then quantified the edges in common between the networks obtained
640 via the two estimators CA (which is currently the most widely used estimator)
641 and ℓ_{CA} . For the dead rat, 67% of edges are in common between the two
642 estimators. Additionally, 60% and 77% of edges are similar for the live rats.

643 <https://www.overleaf.com/project/619e15e123dc6c1b1e091576>

644 *6.3. Evaluation on human data*

645 Based on our findings on the rats datasets, we evaluate the performances
646 of the three estimators CA (most common estimator, highest dead-live rat
647 distance), AC (low dead-live rat distance) and ℓ_{CA} (high dead-live rat dis-
648 tance) for 100 subjects of the HCP dataset.

649 Figure 7(A) reports the correlation values among all pairs of regions for
650 four randomly selected HCP subjects. Consistent with the rat results, the
651 estimator CA yields the largest values of correlations, estimator AC yields
652 very low values, while ℓ_{CA} values are different from zero, but smaller than
653 CA values.

654 Reproducibility results for correlation estimates are shown in Figure 7
655 (B,C). The Concordance Correlation Coefficient was similar between estima-
656 tors (average (sd) across 100 subjects for CA : 0.64 (0.13), AC : 0.66 (0.20),
657 ℓ_{CA} : 0.62 (0.17), R : 0.56 (0.17), ℓ_R : 0.52 (0.14)), with variations in repro-
658 ducibility reflecting inter-subject variability more than differences between
659 estimators. For graph metrics reproducibility, we report only the results
660 with betweenness in Figure 7 (D,E), since similar results are obtained with

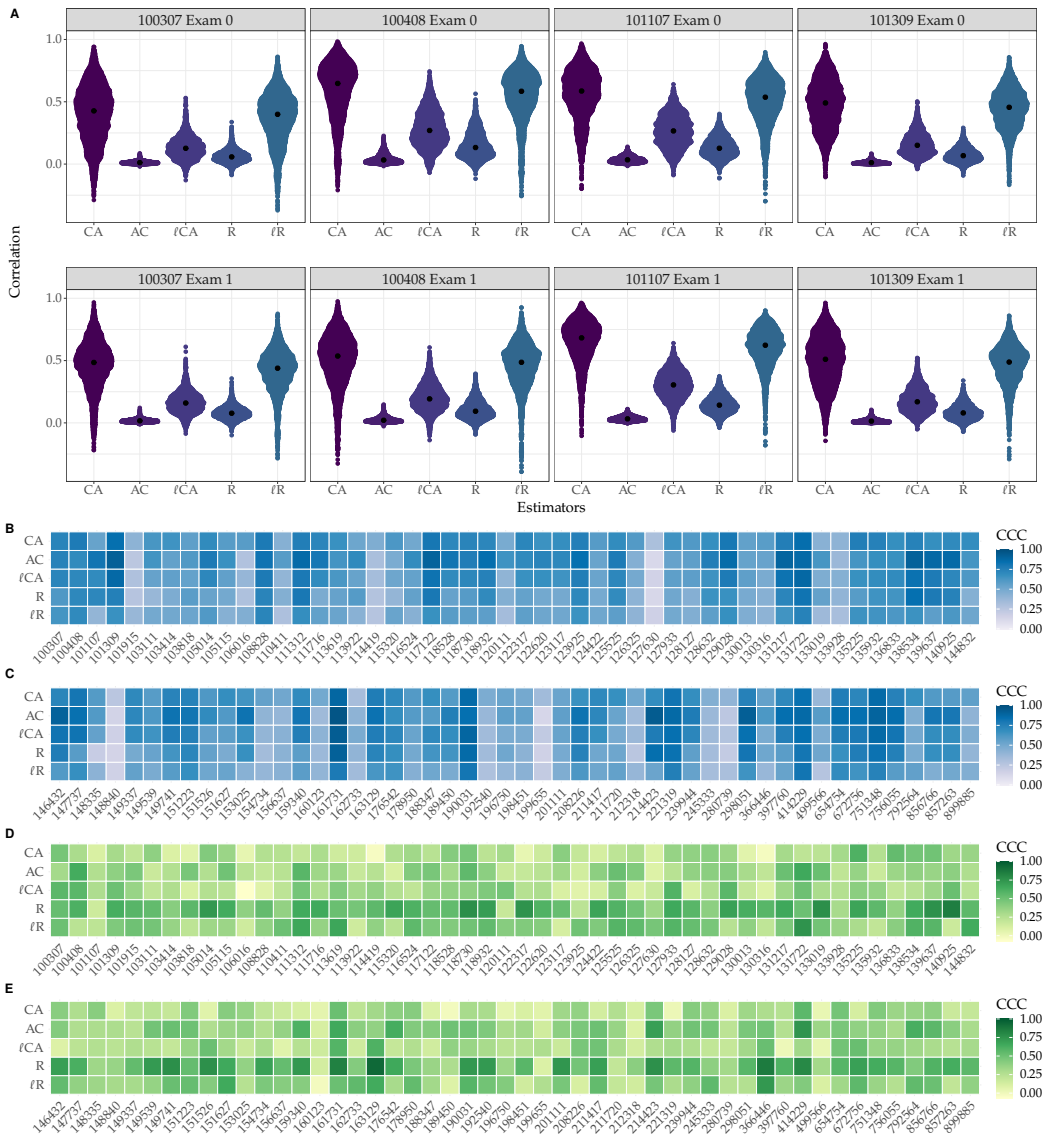

Figure 7: Human data results. **A.** Empirical distribution of inter-regional correlations for three selected estimators for all pairs of brain regions for four human subjects. Each subject was scanned twice, on different days. **B. and C.** Concordance correlation Coefficient (CCC) for the reproducibility of the inter-regional correlation values obtained by different estimators for all human subjects, computed between the two examinations. Higher CCC indicates a more repeatable estimator. All estimators have broadly similar reproducibility. **D. and E.** reproducibility of a topological graph metric (betweenness). Again all estimators give broadly similar results, with slightly higher reproducibility for AC

661 other metrics. Here, the methods differed more, with average (sd) across
 662 100 subjects for CA: 0.29 (0.14), AC: 0.55 (0.17), ℓ CA: 0.4 (0.16), R: 0.37
 663 (0.14), ℓ R: 0.26 (0.15). ℓ CA had significantly lower CCC than AC ($T=-6.8$,
 664 $p = 1.6e^{-10}$), However, ℓ CA has significantly higher CCC than CA ($T=5.1$,
 665 $p = 8e^{-07}$) and ℓ R ($T=6.3$, $p = 2e^{-9}$). Finally ℓ CA and R are not significantly
 666 different ($T=1.35$, $p = 0.18$). These differences are robust to the choice of
 667 threshold (cf, Appendix Appendix G.5).

668 In the thresholded graphs, the percentage of edges in common between
 669 estimators CA and ℓ CA was on average equal to 70% for the one hundred
 670 subjects used in this analysis for both sessions. Figure 8 shows median
 671 differences between the estimators in brain space across the HCP subjects.

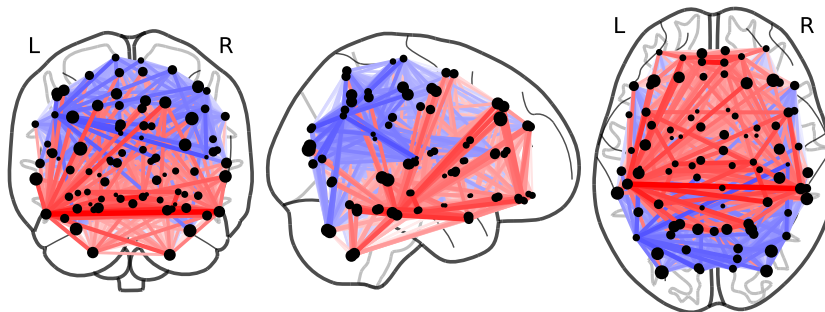

Figure 8: Largest differences between the CA and ℓ CA estimators, median over 100 HCP subjects. Only the top 20% differences are shown. Inter-regional correlations are taken in absolute value and rank-transformed prior to computing differences (rank 1 for the strongest correlation, rank 2 for the second-strongest, and so on). Red indicates absolute correlations that are higher for the ℓ CA than the CA estimator, while blue indicates the reverse. Node size is proportional to region size in the atlas. Estimator CA on average shows hyperconnectivity in occipital and generally dorsal posterior regions, and hypoconnectivity in frontal, temporal, and general ventral anterior regions.

672 Looking at dependence on region size, the CA estimator showed signifi-

673 cantly more correlation with region size than the ℓ CA estimator (average (sd)
 674 across 100 subjects 0.55 (0.10) vs 0.40 (0.09), $T=27.2$, $p = 1.1e^{-47}$.

675 In terms of discriminative power between subjects, for connectome finger-
 676 printing, CA and ℓ CA achieved the same performance (72% correct identifica-
 677 tion), while AC had slightly lower performance (68% correct identification).
 678 Group differences were also similar between estimators. Table 2 provides
 679 details.

estimator	intra (sd)	inter (sd)	W (p -value)	identification rate
CA	0.29 (0.10)	0.49 (0.10)	-5.82 ($p_{hmp} = 1.5e^{-10}$)	72%
AC	0.19 (0.10)	0.32 (0.10)	-4.88 ($p_{hmp} = 3.6e^{-9}$)	69%
ℓ CA	0.26 (0.10)	0.43 (0.10)	-3.315.58 ($p_{hmp} = 1.2e^{-9}$)	72%

Table 2: Discriminative power of estimators on the human dataset. intra: Within-subject average and standard deviation of graph distances between first and second imaging session across 100 subjects; inter: same for between-subjects, using only the first session. W: average one-sided Wilcoxon rank-sum test value on 10 random splits, with corresponding harmonic mean p -value

680 7. Discussion

681 In this paper we illustrate the effect of averaged data on estimators of
 682 correlation when two types of noises are present, local and global noise. The
 683 use of the classical correlation of averages is hindered by the presence of
 684 these noises in addition to the presence of intra-correlations. We proposed
 685 alternative estimators including correction terms to compensate the intra-
 686 correlations, local and global noises. The performance of these estimators

687 was evaluated on simulations, rats data, and human data, yielding several
688 observations.

689 *7.1. The correlation of averages estimator is highly biased*

690 The CA estimator tends to be highly biased, as illustrated on synthetic
691 data where the ground truth is known, but also compared to other estimators,
692 as shown on live rats and human data, where the mode of the distribution of
693 correlation values is systematically among the highest found. We hypothesise
694 that this is driven by a combination of low intra-correlation and large region
695 sizes, which further lowers intra-correlation. This can be seen from the es-
696 timator definition in Eq. 4. We also note that the ℓ CA estimator effectively
697 reduces this influence of region size.

698 In addition, Figure 8 revealed a systematic spatial bias between the CA
699 and ℓ CA estimator, exhibiting dorsal posterior hyper-connectivity for CA,
700 and corresponding ventral anterior hypo-connectivity. The figure also sug-
701 gests that the largest differences between the two estimators appear between
702 regions that are the largest, further highlighting the reduced dependency to
703 region size for the ℓ CA estimator. The spatial distribution of these differences
704 suggests that caution is in order when examining large-scale resting-state net-
705 works derived from the CA estimator, as some apparent topological properties
706 of brain networks, such as modularity, could be driven in part by region size
707 and region intra-correlation. Indeed, in our experiments, thresholded graphs
708 differed in a large proportion of edges, both in rats (around 30%-50% edge
709 differences) and humans (around 30% edge differences). Thus, it is probable
710 that both edge-level and graph-level metrics obtained from the CA estima-
711 tor are biased due to their over- or under-estimation of actual functional

712 connectivity, in a spatially-dependent manner. For clinical applications, this
713 phenomenon could either emphasize or reduce differences between patients
714 and controls. Since we have no ground truth available for in-vivo functional
715 connectivity, in practical situations, we therefore recommend that results ob-
716 tained with the c_A estimator be re-run at least with the ℓCA estimator as a
717 sensitivity analysis. The computational cost is not excessive, and differences
718 in results could indicate that estimator-induced bias was at play.

719 *7.2. local noise and intra-correlation link to long-range correlation*

720 In this paper, we explain the bias observed in CA estimator by introduc-
721 ing hypotheses on both intra-correlation and noise. Indeed, previous studies
722 on regional homogeneity (Zang et al., 2004) showed relevant results on clas-
723 sification of pathologies based only on intra-regional properties. This was
724 confirmed by a recent work on classification of intra-correlation (Petersen
725 et al., 2016) using Wasserstein distances. Based on these findings, we hy-
726 pothesize that bias observed on inter-correlation is driven by intra-correlation
727 and noise. Our simple simulation model illustrates the effect of local noise
728 and intra-correlation. This is clearly displayed in Figures 4-5, where the box-
729 plots for the various estimators are plotted. However, it is important to note
730 that under local noise, in this framework with controlled intra-correlation,
731 estimator CA is relatively close to the exact value. This may be explained
732 by a trade-off in the denominator of the limit as expressed in Table 1. In
733 our simulation, we also observed that the CA estimators bias depends on
734 the intra-correlation and local noise. Indeed, high values of CA tends to be
735 observed when low values of intra-correlation are observed. These low values
736 of intra-correlation have already been mentioned in the study of dynamics of

737 neural networks (Deco et al., 2014) where local decorrelation was reported in
738 real datasets. In our paper, for the first time, we proved a statistical expla-
739 nation of the link between local decorrelations and long-range correlations
740 using aggregated time series.

741 The model chosen in this paper for intra-correlation and local noise was
742 driven by statistical motivations to be able to write explicit formulas for
743 the limit of the estimators. However, as observed in Jiang and Zuo (2016);
744 Deco et al. (2014), these hypotheses are realistic for resting-state fMRI data,
745 where local decorrelations are observed. These local decorrelations can come
746 from two factors: a low intra-correlation (as modeled by the choice of the
747 intra-correlation coefficients of the matrix), or a strong local noise. **The**
748 **stationarity assumption may be not adequate based on raw data. However,**
749 **as mentioned in Section 2.1, it becomes very reasonable after performing a**
750 **wavelet transform of each time series voxelwise. This preprocessing signifi-**
751 **cantly reduces non stationary artefacts.**

752 *7.3. Repeatability and reproducibility*

753 Repeatability of correlation values in dead rats was very low for all es-
754 timators, consistent with the random nature of the data. For live rats, the
755 CCC ranged from 0.46 to 0.87 depending on specimen and estimator. For
756 humans, CA and ℓ_{CA} showed approximately the same reproducibility (0.63
757 average (0.2)), and AC was slightly superior (0.66 average (0.2)). But repro-
758 ducibility differences between estimators were much less pronounced than
759 reproducibility differences between individual subjects.

760 As a representative for the reproducibility of graph metrics, we inves-
761 tigated betweenness. Here, AC offered the highest reproducibility (average

762 (sd): 0.55 (0.17)) and ℓ_{CA} improved markedly over CA (0.4 (0.16) vs 0.29
763 (0.14)). This is contrast to another study that found no effect of aggregation
764 method (region mean time series versus region median versus 1st eigenvariate
765 of the region) on the reproducibility of graph metrics (Braun et al., 2012)
766 (although in that study sessions were weeks apart).

767 *7.4. Discriminability*

768 Estimators CA, AC, ℓ_{CA} showed similar values for discriminability, with
769 slightly lower identification rate and intra-subject to inter-subject distribu-
770 tion separation for AC than the two others, and slightly lower intra-inter
771 separation for ℓ_{CA} than CA. This suggests that the improved robustness to
772 region size and intra-correlation effects of ℓ_{CA} does not result in a sizeable
773 impact on discriminative ability, although this warrants further evaluation.

774 *7.5. Limitations*

775 Our signal model, and therefore the derived estimators, is a trade-off be-
776 tween model realism and tractability of the analysis of estimator properties.
777 This comes with important limitations.

778 First, assuming stationarity and additivity of the local noise fails to cap-
779 ture effects like system instability due to B0 inhomogeneity, RF power vari-
780 ations, or gradient fluctuations (Lazar, 2008; Greve et al., 2013; Liu, 2016).
781 Independently of the model, note that effects such as drift are mitigated by
782 using wavelet coefficient time series as we did in this study, and that such
783 instabilities explain proportionally less of the noise variance than thermal
784 noise at high field (Greve et al., 2011).

785 Second, motion effects, and in particular differential long-vs short-range
786 effects on correlations (Van Dijk et al., 2010; Yan et al., 2013), were not
787 studied, and their interplay with the spatial bias exhibited by estimator CA
788 in Figure 8 was not examined.

789 Third, our new estimators come with the added burden of choosing hyper-
790 parameters such as neighbourhood size. These are currently selected empir-
791 ically, and no systematic sensitivity analysis has been performed. However,
792 our proposed approach may be used to redefine the brain regions by group-
793 ing voxels with high intra-correlation. This would allow to define new brain
794 regions using intra-correlation in addition to anatomical criterion.

795 Despite these limitations, we believe our empirical tests served to bridge
796 the gap towards applicability, since our model yielded at least an estimator,
797 ℓ_{CA} , with useful properties for use in neuroimaging - namely, reduced depen-
798 dency to region size and low intra-correlation, and improved reproducibility
799 of graph metrics.

800 **8. Acknowledgements**

801 This work was partly funded by French National Research Agency project
802 ANR-20-NEUC-0003-02. Rat data was acquired at the IRMaGe MRI facil-
803 ity, partly funded by the French program Investissement d’Avenir run by the
804 French National Research Agency, grant Infrastructure d’avenir en Biologie
805 Santé ANR-11-INBS-0006. The work was also partly funded by the transna-
806 tional Alliance Campus Rhodanien programme. Human data were provided
807 by the Human Connectome Project, WU-Minn Consortium (Principal Inves-
808 tigators: David Van Essen and Kamil Ugurbil; 1U54MH091657) funded by

809 the 16 NIH Institutes and Centers that support the NIH Blueprint for Neu-
810 roscience Research; and by the McDonnell Center for Systems Neuroscience
811 at Washington University. We also thank Ayoub Cherkaoui and Ossama Ziri
812 for coding the Python implementation of the estimators.

813 **References**

814 Achard, S., Coeurjolly, J.F., Marcillaud, R., Richiardi, J., 2011. fMRI func-
815 tional connectivity estimators robust to region size bias, in: IEEE Work-
816 shop on Statistical Signal Processing, SSP2011, Nice, France. pp. 813–816.

817 Achard, S., Salvador, R., Whitcher, B., Suckling, J., Bullmore, E., 2006. A
818 resilient, low-frequency, small-world human brain functional network with
819 highly connected association cortical hubs. *Journal of Neuroscience* 26,
820 63–72.

821 Afyouni, S., Smith, S.M., Nichols, T.E., 2019. Effective degrees of freedom
822 of the Pearson’s correlation coefficient under autocorrelation. *NeuroImage*
823 199, 609–625.

824 Alexander-Bloch, A.F., Gogtay, N., Meunier, D., Birn, R., Clasen, L.,
825 Lalonde, F., Lenroot, R., Giedd, J., Bullmore, E.T., 2010. Disrupted Mod-
826 ularity and Local Connectivity of Brain Functional Networks in Childhood-
827 Onset Schizophrenia. *Frontiers in Systems Neuroscience* 4.

828 Alexander-Bloch, A.F., Shou, H., Liu, S., Satterthwaite, T.D., Glahn, D.C.,
829 Shinohara, R.T., Vandekar, S.N., Raznahan, A., 2018. On testing for spa-
830 tial correspondence between maps of human brain structure and function.
831 *NeuroImage* 178, 540–551.

- 832 Becq, G.G.J.P.C., Barbier, E., Achard, S., 2020a. Brain networks of rats un-
833 der anesthesia using resting-state fmri: comparison with dead rats, random
834 noise and generative models of networks. *Journal of Neural Engineering* .
- 835 Becq, G.J.P., Habet, T., Collomb, N., Faucher, M., Delon-Martin, C., Coizet,
836 V., Achard, S., Barbier, E.L., 2020b. Functional connectivity is pre-
837 served but reorganized across several anesthetic regimes. *NeuroImage* 219,
838 116945.
- 839 Bergholm, F., Adler, J., Parmryd, I., 2010. Analysis of bias in the apparent
840 correlation coefficient between image pairs corrupted by severe noise. *J*
841 *Math Imaging Vis* 37, 204–219.
- 842 Bolt, T., Nomi, J.S., Rubinov, M., Uddin, L.Q., 2017. Correspondence be-
843 tween evoked and intrinsic functional brain network configurations. *Hu-*
844 *man Brain Mapping* 38, 1992–2007. [https://onlinelibrary.wiley.](https://onlinelibrary.wiley.com/doi/pdf/10.1002/hbm.23500)
845 [com/doi/pdf/10.1002/hbm.23500.](https://onlinelibrary.wiley.com/doi/pdf/10.1002/hbm.23500)
- 846 Braun, U., Plichta, M.M., Esslinger, C., Sauer, C., Haddad, L., Grimm, O.,
847 Mier, D., Mohnke, S., Heinz, A., Erk, S., Walter, H., Seiferth, N., Kirsch,
848 P., Meyer-Lindenberg, A., 2012. Test–retest reliability of resting-state con-
849 nectivity network characteristics using fMRI and graph theoretical mea-
850 sures. *NeuroImage* 59, 1404–1412.
- 851 Burt, J.B., Helmer, M., Shinn, M., Anticevic, A., Murray, J.D., 2020. Gen-
852 erative modeling of brain maps with spatial autocorrelation. *NeuroImage*
853 220, 117038.

- 854 Büchel, C., Friston, K.J., 1997. Modulation of connectivity in visual path-
855 ways by attention: cortical interactions evaluated with structural equation
856 modelling and fMRI. *Cerebral Cortex* 7, 768–778.
- 857 Caballero-Gaudes, C., Reynolds, R.C., 2017. Methods for cleaning the BOLD
858 fMRI signal. *NeuroImage* 154, 128–149.
- 859 Cao, H., McEwen, S.C., Forsyth, J.K., Gee, D.G., Bearden, C.E., Addington,
860 J., Goodyear, B., Cadenhead, K.S., Mirzakhani, H., Cornblatt, B.A.,
861 Carrión, R.E., Mathalon, D.H., McGlashan, T.H., Perkins, D.O., Bel-
862 ger, A., Seidman, L.J., Thermenos, H., Tsuang, M.T., van Erp, T.G.M.,
863 Walker, E.F., Hamann, S., Anticevic, A., Woods, S.W., Cannon, T.D.,
864 2019. Toward Leveraging Human Connectomic Data in Large Consortia:
865 Generalizability of fMRI-Based Brain Graphs Across Sites, Sessions, and
866 Paradigms. *Cerebral Cortex* 29, 1263–1279.
- 867 Cao, J., Worsley, K., 1999. The geometry of correlation fields with an ap-
868 plication to functional connectivity of the brain. *The Annals of Applied*
869 *Probability* 9, 1021–1057. Publisher: Institute of Mathematical Statistics.
- 870 Castellanos, F.X., Di Martino, A., Craddock, R.C., Mehta, A.D., Milham,
871 M.P., 2013. Clinical applications of the functional connectome. *NeuroIm-*
872 *age* 80, 527–540.
- 873 Castrillon, J.G., Ahmadi, A., Navab, N., Richiardi, J., 2014. Learning with
874 multi-site fMRI graph data, in: 2014 48th Asilomar Conference on Signals,
875 Systems and Computers, pp. 608–612. ISSN: 1058-6393.

- 876 Chen, J.E., Glover, G.H., 2015. BOLD fractional contribution to resting-
877 state functional connectivity above 0.1 Hz. *NeuroImage* 107, 207–218.
- 878 Clifford, P., Richardson, S., Hemon, D., 1989. Assessing the significance of
879 the correlation between two spatial processes. *Biometrics* 45, 123–134.
- 880 Cordes, D., Haughton, V.M., Arfanakis, K., Carew, J.D., Turski, P.A.,
881 Moritz, C.H., Quigley, M.A., Meyerand, M.E., 2001. Frequencies Con-
882 tributing to Functional Connectivity in the Cerebral Cortex in “Resting-
883 state” Data. *American Journal of Neuroradiology* 22, 1326–1333. Pub-
884 lisher: American Journal of Neuroradiology Section: BRAIN.
- 885 Dadi, K., Rahim, M., Abraham, A., Chyzhyk, D., Milham, M., Thirion, B.,
886 Varoquaux, G., 2019. Benchmarking functional connectome-based predic-
887 tive models for resting-state fMRI. *NeuroImage* 192, 115–134.
- 888 Deco, G., Ponce-Alvarez, A., Hagmann, P., Romani, G.L., Mantini, D., Cor-
889 betta, M., 2014. How Local Excitation-Inhibition Ratio Impacts the Whole
890 Brain Dynamics. *Journal of Neuroscience* 34, 7886–7898.
- 891 Descombes, X., Kruggel, F., Von Cramon, D., 1998. fMRI Signal Restoration
892 Using a Spatio-Temporal Markov Random Field Preserving Transitions.
893 *NeuroImage* 8, 340–349.
- 894 Eickhoff, S.B., Thirion, B., Varoquaux, G., Bzdok, D., 2015. Connectivity-
895 based parcellation: Critique and implications. *Human Brain Mapping* 36,
896 4771–4792.
- 897 Fan, F., Liao, X., Lei, T., Zhao, T., Xia, M., Men, W., Wang, Y., Hu, M.,

- 898 Liu, J., Qin, S., Tan, S., Gao, J.H., Dong, Q., Tao, S., He, Y., 2021. De-
899 velopment of the default-mode network during childhood and adolescence:
900 A longitudinal resting-state fMRI study. *NeuroImage* 226, 117581.
- 901 Figueroa-Jimenez, M.D., Cañete-Massé, C., Carbó-Carreté, M., Zarabozo-
902 Hurtado, D., Peró-Cebollero, M., Salazar-Estrada, J.G., Guàrdia-Olmos,
903 J., 2021. Resting-state default mode network connectivity in young in-
904 dividuals with down syndrome. *Brain and Behavior* 11, e01905. <https://onlinelibrary.wiley.com/doi/pdf/10.1002/brb3.1905>.
905
- 906 Finn, E.S., Shen, X., Scheinost, D., Rosenberg, M.D., Huang, J., Chun,
907 M.M., Papademetris, X., Constable, R.T., 2015. Functional connectome
908 fingerprinting: identifying individuals using patterns of brain connectivity.
909 *Nature Neuroscience* 18, 1664–1671.
- 910 Fornito, A., Bullmore, E.T., Zalesky, A., 2017. Opportunities and Challenges
911 for Psychiatry in the Connectomic Era. *Biological Psychiatry: Cognitive
912 Neuroscience and Neuroimaging* 2, 9–19.
- 913 Fornito, A., Zalesky, A., Breakspear, M., 2015. The connectomics of brain
914 disorders. *Nature Reviews Neuroscience* 16, 159–172.
- 915 Gaetan, C., Guyon, X., et al., 2010. *Spatial statistics and modeling*. vol-
916 ume 90. Springer.
- 917 Glasser, M.F., Sotiropoulos, S.N., Wilson, J.A., Coalson, T.S., Fischl, B.,
918 Andersson, J.L., Xu, J., Jbabdi, S., Webster, M., Polimeni, J.R., Van Es-
919 sen, D.C., Jenkinson, M., 2013. The minimal preprocessing pipelines for
920 the Human Connectome Project. *NeuroImage* 80, 105–124.

- 921 Greve, D.N., Brown, G.G., Mueller, B.A., Glover, G., Liu, T.T., Function
922 Biomedical Research Network, 2013. A Survey of the Sources of Noise in
923 fMRI. *Psychometrika* 78, 396–416.
- 924 Greve, D.N., Mueller, B.A., Liu, T., Turner, J.A., Voyvodic, J., Yetter, E.,
925 Diaz, M., McCarthy, G., Wallace, S., Roach, B.J., Ford, J.M., Mathalon,
926 D.H., Calhoun, V.D., Wible, C.G., Brown, G.G., Potkin, S.G., Glover,
927 G., 2011. A novel method for quantifying scanner instability in fMRI:
928 Quantifying Scanner Instability in fMRI. *Magnetic Resonance in Medicine*
929 65, 1053–1061.
- 930 Gunst, R.F., 1995. Estimating spatial correlations from spatial-temporal
931 meteorological data. *Journal of climate* 8, 2454–69.
- 932 Hartvig, N.V., Jensen, J.L., 2000. Spatial mixture modeling of fMRI data.
933 *Human Brain Mapping* 11, 233–248.
- 934 Jiang, L., Zuo, X.N., 2016. Regional Homogeneity: A Multimodal, Multiscale
935 Neuroimaging Marker of the Human Connectome. *The Neuroscientist* 22,
936 486–505.
- 937 Jo, H.J., Saad, Z.S., Simmons, W.K., Milbury, L.A., Cox, R.W., 2010. Map-
938 ping sources of correlation in resting state FMRI, with artifact detection
939 and removal. *NeuroImage* 52, 571–582.
- 940 Köhler, S., McIntosh, A.R., Moscovitch, M., Winocur, G., 1998. Functional
941 interactions between the medial temporal lobes and posterior neocortex
942 related to episodic memory retrieval. *Cerebral Cortex* 8, 451–461.

- 943 Lazar, N.A., 2008. Noise and Data Preprocessing, in: *The Statistical Analysis*
944 *of Functional MRI Data*. Springer New York, New York, NY, pp. 37–51.
945 ISSN: 1431-8776 Series Title: *Statistics for Biology and Health*.
- 946 Lin, L.I.K., 1989. A Concordance Correlation Coefficient to Evaluate Re-
947 producibility. *Biometrics* 45, 255–268. Publisher: [Wiley, International
948 Biometric Society].
- 949 Liu, T.T., 2016. Noise contributions to the fMRI signal: An overview. *Neu-*
950 *roImage* 143, 141–151.
- 951 Markello, R.D., Misic, B., 2021. Comparing spatial null models for brain
952 maps. *NeuroImage* 236, 118052.
- 953 Moulines, E., Roueff, F., Taqqu, M.S., 2007. On the spectral density of the
954 wavelet coefficients of long-memory time series with application to the log-
955 regression estimation of the memory parameter. *Journal of Time Series*
956 *Analysis* 28, 155–187.
- 957 Murphy, K., Birn, R.M., Bandettini, P.A., 2013. Resting-state fMRI con-
958 founds and cleanup. *NeuroImage* 80, 349–359.
- 959 Ng, B., Varoquaux, G., Poline, J.B., Greicius, M., Thirion, B., 2016. Trans-
960 port on Riemannian Manifold for Connectivity-Based Brain Decoding.
961 *IEEE Transactions on Medical Imaging* 35, 208–216.
- 962 Ogawa, A., 2021. Time-varying measures of cerebral network centrality
963 correlate with visual saliency during movie watching. *Brain and Behav-*
964 *ior* 11, e2334. [https://onlinelibrary.wiley.com/doi/pdf/10.1002/](https://onlinelibrary.wiley.com/doi/pdf/10.1002/brb3.2334)
965 [brb3.2334](https://onlinelibrary.wiley.com/doi/pdf/10.1002/brb3.2334).

- 966 Ostroff, C., 1993. Comparing correlations based on individual-level and ag-
967 gregated data. *Journal of Applied Psychology* 78, 569.
- 968 Pawela, C.P., Biswal, B.B., Cho, Y.R., Kao, D.S., Li, R., Jones, S.R., Schulte,
969 M.L., Matloub, H.S., Hudetz, A.G., Hyde, J.S., 2008. Resting-state func-
970 tional connectivity of the rat brain. *Magnetic Resonance in Medicine* 59,
971 1021–1029.
- 972 Petersen, A., Zhao, J., Carmichael, O., Müller, H.G., 2016. Quantifying Indi-
973 vidual Brain Connectivity with Functional Principal Component Analysis
974 for Networks. *Brain Connectivity* 6, 540–547.
- 975 Poline, J.B., Worsley, K.J., Evans, A.C., Friston, K.J., 1997. Combining spa-
976 tial extent and peak intensity to test for activations in functional imaging.
977 *NeuroImage* 5, 83–96.
- 978 Poline, J.B., Worsley, K.J., Holmes, A.P., Frackowiak, R.S.J., Friston, K.J.,
979 1995. Estimating Smoothness in Statistical Parametric Maps: Variability
980 of p Values. *Journal of Computer Assisted Tomography* 19, 788–796.
- 981 Richiardi, J., Achard, S., Bunke, H., Van De Ville, D., 2013. Machine Learn-
982 ing with Brain Graphs: Predictive Modeling Approaches for Functional
983 Imaging in Systems Neuroscience. *IEEE Signal Processing Magazine* 30,
984 58–70.
- 985 Rosner, B., Donner, A., Hennekens, C., 1977. Estimation of interclass corre-
986 lation from familial data. *Applied statistics* 26, 179–187.
- 987 Salvador, R., Suckling, J., Schwarzbauer, C., Bullmore, E., 2005. Undirected

988 graphs of frequency-dependent functional connectivity in whole brain net-
989 works. *Philosophical Transactions of the Royal Society B: Biological Sci-*
990 *ences* 360, 937–946.

991 Stanley, M.L., Moussa, M.N., Paolini, B.M., Lyday, R.G., Burdette, J.H.,
992 Laurienti, P.J., 2013. Defining nodes in complex brain networks. *Frontiers*
993 *in Computational Neuroscience* 7.

994 Student, 1914. The elimination of spurious correlation due to position in
995 time and space. *Biometrika* 10, 179–181.

996 Termenon, M., Jaillard, A., Delon-Martin, C., Achard, S., 2016. Reliability
997 of graph analysis of resting state fMRI using test-retest dataset from the
998 human connectome project. *Neuroimage* 142, 172–187.

999 Tomasi, D., Volkow, N.D., 2010. Functional connectivity density mapping.
1000 *Proceedings of the National Academy of Sciences* 107, 9885–9890.

1001 Tooley, U.A., Bassett, D.S., Mackey, A.P., 2021. Environmental influences on
1002 the pace of brain development. *Nature Reviews Neuroscience* 22, 372–384.

1003 Triana, A.M., Glerean, E., Saramäki, J., Korhonen, O., 2020. Effects of
1004 spatial smoothing on group-level differences in functional brain networks.
1005 *Network Neuroscience* 4, 556–574.

1006 Uddin, L.Q., Kelly, A.C., Biswal, B.B., Margulies, D.S., Shehzad, Z., Shaw,
1007 D., Ghaffari, M., Rotrosen, J., Adler, L.A., Castellanos, F.X., Milham,
1008 M.P., 2008. Network homogeneity reveals decreased integrity of default-
1009 mode network in ADHD. *Journal of Neuroscience Methods* 169, 249–254.

- 1010 Van Dijk, K.R.A., Hedden, T., Venkataraman, A., Evans, K.C., Lazar, S.W.,
1011 Buckner, R.L., 2010. Intrinsic Functional Connectivity As a Tool For
1012 Human Connectomics: Theory, Properties, and Optimization. *Journal of*
1013 *Neurophysiology* 103, 297–321.
- 1014 Whitlow, C.T., Casanova, R., Maldjian, J.A., 2011. Effect of Resting-State
1015 Functional MR Imaging Duration on Stability of Graph Theory Metrics of
1016 Brain Network Connectivity. *Radiology* 259, 516–524.
- 1017 Wilson, D.J., 2019. The harmonic mean p -value for combining dependent
1018 tests. *Proceedings of the National Academy of Sciences* 116, 1195–1200.
- 1019 Worsley, K.J., Evans, A.C., Marrett, S., Neelin, P., 1992. A Three-
1020 Dimensional Statistical Analysis for CBF Activation Studies in Human
1021 Brain. *Journal of Cerebral Blood Flow & Metabolism* 12, 900–918. Pub-
1022 lisher: SAGE Publications Ltd STM.
- 1023 Worsley, K.J., Marrett, S., Neelin, P., Vandal, A.C., Friston,
1024 K.J., Evans, A.C., 1996. A unified statistical ap-
1025 proach for determining significant signals in images of cere-
1026 bral activation. *Human Brain Mapping* 4, 58–73. .eprint:
1027 [https://onlinelibrary.wiley.com/doi/pdf/10.1002/%28SICI%291097-](https://onlinelibrary.wiley.com/doi/pdf/10.1002/%28SICI%291097-0193%281996%294%3A1%3C58%3A%3AAID-HBM4%3E3.0.CO%3B2-O)
1028 [0193%281996%294%3A1%3C58%3A%3AAID-HBM4%3E3.0.CO%3B2-O.](https://onlinelibrary.wiley.com/doi/pdf/10.1002/%28SICI%291097-0193%281996%294%3A1%3C58%3A%3AAID-HBM4%3E3.0.CO%3B2-O)
- 1029 Yan, C.G., Cheung, B., Kelly, C., Colcombe, S., Craddock, R.C., Di Mar-
1030 tino, A., Li, Q., Zuo, X.N., Castellanos, F.X., Milham, M.P., 2013. A
1031 comprehensive assessment of regional variation in the impact of head mi-
1032 cromovements on functional connectomics. *NeuroImage* 76, 183–201.

1033 Ye, J., Lazar, N., Li, Y., 2011. Sparse geostatistical analysis in clustering
1034 fMRI time series. *Journal of Neuroscience Methods* 199, 336–345.

1035 Ye, J., Lazar, N.A., Li, Y., 2009. Geostatistical analysis in clustering fMRI
1036 time series. *Statistics in Medicine* 28, 2490–2508.

1037 Zang, Y., Jiang, T., Lu, Y., He, Y., Tian, L., 2004. Regional homogeneity
1038 approach to fMRI data analysis. *NeuroImage* 22, 394–400.

1039 Zhang, C., Cahill, N., Arbabshirani, M., White, T., Baum, S., Michael, A.,
1040 2016. Sex and age effects of functional connectivity in early adulthood.
1041 *Brain Connectivity* 6.

1042 **Appendix A. Brain functional connectivity review**

1043 The literature review was conducted on PubMed using the keywords
1044 "brain connectivity graph resting state 'human connectome project'" on
1045 September 30, 2021. The search returned 32 papers written between 2014
1046 and 2021. Out of those papers, 5 were not open access and 2 papers were lit-
1047 erature reviews, and were not considered further. 3 papers were either using
1048 seed-based or voxel-to-voxel correlation. Out of the remaining 24 papers 71%
1049 (17/24) first averaged voxels before computing the inter-regional correlations
1050 and 88% (21/24) employed some kind of spatial aggregation method, includ-
1051 ing but not limited to averaging over voxels, ICA or dictionary learning.

1052 **Appendix B. Hypotheses for the spatio-temporal model**

The assumptions on the model can be written as follows. For any $i, i' \in \mathcal{C}$ and $s, t = 1, \dots, T$,

$$\begin{aligned} \mathbb{E}[X_i(t)] &= \mathbb{E}[\varepsilon_i(t)] = \mathbb{E}[e(t)] = 0, \\ \mathbb{E}[X_i(s)X_i(t)] &= \mathbb{E}[\varepsilon_i(s)\varepsilon_i(t)] = \mathbb{E}[e(s)e(t)] = 0, \\ \mathbb{E}[X_i(s)\varepsilon_{i'}(t)] &= \mathbb{E}[X_i(s)e(t)] = \mathbb{E}[\varepsilon_i(s)e(t)] = 0, \\ \mathbb{E}[e(t)^2] &= \sigma_e^2. \end{aligned}$$

1053 Let Σ be the covariance matrix of the vector $(Y_i(t))_{i \in \mathcal{C}, t=1, \dots, T}$. In this
1054 paper, we assume without referring specifically to this assumption that the
1055 parameters $\sigma_j^2, \sigma_\varepsilon^2, \sigma_e^2, \rho_{ii'}, \eta_{ii'}, r_{jj'}$ are such that Σ is a positive definite
1056 matrix.

1057 We also assume that the random variables are independent in time. This
1058 is not overly restrictive: in particular, if the random variables have long
1059 memory, after a wavelet decomposition, the random variables can be approx-
1060 imated to be decorrelated in time for large wavelet scales (Moulines et al.,
1061 2007). In addition, assuming that the X_i 's are centered is coherent as it is
1062 a well-known fact that a wavelet decomposition based on a wavelet mother
1063 with K vanishing moments cancels out every polynomial trend with degree
1064 $K - 1$.

1065 Finally, to apply the law of large numbers, we also assume that all random
1066 variables are absolutely integrable, that is $\mathbb{E}[|Z_i(t)|] < \infty$ for $Z = X, \varepsilon, e$,
1067 $i \in \mathcal{C}$ and $t = 1, \dots, T$.

1068 **Appendix C. Properties of the estimators of interest**

For any set of indices E with cardinality $\#E$, we let

$$\bar{\rho}_E = \frac{1}{(\#E)^2} \sum_{i,i' \in E} \rho_{ii'} \quad \text{and} \quad \bar{\eta}_E = \frac{1}{(\#E)^2} \sum_{i,i' \in E} \eta_{ii'}. \quad (\text{C.1})$$

1069 The results of the paper are based on this proposition:

1070 **Proposition Appendix C.1.** *Consider the notation of Section 2.1 and*
 1071 *assumptions described in Appendix B. Let $j, j' \in \{1, \dots, J\}$.*

1072

(i) Let $E \subseteq \mathcal{R}_j$, then for any $t = 1, \dots, T$

$$\text{Var}[\bar{X}_E(t)] = \sigma_j^2 \bar{\rho}_E \quad (\text{C.2})$$

$$\text{Var}[\bar{\varepsilon}_E(t)] = \sigma_\varepsilon^2 \bar{\eta}_E = \mathcal{O}(1/(\#E)) \quad (\text{C.3})$$

$$\text{Var}[\bar{e}_E(t)] = \text{Var}(e(t)) = \sigma_\varepsilon^2 \quad (\text{C.4})$$

$$\text{Var}[\bar{Y}_E(t)] = \sigma_j^2 \bar{\rho}_E + \sigma_\varepsilon^2 \bar{\eta}_E + \sigma_\varepsilon^2. \quad (\text{C.5})$$

1073 (ii) Let $E \subseteq \mathcal{R}_j$ and $E' \subseteq \mathcal{R}_{j'}$, then

$$\text{Cov}[\bar{Y}_E(t), \bar{Y}_{E'}(t)] = \begin{cases} \sigma_j \sigma_{j'} r_{jj'} + \sigma_\varepsilon^2 & \text{if } j \neq j' \\ \sigma_j^2 \bar{\rho}_{E,E'} + \sigma_\varepsilon^2 & \text{if } j = j' \end{cases} \quad (\text{C.6})$$

1074 where

$$\bar{\rho}_{E,E'} = \frac{1}{(\#E)(\#E')} \sum_{i \in E, i' \in E'} \rho_{|i-i'|}. \quad (\text{C.7})$$

(iii) Let $i \in E \subseteq \mathcal{R}_j$ and $i' \in E' \subseteq \mathcal{R}_{j'}$ and assume for any $i \in E$ and $i' \in E'$ $|i - i'| \geq p$ (in the case $j = j'$). Then as $T \rightarrow \infty$, the following statements

hold almost surely.

$$\begin{aligned} \widehat{\sigma}^2(\mathbf{Y}_i) &\xrightarrow{a.s.} \text{Var}[Y_i(1)] & \text{and} & \quad \widehat{\text{Cov}}[\mathbf{Y}_i, \mathbf{Y}_{i'}] \xrightarrow{a.s.} \text{Cov}[Y_i(1), Y_{i'}(1)] & \text{(C.8)} \\ \widehat{\sigma}^2(\bar{\mathbf{Y}}_E) &\xrightarrow{a.s.} \text{Var}[\bar{Y}_E(1)] & \text{and} & \quad \widehat{\text{Cov}}[\bar{\mathbf{Y}}_E, \bar{\mathbf{Y}}_{E'}] \xrightarrow{a.s.} \text{Cov}[\bar{Y}_E(1), \bar{Y}_{E'}(1)]. & \text{(C.9)} \end{aligned}$$

1075 Proposition Appendix C.1 is given without proof. (i)-(ii) ensue from the
1076 model (1) while (iii) is quite straightforward since we have assumed indepen-
1077 dence in time.

1078 As seen from Proposition Appendix C.1, the quantity $\bar{\eta}_E$ is related to
1079 the correlation structure of the local noise. By assuming this noise to be
1080 p -dependent (that is $\eta_\delta = 0$ when $\delta \geq p$), it is clear that the larger $\#E$ the
1081 smaller $\bar{\eta}_E$.

1082 Appendix D. Consistency results for the existing estimators

1083 Appendix D.1. Consistency of $\widehat{r}_{jj'}^{\text{CA}}$

1084 Proposition Appendix C.1 shows $\widehat{r}_{jj'}^{\text{CA}}$ is a strongly consistent estimator
1085 of $r_{jj'}^{\text{CA}}$ as $T \rightarrow \infty$ where

$$r_{jj'}^{\text{CA}} = r_{jj'} \frac{1 + \sigma_{e,jj'}^2 / r_{jj'}}{\sqrt{(\bar{\rho}_{\mathcal{R}_j} + \sigma_{\varepsilon,j}^2 \bar{\eta}_{\mathcal{R}_j} + \sigma_{e,j}^2)(\bar{\rho}_{\mathcal{R}_{j'}} + \sigma_{\varepsilon,j'}^2 \bar{\eta}_{\mathcal{R}_{j'}} + \sigma_{e,j'}^2)}}. \quad (\text{D.1})$$

1086 Another way to correct the size effect is to compensate the inter-correlation
1087 by the intra-correlation. This would lead to the following estimator:

$$\widehat{r}_{jj'}^{\widetilde{\text{AC}}} = \frac{1}{N_j N_{j'}} \left(\sum_{i,i' \in \mathcal{R}_j} \widehat{\text{Cor}}(\mathbf{Y}_i, \mathbf{Y}_{i'}) \sum_{i,i' \in \mathcal{R}_{j'}} \widehat{\text{Cor}}(\mathbf{Y}_i, \mathbf{Y}_{i'}) \right)^{1/2} \widehat{r}^{\text{AC}}. \quad (\text{D.2})$$

1088 The two estimators (5) and (D.2) have the important property to remove the
1089 size effect (since when $\sigma_\varepsilon = \sigma_e = 0$, $r_{jj'}^{\text{AC}} = r_{jj'}$). Note that both estimators
1090 tend to the same limit.

1091 *Appendix D.2. Consistency of $\hat{r}_{jj'}^{\text{AC}}$*

1092 Proposition Appendix C.1 shows that $\hat{r}_{jj'}^{\text{AC}}$ is a strongly consistent esti-
 1093 mator of $r_{jj'}^{\text{AC}}$ given by

$$r_{jj'}^{\text{AC}} = r_{jj'} \frac{1 + \sigma_{e,jj'}^2/r_{jj'}}{\sqrt{(1 + \sigma_{e,j}^2 + \sigma_{e,j}^2)(1 + \sigma_{e,j'}^2 + \sigma_{e,j'}^2)}}. \quad (\text{D.3})$$

1094 As revealed by (D.1) and (D.3), $\hat{r}_{jj'}^{\text{CA}}$ and $\hat{r}_{jj'}^{\text{AC}}$ do not converge toward
 1095 $r_{jj'}$ when a local noise or global noise is present. We could ask why $\hat{r}_{jj'}^{\text{CA}}$ is
 1096 interesting. Actually, a first spatial averaging tends to decrease the effect
 1097 of the local noise. Indeed, when $\sigma_e^2 = 0$ (and with equal unit variances to
 1098 simplify), we have

$$r_{jj'}^{\text{CA}} = \frac{r_{jj'}}{\sqrt{(\bar{\rho}_{\mathcal{R}_j} + \sigma_\varepsilon^2 \bar{\eta}_{\mathcal{R}_j})(\bar{\rho}_{\mathcal{R}_{j'}} + \sigma_\varepsilon^2 \bar{\eta}_{\mathcal{R}_{j'}})}} \quad \text{and} \quad r_{jj'}^{\text{AC}} = \frac{r_{jj'}}{1 + \sigma_\varepsilon^2}.$$

1099 Hence, if we expect that $\bar{\rho}_{\mathcal{R}_j} \approx \bar{\rho}_{\mathcal{R}_{j'}} \approx 1$, $\hat{r}_{jj'}^{\text{CA}}$ will be a better estimator since
 1100 $\bar{\eta}_{\mathcal{R}_j} = \mathcal{O}(1/N_j)$. A natural compromise between $\hat{r}_{jj'}^{\text{CA}}$ and $\hat{r}_{jj'}^{\text{AC}}$ can be defined
 1101 using local neighborhood as defined by ℓ_{CA} .

1102 *Appendix D.3. Consistency of $\hat{r}_{jj'}^{\text{R}}$*

1103 From Proposition Appendix C.1, as $T \rightarrow \infty$

$$\frac{1}{4} \sum_{\alpha, \beta=1}^2 \widehat{\text{Cor}}(\mathbf{Y}_{i_\alpha^{(b)}}, \mathbf{Y}_{i_\beta^{(b)}}) \xrightarrow{\text{a.s.}} \frac{\sigma_j \sigma_{j'} r_{jj'} + \sigma_e^2}{\sqrt{(\sigma_j^2 + \sigma_\varepsilon^2 + \sigma_e^2)(\sigma_{j'}^2 + \sigma_\varepsilon^2 + \sigma_e^2)}}$$

1104 and

$$\widehat{\text{Cor}}(\mathbf{Y}_{i_1^{(b)}}, \mathbf{Y}_{i_2^{(b)}}) \xrightarrow{\text{a.s.}} \frac{\sigma_j^2 \rho_\delta + \sigma_e^2}{\sigma_j^2 + \sigma_\varepsilon^2 + \sigma_e^2},$$

1105 whereby we deduce that $\hat{r}_{jj'}^{\text{R}}$ is a strongly consistent estimator of

$$r_{jj'}^{\text{R}} = r_{jj'} \frac{1 + \sigma_{e,jj'}^2/r_{jj'}}{\sqrt{|(\rho_\delta + \sigma_{e,j}^2)(\rho_\delta + \sigma_{e,j'}^2)|}}. \quad (\text{D.4})$$

1106 From (D.4), we observe that when $\sigma_e = 0$ then for any unknown value of σ_ε ,
 1107 $\hat{r}_{jj'}^R$ estimates consistently $r_{jj'}/|\rho_\delta|$ which should be close to $r_{jj'}$ if we take
 1108 $\delta = p$ and expect that ρ_p is close to 1. In other words, the estimator $\hat{r}_{jj'}^R$ is
 1109 robust to the size of the regions and robust to a possible local noise.

1110 To reduce the assumption that ρ_p is close to 1, we can combine this idea
 1111 of replicates with local averaging. This is the topic of the next section.

1112 Appendix E. Consistency of $\hat{r}_{jj'}^D$

1113 The following result is the key ingredient:

Proposition Appendix E.1. *Under the notation of this section, as $T \rightarrow \infty$, the following statements hold almost surely.*

(i)

$$\widehat{\text{Cov}}(\mathbf{Y}_{i^{(b)}} - \mathbf{Y}_{k^{(b)}}, \mathbf{Y}_{i'^{(b)}} - \mathbf{Y}_{k'^{(b)}}) \xrightarrow{\text{a.s.}} \sigma_j \sigma_{j'} r_{jj'}.$$

1114 (ii)

$$2\widehat{S}^2(\mathbf{Y}_{i^{(b)}}, \mathbf{Y}_{k^{(b)}}, \mathbf{Y}_{k'^{(b)}}) \xrightarrow{\text{a.s.}} 2\sigma_j^2 + 2\sigma_\varepsilon^2. \quad (\text{E.1})$$

1115 *Proof.* (i) Using the independence in time, it is clear that the left-hand
 1116 side converges almost surely to $\text{Cov}(Y_{i^{(b)}}(1) - Y_{k^{(b)}}(1), Y_{i'^{(b)}}(1) - Y_{k'^{(b)}}(1)) =$
 1117 $\sigma_j \sigma_{j'} r_{jj'} + \sigma_e^2 - 2\sigma_e^2 + \sigma_e^2$ since the two regions \mathcal{R}_k and $\mathcal{R}_{k'}$ are disconnected,
 1118 which leads to the result.

1119 (ii) In the same way, the left-hand side tends to $\text{Var}(Y_{i^{(b)}}(1) - Y_{k^{(b)}}(1)) +$
 1120 $\text{Var}(Y_{i'^{(b)}}(1) - Y_{k'^{(b)}}(1)) - \text{Var}(Y_{k^{(b)}}(1) - Y_{k'^{(b)}}(1)) = \sigma_j^2 + \sigma_k^2 + \sigma_{k'}^2 + 4\sigma_\varepsilon^2 - \sigma_k^2 -$
 1121 $\sigma_{k'}^2 - 2\sigma_\varepsilon^2$ which yields the stated limit. \square

1122 In other words, Proposition Appendix E.1 shows that $\hat{r}_{jj'}^D$ is a strongly

1123 consistent estimator of $r_{jj'}^D$ given by

$$r^D = r_{jj'} \frac{1}{\sqrt{(1 + \sigma_{\varepsilon,j}^2)(1 + \sigma_{\varepsilon,j'}^2)}} \quad (\text{E.2})$$

1124 which, in the situation where $\sigma_\varepsilon = 0$, is nothing else than $r_{jj'}$.

1125 Appendix F. Consistency of $\widehat{r}_{jj'}^{\text{RD}}$

1126 The following result is a consequence of Propositions Appendix C.1-
1127 Appendix G.1.

1128 **Proposition Appendix F.1.** *As $T \rightarrow \infty$, the following statements hold*
1129 *almost surely.*

1130 (i) *For any $i_1, i_2 \in \mathcal{R}_j, i'_1, i'_2 \in \mathcal{R}_j, i_k \in \mathcal{R}_k$ and $i_{k'} \in \mathcal{R}_{k'}$, such that $|i_2 - i_1| =$
1131 $|i'_2 - i'_1| = \delta \geq p$*

$$\sqrt{|\widetilde{\text{Cor}}(\mathbf{Y}_{i_1}, \mathbf{Y}_{i_2}; \mathbf{Y}_{i_k}, \mathbf{Y}_{i_{k'}}) \widetilde{\text{Cor}}(\mathbf{Y}_{i'_1}, \mathbf{Y}_{i'_2}; \mathbf{Y}_{i_k}, \mathbf{Y}_{i_{k'}})|} \xrightarrow{\text{a.s.}} \frac{\sigma_j \sigma_{j'} |\rho_\delta|}{\sqrt{(\sigma_j^2 + \sigma_\varepsilon^2)(\sigma_{j'}^2 + \sigma_\varepsilon^2)}} \quad (\text{F.1})$$

(ii) *For any ν -neighborhoods $\mathcal{V}_{j_1}, \mathcal{V}_{j_2} \in \mathcal{R}_j, \mathcal{V}'_{j_1}, \mathcal{V}'_{j_2} \in \mathcal{R}_{j'}$, $\mathcal{V}_k \in \mathcal{R}_k, \mathcal{V}_{k'} \in \mathcal{R}_{k'}$,
such that for any $i_1 \in \mathcal{V}_{j_1}, i_2 \in \mathcal{V}_{j_2}, i'_1 \in \mathcal{V}'_{j_1}, i'_2 \in \mathcal{V}'_{j_2}, |i_1 - i_2| = |i'_1 - i'_2| =$
 $\delta \geq p$*

$$\begin{aligned} & |\widetilde{\text{Cor}}(\bar{\mathbf{Y}}_{\mathcal{V}_{j_1}}, \bar{\mathbf{Y}}_{\mathcal{V}_{j_2}}; \bar{\mathbf{Y}}_{\mathcal{V}_k}, \bar{\mathbf{Y}}_{\mathcal{V}_{k'}}) \widetilde{\text{Cor}}(\bar{\mathbf{Y}}_{\mathcal{V}'_{j_1}}, \bar{\mathbf{Y}}_{\mathcal{V}'_{j_2}}; \bar{\mathbf{Y}}_{\mathcal{V}_k}, \bar{\mathbf{Y}}_{\mathcal{V}_{k'}})| \xrightarrow{\text{a.s.}} \\ & \frac{\sigma_j^2 \sigma_{j'}^2 \rho_{\mathcal{V}, \mathcal{V}'}^2 \delta}{(\sigma_j^2 \bar{\rho}_\nu + \sigma_\varepsilon^2 \bar{\eta}_\nu)(\sigma_{j'}^2 \bar{\rho}_\nu + \sigma_\varepsilon^2 \bar{\eta}_\nu)} \quad (\text{F.2}) \end{aligned}$$

1132 where $\mathcal{V}, \mathcal{V}'$ are two ν -neighborhoods at distance δ .

1133 Propositions Appendix G.1-Appendix F.1 show that $\widehat{r}_{jj'}^{\text{RD}}$ is a strongly
1134 consistent estimator of $r_{jj'}^{\text{RD}}$ given by

$$r_{jj'}^{\text{RD}} = \frac{r_{jj'}}{|\rho_\delta|} \quad (\text{F.3})$$

1135 **Appendix G. Consistency of localized versions of estimators**

1136 *Appendix G.1. Consistency of $\widehat{r}_{jj'}^{\ell\text{CA}}$*

1137 We can apply Proposition Appendix C.1 to show that $r_{jj'}^{\ell\text{CA}}$ is a strongly
1138 consistent estimator of

$$r_{jj'}^{\ell\text{CA}} = r_{jj'} \frac{1 + \sigma_{e,jj'}^2 / r_{jj'}}{\sqrt{(\bar{\rho}_{\mathcal{V}} + \sigma_{\varepsilon,j}^2 \bar{\eta}_{\mathcal{V}} + \sigma_{e,j}^2)(\bar{\rho}_{\mathcal{V}} + \sigma_{\varepsilon,j'}^2 \bar{\eta}_{\mathcal{V}} + \sigma_{e,j'}^2)}} \quad (\text{G.1})$$

1139 where \mathcal{V} is any ν -neighborhood. When there is no global noise ($\sigma_e = 0$) and
1140 for moderate ν , it may be expected that the denominator of $r_{jj'}^{\ell\text{CA}}$ is closer to
1141 1 than the ones of $r_{jj'}^{\text{CA}}$ and $r_{jj'}^{\text{AC}}$.

1142 *Appendix G.2. Consistency of $\widehat{r}_{jj'}^{\ell\text{R}}$*

1143 Proposition Appendix C.1 shows that $\widehat{r}_{jj'}^{\ell\text{R}}$ is a strongly consistent esti-
1144 mator of $r_{jj'}^{\ell\text{R}}$ defined by

$$r_{jj'}^{\ell\text{R}} = r_{jj'} \frac{1 + \sigma_{e,jj'}^2 / r_{jj'}}{\sqrt{|(\bar{\rho}_{\mathcal{V},\mathcal{V}',\delta} + \sigma_{e,j}^2)(\bar{\rho}_{\mathcal{V},\mathcal{V}',\delta} + \sigma_{e,j'}^2)|}} \quad (\text{G.2})$$

1145 where $\bar{\rho}_{\mathcal{V},\mathcal{V}',\delta}$ is defined by (C.7) with \mathcal{V} and \mathcal{V}' two ν -neighborhoods at dis-
1146 tance δ . Similarly to the estimator \widehat{r}^{R} , when $\sigma_e = 0$, the previous expression
1147 reduces to $r_{jj'}^{\ell\text{R}} = r_{jj'} / |\bar{\rho}_{\mathcal{V},\mathcal{V}',\delta}|$ and again it is not unreasonable to think that
1148 $\bar{\rho}_{\mathcal{V},\mathcal{V}',\delta}$ is close to 1.

1149 *Appendix G.3. Consistency of $\widehat{r}_{jj'}^{\ell\text{D}}$*

1150 The following result is an adaptation of Proposition Appendix E.1 to
1151 local averages.

Proposition Appendix G.1. *As $T \rightarrow \infty$, the following statements hold almost surely.*

(i)

$$\widehat{\text{Cov}}(\bar{\mathbf{Y}}_{\mathcal{V}_j^{(b)}} - \bar{\mathbf{Y}}_{\mathcal{V}_k^{(b)}}, \bar{\mathbf{Y}}_{\mathcal{V}_{j'}^{(b)}} - \bar{\mathbf{Y}}_{\mathcal{V}_{k'}^{(b)}}) \xrightarrow{\text{a.s.}} \sigma_j \sigma_{j'} r_{jj'}.$$

1152 (ii)

$$2\widehat{s}^2(\bar{\mathbf{Y}}_{\mathcal{V}_j^{(b)}}, \bar{\mathbf{Y}}_{\mathcal{V}_k^{(b)}}, \bar{\mathbf{Y}}_{\mathcal{V}_{j'}^{(b)}}) \xrightarrow{\text{a.s.}} 2\sigma_j^2 \bar{\rho}_{\mathcal{V}} + 2\sigma_{\varepsilon}^2 \bar{\eta}_{\mathcal{V}}. \quad (\text{G.3})$$

1153 Using Proposition Appendix G.1 (for which proof follows along simi-
1154 lar lines as Proposition Appendix E.1), we deduce that $\widehat{r}_{jj'}^{\ell\text{D}}$ is a strongly
1155 consistent estimator of $r_{jj'}^{\ell\text{D}}$ given by

$$r_{jj'}^{\ell\text{D}} = r_{jj'} \frac{1}{\sqrt{(\bar{\rho}_{\mathcal{V}} + \sigma_{\varepsilon,j}^2 \bar{\eta}_{\mathcal{V}})(\bar{\rho}_{\mathcal{V}} + \sigma_{\varepsilon,j'}^2 \bar{\eta}_{\mathcal{V}})}} \quad (\text{G.4})$$

1156 where \mathcal{V} is any ν -neighborhood.

1157 *Appendix G.4. Consistency of $\widehat{r}_{jj'}^{\ell\text{RD}}$*

1158 Propositions Appendix G.1-Appendix F.1 show that $\widehat{r}_{jj'}^{\ell\text{RD}}$ is a strongly
1159 consistent estimator of $r_{jj'}^{\ell\text{RD}}$ given by

$$r_{jj'}^{\ell\text{RD}} = \frac{r_{jj'}}{|\bar{\rho}_{\mathcal{V},\mathcal{V}',\delta}|} \quad (\text{G.5})$$

1160 where \mathcal{V} and \mathcal{V}' are two ν -neighborhoods at distance δ . Similarly to the
1161 previous estimator, $\widehat{r}_{jj'}^{\ell\text{RD}}$ is robust to an additive global and local noise.

1162 *Appendix G.5. Robustness of CCC differences in terms of threshold*

1163 In the main text, we presented the difference of CCC for the different
1164 estimators based on a single threshold corresponding to 20% of the edges of
1165 the graph. Figure G.9 displays the variability of CCC according to different

1166 number of edges selected to construct the graph. This shows the robustness
1167 of our findings where ℓ_{CA} has always higher CCC than CA for all possible
1168 thresholds.

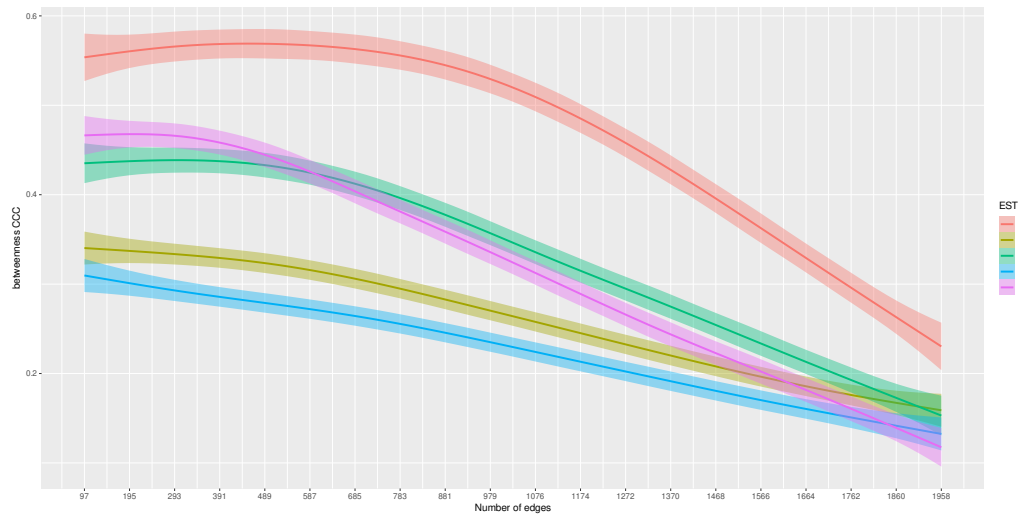

Figure G.9: CCC of betweenness according to different choices of threshold and for the different estimators.