



HAL
open science

Sustainable aviation in the context of the Paris Agreement: A review of prospective scenarios and their technological mitigation levers

S. Delbecq, J. Fontane, N. Gourdain, T. Planès, F. Simatos

► To cite this version:

S. Delbecq, J. Fontane, N. Gourdain, T. Planès, F. Simatos. Sustainable aviation in the context of the Paris Agreement: A review of prospective scenarios and their technological mitigation levers. Progress in Aerospace Sciences, 2023, 141, pp.100920. 10.1016/j.paerosci.2023.100920 . hal-04237360

HAL Id: hal-04237360

<https://hal.science/hal-04237360>

Submitted on 14 Nov 2023

HAL is a multi-disciplinary open access archive for the deposit and dissemination of scientific research documents, whether they are published or not. The documents may come from teaching and research institutions in France or abroad, or from public or private research centers.

L'archive ouverte pluridisciplinaire **HAL**, est destinée au dépôt et à la diffusion de documents scientifiques de niveau recherche, publiés ou non, émanant des établissements d'enseignement et de recherche français ou étrangers, des laboratoires publics ou privés.

Sustainable aviation in the context of the Paris Agreement: A review of prospective scenarios and their technological mitigation levers

S. Delbecq, J. Fontane, N. Gourdain^{*}, T. Planès, F. Simatos

ISAE-SUPAERO, Université de Toulouse, 10 avenue Édouard Belin, Toulouse, 31055, France

A B S T R A C T

Keywords:

Sustainable aviation
Prospective scenarios
Aircraft efficiency
Fuel decarbonization
Aviation climate impact

The sustainability of air transport is increasingly studied in relation to climate issues. The objective of this paper is to provide the key elements for assessing whether a given transition scenario for aviation could be considered as sustainable in the context of the Paris Agreement. Addressing this question relies on a broad range of concepts which are reviewed. First, ethical considerations related to effort-sharing mitigation principles and physical considerations on climate impacts of aviation are introduced. Then, the technological levers of action for mitigating CO₂ and non-CO₂ effects are detailed. Concerning CO₂ emissions, low-carbon alternative energy carriers represent the main lever, with a wide range of solutions with varying degrees of maturity and decarbonization potentials. Other significant CO₂ levers include improving aircraft architecture efficiency and accelerating fleet renewal. Concerning non-CO₂ effects, contrail effect mitigation through operational strategies is one of the most promising lever. Aviation transition scenarios are then reviewed, with a particular focus on scenario simulation and sustainability assessment methodologies. Prospective scenarios are a useful framework for assessing the impacts of technological levers on the achievement of climate objectives. This review leads to the conclusion that technological levers have an important role to play in making aviation sustainable; however, significant uncertainties weigh on their feasibility, particularly for the most ambitious scenarios which rely on strong technological and political trade-off assumptions. The paper ends by raising the question about the meaning of sustainable aviation, which must be based on technological but also, for instance, social, economic and ethical considerations.

1. Introduction

In its Working Group I Sixth Assessment Report (AR6) published in August 2021 [1], the Intergovernmental Panel on Climate Change (IPCC) stated that “observed changes in climate are unequivocal at the global scale” and that “human influence on the climate system is now an established fact”: between the periods 1850–1900 and 2011–2020, the average global temperature has raised by 1.09 °C, of which 1.07 °C is due to human activities. The impacts of this human-induced climate change such as water scarcity, extreme weather events, sea level rise or biodiversity loss are already observable and are expected to intensify with the global temperature rise [2].

1.1. Paris Agreement

In light of this scientific evidence, climate change mitigation and adaptation have come to the forefront of international policy. The Paris

Agreement is an international and legally binding treaty which was adopted by 196 Parties of the United Nations Framework Convention on Climate Change (UNFCCC) at COP 21 in Paris, on December 12th, 2015.¹ Its general goal, defined in Article 2, is to “strengthen the global response to the threat of climate change”. Several more precise goals are stated in the Agreement, among which two are particularly relevant for our purposes [3]:

1. Article 2 states a long-term objective in terms of temperature, namely “[to hold] the increase in the global average temperature to well below 2 °C above pre-industrial levels and [to pursue] efforts to limit the temperature increase to 1.5 °C above pre-industrial levels”;
2. Article 4 formulates an objective in terms of emissions, namely “to achieve a balance between anthropogenic emissions by sources and removals by sinks of greenhouse gases in the second

^{*} Corresponding author.

E-mail addresses: scott.delbecq@isae.fr (S. Delbecq), jerome.fontane@isae.fr (J. Fontane), nicolas.gourdain@isae.fr (N. Gourdain), thomas.planes@isae.fr (T. Planès), florian.simatos@isae.fr (F. Simatos).

¹ See for instance the [webpage of the UNFCCC dedicated to the Paris Agreement](#).

Nomenclature

ACARE	Advisory Council for Aeronautical Research in Europe
AEC	Alternative Energy Carrier
AESA	European Union Aviation Safety Agency
AKM	Aircraft-Kilometer
AR5	Fifth Assessment Report
AR6	Sixth Assessment Report
ASK	Available Seat-Kilometer
ATAG	Air Transport Action Group
ATJ	Alcohol-To-Jet
BECCS	Biomass Energy with Carbon Capture and Storage
BLADE	Breakthrough Laminar Aircraft Demonstration in Europe
BLI	Boundary Layer Ingestion
BWB	Blended-Wing Body
CCS	Carbon Capture and Storage
CDR	Carbon Dioxide Removal
CROR	Contra-Rotating Open Rotors
CSP	Concentrated Solar Power
DAC	Direct Air Capture
DSHC	Direct Sugar to Hydrocarbon
EHA	Electro-Hydrostatic Actuator
EIS	Entry-Into-Service
EMA	Electromechanical Actuator
EMC	Electromagnetic Compatibility
ERF	Effective Radiative Forcing
EU	European Union
EWIS	Electrical Wiring Interconnection System
FT	Fischer-Tropsch
GHG	Greenhouse Gas
HEFA	Hydroprocessed Esters and Fatty Acids
HTE	High Temperature Electrolysis
IAM	Integrated Assessment Model
ICAO	International Civil Aviation Organization
IEA	International Energy Agency
IPCC	Intergovernmental Panel on Climate Change
LCA	Life Cycle Assessment
LHV	Lower Heating Value
LTE	Low Temperature Electrolysis
LUC	Land Use Change
MEA	More Electric Aircraft
NDC	Nationally Determined Contribution
PAX	Revenue Passengers
PbTL	Power- and Biomass-to-Liquid
PDE	Pulsating Detonation Engines
PtL	Power-to-Liquid
RDE	Rotating Detonation Engines
RF	Radiative Forcing
RPK	Revenue Passenger-Kilometer
RTK	Revenue Tonne-Kilometers
SAF	Sustainable Aviation Fuel
SBW	Strut-Braced Wing
SFC	Specific Fuel Consumption

SMR	Short-Medium Range
TCRE	Transient Climate Response to cumulative Emissions
TRL	Technology Readiness Level
UCO	Used Cooking Oil
UHBR	Ultra High Bypass Ratio
UNFCCC	United Nations Framework Convention on Climate Change
VHBR	Very High Bypass Ratio
WG	Working Group

half of this century”, i.e., to reach net zero greenhouse gas (GHG) emissions between 2050 and 2100.

The Paris Agreement does not define climate objectives for each Party, but rather asks in its Article 4 that each Party sets nationally determined contributions (NDC). Concerning international aviation, emissions are not accounted for in national inventories because of their international nature, and are therefore not included in NDC’s. Said otherwise, emissions from the international aviation sector are not covered by the Paris Agreement: the Kyoto protocol rather delegated this responsibility to the International Civil Aviation Organization (ICAO), the UN specialized agency for aviation.

The temperature target of Article 2 is set as a range of temperatures whose upper bound (“well below 2°C”) is only loosely defined. As it will be seen below, it is important to keep this observation in mind when assessing prospective scenarios, for instance for the aviation sector, as every tenth of degree has a significant impact on emission pathways. Pathways limiting global warming to 1.5°C are very different from those limiting global warming to 2°C. Thus, it opens the possibility for a wide range of scenarios that can claim to be compatible with the Paris Agreement, depending on one’s interpretation of “well below”, all the more given the uncertainties that underlie estimates of temperature increase. At any rate, scenarios only limiting global warming to 2°C are not compatible with the Paris Agreement.

The objective of Article 4 of the Paris Agreement rests upon the fact that temperature increase can only be stopped if the atmospheric concentration of GHG ceases to increase. However, the eventual increase in temperature crucially relies on the time at which this happens, and also on the whole emission pathway before that.

1.2. IPCC and Paris Agreement

In order to make the link between emission pathways and the goals of the Paris Agreement, the UNFCCC invited the IPCC to provide a Special Report on the impacts of global warming of 1.5°C above pre-industrial levels and related global GHG emission pathway. The IPCC accepted the UNFCCC’s invitation at its 43rd Session in 2016, and published the Special Report *Global Warming of 1.5°C* in 2018. In addition to describing impacts and emission pathways related to a global warming of 1.5°C, this Special Report also offers a comparison between impacts of global warming of 1.5°C and 2°C.

Although the Paris Agreement mentions reaching net zero GHG emissions, the IPCC’s AR6, published in 2021–2022, stresses that “limiting human-induced global warming to a specific level requires limiting cumulative CO₂ emissions, reaching at least net zero CO₂ emissions, along with strong reductions in other GHG emissions” [1]. In particular, emphasis is put on CO₂ emissions and the need to reach carbon neutrality, which is different from GHG neutrality, and other GHG such as methane are treated separately. This separate treatment of CO₂ and non-CO₂ emissions has two main reasons. First, CO₂ is the main driver of global warming, being responsible for around 80% of the temperature increase between 1750 and 2019 [4, Figure 7.7]. Second,

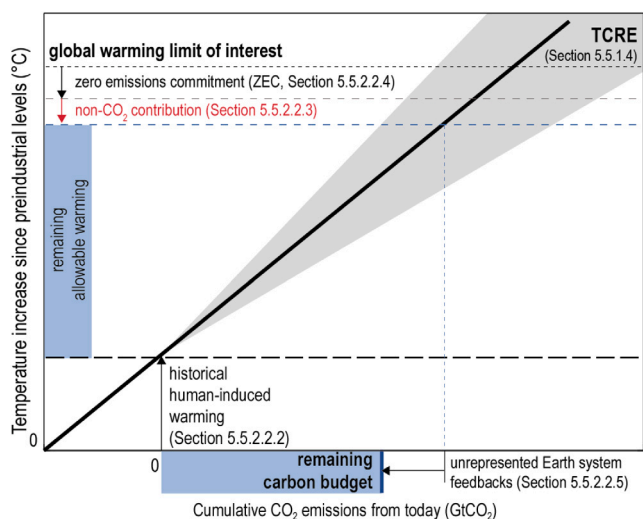

Fig. 1. Illustration of how carbon budgets are computed. The black line gives the linear relation between cumulative CO₂ emissions and temperature increase (the slope of this line is the central value of TCRE). The gray area illustrates the uncertainty in the TCRE value. The figure illustrates also the way the non-CO₂ contribution, the potential additional warming after reaching net-zero and Earth system feedback are accounted for.

Source: From AR6, WGI, Figure 5.31 [7].

it is difficult to treat all climate forcers with a single metric, which owes in part to the different persistence duration of different climate forcers. Noticeably, CO₂ is a long-lived climate forcer, with around 20% of emitted CO₂ remaining in the atmosphere after 1000 years [5, Box6.1].² In contrast, the lifetime of methane (CH₄) is between 9 and 12 years, which makes it a short-lived climate forcer, and that of nitrous oxide (N₂O) between 109 and 116 years [6, Table 2.2].

The notion of carbon budget quantifies the level at which cumulative CO₂ emissions need to be limited in order to maintain temperature below certain thresholds. In AR6, remaining carbon budget is defined as the maximum amount of cumulative net global anthropogenic CO₂ emissions expressed from a recent specified date that would result in limiting global warming to a given level with a given probability, taking into account the effect of other anthropogenic climate forcers [7].

Fig. 1 illustrates the way carbon budgets are computed. It rests upon a fundamental fact: despite change in global temperature being regulated by complex processes, it is nearly linearly related with cumulative emissions of CO₂. The slope of the line is a critical parameter to assess carbon budgets: it is called Transient Climate Response to cumulative Emissions of CO₂ or TCRE. Its best estimate is 1.65 °C per 1000 PgC, corresponding to the black line in Fig. 1, with a likely range of values between 1.0 °C and 2.3 °C [7], corresponding to the gray area in Fig. 1. TCRE allows to convert emissions of CO₂ into a change in global temperature by considering various processes, namely terrestrial and oceanic carbon uptake, radiative forcing (RF) from CO₂, and ocean heat uptake.

Table 1 presents various carbon budgets for varying temperature limit and TCRE percentile. We see for instance that the remaining carbon budget from the beginning of 2020 is equal to 700 GtCO₂ for a 67% likelihood of limiting global warming to 1.7 °C. It means that if cumulative net CO₂ emissions amount to 700 GtCO₂ from 2020 to the year where net CO₂ emissions reach zero, then there is 67% chance that temperature increase will be limited to 1.7 °C compared to the pre-industrial period. Here the uncertainty is that of TCRE (the gray area

Table 1

Different values of carbon budget for varying warming levels and TCRE percentile. For instance, the remaining carbon budget to limit global warming to + 1.7 °C with more than 67% of success is equal to 700 GtCO₂.

Source: Adapted from IPCC, AR6, WGI, table 5.8 [7].

Remaining carbon budget starting from 1st of January 2020 by TCRE percentile and warming level			
Warming since	TCRE percentile		
	33%	50%	67%
1850–1900			
+1.5 °C	650	500	400
+1.7 °C	1050	850	700
+2 °C	1700	1350	1150

in Fig. 1). Besides this uncertainty, there are four other variations and uncertainties that may affect carbon budgets (see [7] for more details):

1. estimates of historical warming (vertical black arrow pointing up in Fig. 1);
2. non-CO₂ warming contribution (red arrow in Fig. 1);
3. the potential additional warming after a complete cessation of net CO₂ emissions (vertical black arrow pointing down in Fig. 1);
4. adjustments for additional Earth system feedbacks (horizontal black arrow in Fig. 1).

It is important to keep in mind that these uncertainties may be significant. For instance, the values of carbon budget reported in Table 1 do not take into account non-CO₂ emissions such as methane emissions, which may increase or decrease by 220 GtCO₂ the corresponding carbon budget. When combining the uncertainties related to TCRE, non-CO₂ forcing and response, the level of non-CO₂ mitigation and historical warming, the IPCC concludes that “there is a small probability that the remaining carbon budget for limiting warming to +1.5 °C since the 1850–1900 period is effectively zero.”

1.3. Sharing carbon budgets among countries

The notion of carbon budget is defined at the global scale. NDCs constitute a mechanism designed to share this carbon budget in a distributed manner among countries, but as every country sets its own emission target, there is no guarantee that, once reconciled, the NDCs altogether will comply with the Paris Agreement objectives. In order to make the NDCs converge towards achieving net zero emissions in the second half of the century, the Paris Agreement set up a “ratchet mechanism” whereby ambitions are increased over time.

In these international negotiations, and also in public debate, the question of equity is crucial as it is a key component to enable deeper climate ambitions [8]. Equity is an ethical principle which has been endorsed by the UNCCC: it is recalled in the preamble and in various articles of the Paris Agreement, together with the principles of common but differentiated responsibilities and of respective capacities. Whether an allocation of the carbon budget among countries is fair or not unavoidably rests on ethical premises. Three different equity principles are proposed in [9], which echo those of the UNCCC: equality, responsibility and capability. Equality relies on the equality of all human beings and points towards a per-capita division of the carbon budget; responsibility suggests to take into account the responsibility into the current temperature increase, which is directly related to past cumulative emissions [10]; and capability suggests to apportion effort, for instance to financial and technological capabilities. In Berg et al. [11], two other effort-sharing principles are considered: cost-based principles and the grandfathering approach (see below). These general principles can be combined to create a wide range of possibilities, which lead to very different allocations. The grandfathering approach tends to systematically favor wealthiest countries, while allocations based on responsibilities and capacities can lead to negative carbon budgets for

² Excess of CO₂ emitted in the atmosphere is characterized by multiple residence times, so that no lifetime is provided for CO₂ in AR6.

the same countries [11], meaning that these countries have a “carbon debt” towards other countries.

These equity principles do not cover the whole possible spectrum: for instance, Dooley et al. [12] mention other principles such as need, environmental and transitional justice, ecological debt, intergenerational equity, survival emissions, progressivity, prioritarianism and egalitarianism. These authors also stress that no choice can be considered as “neutral”, and they point to the importance of making explicit the normative assumptions and values underlying the considered allocation [12].

One approach is particularly discussed in the literature, namely the grandfathering approach: in this approach, a country is allocated a share of the carbon budget which is proportional to the share of its emissions (whether current or historical). In a context of emission reduction, this amounts to asking every country to diminish its emission at the same relative speed, i.e., if global emissions need to decrease by 5% per year to respect a given carbon budget, then, under the grandfathering approach where current emissions are considered, every country would need to make its emissions decrease by 5% per year. By definition, this allocation can only be considered as just if the existing share of emissions is also fair. Moreover, this allocation goes against the principle of differentiated responsibilities (because it rather favors countries with an important share of emissions) and does not consider people’s needs. Actually, this approach is mainly justified by pragmatic reasons, for instance by the necessity to include grandfathering at the start of a scheme that could be strengthened later, or because of the priority to avert catastrophic climate change over fairness considerations [13]. At any rate, the grandfathering approach is not based on equity principles, and considering it as an equity principle is even considered by some authors as “morally perverse” [12,14].

1.4. Sharing carbon budgets among business sectors

The works discussed above have studied the fairness of various allocation and effort-sharing schemes. However, they focus on sharing the carbon budget between countries and so leave open the question on how to apply these ideas to business sectors such as aviation. This question has actually been considered in another stream of work on absolute environmental sustainability [15]. The goal of absolute environmental sustainability is to assess whether the impact of a particular unit (country, business sector, etc.) is absolutely sustainable or not, by comparing its environmental impact to absolute thresholds. For instance, the carbon budget approach is a particular example of absolute environmental sustainability assessment, but the scope may be much larger, e.g., by considering the planetary boundaries framework [16]. In this context, what is to be shared is the safe operating space (instead of the carbon budget), and the step of sharing this safe operating space is called *downscaling*. Applications in various fields can be found in the literature. For instance, studies have been performed in chemistry [17], building [18], electricity production in the United States [19] and road transport [20].

A review of various sharing principles is performed in [21] in the context of distributive justice theory. This review includes seven academic papers assessing the absolute environmental sustainability of industry sectors, products or companies rather than countries. One of the important insight is that, when considering a particular sharing principle, the *target* of distribution should be well-defined. And even though one may share the carbon budget between units which may not directly relate to a group of human beings (like a business sector, and not a country, such as aviation), distribution among individual human beings should be the target because it is individual human beings that are ultimately the center of the reasoning. As the authors of [21] put it, “when we owe something to a country it is because we owe something to its inhabitants, when we owe something to a company it is because we owe something to its users.” So even though we switch from allocating a share of the carbon budget to a country to allocating

a share of the carbon budget to a business sector, the target remains the same, namely human beings.

These discussions show that insight obtained on sharing a carbon budget between countries can be considered for sharing a carbon budget between business sectors. However, comparisons should be made with caution because of the many methodological differences in allocations between countries and sectors. Indeed, it is difficult to make an ethical comparison between a car user and an airplane user for example. As a consequence, in the case of business sectors, the use of other effort-sharing principles for performing allocations could bring other relevant insights. In addition to the grandfathering approach detailed in Section 1.3, numerous approaches can be used [22–24]: ability to pay, cost-effectiveness, cost-benefit, demand-based (using for instance proportional or constrained equal losses rule for sharing the carbon budget), etc. For instance, economic approaches have the advantage of being able to allocate efforts to minimize costs or maximize benefits when prioritizing technological solutions. Similarly, demand-based approaches can make it possible to identify the estimated efforts achievable by each business sector, and to manage possible allocation conflicts via different sharing rules.

1.5. Sustainable aviation in the context of the Paris Agreement

Following these discussions on business sector allocations, many questions arise regarding the application to the specific sector of aviation. As a consequence, there has recently been a surge of reports and academic papers trying to assess the climate impact of aviation transition scenarios. Compared to other business sectors, there are two reasons why aviation may deserve a particular treatment:

1. emissions from international aviation are not accounted for in national carbon inventories and are thus not covered by NDCs (note that, as mentioned above, emissions from domestic aviation are). This is a significant problem, as emissions from international aviation account for nearly 60% of emissions from passenger commercial aviation [25];
2. aviation non-CO₂ climate impacts are at least as significant as its CO₂ impacts (see Section 2 below): thus, only considering CO₂ emissions ignores a significant part (even probably the major part) of its climate impact.

For these reasons, various methodologies have been developed in order to assess the compatibility of aviation transition scenarios with the Paris Agreement. As a consequence, the motivation of this paper is to assess whether a given transition scenario for the aviation sector could be considered as sustainable in the context of the Paris Agreement. Addressing this question relies on a broad range of concepts and the main objective of the present paper is to review them.

The rest of the paper is organized as follows. First, an overview of the impact of aviation on climate change is given in Section 2. Then, Section 3 provides a specific Kaya identity for aviation. It allows to introduce the main levers of action for reducing aviation CO₂ emissions. Thus, the next two sections focus on each of the two technological levers and consider their potential evolution by 2050: the efficiency levers in Section 4 and the fuel decarbonization levers in Section 5. However, the last lever of the Kaya identity, namely traffic, will not be discussed here because it depends on economic, political and societal choices which fall outside the scope of this paper. Then, Section 6 provides a review on the potential technological solutions for reducing non-CO₂ effects, even if these aspects cannot be analyzed using the Kaya identity, due to its very construction. Based on the previous elements and a dedicated literature review on sustainable prospective scenarios for air transport, Section 7 deals with the main issues introduced previously concerning the inclusion of the Paris Agreement in the transition scenarios for the aviation sector. This section highlights the different methodologies used in the academic field for simulating and evaluating the climate sustainability of aviation scenarios. To

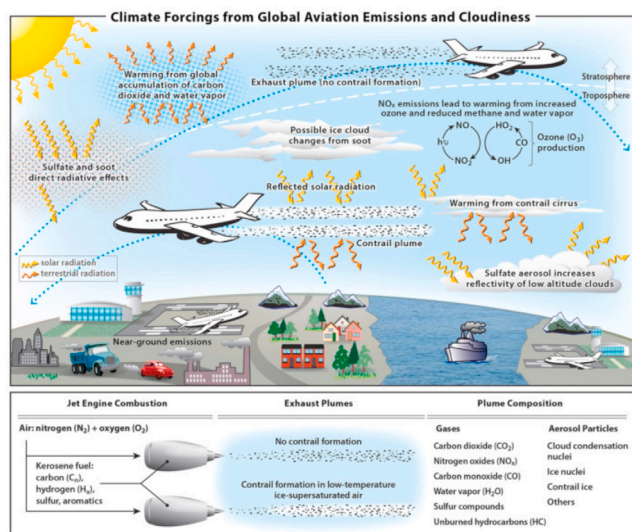

Fig. 2. Schematic view of the different processes by which aviation contributes to climate change, after Lee et al. [26].

go further, Section 8 discusses specific elements concerning aviation transition. This section allows to study the climate and energy sustainability of some illustrative prospective scenarios. A discussion on the consequences of climate change on air transport as well as on possible pitfalls of prospective scenarios is also conducted. Finally, conclusions and perspectives are given in Section 9.

2. Climate impact of aviation

In this section, the impact of aviation on climate is described and quantified. A comparison is also provided between the CO₂ effects and non-CO₂ effects as well as a discussion on the uncertainties.

2.1. A dual contribution to climate change

The aviation sector contributes to the increase in global warming through multiple mechanisms illustrated in Fig. 2 that are generally grouped in two categories, namely the CO₂ and non-CO₂ effects [26].

2.1.1. CO₂ effects

The CO₂ effects correspond to CO₂ emissions from aviation, the direct climate impact of which is reinforcement of the greenhouse effect. Most of CO₂ emissions come from the combustion of the kerosene by the aircraft engines, but the scope can be larger. For instance, well-to-tank CO₂ emissions occurring in the upstream part of the jet fuel life cycle also occur. As will be seen in Section 5, these emissions must also be taken into when comparing fossil kerosene to potential low-carbon alternative energy carriers. These emissions include emissions related to its production, refining and transport [27,28]. Moreover, CO₂ emissions occurring throughout the aircraft's life cycle, related to its construction, maintenance and end of life and related to airport infrastructures, must be also included but these emissions are small and represent only a few percent of all CO₂ emissions from aviation [29].

2.1.2. Non-CO₂ effects

The impact of aviation on climate is not limited to CO₂ emissions, as kerosene combustion releases other products, especially water vapor and aerosols which contribute to contrail formation. Depending on the flight phase, kerosene combustion may also emit nitrous oxide (N₂O) and methane (CH₄) but these emissions overall represent less

than 1% of CO₂-eq emissions³ and are therefore usually left out. In addition to the effects of these GHG, five non-CO₂ effects illustrated in Fig. 2 are also contributing to aviation climate impact: cirrus formation caused by condensation trails (*contrail cirrus* of Fig. 2), the effect of nitrogen oxides (NO_x) and water vapor on GHG concentrations, aerosol-radiation interactions and aerosol-cloud interactions. These effects are well documented in the literature and are only briefly described here, the reader is referred to the review of Lee et al. [26] for further details.

Condensation trails, or contrails, are thin linear clouds of ice particles which can be seen behind flying aircraft [30]. The formation and persistence of contrails depend on the ambient atmospheric conditions (temperature and relative humidity) and the mixing line of the plume air, defined by the revised Schmidt–Appleman criterion [31] which establishes the threshold temperature of contrail formation. Therefore, for contrails to form and persist, the mixing line of plume air must pass through the region of supersaturation with respect to liquid water and the ambient atmospheric water vapor must be both subsaturated with respect to liquid water and supersaturated with respect to ice. In dry air with a low relative humidity relative to ice, a contrail does not survive for more than a few minutes. But in ice supersaturated regions, the ice particles of the contrail grow by deposition of ambient water molecules and the contrail can persist, or even develop into induced-cirrus clouds difficult to distinguish from natural cirrus clouds. Aircraft spend 10 to 15% of their cruising time in such regions [32–34], and about 5% of the kerosene spent is burned in these regions [35]. These induced cirrus clouds increase the global cloudiness and have an overall warming effect [26].

The high combustion temperature produces **nitrogen oxides** which induce chemical reactions having effect on local concentration of three GHG, namely ozone (O₃), methane and water vapor. In the short-term, NO_x react with the oxygen in the air to form O₃ and, concurrently, participate in the reduction of the life time and local concentration of CH₄. In the longer term, the reduction of CH₄ leads to a decrease in stratospheric O₃ and water vapor. When all these reactions are taken into account, it appears that the NO_x contribution currently constitutes a warming effect [26].

Planes fly at an average altitude of 10000m, a region which corresponds to the lower stratosphere at high latitudes where a large part of global aircraft fleet yearly emissions are produced, mainly in the northern hemisphere. The accumulation of the associated **water vapor** emissions modifies the water content in the lower stratosphere and therefore the water vapor radiation balance leading to a warming effect [26].

Aerosol-radiation interactions are caused by non-volatile particulate matter emitted during combustion, mainly soot and aerosols precursor of both sulfate (SO₄²⁻) and nitrate (NO₃⁻). Soot aerosols are formed by the condensation of unburnt aromatic compounds in the combustion chamber and sulfate aerosol by oxidation of sulfur contained in the fuel. Most sulfate aerosols are produced after emission of compounds precursor of sulfur by oxidation in the ambient air. The soot absorbs shortwave radiation which leads to net warming, and the sulfate aerosol diffuses incoming shortwave radiation which leads to net cooling. For instance, global aviation emissions in 2000 increased the mass concentration of soot and sulfate aerosols by 3%–5% and the total concentration of aerosols by 10%–30% at the main flight levels in the Northern Hemisphere [36].

Aerosol-cloud interactions are processes by which aerosols influence cloud formation. Cloud droplets and ice crystals nucleate on aerosols such as soot and sulfate particles from planes. Sulfate aerosols mainly affect liquid clouds in the background atmosphere. They are highly effective as cloud condensation nuclei for the formation of liquid clouds and also promote the freezing of particles of solution at cold

³ See the note FCCC/SBST A/2005/INF.2 by the Subsidiary Body for Scientific and Technological Advice for example.

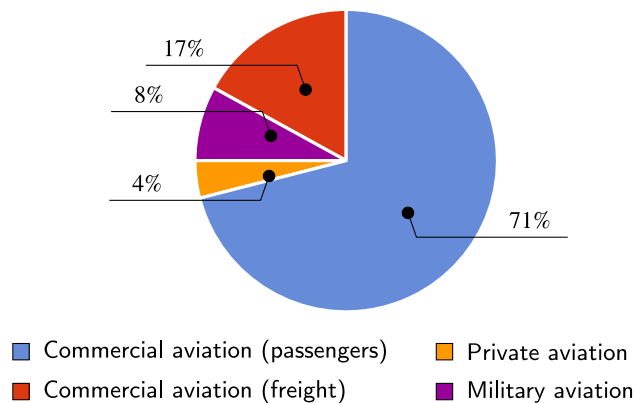

Fig. 3. Distribution of CO₂ emissions from global aviation in 2018 according to the type of aviation. After figure 1 of Gössling and Humpe [39].

temperatures, leading to ice cloud nucleation. There are very large uncertainties regarding the assessment of their effect on climate and there is even no scientific consensus whether they induce a warming or cooling effect [26]. This point is discussed in Section 2.4 below.

2.2. Evaluation of the climate impact of aviation

Several approaches can be used to evaluate the climate impact of aviation depending on the methodology and the scope considered. Note that here, we focus on global estimates, whereas methodologies have been proposed to estimate the climate impact of single flights [37]. Only evaluating CO₂ effects is a robust method as CO₂ emissions are known with a low level of uncertainty, but are incomplete because non-CO₂ effects are not included. The impact of aviation is first evaluated through CO₂ effects only before providing a more comprehensive method, including non-CO₂ effects.

2.2.1. Evaluation of CO₂ effects

Aviation CO₂ emissions can be evaluated from the energy consumption of the aviation sector provided by the IEA. What this data covers contains some ambiguity. Since 2006, the IEA demands that kerosene for military aviation not be reported with kerosene for commercial aviation, but also declares not to be sure if this demand is followed [38]. Therefore, the 1.05 GtCO₂ reported for 2018 in Table 2 do not in principle include military aviation. Nevertheless, this value is used by Lee et al. who study global aviation (i.e., commercial, military and private aviation), and it is also comparable to the 1046 MtCO₂ for global aviation estimated by Gössling and Humpe [39]. This is why we consider that the figures taken from the IEA correspond to global aviation which includes commercial aviation (Revenue Passengers (PAX) and Revenue Tonne-Kilometers (RTK)) as well as military and private aviation. As illustrated in Fig. 3, commercial aviation is estimated to have accounted for 88% of CO₂ emissions from global aviation in 2018, compared to 8% and 4% for military and private aviation, respectively [39]. Given the few data available for military and private aviation, this figure bears a high uncertainty. In the present paper, the focus is made on commercial aviation because it represents the major contribution to the climate impact of global aviation and because it is more relevant to focus on commercial aviation to evaluate prospective scenarios. Indeed, assumptions will be made for example on the traffic evolution, technological improvements or aircraft load factor in the following of the paper. These assumptions concern commercial aviation alone and their application to military and private aviation is not relevant because their traffic and efficiency evolution obeys to a different rationale. Nevertheless, military and private aviation will sometimes be included in the estimation presented in this section.

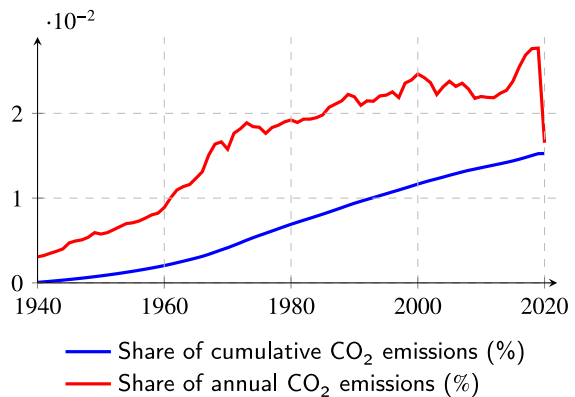

Fig. 4. Change in past and recent shares (yearly) of aviation in global CO₂ emissions over the period 1940–2020. The past share (in blue) corresponds to the value for cumulative emissions from aviation since 1750 divided by the cumulative global ones over the same period. The annual share (in red) corresponds to the value for annual emissions from aviation divided by the value of global annual emissions. Calculations based on data from [41] for CO₂ anthropogenic emissions, and data from [42] (period 1940–1972) and from the IEA (period 1973–2020) for aviation CO₂ emissions.

The conversion of energy consumption into CO₂ emissions requires the knowledge of the carbon intensity of kerosene. The carbon intensity of its combustion is known with a small uncertainty of 1% to 2% [26, 28]. In their recent review, Jing et al. [28] reported values ranging from 72.8 to 75.4 gCO₂-eq/MJ with a weighted average of 74.0 gCO₂-eq/MJ. This is the value retained here for the carbon intensity of kerosene and it is consistent with the values provided by Stratton et al. [27] or Lee et al. [26]. Concerning the emissions over the full life cycle of kerosene, the weighted average of 88.7 gCO₂-eq/MJ obtained by Jing et al. [28] over the range 81.1 to 94.8 gCO₂-eq/MJ is used here. This figure is slightly higher than the baseline value from table S6 in Stratton et al. [27] (87.5 gCO₂-eq/MJ) but slightly lower than those used by the ICAO (89 gCO₂-eq/MJ)⁴ or by the European Union (EU) via its RED II program (94 gCO₂-eq/MJ) [40, p26].

In 2019, global aviation emitted 1.07 GtCO₂ through kerosene combustion, which represented 2.6% of total anthropogenic CO₂ emissions, including emissions related to land use, which amounted to 41.64 GtCO₂ [41]. This share of 2.6% will be taken as a reference value when discussing the influence of traffic evolution and of global and aviation climate objectives in Section 8.1. Keeping the same reference year of 2019 but reducing the scope to commercial aviation and taking into account well-to-tank emissions, aviation CO₂ emissions represented 2.8% of total anthropogenic emissions. Now, if the focus is made on the cumulative historical impact from 1750, date commonly considered to be the start of the preindustrial era and taken as climate reference, CO₂ emissions from global aviation represented 1.4% of total anthropogenic emissions between 1750 and 2018, see Table 2. Here and elsewhere, values corresponding to historical emissions are computed by only considering emissions from the combustion because no historical data is available concerning well-to-tank emissions. In the long run, the share of aviation emissions, both when considering historical and annual emissions, has been increasing from 1940 as illustrated in Fig. 4, with a sudden drop in annual share in 2020 due to the COVID-19 crisis, but which is probably not significant for long-term trends. Moreover, the share of aviation in cumulative CO₂ emissions is lower than its current share which highlights the fact that aviation emissions have increased more rapidly than those of other sectors. It can also be explained by the fact that emissions from the aviation sector only began in 1940, year commonly taken as reference for estimating its climate impact. Over the period 1940–2018, emissions from the

⁴ EASA, Sustainable Aviation Fuels, accessed on March 10th 2023.

Table 2
Assessment of the climate impact of aviation for various scopes.

Period	CO ₂		ERF	
	Aviation CO ₂ emissions (GtCO ₂)	% of global CO ₂ emissions	Aviation ERF (mW m ⁻²)	% of global ERF
Global aviation, only combustion				
1750–2018	32.92	1.4%	100.9	3.8%
2000–2018	15.32	2.2%	44.2	4.8%
2018	1.05	2.4%	2.5	—
Commercial aviation, full life cycle				
2000–2018	16.49	2.4%	47.6	5.1%
2018	1.13	2.8%	4.2	—

aviation sector represented 1.8% of total emissions, which is effectively more than 1.4% over the period 1750–2018.

2.2.2. Evaluation of CO₂ and non-CO₂ effects

To estimate the climate impact of aviation by including both CO₂ and non-CO₂ effects, the results of Lee et al. [26] are used to evaluate this impact in terms of effective radiative forcing (ERF). The ERF, given in W m⁻², consists in evaluating the influence of a given climate forcer on the climate system by allowing adjustments for all variables except for the global mean surface temperature, the ocean temperature and the sea ice cover [43]. Introduced by the IPCC in its Fifth Assessment Report (AR5), it provides a better assessment of the climate impact of forcers that are heterogeneously distributed in space such as contrail-induced cirrus, compared to the measure of radiative forcing (RF) [26]. The RF is obtained when adjustments are allowed only for stratospheric temperatures [43].

Lee et al. [26] calculated that between 1750 and 2018, global aviation induced an ERF of 100.9 mW m⁻² [55–145].^{5,6} Fig. 5 details how this value is distributed between CO₂ effects and the five non-CO₂ effects mentioned in Section 2.1.2. It appears that non-CO₂ effects are preponderant and are responsible for two thirds of the ERF of aviation, *i.e.* 66.6 mW m⁻² [21–121], whereas CO₂ effects contribute for 34.3 mW m⁻² [28–40]. Contrails cirrus and NO_x are the predominant non-CO₂ effects and they respectively induced an ERF of 57.4 mW m⁻² [17–98] and 17.5 mW m⁻² [0.6–29]. Non-CO₂ effects are by nature varied and more difficult to evaluate than CO₂ effects. They are the main source of uncertainties for evaluating the climate impact of aviation, and the interactions between aerosols and clouds are not yet sufficiently well understood to be taken into account. These uncertainties are reported in Fig. 5 and are discussed in more detail, together with on-going research, in Section 2.4.

Using the recent anthropogenic radiative forcing value, estimated at 2.66 W m⁻² between 1750 and 2018 [4], the aviation has been responsible for 3.8% of global warming over the same period.⁷

Using the values of the anthropogenic ERF together with the values of aviation-induced ERF given by Lee et al. [26] for each year between 2000 and 2018, it is possible to plot the variation in the aviation's share of the total anthropogenic ERF given in Fig. 6. It exhibits a very different behavior from the corresponding curve for CO₂ emissions in Fig. 4. Whereas for CO₂ effects, past impact increases almost linearly over time, thus reflecting the cumulative nature of CO₂, the past impact

⁵ This range corresponds to the 90% confidence interval around the median value of 100.9 mW m⁻², indicating that the true figure lies in between 55 mW m⁻² and 145 mW m⁻² with a 90% probability.

⁶ As mentioned previously, values for historical impacts only consider CO₂ emissions due to kerosene combustion: because of lack of historical data, well-to-tank CO₂ emissions are not considered.

⁷ When Lee et al. made their estimations, the anthropogenic radiative forcing value was only known up to 2011. Over the period 1750–2011, they thus estimated that aviation had been responsible for 3.5% [3.4–4.0] of global warming.

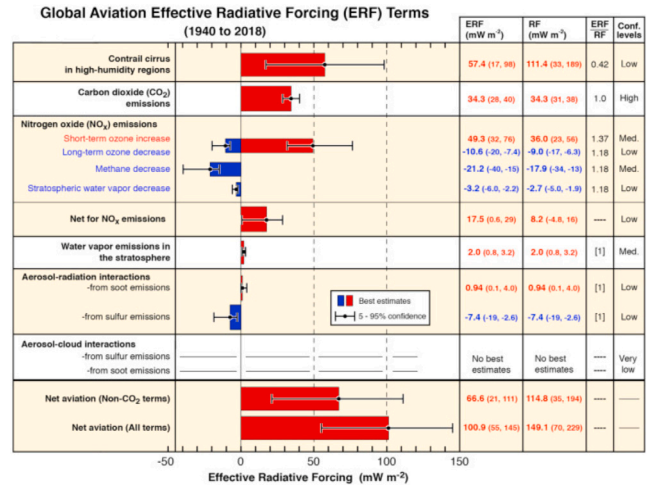

Fig. 5. Breakdown of radiative forcing terms due to global aviation from 1940 to 2018. The bars and whiskers show the best estimates for radiative forcing and 90% confidence intervals respectively. The red bars show the warming terms and the blue bars the cooling terms. According to figure 3 (and its caption) by Lee et al. [26].

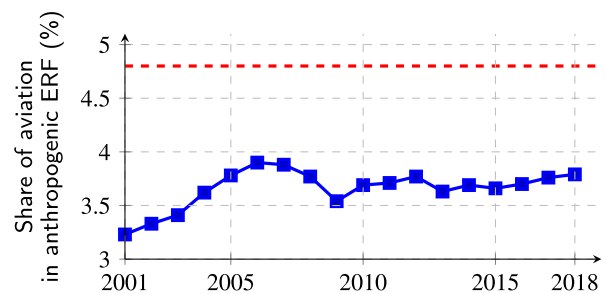

Fig. 6. The blue line represents for each year the share of aviation in ERF calculated since 1750. For instance, the value of the curve in 2010 corresponds to the ratio between the ERF due to aviation between 1750 and 2010, divided by global ERF over the same period. The dashed red line, situated at 4.8%, represents the share of ERF due to aviation over the period 2000–2018, which shows that the share of aviation in ERF increase is higher over recent rather than longer periods. Calculations based on data from Lee et al. [26] for ERF values from aviation, and from the IPCC Working Group I AR6 for anthropogenic ERF values [4].

aviation in terms of ERF has fluctuated since 2001. Even if no clear trend comes out over the period 2000–2018, it is nevertheless possible to calculate a mean share over this period where aviation represented 4.8% of the increase in ERF, a value higher than the 3.8% over the period 1750–2018. Finally, reducing the scope to commercial aviation and considering the full life-cycle, the share of ERF due to commercial aviation over the recent period 2000–2018 amounts to 5.1%.

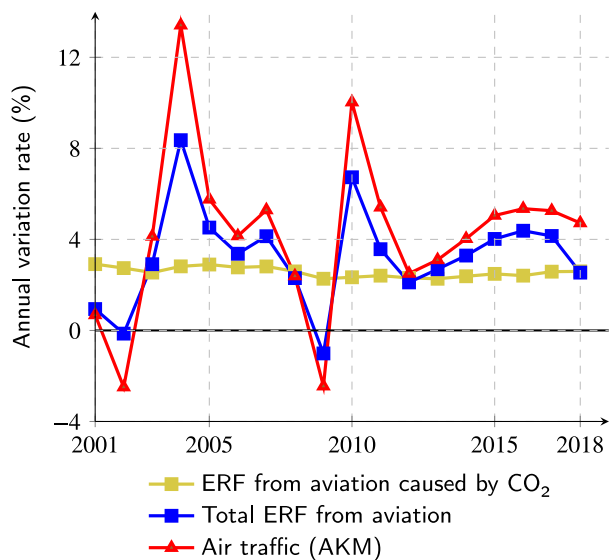

Fig. 7. The blue curve shows the annual variation rate in ERF from aviation, the yellow curve shows the annual variation rate in ERF from aviation due to CO₂ effects only, and the red curve shows the variation in traffic (measured in AKM) between 2001 and 2018. Calculations based on data from Lee et al. [26] (blue and yellow curves) and on data from ICAO (red curve).

2.3. Comparison of CO₂ and non-CO₂ effects

One fundamental difference between CO₂ effects and non-CO₂ effects stems from their different characteristic time scales. When part of the CO₂ emitted remains in the atmosphere for centuries [5,44], contrail cirrus persist for a few days at most [33,45] and aerosols remain in the atmosphere at most a year (and maximum one month if they are emitted in the troposphere) [46]. As a result, the impact of CO₂ effects is cumulative and over the long-term, whereas the impact of non-CO₂ effects is instantaneous and over the short-term. Therefore, the variation in the impact of non-CO₂ effects depends greatly on variation in traffic and their impact can change significantly over time, whereas, due to their cumulative and long-term nature, CO₂ effects are considerably less sensitive to short-term variations in traffic. This correlation between the change in impact of non-CO₂ effects with the evolution in traffic is illustrated in Fig. 7 which shows the evolution in annual variation rates in ERF from aviation and traffic (measured in aircraft-kilometers noted AKM). It underlines the very strong correlation between the variation in traffic and the variation in the total ERF from aviation which is dominated by the short-lived non-CO₂ effects. On the contrary, the annual variation rate of ERF due to CO₂ effects is very stable because of their cumulative effect. Over this period, the traffic decreased twice in 2002 and 2009 and aviation temporarily contributed to the decrease in ERF. Conversely, in 2004, traffic increased by 13% and the climate impact from aviation by 8%. In addition to the change in air traffic, specific strategies, described in detail in Section 6, could also enable a possible decrease of the ERF induced by these non-CO₂ effects.

2.4. Narrowing uncertainties

The uncertainties on ERF values shown in Fig. 5 are mainly due to non-CO₂ effects, especially the effect on radiative forcing from cirrus caused by contrails but also NO_x. Those associated to aerosol-cloud interactions are so large, with ERF values spanning a large range from -500 mW m⁻² to 300 mW m⁻², that these effects are not included in the assessment provided by Lee et al. [26] on which the previous discussion has been based. Here we complement this discussion and point to subsequent work to [26] which may affect some of its results, essentially by narrowing uncertainties.

2.4.1. Aerosol-cloud interactions

Regarding aerosol-cloud interaction, no best estimate was given by Lee et al. due to the wide range of values reported. Subsequently, Kärcher et al. [47] showed that extreme (positive and negative) values of the impact on RF of the aerosol-cloud interactions were probably overestimated. Even if they do not give a RF estimate, they conclude that the impact of aerosol-cloud interactions due to soot emissions is likely to be much lower than that due to contrail cirrus, and may even be insignificant. A similar conclusion is reached by Zhu et al. [48] by comparing the radiative properties of cirrus clouds during the travel restrictions due to the COVID-19 pandemic to the ones before it. When soot emission is reduced, they observe a significant increase in ice crystal number concentrations, which leads to a rather small positive radiative effect.

2.4.2. NO_x

Regarding NO_x, Grewe et al. [49] raise a methodological issue for estimating the impact of NO_x, and claim that assessments should take into account the non-linear aspect of the chemical system within which these emissions occur. According to them, not taking the non-linearity into account underestimates the impact of NO_x. Moreover, for the future, the effect of atmospheric background concentration could change the climate impact of NO_x emissions (see Section 6.1 for more details).

2.4.3. Contrails

The evaluation of the climate impact of contrails is very difficult because it requires an understanding of a wide range of complex phenomena such as the creation of contrail cirrus, their extent and life time, their optical properties and also other phenomena such as the interaction with natural clouds. The assessment provided by Lee et al. relies on numerical models because, until recently, limited data was available for direct measurements. However, the situation evolved significantly following the collapse of air traffic due to the COVID-19 pandemic. This event represented an unprecedented opportunity to validate the models against observation by comparing situations with and (almost) without aviation. Several research teams have tried to assess the difference in cirrus coverage and optical thickness during the almost complete shutdown of air traffic in the couple of months after March 2020 [50–54]. The results are contrasted: for instance, while Quaas et al. [53] detect a perceptible impact of air traffic reduction on cirrus coverage at the 20% Northern Hemisphere mid-latitudes with a measured reduction of $\sim 9 \pm 1.5\%$ on average, Digby et al. [50] conclude that no global response was detected through satellite observations of cirrus cloud following the strong traffic decrease during spring 2020.

A direct comparison of these papers is delicate because they consider different scopes and use different methodologies. Further research therefore seems necessary in order to reach a consensus. Concerning reassessment of contrail cirrus impact on ERF with this new data, Gettelman et al. [55] find an ERF median estimate of 62 mW m⁻² [3–121] in line with the estimate of Lee et al. but with a larger confidence interval. Similarly, Schumann et al. [56] find a net RF of 142.2 mW m⁻² which correspond to an ERF of 59.7 mW m⁻² if the ratio ERF/RF = 0.42 given by Lee et al. is used. However, the study by Quaas et al. [53] concludes with a best estimate of net RF of 62 mW m⁻² [22–100]. Still with a ratio ERF/RF = 0.42, this corresponds to an estimate of 25.6 mW m⁻² [9.2–42] in terms of ERF, which is two times lower than the estimate of Lee et al. Finally, although this is not the heart of Digby et al.’s paper [50], they also provide a back-of-the-envelope⁸ estimate of the ERF of contrail cirrus, and come up with a best estimate of 8 mW m⁻² [-3–22]. This result suggests that the climate impact of

⁸ The authors explicitly mention that their “results should not be treated as purely quantitative.”

Table 3

Summary of all terms involved in the Kaya equations (1) and (2): name and unit, description, associated levers for CO₂ mitigation and evolution over the period 1973–2019.

Term of Kaya equations	Name (unit)	Description	Lever	Evolution (1973–2019)
General Kaya equation (1)				
CO ₂	CO ₂ emissions (MtCO ₂)	Aviation CO ₂ emissions	All levers	+184%
$\frac{\text{CO}_2}{\text{E}}$	Carbon intensity (MtCO ₂ /EJ)	Quantity of CO ₂ released per unit of energy	Fuel	0%
$\frac{\text{E}}{\text{RPK}}$	Energy intensity (EJ/RPK)	Quantity of energy used for a passenger to travel one kilometer	Aircraft efficiency, operations, load, size	–80%
RPK	Traffic (RPK)	Global traffic	Demand-based mitigation	+1302%
Kaya equation for the energy intensity (2)				
$\frac{\text{E}}{\text{AKM}}$	Energy intensity (EJ/AKM)	Quantity of energy used for an aircraft to travel one kilometer	Aircraft efficiency, operations	–62%
$\frac{\text{E}}{\text{ASK}}$	Energy intensity (EJ/ASK)	Quantity of energy used for a seat to travel one kilometer	Aircraft efficiency, operations	–71%
$\frac{\text{ASK}}{\text{ASM}}$	Size (ASK/AKM)	Number of seats per aircraft	Size	+31%
$\frac{\text{RPK}}{\text{ASK}}$	Load (RPK/ASK)	Passenger load factor	Load	+43%

contrail cirrus could be much weaker than the best estimate of Lee et al. being 2 to 7 times smaller and corresponding to the lowest values of Lee et al.'s confidence interval. To conclude this discussion on the climate impact of contrails, it is interesting to mention the work of Wilhelm et al. [57] which shows that weather variability has a strong impact on contrails instantaneous radiative forcing, and concludes that “there is a fundamental limit to the precision with which the RF and ERF of contrail cirrus can be determined”.

3. CO₂ mitigation: Kaya decomposition adapted to aviation for identifying levers

As mentioned in Section 2, aviation has a dual contribution to climate change. Focusing on the CO₂ emissions of the aviation sector, the Kaya identity provides a useful conceptual tool to identify the different action levers for reducing CO₂ emissions. Originally introduced by the Japanese economist Yoichi Kaya in 1993 [58] to break down global CO₂ emissions in four different factors, several adaptations have been proposed in the literature [59–64]. An example used hereinafter is given by the following equation:

$$\text{CO}_2 = \frac{\text{CO}_2}{\text{E}} \times \frac{\text{E}}{\text{RPK}} \times \text{RPK} \quad (1)$$

where the three factors $\frac{\text{CO}_2}{\text{E}}$, $\frac{\text{E}}{\text{RPK}}$ and RPK detailed in Table 3 correspond respectively to the *fuel carbon intensity* which is the quantity of CO₂ released per unit of energy,⁹ the *aircraft energy intensity per RPK* which is the quantity of energy used for a passenger to travel one kilometer and the *traffic* which measures the distance traveled yearly by all passengers in Revenue Passenger Kilometer (RPK). This decomposition, and the levers identified in Table 3, may give the impression that one can consider the evolution of these terms independently but this is not necessarily the case. An important example is that of traffic, which somewhat correlates with many other terms. For instance, a decrease in air traffic can lead to a smaller fleet, for which it is easier to decarbonize the fuel (lower need for alternative fuels) or to improve the energy intensity (e.g. simpler air traffic management).

The historical change in CO₂ emissions from the aviation sector with respect to the Kaya identity (1) is given in Fig. 8 for the period 1973–2020. The constant carbon intensity reflects the fact that jet fuel burnt

⁹ In this decomposition, only the CO₂ emitted during combustion of kerosene is considered due to missing historical data on upstream emissions.

by aircraft engines has remained the same since 1973. Excluding year 2020 which stands as a singularity due to COVID-19 pandemic and is clearly visible in Fig. 8, energy intensity has decreased by 80% in 47 years which corresponds to an average improvement of 3.4% per year. As shown in Fig. 8, this decrease is not constant, annual gains ranging from 2.1% to 6.1% depending on the decade. These drops in consumption per RPK were obtained through technological improvements in terms of aerodynamics, propulsion, aircraft weight, aircraft systems and operations (including the increase of the load factor). This improvement in energy efficiency in the aviation sector is more than twice as high as the global average of 1.5% per year calculated for all business sectors over the period 1990–2018 [65]. Nevertheless, in the same lapse of time, the traffic increased a lot more rapidly, at an annual pace of 5.6%, increasing therefore from 618 billion RPK in 1973 to 8281 billion RPK in 2019. This eventually led to an increase in CO₂ emissions of 184% between 1973 and 2019. This phenomenon is a consequence of the rebound effect, highlighted from 1865 by the economist William Stanley Jevons [66]. This paradox stipulates that efficiency gains can lead to an overall increase in resources consumed instead of a decrease as one might expect, as a result of the increase in existing uses and/or the development of new uses made possible by improving efficiency and reducing costs.

It is possible to refine further the Kaya identity (1) by breaking down the energy intensity term as follows

$$\frac{\text{E}}{\text{RPK}} = \frac{\text{E}}{\text{ASK}} \times \frac{\text{ASK}}{\text{RPK}} = \frac{\text{E}}{\text{AKM}} \times \frac{\text{AKM}}{\text{ASK}} \times \frac{\text{ASK}}{\text{RPK}} \quad (2)$$

where four new levers described in Table 3 appear: the load factor $\frac{\text{RPK}}{\text{ASK}}$ (with ASK the Available Seat-Kilometers), the aircraft capacity $\frac{\text{ASK}}{\text{AKM}}$, the energy intensity $\frac{\text{E}}{\text{AKM}}$ for an aircraft to fly one kilometer and the energy intensity $\frac{\text{E}}{\text{ASK}}$ for a seat to travel one kilometer. The evolution of these different terms since 1973 is given in Fig. 9 which shows that the improvement in energy efficiency per passenger ensue from the evolution towards larger, more loaded and more efficient aircraft. Note that, except for the size, the trends are rather monotone. Moreover, we can see the difference in compound rates by decade between Figs. 8 and 9. Indeed, the compound rates for the energy intensity per ASK are smaller (in absolute values) than that for the energy intensity per RPK because the latter is also affected by improvement in the load factor RPK/ASK, which has increased by 43% between 1973 and 2019.

This Kaya identity highlights two technological factors for reducing CO₂ emissions from the aviation sector in addition to the evolution

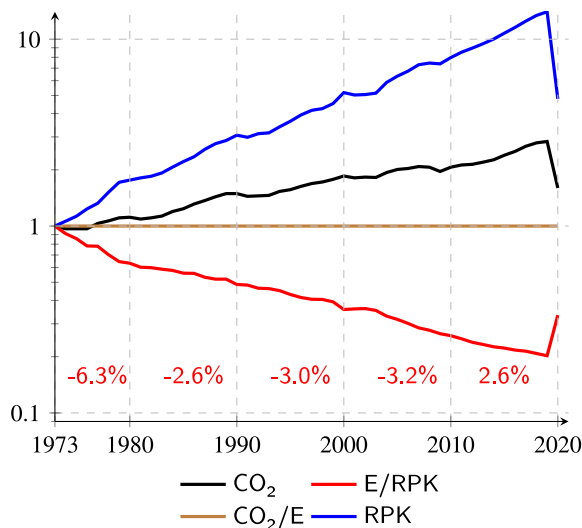

Fig. 8. Change in the terms of the Kaya identity (1) for aviation emissions between 1973 and 2020, normalized by their values in 1973. The energy intensity (E/RPK) annual variation compound rate is shown for each decade in red: a negative rate corresponds to a decrease in energy intensity, and thus an increase in energy efficiency. Calculations based on data from the IEA and the ICAO. The carbon intensity of the jet fuel is taken as $74.0 \text{ gCO}_2\text{-eq/MJ}$ [28].

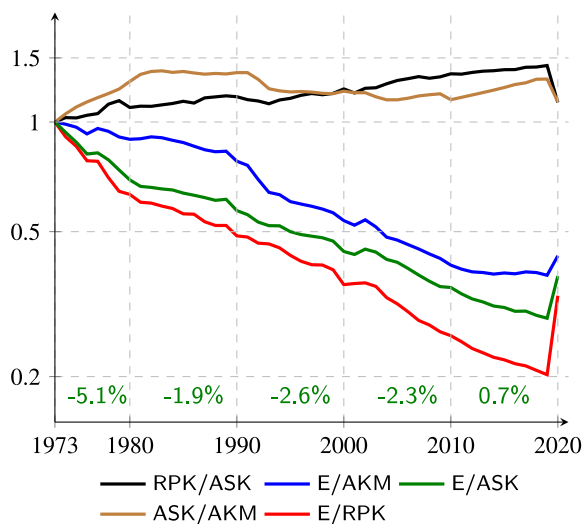

Fig. 9. Change in the terms of the Kaya identity (2) for energy intensity per passenger between 1973 and 2020, normalized by their values in 1973. The energy intensity (E/ASK, instead of E/RPK as in Fig. 8) annual variation compound rate is shown for each decade in green: a negative rate corresponds to a decrease in energy intensity, and thus an increase in energy efficiency. Calculations based on data from the IEA and the ICAO.

of the air traffic. On the one hand, the efficiency of the aircraft fleet can be improved by reducing the energy intensity $\frac{E}{\text{RPK}}$. These gains in efficiency can be split into different factors according to Eq. (2), showing for instance the importance of the term $\frac{E}{\text{ASK}}$ related to aircraft architectures and their operations. On the other hand, the reduction of CO_2 emissions can be achieved by decreasing the carbon intensity $\frac{\text{CO}_2}{E}$ of the energy used by the aircraft fleet. These two levers of action are studied in sections 4 and 5 respectively.

4. CO_2 mitigation: efficiency levers

As shown in Section 3, one lever for reducing CO_2 emissions consists in reducing the energy intensity of the aircraft fleet, in other words,

improving its efficiency. In this section, a focus is made on efficiency gains from aircraft technologies. However, efficiency gains from load factor and operation improvements are not reviewed in this paper, but the corresponding potential gains are discussed in Section 8.1. More specifically concerning operations, the reader may refer to the works of Alfonso et al. [67] which provide an overview of the key concepts for improving operations, such as flight scheduling, formation flight, trajectory optimization, continuous climb and descent operations, all-electric ground operations and synergies with airports.

This section on efficiency levers aims to provide a review of aircraft technology to build representative scenarios for estimating aircraft efficiency gains at the fleet level in Section 4.3. For this purpose, incremental technologies (Section 4.1) and disruptive technologies (Section 4.2) are considered separately because they will be mature at different time horizons and therefore will not contribute in the same manner to improving fleet energy efficiency by 2050. Indeed, new technologies can be characterized by their Entry-Into-Service (EIS) and/or Technology Readiness Level (TRL)¹⁰ to assess when they could potentially be deployed and produce an effect. Incremental technologies are reviewed and sorted with respect to the decade when their EIS can occur. For disruptive technologies their possible EIS is more uncertain, therefore emphasis is placed on retrieving possible intervals from the literature. Furthermore, the size and type of aircraft for which a given technology is underlined, when possible.

4.1. Incremental aircraft technologies

This part aims at identifying the incremental technologies for each of the typical disciplines of an aircraft: propulsion, aerodynamics, structure and systems.

4.1.1. Engines

Improving engine efficiency, which can be measured by the decrease in Specific Fuel Consumption (SFC), relies on gains in both thermal efficiency and propulsive efficiency, the product of which defines thermopropulsive efficiency. A gain in thermal efficiency depends on the efficiency improvement of the thermodynamic cycle via the components of the turbomachinery (compressor, combustion chamber and turbine). A gain in propulsive efficiency consists in decreasing the residual kinetic energy in the exhaust jet. The highest propulsive efficiency is reached when the difference between gas jet speed and flight speed is as small as possible. The objective is therefore to generate a high air flow rate with the minimum speed difference with respect to the aircraft speed, and this is the role the fan plays in turbofan engines. The efficiency of current engines, without significant disruptive technology, can still be improved, primarily by increasing the bypass ratio and the temperature at the combustion chamber outlet.

However, technological limits are being reached. For example, the materials used to make turbine blades are already highly complex (titanium alloys) but do not alone ensure blade resistance to extreme temperatures at the combustion chamber outlet (of around 1800 K to 2000 K), which exceed the metal alloy melting temperature [68]. It is therefore necessary to cool the first stages of the high-pressure turbine at the combustion chamber outlet with “cold” air from the compressor, a bleeding which reduces the efficiency of the engine [68]. It is thus impossible to significantly increase the temperature at the combustion chamber outlet yet, without affecting the performance of the thermodynamic cycle. In the same way, the increase in bypass ratio faces problems such as increasing the size and weight of the engine with respect to its integration on the aircraft.

Very high bypass ratio (VHBR) and ultra high bypass ratio (UHBR) engine designs are based on the increase in bypass ratio up to around

¹⁰ A TRL of 1 corresponds to the lowest level of readiness and a TRL of 9 to the highest.



Fig. 10. Open rotor presented at the 2017 International Paris Air Show by Safran, after [wikimedia commons](#).

20 (to be compared to a current bypass ratio of around 10 for the latest generation LEAP or Trent engines). An increase in bypass ratio not only increases propulsive efficiency but also reduces the noise emitted by the engine, by decreasing the exhaust gas jet speed. The expected gains are potentially around 5 to 10% on fuel consumption, while reducing the noise emitted by around 7 dB, compared to the current generation [69].

The increase in the bypass ratio enables turboprop engines to be particularly efficient. The (ducted) fan is replaced by an (open) propeller, which increases blade span, and thus ensures a very high bypass ratio. Therefore these engines can be used to reduce fuel consumption by around 40%. However, the propeller rotation speed, combined with the aircraft's forward speed, may induce the appearance of intense compressible effects (especially shock waves related to the presence of local supersonic regions), which significantly deteriorate performances as soon as the flight speed or the size of the aircraft are increased. These engines are therefore limited to flight Mach numbers of around 0.65, lower than those reached with a turbofan (of around 0.85), but also mainly used to power 100-seats short-haul aircraft due to thrust limitations. A solution to offset this disadvantage is to ensure thrust using two contra-rotating propellers, which enables them to reduce their rotation speed for a given level of thrust. These open rotor engine architectures are generally called Contra-Rotating Open Rotors (CROR) [70], see Fig. 10. This type of engines have a higher flight Mach number limit of around 0.75 and enables substantial fuel savings of around 10% to 20% compared to the best modern turbofans [71].

Although a lot more exploratory, improving the turbofan thermodynamic cycle remains possible, especially by replacing the isobaric combustion (Brayton cycle) by an isochoric combustion (Humphrey cycle) [72]. These engines, called pulsating detonation engines (PDE) or rotating detonation engines (RDE) exhibit better performances than those of isobaric engines, whether in terms of thermopropulsive efficiency or specific power. However, their operation in unsteady regime requires more research efforts, in order to adapt the components downstream of the combustion chamber (the turbine in particular) [73, 74]. Despite degraded functioning of a current turbine downstream of this type of combustion chamber, recent publications show thermal efficiency gains over the entire cycle of around 5% [75].

To conclude, future engine improvements mainly rely on larger dimensions (UHBR, CROR), which will further increase the coupling between the aircraft's aerodynamics, weight, and engine. It is therefore necessary, now more than ever, to more effectively integrate the propulsion system within the aircraft airframe which could represent another potential source of fuel savings. Bury et al. [76] show the

complexity of the flow in the case of a configuration where the engine is integrated under the wing, especially the presence of localized separations responsible for drag increase. Optimized aerodynamic design of the entire wing/engine integrated system is a crucial aspect for reducing fuel consumption. Integrating propulsion systems directly on the aircraft airframe and no longer under the wing is one of the disruptive technologies considered in the next ten years (see Section 4.2).

4.1.2. Aerodynamics

During cruise flight, in order to maintain airspeed (and therefore lift), engine thrust is used to compensate the drag component of the aerodynamic force exerted on the aircraft. The reduction in drag therefore influences directly the fuel consumption through the increase in lift-to-drag-ratio. However, drag gains remain difficult today because air flow around an aircraft remains complex and difficult to predict.

For current civil transport aircraft flying at compressible subsonic speed (around Mach 0.8), there are three drag components: skin friction drag, induced drag and parasite drag. Many gains have already been made in the past on aircraft aerodynamics (resulting in an improvement of the lift-to-drag-ratio): shape optimization, increase of the wing aspect ratio, improvement of control surface design, etc. Given the different drag components of an aircraft, there are increasingly fewer opportunities likely to lead to a significant improvement in aerodynamic performance. They are mainly based on the design of wings operating in laminar state for reducing skin friction drag, the increase in wing span and modification of wing tip shape for reducing induced drag and the integration optimization for various aircraft components and control surfaces to reduce parasite drag related to their functioning and interactions. The two first levers are detailed in the following.

Designing a wing operating with laminar flow, without changing the aircraft's speed, is a major scientific and technological challenge [77]. The advantage of a laminar regime is to reduce the dependency of wall friction on speed, by switching from a scaling of $F \sim V^5$ to $F \sim V^{\frac{1}{2}}$, which gives an increasing reduction in fuel consumption the higher the flight speed [78]. An order of magnitude calculation shows that, for a speed of around 250 m s^{-1} , skin friction drag can be reduced by around 80% in the laminar regime compared to the turbulent regime. Knowing that around 20% of the aircraft total drag is attributable to the skin friction drag of the wing, the advent of laminar-flow wings¹¹ would therefore enable to reduce drag during cruise by around 15% at best. A demonstrator has already been used to prove the technical feasibility of extending the laminar region up to 50% of the chord. The BLADE (Breakthrough Laminar Aircraft Demonstration in Europe) project especially demonstrated an overall reduction in drag of 8%, corresponding to a gain in fuel consumption of around 5%, by implementing this technology on an Airbus A340-300 [79]. However, this result could only be achieved for flight Mach number of 0.75, therefore slightly lower than the usual cruise flight Mach number of 0.82. A challenge inherent to the transition to laminar flow at a high Reynolds number also consists in being able to maintain this flow regime in all circumstances, including in the event of an impact and the deformation of the leading edge (even of only a few tens of millimeters) caused by insects swatted on the wing.

The induced drag, which is the other important component of the aircraft total drag, can be reduced by modifying the wing tip shape (spiroid winglet for example [80]), in order to achieve fuel consumption reductions of around 5% compared to configurations without winglet. An increase in wing span produces gains of the same order of magnitude [81], but induces more complex fluid/structure interactions, mainly due to wing increased flexibility [82]. Whereas wing tip shape can be modified on an existing aircraft (and therefore rapidly spread

¹¹ A laminar-flow wing is a wing for which the transition from laminar to turbulent flow is pushed towards the trailing edge. The natural transition occurs within the first few percent of the chord, close to the leading edge.

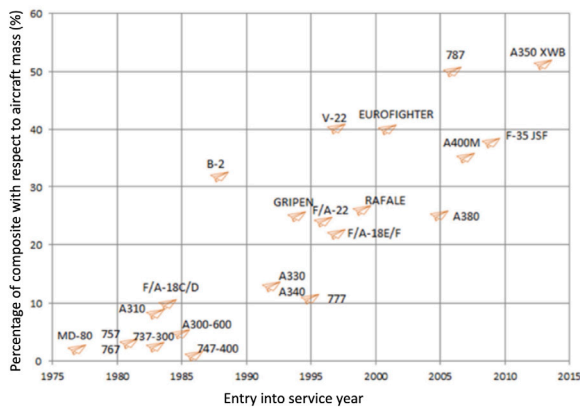

Fig. 11. Change in the use of composite materials in aviation: weight percentage according to the year of commissioning of the aircraft according to Montagne [83]. This figure contains both information on commercial and military aircraft.

out on a large scale), a change in wing span requires designing a new plane (and therefore delaying substantially its EIS and associated fuel consumption gains).

4.1.3. Lighter aircraft

Many technological developments aim to reduce aircraft weight, which allows to reduce the fuel consumption for a given mission. A significant contribution to a lighter structure involves replacing metal structures with composite materials. Aeronautical structures are built by assembling a large number of parts (typically several million parts for a long-haul airliner), connected together using mechanical fastening technologies (rivets, bolts, ...) and/or bonding technologies. To ensure reliability and durability, the preferred method is often the bolted or riveted assembly [83]. Composite materials exhibit a different behavior from metals, in terms of breaking modes, fatigue and tolerance to damage for example. Significant research into understanding and modeling the behavior of these materials is being undertaken to enable their more widespread deployment on aircraft. Fig. 11 shows that most recent long-haul airliners (e.g. Airbus A350) already have more than 50% of their mass composed of composite material compared to less than 30% for airliners commissioned in the early 2000s. Weight gains can further be made through new additive manufacturing processes mainly (3D-printing), which also means that fewer metal materials need to be used (nickel, titanium and aluminum). Pushed to its maximum potential, additive manufacturing can reduce fuel consumption by around 6% [84].

However, reducing aircraft weight can also enable the design of larger aircraft (therefore increasing the number of seats) or with increased range for a given quantity of fuel. Historically, it appears that aircraft size and weight have increased over the years, although the energy efficiency has also been improved. Indeed, despite the increasing trend in total aircraft weight, when normalized by the number of seats, it tends to decrease in a manner correlated with fuel consumption, as shown in Fig. 12.

4.1.4. Aircraft systems

The improvement in aircraft systems mainly involves their electrification [86]. It relies on two strategies illustrated in Fig. 13. The first one consists in replacing air power systems with electrical systems (bleed-less) enabling all at once, an increase in overall gas turbine efficiency, easier physical integration and streamlined maintenance. The second one covers hydraulic-less aircraft design aiming to replace fluid power systems with electrical systems.

To date, systems have only been partially electrified on the latest generation of commercial aircraft, due to electrical system applications

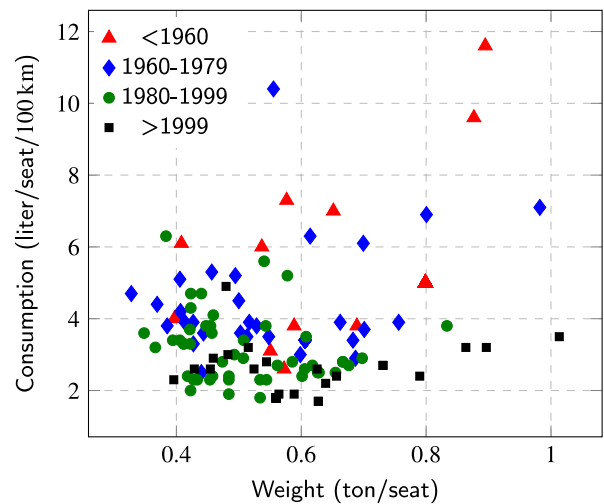

Fig. 12. Change in fuel consumption per seat for 100km according to aircraft weight per seat for different aircraft generations. The different shapes and colors correspond to different years of EIS.

Source: Graph compiled from data by Bejan et al. [85].

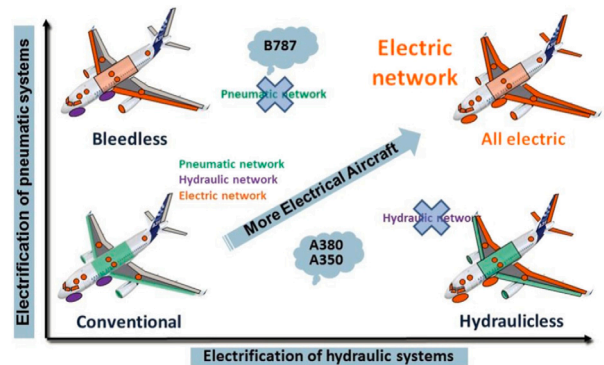

Fig. 13. The two strategies of the more electric aircraft according to Giraud et al. [87].

covering the entire range of TRLs. However, the direction taken by stakeholders is towards complete electrification with the concept of More Electric Aircraft (MEA). For large aircraft, in particular, the primary objective is to reduce total weight while making them easier to integrate and maintain.

As an example, replacing one of the fluid distribution networks with an electrical network on the Airbus A380 enabled a weight gain estimated at 500 kg [88]. This electrical network is used as a power source for specific flight control actuators and thrust reverser actuator system. In addition, replacing hydraulic systems would allow the elimination of hydraulic fluids (Skydrol). Nevertheless, the complete withdrawal of fluid equipment remains challenging due to their performance and ease of use for implementing certain essential functions. For example, damping must take place in the landing gear extension/retraction actuating system when a power failure occurs on its extension, in order to brake and dampen the impact at the end of travel (free-fall) [89]. This is done relatively easily in hydraulics by connecting a hydraulic resistance to both chambers of the cylinder. However, electromechanical technology involves creating passive viscous friction in the electric motor, which is more complex and is not yet implemented on aircraft in operation.

Similarly, to improve gas turbine efficiency, the bleed air system has been replaced by two electrically driven compressors on the Boeing 787 aircraft which has become the first commercial bleed-less aircraft [90]. This same aircraft also includes electrification of other systems such as engine-start and ice protection systems. The latter comprises electrical

resistance elements which generate heat under the surface of the wing's leading edge, which promises less energy consumption compared to other ice protection technologies which use hot air from the engine. These architectural choices lead to a significant increase in the aircraft's electric power onboard (1 MW on the Boeing 787) and, therefore, a significant increase of the mass of electrical power generation and distribution systems. Nevertheless, Boeing estimates a gain of around 3% over the aircraft overall consumption [90].

More general studies on system electrification, with an electrified aircraft for which only the propulsion is managed by combustion engines, estimates a weight reduction of around 10% and a reduction in consumption of around 9% [91,92].

Two other main advantages of electrification are the increase in the efficiency of the power transmission components and perhaps above all, a more efficient usage of the power. Consequently, an electrical system can provide almost just the right amount of power and energy required for the application. Furthermore, new electrical distribution system architectures are currently being studied such as modular cores in order to more effectively manage power fluctuations and distribution in the various systems during a flight. These directions towards a more electric aircraft have been studied in the European research programs MOET (More Open Electrical Technologies) and POA (Power Optimized Aircraft). The natural conclusion is that electrification is useful as it uses less engine power, on the condition that the associated potential increase in weight does not cancel out this gain.

Research work [93] began in the 2000s to remove the various barriers related to complete system electrification. The first research theme concerns the development of new system and equipment architectures and technologies in order to be operated with an electrical power source. For example, the development of reliable and lightweight electro-hydrostatic actuators (EHA) and electromechanical actuators (EMA) with very long service life are being investigated for different applications such as landing gear or flight controls [94]. Electrification of the ice protection system also provides consumption gains, like for example with the Boeing 787 anti-icing system, but gains could be increased further with electromechanical de-icing systems [95]. The second research theme concerns electric power distribution. It has been used since the early days of commercial aviation but the transition towards a more electric aircraft will imply a growing number of systems using electric power and, therefore an increase in the level of power the distribution system is expected to generate and distribute. This increase in power requires the development of reliable high-power components. For example, the wiring becomes a complex system, called the Electrical Wiring Interconnection System (EWIS), which is made up of wires, connectors, and contactors among others, and which requires a multiphysical and integrated approach to be designed. In order to maintain a reasonable electric current level, and therefore a reasonable component weight, it is suggested to increase network voltage between 500 V and 1000 V. But it increases the risk for electric arc and partial discharge phenomena, especially with the decrease in air pressure. The increase in the number of electrical and electronic components and power levels amplifies electromagnetic compatibility (EMC) issues. Lastly, the last research theme deals with the thermal management issues, which requires the development of low-loss and therefore high performance components, especially in terms of power electronics with wide gap components. Indeed, thermal management is a critical point in the electrification of aircraft because, unlike hydraulics or pneumatics, the losses are not transported and must be managed locally. One example is the use of air intakes to cool the relatively low-power electrohydrostatic actuators on the A380 and A350 [96]. It is also important to mention that the fuel system plays a crucial role today in the thermal management of the propulsion system as it provides a large quantity of fuel as a cold fluid source. As a consequence, switching to all-electric aircraft (see Section 5.3.3), and therefore removing fuel and substantially increasing electric power, is a significant challenge in terms of thermal management.



Fig. 14. View of the NASA N3-X blended-wing body concept [101].

4.2. Disruptive aircraft technologies

The improvements described previously enable to reduce the aircraft consumption but the gains appear to be limited for the conventional architectures. Disruptive innovations and technologies remain however possible to further improve aircraft efficiency.

This part identifies the disruptive technologies that could be envisioned in the longer term. Disruptive technologies mainly consist of radical changes in the shape, the architecture or the type of propulsion system of the aircraft. In this paper, they are categorized in two categories. First, radical changes in the shape and architecture are referred to as *Unconventional configurations*. Then, radical changes in the propulsion system are referred to as *Unconventional propulsive systems*.

4.2.1. Unconventional configurations

The exploration and evaluation of unconventional aircraft configurations is the subject of many research for most referenced in the following review papers [97,98]. The objective remains to evaluate potential gains regarding fuel consumption when compared to recent airliners. The following aims at providing examples of key unconventional aircraft concepts by radically changing aircraft shape, with an EIS between 2035 and 2050.

One of the most discussed solutions is to replace the standard tube-and-wing configurations, consisting of a fuselage, a wing and tails, with flying wings for example. Unlike the tube-and-wing configuration, in which the fuselage makes almost no contribution to lift while significantly contributing to the total drag, this type of configuration enables the lift generation via a single wing element, while substantially reducing the overall drag of the aircraft airframe. Different types of flying wings can be considered, such as Blended-Wing Body (BWB) which are often studied (Fig. 14). Finally, the flying wing architecture allows, for a given number of passengers, to reduce the aircraft take-off weight by around 15% and to increase its lift-to-drag-ratio by 20% [99]. Although it is a concept whose efficiency is still being studied, an improvement in the overall energy efficiency of around 25% compared to an aircraft from the current B777 type generation seems possible [100]. Moreover, it should be emphasized that this aircraft's shape offers greater flexibility for distributing fuel mass than conventional architectures. It could be particularly interesting in the case of hydrogen-powered aircraft which would require larger fuel tanks (see Section 5.3.2).

Nevertheless, other unconventional concepts closer to the conventional tube-and-wing configuration are also investigated. For example, the Strut-Braced Wing (SBW) configuration could offer significant benefits due to higher aspect ratio wings and thus lower induced drag. Ma et al. [102] estimate a benefit of around 23% due to aerodynamic and structural aspects compared to an Airbus A320 neo.

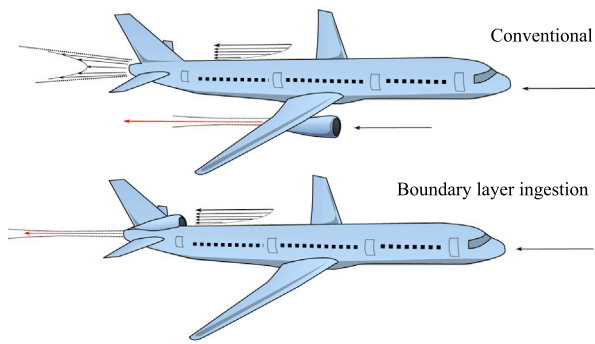

Fig. 15. Principle of engine integration with boundary layer ingestion compared to conventional integration under the wing according to figure 4.1 of Binder [104]. The propulsion system re-accelerates the fluid from the boundary layer, ideally up to the aircraft's flight speed, enabling a substantial gain both in propulsive efficiency and on drag.

4.2.2. Unconventional propulsive systems

Another category of disruptive technologies concerns unconventional propulsive systems. Two main directions can be identified for unconventional propulsion systems. The first one aims to work on innovative integration of the propulsion system within the airframe. The second one consists of the development of hybrid-electric architectures.

The first direction explores more efficient engine integration possibilities. Engines could be for example partially integrated into the central part of flying wings. This integration allows both to reduce overall drag (removal of most parasite drag and reduction in engine nacelle and aircraft wake drag) and also to improve the engine propulsive efficiency. Indeed, the engine inlet flow would have been slowed upstream due to the development of the boundary layer along the aircraft. This principle, called boundary layer ingestion (BLI), consists in producing thrust by accelerating fluid flow from a speed lower than the flight speed. The engine exhaust flow velocity would therefore have a lower residual kinetic energy than in the case of a conventional engine architecture placed under the wing, as illustrated in Fig. 15. BLI induces however strong distortion at the engine inlet which affects the performance of the thermodynamic cycle. Overall, the potential gain in fuel consumption reduction is estimated between 3% to 4% [103]. This type of engine integration is not determined by flying wing architectures and can also very well be implemented on standard tube-and-wing configurations.

The second disruptive technology is the hybrid-electric propulsion [105–108]. The two main advantages sought are better overall propulsion chain efficiency and improved energy management. It is thus possible to imagine a large number of architectures, a few examples of which are given in Fig. 16. In addition to these two main advantages, other possibilities are offered by hybridization.

First, switching to electric thrusters is also made possible by hybridization. It allows disruptive propulsion integration such as BLI and distributed propulsion to be also envisaged. Distributed propulsion can, like BLI discussed previously, improve aero-propulsive efficiency by blowing or suction effect according to the thruster's position. This concept is also used to implement control functions such as differential thrust (e.g. yaw control) and thus to reduce the size of the control surfaces (e.g. rudder) and therefore aircraft drag.

Second, another potential of hybridization lies in the potential to recover energy during the descent and braking phase, which is made possible through the use of electrical energy source and electric-powered thruster. Even if brake energy remains marginal compared to the energy used during the flight, the energy likely to be recovered during the descent could represent 4% to 15% of the potential recoverable gravity energy for a short-haul aircraft according to descent time and how much the propeller is used as generator [109]. However, this

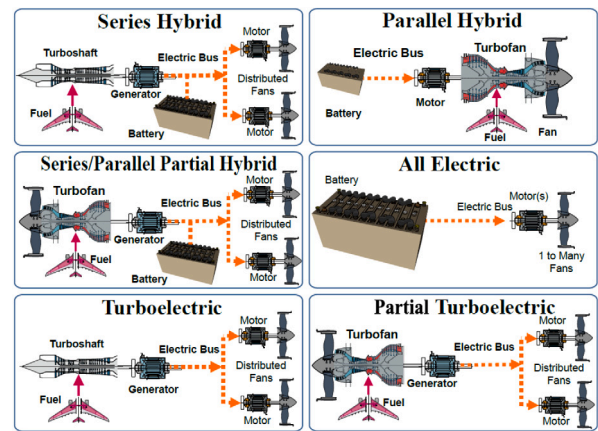

Fig. 16. Hybrid-electric propulsion architectures. [109]–[110].

energy recovered by using the propeller as generator during the descent phase is believed to be less useful overall compared to a propeller operating solely to compensate for its own drag. Indeed, the increase in the cruising range due to this operating mode renders the solution less attractive [109].

In any case, the power densities of the elements of the electrical system (engine, converters, cabling, etc.) are crucial for the viability of each of the solutions over the target range as they are likely to increase the aircraft's weight significantly. In the same way, low energy densities per unit of weight are barriers to the feasibility of these solutions. To illustrate the criticality of these parameters, the case of an all-electric aircraft (batteries), which will be discussed in detail in Section 5.3.3, can be used. For instance, Epstein [111] studied for an all-electric, 150-seat, single-aisle aircraft with power densities of 12 kW kg^{-1} for the electrical system components (to be compared with around 5 kW kg^{-1} for an electric engine in 2020). With this architecture, it is necessary to use batteries with energy densities of 1500 Wh kg^{-1} (to be compared with the 200 Wh kg^{-1} to 250 Wh kg^{-1} for a lithium-ion battery cell in 2020) in order to achieve a range of 1000 km. As a consequence, all-electric architectures could be limited to small aircraft due to electric component masses, but hybrid-electric architectures using fuel could be more relevant for aircraft with longer range.

In a nutshell, hybrid-electric propulsion associated to benefits from the other disciplines that it enables could lead to gains of around 30% but for missions limited to 1000 NM [97,112]. Nevertheless, it is essential to note that difficulties (e.g. thermal management) related to the increase in electric power on-board would be even more significant due to the fact that propulsion system power is almost 20 times greater than that of non-propulsive systems. This is why cryogenic propulsion systems and superconductive components [113] are also envisioned in the longer term.

4.2.3. Challenges of unconventional aircraft architectures

At this stage, significant technological barriers must still be removed to replace conventional architectures with new disruptive ones. It is indispensable to rethink aircraft design, which includes the certification process. Beyond the technological challenges, the advent of these new architectures, based on potential synergies between the various subsystems (airframe, engines and aircraft systems), also comes up against the current structure of the aeronautical industry where the clear segregation of skills (engine manufacturers, aircraft manufacturers, system manufacturers) is not compatible with a tightly coupled upstream design. These potential synergies underline the importance of developing multidisciplinary and integrated design methods and tools.

Table 4
Representative scenarios for future aircraft fleet for each category with maximum three generations of aircraft (1,2,3) until 2050.

Scenarios	Short range		Medium range		Long range	
	EIS	Gains [%]	EIS	Gains [%]	EIS	Gains [%]
Scenario 1	2035,2045,_	15,30,_	2035,2045,_	15,30,_	2035,2045,_	15,30,_
Scenario 2	2035,2045,_	20,35,_	2035,2045,_	20,35,_	2035,2045,_	20,35,_
Scenario 3	2030,2040,_	15,30,_	2030,2040,_	15,30,_	2030,2040,_	15,30,_
Scenario 4	2025,2035,_	15,30,_	2025,2035,_	15,30,_	2030,2040,_	15,30,_
Scenario 5	2030,2040,_	15,40,_	2030,2040,_	15,40,_	2030,2040,_	15,40,_
Scenario 6	2030,2037,2045	15,30,40	2030,2037,2045	15,30,40	2030,2037,2045	15,30,40

4.3. Aircraft efficiency gains at the fleet level

The main levers for improving aircraft efficiency have been detailed in the previous sections. This part aims at providing scenarios and global estimation for the evolution of aircraft efficiency gains at the fleet level. For this purpose, fleet-renewal-based scenarios are proposed to model the evolution of the mean fleet efficiency.

4.3.1. Representative scenarios for future aircraft fleet

The first step is to build representative scenarios for the future aircraft fleet which requires to obtain data on future aircraft efficiency gains and aircraft EIS. The data obtained in the previous sections are used. In particular, Bravo et al. [97] have provided a significant review of unconventional configurations with emphasis placed on the gains with respect to the models' level of fidelity to predict them. Some of the referenced unconventional configurations that are based on high-fidelity models are used, in terms of range, gains and EIS, to consolidate the latter fleet renewal scenarios. Moreover, the IATA aircraft technology roadmap [114] has also been used because it offers an interesting assessment of gains and EIS associated with each technology that is consistent with the previous aircraft technology literature review. Based on these different data, it has been chosen to consider that the next generation of aircraft integrating incremental technologies could yield gains of 15 to 20% (with respect to recent airliners) whereas for the following generation gains could reach 20 to 35%. Concerning unconventional configurations, it has been considered that disruptive technologies could lead to 40% gains. It has been chosen to vary the EIS of new aircraft as it is an important parameter for fleet renewal scenarios.

Six fleet renewal scenarios have therefore been proposed to assess sensitivities to the parameterization, and are summarized in Table 4. The fleet is decomposed into three main categories: short range, medium range and long range. Almost all scenarios except the last one consider an introduction of two generations of aircraft to enter into service between 2020 and 2050. In Scenario 1, moderate gains of respectively 15% and 30% for the two generations are considered. Their EIS is moderate also with respectively the year 2035 and 2045. In Scenario 2, higher gains for the two generations are considered compared to Scenario 1. In Scenario 3, earlier EIS for the two generations are considered compared to Scenario 1. Scenario 4 is an illustrative scenario where two generations of Short-Medium Range (SMR) turbofans are introduced very early compared to Scenario 1 in respectively 2025 and 2035 with moderate gains. This could have been possible if new a narrowbody program had been launched at the early 2020s. Scenario 5 is similar to Scenario 3 but the second generation of aircraft uses disruptive technologies and thus presents higher fuel efficiency gains. Scenario 6 is similar to Scenario 3 but a third generation of aircraft with disruptive technologies is introduced.

4.3.2. Simulation of the fleet renewal and results

Based on the previously defined scenarios, the evolution of the fleet efficiency gains are simulated. The simulation of the evolution of the aircraft fleet is based on the easily customizable fleet renewable models developed in [115]. The models have been calibrated based on the world fleet in 2020. The current aircraft in-service life is estimated

at 25 years, but an alternative reduced value of 20 years is also investigated. The reference recent aircraft for the short-range category has an energy consumption of 0.95 MJ/ASK where regional jets and regional turboprops have not been considered as they are marginal. For the medium-range and long-range categories, the energy consumption of the reference recent aircraft are respectively 0.70 MJ/ASK and 0.83 MJ/ASK.

An example of the evolution of the aircraft shares and mean fleet energy consumption is given for each category in Fig. 17 for Scenario 4 with an aircraft in-service life of 25 years. One can see that this scenario enables, for example, to reduce the mean energy consumption of the short-range fleet from 1.09 MJ/ASK in 2020 to 0.71 MJ/ASK in 2050.

The results obtained for the different representative scenarios and renewal characteristics are summarized in Table 5. From these results and the specificity of each corresponding scenario, multiple observations can be made. First, one can see that an earlier EIS of 5 years in Scenario 3 produces more effect than increasing efficiency gains of aircraft by 5%. In addition, Scenario 4 shows that if a new program was launched in this decade, here in the year 2025, it would have a significant effect on the fleet efficiency. This scenario enables to reach an annual gain rate of 1.4% (25-year in-service life) and 1.6% (20-year in-service life). Similarly, the Scenario 5 that introduces unconventional architectures in 2040 yields significant annual gain rates of 1.4% and 1.6%. Also, deploying a third generation of aircraft before 2050 marginally increases the gains. Finally, accelerating fleet renewal by changing the in-service life of an aircraft from 25 to 20 years enables increased gains from 8% (Scenario 4) to 14% (Scenario 5). Overall, the proposed scenarios enable to improve aircraft fleet efficiency of 25.9 to 35.1% between 2020 and 2050. If fleet renewal is accelerated, the improvements can reach 28.7 to 39.0% which corresponds to annual gain rates between 1.0 to 1.6%. However, it would be interesting to estimate cumulative gains and not only annual gains because it is the cumulative CO₂ emissions, and therefore the cumulative amount of energy consumed, that are important to consider as explained in Section 1. Nevertheless, this raises the question of how to compare cumulative gains knowing that the traffic evolution has also an influence.

5. CO₂ mitigation: fuel decarbonization levers

5.1. General consideration

As explained in Section 3 when discussing Kaya identity, replacing the current kerosene from fossil origin by Alternative Energy Carriers (AEC) with a lower content in fossil carbon is the main lever for the aviation sector to diminish its CO₂ emissions. Table 6 presents the five main AEC currently envisaged for the aviation sector: electrofuels, biofuels, PBL (which stands for Power- and Biomass-to-Liquids), electric batteries and hydrogen.

This table also presents the main primary energy source from which each AEC is produced. There is a wide variety of hydrogen production methods, but we focus here on hydrogen produced by water electrolysis, as it is the potentially low-carbon production method which is most mature today [116–119]. Another significant low-carbon production pathway currently considered is to use current methods (such as steam methane reforming and coal gasification) coupled with Carbon Capture

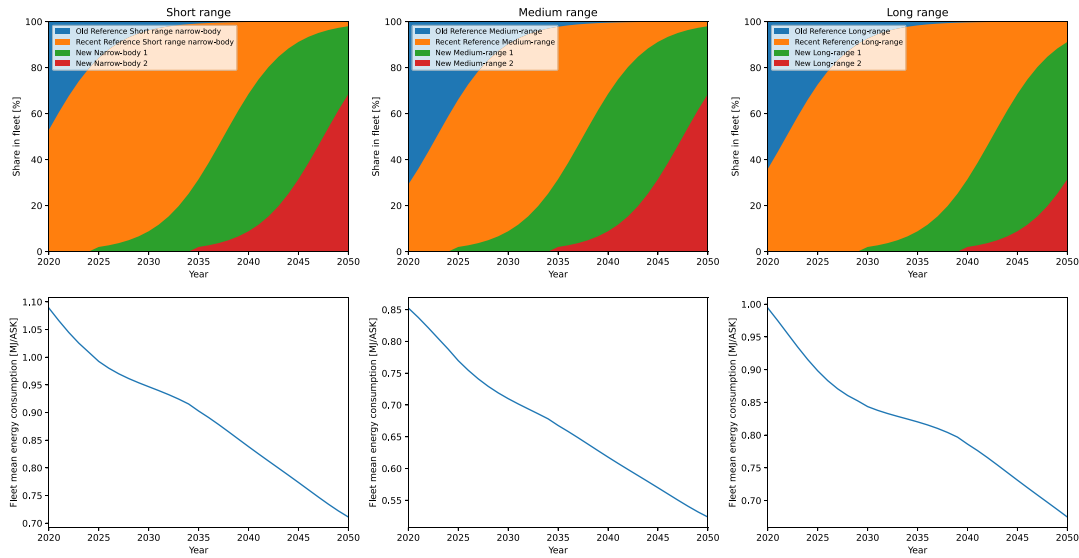

Fig. 17. Visualization of Scenario 4 fleet renewal.

Table 5
Resulting energy efficiency gains with two fleet renewal rates for the different representative scenarios.

Scenarios	Results for 25-year fleet renewal			Results for 20-year fleet renewal		
	Gains in 2035	Gains in 2050	Equivalent annual gain (2050)	Gains in 2035	Gains in 2050	Equivalent annual gain (2050)
Scenario 1	15.9%	25.9%	1.0%	16.2%	28.7%	1.1%
Scenario 2	16.0%	28.7%	1.1%	16.3%	32.3%	1.3%
Scenario 3	16.8%	31.5%	1.3%	17.8%	34.7%	1.4%
Scenario 4	18.7%	34.9%	1.4%	20.6%	37.7%	1.6%
Scenario 5	16.8%	34.1%	1.4%	17.5%	38.9%	1.6%
Scenario 6	16.8%	35.1%	1.4%	17.5%	39.0%	1.6%

Table 6
Table summarizing the five main alternative energy carriers envisioned for aviation. For each AEC, the main energy source (sometimes referred to as primary energy) and the main source of CO₂ emissions are mentioned; the distinction is made between drop-in AEC, which are carbon-based, and non-drop-in AEC which are carbon-free; finally, the CO₂ credit of carbon-based AEC is indicated.

Energy carrier	Main energy source	Main source of CO ₂ emissions	Drop-in/Carbon-based	CO ₂ credit
Biofuel	Biomass	Feedstock to fuel processing, land use change	yes	Biomass growth
Power- and Biomass-to-Liquid	Biomass & electricity	Feedstock to fuel processing, land use change, electricity production	yes	Biomass growth
Electrofuel	Electricity	Electricity production	yes	CO ₂ capture
Electric batteries	Electricity	Electricity production	no	—
Hydrogen	Electricity	Electricity production	no	—

and Storage (CCS) technologies [120], but this is outside the scope of this review. For biofuels, we have only mentioned biomass, but some production pathways also need hydrogen [121]. When the latter is produced from electrolysis, the biofuel production pathway then also relies on electricity, although this is not indicated in Table 6. The influence of hydrogen on biofuel production will not be discussed here, more details can be found in [121,122].

The notion of energy carrier is central here: in contrast with fossil kerosene that (up to crude oil refining) is almost readily available as such, the conversion pathways envisaged to produce AEC for the aviation sector involve major transformations. For many envisioned pathways, significant CO₂ emissions could occur during the production of the energy carrier. For instance, an hypothetical all-electric aircraft embarking all its energy in electric batteries would be completely emission free during its flight (no CO₂ emissions, but also no water, sulfur, etc.), but significant CO₂ emissions could occur during the production of electricity stored in the battery. Indeed, electricity is

currently mostly produced from fossil energy, with more than 60% of electricity produced from natural gas, oil and coal in the world [123]. In particular, it is mandatory to include emissions from the AEC production in the scope of emissions considered and not to restrict the focus to in-flight emissions. For this reason, tools from Life Cycle Assessment (LCA) need to be used.

Electrofuels, biofuels and PBTl are drop-in fuels, meaning that they can be directly embarked in current aircraft (with some possible limitations, see discussion below), whereas powering an aircraft with electric batteries or hydrogen requires designing a new one. The goal of this section is to give insight into the potential climate benefits of these new energy carriers: for this reason, we will consider them in isolation, e.g., consider an all-electric aircraft or a cryoplane powered only by hydrogen.

Because of their importance, a large amount of literature has already been devoted to assess the potential climate benefits of these alternative energy carriers. In this section, we focus on high-level considerations

Table 7
FRL and TRL values from [127, table 3]; highlights from [128, Table 1].

Drop-in AEC		TRL	FRL	Highlights
Biofuel	HEFA	9	9	• Commercial passenger jet flight test with 100% HEFA fuel
	FT	6–8	6–7	• Establishment of the first commercial Fischer–Tropsch BtL plant in the UK (Velocys)
	ATJ	6–8	7–8	• First commercial flight with ATJ fuel • British Airways will purchase SAF from LanzaJet's US plant from late 2022 • Oneworld Alliance members will utilize Gevo's SAF for operations in California from 2027, for a five year-term.
	DSHC/SIP	7–9	5–8	• Commercial flight with 10% farnesane blend from Amyris/Total (2014)
electrofuel		5–8	–	• World's first 110kt/year recycled carbon methanol production plant • 'Green Fuels Hamburg'

to understand the potential of these AEC to lower CO₂ emissions from the aviation sector. Our goal is to introduce the key parameters that need to be taken into account in designing transition scenarios. For more precise technical details, the reader is for instance referred to the two recent thorough surveys [124,125] that provide an in-depth presentation of the four main AEC mentioned above. For each AEC we also point to more specific references below.

Note finally that in this section, we focus on CO₂ effects. However, these new energy carriers are also expected to hold benefits concerning non-CO₂ effects, in particular contrails: these potential benefits are discussed in Section 6.

5.2. Drop-in AEC

5.2.1. General consideration

Kerosene is a hydrocarbon chain made of carbon and hydrogen. Drop-in AEC, sometimes referred to as alternative drop-in fuels or alternative jet fuels, are kerosene whose carbon comes from the atmosphere rather than from fossil origin. For biofuels and PBTl, this atmospheric carbon has been captured by the biomass, whereas for electrofuels, it is directly captured from the atmosphere. Thus, when these fuels are burned, the CO₂ they add into the atmosphere ultimately came from the atmosphere where it returns. These drop-in AEC are sometimes referred to as Sustainable Aviation Fuel (SAF), although the terminology of SAF is used differently depending on regulatory context, feedstock basis, and production technology, see for instance [126, chapter 4] for a discussion on the definition of SAF. In the present paper, the term SAF will be used only when discussing a paper where this terminology is used and its precise meaning will be that of the original source.

In order to be embarked in an aircraft, a fuel needs to comply with the ASTM D4054 reference. As of March 2023, nine conversion processes from various feedstock to fuel satisfying this reference have been approved by the ASTM International.¹² Two of them, defined in the reference ASTM D1655, have to be co-processed with petroleum, while the seven others, defined in the reference ASTM D7566, can be produced from biomass, algae or oil. Currently, these fuels need to be blended with conventional jet fuel. In particular, the reference ASTM D7566 defines a maximum blending ratio for each fuel produced by these pathways: for the HC-HEFA-SPK and SIP pathways (produced from algae and biomass used for sugar production, respectively), the maximum blending ratio is 10%, while for the other five pathways, it is 50%. In October 2021, an Airbus A319neo aircraft operated on 100% HEFA biofuel,¹³ which suggests that the limitation on the blending ratio is likely to evolve in the future. Note also that drop-in AEC are at varying stage of technological maturity, as can be seen on Table 7 for biofuels and electrofuels.

¹² See the [webpage dedicated to the conversion processes](#) of the ICAO Global Framework for Aviation Alternative Fuels, accessed on 20th, March 2023

¹³ [First A319neo flight with 100% sustainable aviation fuel](#), accessed on April 14th, 2023.

The Kaya identity (1), introduced to decompose past emissions of the aviation sector, is still useful to assess future emissions due to drop-in fuels. Since these drop-in fuels can, by definition, be embarked on conventional aircraft, only the emission factor term $\frac{CO_2}{E}$ needs to be considered. Typical values for this factor for alternative drop-in fuel are summarized in Table 8. The goal of this section is to explain these values as well as the main sources of variability and uncertainty.

As mentioned in Table 6, alternative drop-in fuels are those AEC that are carbon-based: indeed, the two other AEC (electric batteries and hydrogen) are carbon-free. In particular, the use of alternative drop-in fuels during the flight still emits CO₂ in the atmosphere, in contrast to carbon-free AEC which do not emit CO₂ during the flight. Although the combustion emission factor is around 4% lower for alternative drop-in fuels than for fossil kerosene,¹⁴ the potential climate benefits actually come from the fact that carbon has been previously captured from the atmosphere. As indicated in Table 6, for electrofuels this CO₂ credit would come from CO₂ capture, the latter being either directly captured from the atmosphere (DAC for Direct Air Capture) or collected from point sources of industrial processes producing CO₂ through fermentation, calcination and most notably combustion of fossil fuels [134]. For biofuels and PBTl, the CO₂ credit would come from the growth of the biomass. If understanding these benefits is relatively straightforward for electrofuels, this is different for biofuels and the assessment of their potential climate benefits is quite delicate as discussed below in Section 5.2.2.

5.2.2. Biofuels

Assessing CO₂ emissions from biofuels is a delicate issue: the primary objective of this section is to explain the main assumptions and the main factors of variability and uncertainty that underlie estimations of biofuel CO₂ emissions. Also, biofuels belong to the wider category of biomass-based technologies such as BECCS (Biomass Energy with Carbon Capture and Storage) which, because they rely on land management which involves water and land use, have far-reaching consequences beyond CO₂. Here we focus on CO₂ emissions, but more general considerations can for instance be found in [135–139], see also the IPCC special report on climate change and land [140].

There is a wide variety of conversion pathways to produce jet fuel from biomass, which are for instance described in details in [142–144]. In Fig. 18, six pathways are represented which allow to process feedstock grouped in three families: oil-containing biomass and readily available oil, (ligno)cellulosic biomass and sugar and starch biomass. Currently, three pathways are considered most promising [128]: the HEFA (Hydroprocessed Esters and Fatty Acids) pathway to process oil-based feedstock, the FT (Fischer–Tropsch) pathway to process cellulosic feedstock and the ATJ (Alcohol-To-Jet) pathway to process sugar and starch biomass. The evaluation of the emission factor of each pathway is decomposed into two terms: the core LCA accounts for well-to-wake

¹⁴ For electrofuels and biofuels, the combustion emission factor is around 70 gCO₂-eq/MJ [132,133], while it around 74 gCO₂-eq/MJ for fossil kerosene [28].

Table 8

For each alternative drop-in fuel, the range of full LCA emission factor is given. Variability arises from methodological choices and differences in pathways, and for biomass-based fuels, an intrinsic uncertainty is related to the estimation of land-use change emissions. The wide range of emission factor values for electrofuel and PBtL is explained by the influence of the electricity mix.

Alternative drop-in fuel	Full LCA emission factor (gCO ₂ -eq/MJ _{fuel})	Main source of variability	Main source of uncertainty	Ref
Biofuel	-30–100	Feedstock, conversion pathway	Land use change emissions	[129]
Electrofuel	3–300	Electricity production emission factor	—	[130,131]
PBtL	4–187	Feedstock, conversion pathway, electricity production emission factor	Land use change emissions	[130]

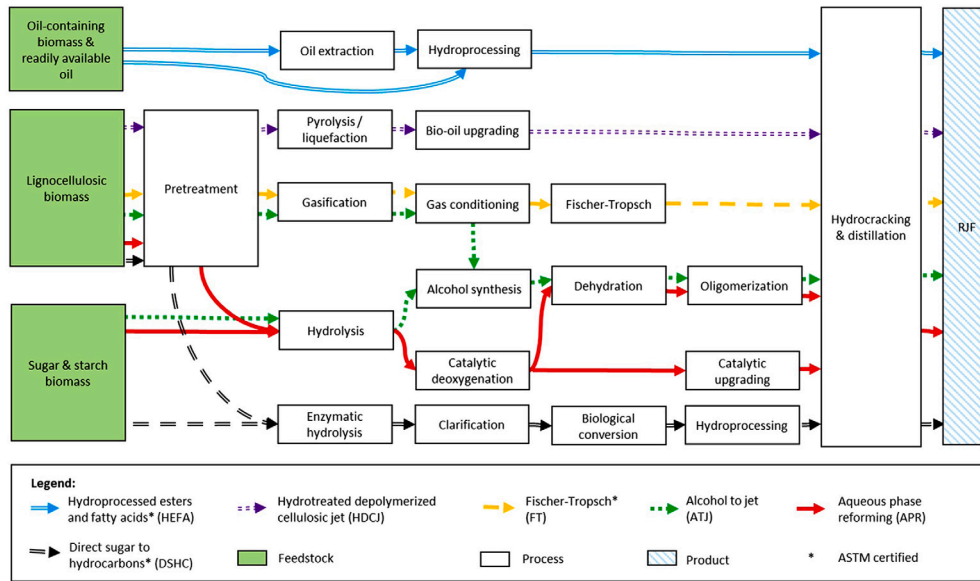

Fig. 18. Description of the main biofuel production pathways. Three types of feedstock are distinguished depending whether they are mainly based on lipid, carbohydrate or cellulose, which is an important factor determining full LCA emissions.

Source: From Figure 1 in [141].

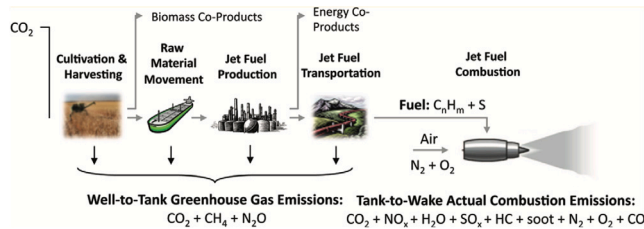

Fig. 19. System boundary of biofuel core LCA.

Source: From [27].

CO₂ emissions, and LUC emissions account for emissions due to land use change. As will be explained below, LUC emissions need to be taken into account in order for the assumption of combustion neutrality to be valid; moreover, the estimation of these emissions is intrinsically uncertain. We first present results for core LCA and corresponding allocation methods, then discuss the assumption of combustion neutrality, which leads to a discussion on LUC emissions. Finally, full LCA results, combining core LCA and LUC emissions, are presented.

Biofuels core LCA. The system boundary of core LCA, described above, is depicted on Fig. 19. It accounts for emissions that occur during the cultivation of the biomass, the transport of the feedstock and the fuel, the conversion of the feedstock to fuel, and the combustion of the fuel. Within this system boundary, the weighted-average emission factor of fossil kerosene is 88.7gCO₂-eq/MJ, which is therefore the benchmark against which to compare potential benefits [28].

For biofuels, different production pathways can have very different core LCA results. Typical values for the HEFA and FT pathways [132]

Table 9

Illustrative core LCA results for the HEFA and FT pathways, without the assumption of carbon-neutral combustion.

Source: Values taken from [132], Table 51 for HEFA and Table 35 for FT.

Emission factor (gCO ₂ -eq/MJ) by stage	HEFA	FT
Biomass growth	-70.5	-222.7
Cultivation and transportation	21.9	7.5
Conversion	10.3	152.1
Combustion	70.4	70.4
Total	32.1	7.3

are for instance provided in Table 9, see also [122,145] for other core LCA results.

From this table we see that the climate benefit depends on the production pathway. Moreover, we see that different pathways have different carbon flows: although for HEFA, the CO₂ credit corresponds to the amount of CO₂ released during the combustion, for FT the CO₂ credit is much larger than the amount of CO₂ released during the combustion, and a significant amount of CO₂ is also released during the conversion from feedstock to fuel. In principle, it is also possible to capture this carbon, in which case CO₂ emissions can become negative. The possibility to couple biofuel production with CCS technologies is discussed in [146–150]. Moreover, PBtL (discussed in Section 5.2.4 below) aim to alleviate this high carbon loss that occurs during the FT process.

LCA allocation method and selectivity. Most biofuel conversion pathways produce hydrocarbon chains of varying lengths, see for instance

Table 10

List of co-products and selectivity range for the three main biofuel production pathways. The list of co-products is from [124, Table 1]; the range of selectivity values derives from data from [151–154] for FT (using the selectivity for diesel when the one for jet fuel was not available), from [132,155–157] for HEFA and from [158] for ATJ.

Production pathway	Co-products	Selectivity range
FT	Propane, Naphtha, Diesel, Gasoline, Waxes	15%–50%
HEFA	Propane, Naphtha, Diesel	15%–74%
ATJ	Isobutene, Isooctane, High-protein animal feed	15%–100%

Table 11

Variation in core LCA results depending on the allocation method. Two allocation methods are considered: the energy allocation (column E) and the displacement allocation (column D), where the emission factors expressed in $\text{gCO}_2\text{-eq/MJ}_{\text{fuel}}$ are indicated. The column variation is obtained as the ratio D/E-1.

Source: From Figure 3 in [122].

Process	Feedstock	E	D	Variation
HEFA	Used Cooking Oil	27	27	0%
	Jatropha	55	22	-60%
	Camelina	47	44	-6%
FT	Willow	9	0	-100%
	Poplar	9	0	-100%
	Corn stover	13	4	-69%
	Forest residues	6	-3	-150%
ATJ	Corn	55	71	+29%
	Corn stover	35	22	-37%
	Sugar cane	26	22	-15%

Table 10 for the HEFA, FT and ATJ pathways; other co-products can exist, and some pathways, such as the FT or the Direct Sugars to Hydrocarbons (DSHC) pathways, are even net producers of electricity [122]. In such cases, the CO_2 emissions of the production pathway need to be allocated between these different co-products. Standard LCA allocation methods are based on the energy, mass or economic value of the inputs and co-products. The energy allocation is particularly well-suited for energy products such as biomass and fuel. However, non-energy co-products can arise in some biofuel pathways, for instance camelina meal in the HEFA pathway from camelina [122]. In this case, an alternative possible allocation method is the displacement method, which awards an emission credit to co-products based on the yield of the co-product and the GHG emission intensity of the displaced product [122]. Table 11 shows the influence of the chosen allocation method (by energy or by displacement) for various pathways.

Selectivity is an important parameter of a given production pathway: it refers to the proportion of kerosene in the fuel output. Here proportion is usually measured by energy, but it can also be measured by mass. Selectivity depends on the production pathway and can, to some extent, be tuned. Stratton et al. [132] mention for instance that “a F-T plant configured to produce 70% diesel and 30% naphtha should theoretically be able to undergo modifications such that it could yield 60% jet fuel and 40% naphtha”, which is the reason why selectivity values for diesel was used as a proxy for the selectivity value of jet fuel in Table 10. Ranges of typical selectivity values for HEFA, FT and ATJ are given in Table 10. If selectivity is measured along the same unit than the allocation method, then the value of selectivity does not affect the final result. For instance, if one is interested in the emission factor of some biofuel produced by some pathway and the energy allocation method is chosen, then the value of the selectivity, if it is expressed in energy ratio, does not affect the result. However, selectivity is an important factor when considering energy efficiency issues, as will be discussed below for the case of electrofuels: indeed,

it allows to estimate the total amount of primary energy necessary to produce a given amount of alternative jet fuel. Note also that tuning selectivity rests on economic consideration, as hydrocarbons with a higher economic value will tend to be favored.

Assumption of carbon-neutral combustion. Many LCA studies assume that the combustion of biofuel is carbon neutral, the rationale being that the CO_2 emitted during the combustion was already captured from the atmosphere. This is a useful accounting convention, but it may have two drawbacks.

First, it may give the wrong impression that there was as much CO_2 captured from the atmosphere during the biomass growth than what was released during the biofuel combustion. However, as mentioned previously in the case of FT biofuels, this is not necessarily so. In the case of FT biofuels, what could be considered as neutral is the whole balance of CO_2 captured during the biomass growth, which indeed goes back to the atmosphere. However, this CO_2 captured during the biomass growth goes back to the atmosphere either during the fuel combustion, or during the conversion process.¹⁵

The second potential problem is that for this assumption to be justified, a careful carbon accounting needs to be performed. In particular the system boundary of the core LCA, depicted in Fig. 19, needs to be extended in order to include land-use change emissions. If not, there is a risk of significant carbon accounting error. This risk was widely discussed in the scientific literature [159–162], by the scientific councils of European [163] and American environment agencies [164] and by the IPCC [165]. Creutzig et al. [136] explain that “The neutrality perception is linked to a misunderstanding of the guidelines for GHG inventories [...]. Carbon neutrality is valid if the countries account for LUC in their inventories for self-produced bioenergy”.

In fact, the neutrality of an emission can only be justified by comparing the net carbon flow in two cases. One case with emission and one case without emission. This alternative scenario is called a *counterfactual* scenario.¹⁶ Neutrality is therefore justified if the net CO_2 emissions balance is the same in both cases. Therefore, as biofuel combustion emits CO_2 into the atmosphere which would not otherwise have been emitted in the absence of the said biofuel, this emission has to be offset by additional absorption, *i.e.* which would not have been present without the biofuel. It is the meaning of the word *increased* in the following citation from the IPCC [165, p 877]: “if bioenergy production is to generate a net reduction in emissions, it must do so by offsetting those emissions through increased net carbon uptake of biota and soils”. For example, considering a situation without biofuel in which the biomass is produced at a given location (counterfactual scenario), and then, all other things being equal, this biomass is used to produce biofuel, then the neutrality hypothesis is not justified since an emission flow has been added without creating additional absorption [161].

The previous citation by the IPCC clearly shows that considering the combustion neutrality hypothesis does in fact rely on an offset principle. An emission at a given time and place is offset by equivalent absorption, possibly in another place and at another time. However, since additionality is based by definition on a scenario which will not take place (the counterfactual scenario), it is impossible to guarantee it and only its likelihood can be estimated. Yet this problem tends to be underestimated. For instance, a study on offset projects from the *Clean Development Mechanism* by the UN showed that 85% of the planned projects had a low probability of being additional [166].

For combustion to be considered as neutral, it is therefore necessary for the biofuel life cycle to be analyzed according to a rigorous and exhaustive method. As illustrated by the example of additionality

¹⁵ As mentioned above, this CO_2 could in principle be captured and stored instead of being released in the atmosphere.

¹⁶ There is in fact a subjective choice to be made about it, for example, a trend-based counterfactual scenario or a counterfactual scenario considering other possible futures.

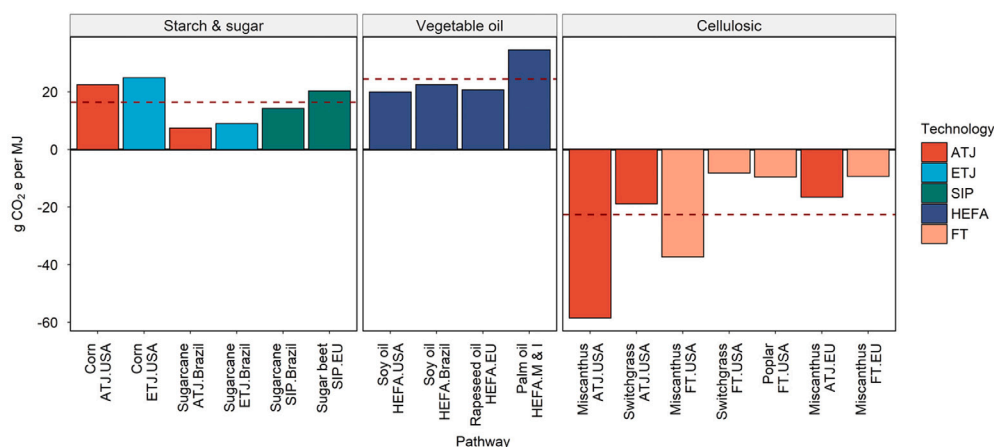

Fig. 20. Estimation of LUC emissions for various biofuel pathways.
Source: From Figure 2 in [129].

discussed above, the most delicate point is understanding the influence of biofuel production on emissions related to land change use, which will be discussed further on.

LUC emissions. Two types of emissions related to land use change are distinguished: direct land use change emissions occur when some land (forest, food crop, etc.) is converted to grow raw materials for bioenergy, leading to a variation in the carbon store in this land; and indirect land use change emissions occur when land is converted somewhere in response to an increase in bioenergy cultures somewhere else. Although indirect land use change emissions cannot be measured or observed directly, they can be assessed using socio-economic models. To take a concrete example, if a wheat field is replaced by a field of miscanthus, in response to which a forest is cut down to grow wheat, replacement of the wheat field is counted in direct emissions and replacement of the forest in indirect emissions. The need to rely on possibly complex socio-economic models makes the estimation of LUC emission intrinsically uncertain [147,159,160,167].

Induced land use change emissions encompass both types of emissions, direct and indirect, and are simply referred to as LUC emissions. LUC emissions take into account carbon changes from various categories, such as natural vegetation, agricultural biomass and soil (possibly distinguishing peatland). Emissions induced when unused cultivated land is put back into production and also the effect of foregone sequestration (avoided emission savings due to reduced afforestation) are also taken into account [129,168]. When all these terms are counted, biofuel combustion can be considered neutral, as previously discussed.

Values for several production pathways are presented in Fig. 20: these values are taken from [129], see also [147,168] for other results.

Also, estimating LUC emissions means fixing a time scale. Indeed, several of the emissions described above only occur once, for example like carbon released from peatland converted into a bioenergetic crop. This instantaneous emission therefore has to be divided over a time scale which must be set subjectively, and results in a possible “carbon debt” [169,170]. The resulting estimation therefore necessarily reflects value judgments [165]. Finally, the time value of emissions and absorption is just as important. For example, emitting CO₂ which will only be offset in 20 to 30 years exacerbates the global warming problem which is also a short-term problem. In the case of biofuels, this problem can for example arise for lignocellulose rotations which, even in short rotation, take many years to grow. This problem is investigated in details in [147], which concludes that the carbon debt depends on the production pathway and the land concerned. For instance, “biofuel production from switchgrass cultivated on former agricultural lands

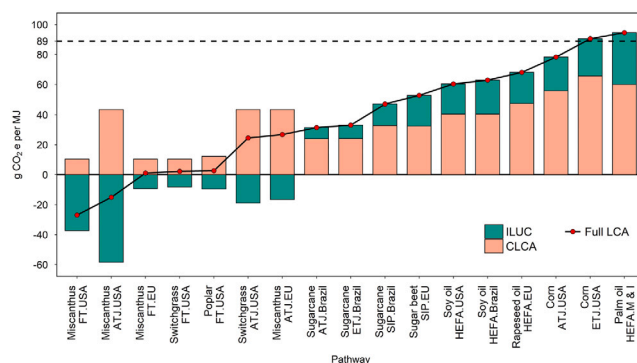

Fig. 21. Full LCA results for different biofuel production pathways. Green bars indicate LUC emissions; red bars indicate core LCA emissions; and the dots indicate full LCA results. Emissions related to land use change are computed with a 25-year amortization period.

Source: According to figure 2 by Zhao et al. [129].

avoids carbon debt, resulting in immediate net mitigation potential.”

Full LCA results. Combining core LCA and LUC emissions results in full LCA emissions. The overall emission factor strongly depends on the feedstock, the conversion pathway and even the location where the biomass was grown, with feedstock being the main source of variability across the pathways for full LCA emission values [129]. Fig. 21 provides a complete estimate for various feedstock, location and pathways. The emission factors range from negative for US miscanthus processed by the FT and ATJ pathways thanks to soil carbon sequestration [171], to close to 0 for EU miscanthus, switchgrass and poplar processed by the FT pathway, to positive for other combinations of feedstock/location/pathways. Recalling that the full LCA emission factor of fossil kerosene is around 89 gCO₂-eq/MJ [28], some biofuels are seen to perform even worse than fossil kerosene.

Fig. 22 synthesizes full LCA results for different biofuel pathways gathered from various sources.

5.2.3. Electrofuels

Electrofuels, also called e-fuels or PtL (Power-to-Liquid) refer to fuels that are produced by combining hydrogen produced by electrolysis with carbon coming from CO₂ (collected from atmosphere or industrial plant, see Section 5.2.1). The general principle of electrofuel production is represented in Fig. 23. When coming from point sources, the CO₂ is in general still from fossil rather than biogenic origin, and so it can

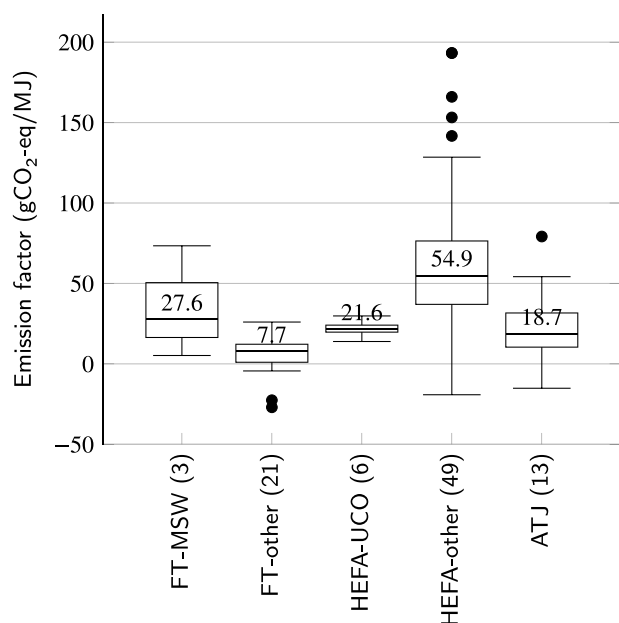

Fig. 22. Boxplot for the full LCA emission factor (including LUC) of different biofuel production pathways. For each pathway, the number of values on which the boxplot is based is indicated within parenthesis, and the median value is indicated above the median bar.

Source: Data compiled from [129,132,158,172,173].

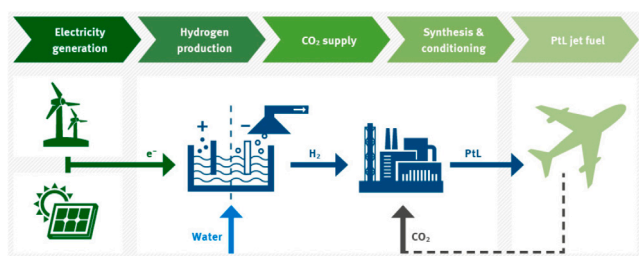

Fig. 23. Electrofuel general principle.

Source: Figure 2 from [174].

at best halve global CO₂ emissions. In the short-run these sources are more abundant and are more easily mobilized, but in the long-run, only atmospheric CO₂ has the potential to drastically diminish CO₂ emissions.

Electrofuels have been intensively studied, see for instance [175–180] for general reports and papers, [174,181,182] for papers and reports more specific to the aviation sector and [153,183–188] for papers including economic considerations.

Carbon-neutral combustion. Usually, one assumes that the combustion of electrofuels is carbon-neutral, and the scope of CO₂ emissions is restricted to the electricity production process: this is the reason why electricity production is mentioned as the only main source of CO₂ emissions for electrofuels in Table 6. As it has been discussed for biofuels, this assumption deserves scrutiny. However, for electrofuels the situation is much simpler than for biofuels because the carbon that is used is not mediated by biomass. In particular, the additionality of the CO₂ sink is clear because no CO₂ would be sequestered in the absence of the man-made carbon-capture technology. This is all the more true as DAC facilities themselves have a negligible impact on land use [131,189], and so the impact of electrofuels on land-use is through the electricity production facilities. Finally, the carbon that is captured by DAC technologies is directly converted into fuel, so that

Table 12

Different values in gCO₂-eq/kWh of electricity production emission factor by production source (in 2010 and 2050) and world region in 2021. PV: photovoltaic; CSP: concentrated solar power. Values from [194] for the values by energy source and Our World in Data for world regions.

By production source		
	EF in 2010	EF in 2050
Coal (CCS)	210	109
Gas (CCS)	170	78.3
Bioenergy	200	98.4
BECCS	–	–312
Hydropower	24	–
Nuclear	12	3.5
Wind	11	4.4
CSP	27	11.5
PV	48	6
Values by world region		
	EF in 2021	–
World	441	–
US	379	–
EU27	262	–
China	544	–

electrofuels do not suffer from the potential problem of carbon debt or delayed offset.

As already discussed for biofuels, the assumption of carbon-neutral combustion could tend to obfuscate CO₂ emissions that occur during the conversion process. However, for FT biofuels, the carbon loss occurs because of the stoichiometric ratio H₂/CO of the input biomass as it will be discussed in Section 5.2.4 below on PbtL. In the electrofuel pathway, this ratio is controlled, and so there should be no carbon loss. Most studies indeed suggest that there is no carbon loss in electrofuel production pathways: Giesen et al. [190, Figure 4] and Liu et al. [191, Figure 2] provide flow diagrams where the amount of CO₂ captured is equal to that emitted during the combustion, Micheli et al. [131] provide a detailed LCA with small carbon losses, and Albrecht et al. report a carbon conversion of 98% [183]. However, König et al. [192] report a carbon efficiency of 73.7%, while Alhyari et al. [193] suggests that up to 30% of the input CO₂ could be reemitted during the conversion process.

Kaya identity for electrofuels. Since CO₂ emissions for the production of electrofuels are mainly due to the production of electricity, the Kaya identity can be refined as follows in order to understand the amount of electricity needed:

$$\text{CO}_2 = \frac{\text{CO}_2}{\text{E}[\text{elec}]} \times \frac{\text{E}[\text{elec}]}{\text{E}[\text{efuel}]} \times \frac{\text{E}[\text{efuel}]}{\text{RPK}} \times \text{RPK} \quad (3)$$

with E[elec] the amount of electricity produced and E[efuel] the amount of energy embarked in the plane in the form of electrofuel. Note that in this decomposition, CO₂ corresponds only to CO₂ emitted due to the electricity production because of the convention of carbon-neutral combustion discussed above.

Since electrofuels are drop-in, the energy intensity term $\frac{\text{E}[\text{efuel}]}{\text{Traffic}}$ does not change. The electricity production emission factor $\frac{\text{CO}_2}{\text{E}[\text{elec}]}$ is common to all electricity-based AEC and will be discussed in Section 5.4. Current values for electricity production emission factors are summarized in Table 12, together with estimation for 2050.

Given the wide range of values for the electricity production emission factor, clear accounting rules are needed in order to determine which value to use. Two options are commonly considered: the national grid emission factor, or an assumption of 100% renewable electricity. In Europe for instance, Article 25, paragraph 3 of the Renewable Energy Directive (RED II) presents three options for calculating the amount of renewable energy used in electrofuels [178]:

1. Assume the average share of renewable electricity in the country of production when importing electricity from the grid;

Table 13

Overall conversion efficiency for electrofuels. LTE = low temperature electrolysis; HTE = high temperature electrolysis. Here efficiency is the ratio of the energy in all fuel outputs (mostly naphtha, diesel and kerosene), divided by the energy input (mostly under the form of electricity).

Source: Adapted from [182].

CO ₂ source	Conversion efficiency in 2020 [2050]	
	LTE	HTE
Air	38% [41%]	45% [46%]
Exhaust gas	47% [51%]	60% [61%]
Fermentation	48% [53%]	62% [63%]

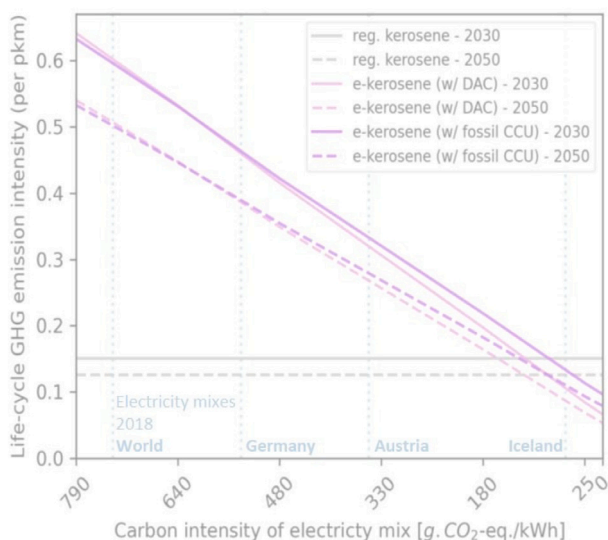

Fig. 24. Evolution of the electrofuel emission factor as a function of the electricity production emission factor.

Source: Extract from Extended Data Figure 5 in [180].

2. Assume 100% renewable share if electrofuels are produced via a direct connection to a new renewable electricity installation that does not import electricity from the grid;
3. Assume 100% renewable share when importing electricity from the grid if it can be demonstrated that the electricity is from renewable sources.

The conversion intensity $\frac{E_{[elec]}}{E_{[efuel]}}$, defined as the amount of electricity needed to produce 1 MJ of electrofuel, depends mainly on two factors: the CO₂ source and the use of low- or high-temperature electrolysis. Table 13 summarizes typical values for the conversion efficiency of the full process. These values, taken from [174], are consistent with those reported in many different sources such as [124,133,180,190,195–197]. Both the CO₂ source, with concentrated CO₂ source being more efficient than diluted ones, and of the electrolysis technique used, with electrolysis being more efficient at high temperature than at low one, influence the conversion efficiency.

Electrofuels emission factors. Electrofuels emission factors thus depend on the conversion efficiency and the electricity production emission factor. Fig. 24 shows the evolution of the electrofuel emission factor with respect to the electricity production emission factor.

Estimates of electrofuel emission factors can be obtained by dividing the electricity emission factor of Table 12 by the conversion efficiency of Table 13. For instance, producing electrofuels from the Chinese mix, in current conditions with low-temperature electrolysis and with CO₂ coming from exhaust gas, would result in an electrofuel emission factor of 321 gCO₂-eq/MJ, while an electrofuel produced in 2050 from wind

Table 14

Different values for electrofuel emission factors depending on the production pathway, the origin of CO₂ and the electricity mix.

Assumptions	EF (gCO ₂ -eq/MJ)	Ref
Back-of-the-envelope computation from Tables 12 and 13		
China mix 2020 + LTE + exhaust gas	321	Own calculation
PV 2020 + LTE + DAC	35	Own calculation
Wind 2050 + HTE + DAC	3	Own calculation
From literature		
Wind/PV in Germany, renewable world embedding	~1	[182]
Wind/PV in Germany, today's energy landscape in material sourcing and construction	11–28	[182]
DAC 2030/2050	23/16	[180]
CCU 2030/2050	61/56	[180]
Grid mix	227	[131]
Wind power	9.35	[131]
PV	28.6	[131]
Wind power	9.35–39.5	[131]
DAC	30	[190]
German mix	277	[193]
Wind	8.6	[193]
PV	46	[193]

electricity, high-temperature electrolysis and CO₂ from DAC would result in an emission factor of 3 gCO₂-eq/MJ. These values are consistent with the values from the literature reported in Table 14.

Comment on selectivity. As for biofuels, the electrofuel production pathway creates hydrocarbon chains of varying lengths, so that selectivity remains a relevant notion. Similarly as for biofuels, selectivity does not affect the core LCA analysis if, for instance, selectivity is expressed in energy ratios and the energy allocation method is chosen. However, selectivity becomes important if one seeks to understand the amount of energy needed to produce a given amount of aviation electrofuel. Such estimations are for instance performed in the two reports [198,199], that use a conversion efficiency of ~20%. But in this case, this ratio is the amount of electrofuel for aviation obtained from 1 MJ of electricity, and not the total amount of output fuel. Thus, with this 1 MJ, one obtains ~0.2 MJ of aviation electrofuel, but also other co-products.

5.2.4. Power- and Biomass-to-Liquids

As discussed in Section 5.2.2 on biofuels, FT biofuels are among the most promising biofuels, but they suffer from a large carbon loss. The carbon flow of FT biofuels is represented in Fig. 25(a), where we see that the carbon loss mainly occurs during the gas cleaning process. In order to understand the potential interest of PBT, one needs to better understand the origin of this carbon loss. The following explanation closely follows that given in [200].

The FT reaction transforms H₂ and CO to produce hydrocarbon chains according to the following reaction:

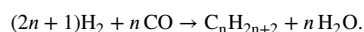

For this reaction to occur, the stoichiometric ratio H₂/CO must be slightly higher than two. However, when biomass is gasified, the product gas has an H₂/CO ratio of less than one. In order to increase the ratio to a level that is suitable for FT synthesis, the conventional way of thinking is to add steam to the syngas so that CO is shifted to CO₂ and H₂ according to the following water gas shift reaction:

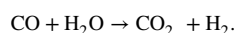

Table 15

Carbon efficiency is the share of input carbon that ends up in the output fuels. Conversion efficiency is the ratio between the energy in the fuel output, divided by the sum of power input and energy in feedstock on Lower Heating Value (LHV) basis. The large range of values for the emission factors reflects the large variations for the electricity production emission factor.

	FT biofuel	Electrofuel	PBtL	Ref
Carbon efficiency range	20%–40%	87%–99%	55–97.7%	[130,200–203]
Conversion efficiency range	30%–50%	40%–60%	51%–71%	[152,154,156,173,182,200–202]
Emission factor (gCO ₂ -eq/MJ)	–33–27.6	3–330	4–187	[130,172,173]

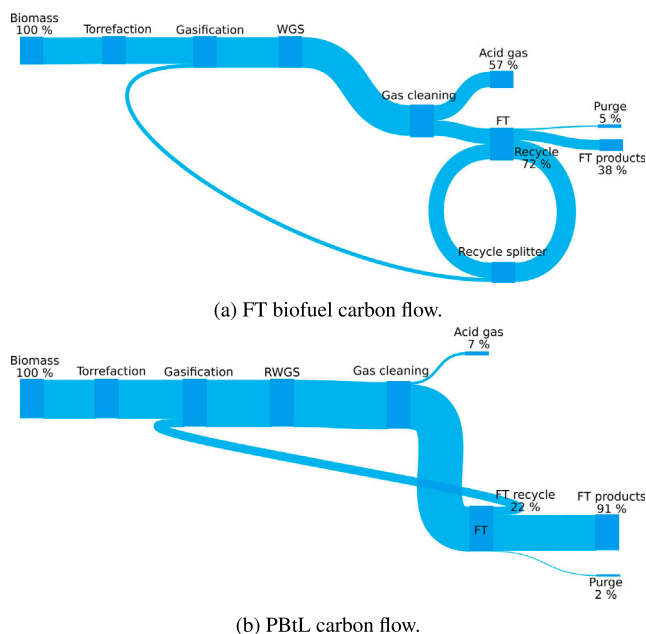

Fig. 25. Carbon flows for a FT biofuel (top) and PBtL (bottom). Although 62% of the input carbon is lost in the FT pathway (through acid gas and purge), for PBtL, 92% of the input carbon ends up in the output fuels.

Source: From [200, Figures 13 and 14].

This increases the H₂/CO ratio because it adds H₂ and removes CO, but by doing this, half of the biomass carbon ends up as CO₂ and not in the product, and this is this CO₂ which is removed in the gas cleaning step of Fig. 25(a).

In PBtL, the stoichiometric ratio H₂/CO is adjusted by directly adding H₂. The extra hydrogen produced is added at different steps of the process: most of the hydrogen is added to the syngas at high temperature and some at low temperature. At high temperature, the hydrogen is partly converting CO₂ into CO in a reverse water gas shift reaction and partly increasing the H₂/CO ratio. At low temperature, the hydrogen is only used to adjust the H₂/CO ratio to the optimal ratio. This fundamentally changes the carbon flow, as it can be seen on Fig. 25(b).

Table 15 shows that the carbon efficiency of PBtL is indeed improved compared to FT biofuels. Moreover, PBtL are similar to electrofuels in terms of CO₂ emissions but are more efficient from an energy point of view. This increased efficiency translates in economic performance in-between biofuels and electrofuels [130,201].

From a mitigation perspective, the destination of the biomass carbon is an important criterion to decide between PBtL and FT biofuel. For PBtL, most of the atmospheric carbon captured by the biomass goes into the fuel, while for FT biofuel, a large part of this carbon escapes directly during the production process. Without CCS technologies, the use of PBtL rather than FT biofuel therefore optimizes the role of biomass for a given quantity of fuel. However, the use of FT biofuel coupled with CCS technologies to capture the CO₂ emitted during the production could minimize CO₂ emissions over the whole life cycle

(or even turn them negative) compared to PBtL. In this case, for a given quantity of carbon captured by the biomass, PBtL would make it possible to use all of this carbon to produce fuel, while FT-CCS would use a part of this carbon to produce fuels, and the other part would be stored and thus removed from the atmosphere.

5.3. Non-drop-in AEC

5.3.1. General consideration

As it can be seen on Table 6, mainly two non-drop-in AEC are currently considered: hydrogen and electric batteries. As mentioned previously, we only consider in this paper hydrogen produced by water electrolysis. We therefore consider that these two AEC are produced from electricity: in particular, the Kaya identity (3) introduced to understand CO₂ emissions associated to electrofuels still applies and can be written as

$$\text{CO}_2 = \frac{\text{CO}_2}{\text{E}[\text{elec}]} \times \frac{\text{E}[\text{elec}]}{\text{E}[\text{AEC}]} \times \frac{\text{E}[\text{AEC}]}{\text{RPK}} \times \text{RPK} \quad (4)$$

with AEC being either electric batteries or hydrogen. Since these two AEC do not emit CO₂ during the flight when they are used to power an aircraft, there is no need to discuss the assumption of carbon-neutral combustion, which is key in analyzing CO₂ emissions for drop-in AEC. In Eq. (4), CO₂ therefore refers to emissions during the production of electricity.¹⁷ The electricity production emission factor $\frac{\text{CO}_2}{\text{E}[\text{elec}]}$ has already been discussed in Section 5.2.3 and will be discussed in more details in Section 5.4.

Thus, for each AEC, the discussion below will focus on the two remaining terms $\frac{\text{E}[\text{elec}]}{\text{E}[\text{AEC}]}$ (conversion intensity) and $\frac{\text{E}[\text{AEC}]}{\text{RPK}}$ (energy intensity). From a conceptual standpoint, the main difference between the Kaya identities (3) and (4) is the energy intensity term $\frac{\text{E}[\text{AEC}]}{\text{RPK}}$: although for drop-in fuels this term was the same as for fossil kerosene, powering an aircraft from electric batteries or hydrogen requires to design a new aircraft with possibly different energy efficiency.

5.3.2. Hydrogen

Due to the low density of hydrogen, the majority of research projects consider the use of liquid hydrogen to decrease the volume of hydrogen on board [206, Figure 16]. Therefore, in the following, we focus on liquid hydrogen.

Analysis of the conversion intensity term $\frac{\text{E}[\text{elec}]}{\text{E}[\text{AEC}]}$. Conversion intensity is directly related to the way hydrogen is produced. On Fig. 26, it can be seen that in 2021, 94 Mt of hydrogen was produced, either as a by-product of naphtha reforming at refineries (16.9 MtH₂), or from dedicated production plant (77 MtH₂) [120]. Out of these 77 MtH₂, the

¹⁷ Concerning hydrogen, this assumption is restrictive. Indeed, a growing evidence suggests potential leakage during production, transport, storage and use, with leakage rates ranging from 1 to 10% [204]. Hydrogen is not a greenhouse gas, but it interacts with methane and ozone [205]. For instance, “tropospheric oxidation of H₂ depletes the hydroxyl radical (OH). Since OH is the main sink for methane, a potent greenhouse gas, this results in a lengthening of the methane atmospheric lifetime” [204]. By restricting the perimeter to CO₂ emissions due to electricity production, these potential emissions are therefore neglected.

Table 16

Summary values for liquid hydrogen production. Electrolysis efficiency is the amount of hydrogen obtained from 1 MJ of electricity; liquefaction intensity is the amount of electricity needed to liquefy 1 MJ of hydrogen; and the production efficiency is the amount of liquid hydrogen obtained from 1 MJ of electricity. The 2030 value of liquefaction intensity is based on technology which was announced in 2017 to be available in the next 5 years [211].

Parameter	Unit	Range of values		Ref
		2020	2030	
Electrolysis efficiency	MJ[H ₂]/MJ[elec]	56%–81%	63%–84%	[196]
Liquefaction intensity	MJ[elec]/MJ[LH ₂]	0.3–0.45	0.18	[211]
LH ₂ production efficiency	MJ[LH ₂]/MJ[elec]	48%–59%	57%–73%	Own calculation

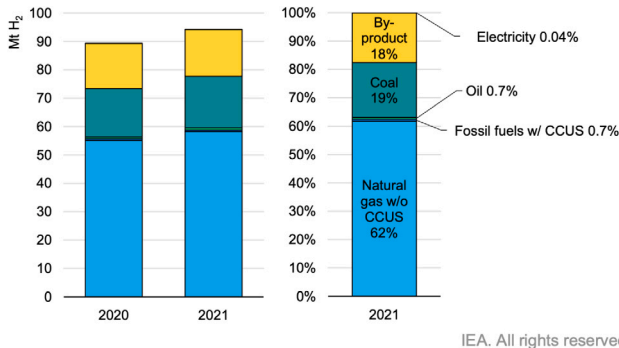

Note: CCUS = carbon capture, utilisation and storage.

Fig. 26. Hydrogen production mix in 2021.
Source: From the figure on page 71 of [120].

vast majority (99%) was produced from natural gas and coal, with respective emission factors around 12 gCO₂/kgH₂ and 23 gCO₂/kgH₂ respectively [118,196,207–209], corresponding to around 910 MtCO₂ of emissions,¹⁸ a figure comparable to those of the aviation sector (see Section 2.2.1).

Production of hydrogen from electrolysis is currently marginal (0.04% of total production in 2021 [120]) but is expected to play an important role for the low-carbon production of hydrogen in the future. The emission factor then depends on the electrolysis efficiency (in MJ[H₂]/MJ[elec]). Currently, typical efficiency lies in the range between 56% and 81%, and could increase in the future [196, Table 3].

Finally, hydrogen needs to be liquefied. If hydrogen is available at ambient pressure, the work for an ideal hydrogen liquefaction amounts to 3.8 kWh per kilogram of liquid hydrogen, which represents around 10% of the hydrogen energy content. Recent liquefaction plants require between 10 kWh/kg[LH₂] and 15 kWh/kg[LH₂], and values around 6 kWh/kg[LH₂] seem reachable in the short term [210,211] but at a higher operating cost [212]. As a consequence, as summarized in Table 16, the energy efficiency of liquid hydrogen (taking into account the electrolysis and liquefaction steps) currently lies in the range from 48% to 59%, thereby corresponding to a conversion intensity term $\frac{E_{[elec]}}{E_{[AEC]}}$ in the range from 1.7 to 2.1.

Analysis of the energy intensity term $\frac{E_{[AEC]}}{RPK}$. The evolution (compared to a conventional plane) of the energy efficiency of hypothetical hydrogen aircraft is governed by various technological parameters and design choices. The reader is for instance referred to the three recent surveys [116,206,213] for in-depth discussions. Here, we briefly describe the technological evolution with the main impact on energy efficiency. These evolutions and their impacts are summarized in Table 17.

There is first a design choice, in that hydrogen could be used in two different ways to power an aircraft: either to power a fuel cell to

Table 17

Technological evolution with the main impact on the energy efficiency of hypothetical future hydrogen airplane. A positive (+) (resp. negative (-)) qualitative impact means a technological evolution which tends to improve (resp. degrade) energy efficiency.

Technological evolution	Impact description	Qualitative impact
New fuel	Higher fuel LHV (smaller fuel mass)	+
	Lower fuel volumetric energy density (negative impact on load or aerodynamic)	-
Cryogenic fuel tank	Higher tank mass	-
Fuel cell	Higher efficiency of electric power chain	+
	Low specific power of fuel cell	-

Table 18

Hydrogen summary values compared to the ones of fossil kerosene.

Parameter	Unit	Kerosene	Hydrogen
LHV	MJ kg ⁻¹	min 42.8	119.9
Energy density (1 bar)	MJ l ⁻¹	min 33.2	0.01
Energy density (700 bar)	MJ l ⁻¹	-	4.8
Energy density (liquid, -253 °C)	MJ l ⁻¹	-	8.5

produce electricity within an electric propulsion system, or through its combustion into a gas turbine. The gas turbine design necessitates only minor technological evolution, whereas the fuel cell design benefits from the higher efficiency of electric propulsion; however, fuel cells incur a mass penalty due to their current limited specific power [198].

Compared to kerosene, Table 18 shows that hydrogen has a higher specific energy (LHV), but a lower volumetric energy density. Thus, embarking the same amount of energy entails less mass but requires a higher storage volume. Having to embark a larger volume of fuel has a negative impact on efficiency compared to conventional kerosene tube-and-wing aircraft. In this case, two solutions can be considered. On the one hand, by keeping the same architecture, the hydrogen tanks could be integrated into the fuselage, which would reduce the volume available to carry the payload and so the passengers. On the other hand, the architecture could be adapted by lengthening or widening the fuselage or wing, which would result in an increase in weight or a decrease in aerodynamic performance. However, other aircraft configurations, such as blended-wing body, could be interesting due to a larger available volume.

To ease this volume issue, hydrogen can be embarked under liquid state onboard large commercial aircraft, which explains why many research projects are focused on liquid hydrogen. Indeed, the hydrogen

¹⁸ The IEA indicates more than 900 MtCO₂ [120]: the more precise value of 910 MtCO₂ is obtained from the IEA mix of Fig. 26 together with the values of emission factor mentioned in the text.

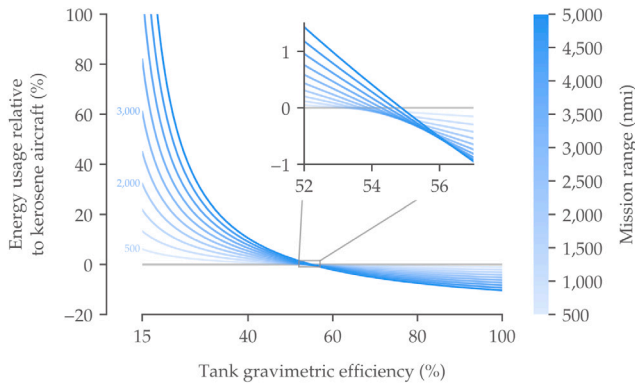

Fig. 27. Evolution of the energy usage relative to a conventional aircraft as a function of the tank gravimetric efficiency, see detailed discussion in the body of the text. Source: From [206, Figure8].

volumetric energy density is higher in this state (8.5 MJ l^{-1}). This requires to store hydrogen at a temperature of $-253 \text{ }^\circ\text{C}$, which necessitates heavy cryogenic fuel tanks [214–218]. Actually, the incurred mass penalty is an important driver for the aircraft total efficiency, as can be seen on Fig. 27. In this figure, the performance of a cryogenic fuel tank is assessed through its gravimetric efficiency (sometimes also called gravimetric index, for instance in [198,219]), defined as the ratio of the fuel mass divided by the sum of fuel and tank mass. For instance, a gravimetric efficiency of 67% corresponds to a tank which is twice lighter than the fuel it carries. The gravimetric efficiency of kerosene tanks is very high, ranging between 90 and 98% [216,219], whereas that of cryogenic hydrogen is lower. The gravimetric efficiency depends (among other things) on the volume storage of the tank, and so it also indirectly depends on aircraft design [220]. Currently, values are in the range between 10 and 20% [198,219]; values in the range 30 to 40% are set as targets by the Clean Hydrogen JU in 2030¹⁹; and values above 60% appear to be prospective values. For instance, [216] reports that a maximal gravimetric efficiency of 65% could be achieved with a spherical cryogenic tank. However, this shape has a low packing density and so cylindrical tanks with hemispherical ends are usually considered [215]. [215] reports a baseline value of 45%, qualifies values of 30% as pessimistic and values of 85% as futuristic.

In summary, some technological evolution will have a positive impact on energy efficiency, and others a negative impact. One can also add to the list of Table 17 the increase in structural weight (fuselage and wings) [221]. All-in-all, the global impact on aircraft energy efficiency depends on many assumptions, such as the evolution of tank gravimetric efficiency or design choices. Adler and Martins [206] have a particularly insightful analysis of Fig. 27: “for low gravimetric efficiencies, hydrogen aircraft performance worsens relative to kerosene aircraft the further the flight. The assumption of a lower tank gravimetric efficiency is why some say hydrogen is only suitable for short- and medium-range aircraft. However, when the tank gravimetric efficiency is high, the opposite trend is observed: hydrogen aircraft improve over conventional kerosene aircraft as the range increases. The tipping point where the trend flips is around a tank gravimetric efficiency of 55%, regardless of the mission range” [206]. This analysis is coherent from data that can be gathered in the literature on cryoplane design, and which is summarized in Fig. 28. It must be stressed that on this figure, data are not entirely homogeneous. For instance, according to the study, efficiency is measured in MJ/RPK or in MJ/ASK; moreover, the technology levels considered may belong to different years.

¹⁹ See for instance the Clean Hydrogen JU - SRIA Key Performance Indicators (KPIs), accessed on 30th, March 2023.

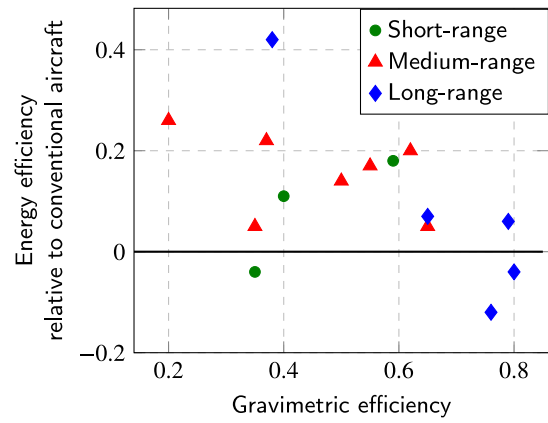

Fig. 28. Each point represents a cryoplane proposed in the literature, and plots its energy efficiency (relative to a conventional aircraft) against the assumed value of gravimetric efficiency. Below gravimetric efficiency of 0.5, efficiency degrades with range, and the trend seems to reverse above 0.5, thus confirming the insight of Adler and Martins [206].

Source: Data compiled from [127,198,212,219,221–223].

Table 19

Conversion efficiency and energy efficiency relative to a conventional aircraft for the all-electric aircraft of [225].

Parameter	Value
Conversion efficiency	76%
Energy efficiency	+58%

5.3.3. Electric batteries

In this section, all-electric aircraft using batteries are discussed. The in-flight climate benefits of an all-electric aircraft are clear, as such an aircraft would entail no emissions at all, thereby decreasing CO_2 emissions and also non- CO_2 impacts (note that contrails could still be formed [224]). Similarly as for hydrogen, the CO_2 emissions associated to electric batteries can be analyzed through the Kaya decomposition for electricity-based AEC (4), and so we need to discuss the conversion intensity term $\frac{E[\text{elec}]}{E[\text{AEC}]}$ and the energy intensity term $\frac{E[\text{AEC}]}{\text{RPK}}$. The following analysis is based on the recent study of Gnad et al. [225]: the values of conversion and energy intensities are summarized in Table 19 and briefly commented below.

Analysis of the conversion intensity term $\frac{E[\text{elec}]}{E[\text{AEC}]}$. Losses corresponding to two steps can be considered when storing electricity into batteries: 1/ transport of electricity and 2/ storage of electricity into the battery. Typical loss rates due to transport amount to 10%. For instance, 97 EJ of electricity was produced in 2019 for 82 EJ of electricity as final energy [123], corresponding to losses of around 15%; in [225], a value of 7% is used for transport loss. Concerning battery charging and round-trip efficiency, a value of 81% is considered in [225].

Analysis of the energy intensity term $\frac{E[\text{AEC}]}{\text{RPK}}$. The main problem facing all-electric aircraft is that of battery weight. Note that battery specific power is also an issue, but less so than the issue of battery specific energy [108,111,225].

Currently, state-of-the-art Li-ion batteries achieve specific energy around 0.2 kWh kg^{-1} , compared to a specific energy of 12 kWh kg^{-1} for jet fuel (corresponding, at 50% gas turbine efficiency, to an effective density of 6 kWh kg^{-1}). Therefore, embarking the required amount of energy in the form of batteries would induce a prohibitive weight penalty. Gnad et al. [225] assess the feasibility of an all-electric 180-passenger commercial aircraft. One of their conclusions is that an all-electric 180-passenger commercial aircraft with a mission range of 500 NM (900 km) would require battery specific energy of at least 0.8 kWh kg^{-1} , which represents a four-time increase over current values.

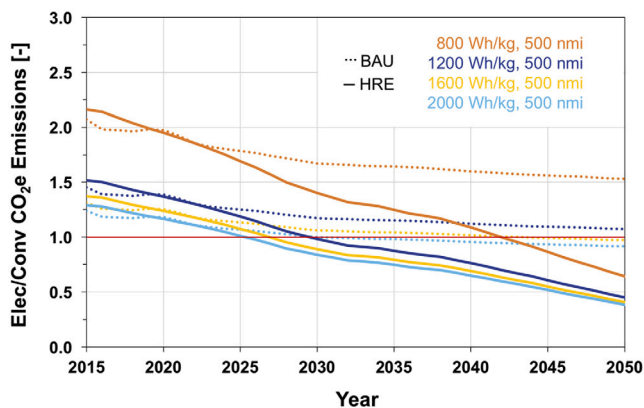

Fig. 29. Break-even years for the all-electric aircraft of [225], with two different scenarios, BAU (business as usual) and HRE (high renewable energy), for the evolution of the electricity carbon intensity, and different assumptions for the battery specific energy. Even with optimistic batteries with a specific energy of 0.8 kWh kg^{-1} (see text), an all-electric aircraft would only break even with the corresponding conventional aircraft with fossil kerosene after 2040.

Source: From Figure 30 in [225].

Despite the more efficient electric powertrain (66.1% onboard efficiency for an all-electric aircraft vs. 43.1% for a conventional aircraft in [225]), there is a strong mass penalty: the maximum takeoff weight of the all-electric aircraft of [225] is 2.6 times higher than that of its conventional counterpart. This mass penalty ultimately translates to a decrease of the energy intensity, which increases by 58% compared to a similar conventional aircraft [225].

Moreover, batteries with specific energy of at least 0.8 kWh kg^{-1} are not foreseen on a commercial scale before 2050 [108]. This is the main reason why papers that have assessed the potential climate benefits of all-electric aircraft conclude that they will only have a marginal impact by 2050 for short-medium-range and long-range aircraft [111,225].

5.4. Break-even years for electricity-based AEC

The carbon intensity of electricity-based AEC depends crucially on the carbon intensity of the electricity: values of AEC carbon intensity were for instance given in Table 14 for electrofuels, for varying assumptions on the electricity carbon intensity. We see that if the electricity carbon intensity is too high, the electrofuel carbon intensity is higher than that of fossil kerosene, but electrofuels become beneficial when produced from dedicated low-carbon electricity sources (renewable or nuclear). A similar analysis applies to all other electricity-based AEC, in particular electric batteries and hydrogen (when produced from electrolysis); it also applies, but to a lesser extent, to PBtL. Currently, many electricity mixes lead to AEC carbon intensity higher than that of fossil kerosene, but as mixes evolve towards mixes with a higher share of low-carbon electricity sources, there is a point in time where the AEC would break even with fossil kerosene. This break-even year is of prime importance, because even if all the aviation-related technologies were available, the new AEC would not be beneficial for climate before this break-even year.

The analysis of break-even year was for instance made for electric batteries in [225]. Fig. 29 shows the result of the analysis. As the electricity carbon intensity decreases, the all-electric aircraft considered becomes more and more efficient, but even with batteries with a specific energy of 0.8 kWh kg^{-1} which are not foreseen before 2050 (see above), it is only after 2040 that the all-electric aircraft would become beneficial relative to a conventional aircraft powered with fossil kerosene. Concerning hydrogen, a study of the French national environment agency ADEME showed that the break-even year at the world level would be in 2045, and beyond 2050 for Asia-Pacific and

Africa. However, the break-even year would be before 2030 for central and south America and Europe [226]. Concerning electrofuels, data such as those displayed in Fig. 24, coupled with scenarios for the evolution of the electricity carbon intensity, leave open the possibility to carry on similar analysis. Lastly, it is important to note that the concept of break-even year applies in the case of electricity from the grid, and not for dedicated electricity which can be low-carbon right now.

6. Non-CO₂ mitigation levers

As discussed in Section 2, it is mandatory to consider the role of non-CO₂ effects to correctly evaluate the impact of aviation on climate. The comparison of these effects with CO₂ effects in terms of warming potential is not straightforward, depending also on the time horizon chosen. However, while the lifetime of most of non-CO₂ effects is usually short (typically a couple of hours up to a couple of months), their instantaneous effects are sufficiently important to represent more than half of the current effective radiative forcing due to aviation. As a consequence, it is mandatory to consider an adequate mitigation policy also for these non-CO₂ effects. A particular care has to be brought when considering the reduction of these non-CO₂ climate forcers, because some of associated mitigation levers may lead to an increase in CO₂ emissions.

Among non-CO₂ effects, the most important impacts come from NO_x emissions ($+17.5 \text{ mW m}^{-2}$) and contrail-induced cirrus induced by the aircraft contrails ($+57.4 \text{ mW m}^{-2}$). For these two effects, specific mitigation strategies are discussed in the next paragraphs.

6.1. NO_x emissions

The majority of NO_x are emitted during the cruising phase, where particular chemical reactions lead to the formation of ozone (O₃). In all cases, the reduction of NO_x remains challenging for aviation. The adaptation of the engine design to reduce NO_x emissions is not straightforward since the quantity of these emissions depends on the flight phase due to the engine rotation speed [227]. Moreover, an increase of the engine core temperature, which improves the thermal efficiency of the engine, is usually targeted but increases NO_x emissions [228]. As a consequence, a reduction of NO_x could lead to a decrease of the engine efficiency and thus to an increase of the fuel burned and associated CO₂ emissions. The lifetime of NO_x effects on climate are typically lower than a month, so the warming effect of an even small increase in CO₂ would overcome the benefit of NO_x reduction. An optimization is therefore necessary between fuel consumption and NO_x emissions [229].

The effects of NO_x depend on the region where they are emitted, but the main driver remains the influence of meteorological conditions and the transport pathways of such emissions within the first weeks after emissions [230,231]. For example, when NO_x emissions are transported towards high latitudes, where photochemical activity due to solar irradiance is lower, it results in a limited production of ozone (so minimizing the warming effect), while the transport of NO_x emissions towards lower latitudes increases significantly the production of ozone, thus leading to a strengthened warming effect [232]. The mitigation of NO_x effects could thus benefit from improvement in engine technology, as well as an adaptation of the flight path to avoid some climate-sensitive regions.

However, major uncertainties remain concerning the future impact of aviation NO_x emissions on climate. Indeed, the impact of NO_x emissions depends in particular on atmospheric NO_x and methane background concentrations. Changes in background concentrations could thus lead to small or negative climate forcing induced by aviation NO_x emissions [233]. These results could therefore call into question the objective of reducing NO_x from aviation to mitigate the climate impact of aviation. For these reasons, Skowron et al. [234] conclude that an improvement in efficiency is preferable to a decrease in NO_x emissions.

6.2. Contrails-induced cirrus

To attenuate the climate impact of contrails and induced cirrus, it is necessary to identify the main physical mechanisms involved in their creation and development. First, the condensation of water droplets in the atmosphere, which is the root mechanism at the origin of contrails, is favored by the presence of natural or artificial aerosols. The burning of kerosene is usually an important source of artificial particles in the aircraft plume (the burning of 1 kg of kerosene emits about $10^{14} - 10^{15}$ soot particles [235]), but such soot-rich exhausts are not mandatory for contrails to form and an optimum in particle concentration could theoretically exist [33]. However, more than the creation of a contrail in itself, it is their development and persistence that is responsible for the impact on climate. In some conditions, contrails can persist, spread and evolve into contrail-induced cirrus with observed lifetimes of up to a few hours [236]. Typically, in the North-Atlantic area, 70% of contrails formed are short-lived with negligible influence, 20% of contrails are persistent but with a net cooling effect while only 10% of contrails are persistent with a strong warming impact [237].

Two conditions are necessary for a contrail to persist as presented in Section 2. First, the possibility for such a contrail to form in particular atmospheric conditions can be evaluated with the revised Schmidt–Appleman criterion [238]. This criterion is based on the evaluation of the path of the aircraft plume from the engine exhaust conditions until ambient conditions, in terms of both temperature and humidity. This path has to cross the saturation curve with respect to liquid water to observe the condensation of water droplets. This possibility depends on the value of the slope given by the G -factor (Pa K^{-1}) defined as:

$$G = \frac{p}{\epsilon} \frac{C_p}{\epsilon} \times \frac{EI_{H_2O}}{(1-\eta)Q}, \quad (5)$$

where $\epsilon = 0.622$ is the ratio of molar masses of water and dry air, $C_p = 1004 \text{ J kg}^{-1} \text{ K}^{-1}$ is the constant pressure air heat capacity and p is the ambient pressure of atmosphere. EI_{H_2O} is the fuel related emission index of water vapor ($= 1.25 \text{ kg per kg of burned kerosene}$), Q is the fuel Lower Heating Value ($= 43 \text{ MJ per kg of kerosene}$), and η is the overall aircraft efficiency (typically $\eta = 0.3$). The Schmidt–Appleman criterion only estimates if a contrail can form, so a second condition is necessary to estimate the contrail persistence: the aircraft must fly in an ice supersaturated region (relative humidity with respect to ice must exceed 100%).

To mitigate contrail-induced warming, it is not necessary to avoid all contrails and even not all persistent contrails. Targeting only those responsible individually for the largest warming impact is sufficient to largely eliminate the overall climate effect of contrail-induced cirrus [239]. Different approaches can be considered to reduce such contrails. In the following, the focus is done on the two approaches that have been largely investigated: the flight diversions and the reduction of artificial aerosols emissions [236].

6.2.1. Flight diversion

An efficient mitigation strategy would rely on the avoidance of ice supersaturated regions during the flight path [240], but not in a general manner to avoid useless increase in cost, flight time and both CO_2 and NO_x emissions. However, such flight diversion strategies drastically increase air traffic complexity and the risk of potential conflicts [241]. Only a minority of flights generate most part of the contrails, typically less than 20% [242] and even a lower fraction of flights are responsible for the warmest persistent contrails, which preferentially form during winter night flights [239].

The deviation strategy should thus consider a minority of flights, preferentially during some periods of the day (e.g. the night) and during some seasons (e.g. the winter). The main strategy considered is to divert the aircraft trajectory, in the horizontal direction [243] or in the vertical one [244], as illustrated in Fig. 30. Usually, short-lived contrails form at the tropopause level and above the jet stream,

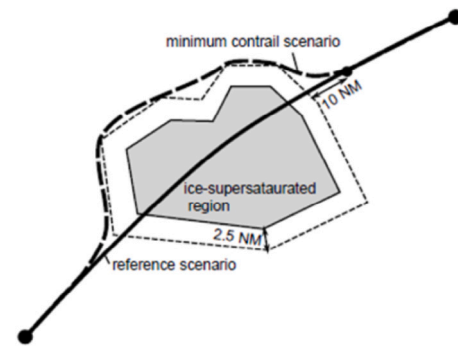

(a) Example of horizontal flight diversion strategy in order to avoid the formation of contrails, according to figure 1 of Rosenow *et al.* [243].

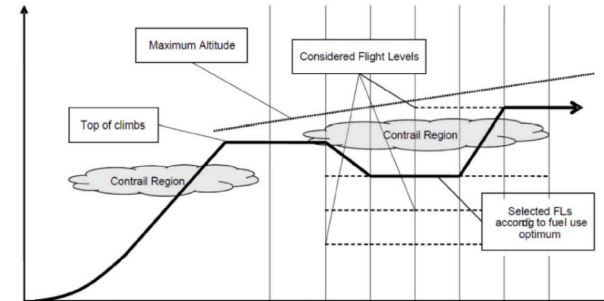

(b) Example of vertical flight diversion strategy in order to avoid the formation of contrails, according to figure 44.3 by Matthes *et al.* [246].

Fig. 30. Illustration of horizontal (left) and vertical (right) flight diversion strategies in order to avoid the formation of contrails. (See [243,246]).

while persistent contrails are located below the tropopause and at the altitude of the jet stream [245], which plead for a modification of the flight altitude up to a few kilometers as an efficient way to reduce the contrail influence. Different strategies can be used to modify the flight altitude [34], such as: (1) change cruise altitude on a global scale; (2) restrict cruise altitudes for determined regions during a given period of the year; (3) change aircraft cruise altitude during flight depending on meteorological conditions.

Such diversion-based methods seem promising: minor changes of the aircraft trajectory, without fuel burnt increase, could result in a 20% reduction of the contrail energy forcing [242]. The potential generalization of diversion strategies, applied to the whole fleet, could lead to a reduction of about 60% of the contrail energy forcing at an extra cost of 0.014% for the fuel burnt [242]. When considering both CO_2 and non- CO_2 effects in the objective function, such trajectory optimization could reduce the climate impact of aviation up to 40% with only a moderate 0.5% penalty on fuel burnt [247].

Different diversion strategies can be implemented to reduce non- CO_2 effects, based on different climate metrics. In all cases, the prediction of optimal climate trajectories requires an accurate evaluation of the operational constraints, aircraft performance and climate impact. Contrails can be predicted with some success, but the evaluation of their persistence, while necessary, remains challenging [239]. In that context, the main weakness of these mitigation strategies is the uncertainties associated to engine emissions, climate modeling and weather forecast, which, if not correctly considered, could lead to unreliable solutions [57,248].

6.2.2. Aerosols reduction

Along with the modification of the trajectory, another approach is to reduce the quantity of artificial aerosols emitted by the engine. This could be achieved by improving/modifying the engine design or by replacing kerosene by AEC.

Concerning the solutions based on engine design, adapted combustion chamber designs, such as dual annular combustors consisting in a double injector rows [249], can for instance reduce by one order of magnitude the number of particles per kilogram of burnt kerosene, compared to conventional combustion chambers. Such low emissions combustors, combined with an adequate diversion strategy, could reduce up to 90% the forcing due to contrails, compared to classical combustors [242]. Another alternative is to evaluate the potential of fuel-cell-based electric engines on the generation of contrails. The main advantage of such a technology is to eliminate artificial aerosols emissions, but in turns it increases the water vapor emissions per unit of energy. Recent theoretical works have shown that such fuel-cell-based engine could generate more frequent contrails, including at the ground level, but with an energy forcing much lower than kerosene-based engine [224]. Such fuel-cell engine will also generate shorter lifetime contrails, reducing their persistence. As a consequence, fuel-cell-based engine would be beneficial to reduce non-CO₂ effects (including NO_x). In the case of a hybrid-electric engine, integrating battery with a turbofan, the conclusion depends on the ratio between electric and thermal powers. A reduction of the contrail influence is observed only when a significant fraction of electric power is used, typically more than 30% [250].

The other solution is to replace kerosene by other AEC. On the one hand, the use of drop-in AEC that contain a lower quantity of soot precursors such as aromatics, like biofuels, could have a significant impact on contrails. For instance, a 50/50 mix between conventional kerosene and biofuels decreases soot emissions by 50% [251]. An even larger reduction of soot emissions, up to 70%, can be obtained with a coal-based fuel with the Fischer-Tropsch process [47]. Such reduction of the artificial aerosol quantities could reduce the quantity of ice crystals observed within contrails [252,253]. Experimentally, a reduction of 50% of the soot quantity lead to a reduction in the number of ice crystals from 45% to 75% [47]. These results have been confirmed by in-situ measurements, showing that the burning of low aromatic fuels can result in a 50 to 70% reduction in soot and ice number concentrations [254]. Combined with an increase of their size, which lead to a more rapid sedimentation, such large soot reduction will reduce the radiative forcing of contrails up to 50% [255]. On the other hand, other AEC, such as hydrogen, can also be considered to reduce artificial aerosol emissions. However, the burning of hydrogen will release a high quantity of water vapor [256]. The G-factor, used in Eq. (5), which gives an estimation of the potential formation of contrails (but not on their persistence), will be increased by a factor 2.6 compared to kerosene engine (considering the same value for the overall efficiency). As a consequence, the probability to create contrails with liquid hydrogen is largely increased. A recent work also suggests that the probability of persistent contrails, which can be precursors of induced cirrus, could be increased up to 30% [245]. However, the life duration of these persistent contrails induced by the burning of hydrogen could be reduced compared to kerosene, so their impact on climate remains uncertain. There is thus a lack of consensus in the literature about the potential of hydrogen to decrease the warming impact of contrails and induced-cirrus on climate [256].

6.2.3. Other levers

Other levers are also investigated. For example, from an operational point of view, recent advances have been achieved to take advantage of the saturation effect, when contrails of two or more aircraft compete for available atmospheric water vapor in close proximity. In that context, formation flights could reduce significantly the contrail persistence as well as fuel consumption [257–259]. Moreover, solutions also probably exist at the aircraft level to reduce the lifetime of contrails. Acting on the wingtip vortices, thanks to an early triggering of the natural Crow instability [260,261], could help to accelerate the dispersion of contrails. This can be done for example through a deflection of the aircraft ailerons at the appropriate frequency [262] or by injecting a disturbance in the vicinity of the vertical tail [263].

6.3. Conclusion

As a conclusion, several mitigation strategies and levers have already been proposed in the literature to efficiently reduce the impacts of non-CO₂ effects, especially regarding the formation and persistence of contrails. However, significant uncertainties remain, especially regarding weather predictions and climate impact of some mitigation levers. The reduction of these uncertainties and their better integration in the trajectory optimization strategy are challenging but are also key priorities that could allow major reductions of non-CO₂ effects. These promising strategies should then demonstrate their full potential in-situ. If successful, an important reduction of these effects on climate could be an achievable target.

7. Literature overview of aviation transition scenarios

If current trends were to continue, aviation could emit around 35 GtCO₂ between 2022 and 2050,²⁰ representing almost 10% of the carbon budget for limiting the temperature increase to 1.5 °C with 67% chance (see Table 1). According to other estimates [265], aviation could account for 22% of global CO₂ emissions in 2050 under such trends. Moreover, CO₂ effects are only a minor share of aviation climate impact, as seen in Section 2. It is therefore clear that aviation CO₂ emissions, and more generally its climate impacts, need to be addressed.

Prospective scenarios including socio-economic, environmental and/or technological aspects are relevant tools to explore and assess possible futures [266]. Such scenarios can use a forecasting approach, where trends are set and scenarios are considered to assess their consequences, or a backcasting approach where a target is set, and scenarios compatible with this target are identified. They can rely on technological levers of action but also on various political and socio-economic levers (economic measures, air traffic regulation...).

The objective of this part is to provide a general overview of prospective scenarios for aviation in the context of climate issues. We first present in Section 7.1 the institutional and industrial targets in terms of climate impact mitigation that have been proposed in recent years. We then analyze in Section 7.2 the scenarios that have been studied in relation with these objectives. A synthetic comparison of the various academic works is finally performed in Section 7.3, which discusses in particular the methodologies and evaluations of climate sustainability.

7.1. Institutional and industrial objectives

Between 2000 and 2021, at least 21 different sustainability targets have been set by institutional (ICAO and European Union) and industrial stakeholders [267]. More than half of these targets are set in terms of aircraft energy efficiency. However, as it has been discussed in Section 3 about historical evolution of Kaya decomposition, improving efficiency does not necessarily translate into a decrease in global impact because of the rebound effect. In the following, we present some global CO₂ emissions targets, summarized in Table 20.

In 2009, the civil aviation industry set three global goals to address its climate impact: a short-term efficiency improvement goal of 1.5% per annum, a mid-term goal to cap net CO₂ emissions through carbon-neutral growth, and a long-term goal to halve net aviation CO₂ emissions by 2050 compared with 2005 levels [268]. In 2021, this target was strengthened, with the air transport sector aiming in the “Commitment to Fly Net Zero 2050” declaration to reach carbon neutrality in 2050 [270].

²⁰ Number obtained by a rough graphical reading from ATAG Scenario 0: baseline/continuation of current trends [264]; in particular, traffic by +3.1% per year.

Table 20

Some institutional and industrial objectives concerning global CO₂ emissions. Sustainability targets in terms of energy efficiency or biofuel adoption are for instance reviewed in [267].

Organization	Year	Objective	Ref
ATAG	2009	Mid-term goal: mid-term goal to cap net CO ₂ emissions through carbon-neutral growth. Long-term goal: halve net aviation CO ₂ emissions by 2050 compared with 2005 levels	Mentioned in [268,269]
	2021	Carbon neutrality in 2050	[270]
ICAO	2010	Achieve a collective medium-term global aspirational goal of keeping the global net carbon emissions from international aviation from 2020 at the same level	[271, Resolution A37-19]
	2022	Achieve a collective long-term global aspirational goal for international aviation of net-zero carbon emissions by 2050	[272, Resolution A41-21]
European commission	2012	Reducing CO ₂ emissions by 75% per passenger and per kilometer in 2050 compared to 2000	[273]
	2022	Carbon neutrality in 2050	[274]
A4E, CANSO, ERA, ACI, ASD	2021	Carbon neutrality in 2050	[275]

Some of the industry objectives were adopted shortly thereafter by the ICAO. During its 37th assembly in September/October 2010, the ICAO assembly adopted the resolution A37-19 that defines the “mid-term aspirational goal of keeping the global net carbon emissions from international aviation from 2020 at the same level” [271], while during its 41st assembly in October 2022, the ICAO assembly adopted the resolution A41-21 which, in addition to the target of carbon-neutral growth, defines a “long-term global aspirational goal for international aviation (LTAG) of net-zero carbon emissions by 2050” [272]. In-between, ICAO adopted in 2016 CORSIA (Carbon Offsetting and Reduction Scheme for International Aviation), a carbon offset scheme for emissions above the 2019 level [276].

The previous targets were set at the global level (restricted to international aviation for ICAO) but regional targets have also been proposed. For instance, at the European level, the High-Level Group on Aviation Research of the European Commission proposed in 2012 a technological target of reducing CO₂ emissions by 75% per passenger and per kilometer in 2050 compared to 2000 [273]. Later, the Advisory Council for Aviation Research and Innovation in Europe (ACARE), which is a public–private partnership that aims to improve the competitiveness and sustainability of the European Union in the field of aeronautics, strengthened this objective to carbon neutrality by 2050 for European air transport [274]. This objective is consistent with the more recent commitments defined by European aviation industry associations. Concerning offsetting schemes, the European Union has adopted a more proactive policy for intra-European flights through its Emissions Trading System (EU-ETS) [277] in addition to CORSIA. Initial work on the integration of non-CO₂ effects in the EU-ETS framework has also been published [278].

Moreover, other issues are addressed and targeted, particularly concerning the use of alternative energy carriers. For instance, a roadmap to promote the emergence of SAF has been drawn up by the European Union through the ReFuelEU initiative [279]. Targets for the integration of AEC into the fleet have been set for drop-in fuels, although the integration of hydrogen is also studied. For example, the objective proposed by the European Parliament is that SAF should represent 6% of aviation fuels in 2030 and 85% in 2050.

7.2. Analysis of prospective scenarios

In this section, an analysis of prospective scenarios for air transport is achieved. Scenarios from institutional, industrial and private stakeholders are briefly mentioned in Section 7.2.1, whereas academic scenarios are then discussed in details, distinguishing scenarios focusing only on CO₂ effects (Section 7.2.2) and those including non-CO₂ effects (Section 7.2.3).

7.2.1. Scenarios from institutional, industrial and private stakeholders

Many institutional, industrial and private stakeholders proposed prospective scenarios for the evolution of CO₂ emissions from air transport. In these different reports, various technological, operational, energy and economic levers of action are considered.

For institutional and industrial stakeholders, prospective scenarios are often used to support various targets set. The Air Transport Action Group (ATAG) for instance published different scenarios in its report *Waypoint 2050* [264] in order to reach carbon neutrality in 2050. The use of sustainable aviation fuels represents the major lever of action for reducing CO₂ emissions in these pathways. Similarly, ICAO published a report on the feasibility of long-term aspirational goal (LTAG) for reducing CO₂ emissions from international civil aviation [280]. Several scenarios are proposed and are given in Fig. 31. It is interesting to note that their cumulative CO₂ emissions are compared to carbon budgets. This report contributed to the recent adoption of the objective of carbon neutrality for international flights by 2050 at the ICAO Assembly 41st Session in 2022. At the European level, the report *Destination 2050* [275] offered similar analyses, with specific assessments of the effect of technological and economic measures on demand.

Finally, studies have also been carried out by non-governmental organizations such as the International Council on Clean Transportation (ICCT). In its report *Vision 2050 - Aligning aviation with Paris Agreement* [281], the ICCT analyzed four pathways using the PACE model for evaluating future global aviation CO₂ emissions. As for ICAO LTAG report, cumulative CO₂ emissions of different scenarios are also compared to carbon budgets.

7.2.2. Academic scenarios only focused on CO₂ effects

Prospective scenarios for the aviation sector have been considered in the scientific literature since at least 1998 [282] and the number of publications has been increasing in recent years. Similarly as for the institutional, industrial and private stakeholders, various climate impact mitigation levers of action are considered. We begin this literature review by discussing studies focusing on CO₂ emissions alone.

In a 2005 paper and then in his doctoral thesis in 2011, Åkerman [283,284] concluded on the need to stabilize the number of flights per inhabitant to levels slightly higher than those of the 2000s, to limit atmospheric CO₂ concentration to 450 ppm. To reach this conclusion, he considered that the aviation sector is allocated its grandfathering share of 2.7% of the total carbon budget, which thus corresponds to the aviation sector’s contribution to CO₂ emissions in 2000. The scenarios considered do not include disruptive innovation such as a flying wing or hydrogen engine, but rather assumes a reduction in flight speed combined with a massive conversion of the fleet to turboprop. Åkerman justifies this choice by the level of risk: such a scenario has very high feasibility unlike scenarios based on disruptive innovations.

In 2010, Mayor and Tol [285] used a model for projecting by region the tourist numbers and CO₂ emissions from international tourism.

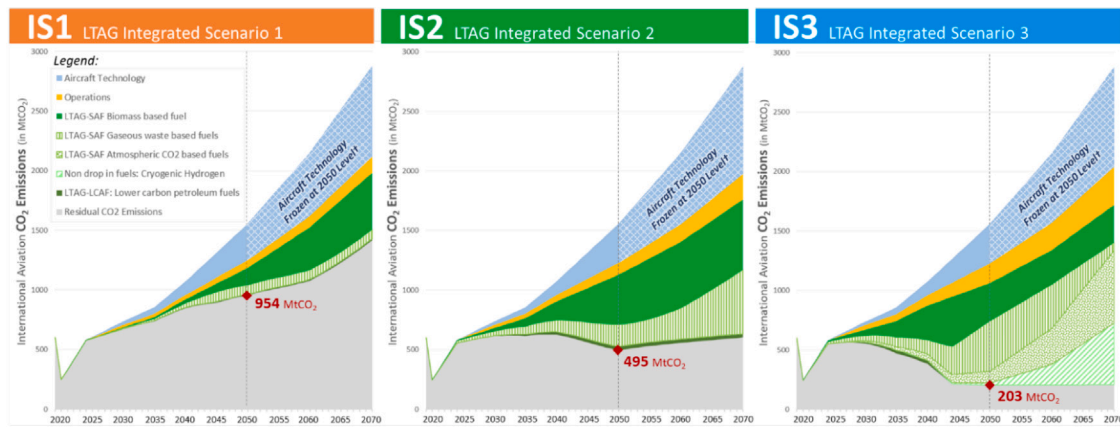

Fig. 31. LTAG Integrated Scenarios [280, Figure 1].

They showed a future increase in terms of trips number but also distance traveled. Several technological, economic and political scenarios are then tested to evaluate CO₂ emissions until 2100. In each scenario, they increase at least until 2050 and then decrease due to lower traffic growth.

Still in 2010, Owen et al. [286] considered five different scenarios based on the IPCC Special Report on Emissions Scenarios and on technology targets of ACARE that determine the evolution of traffic growth and of technology. They computed the evolution of CO₂ emissions, which grow between 2000 and 2050 by a factor in the range of 2.0 and 3.6 depending on the scenario.

In 2012, Gudmundsson and Anger [287] performed a meta-analysis based on 30 different scenarios (including those of [282,286] discussed above), with annual air traffic growth rates between 1.2% and 4.6%. They concluded that incremental technological improvements do not make it possible to lower emissions from the aviation sector by 2050 below their year 2000 level. The only scenario with traffic growth meeting this reduction target implies major disruptive innovation with the advent of hydrogen as energy carrier.

More recently, the work by Terrenoire et al. [288] evaluated different scenarios in terms of temperature by 2100, but only focusing on CO₂ emissions. For instance, an ICAO pre-COVID scenario is considered, based on a 4.6% increase in air traffic per year and an improvement in energy efficiency of 2% per year. In this case, by comparison with the temperature rise of the IPCC RCP2.6 reference scenario [289], the authors show that the contribution of CO₂ emissions from aviation to anthropogenic warming over the period 1940–2100 would be 5.2%. Therefore, the contribution of aviation to global warming is likely to increase significantly by 2100 with this ICAO scenario. Among all the scenarios studied by Terrenoire et al. the most ambitious one presumes a linear reduction in emissions from 2020, to reach half of the 2005 emissions by 2050 (the 2009 industry target). However, the mechanisms leading to such a decrease are not specified. According to this scenario, the contribution of CO₂ emissions from aviation to total anthropogenic warming by 2100 would only be 1.9%, which would constitute a net reduction compared to the past 1750–2011 period.

7.2.3. Academic scenarios including non-CO₂ effects

Extending the analysis of prospective scenarios to account for non-CO₂ effects enable to achieve exhaustive analyses of the impact of scenarios in terms of temperature and comparison with climate objectives, but requires the development of specific methodologies. These methodologies will be discussed in more details in Section 7.3.2. Works trying to extend the analysis beyond CO₂ date back to at least 2000 with Sausen and Schumann [42] including the effect of NO_x emissions. In the following, we will review the most recent papers which account for CO₂ and non-CO₂ effects. As it will be seen, most of the papers that focus on these themes are relatively recent.

In 2006, Ponater et al. [256] carried out a detailed analysis of scenarios with a transition to a fleet entirely powered by hydrogen, with a detailed account of the radiative forcing from CO₂, contrails, water and NO_x (through the impact on ozone and methane). Retrospectively, their scenarios relied on very optimistic assumptions: cryoplanes started to be introduced into the fleet as soon as 2015 for replacing the whole fleet and the CO₂ emissions due to the hydrogen production were neglected. A climate impact reduction of between 15% to 50% in terms of radiative forcing by 2050 was found, with a best estimate near 30% in case of a swift transition. Given the optimistic assumptions underlying this result, this suggests that hydrogen will actually only have a marginal impact on the mitigation of aviation climate impact by 2050, which was for instance confirmed by a recent ICCT study [281]. However, the results of Ponater et al. [256] suggest more significant mitigation gains beyond 2050.

Ivanovich et al. [290] proposed scenario analyses for international shipping and aviation. For air transport, business as usual scenarios could lead to an increase in temperature greater than +0.03 °C between 2020 and 2100, which would compromise the objectives of the Paris Agreement. The authors highlight the fact that stringent mitigation measures may limit this climate impact, and even lead to a temperature decrease of −0.02 °C between 2020 and 2100. However, contrails are not modeled in this paper and are only studied quantitatively. Moreover, the models used to assess the current climate impact of NO_x emissions from aviation provide results that differ from all aviation-specific studies. Indeed, a net negative radiative forcing (leading to a cooling effect) is obtained when estimating their current impact on climate whereas, even if the magnitude is subject to debate [49], there is a consensus that aviation NO_x emissions currently have a net warming effect. This can be explained by the fact that in [290], ground level and not upper air models are used.

Gössling et al. [291,292] studied different pathways to low-carbon air transport. Based on specific models for COVID-19 recovery, fuel cost and elasticity, authors show that air transport demand will continue to grow, but slower than previous forecasts. They also question the long-term business model particularly due to the production capacity and higher cost of biofuels and electrofuels. In this study, non-CO₂ effects are taken into account through a simple model by applying a multiplicative coefficient to CO₂ emissions.

Grewe et al. [293] evaluated the climate impact of different scenarios for aviation in light of the targets of the Paris Agreement, including all climate effects of aviation. Using climate models and considering an allocation to aviation of 5% of the temperature targets from the Paris Agreement, they are able to evaluate the sustainability of scenarios for aviation. They especially conclude that it is little likely that industrial objectives reach the Paris Agreement targets. This result is similar to that from the recent report by Lee [294] which concludes that the 2010 ICAO's carbon neutral growth target is incompatible with the

Paris Agreement. Grewe et al. also consider more ambitious objectives proposed by the ACARE at the European level and show that they can be compatible with the Paris Agreement targets. Finally, the authors analyze the technological hypotheses on which the ACARE's scenarios are based, and conclude that these objectives will probably not be reached, thus bringing the feasibility of these scenarios into question.

Planès et al. [63] analyzed the compatibility of a number of scenarios with the Paris Agreement targets using AeroMAPS (formerly CAST), an open-source numerical tool which simulates prospective scenarios for aviation and evaluates their climate impact [295]. By allocating a carbon budget to aviation, it is therefore possible to estimate whether the scenarios studied exceed the allocated carbon budget or not. A similar approach including non-CO₂ effects is also described in the paper. The authors show that a trade-off between air traffic evolution and carbon budget allocation for aviation is required for meeting the most ambitious climate targets. AeroMAPS is regularly updated with new models (e.g. fleet renewal [115]), new issues (e.g. availability of energy resources [296]) or new modules (e.g. economic analysis on alternative fuel cost [297]).

A recent publication by Klöwer et al. [298] studied the impact of air traffic on temperature. They start their analysis in 2021, considering that temperature has already increased by +1.2 °C which leaves 0.3 °C to 0.8 °C to stay within a 1.5 °C to 2 °C target of the Paris Agreement. The authors conclude that if air traffic resumes its pre-COVID path, then aviation will be responsible for between 6 and 17% of these +0.3 to +0.8 °C. They therefore highlight two scenarios for stabilizing the impact from aviation in terms of temperature: massive introduction of low-carbon fuels which decreases carbon intensity by 90%, or a traffic decline of 2.5% per year, both measures which decrease the radiative forcing of non-CO₂ effects. Concerning the decrease in traffic, it could only be temporary to give the aviation sector time to develop sustainable technological solutions.

Brazzola et al. [98] proposed different definitions of climate neutrality for aviation and analyzed multiple scenarios from this perspective. The authors show that only reaching carbon neutrality, using CO₂ mitigation and CO₂ removal strategies, is not enough to limit the global warming induced by aviation, and that non-CO₂ effects also need to be mitigated. For instance, they consider the use of zero-carbon fuel and zero-emission aircraft which facilitates the transition of the aviation sector for both CO₂ and non-CO₂ effects. Indeed, in the worst case scenario, aviation could contribute to a temperature increase of more than 0.4 °C by 2100, which would jeopardize compliance with the Paris Agreement. Nevertheless, other scenarios with aviation-demand growth that are more technologically ambitious, but also more uncertain, could limit the temperature rise to levels comparable to that induced by aviation in the IPCC SSP1-1.9²¹ scenario.

Dray et al. [62] analyzed emission pathways that also include cost consideration. The scenarios studied lead to a reduction in CO₂ emissions of around 90%, despite a traffic growth of between 2.4% and 4.1% per year. For the middle demand scenarios with an annual traffic growth rate of 3.7%, cumulative CO₂ emissions would reach between 28.0 and 42.3 GtCO₂ for scenarios based on alternative energy carriers, corresponding to an embarked energy consumption of between 12.9 and 25.6 EJ. However, the mitigation of non-CO₂ effects is more limited in the different scenarios, leading to CO₂-equivalent emissions decrease between 46% and 69%. From an economic point of view, the integration of low-carbon fuels would lead to an increase in costs with necessary investments of between US\$0.5 and US\$2.1 trillion. This would generate a limited increase in ticket price, 15% higher than in the trend scenario.

²¹ The SSP1-1.9 corresponds to an IPCC scenario used in AR6. In this very low GHG emissions scenario, where carbon neutrality is reached around 2050, the temperature increase peaks at 1.6 °C by 2050 before decreasing thereafter.

Lastly, Bergero et al. [60] also analyzed aviation net-zero pathways. These scenarios are a mix of three sub-scenarios on the evolution of demand and efficiency, and three sub-scenarios on the evolution of the carbon intensity of fuels used. The authors show that with a moderate growth of 1% per year in demand, a large amount of SAF would be required to reach net-zero CO₂ emissions without ambitious improvements of aircraft efficiency. They also perform economic analyses on the cost of alternative fuels and carbon dioxide removal, as well as specific studies on non-CO₂ emissions.

These different results corroborate the fact that the aviation sector is considered as hard-to-abate, i.e. difficult to decarbonize. This is the reason why offsetting schemes such as CORSIA or EU-ETS have been enforced to make up for the difference between the set target and the reduction in emissions actually reached in 2050 [299]. Specific research then focused on the evaluation of these schemes [300]. The study by Scheelhaese et al. [301] compared the two mechanisms and shows that the European system would be more effective than the ICAO offsetting system until 2035 if it was applied by all the countries signing CORSIA. Because this scenario is considered to be little likely, the authors conclude that the best compromise for the European Union would be to keep the EU-ETS for intra-community flights and to apply CORSIA for flights outside Europe. A report by the European Commission comparing the two schemes concluded that “a certain number of characteristics of CORSIA imply that its level of ambition for the international aviation sector is not aligned with the global level of ambition required to meet the temperature targets of the Paris Agreement, and that it is lower than those targets” and that “participating in CORSIA — and leaving all international aviation (as defined by the ICAO, including between EEA countries) outside the scope of application of the EU-ETS — runs the risk of compromising these targets and weakening the EU's current climate policies” [302].

7.3. Comparison of recent academic studies

As shown previously, the academic literature on air transport prospective scenarios has flourished in recent years. In order to understand the interests and weaknesses of these different studies, a comparison is achieved by focusing on the most recent articles integrating the evaluation of non-CO₂ effects and/or temperature evaluations.

7.3.1. Aviation climate sustainability assessment

In this first section, the objective is to compare the various methodologies used to assess the compatibility of aviation transition scenarios with the Paris Agreement, which corresponds to one of the main objectives of this paper. These climate analyses can focus on CO₂ emissions or integrate all the climate impacts of aviation.

Carbon budget targets and carbon-neutral aviation.

Assessing the climate sustainability of a prospective scenario only taking into account CO₂ effects allows to simplify the approach. Indeed, the vast majority of the papers dedicated to air transport prospective provide data on CO₂ emissions, which are relatively simple to calculate. In this approach focused on CO₂ emissions, two types of evaluation are possible.

On the one hand, one way to account for emissions from aviation stemming from a particular scenario is to estimate the corresponding cumulative emissions and compare them to a given carbon budget. Many recent works have adopted this approach. For instance, the 2022 report of the ICAO committee on aviation environmental protection computes the cumulative emissions of international aviation for three transition scenarios and compare them to different carbon budgets [280]. Concerning recent academic works, Planès et al. [63] use for instance the same methodology considering the whole aviation sector, and not only international aviation. However, if cumulative emissions are computed and compared to a carbon budget, we are not aware of any work that tackles the question of defining a fair share

of the carbon budget allocated to the (international) aviation sector. For instance, the cumulative emissions in the ICAO's LTAG scenarios represent between 1.4% and 11.3% of the carbon budget, depending on the assumptions made and the carbon budgets considered. However, ICAO does not conclude on whether these numbers are compatible or not with the Paris Agreement, precisely because no fair share is defined [280]. In [63], the authors see the share of the carbon budget allocated to the aviation sector as a variable for which they perform a sensitivity analysis. They use the grandfathering allocation as a reference, but do not discuss the fairness of this allocation.

On the other hand, besides considering cumulative emissions and carbon budgets, another approach to assess the compatibility of future aviation CO₂ emissions with the Paris Agreement is to look at net-zero CO₂ emissions or carbon neutrality.²² This second approach is natural because, as mentioned above, carbon neutrality at the global scale needs to be reached in order to fulfill the goals of the Paris Agreement. This is for instance the approach adopted by Bergero et al. [60] who look for net-zero emission pathways for the aviation sector. Note that, in order for the aviation sector to reach carbon neutrality or net-zero CO₂ emissions, either the fuel carbon intensity needs to reach zero, or atmospheric carbon dioxide removal techniques need to be considered. The main problem with this approach is that it focuses on achieving net-zero CO₂ and not on the trajectory of CO₂ emissions, whereas it is the cumulative emissions that count for the climate impact.

Note finally that these two approaches, considering cumulative emissions and carbon neutrality or net-zero CO₂ emissions, are complementary and can be considered together.

Temperature targets and climate-neutral aviation.

Another problem for evaluating the compatibility of aviation transition scenarios with the Paris Agreement is that CO₂ emissions only account for a minor part of aviation climate impacts. For this reason, as mentioned previously, many works have estimated the full climate impact of aviation transition scenarios, including non-CO₂ effects. In this case, the impact is typically quantified in terms of effective radiative forcing or in terms of temperature.

Most works estimate the temperature impact of a given pathway and compare them to the objectives of the Paris Agreement (usually, +1.5 and +2 °C). However, they do not conclude on the compatibility of the trajectory with the Paris Agreement for the same reasons as above, namely, no fair share has been defined, see for instance [288,290]. Two noticeable exceptions can be mentioned. On the one hand, in [293], a share of 5% of the global temperature increase is allocated to the aviation sector to decide whether the trajectory is compatible or not with the Paris Agreement. However, this share is taken because it is the contribution of the aviation sector in the recent temperature increase: in other words, the authors adopt the grandfathering approach. On the other hand, in [298], the authors seek to stabilize temperature at 2019 levels, which corresponds to a share of 0% of the remaining temperature increase and to a share of 2% of the global temperature increase for the objective of +2 °C. This assumption corresponds here to arbitrary choices of objectives.

To go further regarding the climate objectives of aviation, it may be interesting to translate the concept of carbon neutrality in terms of climate neutrality. We use here the terminology of the papers that we review. However, note that the IPCC avoids the term "climate neutrality" because "the concept of climate neutrality is diffuse, used differently by different communities, and not readily quantified" [303, Cross-Chapter Box3]. For instance, in [98], the authors propose the following three definitions of climate neutrality for the aviation sector:

Gold definition: all aviation climate effects are down to net zero after 2050;

Silver definition: aviation forcing is the same as the aviation forcing in the SSP1-1.9 scenario;

Bronze definition: aviation forcing remains constant after 2050.

In the Gold and Bronze definitions, 2050 plays a particular role as it is assumed that this is the date at which climate neutrality is achieved at the global scale. In the Silver definition, the authors justify the choice of the SSP1-1.9 scenario as a reference scenario because it limits global warming to +1.5 °C (in this scenario, the temperature increase in 2100 due to aviation is around +0.04 °C [98]). However, as explained above, this choice corresponds to a particular allocation which relies on ethical premises which are not discussed. Moreover, the authors calculate the levels of CO₂ removal required to offset the residual emissions overshooting the different climate neutrality targets. Lastly, similar issues on net-zero climate impacts are studied in [60,62] where non-CO₂ effects are converted into equivalent CO₂ emissions.

7.3.2. Prospective scenario simulation and evaluation

In this second section, the different methodologies used for simulating and evaluating air transport prospective scenarios are described. Table 21 provides a synthesis of the major methods used in the different papers. The climate sustainability assessment methodologies discussed in Section 7.3.1 are also given.

First, in terms of modeling of mitigation levers, different levels of complexity are considered. For instance, for evaluating the air traffic evolution, most of the papers rely on the use of fixed annual growth rates. However, Grewe et al. [293] use specific data based on [304] whereas Dray et al. [62] use a detailed assessment based on AIM2015, an integrated aviation systems model which simulates the behavior of the air transport ecosystem in order to assess the evolution of air traffic according to different scenarios [305,306]. Similarly, concerning the evolution of the fleet energy efficiency, two main approaches are adopted. On the one hand, top-down approaches allow to simply model the evolution of efficiency by setting annual gains for the entire fleet. On the other hand, a more detailed modeling is obtained by a bottom-up approach where the fleet energy efficiency evolution is a result of assumptions on fleet renewal and efficiency gains by aircraft architecture.

Secondly, the climate models used in these references for taking into account non-CO₂ effects differ. Indeed, some papers only estimate equivalent CO₂ emissions for non-CO₂ effects thanks to simple climate metrics such as GWP and GTP [307]. Others calculate equivalent CO₂ emissions with GWP* which is more suitable for Short-Lived Climate Forcers (SLCFs) [308–310]. For estimating the impact of aviation on temperature, several methods are used. The first one is to simply estimate the temperature from cumulative equivalent emissions using the TCRE coefficient. Then, simple climate models such as OSCAR [311], MAGICC [312,313] and FAIR [314,315] can be used. Finally, two papers rely on dedicated climate models for aviation: AirClim [316] and APMT-IC [317,318]. These different climate models enable to achieve sustainability analyses, the modalities of which vary according to the references: net-zero emissions, temperature or carbon budget allocation, or temperature stabilization.

Lastly, we note that additional analyses are sometimes performed. For instance, we can see on Table 21 that energy consumption is estimated in some scenarios and compared to biomass or electricity availability, and some references also provide dedicated framework for assessing economic studies such as fuel cost or airfare estimates. Moreover, scenario modeling as well as climate and specific analyses are sometimes based on open-access or open-source references. For instance, Planès et al. provide a complete framework to perform these studies using a dedicated tool (AeroMAPS, formerly CAST). Some climate codes as well as the integrated aviation systems model AIM2015 are also available.

²² When they are used at the scale of a region or a business sector, carbon neutrality and net-zero CO₂ emissions are distinguished in IPCC AR6. The difference lies in different boundaries in the emissions and removals being considered [303, Cross-Chapter Box 3].

Table 21
Comparison of the main references providing modeling and assessment of air transport prospective scenarios.

Main references	Mitigation levers of action modeling					Climate models and analyses				Other analyses		Data and tools			
	Model complexity	Traffic	Energy intensity	Carbon intensity	Others	CO ₂	Non-CO ₂	Non-CO ₂ equivalent emissions estimates	Temperature estimates	Sustainability assessment	Energy resources	Economy	Dedicated available tools	Associated available tools	Data availability
Terrenio et al. (2019)	+	Fixed annual growth rates	Top-down	Not directly considered	Carbon neutral growth and linear reduction modeling	x			Simple climate model (OSCAR v2.2)	Comparison with IPCC RCP scenario temperatures				OSCAR v2.2	Private
Ivanovich et al. (2019)	+	Fixed annual growth rates	Not directly considered	Not directly considered	Carbon neutral growth and linear reduction modeling	x	(x)	No estimate	Simple climate model (MAGICC6)	Comparison with climate targets in terms of temperature				MAGICC6	Private
Gossling et al. (2021, 2022)	++	Fixed annual growth rates per region	Top-down	Zero-carbon fuels	Cost elasticity	x	x	Multiplicative coefficient	No estimate	Achievement of net-zero CO ₂ emissions	Resources consumption	Fuel cost and airfare estimates			Private
Grewe et al. (2021)	++(+)	Fixed annual growth rates by year	Top-down / Bottom-up	Representative low-carbon fuels	Non-CO ₂ mitigation linked to fuels	x	x	No estimate	Dedicated climate model (AFClim)	Comparison with a fixed temperature allocation					Zenodo repository (Excel)
Planès et al. (2021) and others	+++	Fixed annual growth rates by decades and markets	Top-down / Bottom-up	Representative and detailed low-carbon fuels	Independent non-CO ₂ mitigation	x	x	GWP*	TCRE coefficient	Comparison with variable (equivalent) carbon budget allocations	Resources consumption + Comparison	Fuel cost estimates	AeroMAPS (formerly CAST)		Directly on AeroMAPS
Klöwer et al. (2021)	++	Fixed annual growth rates	Included by lowering annual growth rates	Zero-carbon fuels	Non-CO ₂ mitigation linked to fuels	x	x	GWP*	Simple climate model (FAIR v1.3) / TCRE coefficient	Comparison with remaining temperature increase / Temperature stabilize at 2019 levels				FAIR v1.3	Zenodo repository (Excel/Supper Notebooks)
Brazzola et al. (2023)	++	Fixed annual growth rates by year	Top-down	Zero-carbon fuels	Non-CO ₂ mitigation linked to fuels	x	x	GWP*	Simple climate model (FAIR v1.3)	Comparison with IPCC SSP1.19 scenario for studying different definitions of climate neutrality				FAIR v1.3	GitHub repository (Excel/Python files)
Dray et al. (2022)	+++	Variable annual growth rates	Bottom-up	Detailed low-carbon fuels	Cost elasticity + Non-CO ₂ mitigation linked to contrails avoidance	x	x	GWP	Dedicated climate model (APMT-IC)	Achievement of net-zero climate impacts	Resources consumption	Fuel cost and airfare estimates based on an integrated aviation systems model (AIM2015)		AIM2015	Private
Bergero et al. (2023)	++	Fixed annual growth rates	Top-down	Representative low-carbon fuels		x	x	GWP/GTP	No estimate	Achievement of net-zero CO ₂ emissions and climate impacts with CDR	Resource consumption and associated hectares + Comparison	Fuel cost estimates			Private Excel

7.3.3. Scenario assumptions and results

In this last section, the different assumptions for defining the air transport prospective scenarios as well as the results obtained are compared. They are gathered in Table 22 for the main references, except for [288,290] which do not take into account all the non-CO₂ effects, and for [98] which does not directly separate efficiency and fuel decarbonization gains.

On the one hand, the assumptions considered in the different scenarios are relatively similar. For the air traffic evolution, most studies consider an annual growth rate of between 2 and 4%. Only two papers consider the case of traffic decrease for achieving some analyses [63, 298]. In terms of energy efficiency (including load factor and operation improvements), annual gains between 1 to 2% are used most of the time, which is consistent with figures obtained in Section 4.3. The highest values considered correspond to extreme cases for which the technical feasibility is not guaranteed [60]. Finally, for comparing the fuel decarbonization in different scenarios, we introduce the concept of fleet decarbonization rate. It corresponds to the reduction of carbon intensity of the entire fleet compared to one of a similar fleet only using kerosene. All studies use scenarios without alternative fuels for comparison, i.e. a fleet decarbonization rate of 0%. Except for Grewe et al. [293] (due to a simplified construction of the model), values between 75% and 100% are considered by 2050. This last value is a theoretical value for which zero-emission fuel is assumed, which can be questioned by considering the whole life cycle of alternative fuels (see Section 5).

On the other hand, by using the main methodologies detailed in Section 7.3.1, the results on climate sustainability assessment can be compared in terms of carbon budget consumption or temperature increase depending on the data available. It is interesting to note that the different aviation scenarios studied in these papers would consume between 2.2% and 13.8% of the global carbon budget for +1.5 °C. These values can be compared to the grandfathering share of around 2% to 3% used depending on references. As a consequence, most scenarios result in a carbon budget consumption higher than this allocation. For analyses in terms of temperature, results of the same order of magnitude are obtained.

8. Opening discussions

The present review has mainly focused on technological levers to mitigate the climate impact of aviation. We now broaden the discussion to address other important elements of aviation transition scenarios. In Section 8.1, representative technological scenarios are considered in order to obtain insight into the influence of traffic evolution and of global and aviation climate objectives. In Section 8.2, a brief discussion concerning the availability of energy resources in aviation transition scenarios is performed. Then, the impacts that climate change can have on air transport, which are related to adaptation issues, are addressed in Section 8.3. Finally, possible pitfalls of prospective scenarios are discussed in Section 8.4.

8.1. Influence of traffic evolution and of global and aviation climate objectives

So far, we mainly focused on the technological levers of action and their place in the prospective scenarios for air transport. In this section, we present some insight on the influence of other non-technological parameters, namely the air traffic evolution and the global and aviation climate objectives (see below for details). In order to keep the discussion short and focus on this insight, several simplifying assumptions are made. For instance, the analysis is restricted to CO₂ emissions, and only drop-in AEC are considered.

The calculations are performed with the AeroMAPS tool introduced in Section 7 [295]. For evaluating the climate sustainability, the methodology based on carbon budget mentioned in Section 7.3.1 is used. As a consequence, the global climate objective can be framed in terms of global carbon budget, and the aviation climate objective in terms of carbon budget allocated to aviation.

The methodology proceeds in two steps. More detailed information can be found in [61,63].

The first step of the methodology is to define three representative technological scenarios. The synthetic assumptions for their main high-level variables are given in Table 23. Scenario A is the most pessimistic:

Table 22

Comparison of prospective scenario assumptions and results for some main references. The asterisk indicates that the estimations have been performed on the reconstructed cumulative emissions of the references and using the carbon budgets given in Planès et al. [63].

Main references	Assumptions			Comparison of main results extracted from references			
	Traffic: compound annual growth (CAGR) rates until 2050	Energy intensity: mean annual efficiency gains until 2050 (including operations and load factor)	Carbon intensity: fleet decarbonization rates in 2050	Global objective considered	Consumption of the global carbon budget for +1.5°C over the period 2020-2050	Consumption of the global carbon budget for +2°C over the period 2020-2050	Comparison to temperature targets used in the references
Gossling et al. (2021)	[1.3% - 4.5%]	1%	[0% - 100%]	Carbon budget *	[2.3% - 9.7%]	[1.0% - 4.2%]	
Grewe et al. (2021)	2.7%	[0% - 3.8%]	[0% - 12%]	Temperature			Between 4.8 and 14.3% (respectively 3.6 and 10.7%) of the total temperature increase for +1.5°C (respectively +2°C) by 2100
Planès et al. (2021)	[-1.8% - 3%]	[1.3% - 2.3%]	[0% - 75%]	Carbon budget	[6.0% - 10.2%]	[2.6% - 4.5%]	
Klower et al. (2021)	[-2.5% - 3%]	1%	[0% - 90%]	Temperature			Between 0 and 17% (respectively 0 and 6%) of the remaining temperature increase for reaching +1.5°C (respectively +2°C) by 2050
Dray et al. (2022)	[2.4% - 4.1%]	1.3%	[0% - 100%]	Carbon budget *	[6.3% - 13.8%]	[2.8% - 6.0%]	
Bergero et al. (2023)	[1% - 4%]	[1% - 4%]	[0% - 100%]	Carbon budget *	[2.2% - 10.8%]	[1.0% - 4.7%]	

Table 23

Main technological hypotheses for the three representative scenarios.

Scenario	A	B	C
Annual improvement in aircraft energy efficiency between 2020 and 2050	1%	1%	1.5%
Average load factor in 2050	89%	89%	92%
Reduction in consumption via operations in 2050 compared to 2020	0%	8%	12%
Fleet decarbonization rate in 2050	0%	37.5%	75%
Result: emission factor in 2050 (gCO ₂ -eq/RPK)	89	52	17

it relies on trend improvements in aircraft efficiency and only considers the use of fossil kerosene. At the other extreme, scenario C is the most ambitious: it relies on advanced improvements on fleet efficiency and on the massive use of low-carbon drop-in AEC. For capturing the impact of this last lever of action, we use the concept of fleet decarbonization rate defined in Section 7.3.3. The fleet decarbonization rate of 75% in 2050 in scenario C could, for example, correspond to an entire fleet of aircraft using fuels that reduce life-cycle CO₂ emissions by 75%, or to 75% of the fleet using carbon-neutral fuels, and the rest of the fleet using fossil kerosene. In particular, it is important to keep in mind that the fleet decarbonization rate indirectly depends on the energy demand, as for instance a fleet decarbonization rate of 75% is more ambitious for a high energy demand. Ultimately, performance of these scenarios can be compared with the corresponding emission factor, expressed in gCO₂-eq/RPK, in 2050, with the most ambitious scenarios inducing lower emission factors.

These different technological scenarios can be justified by the values that have been discussed in the literature review performed in Sections 4 and 5. First, the annual improvements in aircraft energy efficiency lead to global fleet gains between 26% (scenarios A and B) and 36% (scenario C) by 2050 in comparison to current aircraft fleet, which is consistent with results provided in Section 4.3. Then, the fleet decarbonization rate can be compared with the values for the different AEC described in Section 5. We have seen that different drop-in AEC can lead to a significant decrease in the fuel carbon intensity: improved electrofuels from low-carbon electricity can lead to reduction above 90%, and some biofuels even lead to negative carbon intensity. Of course, it is not clear that these beneficial AEC will be available at the required scale, and so that fleet decarbonization rate up to 75% can be achieved: this is especially true if the energy demand grows significantly. Such issues will be briefly discussed in Section 8.2. Finally, concerning the improvements of the load factor and operations, which have only been briefly mentioned here, the assumptions are compared with industrial and institutional data. The values for operations are consistent with the data ranges of 0 to 15% for instance found in [264,280,319]. Similarly, the average load factor assumed in 2050 is of the same order of magnitude as that found in the ICCT *Vision 2050* report [281] and current data of some low-cost airlines.

Once the technological scenarios are defined, the second step of the methodology is to determine the last three variables, namely the air traffic evolution, the global carbon budget and the aviation carbon budget. In the following, two global carbon budgets are considered, namely the median carbon budgets for +1.5 °C and +2 °C. For the two remaining variables, they are accounted for via the air traffic annual growth rate and the share of the global carbon budget allocated to aviation. In order to study the influence of these two parameters, they are varied in pre-defined ranges: thus, a sensitivity analysis is conducted. Nevertheless, two reference values are assumed for facilitating the understanding of the analyses. For air traffic growth, a reference value of 3% per year is considered, corresponding to the order of magnitude of the forecasts provided by ATAG [264]. In terms of reference allocation for aviation carbon budget, the grandfathering approach is used for simplicity, leading to a reference allocated share of 2.6% as mentioned in Section 2.

Several analyses are thus performed. For these three representative technological scenarios, the maximum sustainable air traffic annual growth rate is calculated: this is the annual growth rate for which the cumulative emissions from aviation balance with its carbon budget by 2050. Fig. 32 summarizes the results. Quite expectedly, it can be seen that a more ambitious technological scenario (C compared to A for example) or a less restrictive climate target (+2 °C instead of +1.5 °C) leads to higher maximum sustainable growth rates.

For a climate target of +1.5 °C, allocating to aviation a larger share than the grandfathering share of 2.6% is necessary for maintaining or increasing air traffic, regardless of the representative technological scenarios considered. In the case of scenario C for instance, it would be necessary to allocate to aviation a share of roughly 6% to allow for an annual traffic growth of around 3%. The grandfathering share would lead to a strong decrease in air traffic in order to respect the allocated carbon budget for +1.5 °C.

For a +2 °C target, the results are slightly different. A decrease in air traffic is required for the least ambitious technological scenario A. However, for the most ambitious technological scenario C, growth in air traffic similar to the trend growth is conceivable by allocating the 2.6% grandfathering share to aviation. This corresponds to a traffic doubling between 2018 and 2050. Within scenario C, a stagnation or a slight

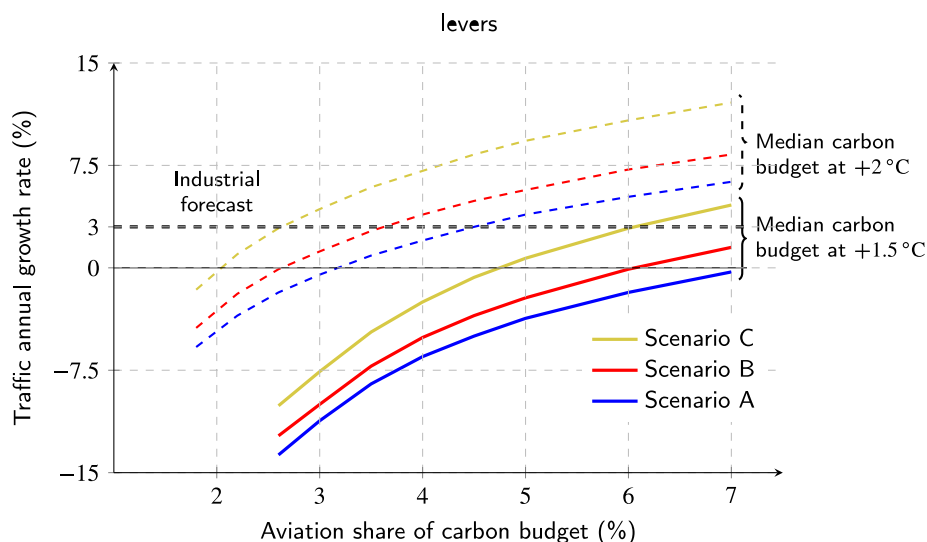

Fig. 32. Maximum sustainable annual air traffic growth rate as a function of the share of carbon budget allocated to aviation for the scenarios A, B and C and two different median carbon budgets at +1.5 °C (solid lines) and +2 °C (dashed lines). The vertical dotted line shows the grandfathering share of 2.6%, and the horizontal dotted line shows the 3% growth rate corresponding to industrial forecasts.

increase in traffic would even be possible by allocating a smaller share than the grandfathering share to aviation, thus leaving some room for maneuver to other sectors.

In a nutshell, for the more ambitious climate objectives, a trade-off between the level of air traffic and the carbon budget allocated to aviation is necessary. The previous analyses can be performed for different carbon budgets for considering other temperature targets. Moreover, the use of Carbon Dioxide Removal (CDR) technologies can also be included in the analysis, which would have the effect of increasing the net carbon budgets. Dedicated studies taking into account these aspects are provided in [61].

Nevertheless, some limits of these analyses have to be noted. First, only representative technological scenarios have been considered for achieving these studies. Even if the scenario assumptions are relevant and consistent with the literature review, multiple variants could be studied, notably concerning the deployment rates of aircraft and AEC. Then, these scenarios only consider CO₂ emissions for simplicity. Indeed, the integration of non-CO₂ effects requires the consideration of specific mitigation levers, the quantification of which remains complex, and it also requires the use of more complex adapted assessment methodologies. Finally, scenarios B and C require the use of low-carbon alternative drop-in fuels to supply the aircraft fleet. For each scenario, it is therefore necessary to evaluate the quantity of energy resources required for aviation and to compare this value with the expected global availability in 2050. A qualitative discussion of these energy issues is performed in the following section.

8.2. Energy consideration

Low-carbon AEC are key components of sustainable aviation scenarios. These AEC shift the energy demand from fossil kerosene to other sources of energy, namely electricity or biomass (see Table 6). For reference, before the COVID-19 crisis, aviation used 14.5 EJ of kerosene in 2019, which represented 2.4% of world total energy supply and 7.7% of oil supply [123]. As discussed in Section 5, the production pathways of these new AEC entail significant energy losses when converting the electricity or biomass into relevant energy carriers for aviation. The biomass and electricity intensity values reported in Table 24 allow to compute how much energy is needed to produce each AEC for a given scenario. Here, intensity is defined as the amount of input energy (in the form of biomass, oil or electricity) needed to produce 1 MJ of AEC. Note that for drop-in AEC, there may be co-products obtained together

Table 24

Biomass (respectively electricity) intensity refers to the amount of biomass (respectively electricity) needed to produce 1 MJ of AEC. For HEFA from oil, biomass is to be understood as oil. Note that for drop-in AEC, there may be co-products obtained together with this 1 MJ of alternative jet fuel. For drop-in AEC, we selected configurations with the highest yield of jet fuel (max selectivity, see Table 10), so these values can be seen as lower bounds. The high values for PBtL can be explained by the fact that the only reference available considers a plant with a low selectivity of 14%. Although this is not reported, FT and ATJ biofuels are net producers of electricity: see for instance [152,154] for FT and [158] for ATJ. This could be taken into account by considering negative intensity.

AEC	Biomass intensity	Electricity intensity	Ref
FT biofuel	3.1–5.6	–	[152,154, 156,173, 320]
HEFA biofuel from oil	1.1–1.7	–	[77,157, 173]
HEFA biofuel from biomass	1.3–2.7	–	[77]
ATJ biofuel	1.2–4.3	–	[158,173]
Electrofuel	–	3.3–5	[182,201]
PBtL	5.5	5.2	[200]
Liquid hydrogen	–	1.7–2.1	Table 16
Electric batteries	–	1.3	[225] (see Table 19)

with this 1 MJ of alternative jet fuel. As a consequence, selectivity has a strong influence on the value obtained for drop-in AEC. Except for PBtL where this was not possible due to lack of data, in Table 24, the values of intensity are computed for the maximum selectivity (see Table 10), and so these values should be considered as lower bounds corresponding to plants aiming at maximizing jet fuel output. Concerning biofuels, Table 24 shows that FT biofuels, which have been seen to be among the most promising in terms of CO₂ emissions reduction, are also the most energy intensive, which coincides with conclusions from the literature [321].

The computed energy demand can then be compared to forecasts of global energy availability, such as those presented in Fig. 33. It is interesting to see in this figure that in all scenarios, electricity production increases compared to current production, up to a factor close to three for the most ambitious scenarios. Concerning bioenergy,

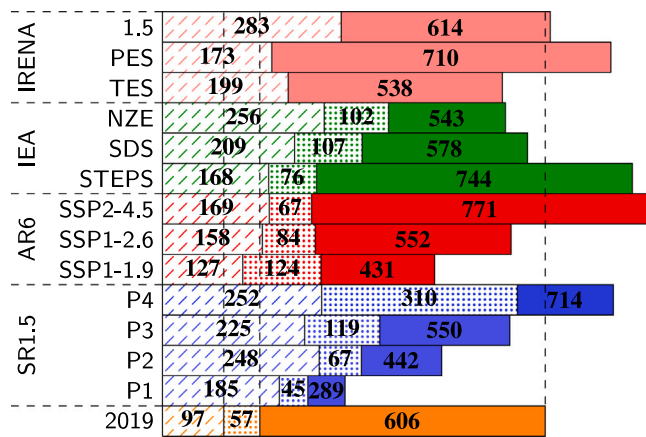

Fig. 33. The values correspond to the amount of electricity (dashed area), bioenergy (dotted area) and total primary energy (length of the entire bar, comprising all three colored areas) in 2050 for each scenario; values are expressed in exajoule. Bioenergy data for the IRENA scenarios was not found in [322], and thus not reported. Source: Data compiled from [1,322,323] and for [324] for the year 2019.

except for the IPCC P4 scenario, values lie in-between current values (57 EJ) and a twofold increase; and in most scenarios, global primary energy is lower than that of today, with only five scenarios (among those reported) leading to an increase in global primary energy.

These biomass and electricity intensities translate into an increased energy demand. Gains in energy efficiency (aircraft efficiency, operations, load factor) can alleviate this increase, but these gains may in turn be tempered in case of strong traffic growth, as it has been the case historically (see Fig. 8). Therefore, the question of energy availability needs to be considered. In that respect, the discussion concerning biomass and electricity is very different. Whereas a consensus exists on the limited physical availability of bioenergy because of its strong impact on land use, electricity production is more often considered to be limited by investment costs and deployment rates, rather than physical constraints. However, deployment rate for aviation biofuel may also restrict its availability [173]. In the following, biofuel and electricity availability are discussed.

8.2.1. Biofuel availability

In 2018, 154 billion liters of biofuel were produced, of which 15 million liters for aviation²³ [326]. These 15 million liters represented 0.004% of the aviation energy consumption in 2018, which highlights the industrial challenge to develop aviation biofuel at a significant level. Projections of future aviation biofuel production can either rely on a backcasting approach where scenarios are designed in order to reach a pre-defined level (this is for instance the case in [264]), or on a forecasting approach. Some estimates of biofuel availability at the world level in 2050 are provided in Table 25. However, given the current level of production which is extremely low, such projections should be taken with care.

For instance, Staples et al. [173] try to estimate the amount of aviation biofuel available in 2050 by applying three successive assumptions on: 1/ the total available bioenergy, 2/ the price of bioenergy (which governs the proportion of primary bioenergy and waste resources that become effectively available for biofuel production) and 3/ the share of available feedstock that is converted to aviation biofuel, as opposed to other potential end uses such as electricity or heat generation, road and marine transportation fuels, or bio-chemicals. One of their results is that under the most optimistic assumptions (in particular, aviation

²³ This is the IEA estimate, whereas ICAO reports a smaller value of 7 million liters [325].

Table 25

Some values of biofuel availability at the world level in 2050. The percentage of aviation energy demand is computed by considering the biofuel availability to the energy demand in the scenarios A and C of Table 23 under an assumption of traffic growth at 3% per year. Scenario F1 of [173] corresponds to an optimistic case where biomass is given in priority for aviation, it may therefore be considered as an upper bound; scenario F2 assumes that biomass is allocated between different sectors in proportion to their demand.

Biofuel availability (EJ/year)	Ref	% aviation energy demand (scenarios A–C)
6	IEA net zero, cited in [327]	32%–43%
7.8	[264]	41%–57%
7–80.4	[173, scenario F1]	37%–100%
0.6–15.4	[173, scenario F2]	3%–100%
5.9	[173, median scenario]	31%–43%

has strict priority over all other sectors for the use of bioenergy), the fleet decarbonation rate in 2050 would reach at most 68%. To put in perspective the value of 75% of Scenario C from the previous section, note that Staples et al. [173] do not consider the use of other drop-in AEC such as electrofuels, and that their study [173] was performed before the COVID-19 crisis. After this crisis, traffic forecast were revised downward, which would have the effect of increasing the fleet decarbonation rate.

Taking a cross-sectorial approach starting from estimates of global bioenergy availability, Searle and Malins [328] performed a meta-study and estimated maximum potentials of 10–20 EJ of biofuel in 2050. This quantity would be available for the whole transport sector, and so aviation would have to compete with the terrestrial and maritime sectors for this source, but even with optimistic share for aviation, this estimate leads towards the lower values reported in Table 25.

At the European level, biofuel production has recently attracted interest following the ReFuelEU Aviation initiative, as mentioned in Section 7.1, which proposes SAF mandate, including biofuels and electrofuels. Modeling of the AESA estimated that the ReFuelEU targets could be achieved by the production in the EU of 70 PJ of biofuel in 2030 and 600 PJ in 2050 (this production is completed by imports and electrofuels) [126]. These numbers correspond closely to those that emerged from a meta-analysis of 56 scenarios for the European transport sector [329]. However, Chiaramonti et al. [329] points to the very large uncertainties that weigh on these forecasts, which range from almost negligible biofuels contribution to a twofold increment compared to the mean values. At another regional level, a study in the US with a detailed analysis of land use concluded that “domestically produced, sustainable biojet fuels can meet the liquid fuel demands of the US aviation sector fully” [138].

Finally, Lim et al. [330] have performed a literature review on opportunities and challenges concerning the production of aviation biofuel, and conclude that “the literature is optimistic towards future demand, but pessimistic towards future supply, with the bottom line indicating few prospects for current investments in biojet”. One of the strongest limitation is the high production cost, which suggests that the aviation biofuel “industry is not financially feasible without strong government intervention” [330].

8.2.2. Electricity availability

In 2021 the electricity world carbon intensity was around 441 gCO₂-eq/kWh (122 gCO₂-eq/MJ), see Table 12. As it has been seen in Section 5 when discussing electricity-based AEC, the electricity carbon intensity has a strong impact on the final AEC carbon intensity, and, at the world level, much lower electricity carbon intensity than the current one needs to be reached before these AEC become climatically beneficial. Thus, electricity production needs to rely less on fossil energy, which restricts the amount of electricity that can be produced.

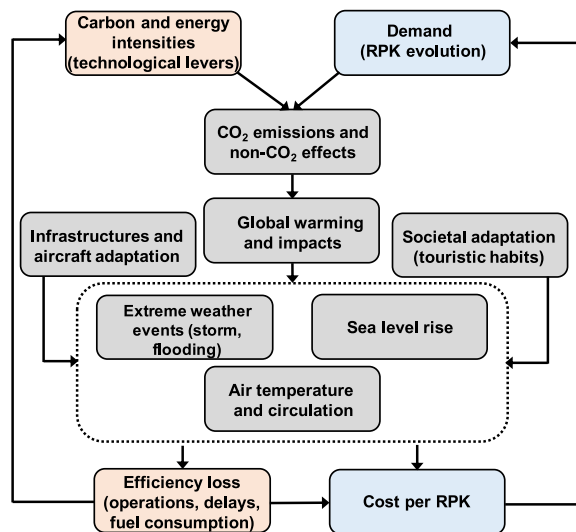

Fig. 34. Overview of climate change impacts for aviation: influence on the energy intensity.

In 2019, 97EJ of electricity was produced, of which 36EJ from low-carbon sources (renewable and nuclear) [123]. In the scenarios reported in Fig. 33 and that limit global warming to between +1.5°C and +2°C, the median value of electricity production is at 199EJ, around twice the current value. However, electricity is the cornerstone of low-carbon transition scenarios for many business sectors and so electricity demand will also increase significantly. This also applies to aviation, since Table 24 shows that electricity-based AEC (especially electrofuels) have a high electricity intensity. For instance, an electricity need between 75 and 115EJ is estimated to power a fleet entirely with electrofuel and liquid hydrogen in 2050 in [198]. This demand represents between 27% and 119% of total electricity production in 2050 among the scenarios of Fig. 33: this potentially high share questions the availability of electricity-based AEC at a large scale.

8.3. Impact of climate change on aviation

This review paper focuses on climate change mitigation issues, for which the technological levers to increase both the energy and carbon efficiency of aviation are a key parameter. However, the aviation efficiency could be negatively affected in the near future by the effects of climate change, as highlighted in Fig. 34. While an adequate global mitigation policy will limit such negative impacts, it is also necessary to consider the possible adaptation of air transport facilities and aircraft to this evolving environment. As a consequence, it could potentially affect the efficiency of the aviation sector in the next decades. The objective of this section is thus to provide some order of magnitude of these impacts for the ground facilities and aircraft operations.

Among the consequences of climate change, the poleward extension of the Hadley cells and the global mean sea level rise will be responsible for a growing exposition of ground infrastructures to negative impacts such as flooding, heat waves, severe turbulence, extreme winds and wildfires [331]. At the same time, the temperature of the different atmosphere layers is evolving in a non-uniform manner, depending both on their latitude and altitude, modifying the atmospheric circulation [1]. For example, the troposphere is globally warming, while the stratosphere is globally cooling, so the climate and weather conditions will be modified, especially at mid-latitude, due to the modification of the large-scale atmospheric circulations [332]. Such modifications of the atmosphere could have specific consequences for aircraft, in terms of efficiency, safety and cost.

The accurate quantification of all these impacts is not straightforward, and their intensity in the future will depend on the evolution of GHG emissions. However, some of these physical mechanisms are already irreversible. The mean sea level will continue to increase during the 21st century, compared to the 1995–2014 average level, by about +0.20 m in 2050 and +0.80 m in 2100 for a RCP8.5 scenario. Even beyond 2100, global mean sea level will still rise for centuries to millennia due to continuing deep ocean heat uptake and mass loss from ice sheets [333]. Combined with the increased intensity and occurrence probability of extreme weather events, this will negatively impact the availability of ground facilities, especially for airports located in the low elevation coastal zone [334]. The consequences of such airport flooding can be transient (a few runways temporary unavailable) or permanent (airport definitively inaccessible due to high sea level). A hundred of small to large airports are very likely to be located beneath the expected sea level in 2100 or affected by coastal flooding due to extreme weather events. In particular in the case of a RCP8.5 scenario, most at risk large airports are located in Asia (e.g. Shanghai airport, China, and Gimhae airport, South Korea) but some are also located in Europe (e.g. Amsterdam airport, Netherlands) and North America (e.g. Oakland and La Guardia airports, USA). All these coastal airports are disproportionately important to the global airline network, and by 2100 from 10% to 20% of all routes will be at risk of disruption [334]. Additionally, the increasing probability of storms could also result in additional delays and flight cancellations due to high-speed sustained winds and gusts [335].

Global warming will also be responsible for an increase of the average near surface air temperature, especially during the summer months, which in turn will reduce the air density by a few percent by the end of the 21st century for a RCP8.5 scenario compared to current conditions. Combined with more frequent heat waves and increased humidity, this could reduce the maximum take-off weight of current aircraft [336,337], up to 5% for some high-latitude and high-elevation airports during the summer months [338]. Such a reduction of the maximum take-off weight corresponds to a decrease of the effective payload up to 10% for long haul aircraft and 20% for regional aircraft. This reduction in the maximum take-off weight due to high surface air temperature is already observed in some regions impacted by global warming, such as Greece [339]. Whatever the GHG emissions scenario, there is a high probability that these impacts will strengthen at least until 2050, especially for airports located far from the coastal zone [340].

Global warming will also modify the atmosphere properties at the aircraft cruising altitudes. For example, in the upper part of the troposphere, the temperature increase is responsible for an increase of the air viscosity at cruising altitudes since the 1950's. This phenomenon increases the global drag of commercial aircraft by +0.22% per century, corresponding to a potential extra-consumption in 2100 of about 4×10^6 oil barrels per year [341]. Due to the modification of local temperature gradients (especially meridional gradient), vertical wind shears will also strengthen at mid-latitude at the tropopause altitude [342]. Combined with the poleward shift of the mid latitude jet stream, this will affect the occurrence probability of turbulence, which is responsible for more than 70% of weather-related accidents for commercial aircraft [343]. These turbulences also negatively impact the efficiency and cost of air transportation, since 5% of flights are estimated to be diverted from their optimal routes to avoid turbulent areas [344]. The modifications of the atmospheric jet streams could increase significantly shear flow instabilities, increasing the occurrence probability of moderate to severe clear-air turbulence. Such increase in turbulence occurrence will be observed globally for all latitudes and seasons, but this effect could be particularly intense for north Atlantic flights during the winter where this probability can increase by +150% for a RCP8.5 scenario [345,346].

The impacts of climate change are thus currently low for air transport, but some physical mechanisms such as the sea level rise and the

evolution of the atmospheric circulation are already on-going and their effects will progressively strengthen in the next decades, especially in the vicinity and beyond 2050 [340,341,345]. While the exact impact in terms of energy intensity and cost is difficult to evaluate for air transport, it could represent an increase of the energy consumption per RPK up to a few percent in 2050. Most of these impacts for ground operations and cruising flights can be at least partially overcome with adequate mitigation and adaptation policies [331]. For example, the adaptation of airports includes the relocation of some coastal airports and the modifications of airport runways to adapt to more intense rainfalls, dominant wind evolutions and longer take-off distances. The adaptation of current and future aircraft to their changing environment could also help to balance negative impacts of climate change, e.g. by increasing the turbine inlet temperature margin or by adapting some of the certification constraints to adapt to more frequent and more intense ground temperatures and turbulence during cruising flights.

8.4. Prospective scenarios, discourses of climate delay and usage issues

As discussed in Section 7.2, prospective scenarios can be useful tools to explore different possible futures, respond to what-if questions, and provide insight into relevant orders of magnitude. They contribute to the public debate by raising awareness and providing knowledge to decision makers. However, it is also important to reflect on this practice to identify potential limits and shortcomings. We discuss here an important criticism that has been addressed to prospective scenarios, including aviation scenarios: namely, it has been argued that they can have a counterproductive effect of delaying climate action, ultimately leading to a worsening of global warming.

This criticism has been made for IPCC scenarios [347] which, as they evolved over time from simple models to involved Integrated Assessment Models (IAM) [348], incorporated new technologies which were not mature, but that bore the potential to cope in the future with the worsening situation. In the meantime, emissions continued to rise, and the authors of [347] (which, quite significantly, include a former IPCC chair) reach the strong conclusion that these scenarios were not intended to limit global warming to +1.5°C, but rather to “protect business as usual”. Similar criticisms have been made for aviation scenarios. A historical perspective reveals that the aviation sector has set many climate targets in recent years, but that most of them were either not checked or simply abandoned. This poses a clear governance issue and suggests that target setting may be a strategy to preserve the sector growth [267]. A parallel conclusion is reached through a media analysis tracing technology-focused aviation discourses, where it is observed that new technology discourses follow one another over time in order to cope with the growing awareness of aviation’s climate impact [349]. The authors of [349] conclude that most of these solutions constitute “technology myths”.

There is therefore a risk that prospective scenarios can lead to a delay in action, and thus fail to address the urgent need for emission reduction. The reason is that such scenarios, especially those that rely on not mature or not scaling up technologies, can carry a sense of “technological optimism” whereby all problems would be solved later thanks to future technological developments. Such discourses have been identified in the scientific literature as discourses of climate delay [350]. This criticism is particularly relevant to the aviation sector because it is a hard-to-abate sector with only limited short-term technological solutions to decrease its CO₂ emissions rapidly. In the IEA Sustainable Development Scenario for instance, more than 83% of the aviation future CO₂ emissions reduction by 2070 are due to prototype technology. By comparison, for shipping and trucks, the two other long-distance transport sectors, the same figure only amounts to 51% and 43%, respectively [351].

Technology has an important role to play in sustainable pathways, but it cannot be taken for granted that technology alone will be sufficient [352]. One of the key issues is the scale at which technological

solutions can be deployed, which is actually the core issue raised in [347]. If technological solutions alone cannot scale up sufficiently in order to yield the required emission decrease, then demand-side mitigation measures need to be considered. In that vein, it is significant to note that IPCC AR6 includes for the first time a chapter dedicated to such measures. It is estimated that demand-side mitigation measures can lead to emission reductions between 40 and 70%; concerning aviation, reducing long-haul flights is identified as one of the levers with the main “Avoid” potential [353].

Demand-side mitigation measures question the usage of technology. This raises two questions of paramount importance [354]: what is the purpose of the technology, and to whom does it benefit? To conclude this section, we provide some elements of reflection concerning these questions for aviation.

Concerning the purpose of aviation, an important distinction has to be drawn between needs and need satisfiers. The theory of human needs distinguishes two basic needs (health and autonomy) and seven intermediate needs such as significant primary relationships or physical security. These needs can be satisfied by different means, or satisfiers. In contrast to needs which are universal, these satisfiers are largely determined by one’s culture [355,356]. From that perspective, even if flying can be perceived as a “necessity” [357], it should be considered as a satisfier and not a need in itself. Aviation can play a role in need-satisfaction [356], but not all flights do. For instance, flights are not always considered as important by those who fly [357], and maintaining or enhancing social capital can be an important motivation for flying [358]. In order to take needs into account, a bottom-up approach starting from human needs is adopted in [359] where the minimal energy consumption required to provide decent material livings to the entire global population is considered. They propose a scenario in which transport needs are evaluated at between 5000 and 15000 kilometers per person and per year, of which around 1000 km is satisfied by aviation. Interestingly, this number is close to the total distance traveled in 2019 if it were divided equally among all human beings. Indeed, in 2019, the traffic amounted to 8644 RPK²⁴ and the world population to 7.76 billion human beings,²⁵ corresponding to an equal share of 1114 km per person. Since “there is no ethically neutral position in the climate context” [12], such bottom-up approaches for designing transition scenarios have the advantage of clearly indicating their underlying ethical choices.

Concerning the people who benefit from aviation, the answer largely depends on the scope considered. If one considers all the economic activity induced by aviation, then before the COVID-19 crisis, the aviation industry supported a third of global trade by value, generated 65 million jobs and underpinned \$2.7 trillion of GDP [360]. But narrowing the scope to the people who actually fly reveals a highly unequal picture, both in terms of energy use [361,362] and income [363,364]. For instance, at the global scale, it is estimated that at most 11% of the population flew in 2018, and only 2% to 4% traveled between countries [39]. In order to take into account the beneficiaries of aviation, the estimation of economic impacts is increasingly common, such as in the IAM dedicated to aviation AIM2015 mentioned in Section 7 [365]. However, similar initiatives to assess social impacts are less numerous, although some work has been emerging in recent years [366].

Designing improved aviation transition scenarios taking into account the different limits highlighted previously offers promising research directions. The inclusion of ethical considerations, related to purpose and equality, would in particular offer more chances of enabling instead of delaying climate action.

²⁴ See the webpage [World Airlines Traffic and Capacity](#) hosted by Airlines for America, and recording ICAO data. Accessed on April 18, 2023.

²⁵ See the [population](#) webpage of Our World In Data. Accessed on April 18, 2023.

9. Conclusion and perspectives

The question that motivated the present review paper was to assess whether a given transition scenario for the aviation sector could be considered as sustainable in the context of the Paris Agreement. Addressing this question relies on a broad range of concepts: ethical considerations related to effort-sharing mitigation principles, physical considerations on how aviation impacts the climate, technological considerations related to CO₂ and non-CO₂ mitigation, and methodological considerations on how to design transition scenarios and assess their climate sustainability. In order to give a synthetic but thorough overview of these key concepts, this paper has therefore drawn upon a vast scientific literature, from which two key messages can be formulated.

First, technological levers have an important role to play in making aviation sustainable. Regarding non-CO₂ effects, which currently represent the main climate forcer of aviation, contrail effect mitigation through operational strategies is very likely the most promising lever to significantly mitigate aviation climate impact. Concerning CO₂ effects, shifting from fossil kerosene to low-carbon alternative energy carriers represents the major lever for reducing significantly CO₂ emissions; this lever could also have beneficial impacts on non-CO₂ effects. Other significant CO₂ levers include improving aircraft architecture efficiency and accelerating fleet renewal. Overall, the use of prospective scenario is a useful framework for assessing the impacts of these levers on climate sustainability.

Second, assessing the compatibility of a scenario with the objectives of the Paris Agreement is subject to many uncertainties. Some are of a scientific nature and could be improved with time and dedicated research effort like the uncertainties resting upon the evaluations of carbon budgets, aviation non-CO₂ effects, mitigation impacts of technological levers and impacts of climate change on aviation. Other uncertainties arise from political trade-offs between social, economic, ethical and other considerations. For instance, they will influence the global climate objectives, the allowed climate impact of aviation (e.g., through its share of carbon budget or temperature increase), and quite significantly the speed at which technologies will develop and scale up. In particular, the most promising technologies to reduce aviation climate impact are not yet mature or their deployment at the required scale is uncertain, especially in a context of strong traffic growth. For instance, some biofuel pathways are already mature, but they are subject to strong limitations on biomass availability, industrial production scale up and competition between business sectors. Regarding electricity-based alternative energy carriers, these solutions are not mature yet and their significant decarbonization potential is highly dependent on the evolution of the electricity mix. Therefore, the most ambitious scenarios for air transport rest upon uncertain technological and socio-economic assumptions: they constitute technological bets bearing the risk of delaying climate action. In the current literature, the evolution of air traffic and the priority granted to this hard-to-abate sector have been largely unquestioned. Indeed, most studies take the industrial traffic forecast as an input, and studies discussing the allowed climate impact of aviation only consider the grandfathering allocation scheme. However, since technological mitigation levers alone are not sufficient for reaching the most ambitious climate targets, the trade-off between the evolution of air traffic and the allowed climate impact of aviation needs to be considered.

By raising these issues, this paper opens perspectives to deal with a broader question: what does sustainability mean for aviation? This review has shown that the sustainability of aviation has so far mostly been considered from a technological perspective. However, sustainability assessment should adopt a larger scope, incorporating broader environmental considerations (resources, water, biodiversity, etc.), but also, ethical, economic, social and other considerations. Socio-economic and ethical considerations have for instance been discussed about the purpose of aviation and the evaluation of its benefits, whereas the availability of energy resources has been briefly mentioned. In particular,

environmental sustainability assessments for the aviation sector could rely on methodologies drawing from the planetary boundaries framework for instance. In a nutshell, defining sustainable aviation requires adopting multidisciplinary approaches. Although current prospective scenarios make it possible to obtain relevant results for aviation transition, one could aim for integrated assessment models enriched with various considerations that would make explicit the underlying ethical choices and the consequences on society.

CRedit authorship contribution statement

S. Delbecq: Conceptualization, Software, Writing – original draft, Writing – review & editing, Visualization. **J. Fontane:** Conceptualization, Data collection, Writing – original draft, Writing – review & editing, Visualization. **N. Gourdain:** Conceptualization, Writing – original draft, Writing – review & editing, Visualization, Project administration. **T. Planès:** Conceptualization, Methodology, Software, Writing – original draft, Writing – review & editing, Visualization. **F. Simatos:** Conceptualization, Data collection, Writing – original draft, Writing – review & editing, Visualization, Project administration.

Declaration of competing interest

The authors declare that they have no known competing financial interests or personal relationships that could have appeared to influence the work reported in this paper.

Data availability

Data will be made available on request.

Acknowledgments

This work evolved from the ISAE-SUPAERO literature overview report [61], and so we wish to thank the reviewers of this former report who indirectly contributed to this paper, namely Olivier Boucher, Philippe Novelli, David Salas, Bruno Savard, Laurent Terray, Étienne Terrenoire and Xavier Vancassel. Also, this work could not have been possible without the institutional support of ISAE-SUPAERO board and researchers, in particular its director Olivier Lesbre and its head of research, Grégoire Casalis. Finally, this work greatly benefited from the numerous discussions held in the Aviation-Climate-Environment research group at ISAE-SUPAERO, and we thank all the participants of this group.

References

- [1] V. Masson-Delmotte, P. Zhai, A. Pirani, S. Connors, C. Péan, S. Berger, N. Caud, Y. Chen, L. Goldfarb, M. Gomis, M. Huang, K. Leitzell, E. Lonnoy, J. Matthews, T. Maycock, T. Waterfield, O. Yelekçi, R. Yu, B. Zhou, in: V. Masson-Delmotte, P. Zhai, A. Pirani, S. Connors, C. Péan, S. Berger, N. Caud, Y. Chen, L. Goldfarb, M. Gomis, M. Huang, K. Leitzell, E. Lonnoy, J. Matthews, T. Maycock, T. Waterfield, O. Yelekçi, R. Yu, B. Zhou (Eds.), *Climate Change 2021: The Physical Science Basis. Contribution of Working Group I to the Sixth Assessment Report of the Intergovernmental Panel on Climate Change*, Cambridge University Press, IPCC, 2021 (Chapter Summary for policymakers).
- [2] H.O. Pörtner, D. Roberts, E. Poloczanska, K. Mintenbeck, M. Tignor, A. Alegría, M. Craig, S. Langsdorf, S. Löschke, V. Möller, A. Okem, in: H.O. Pörtner, D. Roberts, E. Poloczanska, K. Mintenbeck, M. Tignor, A. Alegría, M. Craig, S. Langsdorf, S. Löschke, V. Möller, A. Okem (Eds.), *Climate Change 2022: Impacts, Adaptation, and Vulnerability. Contribution of Working Group II to the Sixth Assessment Report of the Intergovernmental Panel on Climate Change*, Cambridge University Press, 2022, <http://dx.doi.org/10.1017/9781009325844.001> (Chapter Summary for Policymakers).
- [3] UNFCCC, *Paris Agreement*, 2015.

- [4] P. Forster, T. Storelvmo, K. Armour, W. Collins, J.L. Dufresne, D. Frame, D. Lunt, T. Mauritsen, M. Palmer, M. Watanabe, M. Wild, H. Zhang, in: V. Masson-Delmotte, P. Zhai, A. Pirani, S. Connors, C. Péan, S. Berger, N. Caud, Y. Chen, L. Goldfarb, M. Gomis, M. Huang, K. Leitzell, E. Lonnoy, J. Matthews, T. Maycock, T. Waterfield, O. Yelekçi, R. Yu, B. Zhou (Eds.), *Climate Change 2021: The Physical Science Basis. Contribution of Working Group I to the Sixth Assessment Report of the Intergovernmental Panel on Climate Change*, Cambridge University Press, 2021 (Chapter The Earth's Energy Budget, Climate Feedbacks, and Climate Sensitivity).
- [5] S. Szopa, V. Naik, B. Adhikary, P. Artaxo, T. Bernsten, W. Collins, S. Fuzzi, L. Gallardo, A. Kiendler Scharr, Z. Klimont, H. Liao, N. Unger, P. Zanis, in: V. Masson-Delmotte, P. Zhai, A. Pirani, S. Connors, C. Péan, S. Berger, N. Caud, Y. Chen, L. Goldfarb, M. Gomis, M. Huang, K. Leitzell, E. Lonnoy, J. Matthews, T. Maycock, T. Waterfield, O. Yelekçi, R. Yu, B. Zhou (Eds.), *Climate Change 2021: The Physical Science Basis. Contribution of Working Group I to the Sixth Assessment Report of the Intergovernmental Panel on Climate Change*, Cambridge University Press, 2021 (Chapter Short-Lived Climate Forcers).
- [6] S. Gulev, P. Thorne, J. Ahn, F. Dentener, C. Domingues, S. Gerland, D. Gong, D. Kaufman, H. Nnamchi, J. Quaas, J. Rivera, S. Sathyendranath, S. Smith, B. Trewin, K. von Shuckmann, R. Vose, in: V. Masson-Delmotte, P. Zhai, A. Pirani, S. Connors, C. Péan, S. Berger, N. Caud, Y. Chen, L. Goldfarb, M. Gomis, M. Huang, K. Leitzell, E. Lonnoy, J. Matthews, T. Maycock, T. Waterfield, O. Yelekçi, R. Yu, B. Zhou (Eds.), *Climate Change 2021: The Physical Science Basis. Contribution of Working Group I to the Sixth Assessment Report of the Intergovernmental Panel on Climate Change*, Cambridge University Press, IPCC, 2021 (Chapter 2021. Changing State of the Climate System).
- [7] J. Canadell, P. Monteiro, M. Costa, L. Cotrim da Cunha, P. Cox, A. Eliseev, S. Henson, M. Ishii, S. Jaccard, C. Koven, A. Lohila, P. Patra, S. Piao, J. Rogelj, S. Syampungani, S. Zaehle, K. Zickfeld, in: V. Masson-Delmotte, P. Zhai, A. Pirani, S. Connors, C. Péan, S. Berger, N. Caud, Y. Chen, L. Goldfarb, M. Gomis, M. Huang, K. Leitzell, E. Lonnoy, J. Matthews, T. Maycock, T. Waterfield, O. Yelekçi, R. Yu, B. Zhou (Eds.), *Climate Change 2021: The Physical Science Basis. Contribution of Working Group I to the Sixth Assessment Report of the Intergovernmental Panel on Climate Change*, Cambridge University Press, 2021 (Chapter Global Carbon and other Biogeochemical Cycles and Feedbacks).
- [8] IPCC, in: P. Shukla, J. Skea, R. Slade, A.A. Khoualdjia, R. van Diemen, D. McCollum, M. Pathak, S. Some, P. Vyas, R. Fradera, M. Belkacemi, A. Hasija, G. Lisboa, S. Luz, J. Malley (Eds.), *Climate Change 2022: Mitigation of Climate Change. Contribution of Working Group III to the Sixth Assessment Report of the Intergovernmental Panel on Climate Change*, Cambridge University Press, Cambridge, UK and New York, NY, USA, 2022 (Chapter Summary for Policymakers).
- [9] N. Höhne, M. den Elzen, D. Escalante, Regional GHG reduction targets based on effort sharing: a comparison of studies, *Clim. Policy* 14 (1) (2014) 122–147, <http://dx.doi.org/10.1080/14693062.2014.849452>.
- [10] W.J. Botzen, J.M. Gowdy, J.C. van den Bergh, Cumulative CO2 emissions: shifting international responsibilities for climate debt, *Clim. Policy* 8 (6) (2008) 569–576, <http://dx.doi.org/10.3763/cpol.2008.0539>.
- [11] N.J. van den Berg, H.L. van Soest, A.F. Hof, M.G.J. den Elzen, D.P. van Vuuren, W. Chen, L. Drouet, J. Emmerling, S. Fujimori, N. Höhne, A.C. Köberle, D. McCollum, R. Schaeffer, S. Shekhar, S.S. Vishwanathan, Z. Vrontisi, K. Blok, Implications of various effort-sharing approaches for national carbon budgets and emission pathways, *Clim. Change* 162 (4) (2020) 1805–1822, <http://dx.doi.org/10.1007/s10584-019-02368-y>.
- [12] K. Dooley, C. Holz, S. Kartha, S. Klinsky, J.T. Roberts, H. Shue, H. Winkler, T. Athanasiou, S. Caney, E. Cripps, N.K. Dubash, G. Hall, P.G. Harris, B. Lahn, D. Moellendorf, B. Müller, A. Sagar, P. Singer, Ethical choices behind quantifications of fair contributions under the Paris Agreement, *Nature Clim. Change* 11 (4) (2021) 300–305, <http://dx.doi.org/10.1038/s41558-021-01015-8>.
- [13] S. Caney, Justice and the distribution of greenhouse gas emissions, *J. Glob. Ethics* 5 (2) (2009) 125–146, <http://dx.doi.org/10.1080/17449620903110300>.
- [14] S. Kartha, T. Athanasiou, S. Caney, E. Cripps, K. Dooley, N.K. Dubash, T. Fei, P.G. Harris, C. Holz, B. Lahn, D. Moellendorf, B. Müller, J.T. Roberts, A. Sagar, H. Shue, P. Singer, H. Winkler, Cascading biases against poorer countries, *Nature Clim. Change* 8 (5) (2018) 348–349, <http://dx.doi.org/10.1038/s41558-018-0152-7>.
- [15] A. Bjørn, C. Chandrakumar, A.-M. Boulay, G. Doka, K. Fang, N. Gondran, M.Z. Hauschild, A. Kerkhof, H. King, M. Margni, S. McLaren, C. Mueller, M. Owsianiak, G. Peters, S. Roos, S. Sala, G. Sandin, S. Sim, M. Vargas-Gonzalez, M. Ryberg, Review of life-cycle based methods for absolute environmental sustainability assessment and their applications, *Environ. Res. Lett.* 15 (8) (2020) 083001, <http://dx.doi.org/10.1088/1748-9326/ab89d7>.
- [16] W. Steffen, K. Richardson, J. Rockström, S.E. Cornell, I. Fetzer, E.M. Bennett, R. Biggs, S.R. Carpenter, W. de Vries, C.A. de Wit, C. Folke, D. Gerten, J. Heinke, G.M. Mace, L.M. Persson, V. Ramanathan, B. Reyers, S. Sörlin, Planetary boundaries: Guiding human development on a changing planet, *Science* 347 (6223) (2015) <http://dx.doi.org/10.1126/science.1259855>.
- [17] V. Tulus, J. Pérez-Ramírez, G. Guillén-Gosálbez, Planetary metrics for the absolute environmental sustainability assessment of chemicals, *Green Chem.* 23 (24) (2021) 9881–9893, <http://dx.doi.org/10.1039/D1GC02623B>.
- [18] C.E. Andersen, P. Ohms, F.N. Rasmussen, H. Birgisdóttir, M. Birkved, M. Hauschild, M. Ryberg, Assessment of absolute environmental sustainability in the built environment, *Build. Environ.* 171 (2020) 106633, <http://dx.doi.org/10.1016/j.buildenv.2019.106633>.
- [19] I.M. Algunaibet, C. Pozo, Á. Galán-Martín, M.A. Huijbregts, N. Mac Dowell, G. Guillén-Gosálbez, Powering sustainable development within planetary boundaries, *Energy Environ. Sci.* 12 (6) (2019) 1890–1900, <http://dx.doi.org/10.1039/C8EE03423K>.
- [20] A. Valente, V. Tulus, Á. Galán-Martín, M.A. Huijbregts, G. Guillén-Gosálbez, The role of hydrogen in heavy transport to operate within planetary boundaries, *Sustain. Energy Fuels* 5 (18) (2021) 4637–4649, <http://dx.doi.org/10.1039/D1SE00790D>.
- [21] M.W. Ryberg, M.M. Andersen, M. Owsianiak, M.Z. Hauschild, Downscaling the planetary boundaries in absolute environmental sustainability assessments – A review, *J. Clean. Prod.* 276 (2020) 123287, <http://dx.doi.org/10.1016/j.jclepro.2020.123287>.
- [22] J.M. Giménez-Gómez, J. Teixidó-Figueras, C. Vilella, The global carbon budget: a conflicting claims problem, *Clim. Change* 136 (2016) 693–703, <http://dx.doi.org/10.1007/s10584-016-1633-1>.
- [23] A. Quinet, What value do we attach to climate action? *Econ. Stat.* 510 (1) (2019) 165–179, <http://dx.doi.org/10.24187/ecostat.2019.510t.1995>.
- [24] L. Ringius, A. Torvanger, A. Underdal, Burden sharing and fairness principles in international climate policy, *Int. Environ. Agreem.* 2 (1) (2002) 1–22, <http://dx.doi.org/10.1023/A:1015041613785>.
- [25] B. Graver, K. Zhang, D. Rutherford, CO₂ Emissions from Commercial Aviation, 2018, Technical Report, ICCT, 2019.
- [26] D.S. Lee, D. Fahey, A. Skowron, M. Allen, U. Burkhardt, Q. Chen, S. Doherty, S. Freeman, P. Forster, J. Fuglestvedt, et al., The contribution of global aviation to anthropogenic climate forcing for 2000 to 2018, *Atmos. Environ.* 244 (2021) 117834, <http://dx.doi.org/10.1016/j.atmosenv.2020.117834>.
- [27] R.W. Stratton, P.J. Wolfe, J.I. Hileman, Impact of aviation non-CO₂ combustion effects on the environmental feasibility of alternative jet fuels, *Environ. Sci. Technol.* 45 (24) (2011) 10736–10743, <http://dx.doi.org/10.1021/es2017522>.
- [28] L. Jing, H.M. El-Houjeiri, J.-C. Monfort, J. Littlefield, A. Al-Qahtani, Y. Dixit, R.L. Speth, A.R. Brandt, M.S. Masnadi, H.L. MacLean, W. Peltier, D. Gordon, J.A. Bergerson, Understanding variability in petroleum jet fuel life cycle greenhouse gas emissions to inform aviation decarbonization, *Nature Commun.* 13 (1) (2022) 7853, <http://dx.doi.org/10.1038/s41467-022-35392-1>.
- [29] S. Pinheiro Melo, A. Barke, F. Cerdas, C. Thies, M. Mennenga, T.S. Spengler, C. Herrmann, Sustainability assessment and engineering of emerging aircraft technologies—Challenges, methods and tools, *Sustainability* 12 (14) (2020) <http://dx.doi.org/10.3390/su12145663>.
- [30] X.P. Vancassel, F.A. Garnier, P.J. Mirabel, Encyclopedia of Aerospace Engineering, John Wiley & Sons, Ltd, 2010, p. 413, <http://dx.doi.org/10.1002/9780470686652.eae351> (Chapter In Plume Physics and Chemistry).
- [31] U. Schumann, K. Graf, H. Mannstein, B. Mayer, Atmospheric Physics: Background – Methods – Trends, Springer Berlin Heidelberg, Berlin, Heidelberg, 2012, pp. 239–257, <http://dx.doi.org/10.1007/978-3-642-30183-4> (Chapter Contrails: Visible Aviation Induced Climate Impact).
- [32] K. Gierens, P. Spichtinger, U. Schumann, Atmospheric Physics: Background – Methods – Trends, Springer Berlin Heidelberg, Berlin, Heidelberg, 2012, pp. 135–150, <http://dx.doi.org/10.1007/978-3-642-30183-4> (Chapter Ice Supersaturation).
- [33] B. Kärcher, Formation and radiative forcing of contrail cirrus, *Nature Commun.* 9 (1) (2018) 1824, <http://dx.doi.org/10.1038/s41467-018-04068-0>.
- [34] F. Noppel, R. Singh, Overview on contrail and cirrus cloud avoidance technology, *J. Aircr.* 44 (5) (2007) 1721–1726, <http://dx.doi.org/10.2514/1.28655>.
- [35] A. Agarwal, V.R. Meijer, S.D. Eastham, R.L. Speth, S.R.H. Barrett, Reanalysis-driven simulations may overestimate persistent contrail formation by 100%–250%, *Environ. Res. Lett.* 17 (1) (2022) 014045, <http://dx.doi.org/10.1088/1748-9326/ac38d9>.
- [36] M. Righi, J. Hendricks, R. Sausen, The global impact of the transport sectors on atmospheric aerosol: simulations for year 2000 emissions, *Atmos. Chem. Phys.* 13 (19) (2013) 9939–9970, <http://dx.doi.org/10.5194/acp-13-9939-2013>.
- [37] K. Dahlmann, V. Grewe, S. Matthes, H. Yamashita, Climate assessment of single flights: Deduction of route specific equivalent CO₂ emissions, *Int. J. Sustain. Transp.* 17 (1) (2023) 29–40, <http://dx.doi.org/10.1080/15568318.2021.1979136>.
- [38] IEA, CO₂ emissions from fuel combustion, Technical Report, IEA, 2019.
- [39] S. Gössling, A. Humpe, The global scale, distribution and growth of aviation: Implications for climate change, *Global Environ. Change* 65 (2020) 102194, <http://dx.doi.org/10.1016/j.gloenvcha.2020.102194>.
- [40] A. Christensen, C. Petrenko, CO₂-Based Synthetic Fuel: Assessment of Potential European Capacity and Environmental Performance, Technical Report, ICCT, 2017.
- [41] P. Friedlingstein, M. O'Sullivan, M.W. Jones, R.M. Andrew, L. Gregor, J. Hauck, C. Le Quéré, I.T. Luijckx, A. Olsen, G.P. Peters, W. Peters, J. Pongratz, C. Schwingshackl, S. Sitth, J.G. Canadell, P. Ciais, R.B. Jackson, S.R. Alin, R. Alkama, A. Arneeth, V.K. Arora, N.R. Bates, M. Becker, N. Bellouin, H.C. Bittig,

- L. Bopp, F. Chevallier, L.P. Chini, M. Cronin, W. Evans, S. Falk, R.A. Feely, T. Gasser, M. Gehlen, T. Gkritzalis, L. Gloege, G. Grassi, N. Gruber, Ö. Gürses, I. Harris, M. Hefner, R.A. Houghton, G.C. Hurtt, Y. Iida, T. Ilyina, A.K. Jain, A. Jersild, K. Kadono, E. Kato, D. Kennedy, K. Klein Goldewijk, J. Knauer, J.I. Korsbakken, P. Landschützer, N. Lefèvre, K. Lindsay, J. Liu, Z. Liu, G. Marland, N. Mayot, M.J. McGrath, N. Metz, N.M. Monacci, D.R. Munro, S.I. Nakaoka, Y. Niwa, K. O'Brien, T. Ono, P.I. Palmer, N. Pan, D. Pierrot, K. Pocock, B. Poulter, L. Resplandy, E. Robertson, C. Rödenbeck, C. Rodriguez, T.M. Rosan, J. Schwinger, R. Séférian, J.D. Shutler, I. Skjelvan, T. Steinhoff, Q. Sun, A.J. Sutton, C. Sweeney, S. Takao, T. Tanhua, P.P. Tans, X. Tian, H. Tian, B. Tilbrook, H. Tsujino, F. Tubiello, G.R. van der Werf, A.P. Walker, R. Wanninkhof, C. Whitehead, A. Willstrand Wranne, R. Wright, W. Yuan, C. Yue, X. Yue, S. Zaehle, J. Zeng, B. Zheng, Global carbon budget 2022, *Earth Syst. Sci. Data* 14 (11) (2022) 4811–4900, <http://dx.doi.org/10.5194/essd-14-4811-2022>.
- [42] R. Sausen, U. Schumann, Estimates of the climate response to aircraft CO₂ and NO_x emissions scenarios, *Clim. Change* 44 (1) (2000) 27–58, <http://dx.doi.org/10.1023/A:1005579306109>.
- [43] G. Myhre, D. Shindell, F.M. Bréon, W. Collins, J. Fuglestad, J. Huang, D. Koch, J.F. Lamarque, D. Lee, B. Mendoza, T. Nakajima, A. Robock, G. Stephens, T. Takemura, H. Zhang, in: T. Stocker, D. Qin, G.K. Plattner, M. Tignor, S. Allen, J. Boschung, A. Nauels, Y. Xia, V. Bex, P. Midgley (Eds.), *Climate Change 2013: The Physical Science Basis. Contribution of Working Group I to the Fifth Assessment Report of the Intergovernmental Panel on Climate Change*, Cambridge University Press, Cambridge, United Kingdom and New York, NY, USA, 2013 (Chapter Anthropogenic and Natural Radiative Forcing).
- [44] D. Archer, M. Eby, V. Brovkin, A. Ridgwell, L. Cao, U. Mikolajewicz, K. Caldeira, K. Matsumoto, G. Munhoven, A. Montenegro, K. Tokos, Atmospheric lifetime of fossil fuel carbon dioxide, *Annu. Rev. Earth Planet. Sci.* 37 (1) (2009) 117–134, <http://dx.doi.org/10.1146/annurev.earth.031208.100206>.
- [45] D.C. Lewellen, Persistent contrails and contrail cirrus. Part II: Full lifetime behavior, *J. Atmos. Sci.* 71 (12) (2014) 4420–4438, <http://dx.doi.org/10.1175/JAS-D-13-0317.1>.
- [46] A. Petzold, B. Kärcher, *Atmospheric Physics: Background – Methods – Trends*, Springer Berlin Heidelberg, Berlin, Heidelberg, 2012, pp. 37–53 (Chapter Aerosols in the Atmosphere).
- [47] B. Kärcher, F. Mahrt, C. Marcolli, Process-oriented analysis of aircraft soot-cirrus interactions constrains the climate impact of aviation, *Commun. Earth Environ.* 2 (1) (2021) 113, <http://dx.doi.org/10.1038/s43247-021-00175-x>.
- [48] J. Zhu, J.E. Penner, A. Garnier, O. Boucher, M. Gao, L. Song, J. Deng, C.-q. Liu, P. Fu, Decreased aviation leads to increased ice crystal number and a positive radiative effect in cirrus clouds, *AGU Adv.* 3 (2) (2022) e2021AV000546, <http://dx.doi.org/10.1029/2021AV000546>.
- [49] V. Grewe, S. Matthes, K. Dahlmann, The contribution of aviation NO_x emissions to climate change: are we ignoring methodological flaws? *Environ. Res. Lett.* 14 (12) (2019) 121003, <http://dx.doi.org/10.1088/1748-9326/ab5dd7>.
- [50] R.A.R. Digby, N.P. Gillett, A.H. Monahan, J.N.S. Cole, An observational constraint on aviation-induced cirrus from the COVID-19-induced flight disruption, *Geophys. Res. Lett.* 48 (20) (2021) e2021GL095882, <http://dx.doi.org/10.1029/2021GL095882>.
- [51] Q. Li, S. Groß, Changes in cirrus cloud properties and occurrence over Europe during the COVID-19-caused air traffic reduction, *Atmos. Chem. Phys.* 21 (19) (2021) 14573–14590, <http://dx.doi.org/10.5194/acp-21-14573-2021>.
- [52] V.R. Meijer, L. Kulik, S.D. Eastham, F. Allroggen, R.L. Speth, S. Karaman, S.R.H. Barrett, Contrail coverage over the United States before and during the COVID-19 pandemic, *Environ. Res. Lett.* 17 (3) (2022) 034039, <http://dx.doi.org/10.1088/1748-9326/ac26f0>.
- [53] J. Quaas, E. Gryspeerdt, R. Vautard, O. Boucher, Climate impact of aircraft-induced cirrus assessed from satellite observations before and during COVID-19, *Environ. Res. Lett.* 16 (6) (2021) 064051, <http://dx.doi.org/10.1088/1748-9326/abf686>.
- [54] U. Schumann, I. Poll, R. Teoh, R. Koelle, E. Spinielli, J. Molloy, G.S. Koudis, R. Baumann, L. Bugliaro, M. Stettler, C. Voigt, Air traffic and contrail changes over Europe during COVID-19: a model study, *Atmos. Chem. Phys.* 21 (10) (2021) 7429–7450, <http://dx.doi.org/10.5194/acp-21-7429-2021>.
- [55] A. Gettelman, C.C. Chen, C.G. Bardeen, The climate impact of COVID-19-induced contrail changes, *Atmos. Chem. Phys.* 21 (12) (2021) 9405–9416, <http://dx.doi.org/10.5194/acp-21-9405-2021>.
- [56] U. Schumann, L. Bugliaro, A. Dörnbrack, R. Baumann, C. Voigt, Aviation contrail cirrus and radiative forcing over Europe during 6 months of COVID-19, *Geophys. Res. Lett.* 48 (8) (2021) e2021GL092771, <http://dx.doi.org/10.1029/2021GL092771>.
- [57] L. Wilhelm, K. Gierens, S. Rohs, Weather variability induced uncertainty of contrail radiative forcing, *Aerospace* 8 (11) (2021) <http://dx.doi.org/10.3390/aerospace8110332>.
- [58] Y. Kaya, K. Yokobori, et al., *Environment, Energy, and Economy: Strategies for Sustainability*, United Nations University Press Tokyo, 1997.
- [59] V. Andreoni, S. Galmarini, European CO₂ emission trends: A decomposition analysis for water and aviation transport sectors, *Energy* 45 (1) (2012) 595–602, <http://dx.doi.org/10.1016/j.energy.2012.07.039>.
- [60] C. Bergero, G. Gosnell, D. Gielen, S. Kang, M. Bazilian, S.J. Davis, Pathways to net-zero emissions from aviation, *Nat. Sustain.* (2023) 1–11, <http://dx.doi.org/10.1038/s41893-022-01046-9>.
- [61] S. Delbecq, J. Fontane, N. Gourdain, H. Mugnier, T. Planès, F. Simatos, Aviation and Climate: A Literature Review, ISAE-SUPAERO, 2022, <http://dx.doi.org/10.34849/a66a-vv58>.
- [62] L. Dray, A.W. Schäfer, C. Grobler, C. Falter, F. Allroggen, M.E. Stettler, S.R. Barrett, Cost and emissions pathways towards net-zero climate impacts in aviation, *Nature Clim. Change* 12 (10) (2022) 956–962, <http://dx.doi.org/10.1038/s41558-022-01485-4>.
- [63] T. Planès, S. Delbecq, V. Pommier-Budinger, E. Bénard, Simulation and evaluation of sustainable climate trajectories for aviation, *J. Environ. Manag.* 295 (2021) 113079, <http://dx.doi.org/10.1016/j.jenvman.2021.113079>.
- [64] A.W. Schäfer, A.D. Evans, T.G. Reynolds, L. Dray, Costs of mitigating CO₂ emissions from passenger aircraft, *Nature Clim. Change* 6 (4) (2016) 412–417, <http://dx.doi.org/10.1038/nclimate2865>.
- [65] IEA, *Energy Efficiency Indicators, Technical Report*, IEA, 2020.
- [66] W.S. Jevons, The coal question; an inquiry concerning the progress of the nation, and the probable exhaustion of our coal-mines, *Fortnightly* 6 (34) (1866) 505–507, <http://dx.doi.org/10.1017/S0016756800197468>.
- [67] F. Afonso, M. Sohst, C.M. Diogo, S.S. Rodrigues, A. Ferreira, I. Ribeiro, R. Marques, F.F. Rego, A. Sohoul, J. Portugal-Pereira, et al., Strategies towards a more sustainable aviation: A systematic review, *Prog. Aerosp. Sci.* 137 (2023) 100878, <http://dx.doi.org/10.1016/j.paerosci.2022.100878>.
- [68] V.K. Garg, Heat transfer research on gas turbine airfoils at NASA GRC, *Int. J. Heat Fluid Flow* 23 (2) (2002) 109–136, [http://dx.doi.org/10.1016/S0142-727X\(01\)00144-8](http://dx.doi.org/10.1016/S0142-727X(01)00144-8).
- [69] D. Giesecke, M. Lehmler, J. Friedrichs, J. Blinstrub, L. Bertsch, W. Heinze, Evaluation of ultra-high bypass ratio engines for an over-wing aircraft configuration, *J. Glob. Power Propuls. Soc.* 2 (2018) 493–515, <http://dx.doi.org/10.22261/JGPPS.85HP7K>.
- [70] D. Van Zante, F. Collier, A. Orton, S. Khalid, J. Wojno, T. Wood, Progress in open rotor propellers: The FAA/GE/NASA open rotor test campaign, *Aeronaut. J.* 118 (1208) (2014) 1181–1213, <http://dx.doi.org/10.1017/S0001924000009842>.
- [71] L. Langston, Open rotor engines - still an open question? *ASME Mech. Eng.* 140 (2) (2018) 46–48, <http://dx.doi.org/10.1115/1.2018-DEC-9>.
- [72] W.H. Heiser, D.T. Pratt, Thermodynamic cycle analysis of pulse detonation engines, *J. Propuls. Power* 18 (1) (2002) 68–76, <http://dx.doi.org/10.2514/2.5899>.
- [73] T. Grönstedt, M. Irannezhad, X. Lei, O. Thulin, A. Lundbladh, First and second law analysis of future aircraft engines, *J. Eng. Gas Turbines Power* 136 (3) (2014) 031202, <http://dx.doi.org/10.1115/1.4025727>.
- [74] N. Binder, Y. Bousquet, F. Hermet, J. Gressier, Physics and instantaneous performance of radial turbines in unsteady flows: Validity of the quasi-steady assumption for the rotor, *J. Turbomach.* 144 (11) (2022) <http://dx.doi.org/10.1115/1.4054777>.
- [75] V. Anand, A. St. George, E. Knight, E. Gutmark, Investigation of pulse detonation combustors — axial turbine system, *Aerosp. Sci. Technol.* 93 (2019) 105350, <http://dx.doi.org/10.1016/j.ast.2019.105350>.
- [76] Y. Bury, T. Jardin, A. Klöckner, Experimental investigation of the vortical activity in the close wake of a simplified military transport aircraft, *Exp. Fluids* 54 (5) (2013) 1–15, <http://dx.doi.org/10.1007/s00348-013-1524-4>.
- [77] Z.H. Han, J. Chen, K.S. Zhang, Z.M. Xu, Z. Zhu, W.P. Song, Aerodynamic shape optimization of natural-laminar-flow wing using surrogate-based approach, *AIAA J.* 56 (7) (2018) 2579–2593, <http://dx.doi.org/10.2514/1.056661>.
- [78] T. Saeed, W.R. Graham, Design study for a laminar-flying-wing aircraft, *J. Aircr.* 52 (5) (2015) <http://dx.doi.org/10.2514/1.C032862>.
- [79] W.R. Kruger, J. König, Editorial for the CEAS aeronautical journal special edition on smart fixed wing aircraft, WP 1.2 “Load Control”, *CEAS Aeronaut. J.* 10 (2019) 975–976, <http://dx.doi.org/10.1007/s13272-019-00418-w>.
- [80] J.E. Guerrero, D. Maestro, A. Bottaro, Biomimetic spiroid winglets for lift and drag control, *C. R. Méc.* 340 (1) (2012) 67–80, <http://dx.doi.org/10.1016/j.crme.2011.11.007>.
- [81] M.R. Chiarelli, M. Cagnoni, M. Ciabattari, M.D. Biasio, A. Massai, High aspect ratio wing with curved planform: CFD and FE analyses, in: *27th Congress of International Council of the Aeronautical Sciences*, 2010, p. 10.
- [82] G.J. Frank, J.J. Joo, B. Sanders, D.M. Garner, A.P. Murray, Mechanization of a high aspect ratio wing for aerodynamic control, *J. Intell. Mater. Syst. Struct.* 19 (9) (2008) 1101–1112, <http://dx.doi.org/10.1177/1045389X08096734>.
- [83] B. Montagne, Effet de l'interaction fixation composite sur les modes de rupture des assemblages boulonnées composites (Ph.D. thesis), Université de Toulouse, Institut Supérieur de l'Aéronautique et de l'Espace, 2020, URL: <http://www.theses.fr/2020ESAE0012/document>.
- [84] R. Huang, M. Riddle, D. Graziano, J. Warren, S. Das, S. Nimbalkar, J. Cresko, E. Masanet, Energy and emissions saving potential of additive manufacturing: the case of lightweight aircraft components, *J. Clean. Prod.* 135 (2016) 1559–1570, <http://dx.doi.org/10.1016/j.jclepro.2015.04.109>.
- [85] A. Bejan, J.D. Charles, S. Lorente, The evolution of airplanes, *J. Appl. Phys.* 116 (4) (2014) 044901, <http://dx.doi.org/10.1063/1.4886855>.

- [86] V. Madonna, P. Giangrande, M. Galea, Electrical power generation in aircraft: review, challenges and opportunities, *IEEE Trans. Transp. Electr.* 4 (3) (2018) 646–659, <http://dx.doi.org/10.1109/TTE.2018.2834142>.
- [87] X. Giraud, M. Budinger, X. Roboam, H. Piquet, M. Sartor, J. Faucher, Optimal design of the integrated modular power electronics cabinet, *Aerosp. Sci. Technol.* 48 (2016) 37–52, <http://dx.doi.org/10.1016/j.ast.2015.10.013>.
- [88] D. Van Den Bossche, The A380 flight control electrohydraulic actuators, achievements and lessons learnt, in: 25th Congress of the International Council of the Aeronautical Sciences, 2006, pp. 1–8.
- [89] J.C. Maré, *Aerospace Actuators 1: Needs, Reliability and Hydraulic Power Solutions*, John Wiley & Sons, 2016.
- [90] M. Sinnett, 787 No-bleed systems: Saving fuel and enhancing operational efficiencies, 2007.
- [91] W. Cao, B.C. Mecrow, G.J. Atkinson, J.W. Bennett, D.J. Atkinson, Overview of electric motor technologies used for more electric aircraft, *IEEE Trans. Ind. Electron.* 59 (9) (2012) 3523–3531, <http://dx.doi.org/10.1109/TIE.2011.2165453>.
- [92] A.C. Hoffman, I. Hansen, R. Beach, R. Plencner, R. Dengler, K. Jefferies, R. Frye, *Advanced Secondary Power System for Transport Aircraft*, Technical Report, NASA, 1985.
- [93] L. Faleiro, Summary of the European power optimised aircraft (POA) project, in: 25th Congress of the International Council of the Aeronautical Sciences, 2006, pp. 3–8.
- [94] N. Nagel, Actuation challenges in the more electric aircraft: Overcoming hurdles in the electrification of actuation systems, *IEEE Electr. Mag.* 5 (4) (2017) 38–45, <http://dx.doi.org/10.1109/MELE.2017.2755266>.
- [95] M. Budinger, V. Pommier-Budinger, A. Reysset, V. Palanque, Electromechanical resonant ice protection systems: Energetic and power considerations, *AIAA J.* (2021) 1–13, <http://dx.doi.org/10.2514/1.J060008>.
- [96] J.C. Maré, *Aerospace Actuators 2: Signal-By-Wire and Power-By-Wire*, Vol. 2, John Wiley & Sons, 2017.
- [97] P.D. Bravo-Mosquera, F.M. Catalano, D.W. Zingg, Unconventional aircraft for civil aviation: A review of concepts and design methodologies, *Prog. Aerosp. Sci.* 131 (2022) 100813, <http://dx.doi.org/10.1016/j.paerosci.2022.100813>.
- [98] N. Brazzola, A. Patt, J. Wohland, Definitions and implications of climate-neutral aviation, *Nature Clim. Change* 12 (8) (2022) 761–767, <http://dx.doi.org/10.1038/s41558-022-01404-7>.
- [99] R.H. Liebeck, Design of the blended wing body subsonic transport, *J. Aircr.* 41 (1) (2004) <http://dx.doi.org/10.2514/1.9084>.
- [100] A. Abbas, J. de Vicente, E. Valero, Aerodynamic technologies to improve aircraft performance, *Aerosp. Sci. Technol.* 28 (1) (2013) 100–132, <http://dx.doi.org/10.1016/j.ast.2012.10.008>.
- [101] J.J. Berton, W.J. Haller, A noise and emissions assessment of the N3-X transport, in: 52nd Aerospace Sciences Meeting, 2014, p. 0594, <http://dx.doi.org/10.2514/6.2014-0594>.
- [102] Y. Ma, S. Karpuk, A. Elham, Conceptual design and comparative study of strut-braced wing and twin-fuselage aircraft configurations with ultra-high aspect ratio wings, *Aerosp. Sci. Technol.* 121 (2022) 107395, <http://dx.doi.org/10.1016/j.ast.2022.107395>, URL: <https://www.sciencedirect.com/science/article/pii/S1270963822000694>.
- [103] A. Plas, D. Crichton, M. Sargeant, T. Hynes, E. Greitzer, C. Hall, V. Madani, Performance of a boundary layer ingesting (BLI) propulsion system, in: 45th AIAA Aerospace Sciences Meeting and Exhibit, 2007, p. 450, <http://dx.doi.org/10.2514/6.2007-450>.
- [104] N. Binder, Aéro-thermodynamique des Turbomachines en Fonctionnement Hors-Adaptation, in: *Habilitation à Diriger des Recherches*, Université de Toulouse, 2016, <http://dx.doi.org/10.13140/RG.2.2.29134.66889>.
- [105] C.L. Bowman, J.L. Felder, T. Marien, Turbo- and hybrid-electrified aircraft propulsion concepts for commercial transport, in: 2018 AIAA/IEEE Electric Aircraft Technologies Symposium, EATS, 2018, pp. 1–8, <http://dx.doi.org/10.2514/6.2018-4984>.
- [106] B.J. Brelje, J.R. Martins, Electric, hybrid, and turboelectric fixed-wing aircraft: A review of concepts, models, and design approaches, *Prog. Aerosp. Sci.* 104 (2019) 1–19, <http://dx.doi.org/10.1016/j.paerosci.2018.06.004>.
- [107] R. Jansen, C. Bowman, A. Jankovsky, R. Dyson, J. Felder, Overview of NASA electrified aircraft propulsion (EAP) research for large subsonic transports, in: 53rd AIAA/SAE/ASEE Joint Propulsion Conference, 2017, p. 4701, <http://dx.doi.org/10.2514/6.2017-4701>.
- [108] S. Sahoo, X. Zhao, K. Kyprianidis, A review of concepts, benefits, and challenges for future electrical propulsion-based aircraft, *Aerospace* 7 (4) (2020) <http://dx.doi.org/10.3390/aerospace7040044>.
- [109] J. Thauvin, Exploring the Design Space for a Hybrid-Electric Regional Aircraft with Multidisciplinary Design Optimisation Methods (Ph.D. thesis), Université de Toulouse, Institut National Polytechnique de Toulouse, 2018, URL: <https://www.theses.fr/2018INPT0092>.
- [110] J.L. Felder, *NASA Electric Propulsion System Studies*, Technical Report, National Aeronautics and Space Administration, 2015.
- [111] A.H. Epstein, S.M. O'Flarity, Considerations for Reducing Aviation's CO2 with Aircraft Electric Propulsion, *J. Propuls. Power* 35 (3) (2019) 572–582, <http://dx.doi.org/10.2514/1.B37015>.
- [112] R. Jansen, C.C. Kiris, T. Chau, L.M. Machado, J.C. Duensing, A. Mirhashemi, J. Chapman, B.D. French, L. Miller, J.S. Litt, et al., Subsonic single aft engine (SUSAN) transport aircraft concept and trade space exploration, in: AIAA Scitech 2022 Forum, 2022, p. 2179, <http://dx.doi.org/10.2514/6.2022-2179>.
- [113] M. Boll, M. Corduan, S. Biser, M. Filipenko, Q.H. Pham, S. Schlachter, P. Rostek, M. Noe, A holistic system approach for short range passenger aircraft with cryogenic propulsion system, *Supercond. Sci. Technol.* 33 (4) (2020) 044014, <http://dx.doi.org/10.1088/1361-6668/ab7779>.
- [114] IATA, *Aircraft Technology Roadmap to 2050*, IATA, 2019, URL: <https://www.iata.org/contentassets/8d19e716636a47c184e7221c77563c93/Technology-roadmap-2050.pdf>.
- [115] S. Delbecq, T. Planès, M. Delavenne, V. Pommier-Budinger, A. Joksimović, Aircraft fleet models using a bottom-up approach for simulating aviation technological prospective scenarios, in: 33rd Congress of the International Council of the Aeronautical Sciences, 2022.
- [116] A. Baroutaji, T. Wilberforce, M. Ramadan, A.G. Olabi, Comprehensive investigation on hydrogen and fuel cell technology in the aviation and aerospace sectors, *Renew. Sustain. Energy Rev.* 106 (2019) 31–40, <http://dx.doi.org/10.1016/j.rser.2019.02.022>.
- [117] H. Ishaq, I. Dincer, C. Crawford, A review on hydrogen production and utilization: Challenges and opportunities, *Int. J. Hydrogen Energy* 47 (62) (2022) 26238–26264, <http://dx.doi.org/10.1016/j.ijhydene.2021.11.149>.
- [118] M. Ji, J. Wang, Review and comparison of various hydrogen production methods based on costs and life cycle impact assessment indicators, *Int. J. Hydrogen Energy* 46 (78) (2021) 38612–38635, <http://dx.doi.org/10.1016/j.ijhydene.2021.09.142>.
- [119] A.I. Osman, N. Mehta, A.M. Elgarahy, M. Hefny, A. Al-Hinai, A.H. Al-Muhtaseb, D.W. Rooney, Hydrogen production, storage, utilisation and environmental impacts: a review, *Environ. Chem. Lett.* 20 (1) (2022) 153–188, <http://dx.doi.org/10.1007/s10311-021-01322-8>.
- [120] IEA, *Global Hydrogen Review 2022*, Technical Report, IEA, 2022.
- [121] S. Martinez-Villarreal, M. Kammoun, A. Richel, The critical role of hydrogen in the development of new biofuels, *Curr. Opin. Green Sustain. Chem.* 39 (2023) 100716, <http://dx.doi.org/10.1016/j.cogsc.2022.100716>.
- [122] S. de Jong, K. Antonissen, R. Hoefnagels, L. Lonza, M. Wang, A. Faaij, M. Junginger, Life-cycle analysis of greenhouse gas emissions from renewable jet fuel production, *Biotechnol. Biofuels* 10 (1) (2017) 64, <http://dx.doi.org/10.1186/s13068-017-0739-7>.
- [123] IEA, *Key world energy statistics 2021*, Technical Report, IEA, 2021.
- [124] P. Su-ungkavatin, L. Tiruta-Barna, L. Hamelin, Biofuels, electrofuels, electric or hydrogen?: A review of current and emerging sustainable aviation systems, *Prog. Energy Combust. Sci.* 96 (2023) 101073, <http://dx.doi.org/10.1016/j.pecs.2023.101073>.
- [125] V. Undavalli, O.B. Gbadamosi Olatunde, R. Boylu, C. Wei, J. Haeker, J. Hamilton, B. Khandelwal, Recent advancements in sustainable aviation fuels, *Prog. Aerosp. Sci.* 136 (2023) 100876, <http://dx.doi.org/10.1016/j.paerosci.2022.100876>.
- [126] EASA, *European Aviation Environmental Report*, Technical Report, EASA, 2022.
- [127] K. Dahal, S. Brynolf, C. Xisto, J. Hansson, M. Grahn, T. Grönstedt, M. Lehtveer, Techno-economic review of alternative fuels and propulsion systems for the aviation sector, *Renew. Sustain. Energy Rev.* 151 (2021) 111564, <http://dx.doi.org/10.1016/j.rser.2021.111564>.
- [128] N. Detsios, S. Theodoraki, L. Maragoudaki, K. Atsonios, P. Grammelis, N.G. Orfanoudakis, Recent advances on alternative aviation fuels/pathways: A critical review, *Energies* 16 (4) (2023) <http://dx.doi.org/10.3390/en16041904>.
- [129] X. Zhao, F. Taheripour, R. Malina, M.D. Staples, W.E. Tyler, Estimating induced land use change emissions for sustainable aviation biofuel pathways, *Sci. Total Environ.* (2021) 146238, <http://dx.doi.org/10.1016/j.scitotenv.2021.146238>.
- [130] S.A. Isaacs, M.D. Staples, F. Allroggen, D.S. Mallapragada, C.P. Falter, S.R.H. Barrett, Environmental and economic performance of hybrid power-to-liquid and biomass-to-liquid fuel production in the United States, *Environ. Sci. Technol.* 55 (12) (2021) 8247–8257, <http://dx.doi.org/10.1021/acs.est.0c07674>.
- [131] M. Micheli, D. Moore, V. Bach, M. Finkbeiner, Life-cycle assessment of power-to-liquid kerosene produced from renewable electricity and CO2 from direct air capture in Germany, *Sustainability* 14 (17) (2022) <http://dx.doi.org/10.3390/su141710658>.
- [132] R.W. Stratton, H.M. Wong, J.I. Hileman, *Life Cycle Greenhouse Gas Emission from Alternative Jet Fuels*, Technical Report, Partnership for Air Transportation Noise and Emissions Reduction, 2010.
- [133] M. Yugo, *Role of E-Fuels in the European Transport System – Literature Review*, Technical Report report no. 14/19, Concawe, 2020.
- [134] N. von der Assen, L.J. Müller, A. Steingrube, P. Voll, A. Bardow, Selecting CO2 sources for CO2 utilization by environmental-merit-order curves, *Environ. Sci. Technol.* 50 (3) (2016) 1093–1101, <http://dx.doi.org/10.1021/acs.est.5b03474>.
- [135] Z. Ai, N. Hanasaki, V. Heck, T. Hasegawa, S. Fujimori, Global bioenergy with carbon capture and storage potential is largely constrained by sustainable irrigation, *Nat. Sustain.* 4 (10) (2021) 884–891, <http://dx.doi.org/10.1038/s41893-021-00740-4>.

- [136] F. Creutzig, N.H. Ravindranath, G. Berndes, S. Bolwig, R. Bright, F. Cherubini, H. Chum, E. Corbera, M. Delucchi, A. Faaij, J. Fargione, H. Haberl, G. Heath, O. Lucon, R. Plevin, A. Popp, C. Robledo-Abad, S. Rose, P. Smith, A. Stromman, S. Suh, O. Masera, Bioenergy and climate change mitigation: an assessment, *GCB Bioenergy* 7 (5) (2015) 916–944, <http://dx.doi.org/10.1111/gcbb.12205>.
- [137] J.S. Naess, O. Cavalett, F. Cherubini, The land–energy–water nexus of global bioenergy potentials from abandoned cropland, *Nat. Sustain.* 4 (6) (2021) 525–536, <http://dx.doi.org/10.1038/s41893-020-00680-5>.
- [138] N.Z. Uludere Aragon, N.C. Parker, A. VanLoocke, J. Bagley, M. Wang, M. Georgescu, Sustainable land use and viability of biojet fuels, *Nat. Sustain.* 6 (2) (2023) 158–168, <http://dx.doi.org/10.1038/s41893-022-00990-w>.
- [139] N.E. Vaughan, C. Gough, S. Mander, E.W. Littleton, A. Welfle, D.E.H.J. Gernaat, D.P. van Vuuren, Evaluating the use of biomass energy with carbon capture and storage in low emission scenarios, *Environ. Res. Lett.* 13 (4) (2018) 044014, <http://dx.doi.org/10.1088/1748-9326/aaaa02>.
- [140] IPCC, in: P. Shukla, J. Skea, E. Calvo Buendia, V. Masson-Delmotte, H.O. Pörtner, D.C. Roberts, P. Zhai, R. Slade, S. Connors, R. van Diemen, M. Ferrat, E. Haughey, S. Luz, S. Neogi, M. Pathak, J. Petzold, J. Portugal Pereira, P. Vyas, E. Huntley, K. Kissick, M. Belkacemi, J. Malley (Eds.), *Climate Change and Land: IPCC special report on climate change, desertification, land degradation, sustainable land management, food security, and greenhouse gas fluxes in terrestrial ecosystems*, Cambridge University Press, 2022 (Chapter Summary for Policymakers).
- [141] R. Mawhood, E. Gazis, S. de Jong, R. Hoefnagels, R. Slade, Production pathways for renewable jet fuel: a review of commercialization status and future prospects, *Biofuels*, *Bioprod. Biorefin.* 10 (4) (2016) 462–484, <http://dx.doi.org/10.1002/bbb.1644>.
- [142] M. Wang, R. Dewil, K. Maniatis, J. Wheeldon, T. Tan, J. Baeyens, Y. Fang, Biomass-derived aviation fuels: Challenges and perspective, *Prog. Energy Combust. Sci.* 74 (2019) 31–49, <http://dx.doi.org/10.1016/j.pecs.2019.04.004>.
- [143] W.-C. Wang, L. Tao, Bio-jet fuel conversion technologies, *Renew. Sustain. Energy Rev.* 53 (2016) 801–822, <http://dx.doi.org/10.1016/j.rser.2015.09.016>.
- [144] H. Wei, W. Liu, X. Chen, Q. Yang, J. Li, H. Chen, Renewable bio-jet fuel production for aviation: A review, *Fuel* 254 (2019) 115599, <http://dx.doi.org/10.1016/j.fuel.2019.06.007>.
- [145] K. Lokesh, V. Sethi, T. Nikolaidis, E. Goodger, D. Nalianda, Life cycle greenhouse gas analysis of biojet fuels with a technical investigation into their impact on jet engine performance, *Biomass Bioenergy* 77 (2015) 26–44, <http://dx.doi.org/10.1016/j.biombioe.2015.03.005>.
- [146] F. Cheng, H. Luo, J.D. Jenkins, E.D. Larson, The value of low- and negative-carbon fuels in the transition to net-zero emission economies: Lifecycle greenhouse gas emissions and cost assessments across multiple fuel types, *Appl. Energy* 331 (2023) 120388, <http://dx.doi.org/10.1016/j.apenergy.2022.120388>.
- [147] J.L. Field, T.L. Richard, E.A.H. Smithwick, H. Cai, M.S. Laser, D.S. LeBauer, S.P. Long, K. Paustian, Z. Qin, J.J. Sheehan, P. Smith, M.Q. Wang, L.R. Lynd, Robust paths to net greenhouse gas mitigation and negative emissions via advanced biofuels, *Proc. Natl. Acad. Sci.* 117 (36) (2020) 21968–21977, <http://dx.doi.org/10.1073/pnas.1920877117>.
- [148] N. Johnson, N. Parker, J. Ogden, How negative can biofuels with CCS take us and at what cost? Refining the economic potential of biofuel production with CCS using spatially-explicit modeling, *Energy Procedia* 63 (2014) 6770–6791, <http://dx.doi.org/10.1016/j.egypro.2014.11.712>.
- [149] F. Leblanc, R. Bibas, S. Mima, M. Muratori, S. Sakamoto, F. Sano, N. Bauer, V. Daioglou, S. Fujimori, M.J. Gidden, E. Kato, S.K. Rose, J. Tsutsui, D.P. van Vuuren, J. Weyant, M. Wise, The contribution of bioenergy to the decarbonization of transport: a multi-model assessment, *Clim. Change* 170 (3) (2022) 21, <http://dx.doi.org/10.1007/s10584-021-03245-3>.
- [150] G. Liu, E.D. Larson, R.H. Williams, T.G. Kreutz, X. Guo, Making Fischer–Tropsch fuels and electricity from coal and biomass: Performance and cost analysis, *Energy Fuels* 25 (1) (2011) 415–437, <http://dx.doi.org/10.1021/ef101184e>.
- [151] M.E. Dry, The Fischer–Tropsch process: 1950–2000, *Catal. Today* 71 (3) (2002) 227–241, [http://dx.doi.org/10.1016/S0920-5861\(01\)00453-9](http://dx.doi.org/10.1016/S0920-5861(01)00453-9), Fischer–Tropsch synthesis on the eve of the XXI Century.
- [152] T.G. Kreutz, E.D. Larson, G. Liu, R.H. Williams, Fischer–Tropsch fuels from coal and biomass, in: *25th Annual International Pittsburgh Coal Conference*, Vol. 29, No. 2.10, 2008, International Pittsburgh Coal Conference Pittsburgh, Pennsylvania.
- [153] X. Li, P. Anderson, H.R.M. Jongh, M. Paster, J.F. Stubbins, P.J.A. Kenis, Greenhouse gas emissions, energy efficiency, and cost of synthetic fuel production using electrochemical CO₂ conversion and the Fischer–Tropsch process, *Energy Fuels* 30 (7) (2016) 5980–5989, <http://dx.doi.org/10.1021/acs.energyfuels.6b00665>.
- [154] J. O'Malley, N. Pavlenko, S. Searle, Estimating sustainable aviation fuel feedstock availability to meet growing European Union demand, Working Paper 2021–13, ICCT, 2021.
- [155] J. Han, A. Elgowainy, H. Cai, M.Q. Wang, Life-cycle analysis of bio-based aviation fuels, *Bioresour. Technol.* 150 (2013) 447–456, <http://dx.doi.org/10.1016/j.biortech.2013.07.153>.
- [156] S. de Jong, R. Hoefnagels, A. Faaij, R. Slade, R. Mawhood, M. Junginger, The feasibility of short-term production strategies for renewable jet fuels – a comprehensive techno-economic comparison, *Biofuels*, *Bioprod. Biorefin.* 9 (6) (2015) 778–800, <http://dx.doi.org/10.1002/bbb.1613>.
- [157] M. Pearson, C. Wollersheim, J. Hileman, A techno-economic review of hydroprocessed renewable esters and fatty acids for jet fuel production, *Biofuels*, *Bioprod. Biorefin.* 7 (1) (2013) 89–96, <http://dx.doi.org/10.1002/bbb.1378>.
- [158] M.D. Staples, R. Malina, H. Olcay, M.N. Pearson, J.I. Hileman, A. Boies, S.R.H. Barrett, Lifecycle greenhouse gas footprint and minimum selling price of renewable diesel and jet fuel from fermentation and advanced fermentation production technologies, *Energy Environ. Sci.* 7 (2014) 1545–1554, <http://dx.doi.org/10.1039/C3EE43655A>.
- [159] H. Haberl, Net land-atmosphere flows of biogenic carbon related to bioenergy: towards an understanding of systemic feedbacks, *Glob. Chang. Biol. Bioenergy* 5 (4) (2013) 351–357, <http://dx.doi.org/10.1111/gcbb.12071>.
- [160] H. Haberl, D. Sprinz, M. Bonazountas, P. Cocco, Y. Desaubies, M. Henze, O. Hertel, R.K. Johnson, U. Kastrop, P. Laconte, E. Lange, P. Novak, J. Paavola, A. Reenberg, S. van den Hove, T. Vermeire, P. Wadhams, T. Searchinger, Correcting a fundamental error in greenhouse gas accounting related to bioenergy, *Energy Policy* 45 (2012) 18–23, <http://dx.doi.org/10.1016/j.enpol.2012.02.051>.
- [161] T.D. Searchinger, Biofuels and the need for additional carbon, *Environ. Res. Lett.* 5 (2) (2010) 024007, <http://dx.doi.org/10.1088/1748-9326/5/2/024007>.
- [162] T.D. Searchinger, T. Beringer, A. Strong, Does the world have low-carbon bioenergy potential from the dedicated use of land? *Energy Policy* 110 (2017) 434–446, <http://dx.doi.org/10.1016/j.enpol.2017.08.016>.
- [163] EEA Scientific Committee, Opinion of the EEA Scientific Committee on Greenhouse Gas Accounting in Relation to Bioenergy, Technical Report, European Environment Agency, 2011.
- [164] EPA's Science Advisory Board, SAB Review of EPA's Accounting Framework for Biogenic CO₂ Emissions from Stationary Sources, Technical Report, United States Environmental Protection Agency, 2012.
- [165] P. Smith, M. Bustamante, H. Ahammad, H. Clark, H. Dong, E. Elsidig, H. Haberl, R. Harper, J. House, M. Jafari, O. Masera, C. Mbow, N. Ravindranath, C. Rice, C. Robledo Abad, A. Romanovskaya, F. Sperling, F. Tubiello, in: O. Edenhofer, R. Pichs-Madruga, Y. Sokona, E. Farahani, S. Kadner, K. Seyboth, A. Adler, I. Baum, S. Brunner, P. Eickemeier, B. Kriemann, J. Savolainen, S. Schlömer, C. von Stechow, Z. T., J. Minx (Eds.), *Climate Change 2014: Mitigation of Climate Change. Contribution of Working Group III to the Fifth Assessment Report of the Intergovernmental Panel on Climate Change*, Cambridge University Press, Cambridge, United Kingdom and New York, NY, USA, 2014 (Chapter Agriculture, Forestry and Other Land Use (AFOLU)).
- [166] M. Cames, R.O. Harthan, J. Füssler, M. Lazarus, C.M. Lee, P. Erickson, R. Spalding-Fecher, How Additional Is the Clean Development Mechanism? Öko-Institut e.V., 2016.
- [167] R.J. Plevin, M. O'Hare, A.D. Jones, M.S. Torn, H.K. Gibbs, Greenhouse gas emissions from biofuels' indirect land use change are uncertain but may be much greater than previously estimated, *Environ. Sci. Technol.* 44 (21) (2010) 8015–8021, <http://dx.doi.org/10.1021/es101946t>, PMID: 20942480.
- [168] Ecofys, E4tech, The Land Use Change Impact of Biofuels Consumed in the EU, Technical Report, European Commission, 2015.
- [169] J. Fargione, J. Hill, D. Tilman, S. Polasky, P. Hawthorne, Land clearing and the biofuel carbon debt, *Science* 319 (5867) (2008) 1235–1238, <http://dx.doi.org/10.1126/science.1152747>.
- [170] B. Holtmark, Harvesting in boreal forests and the biofuel carbon debt, *Clim. Change* 112 (2) (2012) 415–428, <http://dx.doi.org/10.1007/s10584-011-0222-6>.
- [171] D. Tilman, J. Hill, C. Lehman, Carbon-negative biofuels from low-input high-diversity grassland biomass, *Science* 314 (5805) (2006) 1598–1600, <http://dx.doi.org/10.1126/science.1133306>.
- [172] M. Prussi, U. Lee, M. Wang, R. Malina, H. Valin, F. Taheripour, C. Velarde, M.D. Staples, L. Lonza, J.I. Hileman, CORSIA: The first internationally adopted approach to calculate life-cycle GHG emissions for aviation fuels, *Renew. Sustain. Energy Rev.* 150 (2021) 111398, <http://dx.doi.org/10.1016/j.rser.2021.111398>.
- [173] M.D. Staples, R. Malina, P. Suresh, J.I. Hileman, S.R. Barrett, Aviation CO₂ emissions reductions from the use of alternative jet fuels, *Energy Policy* 114 (2018) 342–354, <http://dx.doi.org/10.1016/j.enpol.2017.12.007>.
- [174] P. Schmidt, W. Weindorf, A. Roth, V. Batteiger, F. Riegel, Power-To-Liquids: Potentials and Perspectives for the Future Supply of Renewable Aviation Fuel, Technical Report, German Environment Agency, 2016.
- [175] A. Christensen, C. Petrenko, CO₂-Based Synthetic Fuel: Assessment of Potential European Capacity and Environmental Performance, Technical Report, ICCT, 2017.
- [176] Transport & Environment, Electrofuels: What Role in EU Transport Decarbonisation?, Technical Report, Transport & Environment, 2017.
- [177] C. Malins, What Role Is There for Electrofuel Technologies in European Transport's Low Carbon Future? Technical Report, Cerulogy, 2017.
- [178] S. Searle, A. Christensen, Decarbonization Potential of Electrofuels in the European Union, Technical Report, ICCT, 2018.

- [179] P. Schmidt, W. Zittel, W. Weindorf, T. Raksha, *Renewables in Transport 2050*, Technical Report, FVV, 2016.
- [180] F. Ueckerdt, C. Bauer, A. Dirmaichner, J. Everall, R. Sacchi, G. Luderer, Potential and risks of hydrogen-based e-fuels in climate change mitigation, *Nature Clim. Change* 11 (5) (2021) 384–393, <http://dx.doi.org/10.1038/s41558-021-01032-7>.
- [181] A. Goldmann, W. Sauter, M. Oettinger, T. Kluge, U. Schröder, J.R. Seume, J. Friedrichs, F. Dinkelacker, A study on electrofuels in aviation, *Energies* 11 (2) (2018) 1–23, <http://dx.doi.org/10.3390/en11020392>.
- [182] P. Schmidt, V. Batteiger, A. Roth, W. Weindorf, T. Raksha, Power-to-liquids as renewable fuel option for aviation: A review, *Chem. Ing. Tech.* 90 (1–2) (2018) 127–140, <http://dx.doi.org/10.1002/cite.201700129>.
- [183] F.G. Albrecht, T.V. Nguyen, Prospects of electrofuels to defossilize transportation in Denmark – A techno-economic and ecological analysis, *Energy* 192 (2020) 116511, <http://dx.doi.org/10.1016/j.energy.2019.116511>.
- [184] S. Brynolf, M. Taljegård, M. Grahn, J. Hansson, Electrofuels for the transport sector: A review of production costs, *Renew. Sustain. Energy Rev.* 81 (2018) 1887–1905, <http://dx.doi.org/10.1016/j.rser.2017.05.288>.
- [185] S. Brynolf, J. Hansson, J.E. Anderson, I.R. Skov, T.J. Wallington, M. Grahn, A.D. Korberg, E. Malmgren, M. Taljegård, Review of electrofuel feasibility—prospects for road, ocean, and air transport, *Prog. Energy* 4 (4) (2022) 042007, <http://dx.doi.org/10.1088/2516-1083/ac8097>.
- [186] M. Fasihi, D. Bogdanov, C. Breyer, Techno-economic assessment of power-to-liquids (PtL) fuels production and global trading based on hybrid PV-wind power plants, *Energy Procedia* 99 (2016) 243–268, <http://dx.doi.org/10.1016/j.egypro.2016.10.115>.
- [187] M. Grahn, E. Malmgren, A.D. Korberg, M. Taljegård, J.E. Anderson, S. Brynolf, J. Hansson, I.R. Skov, T.J. Wallington, Review of electrofuel feasibility—cost and environmental impact, *Prog. Energy* 4 (3) (2022) 032010, <http://dx.doi.org/10.1088/2516-1083/ac7937>.
- [188] M. Lehtveer, S. Brynolf, M. Grahn, What future for electrofuels in transport? Analysis of cost competitiveness in global climate mitigation, *Environ. Sci. Technol.* 53 (3) (2019) 1690–1697, <http://dx.doi.org/10.1021/acs.est.8b05243>.
- [189] P. Smith, S.J. Davis, F. Creutzig, S. Fuss, J. Minx, B. Gabrielle, E. Kato, R.B. Jackson, A. Cowie, E. Kriegler, D.P. van Vuuren, J. Rogelj, P. Ciaia, J. Milne, J.G. Canadell, D. McCollum, G. Peters, R. Andrew, V. Krey, G. Shrestha, P. Friedlingstein, T. Gasser, A. Grübler, W.K. Heidug, M. Jonas, C.D. Jones, F. Kraxner, E. Littleton, J. Lowe, J. Moreira, N. Nakicenovic, M. Obersteiner, A. Patwardhan, M. Rogner, E. Rubin, A. Sharifi, A. Torvanger, Y. Yamagata, J. Edmonds, C. Yongsung, Biophysical and economic limits to negative CO₂ emissions, *Nature Clim. Change* 6 (1) (2016) 42–50, <http://dx.doi.org/10.1038/nclimate2870>.
- [190] C. van der Giesen, R. Kleijn, G.J. Kramer, Energy and Climate Impacts of Producing Synthetic Hydrocarbon Fuels from CO₂, *Environ. Sci. Technol.* 48 (12) (2014) 7111–7121, <http://dx.doi.org/10.1021/es500191g>.
- [191] C.M. Liu, N.K. Sandhu, S.T. McCoy, J.A. Bergerson, A life cycle assessment of greenhouse gas emissions from direct air capture and Fischer–Tropsch fuel production, *Sustain. Energy Fuels* 4 (2020) 3129–3142, <http://dx.doi.org/10.1039/C9SE00479C>.
- [192] D.H. König, N. Baucks, R.U. Dietrich, A. Wörner, Simulation and evaluation of a process concept for the generation of synthetic fuel from CO₂ and H₂, *Energy* 91 (2015) 833–841, <http://dx.doi.org/10.1016/j.energy.2015.08.099>.
- [193] M.M. Alhyari, A. Al-Salaymeh, M. Irshidat, M. Kaltschmitt, U. Neuling, The impact of energy source on the life-cycle assessment of power-to-liquid fuels, *J. Ecol. Eng.* 20 (4) (2019) 239–244, <http://dx.doi.org/10.12911/22998993/104659>.
- [194] M. Pehl, A. Arvesen, F. Humpenöder, A. Popp, E.G. Hertwich, G. Luderer, Understanding future emissions from low-carbon power systems by integration of life-cycle assessment and integrated energy modelling, *Nat. Energy* 2 (12) (2017) 939–945, <http://dx.doi.org/10.1038/s41560-017-0032-9>.
- [195] S. Drünert, U. Neuling, T. Zitscher, M. Kaltschmitt, Power-to-liquid fuels for aviation – processes, resources and supply potential under german conditions, *Appl. Energy* 277 (2020) 115578, <http://dx.doi.org/10.1016/j.apenergy.2020.115578>.
- [196] IEA, *The Future of Hydrogen*, Technical Report, IEA, 2019.
- [197] G. Zang, P. Sun, A. Elgowainy, A. Bafana, M. Wang, Life cycle analysis of electrofuels: Fischer–Tropsch fuel production from hydrogen and corn ethanol byproduct CO₂, *Environ. Sci. Technol.* 55 (6) (2021) 3888–3897, <http://dx.doi.org/10.1021/acs.est.0c05893>.
- [198] McKinsey & Company, *Hydrogen-Powered Aviation. A Fact-Based Study of Hydrogen Technology, Economics, and Climate Impact by 2050*, Technical Report, Clean Sky 2 JU and Fuel Cells and Hydrogen 2 JU, 2020.
- [199] The Royal Society, *Low Carbon Energy Programme Net Zero Aviation Fuels: Resource Requirements and Environmental Impacts*, Technical Report, The Royal Society, 2023.
- [200] M. Hillestad, M. Ostadi, G. Alamo Serrano, E. Rytter, B. Austbø, J. Pharoah, O. Burheim, Improving carbon efficiency and profitability of the biomass to liquid process with hydrogen from renewable power, *Fuel* 234 (2018) 1431–1451, <http://dx.doi.org/10.1016/j.fuel.2018.08.004>.
- [201] R.U. Dietrich, F.G. Albrecht, S. Maier, D.H. König, S. Estelmann, S. Adelung, Z. Bealu, A. Seitz, Cost calculations for three different approaches of biofuel production using biomass, electricity and CO₂, *Biomass Bioenergy* 111 (2018) 165–173, <http://dx.doi.org/10.1016/j.biombioe.2017.07.006>.
- [202] D. Unruh, K. Pabst, G. Schaub, Fischer–Tropsch syngas from biomass: Maximizing carbon efficiency and hydrocarbon yield, *Energy Fuels* 24 (4) (2010) 2634–2641, <http://dx.doi.org/10.1021/ef9009185>.
- [203] J. Weyand, F. Habermeyer, R.-U. Dietrich, Process design analysis of a hybrid power-and-biomass-to-liquid process – An approach combining life cycle and techno-economic assessment, *Fuel* 342 (2023) 127763, <http://dx.doi.org/10.1016/j.fuel.2023.127763>.
- [204] D. Hauglustaine, F. Paulot, W. Collins, R. Derwent, M. Sand, O. Boucher, Climate benefit of a future hydrogen economy, *Commun. Earth Environ.* 3 (1) (2022) 295, <http://dx.doi.org/10.1038/s43247-022-00626-z>.
- [205] R.G. Derwent, Global warming potential (GWP) for hydrogen: Sensitivities, uncertainties and meta-analysis, *Int. J. Hydrogen Energy* 48 (22) (2023) 8328–8341, <http://dx.doi.org/10.1016/j.ijhydene.2022.11.219>.
- [206] E.J. Adler, J.R.R.A. Martins, Hydrogen-powered aircraft: Fundamental concepts, key technologies, and environmental impacts, preprint.
- [207] C. Acar, I. Dincer, Comparative assessment of hydrogen production methods from renewable and non-renewable sources, *Int. J. Hydrogen Energy* 39 (1) (2014) 1–12, <http://dx.doi.org/10.1016/j.ijhydene.2013.10.060>.
- [208] I. Dincer, C. Acar, Review and evaluation of hydrogen production methods for better sustainability, *Int. J. Hydrogen Energy* 40 (34) (2015) 11094–11111, <http://dx.doi.org/10.1016/j.ijhydene.2014.12.035>.
- [209] O. Siddiqui, I. Dincer, A well to pump life cycle environmental impact assessment of some hydrogen production routes, *Int. J. Hydrogen Energy* 44 (12) (2019) 5773–5786, <http://dx.doi.org/10.1016/j.ijhydene.2019.01.118>.
- [210] U. Cardella, L. Decker, H. Klein, Economically viable large-scale hydrogen liquefaction, in: IOP Conference Series: Materials Science and Engineering, Vol.171, No. 1, IOP Publishing, 2017, 012013, <http://dx.doi.org/10.1088/1757-899X/171/1/012013>.
- [211] U. Cardella, L. Decker, H. Klein, Roadmap to economically viable hydrogen liquefaction, *Int. J. Hydrogen Energy* 42 (19) (2017) 13329–13338, <http://dx.doi.org/10.1016/j.ijhydene.2017.01.068>, Special Issue on The 21st World Hydrogen Energy Conference (WHEC 2016), 13–16 June 2016, Zaragoza, Spain.
- [212] J. Hoelzen, D. Silberhorn, T. Zill, B. Bensmann, R. Hanke-Rauschenbach, Hydrogen-powered aviation and its reliance on green hydrogen infrastructure – Review and research gaps, *Int. J. Hydrogen Energy* 47 (5) (2022) 3108–3130, <http://dx.doi.org/10.1016/j.ijhydene.2021.10.239>, *Hydrogen Energy and Fuel Cells*.
- [213] B. Khandelwal, A. Karakurt, P.R. Sekaran, V. Sethi, R. Singh, Hydrogen powered aircraft : The future of air transport, *Prog. Aerosp. Sci.* 60 (2013) 45–59, <http://dx.doi.org/10.1016/j.paerosci.2012.12.002>.
- [214] A. Gomez, H. Smith, Liquid hydrogen fuel tanks for commercial aviation: Structural sizing and stress analysis, *Aerosp. Sci. Technol.* 95 (2019) 105438, <http://dx.doi.org/10.1016/j.ast.2019.105438>.
- [215] J. Huete, D. Nalianda, P. Pilidis, Impact of tank gravimetric efficiency on propulsion system integration for a first-generation hydrogen civil airliner, *Aeronaut. J.* 126 (1302) (2022) 1324–1332, <http://dx.doi.org/10.1017/aer.2022.60>.
- [216] M. Prewitz, A. Bardenhagen, R. Beck, Hydrogen as the fuel of the future in aircrafts – Challenges and opportunities, *Int. J. Hydrogen Energy* 45 (46) (2020) 25378–25385, <http://dx.doi.org/10.1016/j.ijhydene.2020.06.238>.
- [217] S. Rondinelli, A. Gardi, R. Kapoor, R. Sabatini, Benefits and challenges of liquid hydrogen fuels in commercial aviation, *Int. J. Sustain. Aviat.* 3 (3) (2017) 200–216, <http://dx.doi.org/10.1504/IJSA.2017.086845>.
- [218] C. Winnefeld, T. Kadyk, B. Bensmann, U. Krewer, R. Hanke-Rauschenbach, Modelling and designing cryogenic hydrogen tanks for future aircraft applications, *Energies* 11 (1) (2018) <http://dx.doi.org/10.3390/en11010105>.
- [219] J. Mukhopadhyaya, D. Rutherford, *Performance Analysis of Evolutionary Hydrogen-Powered Aircraft*, Technical Report, ICCT, 2022.
- [220] J. Huete, P. Pilidis, Parametric study on tank integration for hydrogen civil aviation propulsion, *Int. J. Hydrogen Energy* 46 (74) (2021) 37049–37062, <http://dx.doi.org/10.1016/j.ijhydene.2021.08.194>.
- [221] D. Verstraete, On the energy efficiency of hydrogen-fuelled transport aircraft, *Int. J. Hydrogen Energy* 40 (23) (2015) 7388–7394, <http://dx.doi.org/10.1016/j.ijhydene.2015.04.055>.
- [222] G. Onorato, P. Proesmans, M.F.M. Hoogreef, Assessment of hydrogen transport aircraft, *CEAS Aeronaut. J.* 13 (4) (2022) 813–845, <http://dx.doi.org/10.1007/s13272-022-00601-6>.
- [223] P. Prashanth, Environmental Impacts of Future Aviation Propulsion Systems (Ph.D. thesis), Massachusetts Institute of Technology, 2023, URL: <https://hdl.handle.net/1721.1/150129>.
- [224] K. Gierens, Theory of contrail formation for fuel cells, *Aerospace* 8 (6) (2021) <http://dx.doi.org/10.3390/aerospace8060164>.
- [225] A.R. Gnadt, R.L. Speth, J.S. Sabnis, S.R. Barrett, Technical and environmental assessment of all-electric 180-passenger commercial aircraft, *Prog. Aerosp. Sci.* 105 (2019) 1–30, <http://dx.doi.org/10.1016/j.paerosci.2018.11.002>.

- [226] ADEME, Elaboration de scénarios de transition écologique du secteur aérien, Technical Report, ADEME, 2022, URL: <https://bibliothèque.ademe.fr/cadic/7365/elaboration-scenarios-transition-ecologique-secteur-aerien-rapport.pdf>.
- [227] J.S. Kurniawan, S. Khardi, Comparison of methodologies estimating emissions of aircraft pollutants, environmental impact assessment around airports, *Environ. Impact Assess. Rev.* 31 (3) (2011) 240–252, <http://dx.doi.org/10.1016/j.eiar.2010.09.001>.
- [228] L. Tsague, T.T. Tatietsé, J. Ngundam, J. Tsogo, Prediction of emissions in turbojet engines exhausts: relationship between nitrogen oxides emission index (EINOx) and the operational parameters, *Aerosp. Sci. Technol.* 11 (6) (2007) 459–463, <http://dx.doi.org/10.1016/j.ast.2007.04.005>.
- [229] S. Freeman, D.S. Lee, L.L. Lim, A. Skowron, R.R. De León, Trading off aircraft fuel burn and NOx emissions for optimal climate policy, *Environ. Sci. Technol.* 52 (5) (2018) 2498–2505, <http://dx.doi.org/10.1021/acs.est.7b05719>.
- [230] S. Rosanka, C. Frömming, V. Grewe, The impact of weather patterns and related transport processes on aviation's contribution to ozone and methane concentrations from NOx emissions, *Atmos. Chem. Phys.* 20 (20) (2020) 12347–12361, <http://dx.doi.org/10.5194/acp-20-12347-2020>.
- [231] C. Frömming, V. Grewe, S. Brinkop, P. Jöckel, A.S. Haslerud, S. Rosanka, J. van Manen, S. Matthes, Influence of weather situation on non-CO₂ aviation climate effects: the REACT4C climate change functions, *Atmos. Chem. Phys.* 21 (2021) 9151–9172, <http://dx.doi.org/10.5194/acp-21-9151-2021>.
- [232] M. Köhler, G. Rädcl, K. Shine, H. Rogers, J. Pyle, Latitudinal variation of the effect of aviation NOx emissions on atmospheric ozone and methane and related climate metrics, *Atmos. Environ.* 64 (2013) 1–9, <http://dx.doi.org/10.1016/j.atmosenv.2012.09.013>.
- [233] E. Terrenoire, D.A. Hauglustaine, Y. Cohen, A. Cozic, R. Valorso, F. Lefèvre, S. Matthes, Impact of present and future aircraft NOx and aerosol emissions on atmospheric composition and associated direct radiative forcing of climate, *Atmos. Chem. Phys.* 22 (18) (2022) 11987–12023, <http://dx.doi.org/10.5194/acp-22-11987-2022>.
- [234] A. Skowron, D.S. Lee, R.R. De León, L.L. Lim, B. Owen, Greater fuel efficiency is potentially preferable to reducing NO_x emissions for aviation's climate impacts, *Nature Commun.* 12 (1) (2021) 564, <http://dx.doi.org/10.1038/s41467-020-20771-3>.
- [235] H.W. Wong, R.C. Miake-Lye, Parametric studies of contrail ice particle formation in jet regime using microphysical parcel modeling, *Atmos. Chem. Phys.* 10 (7) (2010) 3261–3272, <http://dx.doi.org/10.5194/acp-10-3261-2010>.
- [236] J. Molloy, R. Teoh, S. Harty, G. Koudis, U. Schumann, I. Poll, M.E.J. Stettler, Design principles for a contrail-minimizing trial in the North Atlantic, *Aerospace* 9 (7) (2022) <http://dx.doi.org/10.3390/aerospace9070375>.
- [237] R. Teoh, U. Schumann, E. Gryspeerdt, M. Shapiro, J. Molloy, G. Koudis, C. Voigt, M.E.J. Stettler, Aviation contrail climate effects in the North Atlantic from 2016 to 2021, *Atmos. Chem. Phys.* 22 (16) (2022) 10919–10935, <http://dx.doi.org/10.5194/acp-22-10919-2022>.
- [238] U. Schumann, On conditions for contrail formation from aircraft exhausts, *Meteorol. Z.* 5 (1996) 4–23, <http://dx.doi.org/10.1127/metz/5/1996/4>.
- [239] K. Gierens, S. Matthes, S. Rohs, How well can persistent contrails be predicted? *Aerospace* 7 (12) (2020) <http://dx.doi.org/10.3390/aerospace7120169>.
- [240] H. Mannstein, P. Spichtinger, K. Gierens, A note on how to avoid contrail cirrus, *Transp. Res. D* 10 (5) (2005) 421–426, <http://dx.doi.org/10.1016/j.trd.2005.04.012>.
- [241] F. Baneshi, M. Soler, A. Simorgh, Conflict assessment and resolution of climate-optimal aircraft trajectories at network scale, *Transp. Res. D* 115 (2023) 103592, <http://dx.doi.org/10.1016/j.trd.2022.103592>.
- [242] R. Teoh, U. Schumann, A. Majumdar, M.E.J. Stettler, Mitigating the climate forcing of aircraft contrails by small-scale diversions and technology adoption, *Environ. Sci. Technol.* 54 (5) (2020) 2941–2950, <http://dx.doi.org/10.1021/acs.est.9b05608>.
- [243] J. Rosenow, H. Fricke, T. Luchkova, M. Schultz, Minimizing contrail formation by rerouting around dynamic ice-supersaturated regions, *Aeronaut. Aerosp. Open Access J.* 2 (3) (2018) 105–111, <http://dx.doi.org/10.15406/aoaj.2018.02.00039>.
- [244] K. Gierens, L. Lim, K. Eleftheratos, A review of various strategies for contrail avoidance, *Open Atmos. Sci. J.* 2 (2008) 1–7, <http://dx.doi.org/10.2174/1874282300802010001>.
- [245] K. Wolf, N. Bellouin, O. Boucher, Long-term upper-troposphere climatology of potential contrail occurrence over the Paris area derived from radiosonde observations, *Atmos. Chem. Phys.* 23 (1) (2023) 287–309, <http://dx.doi.org/10.5194/acp-23-287-2023>.
- [246] S. Matthes, U. Schumann, V. Grewe, C. Frömming, K. Dahlmann, A. Koch, H. Mannstein, *Atmospheric Physics: Background – Methods – Trends*, Springer Berlin Heidelberg, Berlin, Heidelberg, 2012, pp. 727–746, <http://dx.doi.org/10.1007/978-3-642-30183-4> (Chapter Climate Optimized Air Transport).
- [247] S. Matthes, B. Lühns, K. Dahlmann, V. Grewe, F. Linke, F. Yin, E. Klingaman, K.P. Shine, Climate-optimized trajectories and robust mitigation potential: Flying atm4e, *Aerospace* 7 (11) (2020) 156, <http://dx.doi.org/10.3390/aerospace7110156>.
- [248] A. Simorgh, M. Soler, D. González-Arribas, S. Matthes, V. Grewe, S. Dietmüller, S. Baumann, H. Yamashita, F. Yin, F. Castino, F. Linke, B. Lühns, M.M. Meuser, A comprehensive survey on climate optimal aircraft trajectory planning, *Aerospace* 9 (3) (2022) <http://dx.doi.org/10.3390/aerospace9030146>.
- [249] A.M. Boies, M.E.J. Stettler, J.J. Swanson, T.J. Johnson, J.S. Olfert, M. Johnson, M.L. Eggersdorfer, T. Rindlisbacher, J. Wang, K. Thomson, G. Smallwood, Y. Sevenco, D. Walters, P.I. Williams, J. Corbin, A.A. Mensah, J. Symonds, R. Dastanpour, S.N. Rogak, Particle emission characteristics of a gas turbine with a double annular combustor, *Aerosol Sci. Technol.* 49 (9) (2015) 842–855, <http://dx.doi.org/10.1080/02786826.2015.1078452>.
- [250] F. Yin, V. Grewe, K. Gierens, Impact of hybrid-electric aircraft on contrail coverage, *Aerospace* 7 (10) (2020) <http://dx.doi.org/10.3390/aerospace7100147>.
- [251] R.H. Moore, K.L. Thornhill, B. Weinzierl, D. Sauer, E. D'Ascoli, J. Kim, M. Lichtenstern, M. Scheibe, B. Beaton, A.J. Beyersdorff, J. Barrick, D. Bulzan, C.A. Corr, E. Crosbie, T. Jurkat, R. Martin, D. Riddick, M. Shook, G. Slover, C. Voigt, R. White, E. Winstead, R. Yasky, L.D. Ziemba, A. Brown, H. Schlager, B.E. Anderson, Biofuel blending reduces particle emissions from aircraft engines at cruise conditions, *Nature* 543 (7645) (2017) 411–415, <http://dx.doi.org/10.1038/nature21420>.
- [252] B. Kärcher, C. Voigt, Susceptibility of contrail ice crystal numbers to aircraft soot particle emissions, *Geophys. Res. Lett.* 44 (15) (2017) 8037–8046, <http://dx.doi.org/10.1002/2017GL074949>.
- [253] C. Rojo, X. Vancassel, P. Mirabel, J.L. Ponche, F. Garnier, Impact of alternative jet fuels on aircraft-induced aerosols, *Fuel* 144 (2015) 335–341, <http://dx.doi.org/10.1016/j.fuel.2014.12.021>.
- [254] C. Voigt, J. Kleine, D. Sauer, R.H. Moore, T. Bräuer, P. Le Clercq, S. Kaufmann, M. Scheibe, T. Jurkat-Witschas, M. Aigner, U. Bauder, Y. Boose, S. Borrmann, E. Crosbie, G.S. Diskin, J. DiGangi, V. Hahn, C. Heckl, F. Huber, J.B. Nowak, M. Rapp, B. Rauch, C. Robinson, T. Schripp, M. Shook, E. Winstead, L. Ziemba, H. Schlager, B.E. Anderson, Cleaner burning aviation fuels can reduce contrail cloudiness, *Commun. Earth Environ.* 2 (114) (2021) <http://dx.doi.org/10.1038/s43247-021-00174-y>.
- [255] U. Burkhardt, L. Bock, A. Bier, Mitigating the contrail cirrus climate impact by reducing aircraft soot number emissions, *npj Clim. Atmos. Sci.* 1 (1) (2018) 37, <http://dx.doi.org/10.1038/s41612-018-0046-4>.
- [256] M. Ponater, S. Pechtl, R. Sausen, U. Schumann, G. Hüttig, Potential of the cryoplane technology to reduce aircraft climate impact: A state-of-the-art assessment, *Atmos. Environ.* 40 (36) (2006) 6928–6944, <http://dx.doi.org/10.1016/j.atmosenv.2006.06.036>.
- [257] K. Dahlmann, S. Matthes, H. Yamashita, S. Unterstrasser, V. Grewe, T. Marks, Assessing the climate impact of formation flights, *Aerospace* 7 (12) (2020) <http://dx.doi.org/10.3390/aerospace7120172>.
- [258] T. Marks, K. Dahlmann, V. Grewe, V. Gollnick, F. Linke, S. Matthes, E. Stumpf, M. Swaid, S. Unterstrasser, H. Yamashita, C. Zumege, Climate impact mitigation potential of formation flight, *Aerospace* 8 (1) (2021) <http://dx.doi.org/10.3390/aerospace8010014>.
- [259] S. Unterstrasser, The contrail mitigation potential of aircraft formation flight derived from high-resolution simulations, *Aerospace* 7 (12) (2020) <http://dx.doi.org/10.3390/aerospace7120170>.
- [260] C. Breitsamter, Wake vortex characteristics of transport aircraft, *Prog. Aerosp. Sci.* 47 (2) (2011) 89–134, <http://dx.doi.org/10.1016/j.paerosci.2010.09.002>.
- [261] S.C. Crow, Stability theory for a pair of trailing vortices, *AIAA J.* 8 (12) (1970) 2172–2179, <http://dx.doi.org/10.2514/3.6083>.
- [262] J.D. Crouch, G.D. Miller, P.R. Spalart, Active-control system for breakup of airplane trailing vortices, *AIAA J.* 39 (12) (2001) 2374–2381, <http://dx.doi.org/10.2514/2.1244>.
- [263] V. Brion, D. Sipp, L. Jacquin, Optimal amplification of the crow instability, *Phys. Fluids* 19 (11) (2007) 111703, <http://dx.doi.org/10.1063/1.2793146>.
- [264] ATAG, Waypoint 2050, Technical Report, second ed., ATAG, 2021, URL: <https://aviationbenefits.org/environmental-efficiency/climate-action/waypoint-2050/>.
- [265] M. Cames, J. Graichen, A. Siemons, V. Cook, Emission Reduction Targets for International Aviation and Shipping, European Parliamentary Research Service, EPRS, 2015.
- [266] A.S. Oliveira, M.D. de Barros, F. de Carvalho Pereira, C.F.S. Gomes, H.G. da Costa, Prospective scenarios: A literature review on the scopus database, *Futures* 100 (2018) 20–33, <http://dx.doi.org/10.1016/j.futures.2018.03.005>.
- [267] J. Beevor, K. Alexander, Missed Targets: a Brief History of Aviation Climate Targets of the Early 21st Century, Technical Report, Green Gumption for Possible, 2022.
- [268] ATAG, Aviation Industry Position on the Development of a Long-Term Climate Goal at ICAO, ATAG, 2022, URL: https://www.atag.org/media/2npsc3a1/position-paper_icao-a41-ltag_jun2022-1.pdf.
- [269] ATAG, Waypoint 2050, Technical Report, ATAG, 2020.
- [270] ATAG, Commitment to Fly Net Zero in 2050, ATAG, 2021, URL: <https://aviationbenefits.org/media/167501/atag-net-zero-2050-declaration.pdf>.
- [271] ICAO, Assembly Resolutions in Force (As of 8 October 2010), Technical Report, ICAO, 2011.

- [272] ICAO, Assembly Resolutions in Force (As of 7 October 2022), Technical Report, ICAO, 2022.
- [273] High-Level Group on Aviation Research, Flightpath 2050 – Europe's Vision for Aviation: Maintaining Global Leadership and Serving Society's Needs, Technical Report, European commission, 2012, URL: <https://op.europa.eu/fr/publication-detail/-/publication/7d834950-1f5e-480f-ab70-ab96e4a0a0ad>.
- [274] ACARE, Fly the Green Deal – Europe's Vision for Sustainable Aviation, Technical Report, European commission, 2022, URL: <https://www.acare4europe.org/news/fly-the-green-deal-europes-vision-for-sustainable-aviation/>.
- [275] NLR and SEO Amsterdam Economics, Destination 2050 – A Route to Net Zero European Aviation, Technical Report, A4E (Airlines for Europe), ACI EUROPE (Airports Council International-EUROPE), ASD (Aerospace & Defence Industries Association of Europe), CANSO (Civil Air Navigation Services Organisation), ERA (European Regions Airline Association), 2021, URL: <https://www.destination2050.eu/>.
- [276] ICAO, ICAO Environmental Report 2019 – Chapter 6. Climate Change Mitigation: CORSIA, ICAO, 2019.
- [277] European Commission, Reducing emissions from aviation, 2012, URL: https://ec.europa.eu/clima/eu-action/transport-emissions/reducing-emissions-aviation_en.
- [278] S. Arrowsmith, D.S. Lee, B. Owen, J. Faber, L. van Wijngaarden, O. Boucher, A. Celikel, R. Deransy, J. Fuglestedt, J. Laukia, M. Tronstad Lund, R. Sausen, M. Schaefer, A. Skowron, S. Stromatas, A. Watt, Updated Analysis of the Non-CO2 Climate Impacts of Aviation and Potential Policy Measures Pursuant to the EU Emissions Trading System Directive Article 30(4), Technical Report, European Commission, 2020.
- [279] European Commission, Sustainable aviation fuels – ReFuelEU aviation, 2020, URL: https://ec.europa.eu/info/law/better-regulation/have-your-say/initiatives/12303-Sustainable-aviation-fuels-ReFuelEU-Aviation_en.
- [280] ICAO Committee on aviation environmental protection, Report on the Feasibility of a Long-Term Aspirational Goal (LTAG) for International Civil Aviation CO₂ Emission Reductions, ICAO, 2022, URL: https://www.icao.int/environmental-protection/LTAG/Documents/REPORT_ON_THE_FEASIBILITY_OF_A_LONG-TERM_ASPIRATIONAL_GOAL_en.pdf.
- [281] B. Graver, S. Zheng, D. Rutherford, J. Mukhopadhyaya, E. Pronk, Vision 2050 – Aligning Aviation with the Paris Agreement, ICCT (International Council on Clean Transportation), 2022, URL: <https://theicct.org/publication/global-aviation-vision-2050-align-aviation-paris-jun22/>.
- [282] A. Vedantham, M. Oppenheimer, Long-term scenarios for aviation: Demand and emissions of CO₂ and NO_x, Energy Policy 26 (8) (1998) 625–641, [http://dx.doi.org/10.1016/S0301-4215\(98\)00021-4](http://dx.doi.org/10.1016/S0301-4215(98)00021-4).
- [283] J. Åkerman, Sustainable air transport — On track in 2050, Transp. Res. D 10 (2005) 111–126, <http://dx.doi.org/10.1016/j.trd.2004.11.001>.
- [284] J. Åkerman, Transport Systems Meeting Long-Term Climate Targets: A Back-casting Approach Including International Aviation (Ph.D. thesis), KTH Royal Institute of Technology, 2011.
- [285] K. Mayor, R.S. Tol, Scenarios of carbon dioxide emissions from aviation, Global Environ. Change 20 (1) (2010) 65–73, <http://dx.doi.org/10.1016/j.gloenvcha.2009.08.001>.
- [286] B. Owen, D.S. Lee, L. Lim, Flying into the future: Aviation emissions scenarios to 2050, in: Environmental Science & Technology, Environ. Sci. Technol. 44 (7) (2010) 2255–2260, <http://dx.doi.org/10.1021/es902530z>.
- [287] S.V. Gudmundsson, A. Anger, Global carbon dioxide emissions scenarios for aviation derived from IPCC storylines: A meta-analysis, Transp. Res. D 17 (1) (2012) 61–65, <http://dx.doi.org/10.1016/j.trd.2011.09.010>.
- [288] E. Terrenoire, D.A. Hauglustaine, T. Gasser, O. Penanhoat, The contribution of carbon dioxide emissions from the aviation sector to future climate change, Environ. Res. Lett. 14 (8) (2019) 084019, <http://dx.doi.org/10.1088/1748-9326/ab3086>.
- [289] T. Stocker, D. Qin, G.K. Plattner, M. Tignor, S. Allen, J. Boschung, A. Nauels, Y. Xia, V. Bex, P. Midgley, in: T. Stocker, D. Qin, G.K. Plattner, M. Tignor, S. Allen, J. Boschung, A. Nauels, Y. Xia, V. Bex, P. Midgley (Eds.), Climate Change 2013: the Physical Science Basis. Contribution of Working Group I to the Fifth Assessment Report of the Intergovernmental Panel on Climate Change, Cambridge University Press, 2013 (Chapter Summary for Policymakers).
- [290] C.C. Ivanovich, I.B. Ocko, P. Piris-Cabezas, A. Petsonk, Climate benefits of proposed carbon dioxide mitigation strategies for international shipping and aviation, Atmos. Chem. Phys. 19 (23) (2019) 14949–14965, <http://dx.doi.org/10.5194/acp-19-14949-2019>.
- [291] S. Gössling, A. Humpe, Net-zero aviation: Time for a new business model? J. Air Transp. Manag. 107 (2023) 102353, <http://dx.doi.org/10.1016/j.jairtraman.2022.102353>.
- [292] S. Gössling, A. Humpe, F. Fichert, F. Creutzig, COVID-19 and pathways to low-carbon air transport until 2050, Environ. Res. Lett. 16 (3) (2021) 034063, <http://dx.doi.org/10.1088/1748-9326/abe90b>.
- [293] V. Grewe, A. Gangoli Rao, T. Grönstedt, C. Xisto, F. Linke, J. Melkert, J. Middel, B. Ohlenforst, S. Blakey, S. Christie, et al., Evaluating the climate impact of aviation emission scenarios towards the Paris agreement including COVID-19 effects, Nature Commun. 12 (1) (2021) 1–10, <http://dx.doi.org/10.1038/s41467-021-24091-y>.
- [294] D.S. Lee, International Aviation and the Paris Agreement Temperature, Technical Report, Manchester Metropolitan University, 2018.
- [295] ISAE-SUPAERO, AeroMAPS, 2023, URL: <https://aeromaps.isae-supaero.fr/>.
- [296] T. Planès, Du dimensionnement de systèmes et d'architectures en conception avion à la simulation de scénarios prospectifs durables pour le transport aérien (Ph.D. thesis), Université de Toulouse, Institut Supérieur de l'Aéronautique et de l'Espace, 2022, URL: <https://www.theses.fr/2022ESAE0059>.
- [297] A. Salgas, T. Planès, S. Delbecq, F. Simatos, G. Lafforgue, Cost estimation of the use of low-carbon fuels in prospective scenarios for air transport, in: AIAA SCITECH 2023 Forum, 2023, p. 2328, <http://dx.doi.org/10.2514/6.2023-2328>.
- [298] M. Klöwer, M. Allen, D. Lee, S. Proud, L. Gallagher, A. Skowron, Quantifying aviation's contribution to global warming, Environ. Res. Lett. 16 (10) (2021) 104027, <http://dx.doi.org/10.1088/1748-9326/ac286e>.
- [299] M. Sharmina, O.Y. Edelenbosch, C. Wilson, R. Freeman, D. Gernaat, P. Gilbert, A. Larkin, E. Littleton, M. Traut, D.P. van Vuuren, et al., Decarbonising the critical sectors of aviation, shipping, road freight and industry to limit warming to 1.5–2 °C, Clim. Policy 21 (4) (2021) 455–474, <http://dx.doi.org/10.1080/14693062.2020.1831430>.
- [300] S. Becken, B. Mackey, What role for offsetting aviation greenhouse gas emissions in a deep-cut carbon world? J. Air Transp. Manag. 63 (2017) 71–83, <http://dx.doi.org/10.1016/j.jairtraman.2017.05.009>.
- [301] J. Scheelhaese, S. Maertens, W. Grimme, M. Jung, EU ETS versus CORSIA—A critical assessment of two approaches to limit air transport's CO₂ emissions by market-based measures, J. Air Transp. Manag. 67 (2018) 55–62, <http://dx.doi.org/10.1016/j.jairtraman.2017.11.007>.
- [302] ICF Consulting, Air Transportation Analytics, NewClimate Institute, Cambridge Econometrics, HFW, Sven Starck, Assessment of ICAO's Global Market-Based Measure (CORSIA) Pursuant to Article 28b and for Studying Cost Pass- Through Pursuant to Article 3d of the EU ETS Directive, Technical Report, European Commission, 2020.
- [303] IPCC, in: P. Shukla, J. Skea, R. Slade, A.A. Khoualdjia, R. van Diemen, D. McCollum, M. Pathak, S. Some, P. Vyas, R. Fradera, M. Belkacemi, A. Hasija, G. Lisboa, S. Luz, J. Malley (Eds.), Climate Change 2022: Mitigation of Climate Change. Contribution of Working Group III to the Sixth Assessment Report of the Intergovernmental Panel on Climate Change, Cambridge University Press, Cambridge, UK and New York, NY, USA, 2022 (Chapter 3 Mitigation pathways compatible with long-term goals).
- [304] J. Randers, 2052: A Global Forecast for the Next Forty Years, Chelsea Green Publishing, 2012.
- [305] L. Dray, A. Evans, T. Reynolds, A.W. Schäfer, M. Vera-Morales, W. Bosbach, Airline fleet replacement funded by a carbon tax: An integrated assessment, Transp. Policy 34 (2014) 75–84, <http://dx.doi.org/10.1016/j.tranpol.2014.02.021>.
- [306] L.M. Dray, P. Krammer, K. Doyme, B. Wang, K. Al Zayat, A. O'Sullivan, A.W. Schäfer, AIM2015: Validation and initial results from an open-source aviation systems model, Transp. Policy 79 (2019) 93–102, <http://dx.doi.org/10.1016/j.tranpol.2019.04.013>.
- [307] B. Aamaas, G. Peters, J. Fuglestedt, Simple emission metrics for climate impacts, Earth Syst. Dyn. 4 (1) (2013) 145–170, <http://dx.doi.org/10.5194/esd-4-145-2013>.
- [308] M.R. Allen, K.P. Shine, J.S. Fuglestedt, R.J. Millar, M. Cain, D.J. Frame, A.H. Macey, A solution to the misrepresentations of CO₂-equivalent emissions of short-lived climate pollutants under ambitious mitigation, npj Clim. Atmos. Sci. 1 (1) (2018) 1–8, <http://dx.doi.org/10.1038/s41612-018-0026-8>.
- [309] M. Cain, J. Lynch, M.R. Allen, J.S. Fuglestedt, D.J. Frame, A.H. Macey, Improved calculation of warming-equivalent emissions for short-lived climate pollutants, npj Clim. Atmos. Sci. 2 (1) (2019) 1–7, <http://dx.doi.org/10.1038/s41612-019-0086-4>.
- [310] J. Lynch, M. Cain, R. Pierrehumbert, M. Allen, Demonstrating GWP*: A means of reporting warming-equivalent emissions that captures the contrasting impacts of short-and long-lived climate pollutants, Environ. Res. Lett. 15 (4) (2020) 044023, <http://dx.doi.org/10.1088/1748-9326/ab6d7e>.
- [311] T. Gasser, P. Ciaia, O. Boucher, Y. Quilcaille, M. Tortora, L. Bopp, D. Hauglustaine, The compact earth system model OSCAR v2.2: description and first results, Geosci. Model Dev. (2017) <http://dx.doi.org/10.5194/gmd-10-271-2017>.
- [312] M. Meinshausen, S.C. Raper, T.M. Wigley, Emulating coupled atmosphere-ocean and carbon cycle models with a simpler model, MAGICC6–Part 1: Model description and calibration, Atmos. Chem. Phys. 11 (4) (2011) 1417–1456, <http://dx.doi.org/10.5194/acp-11-1417-2011>.
- [313] M. Meinshausen, T. Wigley, S. Raper, Emulating atmosphere-ocean and carbon cycle models with a simpler model, MAGICC6–Part 2: Applications, Atmos. Chem. Phys. 11 (4) (2011) 1457–1471, <http://dx.doi.org/10.5194/acp-11-1457-2011>.
- [314] C.J. Smith, P.M. Forster, M. Allen, N. Leach, R.J. Millar, G.A. Passerello, L.A. Regayre, FAIR v1.3: a simple emissions-based impulse response and carbon cycle model, Geosci. Model Dev. 11 (6) (2018) 2273–2297, <http://dx.doi.org/10.5194/gmd-11-2273-2018>.

- [315] N.J. Leach, S. Jenkins, Z. Nicholls, C.J. Smith, J. Lynch, M. Cain, T. Walsh, B. Wu, J. Tsutsui, M.R. Allen, FaIR v2.0.0: a generalized impulse response model for climate uncertainty and future scenario exploration, *Geosci. Model Dev.* 14 (5) (2021) 3007–3036, <http://dx.doi.org/10.5194/gmd-14-3007-2021>.
- [316] V. Grewe, A. Stenke, AirClim: an efficient tool for climate evaluation of aircraft technology, *Atmos. Chem. Phys.* 8 (16) (2008) 4621–4639, <http://dx.doi.org/10.5194/acp-8-4621-2008>.
- [317] C. Grobler, P.J. Wolfe, K. Dasadhikari, I.C. Dedoussi, F. Allroggen, R.L. Speth, S.D. Eastham, A. Agarwal, M.D. Staples, J. Sabnis, et al., Marginal climate and air quality costs of aviation emissions, *Environ. Res. Lett.* 14 (11) (2019) 114031, <http://dx.doi.org/10.1088/1748-9326/ab4942>.
- [318] S. de Jong, M. Staples, C. Grobler, V. Daioglou, R. Malina, S. Barrett, R. Hoefnagels, A. Faaij, M. Junginger, Using dynamic relative climate impact curves to quantify the climate impact of bioenergy production systems over time, *GCB Bioenergy* 11 (2) (2019) 427–443, <http://dx.doi.org/10.1111/gcbb.12573>.
- [319] *Thales, Towards Eco-Friendly Operations, Technical Report, Thales Group, 2021.*
- [320] M. Wise, M. Muratori, P. Kyle, Biojet fuels and emissions mitigation in aviation: An integrated assessment modeling analysis, *Transp. Res. D* 52 (2017) 244–253, <http://dx.doi.org/10.1016/j.trd.2017.03.006>.
- [321] A. O'Connell, M. Kousoulidou, L. Lanza, W. Weindorf, Considerations on GHG emissions and energy balances of promising aviation biofuel pathways, *Renew. Sustain. Energy Rev.* 101 (2019) 504–515, <http://dx.doi.org/10.1016/j.rser.2018.11.033>.
- [322] *IRENA, World Energy Transitions Outlook, Technical Report, IRENA, 2021.*
- [323] IPCC, in: V. Masson-Delmotte, P. Zhai, H.O. Pörtner, D. Roberts, J. Skea, P. Shukla, A. Pirani, W. Moufouma-Okia, C. Péan, R. Pidcock, S. Connors, J. Matthews, Y. Chen, X. Zhou, M. Gomis, E. Lonnoy, T. Maycock, M. Tignor, T. Waterfield (Eds.), *Global Warming of 1.5 °C. An IPCC Special Report on the Impacts of Global Warming of 1.5 °C Above Pre-Industrial Levels and Related Global Greenhouse Gas Emission Pathways, in the Context of Strengthening the Global Response to the Threat of Climate Change, Sustainable Development, and Efforts to Eradicate Poverty*, Cambridge University Press, Cambridge, United Kingdom and New York, NY, USA, 2018 (Chapter Summary for Policymakers).
- [324] *IEA, World Energy Outlook 2021, Technical Report, IEA, 2021.*
- [325] *ICAO Committee on aviation environmental protection, Technical Report, ICAO, 2019.*
- [326] *IEA, Renewables 2019, Technical Report, IEA, 2019.*
- [327] *ICAO Committee on aviation environmental protection, Environmental Report, Technical Report, ICAO, 2022.*
- [328] S. Searle, C. Malins, A reassessment of global bioenergy potential in 2050, *GCB Bioenergy* 7 (2) (2015) 328–336, <http://dx.doi.org/10.1111/gcbb.12141>.
- [329] D. Chiamonti, G. Talluri, N. Scarlat, M. Prussi, The challenge of forecasting the role of biofuel in EU transport decarbonisation at 2050: A meta-analysis review of published scenarios, *Renew. Sustain. Energy Rev.* 139 (2021) 110715, <http://dx.doi.org/10.1016/j.rser.2021.110715>.
- [330] M. Lim, M. Luckert, F. Qiu, Economic opportunities and challenges in biojet production: A literature review and analysis, *Biomass Bioenergy* 170 (2023) 106727, <http://dx.doi.org/10.1016/j.biombioe.2023.106727>.
- [331] G.B. Gratton, P.D. Williams, A. Padhra, S. Rapsomanikis, Reviewing the impacts of climate change on air transport operations, *Aeronaut. J.* 126 (1295) (2022) 209–221, <http://dx.doi.org/10.1017/aer.2021.109>.
- [332] S. Molnos, S. Petri, J. Lehmann, E. Peukert, D. Coumou, The sensitivity of the large-scale atmosphere circulation to changes in surface temperature gradients in the Northern Hemisphere, *Earth Syst. Dyn. Discuss.* 2017 (2017) 1–17, <http://dx.doi.org/10.5194/esd-2017-65>.
- [333] P. Arias, N. Bellouin, E. Coppola, R. Jones, G. Krinner, J. Marotzke, V. Naik, M. Palmer, G.K. Plattner, J. Rogelj, M. Rojas, J. Sillmann, T. Storelvmo, P. Thorne, B. Trewin, K. Achuta Rao, B. Adhikary, R. Allan, K. Armour, G. Bala, R. Barimalala, S. Berger, J. Canadell, C. Cassou, A. Cherchi, W. Collins, W. Collins, S. Connors, S. Corti, F. Cruz, F. Dentener, C. Dereczynski, A. Di Luca, A. Diongue Niang, F. Doblas-Reyes, A. Dosio, H. Douville, F. Engelbrecht, V. Eyring, E. Fischer, P. Forster, B. Fox-Kemper, J. Fuglestedt, J. Fyfe, N. Gillett, L. Goldfarb, I. Gorodetskaya, J. Gutierrez, R. Hamdi, E. Hawkins, H. Hewitt, P. Hope, A. Islam, C. Jones, D. Kaufman, R. Kopp, Y. Kosaka, J. Kossin, S. Krakovska, J.Y. Lee, J. Li, T. Mauritsen, T. Maycock, M. Meinshausen, S.K. Min, P. Monteiro, T. Ngo-Duc, F. Otto, I. Pinto, A. Pirani, K. Raghavan, R. Ranasinghe, A. Ruane, L. Ruiz, J.B. Sallée, B. Samset, S. Sathyendranath, S. Seneviratne, A. Sörensson, S. Szopa, I. Takayabu, A.M. Tréguier, B. van den Hurk, R. Vautard, K. von Schuckmann, S. Zaehle, X. Zhang, K. Zickfeld, Technical summary, in: V. Masson-Delmotte, P. Zhai, A. Pirani, S. Connors, C. Péan, S. Berger, N. Caud, Y. Chen, L. Goldfarb, M. Gomis, M. Huang, K. Leitzell, E. Lonnoy, J. Matthews, T. Maycock, T. Waterfield, O. Yelekli, R. Yu, B. Zhou (Eds.), *Climate Change 2021: The Physical Science Basis. Contribution of Working Group I to the Sixth Assessment Report of the Intergovernmental Panel on Climate Change*, Cambridge University Press, Cambridge, United Kingdom and New York, NY, USA, 2021, pp. 33–144, <http://dx.doi.org/10.1017/9781009157896.002>.
- [334] A.N. Yesudian, R.J. Dawson, Global analysis of sea level rise risk to airports, *Clim. Risk Manag.* 31 (2021) 100266, <http://dx.doi.org/10.1016/j.crm.2020.100266>.
- [335] T. Pejovic, V. Williams, R. Noland, R. Toumi, Factors affecting the frequency and severity of airport weather delays and the implications of climate change for future delays, *J. Transp. Res. Board* (2009) <http://dx.doi.org/10.3141/2139-12>.
- [336] D. Ren, L.M. Leslie, Climate warming and effects on aviation, in: R.K. Agarwal (Ed.), *Environmental Impact of Aviation and Sustainable Solutions*, IntechOpen, Rijeka, 2019, pp. 175–189, <http://dx.doi.org/10.5772/intechopen.86871> (Chapter 9).
- [337] Y. Zhou, N. Zhang, C. Li, P. Huang, Decreased takeoff performance of aircraft due to climate change, *Clim. Change* 151 (1295) (2018) 463–472, <http://dx.doi.org/10.1007/s10584-018-2335-7>.
- [338] E. Coffel, R. Horton, The impacts of rising temperature on aircraft takeoff performance, *Clim. Change* 144 (2017) 381–388, <http://dx.doi.org/10.1007/s10584-017-2018-9>.
- [339] G. Gratton, A. Padhra, S. Rapsomanikis, P.D. Williams, The impacts of climate change on Greek airports, *Clim. Change* 160 (2020) 219–231, <http://dx.doi.org/10.1007/s10584-019-02634-z>.
- [340] V. Gallardo, E. Sanchez-Gomez, E. Riber, J. Boe, L. Terray, Evolution of high-temperature extremes over the main Euro-Mediterranean airports, *Clim. Dynam.* (2023) <http://dx.doi.org/10.1007/s00382-022-06652-z>.
- [341] D. Ren, R. Fu, R.E. Dickinson, L.M. Leslie, X. Wang, Aviation impacts on fuel efficiency of a future more viscous atmosphere, *Bull. Am. Meteorol. Soc.* (2020) <http://dx.doi.org/10.1175/BAMS-D-19-0239.1>.
- [342] S.H. Lee, P.D. Williams, Increased shear in the North Atlantic upper-level jet stream over the past four decades, *Nature* 572 (19) (2019) 639–642, <http://dx.doi.org/10.1038/s41586-019-1465-z>.
- [343] I. Gultepe, R. Sharman, P.D. Williams, B. Zhou, G. Ellrod, P. Minnis, S. Trier, S. Griffin, S. Yum, B. Gharabaghi, W. Feltz, M. Temimi, Z. Pu, L.N. Storer, P. Kneringer, M.J. Weston, H.Y. Chuang, L. Thobois, A.P. Dimri, S.J. Dietz, G.B. França, M.V. Almeida, F.L. Albuquerque Neto, A review of high impact weather for aviation meteorology, *Pure Appl. Geophys.* 176 (2019) 1869–1921, <http://dx.doi.org/10.1007/s00024-019-02168-6>.
- [344] L.N. Storer, P.D. Williams, P.G. Gill, Aviation turbulence: Dynamics, forecasting, and response to climate change, *Pure Appl. Geophys.* 176 (2019) 2081–2095, <http://dx.doi.org/10.1007/s00024-018-1822-0>.
- [345] L.N. Storer, P.D. Williams, M.M. Joshi, Global response of clear-air turbulence to climate change, *Geophys. Res. Lett.* 44 (19) (2017) 9976–9984, <http://dx.doi.org/10.1002/2017GL074618>.
- [346] P.D. Williams, Increased light, moderate, and severe clear-air turbulence in response to climate change, *Adv. Atmos. Sci.* 34 (2017) 576–586, <http://dx.doi.org/10.1007/s00376-017-6268-2>.
- [347] J. Dyke, R. Watson, W. Knorr, Climate scientists: concept of net zero is a dangerous trap, 2021, *The Conversation*, URL: <https://theconversation.com/climate-scientists-concept-of-net-zero-is-a-dangerous-trap-157368>.
- [348] L. van Beek, M. Hajer, P. Pelzer, D. van Vuuren, C. Cassen, Anticipating futures through models: the rise of integrated assessment modelling in the climate science-policy interface since 1970, *Glob. Environ. Change* 65 (2020) 102191, <http://dx.doi.org/10.1016/j.gloenvcha.2020.102191>.
- [349] P. Peeters, J. Higham, D. Kutzner, S. Cohen, S. Gössling, Are technology myths stalling aviation climate policy? *Transp. Res. D* 44 (2016) 30–42, <http://dx.doi.org/10.1016/j.trd.2016.02.004>.
- [350] W.F. Lamb, G. Mattioli, S. Levi, J.T. Roberts, S. Capstick, F. Creutzig, J.C. Minx, F. Müller-Hansen, T. Culhane, J.K. Steinberger, et al., Discourses of climate delay, *Glob. Sustain.* 3 (2020) e17, <http://dx.doi.org/10.1017/sus.2020.13>.
- [351] *IEA, Energy Technology Perspectives 2020, Technical Report, IEA, 2021.*
- [352] J. Danaher, Techno-optimism: an analysis, an evaluation and a modest defence, *Phil. Technol.* 35 (2) (2022) 54, <http://dx.doi.org/10.1007/s13347-022-00550-2>.
- [353] IPCC, in: P. Shukla, J. Skea, R. Slade, A.A. Khoualdjajie, R. van Diemen, D. McCollum, M. Pathak, S. Some, P. Vyas, R. Fradera, M. Belkacemi, A. Hasija, G. Lisboa, S. Luz, J. Malley (Eds.), *Climate Change 2022: Mitigation of Climate Change. Contribution of Working Group III to the Sixth Assessment Report of the Intergovernmental Panel on Climate Change*, Cambridge University Press, Cambridge, UK and New York, NY, USA, 2022 (Chapter 5 Demand, services and social aspects of mitigation).
- [354] F. Gonella, C. Almeida, G. Fiorentino, K. Handayani, F. Spanò, R. Testoni, A. Zucaro, Is technology optimism justified? A discussion towards a comprehensive narrative, *J. Clean. Prod.* 223 (2019) 456–465, <http://dx.doi.org/10.1016/j.jclepro.2019.03.126>.
- [355] I. Gough, Climate change and sustainable welfare: the centrality of human needs, *Camb. J. Econ.* 39 (5) (2015) 1191–1214, <http://dx.doi.org/10.1093/cje/bev039>.
- [356] G. Mattioli, Transport needs in a climate-constrained world: a novel framework to reconcile social and environmental sustainability in transport, *Energy Res. Soc. Sci.* 18 (2016) 118–128, <http://dx.doi.org/10.1016/j.erss.2016.03.025>, Energy demand for mobility and domestic life: new insights from energy justice.
- [357] S. Gössling, P. Hanna, J. Higham, S. Cohen, D. Hopkins, Can we fly less? Evaluating the 'necessity' of air travel, *J. Air Transp. Manag.* 81 (2019) 101722, <http://dx.doi.org/10.1016/j.jairtraman.2019.101722>.

- [358] S. Gössling, S. Dolnicar, A review of air travel behavior and climate change, *WIREs Clim. Chang.* 14 (1) (2023) e802, <http://dx.doi.org/10.1002/wcc.802>.
- [359] J. Millward-Hopkins, J.K. Steinberger, N.D. Rao, Y. Oswald, Providing decent living with minimum energy: A global scenario, *Global Environ. Change* 65 (2020) 102168, <http://dx.doi.org/10.1016/j.gloenvcha.2020.102168>.
- [360] IATA, *Annual review 2019*, 2019.
- [361] M. Baltruszewicz, J.K. Steinberger, J. Paavola, D. Ivanova, L.I. Brand-Correa, A. Owen, Social outcomes of energy use in the United Kingdom: Household energy footprints and their links to well-being, *Ecol. Econom.* 205 (2023) 107686, <http://dx.doi.org/10.1016/j.ecolecon.2022.107686>.
- [362] Y. Oswald, A. Owen, J.K. Steinberger, Large inequality in international and intranational energy footprints between income groups and across consumption categories, *Nat. Energy* 5 (3) (2020) 231–239, <http://dx.doi.org/10.1038/s41560-020-0579-8>.
- [363] M. Büchs, G. Mattioli, Trends in air travel inequality in the UK: From the few to the many? *Travel Behav. Soc.* 25 (2021) 92–101, <http://dx.doi.org/10.1016/j.tbs.2021.05.008>.
- [364] D. Ivanova, R. Wood, The unequal distribution of household carbon footprints in Europe and its link to sustainability, *Glob. Sustain.* 3 (2020) e18, <http://dx.doi.org/10.1017/sus.2020.12>.
- [365] T. Reynolds, S. Barrett, L. Dray, A. Evans, M. Köhler, M. Vera-Morales, A. Schäfer, Z. Wadud, R. Britter, H. Hallam, et al., Modelling environmental and economic impacts of aviation: introducing the aviation integrated modelling project, in: 7th AIAA ATIO Conf, 2nd CEIAT Int'L Conf on Innov and Integr in Aero Sciences, 17th LTA Systems Tech Conf; Followed By 2nd TEOS Forum, 2007, p. 7751, <http://dx.doi.org/10.2514/6.2007-7751>.
- [366] A. Barke, C. Thies, S.P. Melo, F. Cerdas, C. Herrmann, T.S. Spengler, Socio-economic life cycle assessment of future aircraft systems, *Procedia CIRP* 90 (2020) 262–267, <http://dx.doi.org/10.1016/j.procir.2020.01.096>.