



**HAL**  
open science

## Identification of existing tools and workflows for solar neighborhood planning

Nicholas Baker, Rafaella Belmonte Monteiro, Alessia Boccalatte, Karine Bouty, Johannes Brozovsky, Cyril Caliot, Rafael Campamà Pizarro, Raphaël Compagnon, Agnieszka Czachura, Gilles Desthieux, et al.

### ► To cite this version:

Nicholas Baker, Rafaella Belmonte Monteiro, Alessia Boccalatte, Karine Bouty, Johannes Brozovsky, et al.. Identification of existing tools and workflows for solar neighborhood planning. IEA Solar Heating and Cooling Technology. 2022. hal-04235538

**HAL Id: hal-04235538**

**<https://hal.science/hal-04235538>**

Submitted on 10 Oct 2023

**HAL** is a multi-disciplinary open access archive for the deposit and dissemination of scientific research documents, whether they are published or not. The documents may come from teaching and research institutions in France or abroad, or from public or private research centers.

L'archive ouverte pluridisciplinaire **HAL**, est destinée au dépôt et à la diffusion de documents scientifiques de niveau recherche, publiés ou non, émanant des établissements d'enseignement et de recherche français ou étrangers, des laboratoires publics ou privés.

# Identification of existing tools and workflows for solar neighborhood planning

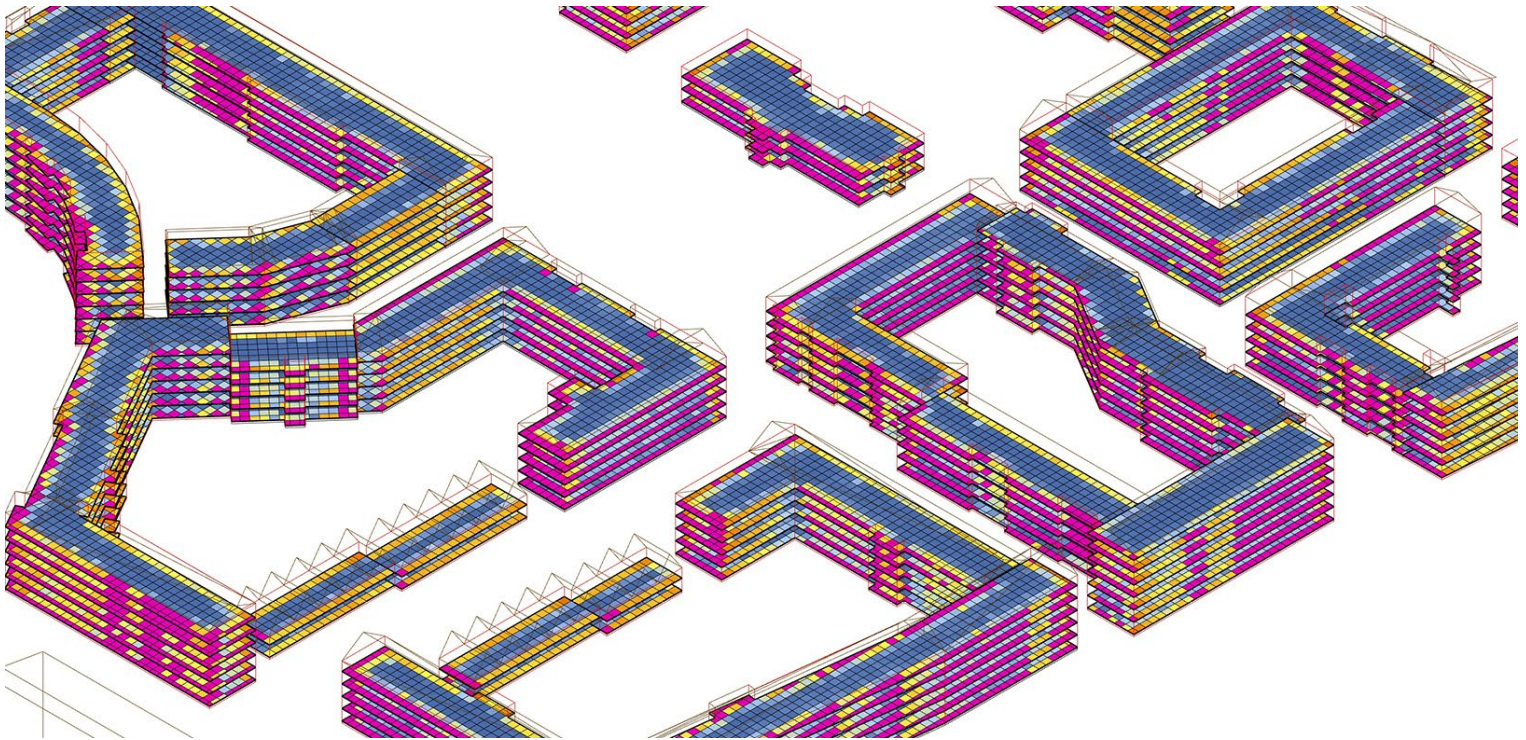

IEA SHC TASK 63 | SOLAR NEIGHBORHOOD PLANNING

# Identification of existing tools and workflows for solar neighborhood planning

**This is a report from SHC Task 63: Solar Neighborhood Planning and work performed in Subtask C: Solar Planning Tools**

**Editors:** Jouri Kanters, Martin Thebault

**Authors:** Nicholas Baker, Rafaella Belmonte Monteiro, Alessia Boccalatte, Karine Bouty, Johannes Brozovsky, Cyril Caliot, Rafael Campamà Pizarro, Raphaël Compagnon, Agnieszka Czachura, Gilles Desthieux, Matteo Formolli, Stéphanie Giroux-Julien, Victor Guillot, Benjamin Govehovitch, Caroline Hachem-Vermette, Ellis Herman, Olivia Alarcon Herrera, Jérôme H. Kämpf, Gabriele Lobaccaro, Christophe Ménézo, Marjorie Musy, Giuseppe Peronato, Arnkell Jonas Petersen, Auline Rodler, Kuljeet Singh, Viktor Sjöberg, Mark Snow, Joar Tjetland, and Yupeng Wang.

**Reviewer:** Maria Wall (Task Manager)

**Date:** June 2022

**Report C1**, DOI [10.18777/ieashc-task63-2022-0001](https://doi.org/10.18777/ieashc-task63-2022-0001)

*The contents of this report do not necessarily reflect the viewpoints or policies of the International Energy Agency (IEA) or its member countries, the IEA Solar Heating and Cooling Technology Collaboration Programme (SHC TCP) members or the participating researchers.*

## Editors / authors

### Jouri Kanters (Subtask Leader)

Lund University  
Department of Building & Environmental Technology  
Division of Energy & Building Design

### Martin Thebault (Subtask Leader)

French National Centre for Scientific Research CNRS  
LOCIE UMR CNRS/USMB- Solar Academy Graduate  
School

## Reviewer

### Maria Wall (Task Manager)

Lund University  
Department of Building & Environmental Technology  
Division of Energy & Building Design

## Authors

### Nicholas Baker

White arkitekter

### Rafaella Belmonte Monteiro

Politecnico Milano

### Alessia Boccalatte

1 : University Savoie Mont-Blanc - LOCIE UMR  
CNRS/USMB - Solar Academy Graduate School  
2 : University of Genoa

### Karine Bouty

University Savoie Mont-Blanc - LOCIE UMR  
CNRS/USMB - Solar Academy Graduate School

### Johannes Brozovsky\*

Norwegian University of Science and Technology  
Department of Architecture and Technology  
Faculty of Architecture and Design

### Agnieszka Czachura

Lund University, Department of Building & Environmental  
Technology, Division of Energy & Building Design

### Gilles Desthieux

Haute école du Paysage d'Ingénierie et d'Architecture de  
Genève (Hepia), Institute for Landscaping Architecture  
Construction and Territory (inPACT), University of  
Applied Sciences Western Switzerland

### Matteo Formolli

Norwegian University of Science and Technology  
Department of Architecture and Technology  
Faculty of Architecture and Design

### Cyril Caliot

Universite de Pau et des Pays de l'Adour, E2S UPPA,  
CNRS, LMAP

### Rafael Campamà Pizarro

Lund University, Department of Building & Environmental  
Technology, Division of Energy & Building Design

### Raphaël Compagnon

Haute école d'ingénierie et d'architecture de Fribourg

### Stéphanie Giroux-Julien

University of Lyon, UCBL, INSA Lyon, CNRS, CETHIL,  
UMR5008

### Victor Guillot

Haute école du Paysage d'Ingénierie et d'Architecture de  
Genève (Hepia), Institute for Landscaping Architecture  
Construction and Territory (inPACT), University of  
Applied Sciences Western Switzerland

### Benjamin Govehovitch

1 : University of Lyon, UCBL, INSA Lyon, CNRS,  
CETHIL, UMR5008  
2 : University Savoie Mont Blanc - LOCIE UMR  
CNRS/USMB - Solar Academy Graduate School

### Caroline Hachem-Vermette

University of Calgary

### Ellis Herman

Spacemaker – Autodesk

### Olivia Alarcon Herrera

University of Calgary

### Jérôme H. Kämpf

Idiap Research Institute  
Energy Informatics Group

### Gabriele Lobaccaro

Norwegian University of Science and Technology  
Dept. of Civil and Environmental Engineering  
Faculty of Engineering

### Christophe Ménézo

University Savoie Mont Blanc LOCIE UMR CNRS/USMB  
– Solar Academy Graduate School

### Marjorie Musy

1 : Equipe BPE Cerema,  
2 : LOCIE UMR CNRS/USMB

**Giuseppe Peronato**  
Idiap Research Institute  
Energy Informatics Group

**Arnkell Jonas Petersen**  
Erichsen & Horgen AS

**Auline Rodler**  
1 : Equipe BPE Cerema,  
2 : LOCIE UMR CNRS/USMB

**Kuljeet Singh**  
Faculty of Sustainable Design Engineering (FSDE),  
University of Prince Edward Island, University Ave,  
Charlottetown, PE C1A 4P3 CANADA

\*At time of contribution

**Viktor Sjöberg**  
White arkitekter

**Mark Snow**  
Australian PV Institute

**Joar Tjetland**  
Erichsen & Horgen AS

**Yupeng Wang**  
Xi'an Jiaotong University

## Contributors

**Silvia Croce**  
Institute for Renewable Energy  
Eurac Research

**Xin Cui**  
Xi'an Jiaotong University

**Pietro Florio\***  
EPFL Lausanne

**Xiuxiu Gao**  
China National Engineering Research Center for  
Human Settlements (CNERCHS), China Architecture  
Design & Research Group (CAG)

**Javeriya Hassan**  
Building Science Graduate Program  
Department of Architectural Science  
Ryerson University\* (name change in progress)

**Miljana Horvat**  
Department of Architectural Science  
Ryerson University\* (name change in progress)

**Olaf Bruun Jørgensen**  
Danish Energy Management DEM

**Xi Zhao**  
China National Engineering Research Center for  
Human Settlements (CNERCHS), China Architecture  
Design & Research Group (CAG)

## Solar Heating & Cooling Technology Collaboration Programme (IEA SHC)

The Solar Heating and Cooling Technology Collaboration Programme was founded in 1977 as one of the first multilateral technology initiatives (“Implementing Agreements”) of the International Energy Agency.

**Our mission** is “Through multi-disciplinary international collaborative research and knowledge exchange, as well as market and policy recommendations, the IEA SHC will work to increase the deployment rate of solar heating and cooling systems by breaking down the technical and non-technical barriers.”

**IEA SHC** members carry out cooperative research, development, demonstrations, and exchanges of information through Tasks (projects) on solar heating and cooling components and systems and their application to advance the deployment and research and development activities in the field of solar heating and cooling.

**Our focus areas**, with the associated Tasks in parenthesis, include:

- Solar Space Heating and Water Heating (Tasks 14, 19, 26, 44, 54, 69)
- Solar Cooling (Tasks 25, 38, 48, 53, 65)
- Solar Heat for Industrial and Agricultural Processes (Tasks 29, 33, 49, 62, 64)
- Solar District Heating (Tasks 7, 45, 55, 68)
- Solar Buildings/Architecture/Urban Planning (Tasks 8, 11, 12, 13, 20, 22, 23, 28, 37, 40, 41, 47, 51, 52, 56, 59, 63, 66)
- Solar Thermal & PV (Tasks 16, 35, 60)
- Daylighting/Lighting (Tasks 21, 31, 50, 61)
- Materials/Components for Solar Heating and Cooling (Tasks 2, 3, 6, 10, 18, 27, 39)
- Standards, Certification, and Test Methods (Tasks 14, 24, 34, 43, 57)
- Resource Assessment (Tasks 1, 4, 5, 9, 17, 36, 46)
- Storage of Solar Heat (Tasks 7, 32, 42, 58, 67)

In addition to our Task work, other activities of the IEA SHC include our:

- SHC Solar Academy
- *Solar Heat Worldwide*, annual statistics report
- SHC International Conference

### Our members

Australia	European Copper Institute	SICREEE
Austria	France	Slovakia
Belgium	Germany	South Africa
Canada	International Solar Energy Society	Spain
CCREEE	Italy	Sweden
China	Netherlands	Switzerland
Denmark	Norway	Turkey
EACREEE	Portugal	United Kingdom
ECREEE	RCREEE	
European Commission	SACREEE	

For more information on the IEA SHC work, including many free publications, please visit [www.iea-shc.org](http://www.iea-shc.org).

---

## Nomenclature

---

BIM : Building Information Model

BIPV : Building Integrated Photovoltaic

BIST : Building Integrated Solar Thermal

BPS: Building Performance Simulation

CAD: Computer Aided Design

DSM: Digital Surface Model

DTM: Digital Terrain Model

HVAC : Heating Ventilation and Air Conditioning

LoD: Level of Detail

LiDAR: Laser imaging Detection and ranging

PV : Photovoltaic

SVF: Sky View Factor

---

# Contents

---

<b>Nomenclature</b> .....	<b>6</b>
<b>Contents</b> .....	
<b>1 Introduction</b> .....	<b>1</b>
<b>2 Tools for solar neighborhood planning: an overview</b> .....	<b>2</b>
2.1. Scale levels and purpose .....	2
2.2. Analogue tools for solar design.....	4
2.3. Modelling solar neighborhoods .....	4
2.3.1. Weather data .....	5
2.3.2. Geometrical modelling methods .....	5
2.3.3. Radiation modelling methods .....	8
2.3.4. Energy consumption .....	8
2.3.5. Microclimate .....	9
2.4. Often used simulation tools.....	11
2.5. Multi objective optimization and multi criteria decision aiding .....	12
2.5.1. Mono and multi-objective optimization.....	12
2.5.2. Multi-criteria decision aiding .....	13
2.6. Commercial vs Open-source.....	14
<b>3 Identification of National Common Indicators for Solar</b> .....	<b>15</b>
3.1. Short overview of Common Indicators for Solar Neighborhoods.....	15
3.1.1. Geometry-based.....	15
3.1.2. Climate-based.....	17
3.2. Method for gathering NCIs from experts .....	18
3.2.1. Obtaining National Common Indicators .....	18
3.2.2. Overview of NCIs.....	18
3.3. Showcase of consequences of National Common Indicators .....	22
<b>4 Workflow stories</b> .....	<b>25</b>
4.1 Introduction.....	25
City of Melbourne.....	26
SunSPoT – APVI Solar Potential Tool .....	31
West 5.....	35
City Valley.....	38
Faelledby .....	42
Leroy-Marlin.....	44
Lake Zilang .....	47
Solar sculpting .....	50
Bryggerikvarteret E.C. Dahls.....	54
Sluppen.....	58
Gullhaug Torg 5 .....	64



Daylight Access in Existing Swedish Neighborhoods .....	67
inFORM.....	69
G2 Solaire.....	73
<b>5 Comparative study of numerical tools .....</b>	<b>76</b>
5.1 Methodology.....	76
5.1.1 Geometry.....	76
5.1.2 Weather data .....	77
5.2 Tools.....	77
5.2.1 Summary of the considered tools and their main characteristics.....	77
3.3.1. Workflows .....	79
3.4. Results .....	80
3.4.1. Cumulative Energy .....	80
3.4.2. Unshaded roof .....	81
3.4.3. Unshaded facades.....	81
3.4.4. Homogeneous district.....	82
3.4.5. Heterogeneous district.....	82
3.4.6. Prediction variability.....	83
3.4.7. Façade Mapping.....	85
<b>6 Discussion and Conclusions .....</b>	<b>87</b>
<b>7 Acknowledgements.....</b>	<b>89</b>
<b>8 References .....</b>	<b>90</b>

---

# 1 Introduction

---

Planning for sustainable neighborhoods is a high priority for many cities. It is therefore important to take the right decisions during the planning phase to ensure that important aspects are considered. One of these important aspects is to consider the harvesting of solar energy in the best possible way. It is however difficult to define the best ways to exploit the incoming solar energy. Solar energy can be used by means of active solar energy production, passively by means of daylighting buildings or outside buildings on the ground for direct solar access or thermal comfort. This different usage can sometimes be conflicting (for example at a building level, in order to maximize the photovoltaic production, it may be necessary to use all the surfaces, therefore preventing the access to daylight). The access to daylight in the street is appreciated during cold days, but shading is preferred during the hotter days.

In addition to these energetic considerations, the design and planning of this neighborhood should consider other aspects such as the aesthetic integration, the local microclimate and comfort or the energy exchanges, in term of self-consumption and exchanges with the grid.

In the urban planning process of neighborhoods, most of the framework for a successful solar integration is set; building volumes and roof inclinations, functions of buildings, shape and function of outdoor spaces, density, etc. It is therefore crucial that urban planners have access to the right tools to assist them in decision-making regarding the solar planning of neighborhoods.

There are many different tools available today that can perform (advanced) solar analyses for solar neighborhoods. Most of these tools have a specific focus in the planning process (different stages in the planning process for new neighborhoods or the existing built environment) or on different scale (city scale to solar energy system scale).

At the same time, there are very few common agreed metrics, also called Key Performance Indicators, that are used worldwide for the planning with solar energy. Even though there are some established KPIs, there is no agreement on which thresholds that should be used and they differ per country, region or even city. The outcome of tools is very related to the KPIs and their thresholds, since they normally require a certain calculation method for analysis.

The aim of this report is to better understand the state-of-art of available tools for solar neighborhood planning, as well as the Key Performance Indicators commonly used in the participating countries of the Task. Therefore, this report consists of the following sections:

- Overview of existing tools for solar neighborhood planning (Chapter 2)
- National Common Indicators (NCI) (Chapter 3)
- Work flow stories (Chapter 4)
- Comparative study (Chapter 5)
- Discussion (Chapter 6)

# 2 Tools for solar neighborhood planning: an overview

This Chapter will provide an overview of existing tools for solar neighborhood planning.

In this report, we will refer to tools as computer-based calculations that are used in the planning and design of solar neighborhoods. This involves evaluating the amount of irradiance received on urban surfaces, access to sun- and daylight indoors and outdoors, economic performance of active solar energy production, or the contribution of active solar energy systems on the energy balance in a neighborhood. We acknowledge that there are also analogue tools available, but the focus in this subtask is on computer-based calculations.

Architects and engineers have in general limited knowledge about advanced solar design tools, experience tools as complex, and consider the available solar software as lacking interoperability, user-friendliness, and an approachable visual environment (Kanters et al., 2013).

This chapter will discuss the following elements of the use of tools:

- scale levels and purpose
- analogue tools
- modelling solar neighborhoods
- often-used tools
- optimization
- commercial vs open-source tools

## 2.1. Scale levels and purpose

Tools for solar energy are used at different scale levels in the planning and design process -the political decision phase, urban design phase, building design phase and the implementation phase (Kanters & Wall, 2016) (Figure 1) and by different user groups, e.g. engineers, consultants, architects and urban planners.

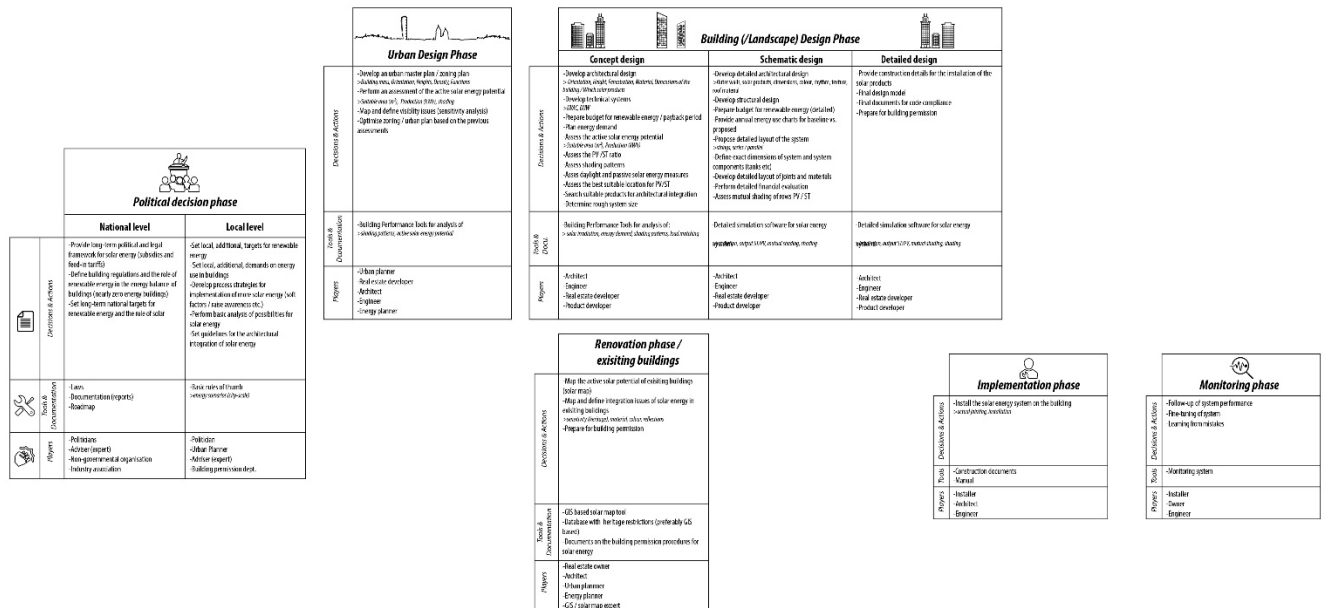

Figure 1: Scale level of the design processes (Kanters & Wall, 2016)

At different scale levels, there will be different levels of details and modelling approaches for the simulation of incoming solar energy. Also, in more general issues, e.g. to what extent active solar energy could contribute to the national or regional energy goals. The relevant Solar Performance Indicators (as further discussed in Chapter 3) for decision makers are fundamental to dictate which kind of tool can be used.

At the national or city levels, analyses are often based on Geographical Information System (GIS)-models and the level of detail of their assumptions is often low. Some countries have standards for 3D city models with an homogeneous level of detail and interactive options, while others have a heterogeneous level of detail between

different neighborhoods and buildings within the same city. The result is that there is a high degree of uncertainty that needs to be addressed (Eriksson & Harrie, 2021; Sun et al., 2019). On the smaller scales -neighborhood and building scale-, the focus has shifted to more detailed analyses, taking into consideration e.g. the energy balance in the neighborhood or buildings, solar access and daylight access on outdoor spaces and the building envelope. The even more detailed phase is often used by installers of e.g. PV systems where specific details about the systems are discussed.

Nault et al. (2018) also describes how different tools are used throughout different stages; from urban planning to urban design to building design. The use of hand sketches, Computer Aided Design (CAD), GIS, Building Information Modelling (BIM) and Building Performance Simulation (BPS) tools are mentioned.

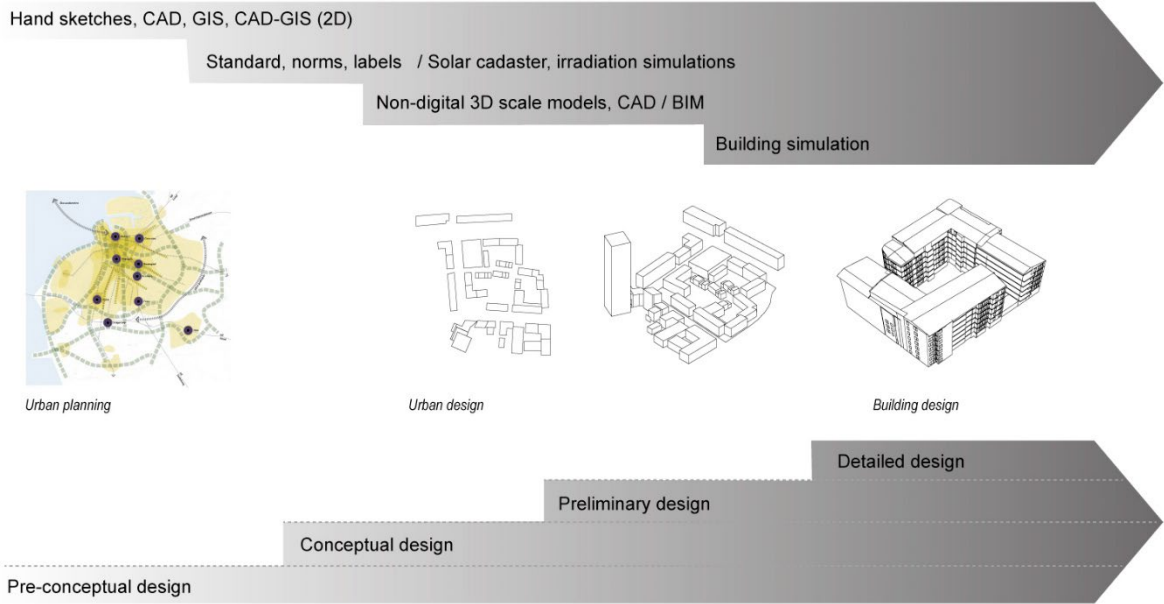

Figure 2. Description of the use of different tools in different planning stages (adapted after (Nault et al., 2018))

## 2.2. Analogue tools for solar design

Before computational power was easily available to produce accurate and useful results, one had to rely on analogue tools for solar design. Amongst them, one of the most common analogue tool is the sun path diagram, which shows the path of the sun throughout the year (Example in Figure 3).

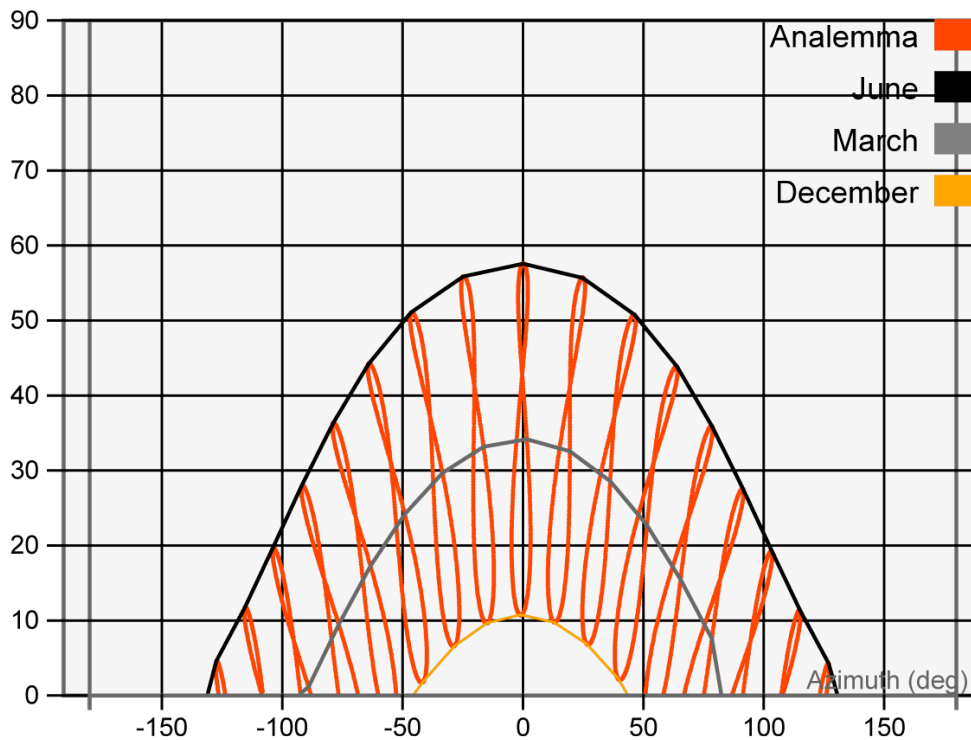

Figure 3. Illustration of sun path of Copenhagen (Arsano & Reinhart, 2021)

With more and more computer power available, there has been a shift towards more computer-based tools which allow to quickly model all types of geometries and surroundings, for every location or weather.

## 2.3. Modelling solar neighborhoods

Solar design tools utilise computational models (also known as sky or radiation models) as the foundation for solar potential computations and performance simulations, and those models were comprehensively reviewed in Freitas et al. (2015).

In its simplest form, modelling solar neighborhoods only requires as inputs a geometry, a weather (including location of the building) and a solar radiation model. However, local conditions (microclimate, energy demands, socio-economic considerations) of a neighborhoods influence the way solar energy should be used. To that aim, it is now necessary to consider a wide range of parameters such as the microclimate (for external and internal comfort as well as performance of the active solar systems) or the energy consumption of the building, which is necessary for self-consumption calculations. Furthermore, the design of solar neighborhoods, or the planning of solar strategies are often iterative processes involving several criteria and actors. Therefore, tools have to be able to account for this complexity as well as offer the possibility to conduct optimization or decision aiding.

### 2.3.1. Weather data

Weather data is an essential input in building performance and solar energy simulations. In the simulation process, weather data are taken as a set of constant parameters for underlying simulation equations because typically the location of the development is known and unalterable. Therefore, the influential parameters that have an impact on the building performance are all linked to the inputs such as shape, layout, orientation, materials, systems, operational schedules, i.e. building design characteristics in a broad sense. Weather data for building simulations includes information about location coordinates, temperature, relative humidity, and solar irradiance; but can also include other parameters such as cloud coverage, precipitation, or illuminance. What is used in annual building simulations of many kinds, including solar radiation studies, is the so-called reference year. It contains one year weather data, a typical meteorological year (TMY), with one value for every hour and every parameter and is based on 10 or more years of meteorological observation data. European standard ISO 15927-4:2005 describes the method of constructing such a reference year. Every month in the reference year is carefully chosen from the multi-year observation data set as the representative typical month of the given time period, which is done by means of cumulative distribution function and calculation methods covered in the standard. For computer simulation purposes, the reference year weather data is written into a text file suitable to be read by the software of choice. The most common building performance indicators simulated using reference year weather data involve energy use, daylighting, and radiation. The latter is frequently used in solar design studies and for generating solar maps.

Certain types of solar design analysis do not require annual weather data input. Those are usually point-in-time calculations. Some solar access metrics are geometry-based only which means all is needed is the urban geometry model and its location data, particularly the latitude, because it carries information about the positions of the sun at any time in a year. For those metrics, the actual local insolation is not considered; it is rather the theoretical access to direct solar rays assuming sunny weather. More information about the metrics can be found in Chapter 3.

Weather observations are presently affected by progressing climate change. The so-called “typical” weather data based on past time periods might no longer be representative of current and future climate patterns. For instance, the web-available Swedish weather data files, compatible with a number of tools in Rhino and Grasshopper environment (epw format, <https://www.energyplus.net/weather>), are based on observation data from time periods of at least 10 years within the time between 1883 and 1996. A number of studies advocated for the use of not just the historical weather, which is the standard type of meteorological data used for performance predictions at present (reference year or TMY), but also future climate scenarios (Naboni et al., 2019; Ren et al., 2019; Robert & Kummert, 2012).

### 2.3.2. Geometrical modelling methods

#### 2.3.2.1. Computer Aided Design (CAD) and Building Information modelling (BIM)

An adequate choice of solar design tools is, amongst others, dependent on the available input data for creating surface model representations and the methods used for that are intrinsically different when digitalising existing or new urban developments. The latter is done by architects and urban planners who use Computer Aided Design (CAD) software often from the very early stages and throughout the entire urban planning and building design process. In such case, the model is digital from the start which makes it accessible for further performance evaluations using computer-based tools. There are still some obstacles to overcome in the process because there is limited intra-software integration possibility, meaning a digital model saved in a certain file extension might need to be converted, refined and/or cleaned to make it compatible with a different software environment. Existing buildings, on the other hand, often do not have a digital model representation in the databases because they predate computers and CAD.

It is nowadays common to model individual buildings or small building complexes using a full 3D model in a CAD environment. Such single-building models can exhibit a sophisticated level of detail (LoD), which is particularly crucial for daylight performance assessments, without an unreasonable amount of time and resources spent on creating detailed 3D representations. Manual labour input required for CAD modelling can usually be justified as long as the model is reasonably sized. Similarly, higher model accuracy is also manageable in terms of hardware computational and graphical strength. However, the larger the model gets, it becomes increasingly more difficult to maintain high model accuracy i.e. LoD, because of greatly increased time investment, memory and computational weight for creating 3D models covering large neighborhood or city scales (Freitas et al., 2015). A more advanced form of the CAD program is BIM (Building Information Modelling) involving the generation and management of digital representations of physical and functional characteristics of places (Abanda et al., 2021). Many BIM programs

are able to perform shadow studies and has become more common that advanced Building Performance Simulations can be run in the BIM environment itself. In some cases, advanced solar and daylight studies can be performed, as well as an evaluation of the PV potential. The integration of building energy simulation into a BIM-based workflow will reduce the time consumed for energy modelling (Andriamamonjy et al., 2019).

### **2.3.2.2. Geographical Information System (GIS)**

In modelling of existing built environments, common urban fabric digitalisation methods are Geographic Information Modelling (GIS)-based and involve the use of images (aerial or satellite photographs in a raster format) and point clouds (from LiDAR scanning technology) as raw input data that it largely simplified and reduced but carries building height information among other things (Freitas et al., 2015).

GIS is a framework for gathering, managing, and analysing data of different kinds and nature. GIS provides the possibility to give a deeper insights into data, such as patterns, relationships, and situations resulting in the potential to make comprehensive analysis (Machete et al., 2018). Solar potential -the amount of energy received by a piece of roof, over a certain amount of time (commonly a year)- analyses are available within GIS tools, resulting in providing data for decision-making in the planning process of solar neighborhoods.

Rasters that contain pixel-based raw photogrammetric topography information are known as Digital Surface Models (DSM) whose heights are given as absolute values as they cover on-ground objects such as buildings, and Digital Terrain Models (DTM) whose height information refers only to the ground elevation disregarding the height of objects on top of it. The raster models are often used in combination with GIS shape files, typically available from city urban planning databases, which provide planimetric information about building footprints and street layouts in a 2D format. The abovementioned terrain survey data can be used to generate 3D models, and there are available tools which make it possible to automate, to a varying degree, the topography digitalisation process (Nex et al., 2013; Peronato et al., 2016). Another common application of raster urban models is simply graphical; 2D height-coloured layouts are used to illustrate the scope of a large case study area, even though the core analysis is done using another modelling approach (Chatzipoulka et al., 2018). The 2D modelling approach is also directly used for calculation of shadow casting and Sky View Factor (SVF) evaluation in the urban models, both essential to solar potential assessments, as the algorithms used for that purpose are efficient and compute faster (Dirksen et al., 2019).

Raster data is particularly used in generation of digital solar maps, which provide solar potential information over large territories. Solar maps or solar cadastres, that offer solar potential mapping on building roofs and other horizontal surfaces. Nowadays, thanks to the improvements of computer-based processing tools, it is not uncommon to also add the third dimension in order to represent vertical surfaces in the city model even though it is challenging (Freitas et al., 2015). Creating the third dimension from a 2D data takes additional steps in the model generation phase and there are special methods for achieving this, for example a “hyperpoints” method (Desthieux et al., 2018). Although 3D models can be derived from 2.5D DSM, they do not carry information about architectural details such as balconies, windows, or other complex facade elements.

### **2.3.2.3. Level of Detail (LoD)**

The Level of Detail (LoD) classification is frequently used in 3D city modelling to indicate the degree of accuracy and sophistication in a digital model representation of a built environment. LoD range from lowest (0) to highest (4), and the numbers indicate the following aggregate building model precision: 0 – 2D footprint representation, 1 – simple rectangular building massing with flat roofs and homogenous vertical surfaces, 2 – added roof slopes, 3 – added window placements and façade details, 4 – added layouts and features of the interiors (Nouvel et al., 2013).

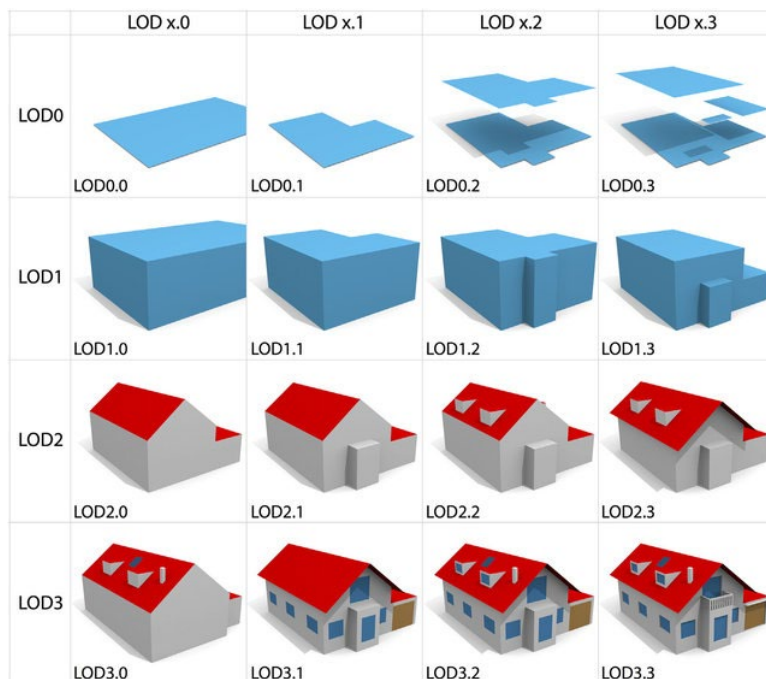

**Figure 4: different Levels of Detail illustrated. Illustration under CC agreement (Biljecki et al., 2016)**

LoD 1 is very common in large-scale urban studies, because it is not computationally heavy, as high-accuracy models of large areas greatly exacerbate workflow efficiency, and because very often simple LoD 1 building massing is readily obtained from survey data without the need for laborious manual override. Common applications of LoD 1 include calculations of: Sky View Factor (Chatzipoulka et al., 2018), irradiance (Carneiro et al., 2010), heating demand (Nouvel et al., 2013), and combinations of solar and daylight availability predictions (Compagnon, 2004). Generally speaking, in the estimation of the solar potential at the urban scale, small construction details are often omitted as they have a much lower impact on the annual potential compared to the massing of building forms and urban layout (Dogan et al., 2012).

The choice of LoD for urban analyses can be influenced by the raw input data; for instance, LiDAR data offers possibility to generate 2.5D and 3D city models with LoD of maximum 2 (Desthieux et al., 2018). Adding details beyond LoD 2 often entails using typically survey-based building archetype characteristics applied as reduction factors which express proportions of different urban surfaces that are occupied by windows, balconies, HVAC installations, and other elements which make them unsuitable for other application such as active solar installations (Lobaccaro et al., 2019). This model accuracy, which is accounting for surface elements using reduction factors is known as LoD 2.5. Studies showed that lower LoD in urban solar potential assessments can lead to underestimation of irradiance when roofs are modelled flat instead of pitched (Peronato et al., 2016) or overestimation of irradiance when reduction factors are used instead of true representation with LoD 3 (Saretta et al., 2020).

The importance of precise glazing modelling on facades was previously brought to attention; however, there is a lack of measurement data to assist digital modelling processes in order to reach LoD 3 (Compagnon, 2004) (Nouvel et al., 2013) (Freitas et al., 2015). This creates a barrier in modelling of existing buildings using LoD 3. Meanwhile, new developments do not face the same problems, as the model is nested in a 3D modelling space from the very early stages of the design process and is continuously refined there. LoD 4 is predominantly applied in daylighting studies, because the internal layout and surface features are significant in simulations of daylight metrics. Overall, high accuracy is desirable, but the LoD selection is often a compromise between a sufficiently detailed representation of built environment and the resources of time and processing power it requires for modelling and computation.



### 2.3.3. Radiation modelling methods

After the creation of a model, with a level of detail in accordance with the required output, an adequate engine to perform the simulation has to be decided. Often 3D modellers have built-in solutions to accomplish that goal, making the choice for the simulation engine an automatic consequence. Other times, when native solutions are not available, plug-ins can fulfil the scope, adding the missing functions to the original software. On the other hand, it is also possible to transfer the model to another environment to perform simulations. This can sometimes, however, result in time-consuming processes of model cleaning/adaptation, due to a lack of interoperability. Two main modelling methods are used in solar simulations: radiosity and ray tracing. The difference in the simulation is the starting point: Ray tracing follows all rays from one point (either the light source or the surface of interest) to another point (surface of interest or light source). Radiosity simulates the diffuse propagation of radiations based on solid angles calculation.

- *Radiosity* is one of the most common methods for light simulations, thanks to its ability to perform analysis under different sky conditions and geometries. The surfaces of the scene are divided into meshes of patches that are treated as perfectly isotropic diffuse reflectors with a constant luminance. View factors between different patches are calculated and the final illuminance of each patch is given by the contribution of the visible surrounding patches and the light source. The general advantages of this method are the quick calculation times for scenes with a limited number of surfaces and the possibility of realizing smooth and fast walk-through into a scene, thanks to the ability of the method to yield the total luminance distribution independently to the viewpoint. Radiosity cannot, however, model specular or anisotropic reflections since the angular properties of the light are not modelled (Iversen et al., 2013).
- *Raytracing* methodology can simulate reflection, transmission, and refraction properties of surfaces under any sky conditions, making possible the study of complex materials and spaces. We refer to *forward raytracing* if the rays are emitted from the source of light into the space, while *backward raytracing* is where rays are emitted by the test points in the scene and the source of the light is traced back from them. The second approach is the most adopted for its fastest outputs resulting from the fact that only the rays reaching the source of light are calculated. In backward raytracing, when the initial set of rays from the test points hit a surface, secondary rays are emitted, with an angle and an intensity depending on the surface's optical properties. This process is iterated until the rays find their way to the light source (sun, celestial hemisphere, or artificial light) unless a certain number of ambient bounces (-ab) is reached, or the relative weight of rays drop under a given threshold value (Larson & Shakespeare, 1998). The disadvantages of this method are generally longer calculation times and the difficulty to deal with complex fenestration systems (i.e., thick Venetian blinds or light pipes) (Iversen et al., 2013; Tsangrassoulis & Bourdakis, 2003).

Performing solar energy simulations are as discussed mainly performed using the radiosity and / or ray-tracing method. The core in a programme that performs such analyses using radiosity and / or ray-tracing methods are so-called engines. Examples of such engines are: Velux Daylight Visualiser, Radiance, Dial+, IES-VE, Dialux, Evalglare, Lightsolve, and 3DS Max design.

### 2.3.4. Energy consumption

In the planning process of a solar neighborhood, the concept of self-consumption has become predominant, with the source of solar energy being either solar thermal energy or photovoltaic energy. However, in order to adequately take decision on the installation of active solar energy, it is necessary to know the energy need.

The decrease of building energy consumption is one of the key goals of the current European regulation toward energy transition and decarbonisation of urban areas. In the last decades, the focus has been mostly on the importance of the renovation processes, i.e. improving the performance of the building envelope or systems. However, thanks to the relatively recent concept of Nearly Zero Energy Building (NZEB), or District (NZED), more awareness has been raised on the self-consumption and on-site energy production issues to attain the yearly balance between the energy yield from renewables and the building (or district). As a result, the most recent advances on solar integration in the urban environment show a growing interest towards the match between demand and production and the development of solar building envelopes. Building-integrated solar systems can be either thermal (BIST) (Maurer et al., 2017) or photovoltaic (BIPV) (Pillai et al., 2022) which is the most common due to the wide range of applications (semi-transparent, coloured, integrated with shading systems) and its dual function in displacing conventional building materials.

Independently from the type of solar system, for a proper integration it is necessary to establish suitable energy indicators to quantify the on-site energy generation at local level. The most commonly used are self-consumption

and self-sufficiency (Ciocia et al., 2021). The self-consumption is defined as the ratio between the energy locally generated and consumed and the total local generation, whereas the self-sufficiency is the amount of energy locally generated and consumed with respect to the total consumption (quantifying, to some extent, the independence from the grid).

As the solar resource availability is strongly variable both during the day and throughout the year, it is necessary to investigate the mismatch between consumption and production, trying to maximise both self-consumption and sufficiency. To this aim, a detailed analysis of both the building energy demand profiles and the solar energy production, based on local weather data, has to be conducted. The comparison between the needs and the solar energy supply should be carried out at least on an hourly basis in order to optimize the solar potential, preventing system oversizing. In this context, the importance of the exploitation of solar vertical surfaces, besides rooftop installations, has emerged. As it is clearly proven by (Redweik et al., 2013), integrating the temporal match issue, solar façades represent an interesting opportunity. Indeed, despite being generally less productive than horizontal surfaces on a yearly basis, vertical systems produce maximum power at different hours of the day (depending on their orientation) thus enabling an extension of peak power production.

Note that the 'classical' indicators of self-consumption (the self-consumption rate and the self-sufficiency rate) may not be the most relevant as objectives for self-consumption. Indeed, a self-consumption rate of 100% is always achievable if the PV energy production is low enough in comparison with the energy needs of the building (by reducing the area occupied by the PV system). Conversely, in order to maximize self-sufficiency, it is sufficient to maximize PV production. However, consuming locally its own energy allows to attenuate some of the interactions with the grid, and neither the maximization of the self-consumption rate nor this of the self-sufficiency can guarantee this. Other indicators can however be of interest such as the minimization of the peak loads, the minimization of the energy exchanges with the grid or the maximization of the benefits (Thebault & Gaillard, 2021).

In the modelling of a solar neighborhood, designed to attain the NZE requirements, it is thus fundamental to adequately investigate building energy consumption, while considering the complexity of the urban context. The most common practice, exploited by different user groups (engineers, architects, urban planners), is building energy modelling and performance simulation. The so-called BEMs (Building Energy Models) are numerical 3D models that describe the heat transfers based on the user's input data related to the building envelope characteristics, weather data, loads, and occupancy levels. Despite being quite well-established for single building energy performance simulations (e. g. DOE-2, EnergyPlus, TRNSYS, BLAST, ESP-r), there are still some limitations mainly related to the evaluation of building energy demand in the urban context. The first obstacle of UBEMs (Urban Building Energy Models) is the extensive computation time needed to lead the energy performance simulation on a large number of buildings, whereas the second is the account for local microclimatic condition of the urban context.

### **2.3.5. Microclimate**

The thermal microclimate within the city differs from the rural areas outside of the city borders. The importance of this effect on solar design and future predictions is that commonly, weather data used for simulations is based on real measurements collected by a station in a rural area, very often airports, which are located outside of cities. Higher temperatures in the cities can, for example, affect the annual energy yield from photovoltaics because of the temperature dependency of PV modules. The urban heat island effect can be simulated, and is commonly done through altering of the existing rural weather file.

While it is most natural to use the closest available weather data to the location of a project, it is also possible to instead use a normalised weather data when studying differences between different urban layouts, usually applied for research purposes. In Ratti et al. (2005), the authors investigated the impact of urban texture on buildings' energy use and used normalised weather data (i.e. climate data for only one city) in all three case studies of different European cities. They argued that when investigating the influence of geometry, climate differences are less relevant and relative outcomes give clearer overview on the quality of the urban design.

The combination of the physical phenomena and meteorological processes involving a certain region shapes its climate. Due to the complexity of the urban context, mainly caused by the intensive human activity and by the deep altering of the natural processes, it is possible to recognise the occurrence of micro-climatic conditions strongly affecting cities. When designing a solar neighborhood, local microclimate should be assessed in order to improve urban design potential not only with a view to increasing solar energy exploitation and daylight access but also urban comfort and quality of life. The most known phenomenon contributing to the urban local climate distortion is the Urban Heat Island (UHI), whose main effect is the increase in air temperatures with respect to the surrounding

non-urbanized areas. This phenomenon negatively influences the thermal comfort at the street level and the energy demand of buildings, increasing their cooling load (Boccalatte et al., 2020; Lima et al., 2019; Morganti et al., 2017; Palme et al., 2017). This, in turn, affects the urban environment with an augmentation of the heat rejected outside from the building HVAC system, resulting in an undesirable feedback loop.

Weather data represent a key input for both Building Energy Models and PV system performance evaluation models, as the higher the temperature of the module, the lower is its efficiency. However, very rarely it is possible to have access to local and site-specific weather information since they often come from climate data as registered at weather stations located at rural or airport sites that are assumed representative of the entire region.

As it is exhaustively evidenced by Bouyer et al. (2011), a numerical simulation is the most effective approach to tackle the complexity and non-linearity of microclimatic phenomena. In this context, it is possible to distinguish between two types of simulation tools: microclimate simulation tools and coupling methodologies (Lauzet et al., 2019). The first group of tools is specifically designed for assessing outdoor local climate phenomena (e. g. impact of vegetation, atmospheric conditions, evaluation of mitigation strategies such as the use of cooling materials), but they are generally very limited in terms of accuracy of the 3D geometries and building attributes due to long computation time needed. Conversely, the coupling method is based on the possibility to couple between BEMs and microclimate simulations, while maintaining an acceptable simulation time. In terms of UHI-related studies, the main objective is to “morph” the original weather data from the rural weather station as a function of the neighborhood characteristics and then use the UHI-modified weather data in order to perform more reliable performance evaluations of buildings and systems.



typically require annual performance predictions. Few software provide sufficient CAD or intra-software workflow integration that is sought after by building and urban design practitioners (Kanters et al., 2014).

In general, at city level, GIS-based tools and compatible engines are used. Using CAD tools to analyse solar concepts for multiple building complexes in large urban scales can quickly become time-inefficient, hence new GIS-based methods have been emerging (Freitas et al., 2015).

On the neighborhood and building level, mainly two modelling methods and connected tools are used: BIM and CAD. There is a limited number of BIM software available, and even less solar tools are available for an integration within the BIM environment.

However, there are, many more solar energy assessment tools that are connected to CAD-programs, especially since the development of visual programming environments. These environments have introduced parametric modelling, which has become a widely used approach in the Architectural and Engineering praxis. Parametric modelling is a modelling process with the ability to change the shape of model geometry as soon as the dimension value is modified. A visual programming environment allows also plugins to be connected in order to e.g. run advanced energy simulations, connect to a 3D printer, etc. Many advanced solar energy simulations can be run through the interface of these visual programming environments. These environments are very flexible and allow users to performance different kinds of operations (e.g. geometry transformation), simulations (energy, daylight, active solar energy production) without having to re-model a 3D model for every simulation.

At the system level, many different stand-alone programs exist that are designed to simulate the performance of active solar energy systems; in particular PV and ST systems. Specific details, like the influence of parallel / series and types of inverters on the system performance can be studied.

## 2.5. Multi objective optimization and multi criteria decision aiding

As mentioned previously, the modelling of solar neighborhood implies many different aspects, which most of the time are not modelled by the same tools. Moreover, the level of details is also different depending on the planning phase. It is therefore crucial to be able to switch from one tool to the other and therefore develop interoperability.

In the CAD environment, visual programming language have started to bridge the gap for the need of different tools for different applications and simulations. The end goal is to use one 3D model that can be used for different simulations, e.g. energy simulations and solar access simulations. Different external plugins enable studying relevant KPIs and other metrics. In the BIM environment, plugins are developed to also work with one 3D model and using that model for different applications and simulations. Therefore, these approaches allow to consider a wide range of criteria and to perform multi objective optimization or multi criteria decision aiding.

Some authors distinguish multi criteria decision aiding (MCDA) and multi objective optimization. The first one aims at providing a support for a decision regarding a specific goal considering a *finite existing set of alternatives*, (an alternative that could be buildings roofs or even districts). The second multi objective approach is a more continuous approach and aim at finding the optimal alternative with respect to the objective function. For example, MCDA can be applied to identify the best existing buildings or site for the implantation of a solar system. On the other hand, multi-objective optimization can be used to design a new solar building/district 'from scratch'.

### 2.5.1. Mono and multi-objective optimization

There has been great progress in the adoption of weighted variables in the sustainability decision making process. Contemporary tools can help develop optimization models that culminate from aggregating several relevant parameters that are critical to a process.

Different types of optimization exist; e.g. single optimization, multi-objective, and multi-domain optimization. These different optimizations are explained in Figure 5. Optimization studies can be performed in many tools, Figure 6 shows an example of the available optimization tools within the Grasshopper environment.

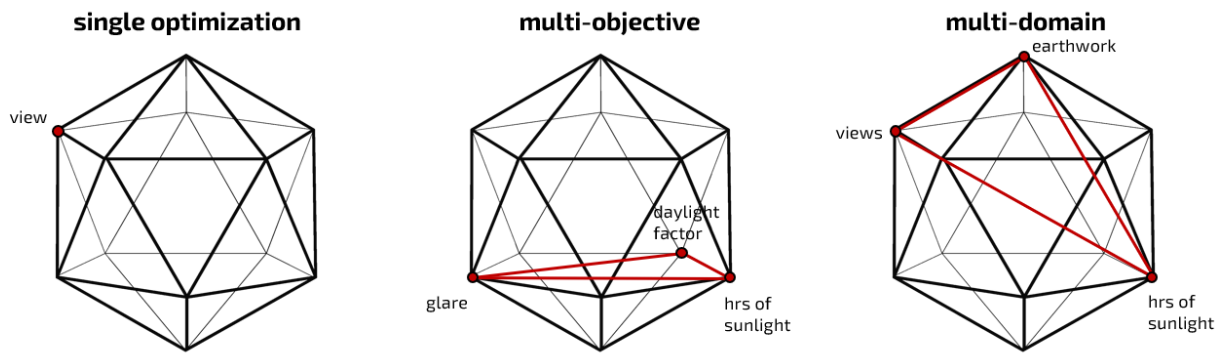

Figure 5. Example of different types of optimizations. Picture by Rafael Campamà Pizarro

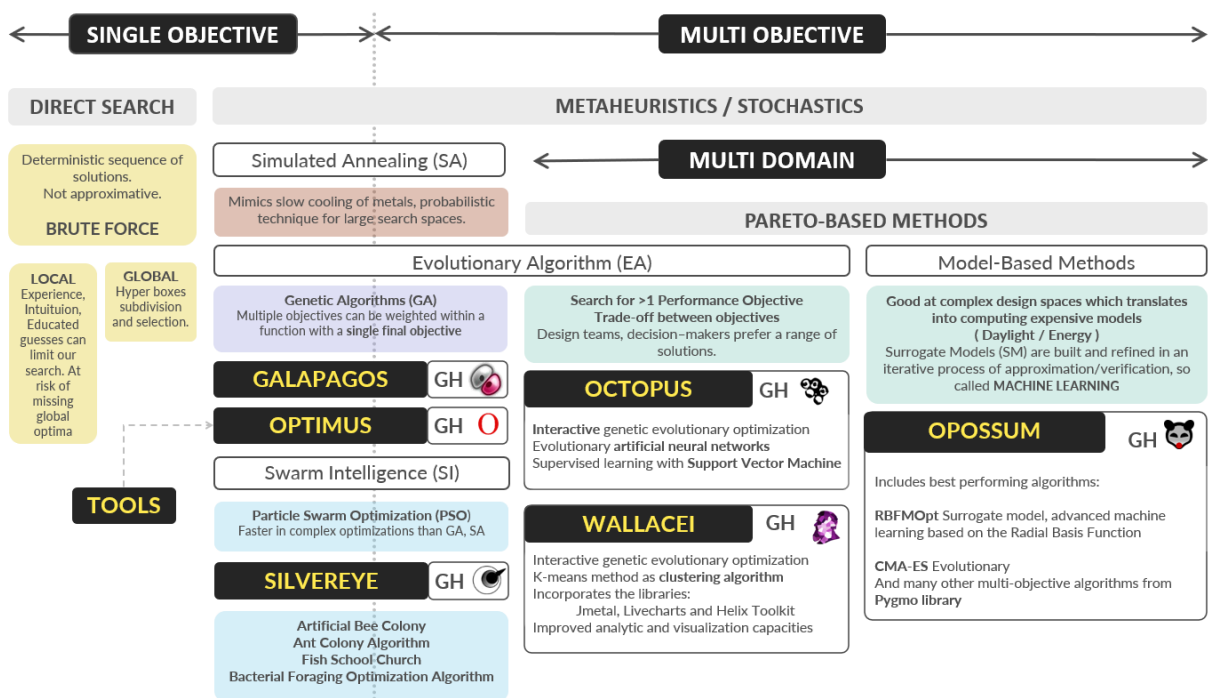

Figure 6. Optimization tools in Grasshopper. Picture by Rafael Campamà Pizarro

## 2.5.2. Multi-criteria decision aiding

Multi criteria decision aiding applied to solar neighborhood is more relevant to existing solar neighborhood than new neighborhoods. Indeed, multi criteria approaches are adapted for problems for which a choice must be made between a set of already existing alternatives.

In multi criteria decision aiding, mostly three types of problem can be addressed:

- Ranking
- Sorting
- Classification

A 'ranking' problem consist in creating an ordinal relation between all the set of alternatives. This includes a pairwise comparison and is usually applied to a small sample of alternatives (Greco et al., 2016). A 'sorting' problem consists in assigning the alternatives to predefined categories (for example A, B, C,S or 'Very good', 'Good', 'average' etc). In sorting procedure, the categories have an ordinal ranking. Finally, classification consists in assigning the alternatives to classes, which have no ordinal ranking.

Multi criteria decision aiding has been widely used in order to find optimal locations for solar farm sites (see e.g. the review of Sward et al. (2021)). However, more recently these multi criteria approach have been developed in the urban context in order to find the most adequate sites (here roofs or piece of roofs) for thermal or PV installations. Most of these studies consisted in superimposing several layers of information, and to compile them in order to find optimal roofs.

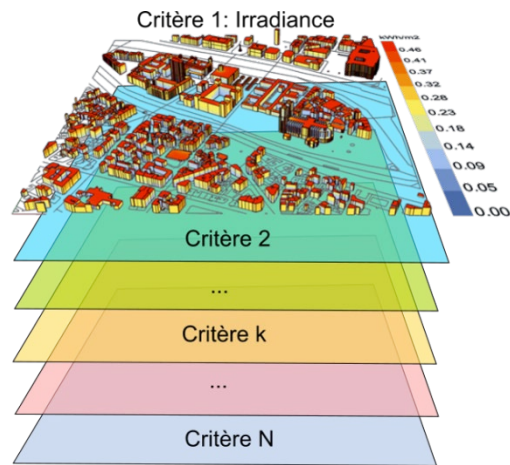

**Figure 7. Illustration of a multicriteria GIS problem. Picture after (Thebault et al., 2021)**

In the literature, several studies aimed at evaluating decision criteria for the urban PV installation. In Thebault (2021) the ELECTRE III (ranking methodology) method was used to rank a small sample of buildings (a dozen) based on their suitability to host PV systems. In this case they considered up to eleven decision criteria for a dozen of buildings. Kosoric et al. (2018) proposed a methodological framework considering the different phases of the installation process and the inherent decision criteria. They apply their method to a high rise building in Singapore and proposed an optimal integration scenario. At the district scale, Florio et al. (2021) combined visual impact, building energy consumption as well as power-grid constraints in order to propose an optimal deployment of PV systems. In a recent work, Thebault et al. (2020) developed a multi criteria sorting procedure to assess the PV-suitability of buildings in a district in Geneva, using the ELECTRE TRI (sorting methodology) method. These previous works were carried at the district scale. However, in order to massively deploy solar energy, these approaches needs to be developed at bigger spatial scale.

As the spatial scale increases, it gets more difficult to consider a wide range of criteria. This is in part due to the availability of the data (e.g. has the information been evaluated? is it possible to evaluate it at such scale?), the heterogeneity of the data (difference in the formats and evaluation methods within the studied area), data privacy (open-access, private, restricted) (Ali et al., 2020). At the city scale, Gupta et al. (2021) considered the capacity of the power distribution grid to propose a strategy for the spatial deployment of PV energy with reduced costs. Florio et al. (2018) assessed the visibility of the roofs from the streets in order to identify the piece of roof on which the installation of PV systems would have least aesthetic impacts. Lee et al. (2018) adopted a clustering approach to evaluate the PV-suitability of buildings based on technical and economic criteria.

## 2.6. Commercial vs Open-source

Simulation tools for performing advanced building energy and solar energy simulations are available with a commercial license, educational license, or are open source.

Many commercial tools are targeting a specific user group, i.e. urban planners or engineers designing PV / ST systems. Those who acquired a license normally have access to a support service. A downside is that often, commercial tools are black boxes, where not much is known / published how they actually work.

Open-source tools exist for all applications. Advantages are of course the absence of costs, but disadvantages could be that is harder to find the right support when problems occur. Some of the open-source tools have however very active online forums where help is provided.

---

## 3 Identification of National Common Indicators for Solar

---

This Chapter describes National Common Indicators (NCI) for solar neighborhoods measuring their performance for the participating countries of the Task. These NCIs can be based on legislation in these countries or have been obtained by best practice or are part of voluntary standards. The NCIs in this Chapter consider both active and passive solar energy. The aim is to highlight differences and similarities between different countries.

### 3.1. Short overview of Common Indicators for Solar Neighborhoods

In general, Common Indicators (or Performance Indicators) related to solar energy performance, can be classified in the following categories (Nault et al., 2015):

1. **Geometry-based:** metrics computed from the morphology of the buildings, based uniquely on the 3D geometry. Examples include the surface-to-volume ratio and the plot ratio.
2. **External solar and geometry-based:** metrics computed from the level of solar exposure of external surfaces expressed in terms of irradiation (kWh/m<sup>2</sup>) or illuminance (klux), considering the interaction of buildings and their geometry.
3. **Full climate and geometry-based:** metrics which are obtained through a more advanced simulation, accounting for the climate and 3D geometry in more detail. Examples include the spatial daylight autonomy and the energy need for space heating.

In the following sub-sections, the different categories are further described and specified. These Common Indicators are based on literature and certain legislation.

#### 3.1.1. Geometry-based

The geometry-based common indicators related to solar performance are:

- I. Direct solar access hours & probable sunlight hours
- II. Sky-view factor
- III. Obstruction angle
- IV. Window to wall ratio
- V. Window to floor ratio
- VI. Density indicators, e.g. floor area ratio

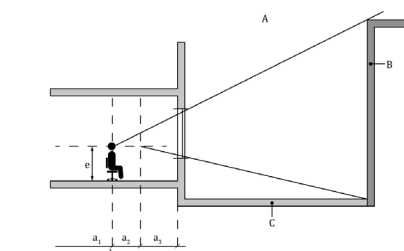

**Table 2. Geometry-based Common Indicators**

Common Indicator	Definition and description	Calculation method
Direct solar access hours & probable sunlight hours	Direct solar access hours are those hours that a surface has access to direct light from the sun. A related, but not similar concept is the Annual Probable Sunlight Hours (APSH) as defined in the United Kingdom. It is calculated in the same way as the direct solar access, however, the APSH also consider if the sky is covered with clouds and extracts data from the weather data for that.	Number of hours of direct sunlight that is received on the considered surface from the sun vectors at its sun path.
Sky View Factor	The Sky view factor is a time- and climate-independent metric that quantifies the amount of sky that is visible from any one point. This metric has been widely used in research on solar and daylight potential (Chatzipoulka et al., 2018; Freitas et al., 2015; Morganti et al., 2017). The SVF is widely used in shadow casting algorithms applied to raster-based modelling of large city areas for purposes such as solar radiation maps (Ratti & Richens, 2004).	There are two main definitions of the calculation method, as discussed by Zhang et al. (2012). The first definition is the geometric definition of SVF, which is commonly used by researchers in urban planning, architecture and urban climatology. It is a measurement of the sky visibility from a point. For that, the sky is divided into smaller patches and it is assumed that each patch of the sky dome is equally important. For urban climatologists, it is for the quantification of “the openness of a site within an urban setting that has important implications for incoming and outgoing radiation (solar and terrestrial) and thus heating and cooling patterns”(GRIMMOND, 2007). This is referred to as the Sky Exposure Factor (SEF) in his paper and it is the definition adopted by the previous studies that aim to evaluate the linear correlation between SVF and irradiance.
Obstruction angle	Blockage of the view to the outside, seen from the middle of the window pane over 0.8 m height (Norway)	
Window to wall ratio	Defined as the ratio of area of the building envelope that is glazed to the total building envelope area	
Window to floor ratio	Defined as the ratio of window glass area to total floor area served by the windows	
Floor area ratio	Defined as the ratio of a building's total floor area to the size of the piece of land upon which it is built.	

**View out**  
In the European standard for daylight in buildings, a certain level of view out is made obligatory (EN 17037. Daylight of Buildings, 2017). The view out relates to the amount of three layers that can be seen: a layer of sky, a layer of landscape, and a layer of ground.

Simplified verification method (EN 17037)



- Key
- a visible layers
  - b no sky
  - c no ground
  - e eye-level 1.2 m
  - A sky
  - B landscape/cityscape
  - C ground

Figure C.6 — Cross-section for simplified verification method

### 3.1.2. Climate-based

The second set of common indicators are climate based and are specified further:

solar irradiation, daylight and visual comfort, energy consumption, active solar production, and thermal comfort

**Table 3. Overview of climate-based indicators**

Common indicator	Definition and description
Solar irradiation	<p>Solar irradiation is the amount of energy that is received on a given surface, other a certain amount of time. In the last decades, digitized solar maps or solar cadastres are available for a growing number of places in the world (Desthieux et al. 2018; Jakubiec &amp; Reinhart, 2013; Kanters et al., 2014). Solar maps aim to provide a knowledge base for informing the public about the potential of installing active solar systems on their property, as well as it functions as decision tool for cities and utility companies. Many solar maps visualise the incoming annual solar irradiation. This solar radiation analysis can be appropriately carried out using 2.5D raster-based data. It involves creation of “hyperpoints” to represent vertical geometry elements from a DSM. The solar radiation analysis is then performed for every pixel using local meteorological radiation data, shadowing data from shadow casting computations, and position inclination and orientation of every pixel (Desthieux et al, 2018).</p>
Daylight and visual comfort	<p>The practice of evaluating daylight in buildings is usually performed on an individual building scale due to the required level of input details and high computation times. Evaluating daylight conditions for larger scenes with multiple building at an early design stage where inputs are constantly changing, the process becomes time-inefficient (Dogan et al., 2012). Efforts have been made to accelerate the simulation process of larger city parts at an early planning phase (R Compagnon, 2004; Nouvel et al., 2013). Visual comfort, in particular glare, has been, amongst others, defined in the new European standard of daylight in buildings. The common indicator ‘Daylight Glare Probability (DGP)’ is used and specified that it should not exceed a maximum value for more than 5 % of the usage time of the space.</p>
Active solar energy production	<p>In many studies and solar maps, the annual solar irradiation level is used to predict the suitability of installing active solar potential systems (particularly PV) (Kanters et al., 2014; Nault et al., 2015). A threshold value of 600 kWh/m<sup>2</sup> annual solar irradiation for PV panels on building envelopes is often used in European Research (Chatzipoulka et al., 2018; R Compagnon, 2004; Nault et al., 2015). Even though suggested thresholds from later studies tended to be higher (R Compagnon, 2004), advances in PV efficiencies and decreasing installation prices should lower the acceptable thresholds. In a study located in northern latitudes of Norway, annual solar irradiation of urban surfaces was classified into ranges, where “high” values began at 660 kWh/m<sup>2</sup> and “very high” at 880 kWh/m<sup>2</sup> (Lobaccaro et al., 2019).</p> <p>Reduction factors in solar potential assessments of urban morphologies can be used in order to account for shading due to architectural elements such as balconies and staircases, since simulated urban models consist of simplified volumetric shapes. This leads to calculation of “effective areas” of facades and roofs, which is then used in assessing the possible yield of solar generated electricity (Desthieux et al. 2018; Lobaccaro et al., 2019; Peronato et al., 2018; Saretta et al., 2020).</p>
Microclimate and outdoor thermal comfort	<p>Thermal comfort outdoors was previously overlooked in urban performance studies for its high complexity and lack of suitable software to estimate outdoor comfort metrics annually (Naboni et al., 2019; Natanian et al., 2020). However, more powerful computers and other developments have made such analyses easier to perform.</p> <p>Outdoor thermal comfort can be quantified using a metric called Universal Thermal Climate Index (UTCI). The UTCI is commonly used in the recent building and urban design studies, particularly as one of indicators considered in a holistic design optimization (Naboni et al., 2019). The outdoor thermal comfort is a delicate balance and small variations of how to place buildings strongly affect the local indoor and outdoor comfort (De Luca et al., 2021).</p>

## **3.2. Method for gathering NCIs from experts**

Parallel to the mentioned Common Indicators in section 3.2, which were mainly based on literature, countries have their own legislation in place concerning the active and passive utilisation of solar energy. Therefore, National Common Indicators (NCIs) were gathered from experts from the participating countries to understand which Common Indicators were used and which threshold.

### **3.2.1. Obtaining National Common Indicators**

The National Common Indicators were gathered through the participating experts of Task 63. Experts contributed by adding a list of NCIs to an excel file. The gathered NCIs were discussed during Task meetings.

Based on these discussions, the gathered NCIs were divided into a 'legislative' and 'voluntary' category, since in many countries, there were NCIs that were not necessarily according to the legislation, but more on voluntary basis. The 'voluntary' category consists of Common Indicators from certifications, best practices, or from different (building) performance labels.

Furthermore, the NCIs were divided into their application area: I) 'Passive solar + daylight and II) Active solar.

### **3.2.2. Overview of NCIs**

The NCIs as obtained are shown in Tables 5-11. First, the NCIs that are according to legislation in the different countries are displayed, followed by the voluntary NCIs. It should be kept in mind that new legislation on daylighting in buildings is gradually coming into force within the European Union – EN 17037.

### 3.1.1.1 Legislative Common Indicators

The Tables 4-6 show the legislated NCIs for Direct Solar Access, daylight, and Active Solar Energy.

**Table 4. National Common Indicators for Direct Solar Access (legislated)**

Country	Metric	Threshold	Date	Time	Place	Type of building
Australia (ACT)	Direct solar access hours	Minimum 3 hours	winter solstice (21 June)	Between 9am and 3pm	floor or internal wall of a daytime living area	Existing Residential
Australia (ACT)	Solar Envelope	Geometry	winter solstice (21 June)	Daytime	Solar Boundary fence	New Residential
		3m northern boundary solar fence and 2.4m for all other boundaries			A daytime living area is provided with a minimum of 4m <sup>2</sup> of transparent vertical glazing that:	
	Direct solar access hours	4m <sup>2</sup> of sunlight			a) is oriented between 45° east of north and 45° west of north; and b) is not overshadowed at noon on the winter solstice (21 June) by: - buildings and structures on the subject block  the 'solar fence' on the northern boundary of the subject block	
Australia (NSW)	Direct solar access hours	Minimum 3 hours	winter solstice (21 June)	Between 9am and 3pm	Principal private open spaces	Residential
Australia (South Australia)	Building Envelope	Geometric	winter solstice (21 June)	daytime	Interface between higher and lower density development	Urban Neighborhood Zone
		30° building envelope to the south or 45° building envelope at north, east or west of the development				
Canada (Toronto)	Urban Heat Island / Solar Reflectance Index (SRI)	≥ 29			at least 50 % of site's non-roof hardscape (Tier 1)	
China	Direct solar access hours	≥ 2, 3 hours	20-Jan			
China	Direct solar access hours	≥ 1 hours	21-Dec			
Czech republic	Direct solar access hours	> 1.5 hours	01-Mar			
Denmark	Window to Floor Ratio	> 10 %				
Estonia	Direct solar access hours	≥ 50 % probable sun hours	22-Apr to 22-Aug			
France	Direct solar access hours	≥ 2 hours	21-Dec		façade of every living space	
France	Window to Floor Ratio	>1/6				
France	Window to Wall Ratio	at least one room with >30% glazed surface				
Germany	Direct solar access hours	≥ 1 hour	17-Jan		at least one window	Residential
Germany	Direct solar access hours	≥ 4 hours	21-Mar, 21-Sep		at least one window	Residential
Italy	Window to Floor Ratio	≥ 1/ 8				

Netherlands	Window to Floor Ratio	≥ 1/ 10				Residential
Norway	View outside	not specified				Every room for continuous occupancy must have at least 1 window with sufficient view to the outside
Norway	Obstruction angle	≤ 45°				Blockage of the view to the outside
Poland	Direct solar access hours	≥ 3 hours	21-Mar, 21-Sep	7:00 - 17:00		permanently occupied rooms
Poland	Direct solar access hours	≥ 1.5 hours	21-Mar, 21-Sep	7:00 - 17:00		at least one room in apartment buildings
Slovenia	Direct solar access hours	≥ 2 hours	21-Dec			
Slovenia	Direct solar access hours	≥ 4 hours	21-Mar, 21-Sep			
Slovenia	Direct solar access hours	≥ 6 hours	21-Jun			
Slovakia	Direct solar access hours	≥ 1.5 hours	1-Mar to 13 Oct			windows of 1/3 of apartment living area, calculated on point centred on the glazing room window.
UK	Direct solar access hours	25 % Annual Probable Sunlight Hours	whole year			
European Union	Direct solar access hours	≥ 1.5 hours (good), ≥ 3hrs (very good), ≥ 4 hours (optimal)	between 1-Feb and 21-Mar			At least one habitable room in the dwelling should have exposure to sunlight

**Table 5: National Common Indicators for Daylight (legislated)**

Country	Metric	Threshold	Date	Place	Height	Type of building
Denmark	Illuminance level (daylight autonomy)	> 300 lux	> 50 % daytime	> 50 % of area		Offices, residential
France	Daylight Factor	> 1.5 %		1 <sup>st</sup> rank zone" (= zone delimited by a distance of { 2 x (room height – working plane height) } from the façade)	0.7 m	
France	BBio ('bioclimatic indicator', also account for passive solar heat gain)	< BBio max (depends on the region in France)	NA			Residential
Italy	Daylight Factor	≥ 2 %				Residential, gym
Italy	Daylight Factor	≥ 2 %				Hospitals & schools
Italy	Daylight Factor	≥ 1 %				Offices
Norway	Daylight Factor	≥ 2 %		Average DF in rooms with continuous occupancy (at 0.5 m from wall)	0.8 m	
Sweden	Daylight Factor	≥ 1 %		a point located halfway through the room depth	0.8 m	

**Table 6: National Common Indicators for Active Solar Energy (legislated)**

Country	Metric	Threshold
Norway	Aesthetical design of surroundings	
Norway	Good architectural design	
Norway	Good visual qualities, both for itself and with respect to its function and its surrounding environment and placement in accordance with the municipality's standards	PV or solar thermal collectors contrasting strongly with the roof/building materials
Switzerland (Vaud)	Domestic Hot Water solar coverage	≥ 30%
Switzerland (Vaud)	Electricity solar coverage	≥ 20%
Switzerland (Geneva)	Domestic Hot Water solar coverage	up to 50%
Switzerland (Geneva)	Electricity solar coverage	up to 30 W/m <sup>2</sup> area built

### 3.1.1.2 Voluntary Common Indicators

Tables 7 –10 show the voluntary NCIs concerning Direct Solar Access, Daylight and Active Solar Energy.

**Table 7: National Common Indicators for Direct Solar Access (voluntary)**

Country	Metric	Threshold	Date	Time	Place	Height
Canada	Outdoor thermal comfort	t.b.d.				
Netherlands	Direct solar access hours	≥ 2 hours	19-Feb to 21-Oct		best practice	Middle of window sill
Netherlands	Direct solar access hours	≥ 3 hours	21-Jan to 22-Nov		best practice	Middle of window sill
Sweden	Direct solar access hours	5 hours	21-Mar		Playground, places to sit	

**Table 8: National Common Indicators for Daylight (voluntary)**

Country	Metric	Threshold
France	Daylight Autonomy	n/a
Switzerland	Daylight Factor	≥ 2 - 5 %

**Table 9: National Common Indicators for Indoor Thermal Comfort (voluntary)**

Country	Metric	Threshold	Date	Type of building
Denmark	Thermal comfort indoors	<27°C	(not more than 26 deg for more than 100 hours when in use, not more than 27 deg for more than 25 hours) per year	Offices

**Table 10: National Common Indicators for Active Solar Energy (voluntary)**

Country	Metric	Threshold	Comments
Canada	(active) Solar Readiness		Ensure that buildings are designed to accommodate connections to solar PV or solar thermal technologies (Tier 2)
Canada	Energy production Solar Coverage	≥ 5 %	Minimum of 5 per cent of the building's annual energy consumption from one or a combination of acceptable renewable energy sources
Denmark	Annual irradiation	> 850 kWh/m <sup>2</sup>	Level due to cost-efficiency
Sweden	Energy Solar Coverage		How much can active solar energy production contribute to the energy mix in a future neighborhood?

### 3.3. Showcase of consequences of National Common Indicators

This section provides an overview of all National Common Indicators. A case is presented that shows the consequences of some of the NCIs applied on the design of a neighborhood. In order to do so, simulations were run with Ladybug / Honeybee for a fictive location with a variable latitude and a fixed longitude (0°). Three NCIs were chosen to show the different impact of NCIs and are listed in Table 11. These three were chosen because they are different of character (a specific date versus annually) or covering a whole continent. Note that these NCIs are all geometry-based and not climate-based.

**Table 11: Selected NCI for showcase**

Country	threshold	date
China	≥ 1 hours of sunlight	21-Dec
UK	25 % Annual Probable Sunlight Hours*	whole year
European Union	≥ 1.5 hours (good), ≥ 3hrs (very good), ≥ 4 hours (optimal)	between 1-Feb and 21-Mar

\*The NCI APSH is officially calculated taking into account the climate / cloud cover. This has not been done here.

A building block with different parameters was set up, see Figure 8. The variables were width of building block, depth of building block, building depth, and building height. These variables resulted in a different obstruction angle  $\alpha$  (Figure 8 and Table 12).

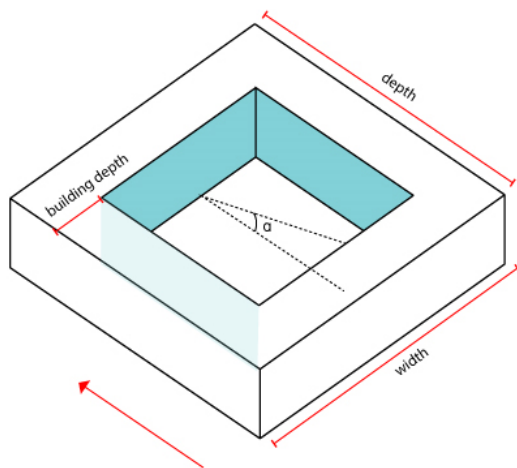

**Figure 8: Building block configurations**

Three facades facing South, East and West were selected since it is likely where daylight is harvested for apartments. One output of the simulations was the share of the inner court-facing facades that did not meet the threshold of the different NCIs. For the European norm 17037, it would mean at least the minimum category (>1.5 hrs on 21<sup>st</sup> of March).

*Table 12: variables for building block*

Case	Block Width	Block Depth	Building depth	Building height	Obstruction angle
1	65	65	12	24	30°
2	80	65	12	18	24°
3	65	80	12	18	18

The latitude was varied from 0 to 70°. Table 13 shows the participating Task 63 countries with their lowest and highest latitude and its capital.

Table 13: participating countries with latitudes

Country	Lowest latitude	Capital	Highest latitude
Canada	41	45 (Ottawa)	83
China	18	40 (Beijing)	53
Denmark	54	56 (Copenhagen)	57
France	42	49 (Paris)	51
Italy	37	42 (Rom)	47
Norway	58	60 (Oslo)	71
Sweden	55	59 (Stockholm)	64
Switzerland	46	47 (Bern)	48

Figure 8-10 show the share of façade surface that do not meet the requirements of the three NCIs for a varying latitude. The Figures clearly shows that at higher latitude, the NCIs are hard to reach for all cases. Even for NCIs which thresholds that should fit the countries from which they have originated, there are parts of the facades facing the inner courtyard that do not meet those thresholds.

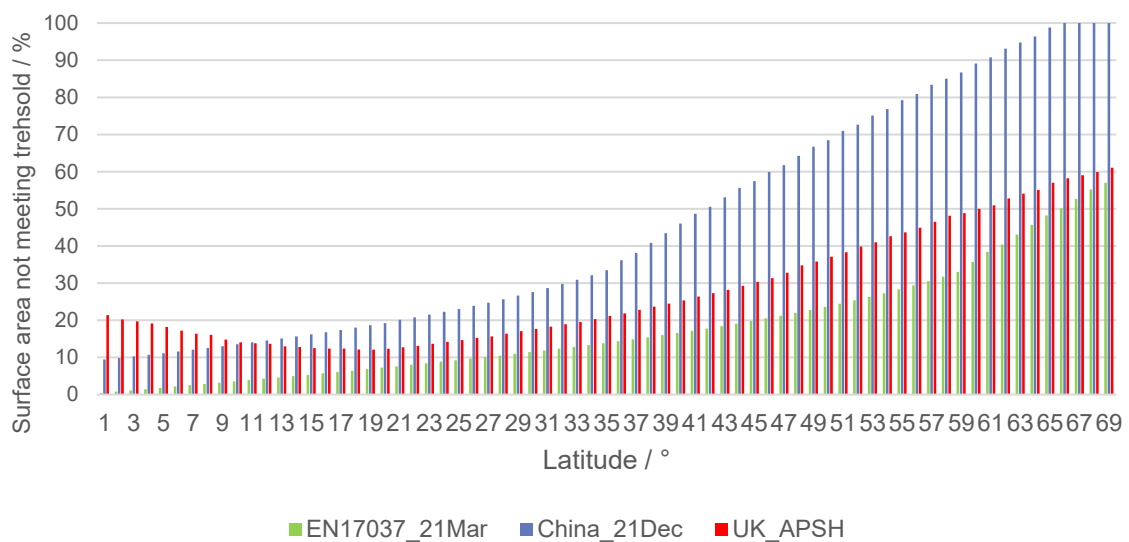

Figure 9: Case 1: share of courtyard-facing facades not meeting the threshold

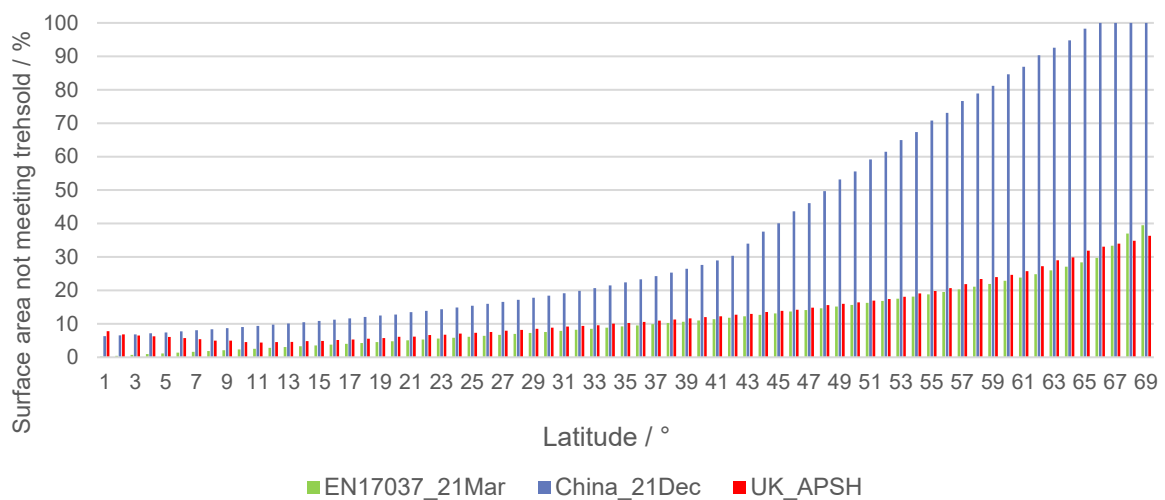

Figure 10: Case 2: share of courtyard-facing facades not meeting threshold



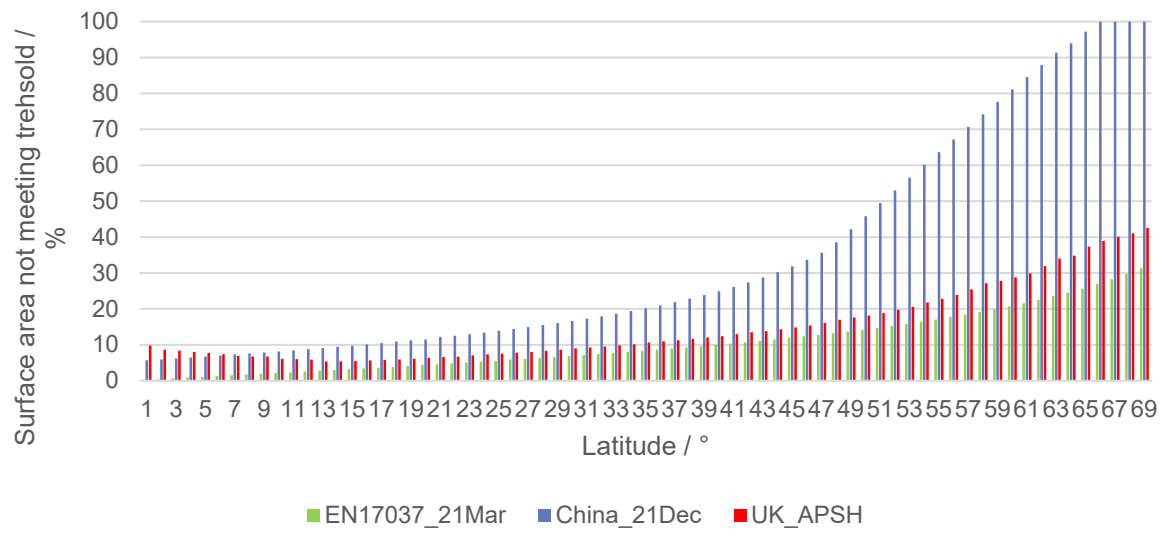

Figure 11: Case 3: share of courtyard-facing facades not meeting threshold

---

## 4 Workflow stories

---

### 4.1 Introduction

How can tools support urban planners and other actors in the planning process for solar neighborhoods? The overview of tools (Chapter 2) and the National Common Indicators (Chapter 3) already have provided some context to that question, but in this chapter 'workflow stories' will highlight how commercial and non-commercial players have worked with tools in the planning process for solar neighborhoods. These workflow stories focus on mainly one project or tool which outcomes have supported decision makers.

The workflow story describes shortly the project, which Key Performance Indicators that were important in the project, how tools have been used throughout the planning process, and which lessons were learnt from using the tools.

**Table 14. Workflow stories**

Country	Project / Tool
Australia	City of Melbourne
Australia	SunSpot tool
Canada	West 5
China	City Valley
Denmark	Faelledby
France	Leroy-Merlin
France	Lake Zilang
Italy	Solar Sculpting
Norway	Bryggerikvartalet E.C. Dahls
Norway	Sluppen
Norway	Gullhaug Torg 5
Sweden	Daylight Access in Existing Swedish Neighborhood
Sweden	inFORM
Switzerland	G2 Solaire

Commercial Workflow stories are marked with **YELLOW**, non-commercial and academic workflow stories are marked with **BLUE**.

# City of Melbourne

Maria Panagiotidou, Jacek Jasieniak - ARC Centre of Excellence in Exciton Science and Department of Materials Science and Engineering, Monash University, Australia

Miguel Brito - Instituto Dom Luiz, Faculdade de Ciências, Universidade de Lisboa, Portugal

Kais Hamza - School of Mathematics, Monash University, Australia

Jin Zhou - Department of Civil Engineering, Monash University, Australia



MONASH  
University

Australian Research Council Centre of Excellence in



## About the project

This project provides an analysis of solar energy production potential for the City of Melbourne at various spatial resolutions and explores the relationship between PV output, urban morphology, climatic conditions and energy consumption used within the local distribution network. For completeness, the approach includes a 3D assessment of building surfaces that considers an

important subset of BIPV in the form of semi-transparent (ST-PV) technologies as an innovative alternative to conventional glazing systems. The summary information below is sourced from a detailed research paper from Panagiotidou et.al (2021) and also presented at the Asia-Pacific Solar Conference (2021).

## Key Performance Indicators in the project

The modelling focused on the City of Melbourne, a 37.4 km<sup>2</sup> municipal area that includes the central business district, an industrial area and mid-rise developments in the inner-city suburbs. A key performance indicator of the project was the quantum of electricity potential BAPV roof, BIPV wall and ST-PV window surfaces could deliver to meet the annual electricity consumption of the City of Melbourne. Using 2018 smart electricity meter data from C4NET (2020) and a PV potential methodology that utilised a linear regression approach correlating urban

form indicators relative to footprint area ratios (kWh m<sup>2</sup>/a), the project results showed that solar PV could achieve up to 74% (2354 GWh/a) of the estimated electricity consumption of the city area. Rooftop panels accounted for the vast majority – 88% – of the potential solar energy the area could generate, with wall-integrated and window-integrated solar delivering 8% and 4% respectively.

Assumptions for the PV deployment and performance simulation.

Parameter	BAPV roof	BIPV wall	ST-PV window
Technology	PERC	PERC	Perovskite ST-PV
Mounting type	Roof-applied	Wall-integrated	Window/curtain wall integrated
Efficiency (%)	23	23	10
Aperture area	0.9	0.9	0.9
T <sub>Pmax</sub> (%/°C)	-0.35	-0.35	-0.20
AVT (%)	0	0	30
PR (-)	0.79	0.79	0.82
UR (-)	0.8	0.8	0.8
Annual solar radiation threshold (kWh m <sup>-2</sup> a <sup>-1</sup> )	1000	800	800

T<sub>Pmax</sub>: temperature coefficient of P<sub>max</sub>, AVT: average visual transmittance, UR: utilisation ratio, PR: performance ratio.

## Tools in the project

### Output

The major contributions of this study reside in the following outcomes:

- The estimation of the ST-PV window potential in the urban scale. The ST-PV window potential along with the estimation of the emerging BAPV roof and BIPV wall potential, lead to the calculation of the total PV potential of the urban environment.

- The development of a multi-scalar approach for the analysis of the PV potential. This is realised through the simulation of the PV potential in the neighbourhood scale, its linear regression with characteristics of the urban morphology and its prediction in the city scale. At the same time, the PV potential of key buildings, identified through the neighbourhood scale simulations, is also calculated.

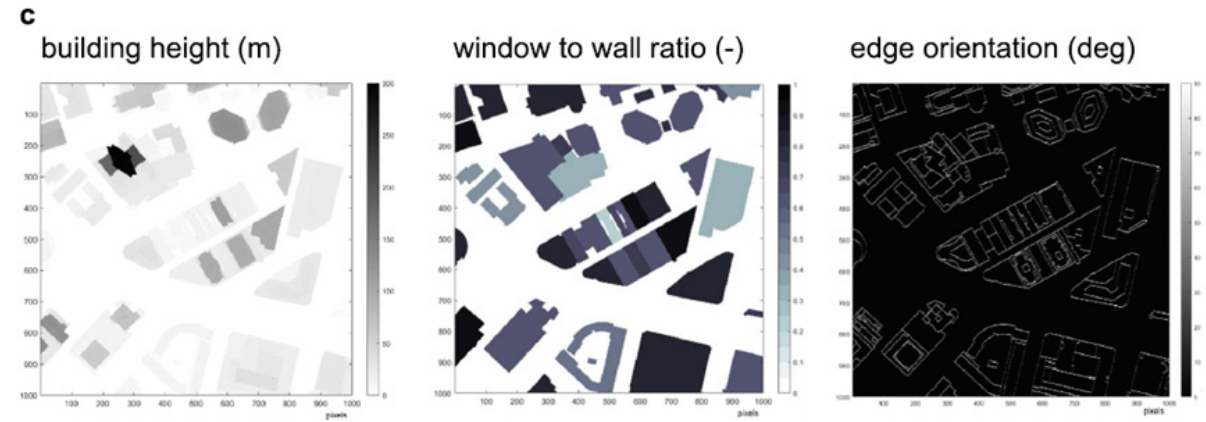
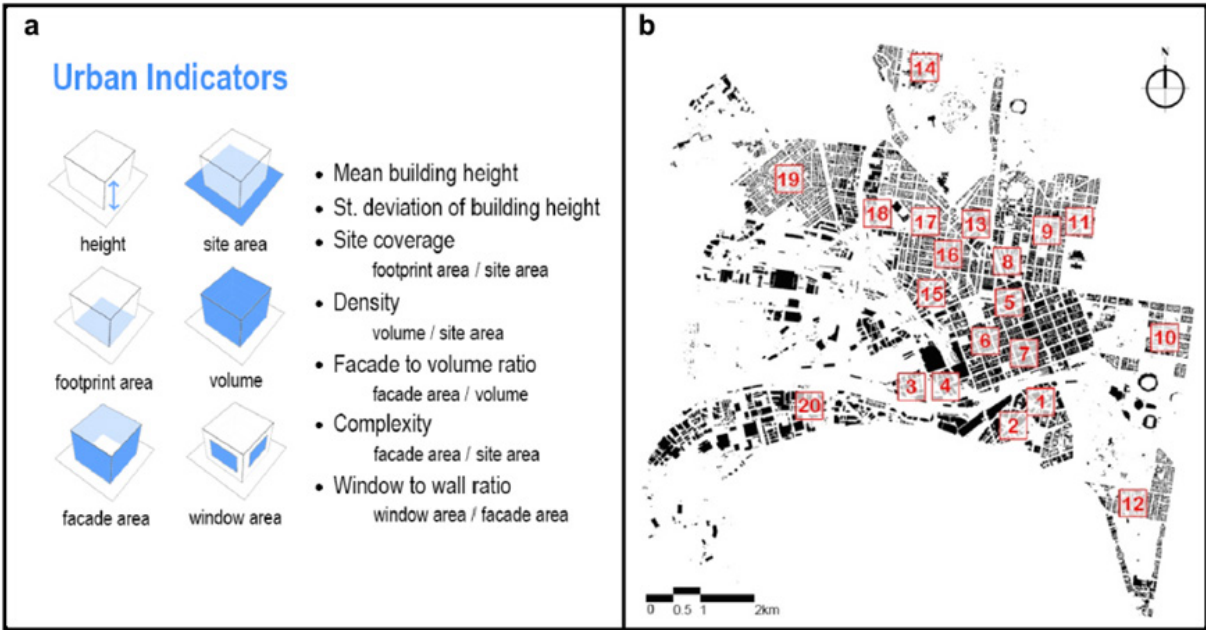

Morphological analysis of selected urban areas (neighbourhood scale) of the City of Melbourne. *a.* The urban form indicators *b.* Selection of 20 urban areas (sized 500 by 500 metres) *c.* Raster images of building height (m) (left), window to wall ratio WWR (-) (middle) and edge orientation (right) of area no 1.

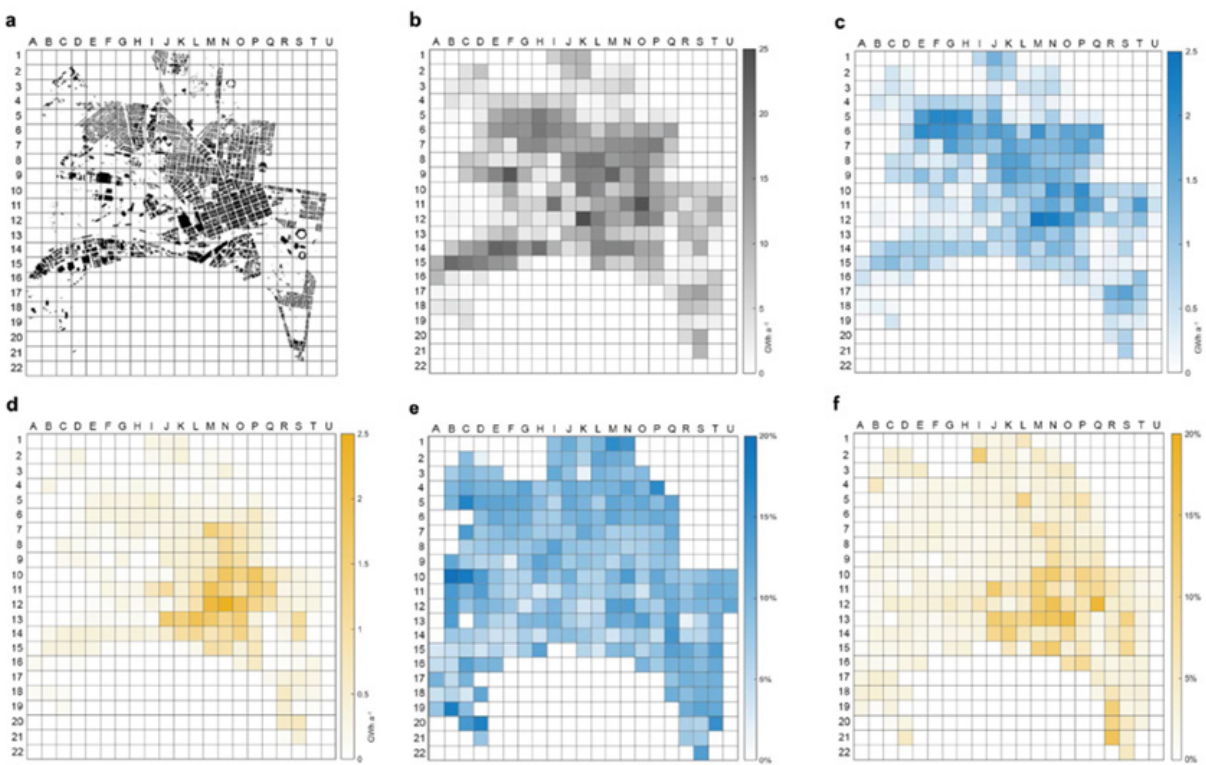

Annual PV Potential of the City of Melbourne in a 500m resolution. *a.* Footprint area of the City of Melbourne *b.* BAPV roof potential *c.* BIPV wall potential *d.* ST-PV window potential *e.* % of BIPV wall potential over the total *f.* % of ST-PV window potential over the total.

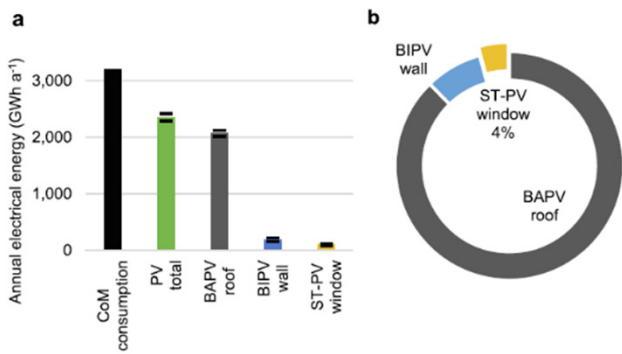

Real-world electricity consumption and estimated PV potential for the City of Melbourne. a. Electricity consumption in 2018 and production estimation in case of fully deployed BAPV roof, BIPV wall and ST-PV window. The horizontal lines indicate the upper and lower bounds of prediction b. Percentage of the annual total PV production potential by the three PV type.

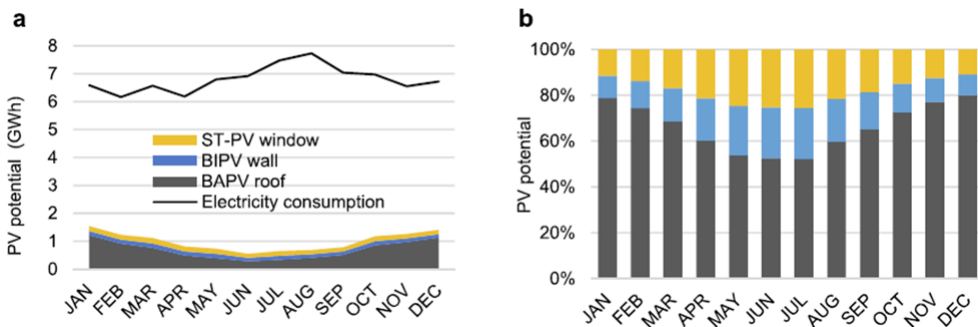

Seasonal performance and electricity consumption of area number 5. a. Monthly PV potential of the three PV types and electricity consumption of 2018 b. Monthly share of the total PV potential that each PV type holds.

## Used tools

Seven urban form variables were calculated in Matlab by applying building height and window to wall ratios (WWR) from an open source building footprint dataset of the City of Melbourne (2018) and represented using ArcGIS PRO. Daysim/Radiance and PVWatts was then employed to calculate PV potential.

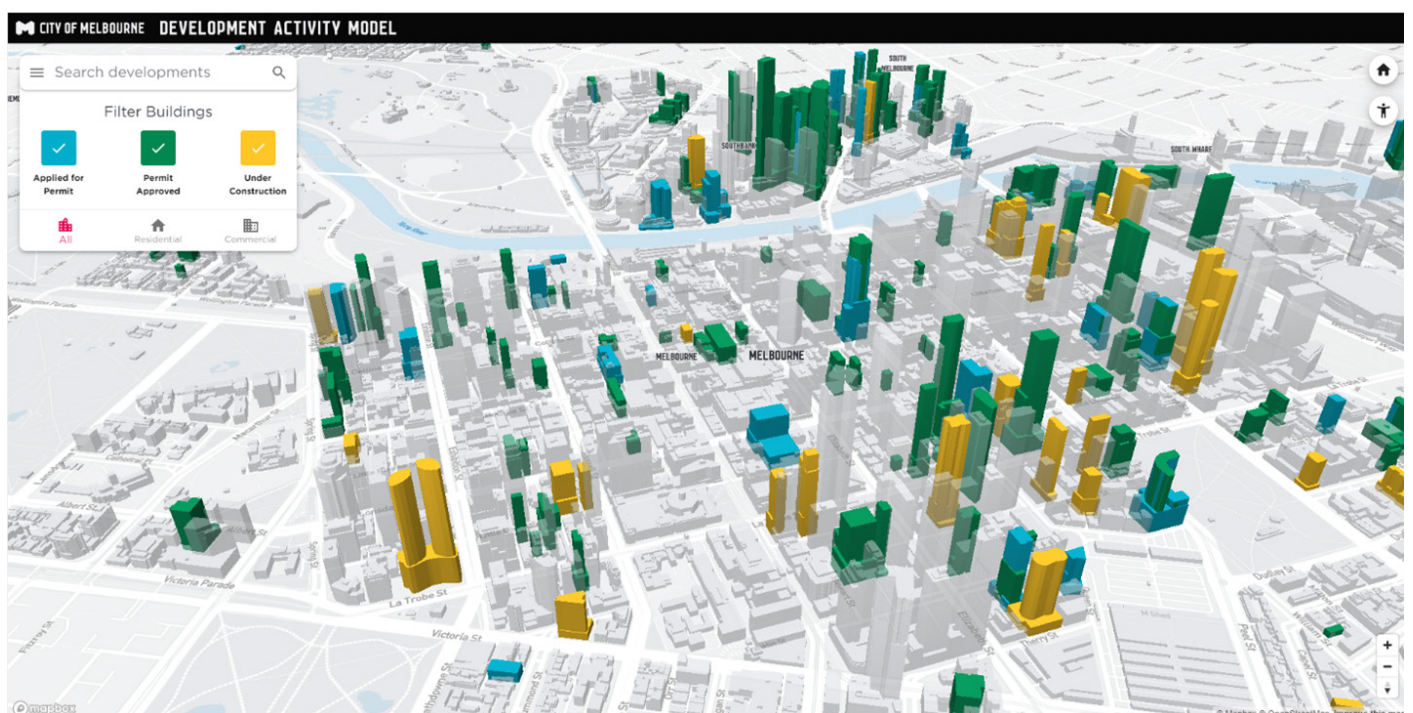

3D Development Activity Model <https://www.developmentactivity.melbourne.vic.gov.au>

The framework for the calculation of the PV potential for selected urban areas (neighbourhood scale) of the City of Melbourne is presented below.

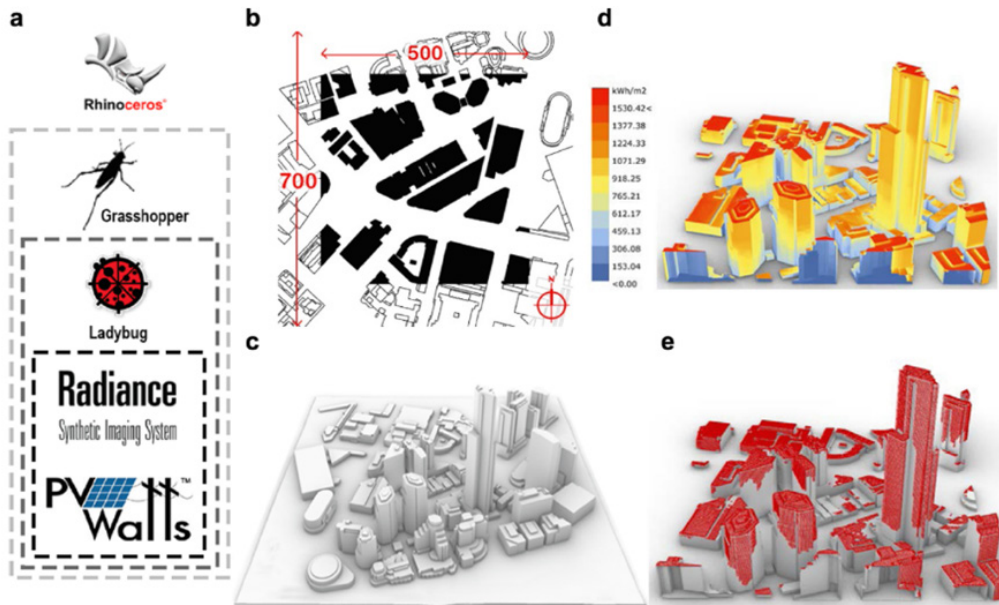

a. Solar potential simulation framework, software structure and tools. b. Simulated (black) and surrounding (white) buildings of area no. 1. c. 3D view of the modelled area, including the surrounding buildings and the terrain. d. Annual solar radiation results on the building envelope. e. Suitable roof (solar radiation  $\geq 1,000 \text{ kWh m}^{-2} \text{ a}^{-1}$ ) & façade areas (solar radiation  $\geq 800 \text{ kWh m}^{-2} \text{ a}^{-1}$ ) for the installation of PV modules (red areas).

Three buildings were selected for detailed simulation, ranging from medium to high ST-PV window potential to building footprint area ratio. To increase simulation accuracy, detailed modelling was conducted, improving the LOD from 1 to 3. Building drawings, pictures and

'Google street' views were employed when available. For each building, the suitable envelope areas were identified and the PV potential of BAPV roof, BIPV wall and ST-PV window was calculated for a representative summer and winter week.

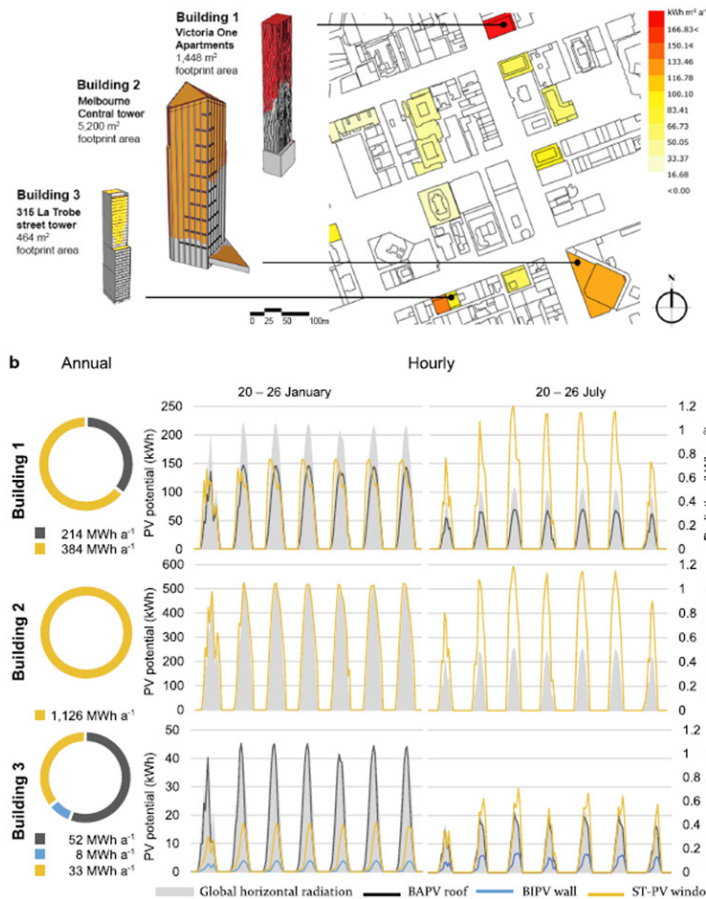

Heat map of the annual ST-PV window potential of area number 5 and seasonal PV performance of selected buildings. a. ST-PV window potential to building footprint area ratio ( $\text{kWh m}^{-2} \text{ a}^{-1}$ ) and the selection of high-performing buildings b. Doughnut chart of the annual PV production and hourly PV performance of a typical winter and summer week.

## Challenges / Lessons learnt

The research found that at the neighbourhood scale, the ST-PV window contribution can become significantly higher, reaching values up to 18% of the total within central urban areas that are characterised by high values of mean and standard deviation of building height, window to wall ratio, urban density and complexity. When single high-rise buildings, that are predominantly glass-based and within dense urban areas are considered, ST-PV windows can produce up to 100% of the total PV potential, favourably supplying similar amounts of electricity throughout the year. This is unlike buildings with a high prevalence of BAPV roofs, for which reduced sunlight during winter periods yield 30–40% reductions in PV electricity productions compared to summer.

The project highlights the challenges in undertaking PV tool simulation at different urban scales whilst being mindful of the level of detail (LoD) required to support planning process decision-making. The methodology used demonstrates a robust approach for considering complex 3D urban environments and prospective PV generation surfaces for BAPV, BIPV wall and ST-PV applications.

## References

Asia Pacific Solar Conference (2021) 16-17 Dec 2021. <https://apvi.org.au/solar-research-conference/proceedings-apsrc-2021>

C4NET (2020) Centre for New Energy Technologies. City of Melbourne Electricity data usage – C4NET observations <https://c4net.com.au/projects/concils-access-to-aggregated-energy-data/>

City of Melbourne (2018) 2018 Building Footprints | Open Data. <https://data.melbourne.vic.gov.au/Property/2018-Building-Footprints/pq2z-35fu>. See also Development Activity Model <https://www.developmentactivity.melbourne.vic.gov.au>

Panagiotidou, M., Brito, M.C., Hamza, K., Jacek J. Jasieniak, J.J. & Zhou, J. (2021) Prospects of photovoltaic rooftops, walls and windows at a city to building scale, *Solar Energy*, Volume 230, 2021, Pages 675-687, ISSN 0038-092X, <https://doi.org/10.1016/j.solener.2021.10.060>.

# SunSPoT – APVI Solar Potential Tool

Jessie Copper, Mike Roberts, Tyce Barton, Rebecca Hu and Anna Bruce  
Australian PV Institute (APVI) and University of NSW (UNSW) Sydney



## About the project

The SunSPoT tool is an open access modelling platform and allows end users to calculate the technical solar power potential of rooftops. It uses geospatial data and combines solar exposure, energy generation and consumption from precincts across Australia. The tool has been developed by the Australian Photovoltaics Institute (APVI) and University of NSW (UNSW) with technology partners Solar Analytics and Enosi Pty Ltd, as part of an Energy Data for Smart Decision Making project, funded by the Australian Government's Smart Cities and Suburbs program.

SunSPoT has been applied predominately at a national and city level for major metropolitan areas of Australia and also for specific local government usage. Specific reports have been generated to assess the solar potential from stadiums for major Australian sporting codes (Cricket, Soccer and the Australian Football League (AFL) (Abdullah-Vetter et.al., 2021), prisons, hospitals and schools in the State of Queensland (Roberts et.al.,2020) but also, more recently, in assessing PV potential for social housing to help alleviate fuel poverty (Roberts et.al.,2021).

This workflow story is drawn from the SunSPoT tool applied to the local government area of Perth, a city in Western Australia (Copper et.al.,2019).

## Key Performance Indicators in the project

The project estimated the useable area suitable for PV deployment across Perth using two different methods and two different datasets. The calculation takes account of the orientation and slope of the rooftop, as well as the average insolation and the degree of shading.

Conservative results suggest around 30% of total roof area in Perth is suitable for PV deployment, accommodating around 400,000 solar PV panels (rated @ 250W) with an annual generating capacity of 153 GWh/year. This equates to abating the equivalent of 107,000 tonnes of CO<sub>2</sub> emissions and supplying power to over 29,000 Australian households. Based on typical tariff rates, the potential savings on electricity bills was estimated at being around AU\$33 million per year.



# Tools in the project

## Output

The project assessed the PV potential for the local government area of Perth and an estimate of the potential impact of rooftop PV on local electricity consumption and greenhouse gas emissions.

The work also identified rooftops with the largest PV potential and presented case studies for four landmark buildings in Perth.

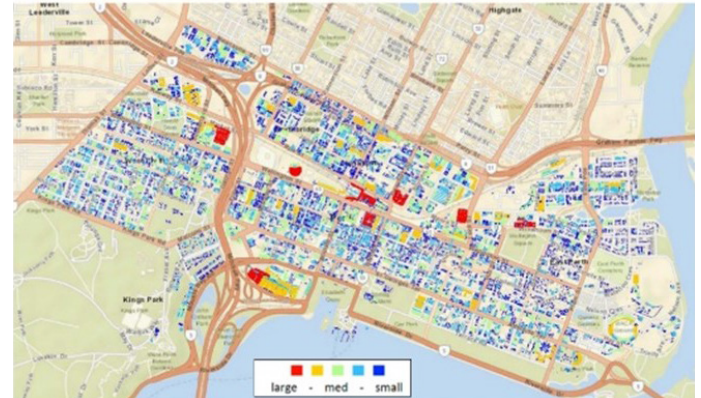
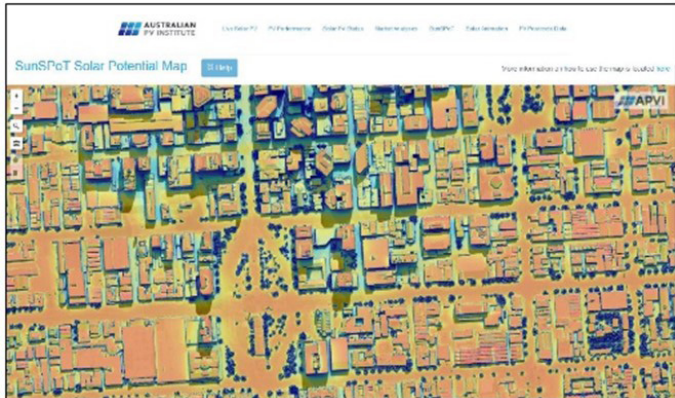

APVI Solar Potential Tool (SunSPoT) Map representation (left) and Perth CBD rooftops with the largest PV potential (right)

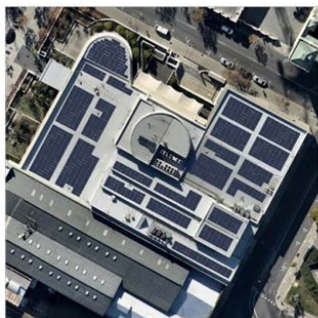

News Corp Building

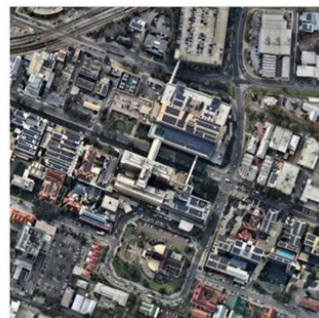

Royal Perth Hospital

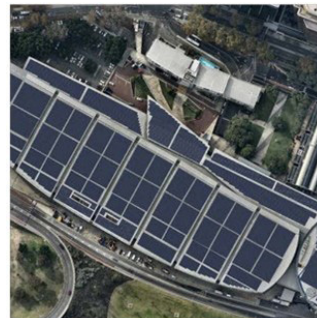

Perth Exhibition/Convention Centre

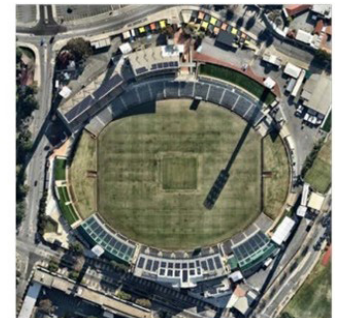

Western Australia Cricket Arena

## Used tools

At a city level, an insolation heatmap layer (see below) allows identification of the best roofs, while the shadow layer enables the user to locate an unshaded area on a rooftop. Users can select any building within the mapped

area, outline a specific roof area and automatically generate an estimate of potential annual electricity generation, financial savings and emissions offset from installing solar PV.



a. aerial photo

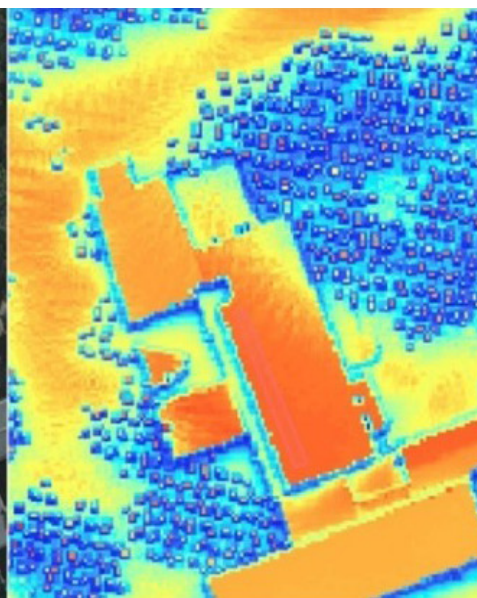

b. insolation heatmap

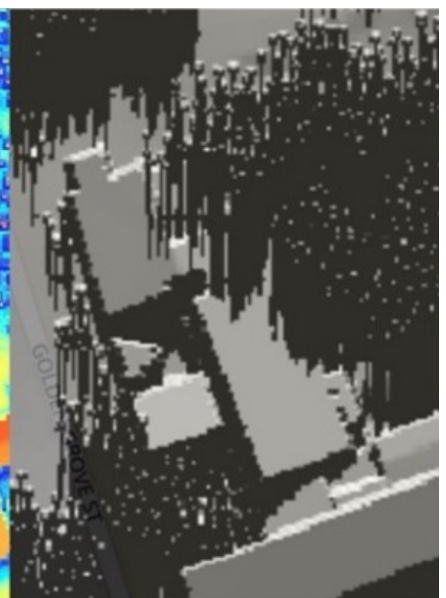

c. winter shadow layer

The data behind the APVI SunPoT were generated as follows:

1. Three types of digital surfaces models (DSMs) (3D building models, XYZ vegetation points and 1 metre ESRI Grids), supplied by geospatial company AAM, were used to model the buildings and vegetation in the areas covered by the map.

2. The DSMs were used as input to ESRI's ArcGIS tool to evaluate surface tilt, orientation and the annual and monthly levels of solar insolation falling on each 1m<sup>2</sup> unit of surface.

3. Insolation values output by the ArcGIS model were calibrated to Typical Meteorological Year (TMY) weather files for each of the capital cities and against estimates of insolation at every 1 degree tilt and orientation from NREL's System Advisor Model (SAM).

Two rooftop suitability methods were used to test the sensitivity of the estimated PV potential. This involved assessing the AAM building model and vegetation DSM to calculate the tilt, aspect and solar insolation of roof areas and determine suitable roof planes based on a minimal level of surface insolation. NREL's PV rooftop suitability method (Gagnon, et.al. 2016) based on ArcGIS's hillshade function and omitting unsuitable southern hemisphere surface orientations (southeast through southwest) was then applied with a minimum criteria of 10m<sup>2</sup> of contiguous area to ensure a minimum 1.5kW PV system for any plane defined as suitable.

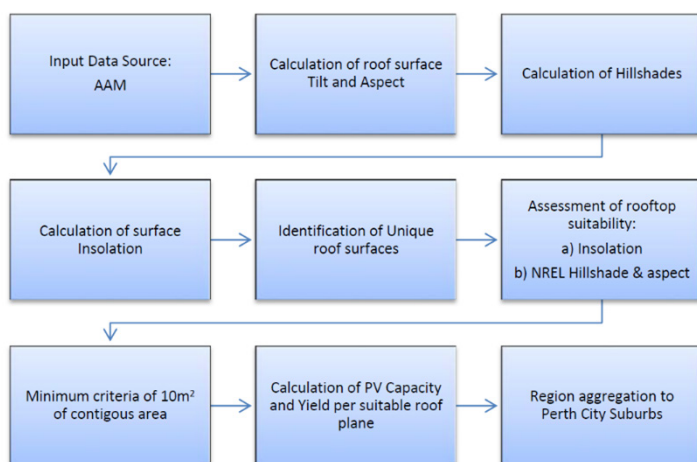

Workflow map process steps for calculating rooftop PV potential

## Challenges / Lessons learnt

During the Perth study, the project team undertook a comparison between LiDAR data previously used and the AAM DSM dataset. As represented below, general agreement was found between the roof planes identified as suitable via these two input data sources. The analyses undertaken with the LiDAR data set, however, excludes a greater proportion of roof surfaces. As no LiDAR data was available for the Perth analysis, a lower limit for the

solar potential was estimated by applying a multiplier to the AAM result. The multiplier was derived as the ratio of the LiDAR result to AAM result for the solar potential of Adelaide, being the city with building stock most similar to that of Perth.



Example of good agreement between the two input data sources for large buildings. Aerial image (Left), AAM 3D buildings with Insolation limit method (centre); LiDAR with Insolation limit method (Right)

The SunSPoT tool provides a 2.5 dimension PV rooftop assessment capability that is user intuitive at both an urban and building level scale. The tool was found to have a similar calculation output when compared against detailed PVSYST solar simulation software (Odeh and Nguyen, 2021). Its functionality extends beyond PV potential outputs and compliments a suite of Australian PV mapping and tracking tools (<https://pv-map.apvi.org.au>) developed by the APVI that has uplifted public awareness and helped incentivise solar power system uptake.

## References

Abdullah-Vetter, Z., Ramsden, C., Nair, S., Dehghanimadvar, M., Roberts, M. & Bruce, A. (2021) Powering a sporting nation: Rooftop solar potential of Australian soccer, AFL and cricket stadia. <https://apvi.org.au/powering-a-sporting-nation-rooftop-solar-potential-of-australian-soccer-afl-and-cricket-stadia>

Copper, J., Roberts, M., Barton, T., Hu, R. & Bruce, A. (2019) Spatial Analysis of Solar Potential in Perth. Australian PV Institute (APVI) <https://apvi.org.au/pv-potential-in-perth>

Gagnon, P., Margolis, R., Melius, J. Phillips, C. & Elmore, R. (2016) Rooftop Solar Photovoltaic Technical Potential in the United States: A Detailed Assessment. NREL/TP-6A20-65298 2016 <http://www.nrel.gov/docs/fy16osti/65298.pdf>.

Odeh, S. & Nguyen, T.H. (2021) Assessment Method to Identify the Potential of Rooftop PV Systems in the Residential Districts. *Energies* 2021, 14(14), 4240 <https://doi.org/10.3390/en14144240>

Roberts, M., Abdullah-Vetter, Z., Heywood, P., Bruce, A. & Egan, R. (2021) Solar Potential of Australian Social Housing Stock. Australian PV Institute (APVI) <https://apvi.org.au/solar-potential-of-australian-social-housing-stock>

Roberts, M., Heywood, P., Ramsden, C., Nair, Abdullah-Vetter, Z., McCoy, B., Nicholls, A., Caton, E., Copper, J. & Bruce, A. (2020) Sunny side up: how schools, prisons and libraries can power Queensland's renewable future. <https://apvi.org.au/sunny-side-up-how-schools-prisons-and-libraries-can-power-queenslands-renewable-future>

# West 5

S2e Technologies Inc.



## About the project

West5 (London, Ontario) is intended to become a net-zero energy community for all age groups. The main goal is to reduce the use of fossil fuels by reducing energy consumption of residential and commercial buildings and produce on-site renewable energy from solar technologies. The neighbourhood has a total area of 283 000 m<sup>2</sup> with a built area of 260 000 m<sup>2</sup>.

The main conceptualization of the West5 community is based on the goal meeting the total energy consumption demand of the community, through the integration of PV panels on optimally oriented roof areas. To meet this goal a set of tools was used to analyse the energy generation potential of the West5 design. Based on the

energy consumption and solar potential, the iterations of the initial design were analysed until the goal of net-zero energy is achieved.

With the evolution of the project and the detailed development of each building the analysis is becoming more complex involving the use of other tools.

## Key Performance Indicators in the project

The main indicators used in this project are PV energy generation and energy consumption to meet the Net-zero energy goal. However, material sustainability, daylighting, and indoor health are studied as part of the design of the community.

PV energy generation is measured considering the available PV surface and the energy generation potential of PV panels. The study integrates factors such as solar availability, snowfall, and technology efficiency.

Energy consumption is assessed as the total energy necessary in the community. Mainly, cooling and heating are assessed, influencing design components of buildings such as the envelope design and choice of mechanical systems. As part of the energy consumption, appliances and equipment are also studied to contemplate highly efficient technology.

The analysis of daylighting was slightly considered as an element in mind for the design. Although, daylighting was not a priority, it was contemplated investigating the daylighting factor of the different spaces, following the LEED program. This KPI contributes both to energy consumption by reducing the need for artificial lighting as well as to the wellbeing of the occupants.

Regarding the material sustainability, the indicators focusing on locality, recycled content (PVC), and renewable content. In this subject, instead of formal tools, the design relied on the experience of the team considering materiality one building at the time as opposed to the master plan level. On the other hand, the indoor health is assessed only indirectly. The design

of energy efficiency considered fresh air exchange, including air filtration. The design of air tightness was mindful of the health in indoor air. At the time, the analysis contemplated industry best practice and assumed appropriate filtration and rates of air exchange. Post-COVID, the expectation of this KPI will be largely considered.

# Tools in the project

## Output

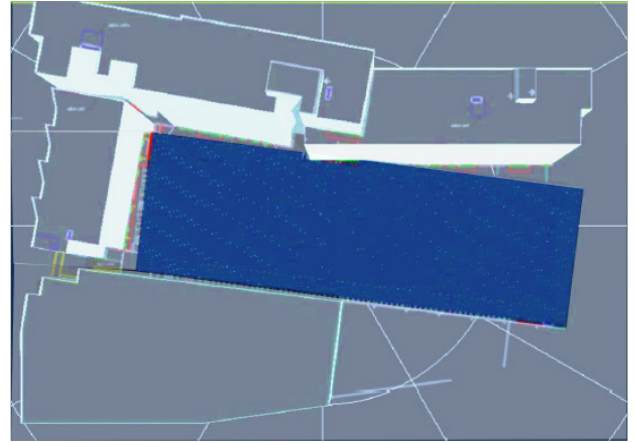
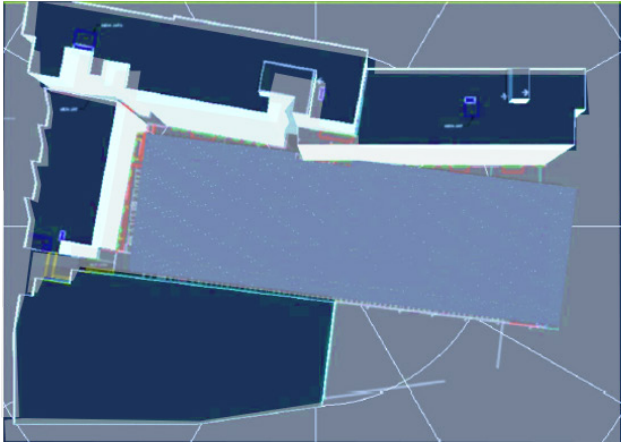

Distribution of PV on the roof of Building 23 (788 kWp) and parking (740 kWp). Source: s2e Technologies Inc.

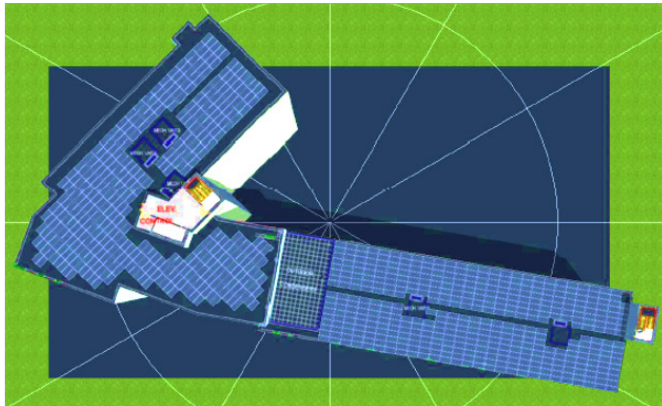

Distribution of PV on the roof of Building 19 (A) and south façade (B). Source: s2e Technologies Inc.

**December 21<sup>st</sup>, 10am**

**December 21<sup>st</sup>, 3pm**



**March 21<sup>st</sup>, 10am**

**March 21<sup>st</sup>, 3pm**



Shadow study for West5 building 19. Source: s2e Technologies Inc.

## Used tools

The initial stages of design considered several tools. Preliminary work initiated with the use of SketchUp, moving forward to REVIT for the Building Integrated Modelling. Home-baked excel spreadsheets were developed for initial calculations with regards to potential energy consumption and generation, as well as the main costs of the development and profit. Following to this, more detailed energy analysis made use of EnergyPlus and Hot2000, and performance of renewable technologies through PVSyst and HOMER. The overall workflow focused on achieving a solar optimized community made use of Euclid within SketchUp, EnergyPlus, and PVSyst. Figure 1 below represents the main tools used and the workflow to achieve a conceptual design based on the PV energy generation and energy consumption analysis. The integrated set of SketchUp and Euclid allowed the virtual modelling of the neighbourhood. With this 3D model representation of buildings, EnergyPlus software was

employed to input data such as internal loads, operation strategies and schedules, HVAC systems, weather data, and specific simulation parameters necessary to compute the energy requirements and potential energy generation. Further in the development of the project, PVSyst was introduced to perform more detailed calculations regarding PV energy generation. The approach for this specific component consisted on isolating the PV surfaces with its surrounding shadow-casting elements and simulate the energy production. The analysis of all data produced from the simulation and PV calculations takes place using excel sheet. This final tool is used to bring together all results obtained from previous stages of the workflow and the conclusions conform the decision-making process of the design. Finally, based on the output information re-design strategies are considered to improve the design to meet the NZE goal.

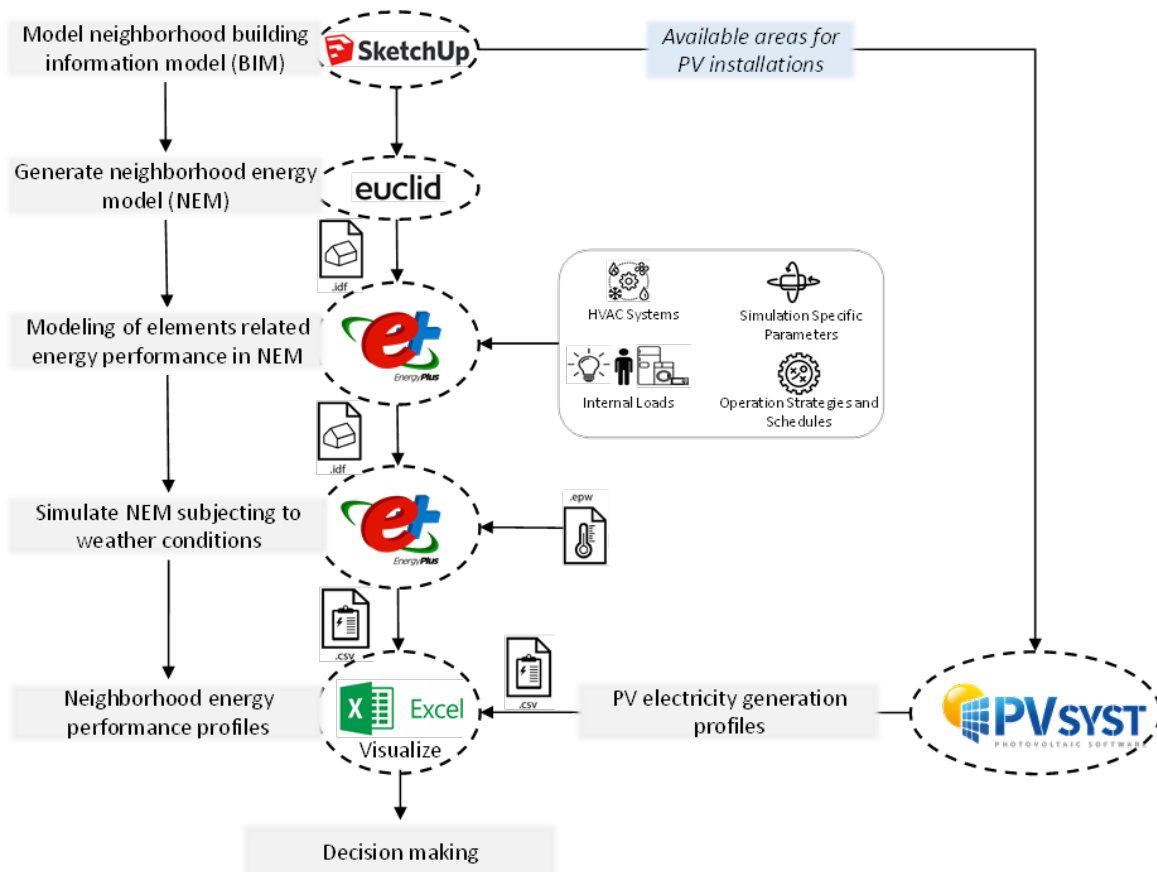

Conceptual design and energy analysis workflow

## Challenges / Lessons learnt

The main challenge observed throughout the development of the project is the ability to use various specialized energy tools. For instance, employing EnergyPlus to set-up a scenario and to simulate the design, is a challenging task which requires specific training. Nonetheless, the interface between SketchUp and EnergyPlus, Euclid reduces the gap between Architects and energy simulation. Furthermore, at the neighbourhood design scale, EnergyPlus can become more complex in terms of the modelling

and set-up. These large-scale analyses require additional training and the use of supplementary resources such as spreadsheets to aid calculations. Similarly, PVSyst tool requires specific training as it can only be used by trained people. Further, this tool has a low accessibility between the design model produced and the PV calculation engine.

Authors of this workflow story: Olivia Alarcon Herrera, Kuljeet Singh and Caroline Hachem-Vermette

# City Valley

2021 Delta Cup International Solar Building Design Competition

Yupeng Wang, Wenru Yue, Long Guo, Qiufeng Wang, Xiaoying Zheng

## About the project

The design process could be considered to be 6 steps for this project, which is located next to the city green belt in the redeveloped urban area in the east of Xi'an, China. This area was developed as the city's military-industrial center in the 1950s, and the site of this project was originally designed as the main residential area within the factory district. The purpose of this design project is to renew the residential block, and combine the TOD model and the urban green forest belt next to the plot to promote the residential block with a more comfortable thermal environment by evaluating the architectural layout and the wind conditions adapting the effects from the urban green belt.

The method conducts thermal environment and energy consumption tests, according to the existing environmental conditions as well as design options to assess the availability and potential of solar energy. In the description of the workflow story, attention will be paid to the interactive process of design and simulation.

## Methodology

### Step 1. – Urban Analysis

The first step of the method is to analyze the current situation of the site, including historical background and climate environment data, and prepare the preliminary

data for simulation and verification for the next step. The meteorological data of Xi'an throughout the year were obtained from Meteonorm.



Existing buildings and selected area in the existing situation (left), After design (right)



City layout and historical evolution map

## SUNLIGHT HOURS ANALYSIS

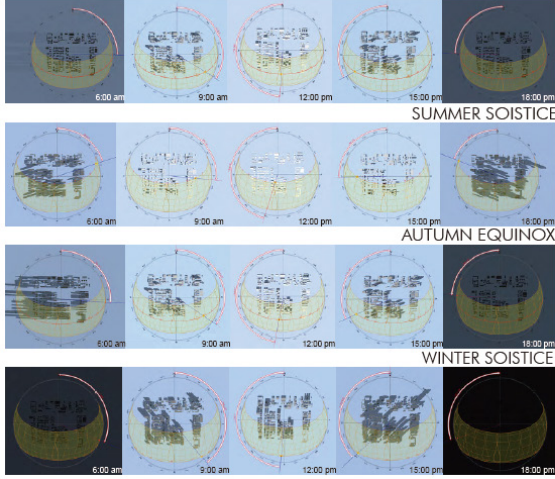

## WIND SIMULATION

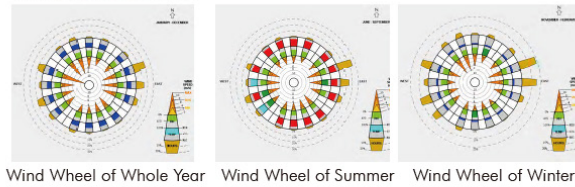

## TEMPERATURE ANALYSIS

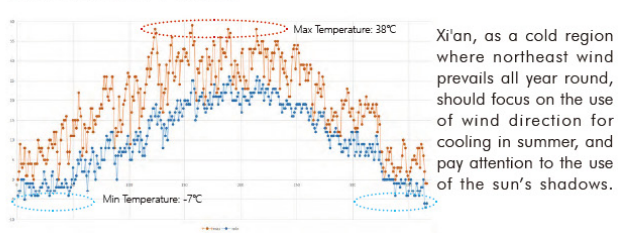

Base shadow analysis and climate conditions

### Step 2. – Climate Data Acquisition and Analysis

The second step is to carry out the field measurements of the air temperature and humidity condition inside and around the project site, use ENVI-met to carry out the preliminary pedestrian height air temperature and wind simulation. A wool-thread simulation is a grasshopper-based simulation algorithm that helps to optimize and

generate a network of paths with the shortest distances between points. In this design, the fitting of the wind route could be performed by the wool simulation in accordance with the ENVI-MET simulation results and the expected air outlet. And then adjust the planning and design according to the condition of wind direction.

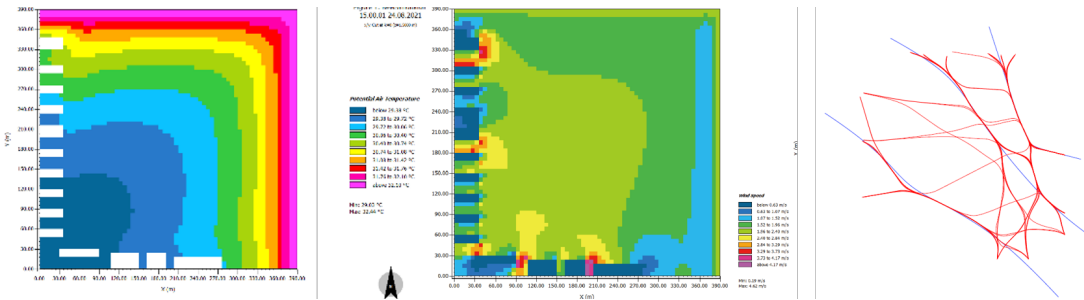

Simulation of site temperature and wind situation by ENVI-met (a) (b), and Wool-thread Simulation by Grasshopper (c)

### Step 3. – Design Based on Environmental Analysis

The buildings in the site are arranged according to the wool-thread algorithm in grasshopper and ENVI-met. Especially for large-scale commercial buildings in the

upwind direction, ventilation corridors need to be opened according to the simulation results, to promote the wind environment of the downwind site.

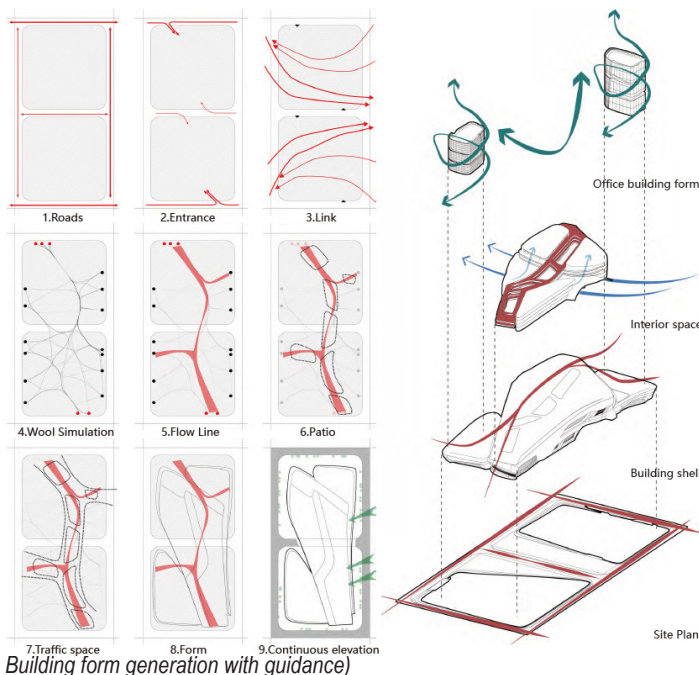



### Step 4. – Add Energy-Saving Technologies

In order to further convert solar energy, known as the usable energy in the community, energy-saving design methods were added to the design. For example, adding

rooftop agriculture on the roof corridor, using buildings to convert carbon dioxide in the air, rainwater recycling, solar panels and other facilities that could help to save energy and avoid resource waste.

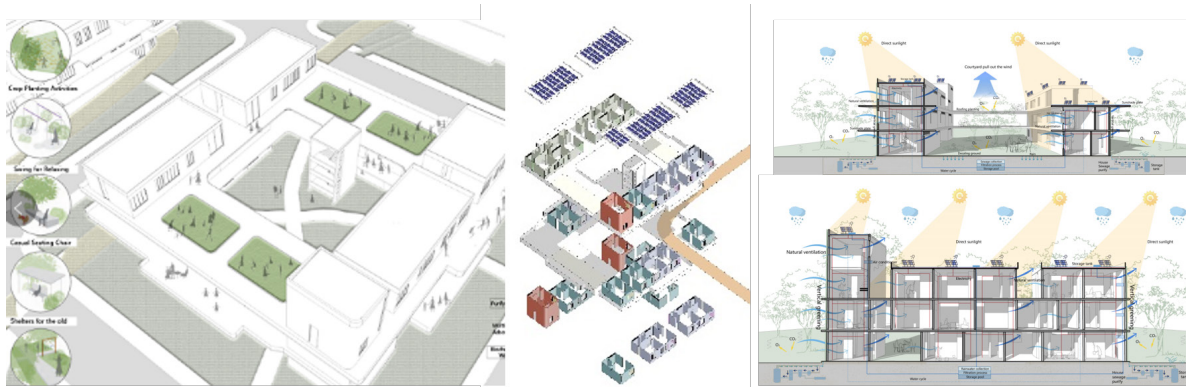

Energy saving methods in residential buildings

### Step 5. – Simulation of Site Thermal Environment and Building Energy Consumption

Energy-Plus was used for building energy simulation. The models of residential and commercial buildings were built in the SketchUp plugin Best Energy environment, and layer the wall, roof, and floor materials of a single

building. The pre-set spatial characteristics and the city's wind and heat environment were used to simulate the building energy consumption of different buildings in winter and summer. Besides, the ENVI-met simulation were carried out for evaluating after-designed model to compare the environmental changings

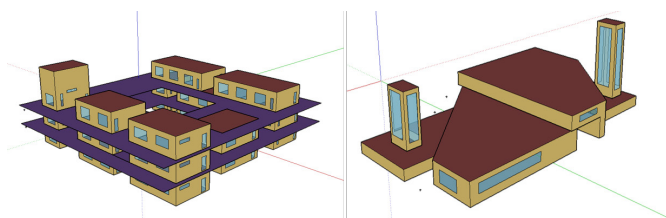

Modules in Energy-Plus (a)(b) and simulation result (c)

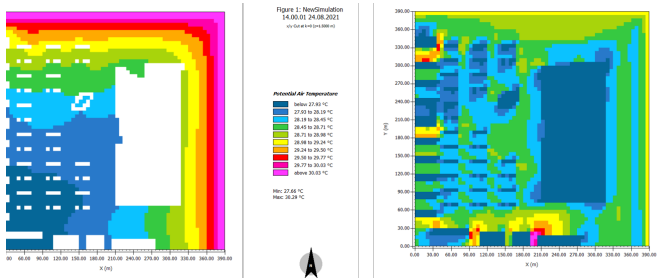
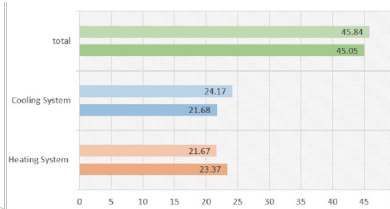

Simulation of project temperature and wind situation by ENVI-met

### Step 6. –Carbon Emission and Energy Consumption Balance Calculation

The final step is to evaluate if the designed block can achieve the zero carbon goal within the 70-year declaration cycle. The heating and cooling energy of the building were calculated using the simulation, and the additional values such as the carbon consumption

of solar panels, and the total energy consumption were calculated in this part. In terms of absorbing solar energy and carbon dioxide, the solar energy that can be fixed by solar panels, the water energy saved by rainwater recycling and the carbon sequestration by planting photosynthesis in the site were calculated.

Energy consumption for building operation(MJ/year)		Energy production of PV panel	
Heating(MJ/year)	2579601.844	area(m <sup>2</sup> )	1579.5
Cooling(MJ/year)	1127547.136	energy(MJ/year)	1247805
<b>total(MJ/year)</b>	<b>3707148.98</b>		
<b>70 years(MJ)</b>	<b>259500428.6</b>	<b>70 years(MJ)</b>	<b>87346350</b>
Energy consumption for water requirements		Energy production of water tank	
water requirements(kg/year)	730000	water production(kg/year)	568986.26kg
conversion to energy(MJ/year)	146000	conversion to energy(MJ/year)	113797.25
<b>70 years(MJ)</b>	<b>10220000</b>	<b>70 years(MJ)</b>	<b>7965807.5</b>
		Energy production of trees	
		Arbors carbon fixation value(kg/tree)	18
		numbers of trees	
		<b>70 years(kg)</b>	<b>1260</b>
		Energy production of shrubs	
		Arbors carbon fixation value(kg/tree)	9
		<b>70 years(kg)</b>	<b>1260</b>

Part of the calculation table

## Used tools

Several software were used in different design and verification stages. Sun Path 3D and Shadow Plugin for shadow analysis, Meeonorm, Excel for data processing, collection, calculation and visualisation, AutoCAD, SketchUp and Rhino for urban design and individual building design, ENVI-met, Kangaroo2 and Energy-Plus for wind path and energy consumption simulations.

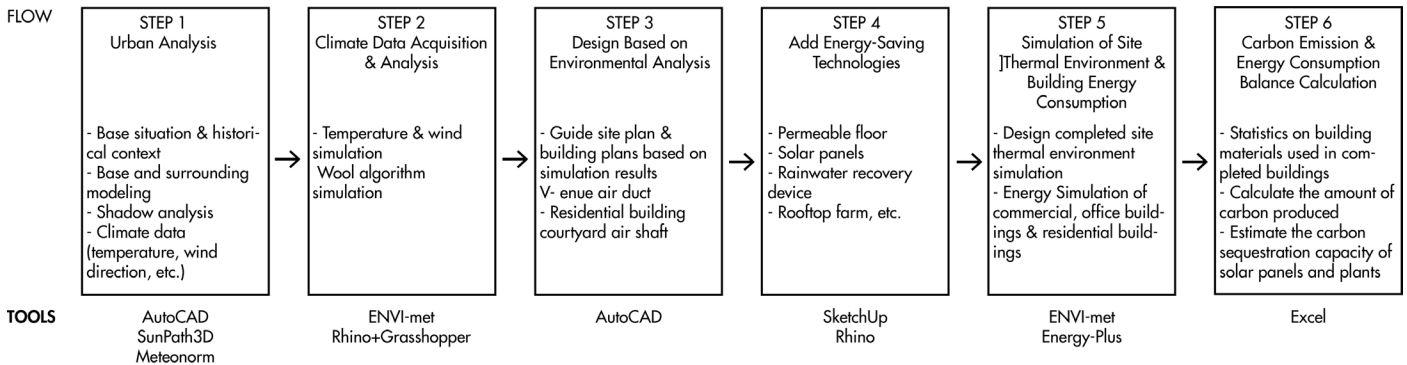

## Challenges / Lessons learnt

When doing the overall management in the early stage, it is better to arrange the software needs to be used, and explore whether the different software can be related. In this design project, if the outdoor thermal environment verified by the ENVI-met can be used in the Energy-Plus simulation, the embodied energy simulation results could be more accurate.

In this design, the overall climate data of Xi'an were used as the premise for simulation and verification, and the actual measurement of one day in summer were used for verification. But it could be more accurate if there are small-scales measurement data as the premise for simulation verification.

Each software has its own characteristics. We believe that scholars will make use of the advantages of each software for further exploration.

# Fælledby

Henning Larsen

Henning  
Larsen —

## About the project

Just beyond the Copenhagen city center, Fælledby transforms the former junkyard site into a model for sustainable living, balancing human priorities with a strong commitment to the natural surroundings. Fælledby explores a living model with nature at its core, simultaneously crafting a new neighborhood to accommodate the demands of the growing city and increasing local biodiversity. The neighborhood merges traditional Danish urban and rural typologies to create a hybrid that balances the city and its natural surroundings. Fælledby will develop in phases,

growing outward from three distinct “cores” that together frame the neighborhood at large. This diffuse approach will maximize access to nature for residents and will allow the landscape to be organically integrated in the site.

## Key Performance Indicators in the project

The goal in this project was to optimize the Key Performances solar access, view and daylight access to optimize the form and density in the neighbourhood.

## Tools in the project

### Output

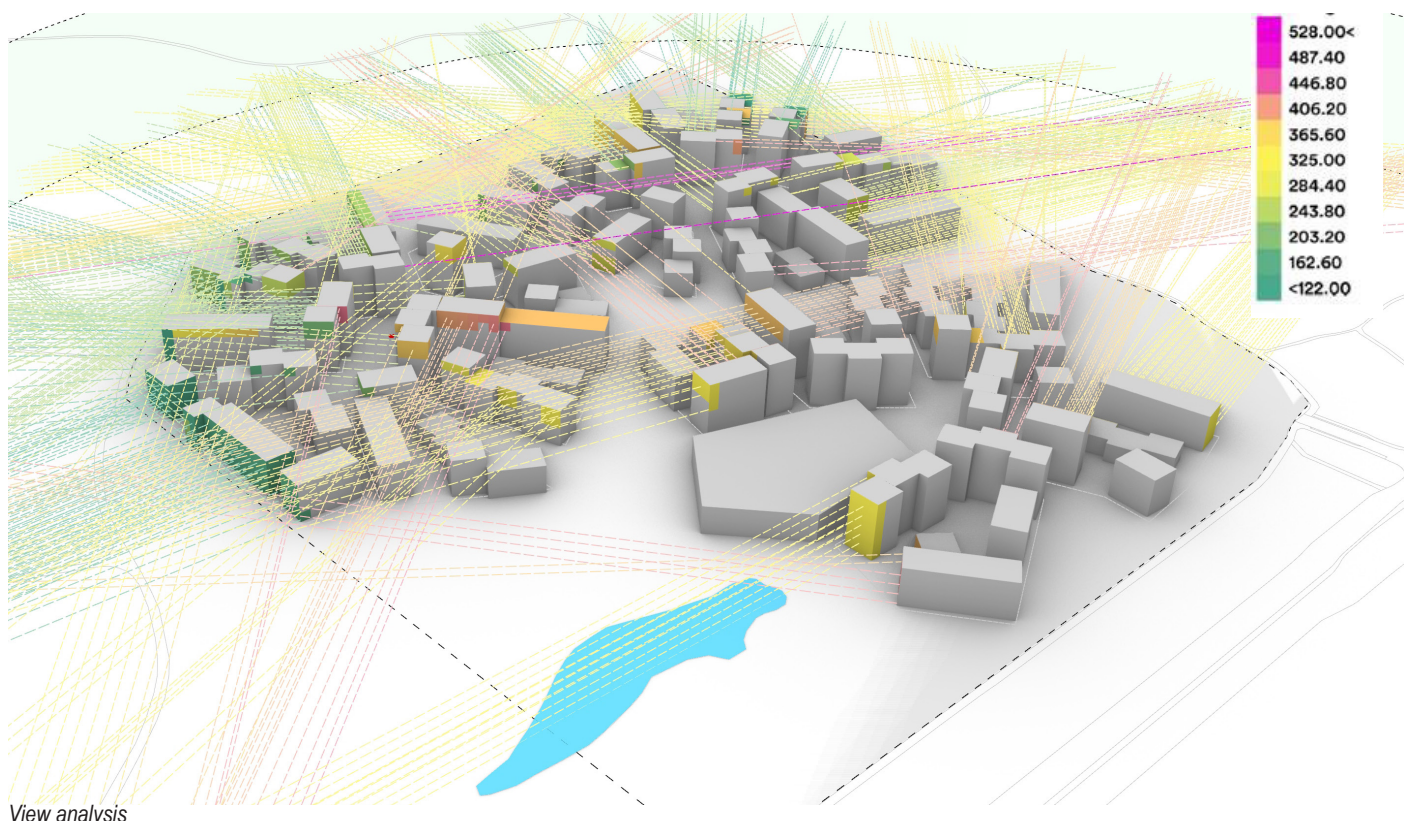

View analysis

The daylight access was in this project studied as the amount of solar hours on facades at equinox (~March 20 & September 23). In other projects, the architects have used the Vertical Daylight Factor.

The view analysis in this project was conceived as the distance to nature (m).

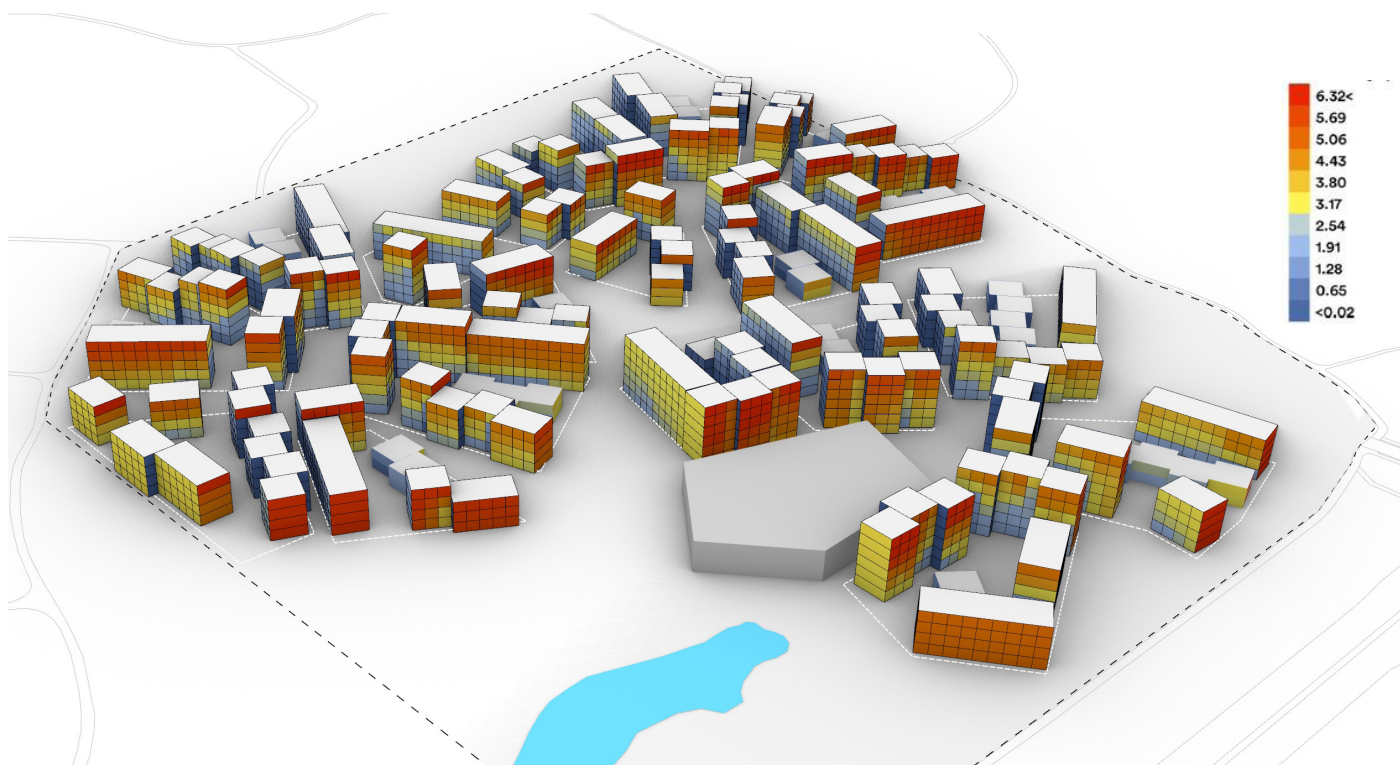

Daylight analysis

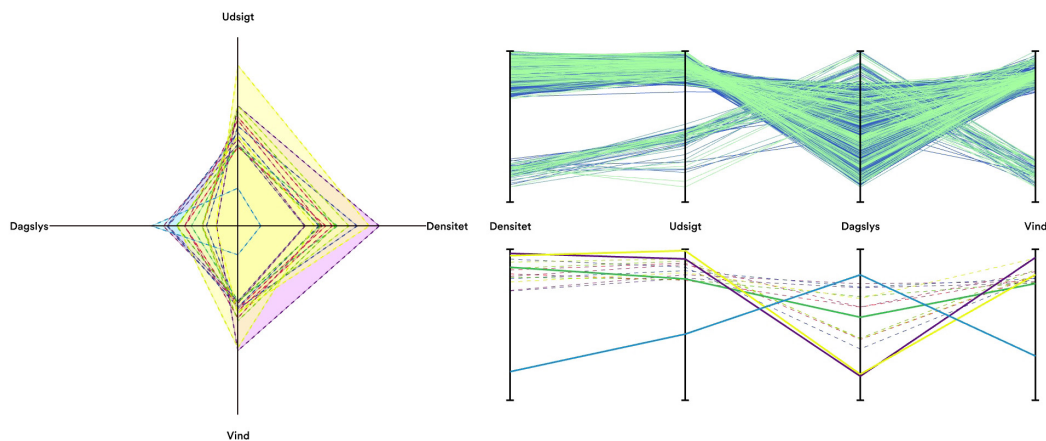

Multi-criteria analysis regarding view, daylight, wind and density

## Used tools

All analyses were performed with Rhino/Grasshopper, to enable a close connection with the architects' workflow. Within Grasshopper, both third-party tools and in-house tools were used, while the Grasshopper plugin "Octopus" was used for the evolutionary multi-objective optimization. The view, wind and sunlight studies are C# scripts developed in house, which increases the simulation speed with approximately 10x compared to most third party python plugins.

Authors of this workflow story: Jouri Kanters

# Leroy-Merlin

Cythelia Energy



## About the project

The Archelios software suite is dedicated to the development of photovoltaic projects, from prospecting to operation, including solar energy calculations, glare studies and normative calculations. A 3D model is generated once and is used by all the tools of the software suite.

This was used extensively for the design of the 500 kWp photovoltaic shading project at Leroy-Merlin in Clermont-Ferrand: Archelios Map, Archelios Ray, Archelios Pro, Archelios Calc and Archelios O&M were used for this project.

## Key Performance Indicators in the project

The objective of the project was to find the best compromise between the aesthetics of the shades and the payback period.

## Tools in the project

### Used tools

Overview of the the software suite:



Today, 91% of the population and 76% of the French territory are covered by the Archelios Map tool. This tool take the form of a solar cadastre that provide informations on the solar energy received on the roofs. Leroy-Merlin is a chain of nearly 150 stores in France. For this project, an analysis of all the group's stores was carried out.

The estimation of the photovoltaic potential of the group's buildings and parking lots allowed us to identify the most favorable sites for a self-consumption photovoltaic installation, including the one in Clermont-Ferrand



PV potential of the Leroy-Merlin buildings across France

As the Clermont store is less than 3 km from an airport, a glare study was carried out to eliminate the risk of glare

for pilots during the approach phase.

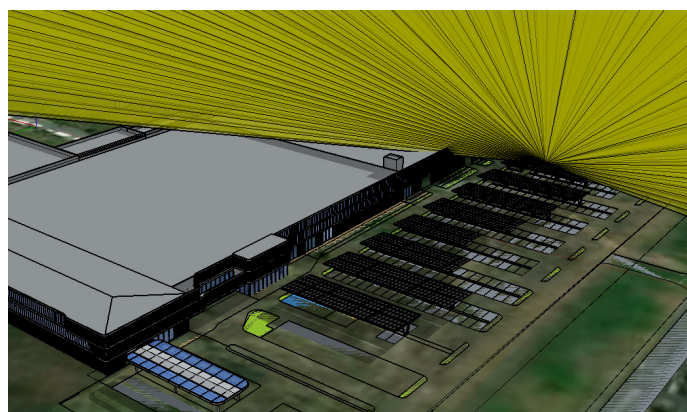

Glare analysis

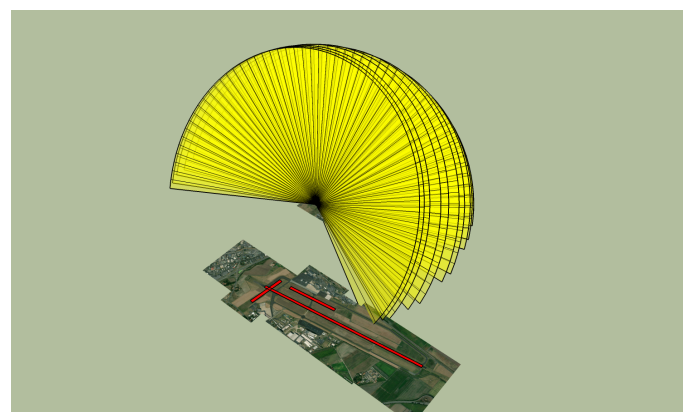

More detailed economic calculations were carried out with Archelios Pro, considering self-consumption from load curves estimated in 10 minutes point. The normative calculations - sizing of cables, protections,

etc. - and the calculation notes and single-line diagrams were made with Archelios calc.

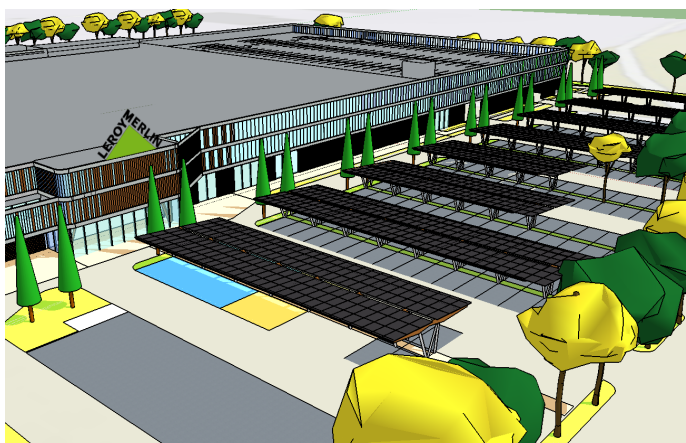

PV system setup



Throughout the life of the installation, its performance will be checked in real time by the Archelios O&M tool. Alarms will be sent in case of a defect detected on the installation and regular reports will be generated automatically

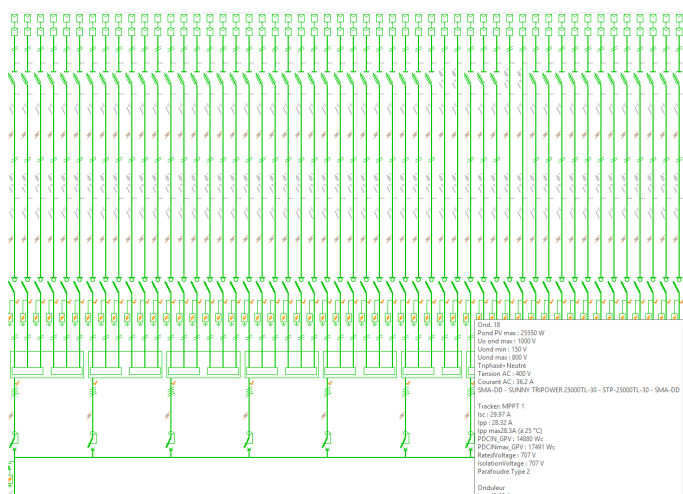

Cabling setup

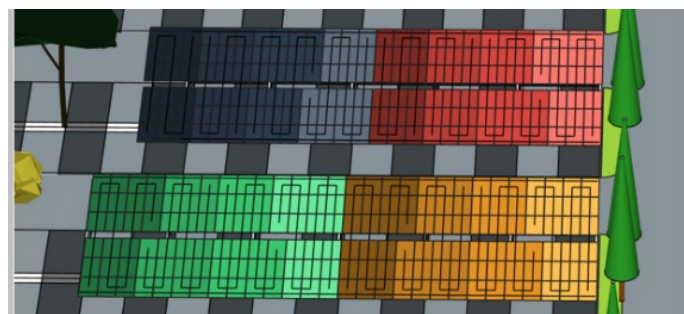

## Challenges / Lessons learnt

There is a need to optimize the tools for the treatment of very heavy files (e.g. ifc, sketchup).

# Lake Zilang

OTEIS



## About the project

In the second phase of the urbanization of the new Nantong center, a series of buildings are planned around Lake Zilang (Nantong, China) to house research institutes and company headquarters for technical innovations. This project of high environmental quality attempts both to stimulate the new district, in continuity with the public buildings in the north, and also to harmonize with the landscaped lake. Specific studies on the energy and

landscape systems and on the local architectural aspects make the project balanced and rich in innovations. In that context, Oteis was in charge with the solar part of the project.



*Conceptual design and energy analysis workflow*



# Key Performance Indicators in the project

The following KPIs were driving the project:

	Specifications/Results	Set by	Phase
I Photovoltaic energy production	>25% of electricity coverage 11.5MWp installed 13 GWh/yr production	Project requirement Legislation	Early planning phase
II. Access to the sun on facade	More than 2/3 of façades having more than 2h of sun the 21st of December	Project requirement Legislation	Early planning phase
III. Outdoor comfort	Universal Thermal Climate Index (UTCI) in the range [9-26]	International Index	Early planning phase
IV. Compactness	High compactness ratio provide better access to daylight	-	Early planning phase
V. Other performance indicators: View on the lake, Air Quality, Energy Recovery		-	Early planning phase

## Tools in the project

### Output

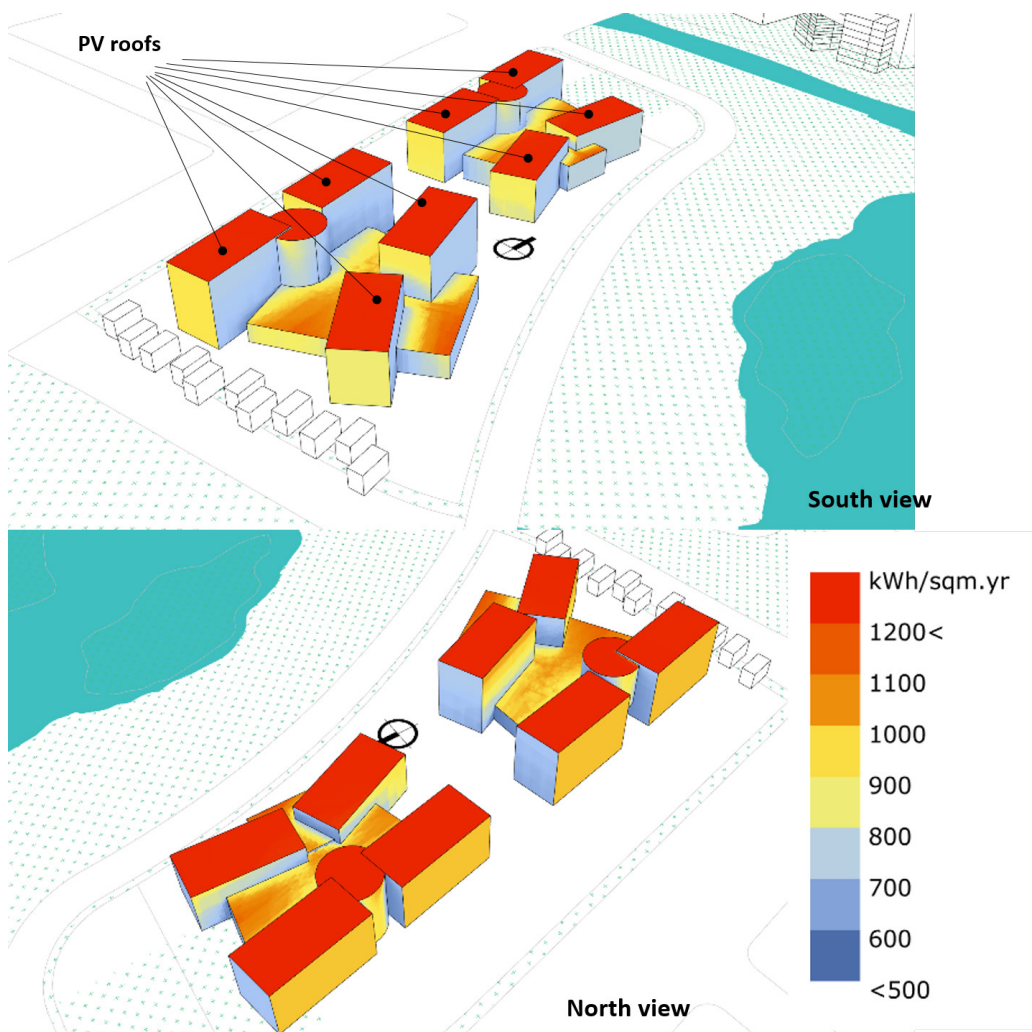

Photovoltaic energy production potential

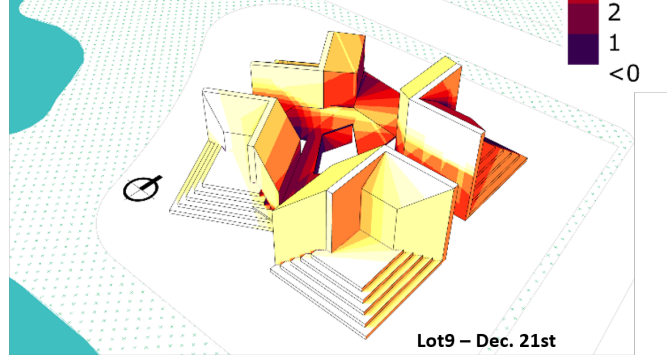
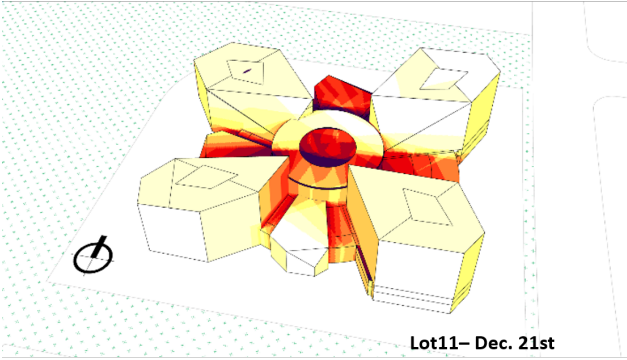
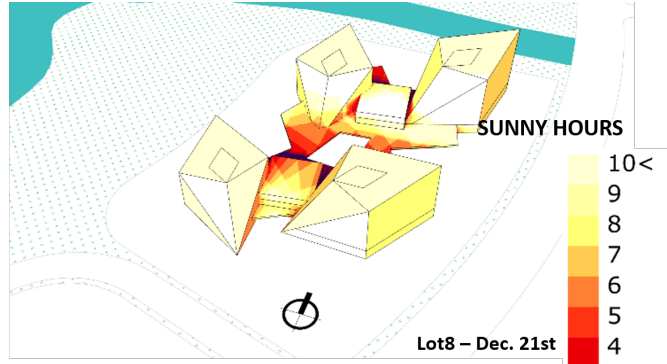
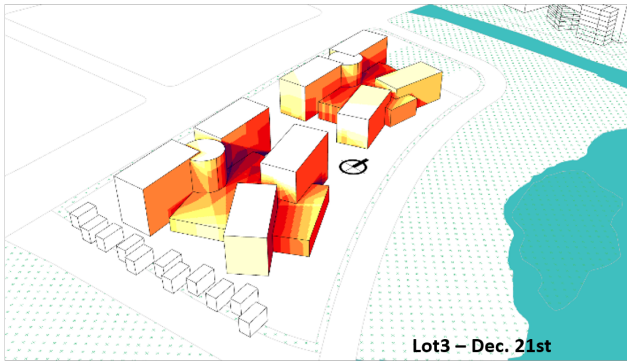

Access to direct sun on facade

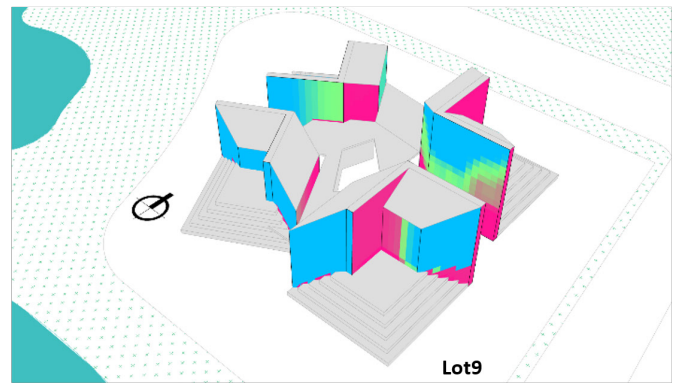
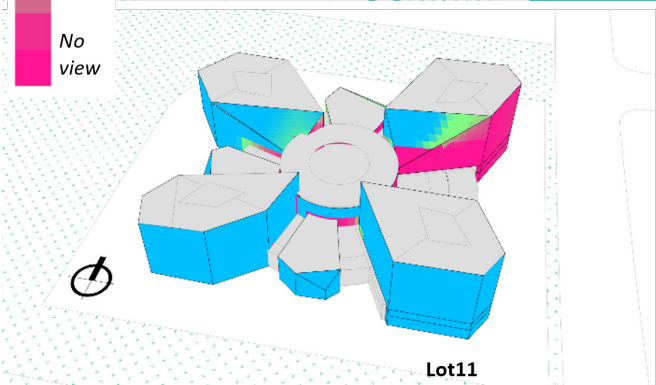
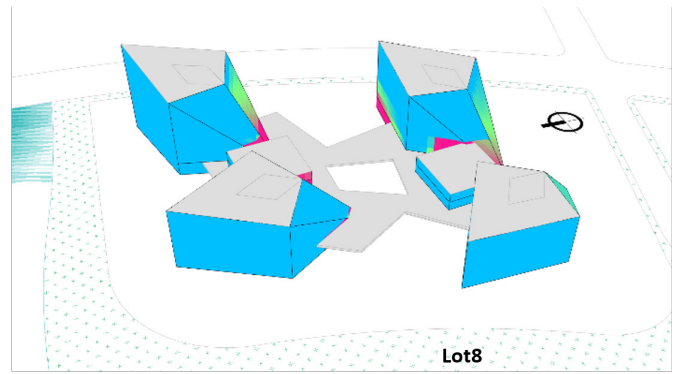
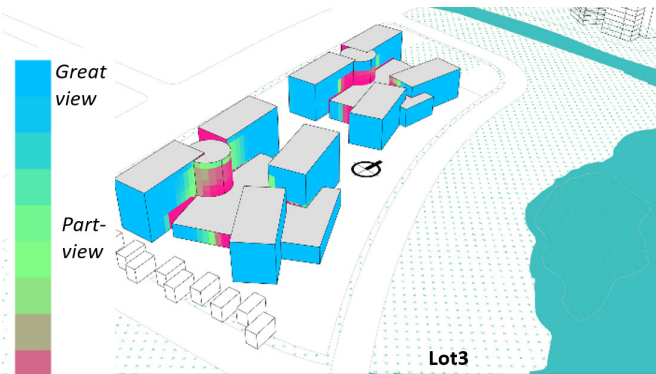

View on the lake

## Used tools

A combination of Rhino and Grasshopper were used to perform the analyses.

Authors of this workflow story: Martin Thebault

# Solar sculpting

Rafaella Belmonte Monteiro



## About the project

The energy performance of a building is strongly influenced by its level of solar exposure, which is affected by the climate, built context, and building morphological characteristics. Since these are typically fixed at the early-design phase, the aim of this research is to find if typologies do present fundamental energy related characteristics that makes the building massing a determining factor influencing building performance.

The research studies three building typologies: towers, courtyards and bars and compares them in terms of three performance indicators: energy demand, daylighting conditions and solar potential – ranked equally - trying to understand not only if there is an impact but also which typology or building dimensions shows to be the most beneficial. The study starts with a broad evaluation of 312 case studies, considering the three typologies, with more general metrics and some assumptions to form a fair comparison and understand the overall performance. After that, at the second stage, a smaller pool of cases is selected and goes through a much more refined analysis, making it possible to reach one synthetic indicator that permits to rank and identify the best performing cases. Those cases are called “Champions”. Finally, at the third stage, the question of how much could still be improved was raised, and in fact more than that, which typology

would have the higher potential for further optimisations of the envelope.

As this study is a collaboration between Politecnico di Milano and Pratt Institute, following a wider research program that continually grows and counts with the work of undergraduate students as well as other master thesis students, to keep in line with the research, the simulations are performed with the weather data file from New York – USA. The program is residential and, to make sure it is up to date with society’s evolution, it counts with a schedule adapted to the new housing trends after the COVID-19 pandemic, with people spending more time at their homes and making use of that space not only for family life but also for work and daily activities.

As a method, it is important to highlight that the comparison is safe due to the assumptions being applied equally to all the cases. For instance, all the cases have the same Floor Area Ratio (FAR = 3), same envelope thermal features and same Window-to-Wall Ratio (WWR = 0,3 – compatible with residential buildings). The plot is also the same, considering a squared space of 100x100 meters, that is divided into a 5x5 meter grid and 15 meters as minimum spacing between buildings.

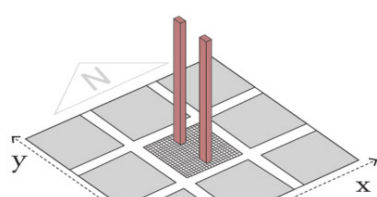

TOWERS

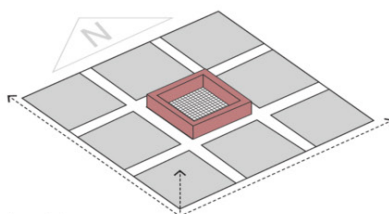

COURTYARDS

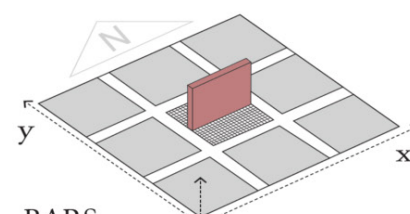

BARS

*Representative sketch of the three typologies studied*

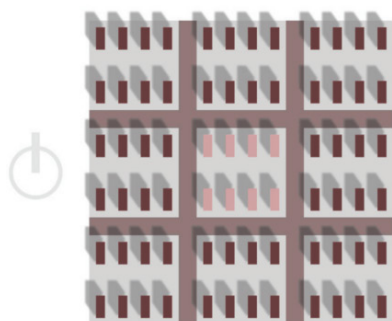

TOWER TYPOLOGY

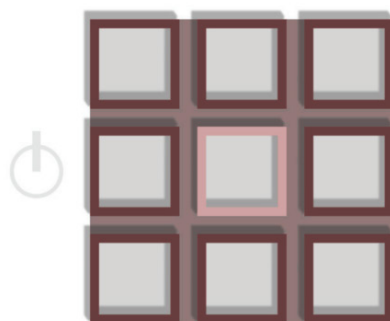

COURTYARD TYPOLOGY

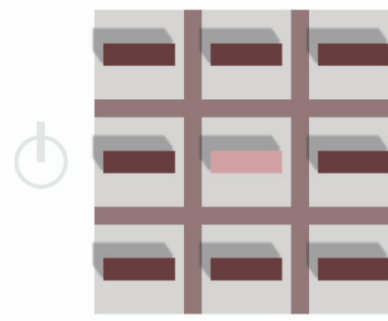

BAR TYPOLOGY

*Representative sketch with the building typology inserted in its urban context*

# Key Performance Indicators in the project

Three performance indicators are at the centre of the research: energy demand (for heating, cooling, artificial lighting, appliances, etc), daylighting conditions, and solar potential (ability of an envelope to receive solar radiation and therefore present a potential to produce solar energy, either from photovoltaic or solar thermal systems). They were selected because of the latent need to match the aspects that mainly influence substantially of the design output, and because of the understanding that they are equally important and complementary for a building performance success.

Moreover, along with the results, other indicators can be extracted to understand the form relationship with the performance output, such as the aspect ratio (building number on the plot), plan floor depth, building height, amount of roof area, etc.

## Tools in the project

### Output

The entire process was based in Rhinoceros + Grasshopper environment. Firstly, the parameters to develop the building mass in study were set and applied to a complete parametrized modelling approach, respecting the constant FAR and for that adjusting the number of floors for each case and its plan floor dimension.

The geometries were then input in three different simulations, using Ladybug, Honeybee and DIVA plugins: solar radiation, energy demand, and daylight (Daylight Factor) and Spatial Daylight Autonomy). Some of the outputs can be seen in the following figures.

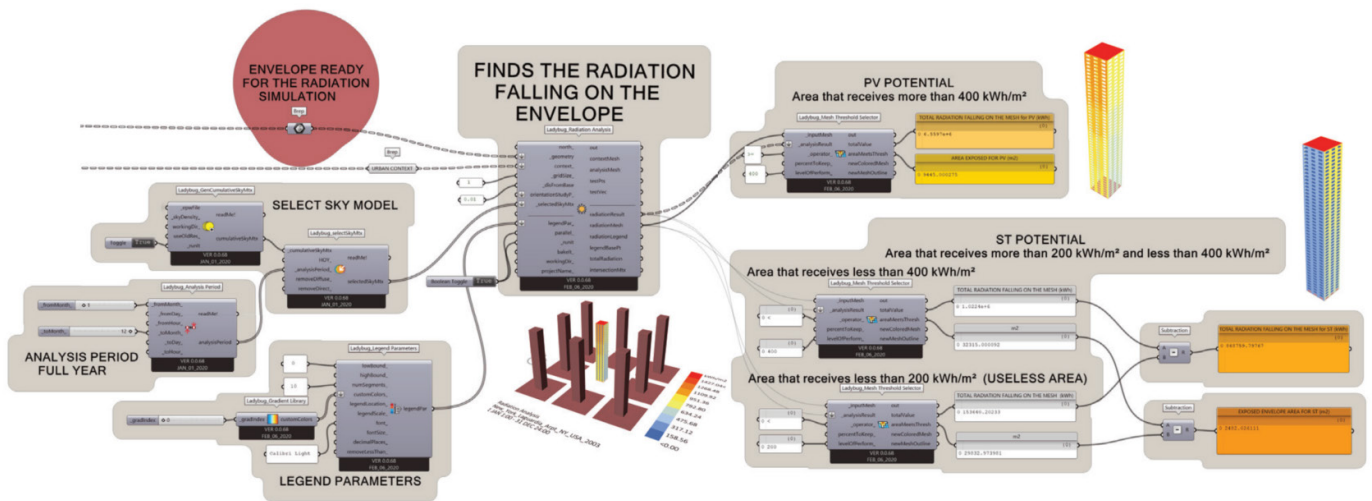

Example of one type of simulation using Ladybug and Honeybee: Solar Radiation and one of the outputs

### AVERAGE GROUND FLOOR DAYLIGHT FACTOR STUDY FOR REGULATIONS AND CONSTRUCTION FEASIBILITY

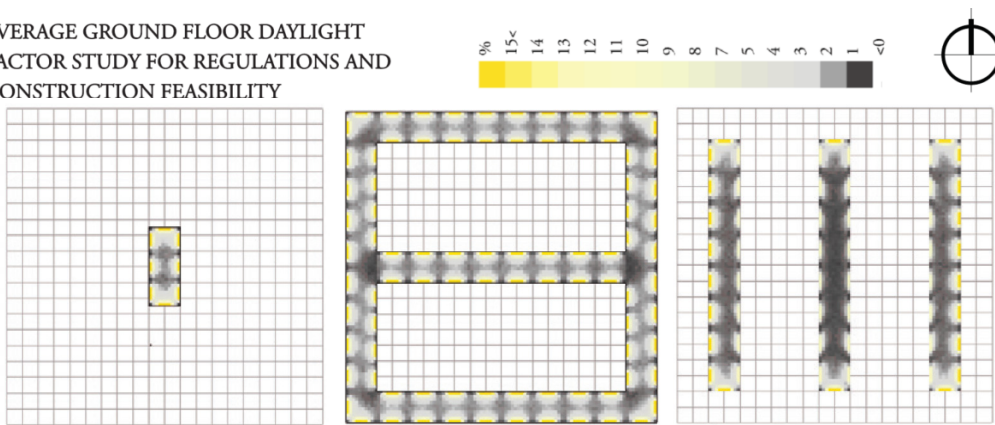

**TOWER 1x1** 10x25m  
ground floor DF: 5,22%  
avgDF: 4,84%  
sDA: 100% ASE: 56,2%

**CTYARD - EW - 1 DIV**  
depth 10m  
ground floor DF: 3,71%  
avgDF: 2,98%  
sDA: 66,2% ASE: 27,1%

**BAR - NS - 3** 15x80m  
ground floor DF: 2,60%  
avgDF: 2,38%  
sDA: 54,8% ASE: 27,0%

Example of one type of simulation using Ladybug and Honeybee: Daylight Factor

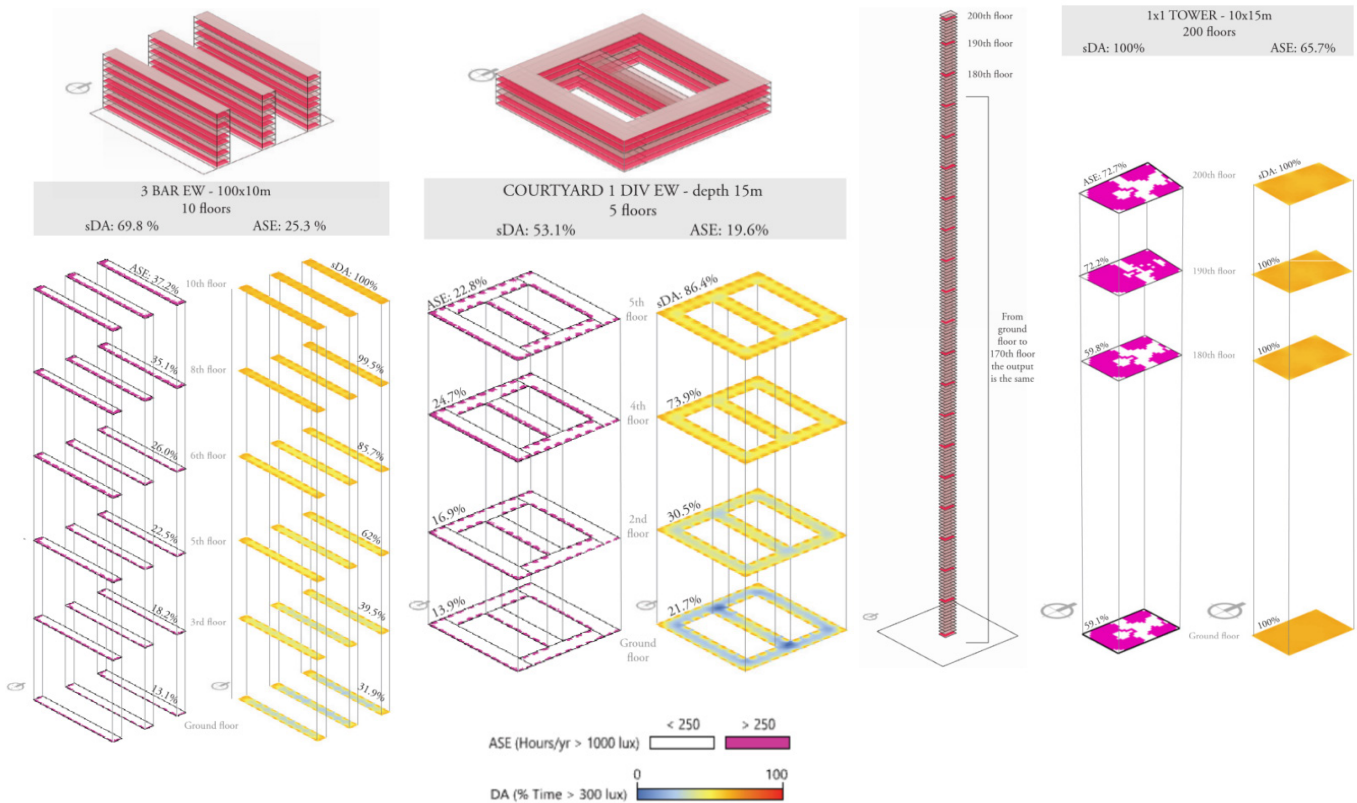

Example of one type of simulation using DIVA (Solemma): Spatial Daylight Autonomy

These software were important in the decision-making progress because once it is possible to simulate the three climate scenarios for energy use, energy production and daylighting conditions, it is possible to post-process

the outputs and offset one from another, which made possible to reach one final synthetic indicator to evaluate a building performance and understand the cases that stood out.

**BAR x COURTYARD x TOWER [FAR=3]**

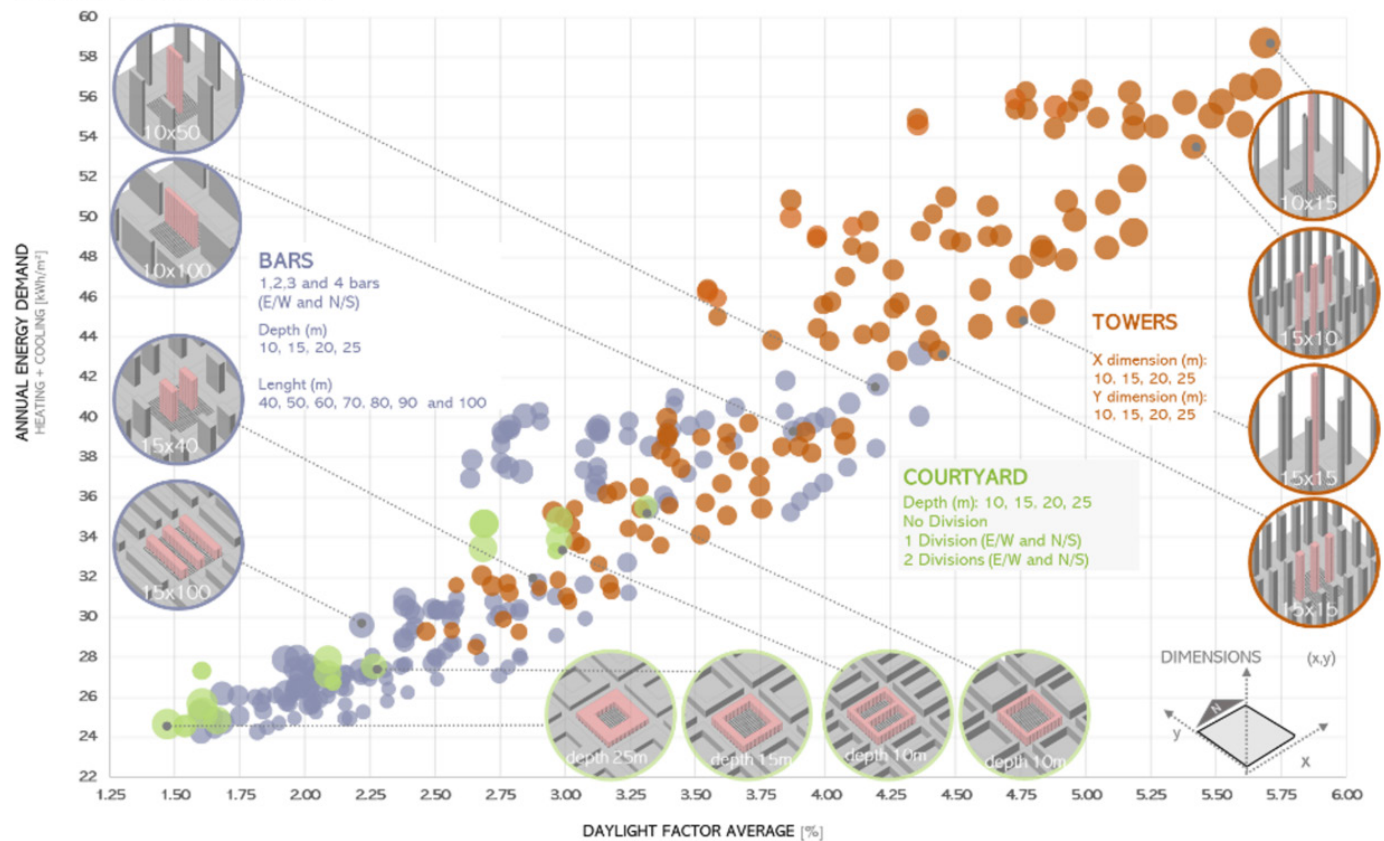

Annual Energy Demand versus Daylight Factor Average

## Used tools

Rhinoceros, Grasshopper, Ladybug, Honeybee and DIVA are software that perfectly interact with one another, and with the help of Excel to process the data, the workflow becomes pretty simple and straightforward. This interaction between outputs had to be carefully assessed and some assumptions on systems and machines had to be taken to permit a reasonable offset from energy demand

and production. Daylighting was considered in the energy use calculation when it was possible to use climate-based metrics to truly extract the artificial lighting requirement from each case, leaving only the appliances requirement as a function of the number of people and schedule. This interaction and process can be seen in the following Figure.

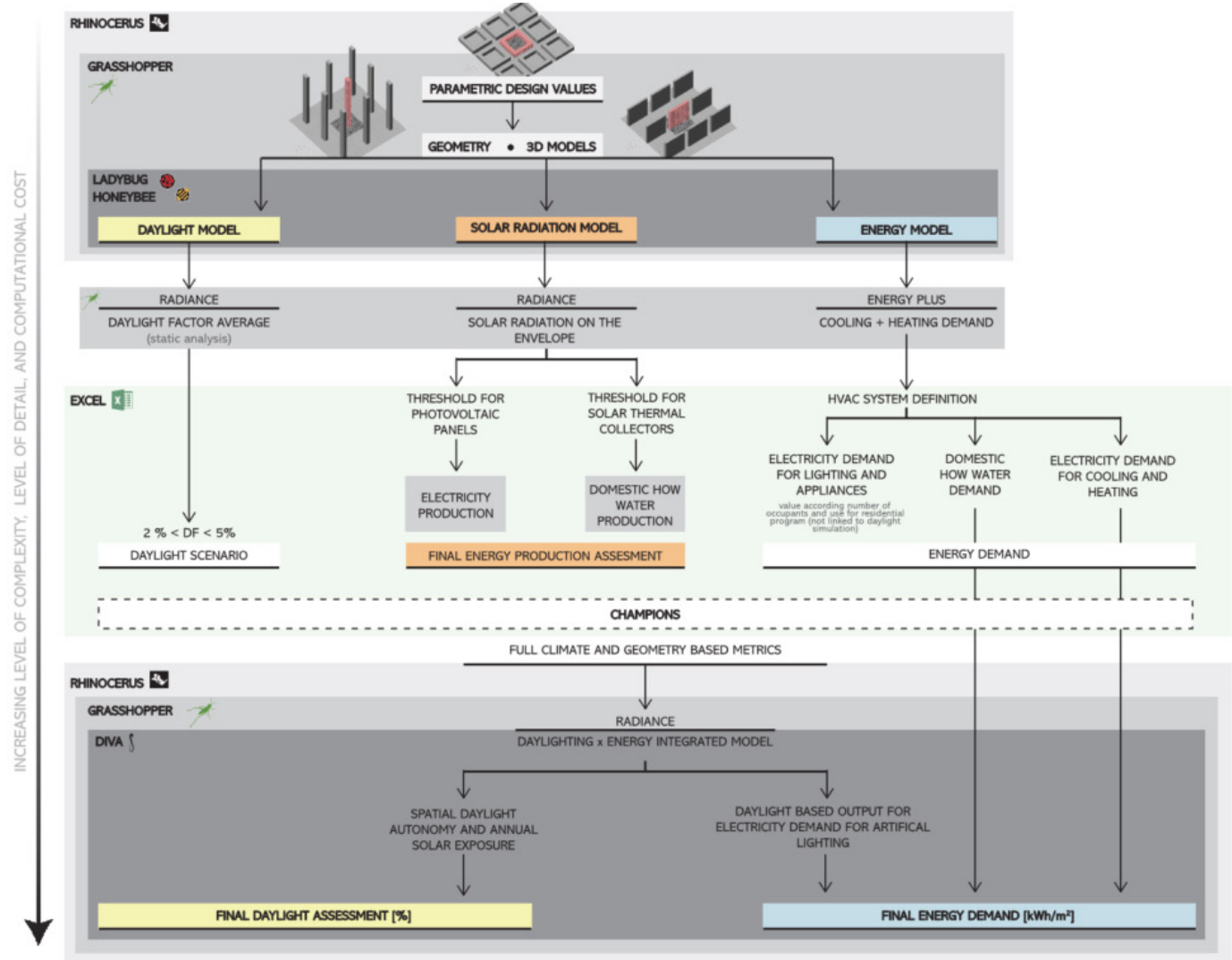

Research workflow - software and outputs

Another tool worth mentioning is the Grasshopper plugin Colibri (CORE) that allows for the quick gathering of data as well as the interface between Grasshopper and Excel. It made possible to combine a high number of simulated

cases in an automatic procedure, without the requirement for the manual simulation of each building setting.

## Challenges / Lessons learnt

First conclusion is that the interaction between the plugins works very well and it is already widely validated. It can be quite time-consuming as the simulations become more refined and/or the square footage is considerable. The outputs of the simulations and post processing the data are several charts that illustrate the building performance and make it possible to perform a fair comparison in a visual and synthetic framework.

*Authors of this workflow story: Rafaella Belmonte Monteiro*

# Bryggerikvartalet E.C. Dahls AS

Rambøll Norge AS

RAMBOLL

## About the project

Rambøll was chosen as an external consultant to evaluate four architectural proposals for E.C. Dahls Bryggerikvartalet (Trondheim). Among the analyses carried out to evaluate the proposals, three are directly related to daylight and solar radiation.



Overview of the project

# Key Performance Indicators in the project

The objective of the analyses was to figure out which of the four proposals had dealt in a better way with the four different parameters analysed. Namely: viewpoint prefer-

ence, sunlight hours, overshadowing solar radiation and preliminary acoustics.

		Specifications	Set by	Legislation / voluntary	Phase
I	At least 50 % solar access of inner court yards	21st Mars (12:00, 15:00 & 18:00), 22nd April (12:00, 15:00, 18:00), 23rd June (18:00 & 20:00).	Municipality	Legislation	Early planning phase
II	Maximizing the number of hours with direct sunlight for % of the surface areas	21st of March and 21st of September (equinox)	Municipality	Voluntary	Early planning phase
III	Solar radiation in kWh/m2 façade and building surfaces	Annual simulation	Municipality	Voluntary	Early planning phase

## Tools in the project

### Output

DXF 3D models were facilitated by the architects. The Rhinoceros geometry were modelled based on these DXF models.

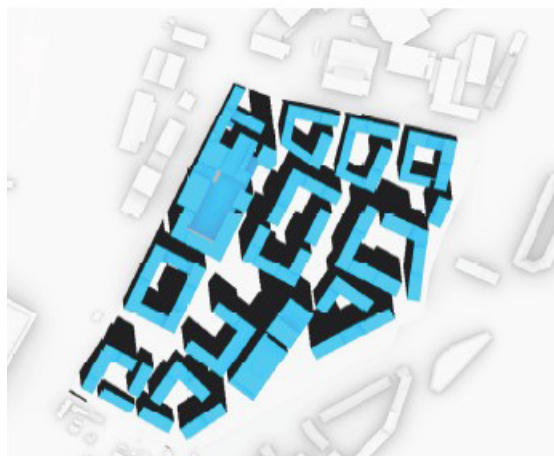

21. mars 1200 hrs



21. mars 1500 hrs



22 april 1500 hrs



22 april 1800 hrs

Solar access analysis





21. mars 1800 hrs

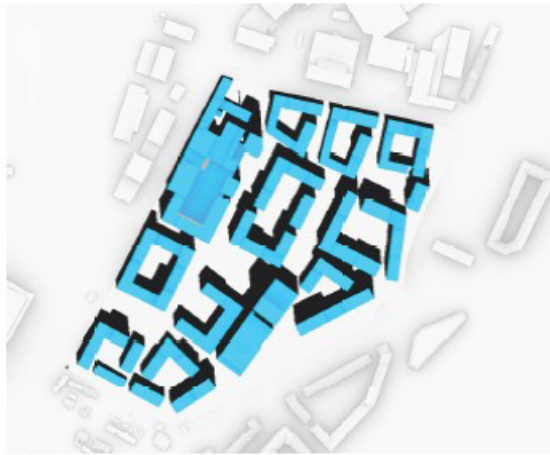

22 april 1200 hrs

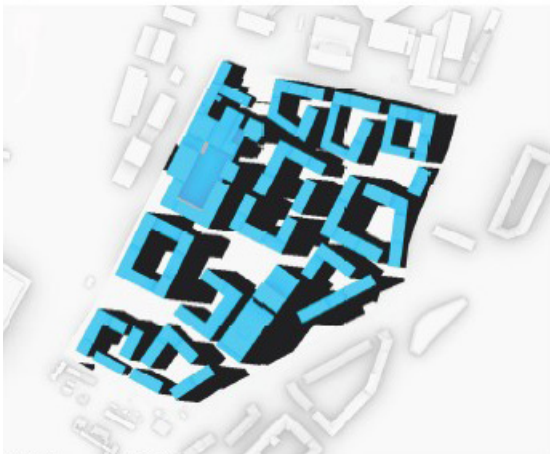

23. june 1800 hrs

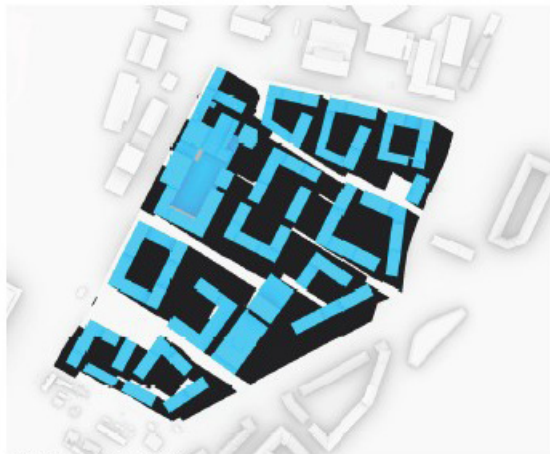

23. june 2000 hrs

Solar access analysis

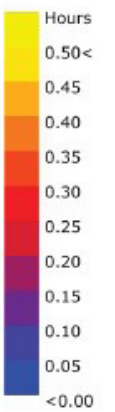

**Morning**

Direct sunlight access analysis: morning



**View from the south**  
Annual irradiation analysis

## Used tools

The tools used for the analyses were the Grasshopper plugins Honeybee and Ladybug, both are open source tools developed to use in combination with Rhinoceros.

Performance indicators	Weather data	Tool / engine used	Interface	Sky
I	Solar vectors 21st Mars, 22nd April, 23rd June, latitude specific	Ladybug	Ladybug	n/a
II	Solar vectors 21st March, latitude specific	Ladybug	Ladybug	n/a
III	Trondheim EPW Data	Radiance	Honeybee	Cumulative sky

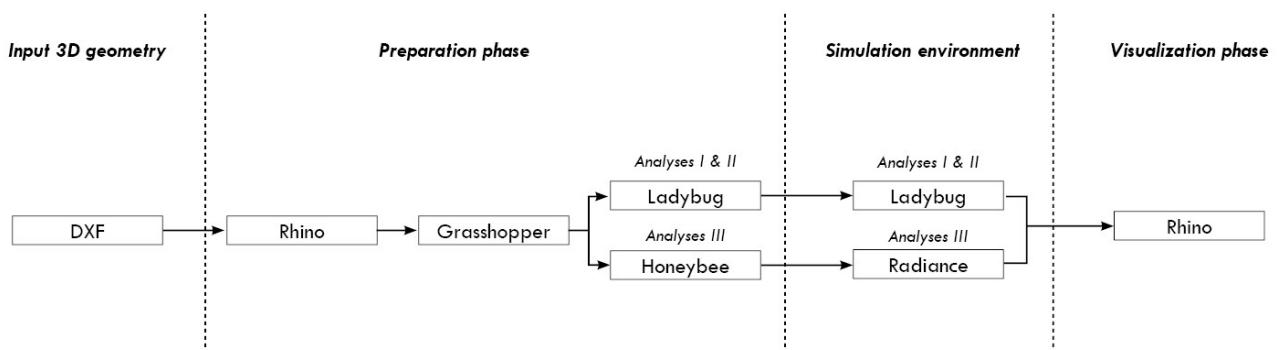

Workflow

## Challenges / Lessons learnt

The most important lesson learnt is that most frequently, the process of preparing the model for the analyses takes more time than the analyses themselves.

*Authors of this workflow story: Johannes Brozovsky*

# Sluppen

Gabriele Lobaccaro, Malgorzata Maria Lisowska, Erika Saretta,  
Pierluigi Bonomo, Francesco Frontini

## About the project

The developed methodology, based on 6 distinct steps, has been applied to the area of Sluppen, in the south part of Trondheim. The area is currently predominantly occupied by industrial buildings and parking lots and crossed by an important driving artery. The ambition of the municipality is to transform it into a more livable district, characterized by no cars and a great variety of mixed-use functions spanning from new technology firms, research

and education centres, residential and service buildings, and urban public spaces. The methodology was tested out on the existing situation as well as on two different design proposals, to assess solar accessibility and potential. In the description of the workflow story, the attention will be placed on the general methodology developed by the authors, while the representation will refer to the Feasibility Study I.

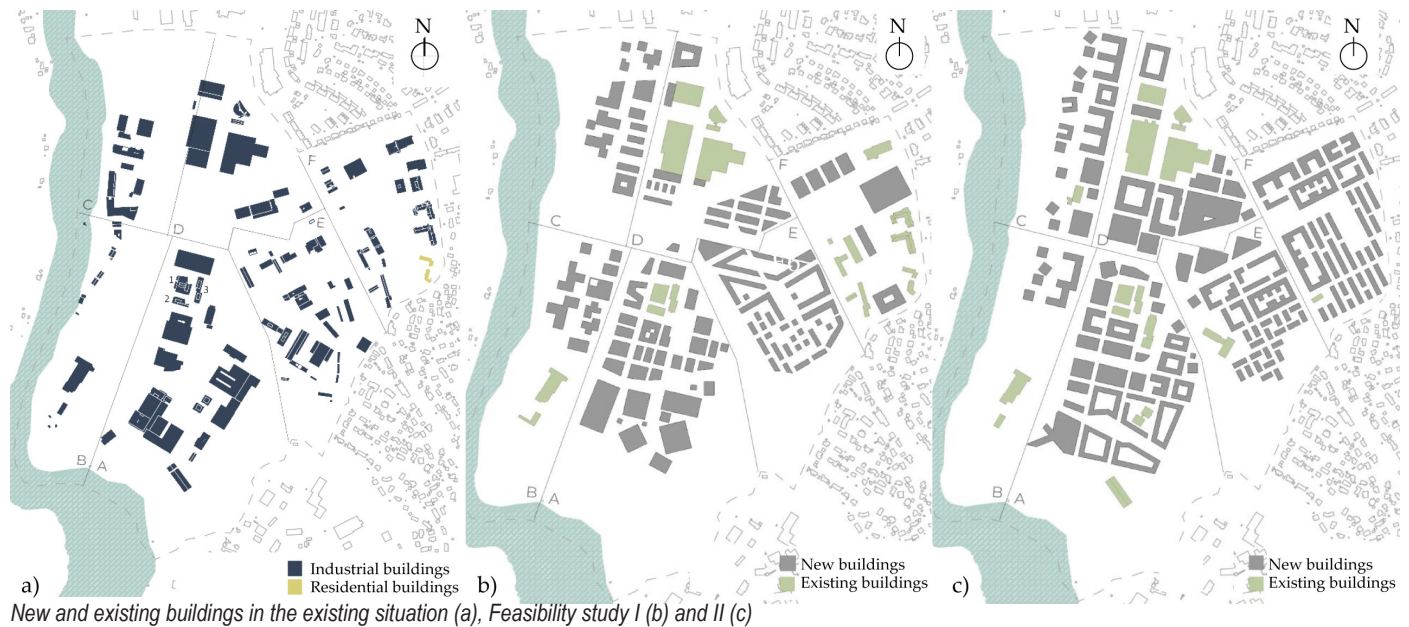

### Methodology

#### Step 1. – Urban Analysis

The first step of the methodology is to analyze the major urban parameters influencing the solar potential and

create a database of the collected information. The information are extracted from a 3D model in Rhinoceros and the database is created in Excel. Specifics of analysis are visible in the following Tables and Figures..

#### Types of analysis conducted in Phase 1.

Type of analysis	Description	Categories
BRA (bruksareal, usable heated floor area)	Used to determine the building density in urban areas in Norway	very low (0-5 000m <sup>2</sup> ) low (5000-10 000 m <sup>2</sup> ) medium (10 000-15 000 m <sup>2</sup> ) medium-high (15 000-20 000 m <sup>2</sup> ) high (20 000-25 000 m <sup>2</sup> ) very high (>25 000 m <sup>2</sup> )
Building heights	Summarized the height of the buildings in the considered area	low (0 < H < 20 m) medium (20 < H < 40 m) high (H > 40 m)
Height/width ratio	Aspect ratio between buildings' heights (H) and distances (W) between them	very low (0 < H/W < 2) low (2 < H/W < 4) medium (4 < H/W < 6) high (6 < H/W < 8) very high (H/W > 8)
Roof type	Morphology of the roof	flat, pitched
Shading	It presents the seasonal variation of shadings. Performed in Ladybug	solstices, equinoxes

a) BRA (available area)

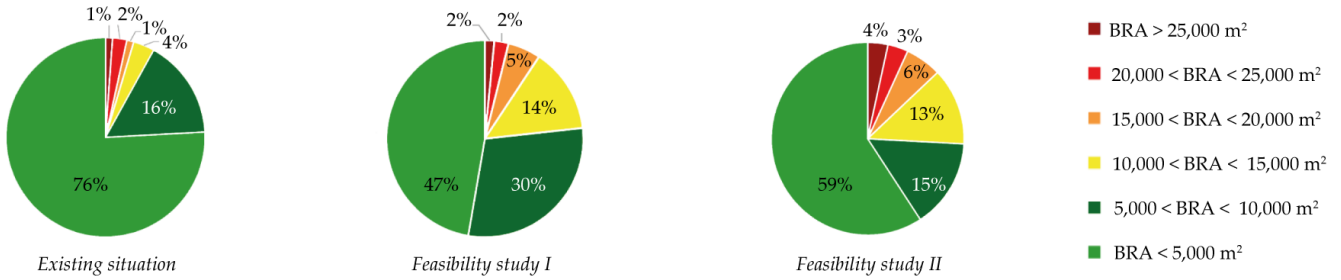

b) Buildings' height

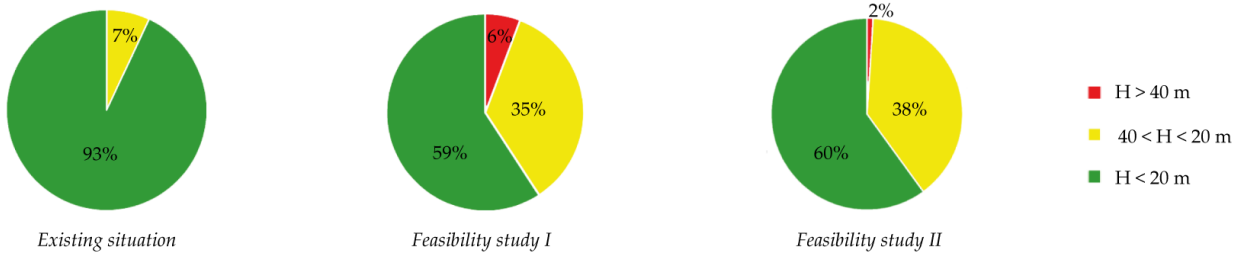

c) Height/Width

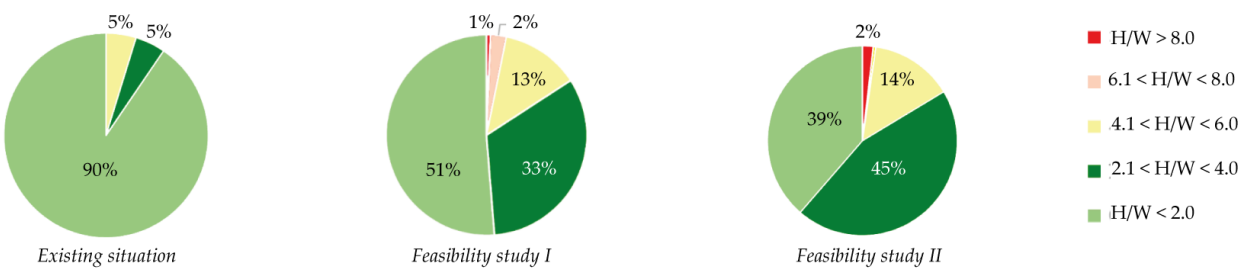

Urban analysis of Sluppen Area: (a) BRA; (b) building height; (c) H/W ratio

Step 2. – Solar Irradiation Analysis

In this second step, seasonal solar irradiation analyses are conducted at a district level to identify the solar potential of roofs and facades. Both direct and diffuse solar irradiation is estimated, and the reflection from the ground (0.9 in winter and 0.2 the rest of the year) and the facades of the surrounding buildings (0.35) is also taken into consideration.

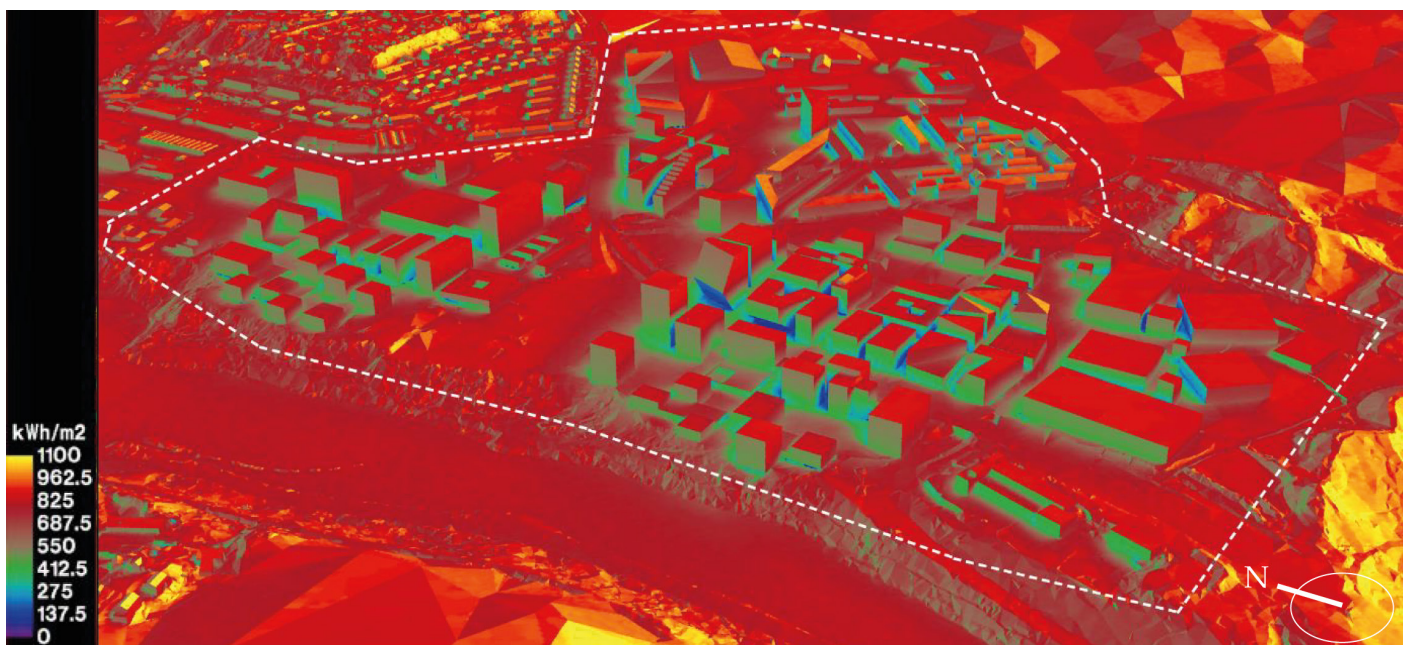

Annual irradiation analysis for feasibility study I.

### Step 3. – Solar Mapping

In this stage, a solar map is developed based on annual solar irradiation analyses with the scope of identifying roofs and facades with the highest solar potential of the area. The average annual irradiation value is taken in the middle point of each building's surface. The obtained values are then divided into five categories (very low 0-220 kWh/m<sup>2</sup>, low 220-440 kWh/m<sup>2</sup>, medium 440-660 kWh/m<sup>2</sup>, high 660-880 kWh/m<sup>2</sup>, very high 880-1100 kWh/m<sup>2</sup>)

and the annual solar irradiation values for each surface are imported into Revit and represented as 2D surfaces or lines of different colours, according to the category to which they belong (Figure below).

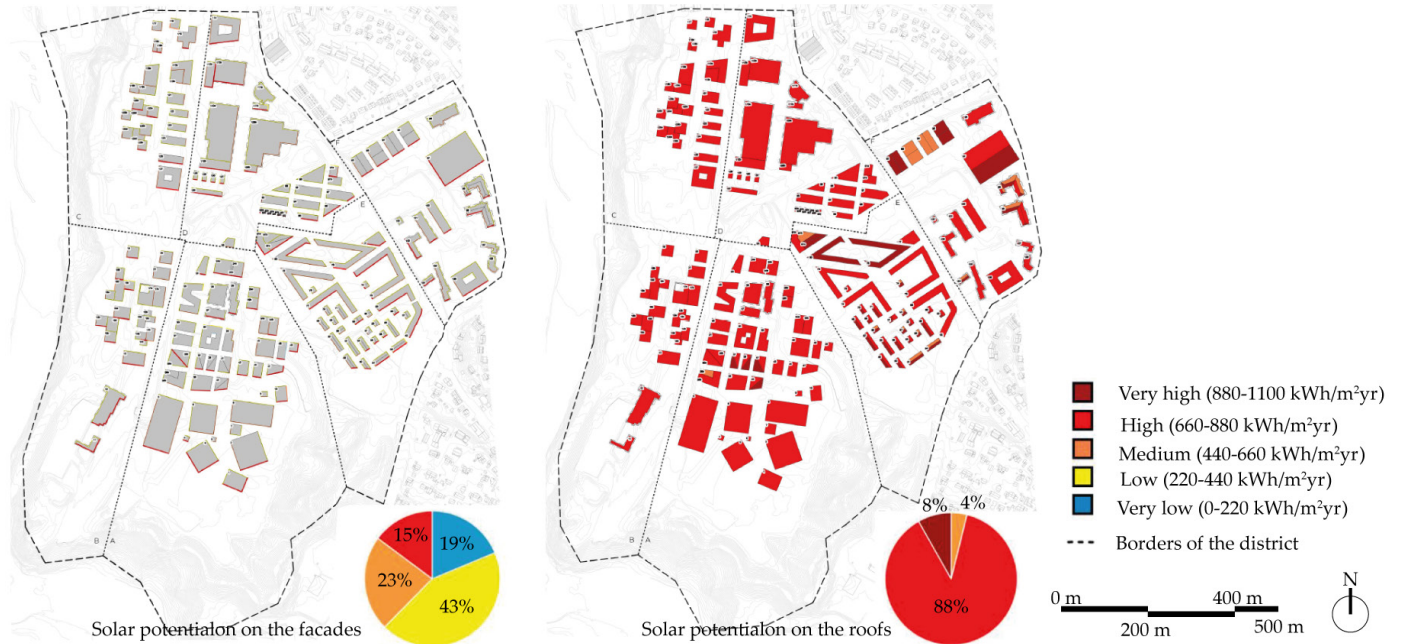

Solar map of the facades and roofs for the feasibility study I

### Step 4. – Data processing

In the Step 4, the outputs of the urban analysis of Step 1 are linked with the solar mapping of Step 3. This is done by transferring the 3D model into Grasshopper environment and it helps to study how the urban morphology influences the solar potential at a district level.

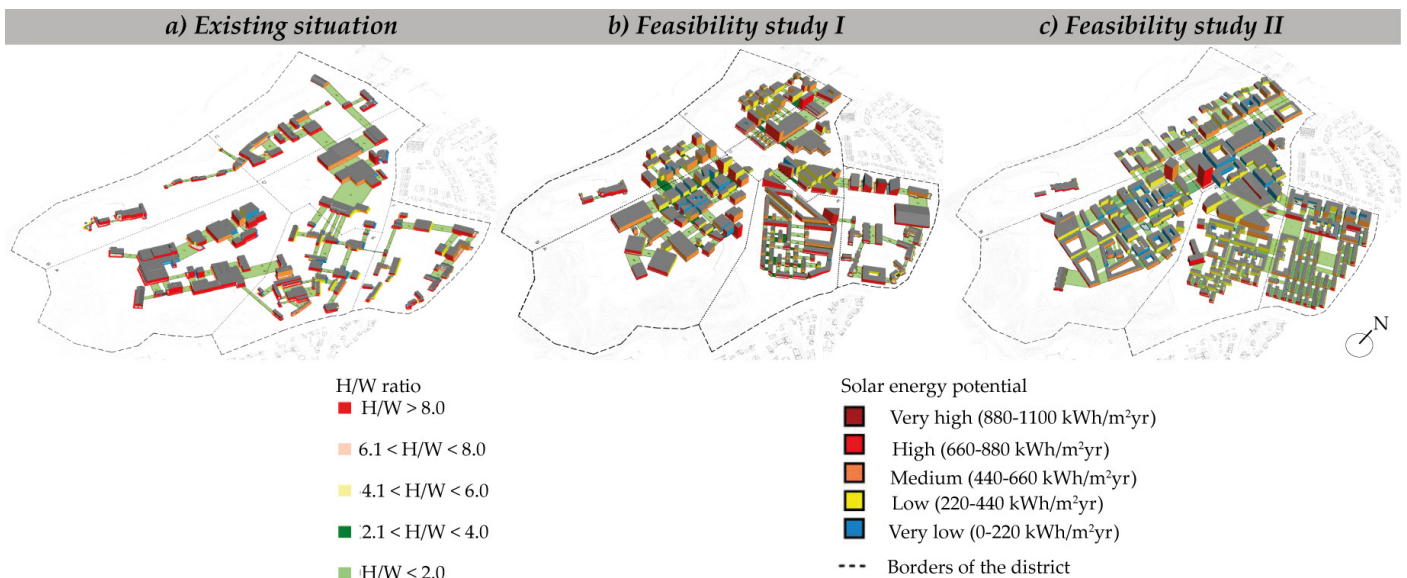

Solar potential of the facades depending on the H/W ratio (Feasibility Study I in the middle)

## Step 5. – Definition of Building Archetypes and Reduction Factors

This step of the methodology aims to define archetypes and identify the effective usable area for PV systems installation on facades and roofs. The total area of the building's envelope is, in fact, usually reduced by shading elements and obstructions (i.e., balconies, external staircases) and by the presence of glazed surfaces, that can only be partially replaced by PV systems.

The calculation of the effective available area is done by defining reduction factors (IR), applied to the total

gross façade area (S<sub>gr</sub>). A total of 5 reduction factors have been defined respectively for the presence of windows (IR1), balconies (IR2), shading of balconies (IR3), self-shading by other elements (IR4), presence of external elements as staircases (IR5).

Different building typologies present in Trondheim are defined as archetypes and their surfaces are analyzed in AutoCAD to understand where BIPV effectively can be applied. In this way, a reduction factor for every building's typology is defined and applied to all the buildings in the study.

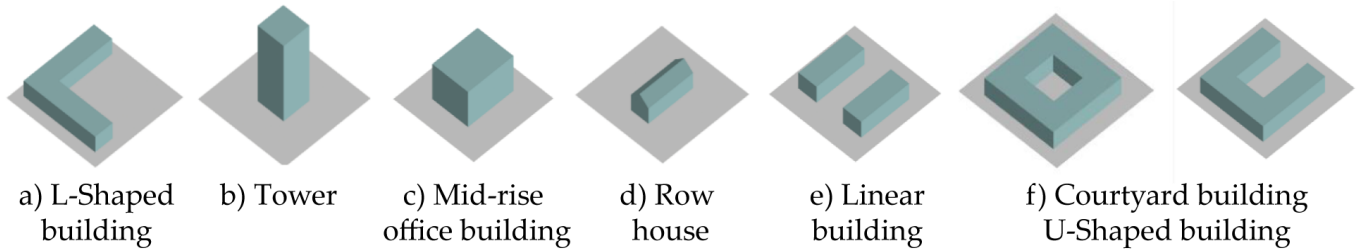

Most common typologies of buildings in Trondheim used as references

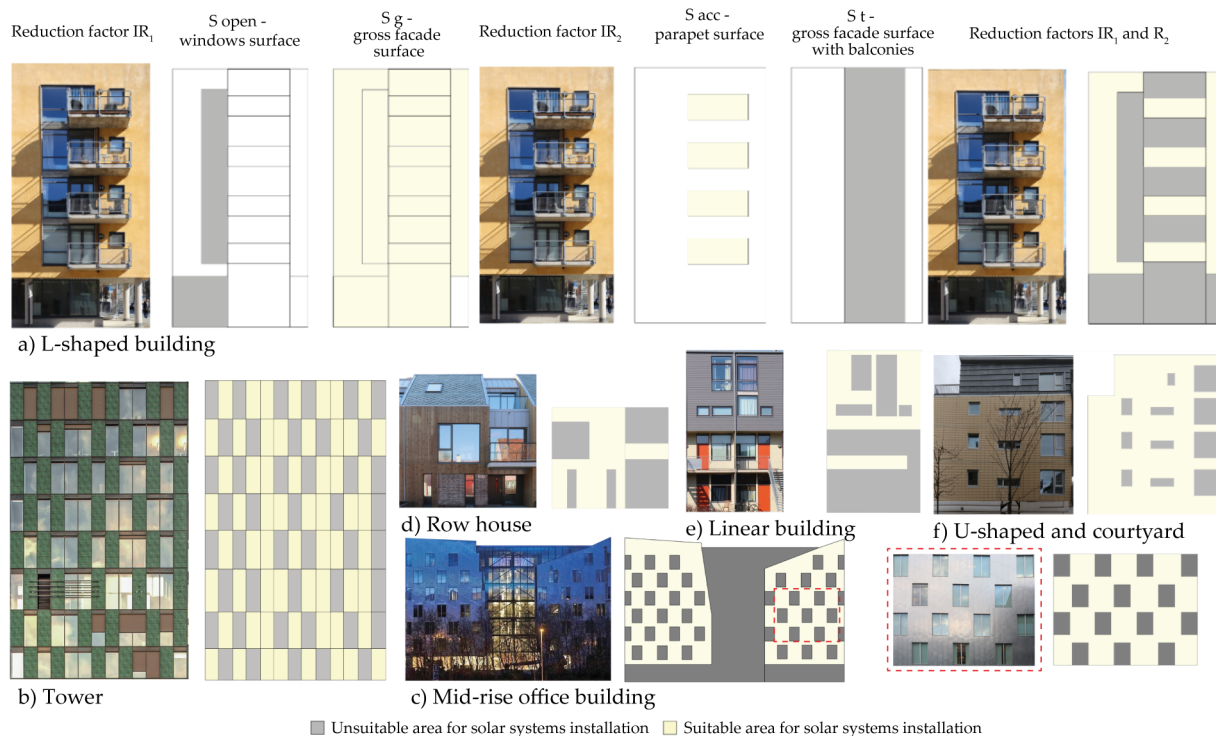

Graphical calculation in AutoCAD of the reduction factors IR1 and IR2 for L-shaped building and summary of the calculation of factors for all building morphologies

Summary of the reduction factors for all the building typologies considered

Building type	Building typology	IR1	IR2	IR3	IR4	IR5	Total
Residential	L-shaped building	80%	62%	61%	89%	80%	22%
	Row house	56%	83%	-	-	-	47%
	U-shaped building	77%	64%	-	94%	-	46%
	Linear building	83%	77%	-	-	83%	53%
Office	Mid-rise	52%	-	-	-	-	52%
	High rise	47%	-	-	-	-	47%

**Step 6. – Solar potential, Solar Energy Generation**  
Analysis and Technology Recommendations

The final step consists of identifying critical areas of the district in terms of high or low solar potential based on the outcomes of steps 3 and 4. The reduction factors developed in Step 5 are also applied to have more reliable results. These analyses are performed on a group of buildings using a grid-based irradiation analysis in Diva-for-Rhino, considering direct, diffuse, and ground/inter-building reflection. The potential energy yield by a PV system is assessed using the following formula:

$$FinalYield = G \left[ \frac{kWh}{m^2y} \right] \times Area[m^2] \times eff[\%] \times PR[\%]$$

Where G is the average value of solar irradiation on the surface area, Area is the area of façade of the roof, eff. indicates the efficiency of the PV module, and PR is the performance ratio.

Finally, a series of recommendations for the most suitable PV system for every surface of the buildings are given, according to the amount and quality of solar irradiation.

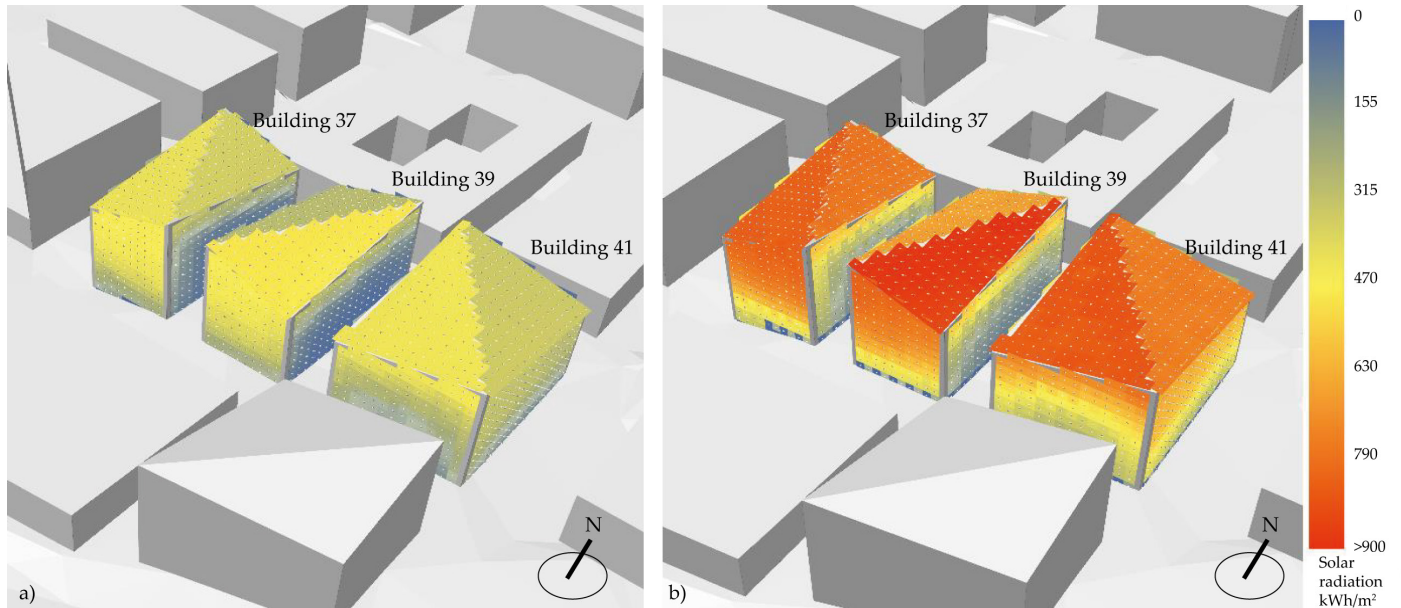

Annual grid-based analysis of direct solar irradiation (a) and global irradiation (b) in the critical area for Feasibility Study I

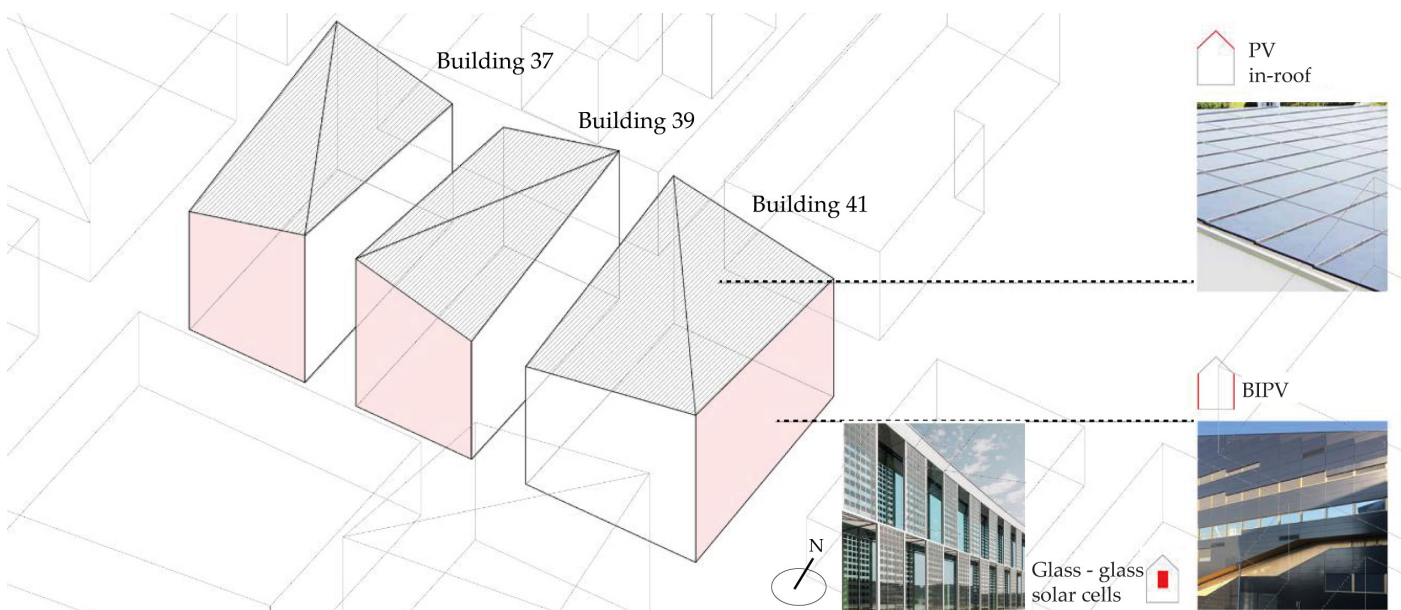

Solar technology recommendations for the critical area for Feasibility Study I

## Used tools

A set of tools has been used along with the steps of the methodology, specifically, Rhinoceros for 3D modelling, Excel, Revit, AutoCAD and Grasshopper for data processing, collection, and visualisation, Ladybug for shadow analysis, while for district level and grid-based solar

irradiation analyses Diva-for-Rhino has been used.

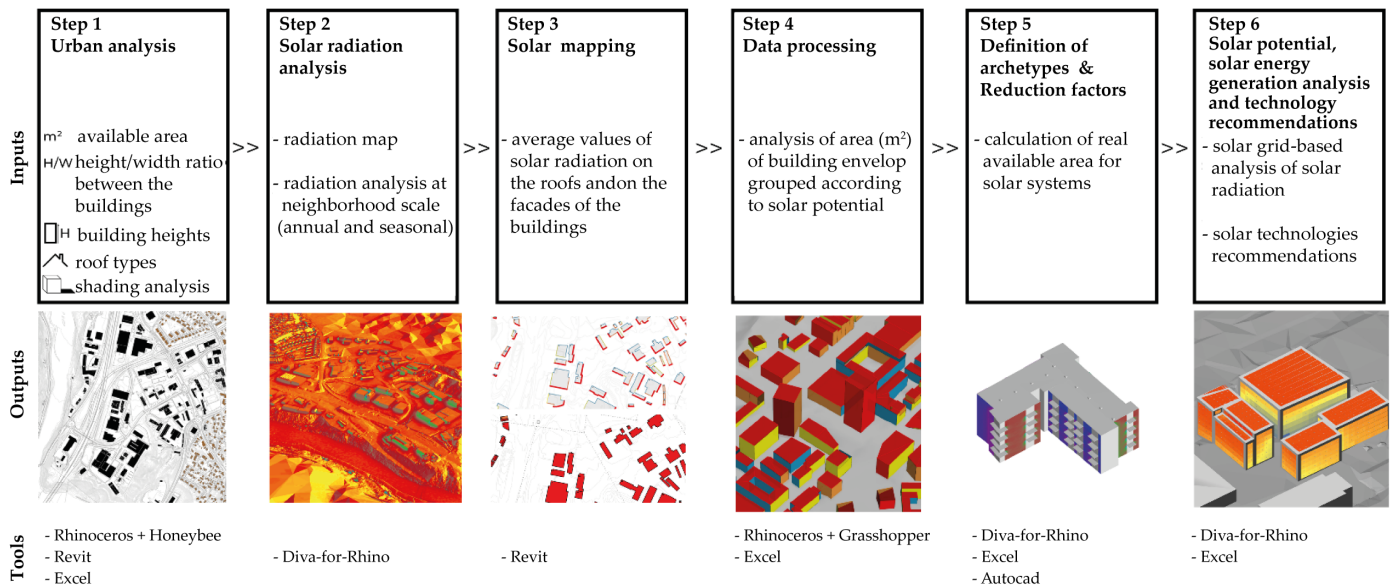

Solar technology recommendations for the critical area for Feasibility Study I

## Challenges / Lessons learnt

The challenges faced in this study are the following:

- Provide a support planning decision-making instrument to consider the solar energy integration since in the early design stages by identifying the most suitable building surfaces, roofs, and façades for BIPV installations in both new and consolidated urban areas.
- Evaluate and compare the solar potential of different project scenarios.
- Optimize the solar energy potential of projects currently under development by controlling their impact on the solar accessibility of the existing buildings.

The lessons learnt from the developed workflow are the following:

- Avoiding switching between much software would have probably been beneficial in terms of straightforwardness of the methodology. A solution could have been to avoid the use of Revit, AutoCAD, and Diva-for-Rhino, and substitute them completely with other software already utilised to have a more integrated workflow using Rhinoceros, Grasshopper, and the Ladybug Tools or a more advance co-simulation approach by coupling existing tools with advance algorithms developed through programming languages (e.g. python, MATLAB Simulink, java, C++).
- The developed approach is replicable for different building and urban scenarios (i.e. the existing situation and the two feasibility studies) showed that it can be used independently for several design proposals and

geographical locations.

- The tools used to develop this approach are popular among architects and urban planners, therefore it can be used by anyone with suitable software skills. The climate data used in this study (through the weather climate file .epw) can be substituted with any other worldwide location. Therefore, it can be replicated in any city. The building archetypes that define the reduction factors can be also replaced by building typologies unique to any location.

Authors of this workflow story: Lobaccaro, G.; Lisowska, M.M.; Saretta, E.; Bonomo, Frontini, F. A



# Gullhaug Torg 5

Erichsen & Horgen AS



## About the project

The project is an office building located in Nydalen (Oslo). The completion of the building is planned spring 2022. The building is structured around an inner atrium. The interior plan for the office spaces are laid out as a flexible and scalable system, oriented towards the outer glass facade. The building has been planned with integrated PV (BIPV) system and a glass facade that has strategically integrated sun shading (ConverLight) as a part of the window glass. The solar shading helps enhance the architecture concept of a visually transparent building. Worth mentioning is also the environmental strategies to reduce the need of glass material in the building by using a heat mirror foil on the centre glass pane. Sufficient insulation value is achieved without using extra panes of glass.

Erichsen & Horgen was contracted to work on the development of the façade design and to work on energy, daylight, solar shading, and the evaluation of potential PV production on the building surfaces.



Project rendering (Avantor/Arcasa Architects)

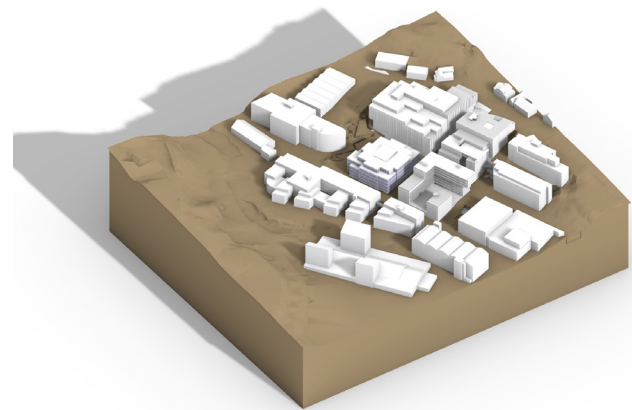

Situation perspective (Erichsen & Horgen)

## Key Performance Indicators in the project

The building is planned to achieve energy standard BREEAM NOR Excellent and has received governmental support from Enova for the work on the innovative facade design.

The following calculations and tools were used:

1. Evaluate the need of sunshading/glass quality (Grasshopper for Rhino),
2. PV production (Grasshopper for Rhino),
3. Early phase daylight – Sky View component (Grasshopper for Rhino),
4. Detailed daylight calculations (IDA Ice).

Parameters for evaluating the calculations:

1. Solar shading should be evaluated when peak solar radiation is higher than  $900\text{W}/\text{m}^2$ .
2. Solar potential considered useful on areas defined by minimum average yearly solar radiation of  $120\text{kWh}/\text{m}^2$ .
3. Sky view component of 15% is considered lower value for when areas can be reasonably utilized as working spaces.
4. Average daylight factor of minimum 2.0%

# Tools in the project

## Output

The studies shown is early phase analysis that effectively contribute as visual representations in the decision making process.

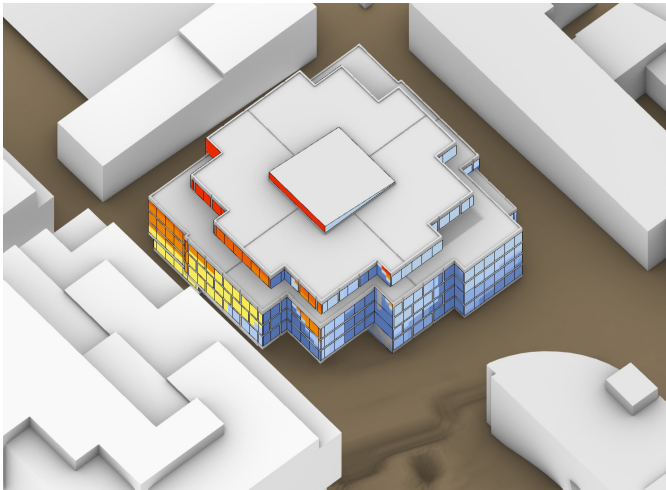
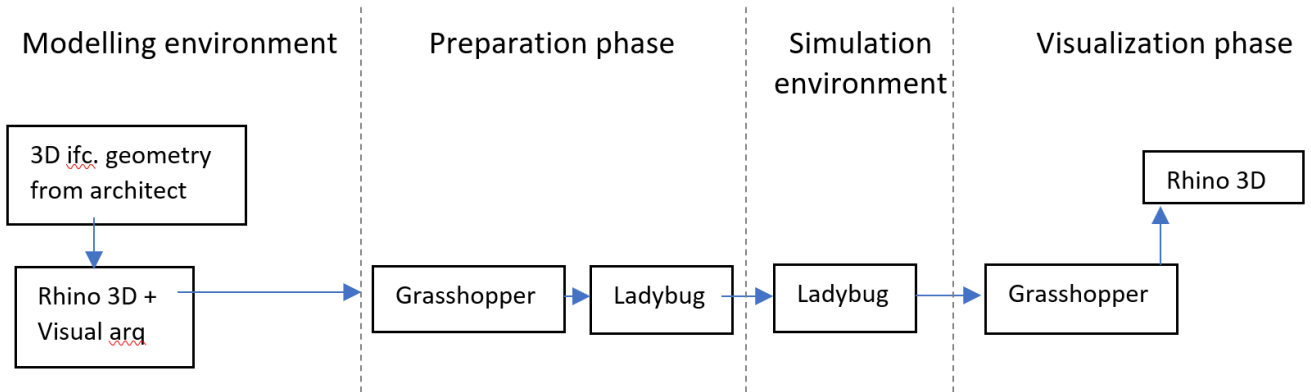

Analysis 1: Evaluation of the need for sunshading/glass quality

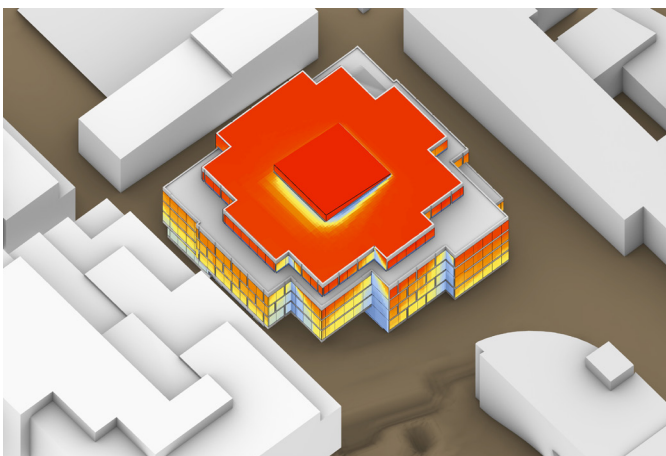
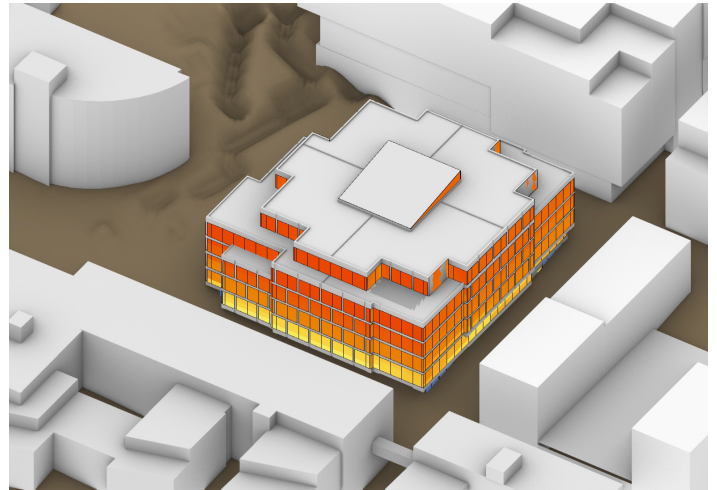

Analysis 2: PV production potential

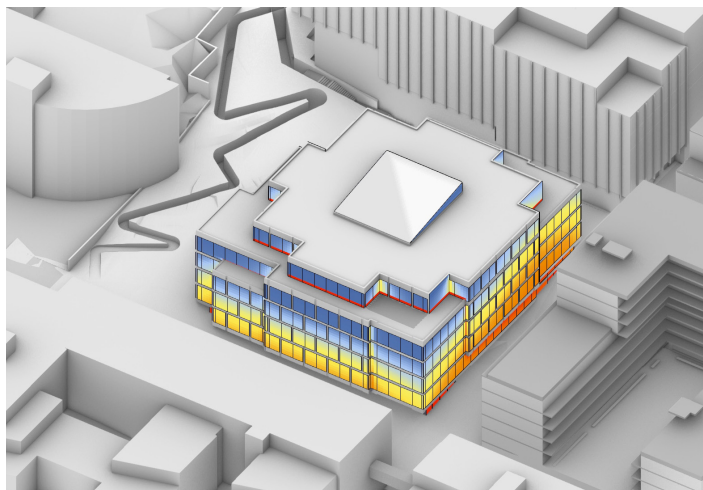
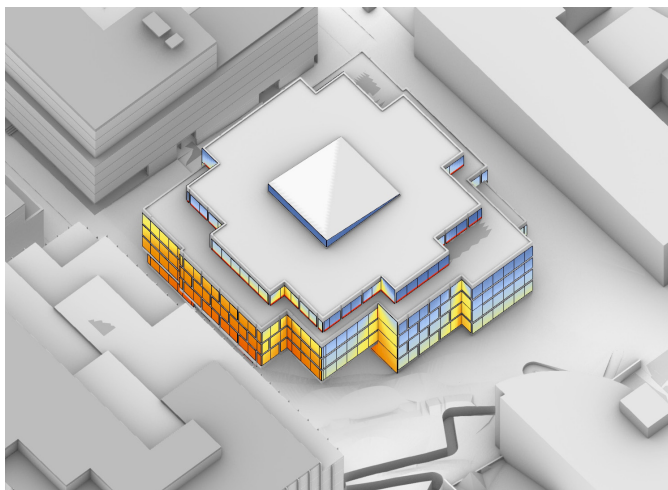

Analysis 3: Sky View Component

Performance indicators	Weather data	Tool / engine used	Interface	Sky
Peak solar radiation	Fornebu STAT. data + Blindern EPW data	Ladybug	Ladybug	Clear sky
Radiation analysis	Blindern EPW data	Ladybug	Ladybug	Cumulative sky
Vertical Sky Component	n/a	Ladybug	Ladybug	n/a

## Challenges / Lessons learnt

Grasshopper for Rhino is a powerful tool for generating visual images that can be used in a decision-making process. The process of building optimal calculation models based on ifc files from the architect are often time consuming.

The calculation results must be considered rough and are less useful for detailed calculations. Software with more detailed parameters such as mounting angles, product specific performance and wiring/grouping may be more reasonable in more detailed planning.

# Daylight Access in Existing Swedish Neighbourhoods

ACC Glass and Facade consultants



## About the project

The project is a reference guide which shows the daylight performance of existing Swedish city districts. The basic idea is that planners can more easily understand and interpret daylight results for new proposals if they can put their results in the context of familiar neighborhoods. In addition to providing a benchmark for new neighborhoods, the project also looks to provide a needed point of reference for cases involving rights for daylight/sunlight for existing properties.

It is well understood that urban density is a key parameter for daylight access. In Sweden, a rapid increase in land prices along with aggressive political policy has fueled a move towards increasingly densely planned settlements. The Nordic climate offers a particular challenge however as access to daylight is severely limited by season. The result has been that many newly planned settlements struggle to meet the even basic building code requirements and/or, in many cases, the daylight access of exist-

ing properties has been severely reduced.

While the use of early-stage daylight analysis metrics has started to make their way into the Swedish planning process in recent years, it is apparent that the techniques commonly used for assessment by daylight specialists are unfamiliar to the majority of planning professionals. In the project, daylight analysis results are compiled for a number of well known existing urban districts and the results of the various analysis metrics are then compared against floor area ratios data for these neighborhoods. The cities of Gothenburg, Malmö, Linköping and Uppsala have contributed models and/or limited funding to the project in return for workshops to discuss the daylight performance of their cities. Within the reference guide, additional results are also given for a limited number of areas in Stockholm. The project is currently searching additional partnerships with Swedish cities / municipalities as well as funding partners.

## Key Performance Indicators in the project

The main performance indicators for this project have to date been Vertical Sky Component (VSC) in relation to Floor Area Ratio (FAR). The use of VSC corresponds to the building regulation's use of daylight factor with overcast sky for assessment at the room level. Floor Area Ratio follows the Swedish definition as outlined by Rådberg (1993).

Plans are currently underway to expand the scope of the work to include results for direct sun as per the CEN 17037:2018 as well as assessment with Aperture Based Daylight Metrics (ABDM) as proposed by John Mardaljevic (2020).

## Tools in the project

### Output

#### URBAN DISTRICT ANALYSIS

##### STOCKHOLM

Röda bergen

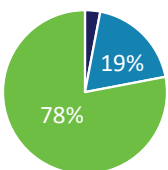

Birkastaden

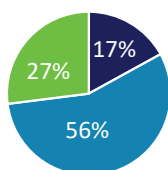

Hagastaden

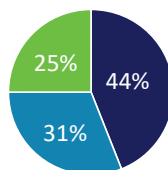

Fredhäll

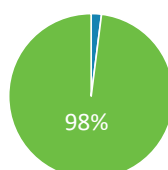

##### GÖTEBORG

Nya Masthugget

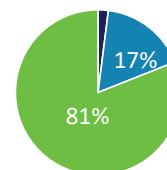

Haga

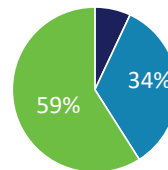

Majorna

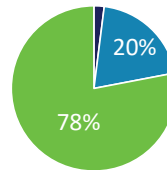

VSC analysis of Haga district Gothenburg



IMAGE COURTESY OF: BYRAN FÖR ARKITEKTUR OCH URBANISM, BAU AB  
 VSC analysis of Haga district Gothenburg

EXISTING SITUATION

NEW PROPOSAL

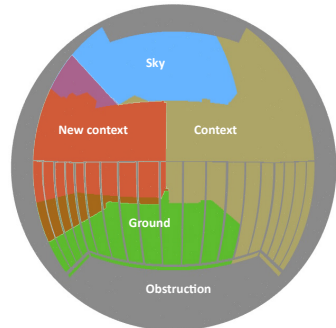
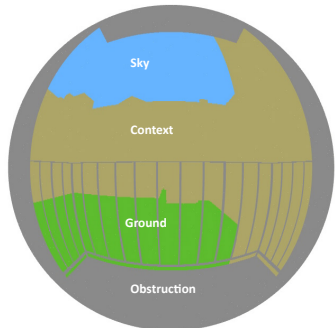
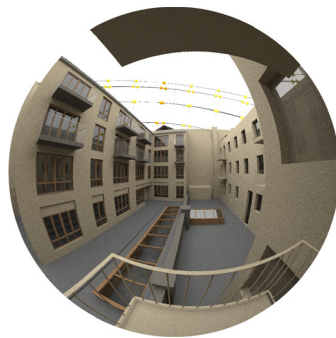
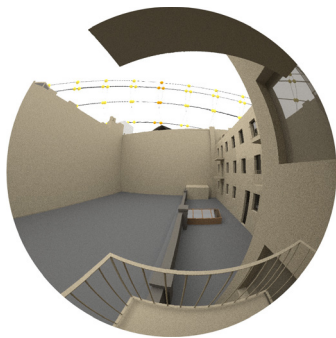

Solar Beam Index (SBI)

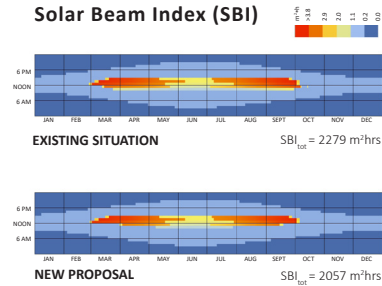

View Lumen

	View Lumens Before per m <sup>2</sup>	View Lumens After per m <sup>2</sup>	% Loss
Sky	188	159	15
Ground	168	132	21
Context	545	610	11
Obstruction	1099	1099	0

Aperture Based Daylight analysis

## Used tools

Models of each urban district were received from the municipalities in .dwg and .skp format. Model geometry was then imported into Rhinoceros, cleaned, and gridded. Analysis was carried out using custom written scripts made for Honeybee/Ladybug plugin for Grasshopper and Radiance as a simulation engine. The post processing of the results was carried out in Excel and Adobe Illustrator.

## Challenges / Lessons learnt

The main challenge to the project has been the varying degree of detail of the models received from the municipalities making comparison of the results between projects less reliable. Similarly, while there are set rules guiding how FAR is to be derived, there is also some judgement involved in the process. As such, the reliability of the FAR statistics submitted by the various partners to the project cannot be verified and thus are of limited use when making comparisons of daylight results between the various municipalities. Rather for future iterations, it is advisable for FAR to be derived by the same person from within the project itself. And then finally, the inherent limitations of VSC and the European Standard direct sun metrics must also be acknowledged.

Authors of this workflow story: Paul Rogers, Mihail Todorov

# inFORM - Inhouse tool for architects/engineers

White arkitekter AB



## About the project

Within White arkitekter, a set of digital tools, called inFORM, can be used by designing architects and engineers to easily evaluate different sustainability aspects on a building or urban design. The tools are developed by the Digital Sustainability group at White and are intended to be used with supervision and assistance from an environmental specialist. They can be used in the Rhino environment. Models can easily be imported and adapted from other programs such as Sketchup or Revit using the tool module conFORM. The use of the toolset does not require any previous knowledge of Rhino.

All the inFORM tools are developed in grasshopper and are simplified versions of more advanced analysis

provided by specialists. The purpose of inFORM is not to replace these services but complement them by making building performance simulations accessible for non-specialists. Training in theory as well as practical use of the tools are supplied and needed for a successful implementation.

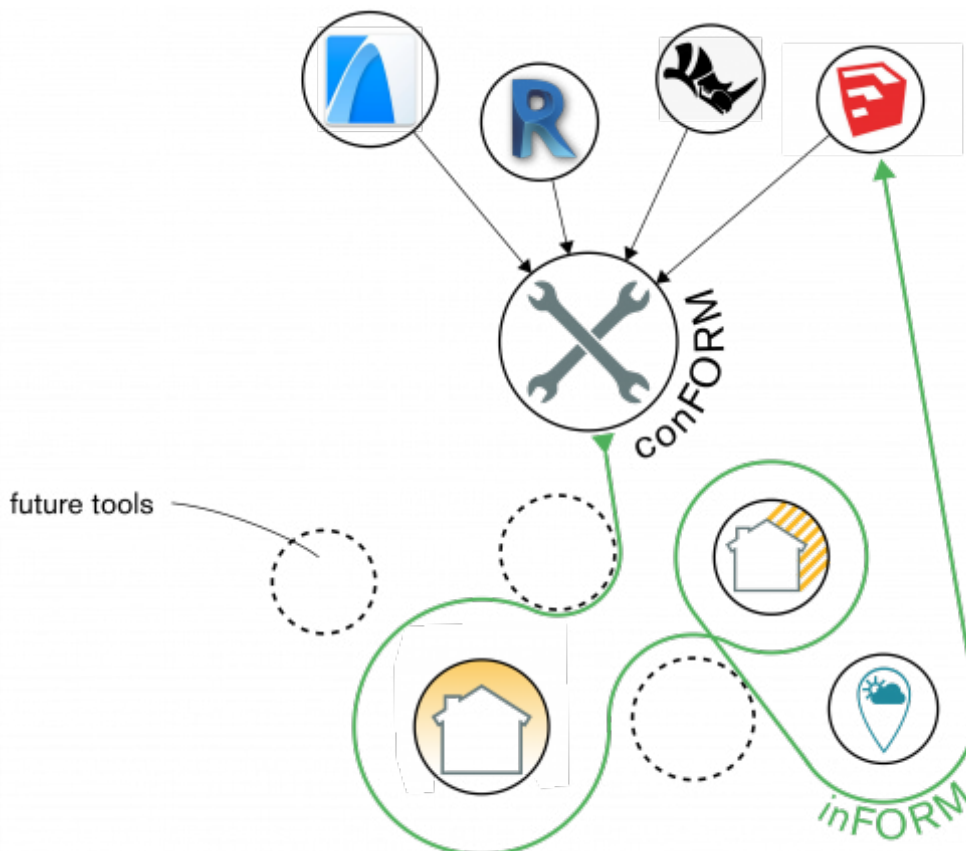

# Key Performance Indicators in the project

A common indicator used in Sweden is the Daylight Factor (DF). The Swedish building regulations state that the DF should be at least 1 % and needs to be calculated on a point located halfway through the room depth, one meter from the darkest lateral wall, 0,80 m above floor level. The daylight factor is linked to the metric Vertical sky component (VSC) that is used in the daylight module within inFORM.

Sunlight access on facades and ground are evaluated in the sunlight module. Swedish building regulations have a vague requirement that at least one regularly occupied space per residential unit shall have access to some direct sunlight during the year. The regulations refer to a publication from 1991 that recommends that apartments and outdoor spaces receive at least 5 hours of direct sunlight on the equinox, between 9am-5pm.

The microclimate module evaluates outdoor thermal comfort using the Universal Thermal Climate Index (UTCI). The UTCI calculation uses air temperature, mean radiant temperature (MRT), wind speed and relative humidity. In the microclimate module, simulated sunlight

access is used in the calculation of MRT, whilst all other parameters are taken from climate data and modified to adjust for context.

Three categories exist in this index:

- Cold thermal sensation: UTCI < 9 degrees
- Neutral thermal sensation (thermal comfort): UTCI of 9 to 26 degrees
- Hot thermal sensation: UTCI > 26 degrees

Primary energy use in buildings are evaluated in the energy module to compare with energy demands in the Swedish building regulations.

Because of that the tools should be fast and integrated in the design process, simplifications have been made. An example of this is that the microclimate module doesn't perform a full wind simulation but still takes into account climate wind data as well as the context and local conditions.

## Tools in the project

### Output

inFORM\_facade daylight can be used to evaluate whether simple building volumes receive enough daylight to facilitate compliance with the Swedish daylight requirement. It is suitable to make estimations both for early building design stage and urban planning. Note that a different tool, the daylight factor tool, should be used later on, once the facade openings and the interior layout have been designed to verify the actual interior daylight levels. inFORM\_sunlight can be used to evaluate sunlight access in:

- Residential buildings (in accordance with the Swedish building regulation)
- Other building types
- Outdoor spaces (courtyards, schoolyards, parks, etc) in accordance with the British BRE standard and Boverkets recommendations

inFORM\_microclimate can be used to evaluate the local climate and to quantify the effect of the built environment on wind speed, sunlight access and outdoor thermal comfort.

inFORM\_energy (Work In Progress) allows to evaluate building energy performance at early design stages based on indicators such as Shape factor, average U value and a simplified primary energy use calculation.

inFORM\_PV (Work In Progress) can be used to quickly and easily assess which surfaces in the project are apt to host PV cells.

The following Figure explains when in the Swedish plan and design process the inFORM tools can be used to inform the process.

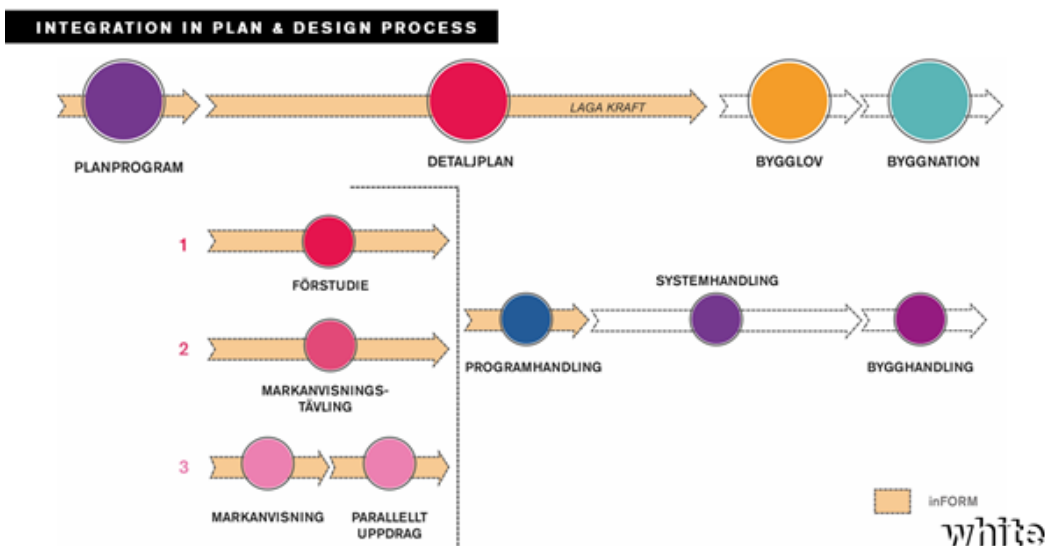

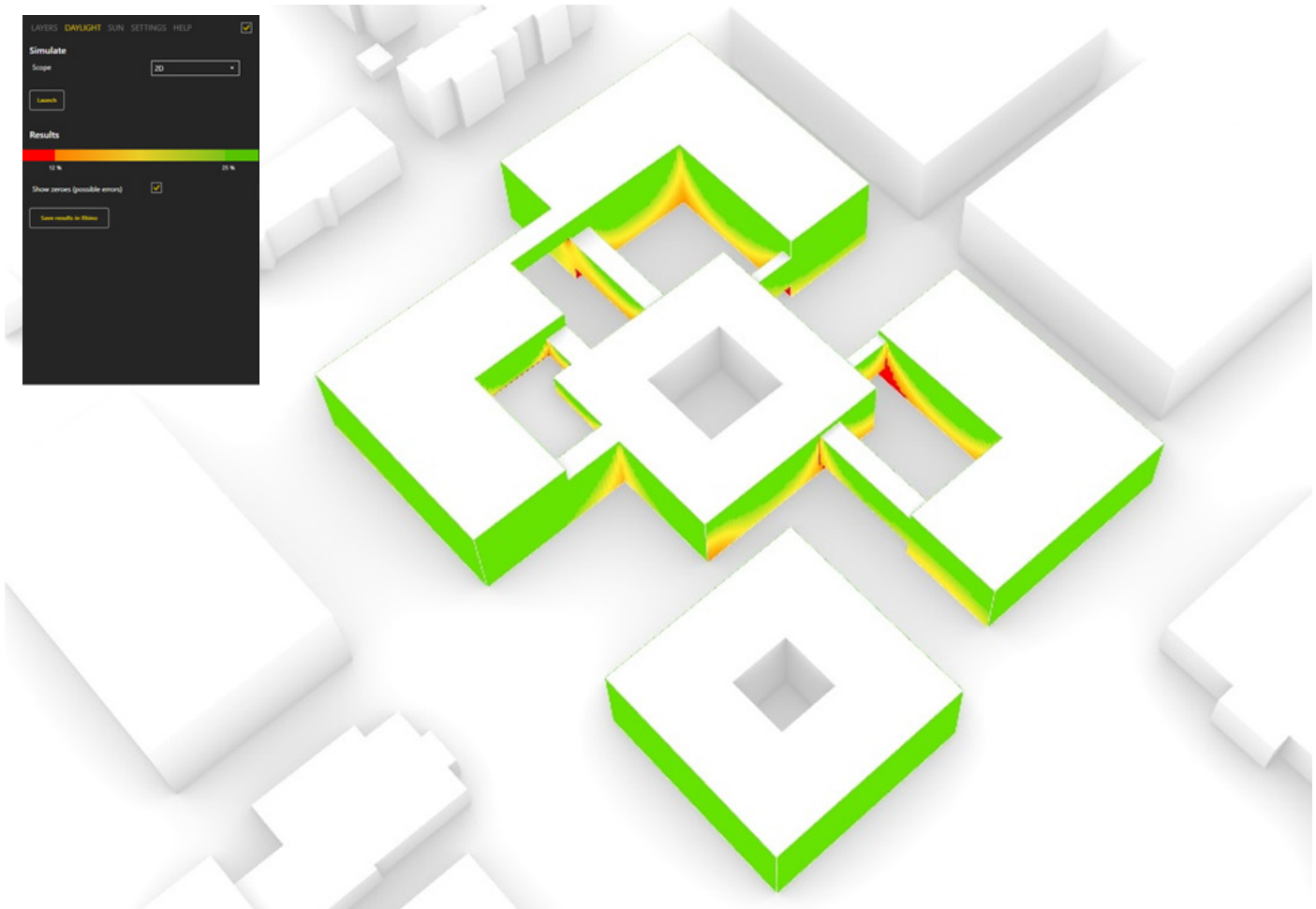

Example of interface and results from the façade daylight tool

## Used tools

Rhino 6, Grasshopper, Excel. The workflow is illustrated in an earlier Figure.

## Challenges / Lessons learnt

### How did the workflow support the project?

In an office project close to Stockholm, a VSC study was performed at an early stage, in order to evaluate a set of different building forms and to quantify the number of storeys deemed possible with respect to daylight requirements (prior research at White has connected VSC results with likely interior DF values). The VSC metric was well suited to this kind of study; requiring only simple building forms and allowing many tests to be performed in quick succession. This quickly resulted in an optimised scenario for each building form. Clear and concise presentation of the results in 2D, together with a clear legend, allowed an informed decision to be made by the client.

In a residential project in the north of Sweden, a sunlight study was performed on simple building volumes, before an interior layout had been set. This highlighted, at an early stage, areas where insufficient sunlight access would require specific design considerations. In this case: where single aspect apartments would not be possible, due to constraints from building regulations. The results, once presented clearly in a report, were able to be used by the design team whilst developing the façade and internal layout.

### What challenges were you presented with when using this workflow?

Daylight: With this workflow, there is a challenge in providing enough information, whilst keeping the presentation clear and understandable. As this is a simplified daylight analysis, several significant assumptions are made. Whilst these keep the study quick and simple, it leaves the results open to a high degree of interpretation. Without the proper level of understanding, this uncertainty can lead to results not having the desired impact on the design.

In another residential project example, a VSC study was performed at an early stage, showing that the new construction would have a significant impact on the daylight access in existing apartments. Whilst this was evident from the results, there were no significant changes made to the building form by the time the project came back for interior DF studies at a later stage. The results from the interior DF studies, however, resulted in a clearer understanding of the problem.



**Sunlight:** The Swedish building regulation for direct sunlight access in residential buildings is vague and leaves significant room for interpretation. Best practice guidelines provide a good fallback, but they can easily be challenged, especially in a project where they are not easily met. This was exemplified in a residential project west of Stockholm, where a sunlight study showed that regulations were not met. Here the preconditions for sunlight access were tough and the decision to run the sunlight study on the spring equinox (as best practice recommends), instead of the summer solstice, was challenged.

**Microclimate:** Accurately evaluating microclimate and outdoor thermal comfort is a complex and computationally heavy process. The simplified method used in inFORM involves a lot of approximations, which can lead to confusion when interpreting results. For example, inFORM was used for a project in Umeå. Here, the architect using the tool assumed that the building geometry would directly influence the thermal comfort results through a reduction in wind velocity. This was not the case however, as the calculation uses wind data directly from a climate file, which is then only corrected for exposure based upon a simplified input from the user; the geometry in the model influences only the sunlight access directly.

The question of whether vegetation should be included was also raised – vegetation is notoriously difficult to model accurately and is most often excluded for simplicity. However, the impact on microclimate can be significant.

### **What needs to be developed in order to improve the workflow?**

In general, the tools need to be approached with a clearer idea of what the project wishes to gain from them. Without clear quantitative boundaries set prior to analysing, the results can be informative but only if sufficient background knowledge is available. Less so for sunlight, where building regulations set a clear requirement (if best practice is referred to).

**Daylight:** A focus on presentation primarily in 2D, with 3D as a backup. Some inclusion of a facility for making comparisons between scenarios would extend the tool's applicability significantly.

**Sunlight:** Clear application to Swedish residential buildings, but less so for other projects (although the methodology used is open to questioning). It requires the inclusion of more best practice guidelines, in order to be useful for a wider range of projects (facades, open spaces, school yards etc).

**Microclimate:** Development of a clearer workflow i.e. in order to achieve a useful output, this tool shall be used for comparative studies or where there is already a clear idea of the intended use of the studied areas. Alternatively, further simplification of the results output to take into account the intended use or intended comparison, in order to give a clear and informative result. Additionally, some consideration of vegetation, as well as connection with actual simulated wind results would be very beneficial.

# G2 Solaire (INTERREG)

University of Applied Sciences and Arts Western Switzerland (HES-SO)

h e p i a

Haute école du paysage, d'ingénierie  
et d'architecture de Genève

Hes-SO GENÈVE  
Haute École Spécialisée  
de Suisse occidentale

Interreg  
France - Suisse



## About the project

Through the development of a solar cadastre on the scale of Greater Geneva (about 2 000 km<sup>2</sup>), the objective of the G2-Solaire project is to provide the means to intensify the use of solar energy, to generate economic activities around the solar sector and ultimately contribute to achieving the energy transition objectives in a context of urban densification.

The project is structured around two main components: A first technical component, associating French and Swiss research laboratories, aims to develop a map of solar potential at the cutting edge of innovation; the second institutional and political component aims to make the cadastre known and to facilitate its appropriation by all the actors concerned (elected officials, public administrations, energy suppliers, investors, professionals in the sector, civil society, individuals).

Besides, it is worth mentioning that the modelling tools used in G2 Solaire was also used in other applications, in particular in the project of Solar planning of the municipality of Carouge (State of Geneva). Carouge is famous for its historical part involving thus high heritage issues. Therefore, the scope of the project was to map and classify the districts Carouge according to high (new developments), middle (existing districts) and low opportunities (historical part) for solar installation with the support of the solar cadaster. Solar potential was also simulated on facades of new building developments. This pilot project (2016 – 2018) was supported by the Swiss Federal Office of Culture (related to heritage issues).

## Key Performance Indicators in the project

Solar potential on roof is considered under the two conditions: 1) Useful areas defined by minimum annual solar radiation of 1000 kWh/m<sup>2</sup>; and 2) Minimum area of 5 m<sup>2</sup>. Besides, the solar cadastre of the Greater Geneva does not rely on particular KPI in the sense of goals and

thresholds associated to indicators. It displays a set of energetic, economic and environmental indicators (as illustrated below / Output) allowing then the user to conclude on the opportunity to install solar panel on his/her roof.

## Tools in the project

### Output

The main output of G2 Solaire is the Web interface of the solar cadastre of the Greater Geneva that displays the main solar maps and indicators to users for both application: PV and thermal.

The screenshot shows the web interface of the solar cadastre of the Greater Geneva. The interface is in French and displays a map of a residential area. A search bar at the top left contains the address "6 Rue Hans-WILSDORF - 1227 Les Acacias - Suisse". The main content area is divided into three tabs: "Données clés", "Caractéristiques de la toiture", and "S'équiper". The "Données clés" tab is active, showing a table of key indicators for solar potential.

Indicateur	Valeur*	Commentaire
Surface des panneaux	5'206 m <sup>2</sup>	Surface des panneaux installables sur la toiture.
Puissance	833 kW	Puissance électrique totale installée en fonction de l'efficacité et de la surface des panneaux.
Production électrique	9'15 MWh/an	Electricité totale produite annuellement par les panneaux.
Investissement	854'658 CHF	Investissement total pour l'installation de systèmes clé en main.

Web interface of the solar cadastre of the Greater Geneva (PV use in the example) <https://sitg-lab.ch/solaire/>

This interface supports a given owner in identifying if the roof is suitable for solar installation and give useful indicators for pre-design of the installation. At the level of ND, municipality or wider, aggregated data (using GIS) support in devising solar planning strategies.

A second version of the interface is currently under development. It will propose a more dynamic use allowing the user to modify the installation area (through a cursor) and to identify the optimum size (according to minimum return

period of the investment).

For professional use, the Geoportail of the State of Geneva displays more specific indicators together with other energy layers.

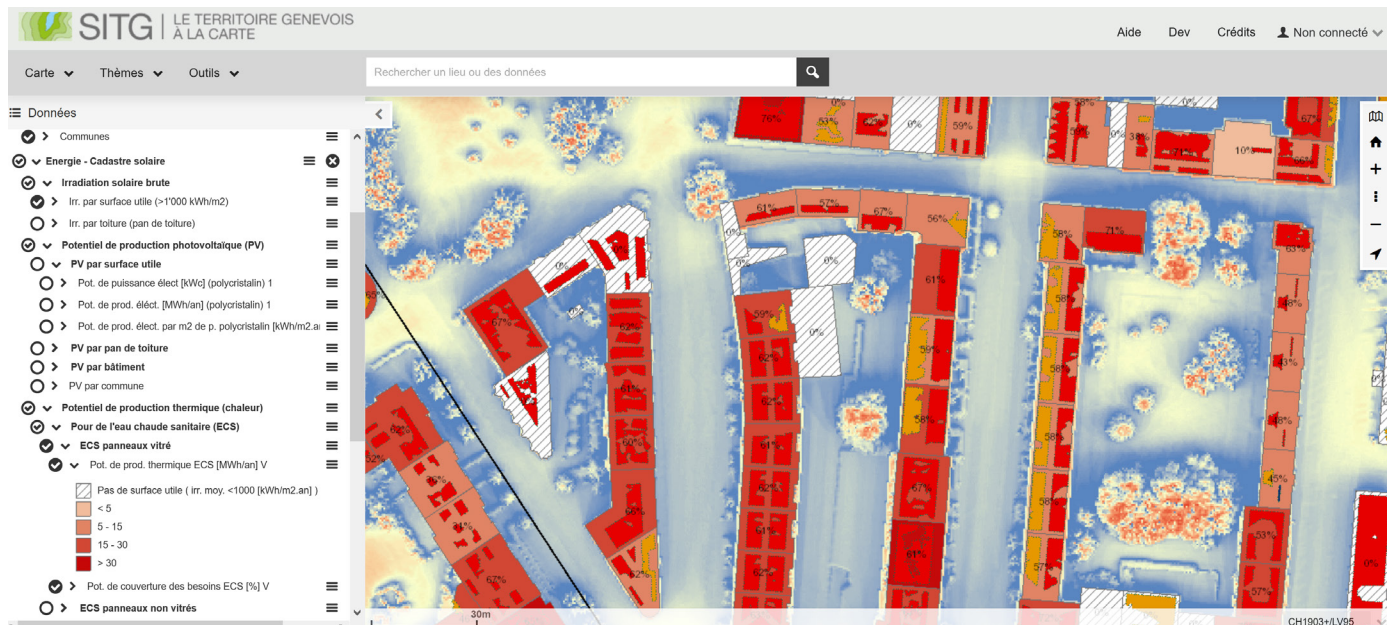

Geoportail displaying energy layers, among them solar (thermal use in the example) ([link](#))

Here is an example of outputs of solar radiation on facade simulated on the development on a new ND in Carouge (Geneva).

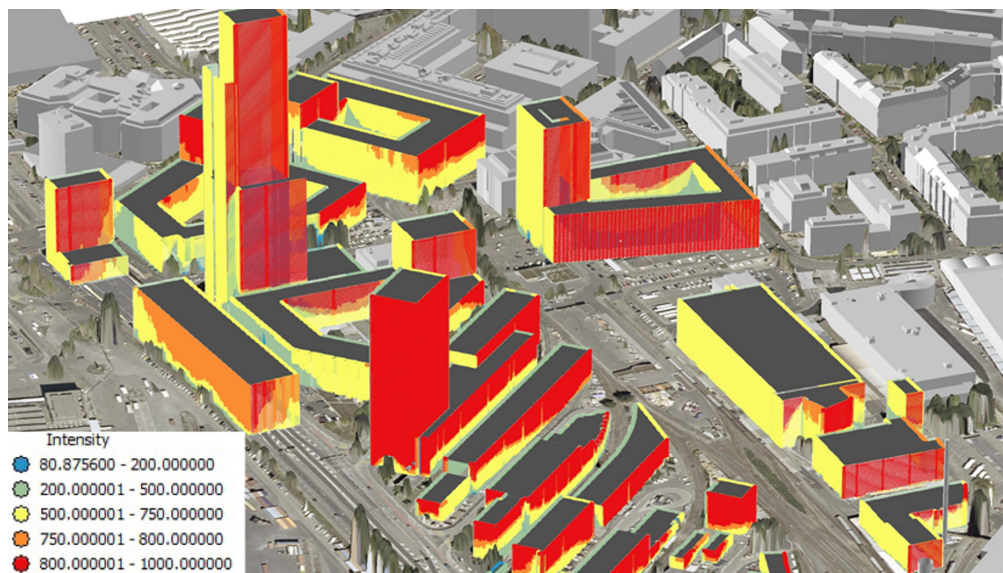

Simulation of solar radiation on facade on the new ND Grosselin in Carouge (Geneva)

## Used tools

The solar modelling used for the solar cadaster was developed around 2010 in collaboration between HEPIA (G. Desthieux), Politecnico di Milano (E. Morello) and EPFL Lausanne (C. Carneiro).

It is based on LiDAR data and 2.5D urban model (resolution of 0.5 m), weather hourly data (Meteonorm®) averaged by month in order to reduce computing time, solar geometry on typical days of the month (around 15th), and shadow casting adapted from Ratti for hourly shadow and sky view factor. Hay model is used for the diffuse component.

Computing time calculation is boosted used GPU techniques (see Stendaro, Desthieux et al., 2020, <https://doi.org/10.3390/app10155361>). The model is encoded in C and Cuda and is open.

The façade component is based on 'hyperpoint' genera-

tion along the façade using digital surface model (DSM), digital terrain model (DTM) and vector building cadastre. All the methodological background of solar radiation on roof and façade is well summarized in Desthieux et al., 2018 (link). The workflow of all the process is given below.

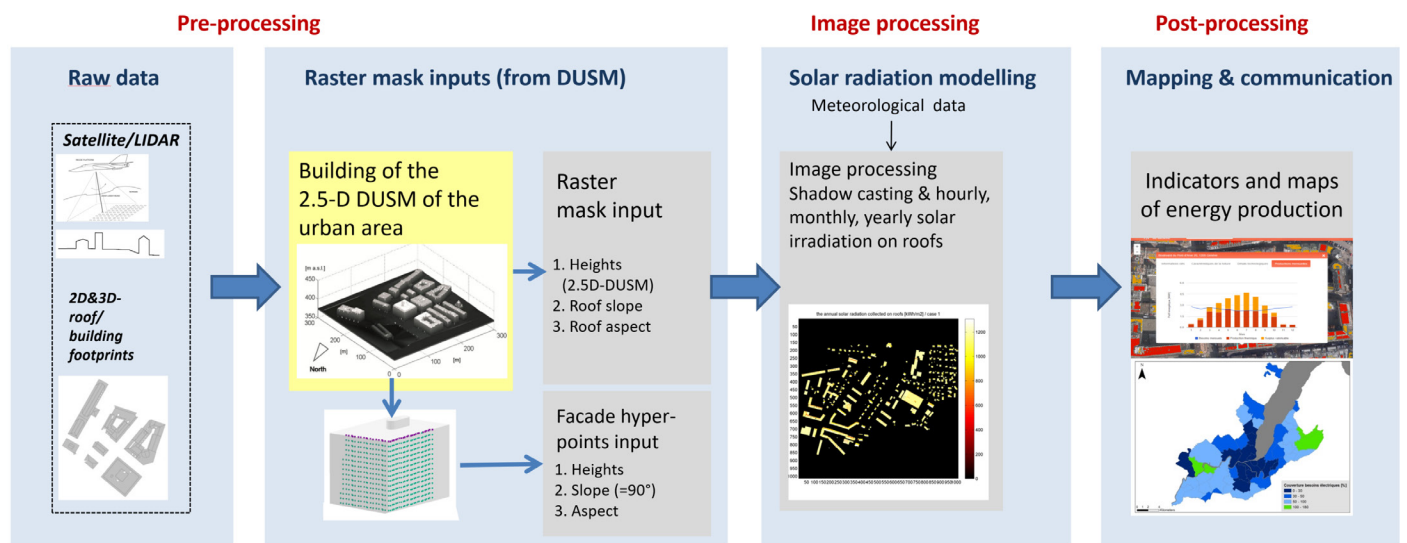

Workflow of the whole process of solar modelling on roofs and facades. Source: <https://doi.org/10.3390/app10155361>

## Challenges / Lessons learnt

The solar cadaster tool reveals to be reliable in general for processing a very large area (2000 m<sup>2</sup>) with high resolution (0.5 m) in rather low computing time (about 3 weeks). The reliability was demonstrated by different field studies. Benchmarking between the solar tool and specific simulation tools (Envimet, Rhino) is currently being done in the framework of G2 Solaire and IEA SHC Task 63. According to the first results, the output values from the solar cadaster tool are close to those of Envimet and Rhino on roof and facade (see chapter 5).

On the user side, the current evolution of the Web interface will help better target the optimum size of solar installation and thus better support decision aiding.

Authors of this workflow story: Gilles Desthieux

## 5 Comparative study of numerical tools

### DISCLAIMER

The work presented in this Chapter is also partly published in a similar form of a conference paper “A Comparative Study Of Simulation Tools To Model The Solar Irradiation On Building Façades”, authored by Martin Thebault, Jerome Kämpf, Giuseppe Peronato, Jouri KanTERS, Karine Bouty, Victor Guillot, Stephanie Giroux, Christophe Menezo, Matteo Formolli, Gilles Desthieux, Benjamin Govehovitch, Raphael Compagnon, Ellis Herman, Cyril Caliot, at the Solar World Congress 2021. Here, additional data and analyses are presented.

This chapter aims at illustrating difference between commonly used tools by analysing their performances, and their workflows. The focus is on the vertical surfaces (i.e., façades). The analysed tools have a large range of applications, from detailed microclimate studies to large-scale irradiation modelling. This comparative study consist of simulations analysing three conceptual urban designs. Two representative winter and summer days are defined. The results, obtained for the modelling of the shortwave irradiance received on the façades, are discussed together with the observed differences.

### 5.1 Methodology

To compare results obtained with the selected tools, different levels of complexity will be analysed. Three scenarios have been considered. The first scenario (i.e. Unshaded roof and Unshaded façade) considers the case of an unshaded building, while the second (i.e. Homogenous district) considers the case of a district with a regular distribution of same-size buildings and the final scenario (i.e. Heterogeneous district) the case of a more random distribution of buildings with different heights.

#### 5.1.1 Geometry

The homogeneous district presented in Figure 1 (a) is composed of three rows of three buildings. The buildings are of same height, and are aligned vertically and horizontally. The heterogeneous district is composed of buildings of various elevation sizes which are not aligned. Each of this district is composed of 9 buildings with a footprint of  $20 \times 20 \text{ m}^2$  each. Each building is composed of  $N_f$  floors, each floor being 3 m high. For example a building with  $N_f=5$  will be 15 m high. For each of these districts the focus will be on the central building, coloured in light red in Figure 1.

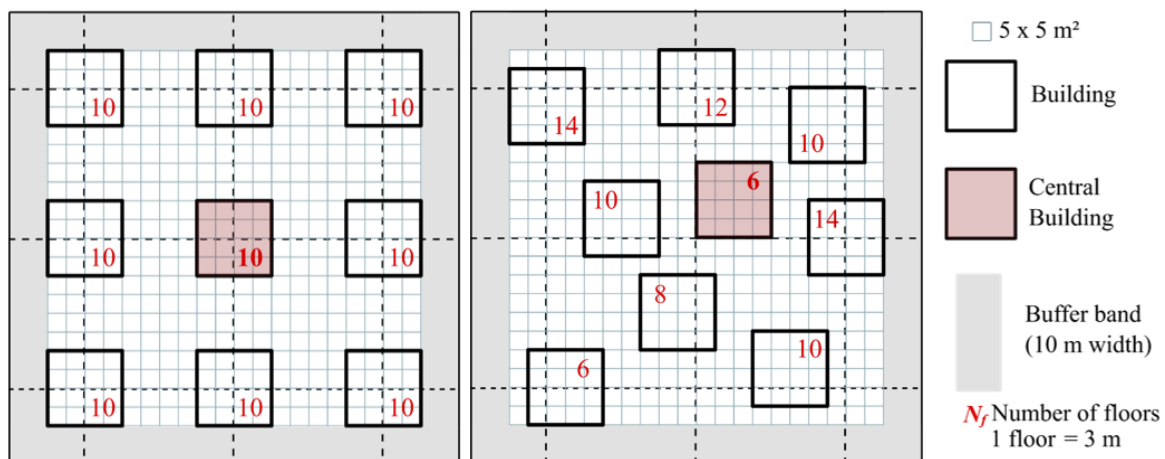

Figure 12 Geometry of (a) the homogeneous and (b) the heterogeneous districts. North is oriented upward.

Note that despite that these two districts have distinct geometries, they have been designed to share similar common urban form indicators (Natanian et al., 2019). These indicators are summarized in Table 15.

Table 15 Urban morphology indicators of the districts

Indicator	Definition	Value
Shape factor	Ratio between the building envelope surface to the building volume	0.23m <sup>-1</sup>
Floor area ratio	Ratio between the building gross floor area to the site area	2.5
Site Coverage	Ratio between the building footprint and the site area	0.25
Average Building Height	Average height (or rise of height) of buildings in an urban model (m).	30 m

## 5.1.2 Weather data

For the weather inputs, data from the Meteorom database corresponding to the location of Geneva, Switzerland (latitude: 46.2044° N, longitude: 6.1432° E), has been used. This database provides hourly data weather conditions (e.g., irradiation, wind speed, temperature, and humidity). The analyses were conducted on two days, one in August and one in February, corresponding to typical summer and winter conditions. The investigated days are obtained from an average of the weather conditions for the considered month. For example for weather input  $W$  (e.g. direct irradiation, wind speed, temperature), the monthly averaged weather inputs are obtained by:

$$W_m(h) = \frac{1}{N_m} \sum_{k=1}^{N_m} W_k(h)$$

where the subscript  $m$  corresponds to the considered month (here February or August),  $N_m$  corresponds to the number of days in the month and  $h$  is the hourly time step. Finally, the sun paths corresponding to the days of the 15th of February and the 16th of August will be considered as suggested by Klein (1977). The weather file contains the direct normal irradiance  $B_n$ , the horizontal sky diffuse irradiance  $D_h$  and the global horizontal irradiance  $G_h$ .

## 5.2 Tools

### 5.2.1 Summary of the considered tools and their main characteristics

Tool Name	Code access	Radiation method	Simulation Engine	Diffuse model
Solar Cadastre of Geneva (CaS)	Closed	Radiosity	Own Engine	Hay
CitySim (CiS)	Open	Radiosity	SRA	Perez
De Luminae (DL)	Closed	Ray-tracing	Radiance	Perez
Diva For Rhino (Diva)	Closed	Ray-tracing	Daysim	Perez
ENVI-met (EM)	Closed	Radiosity	Own engine	Isotropic
Honeybee (HB)	Open	Ray-tracing	Radiance	Perez
htrdr-ModRadUrb (ht)	Open	Monte-Carlo (Ray-tracing)	htrdr-0.6.1	Isotropic
IDAIce	Closed	Ray-tracing	Radiance	-
Indalux (Ind)	Open	Ray-tracing	Radiance	Perez
Ladybug (LB)	Open	Ray-tracing	Radiance	Perez
Solene Microclimat	Open	Radiosity	Own Engine (python)	Perez
Spacemaker (SP)	Closed	Ray-tracing	Own Engine	Simple Sandia Sky

### ***CadSol***

The Solar cadastre of Geneva is a geographic information system (GIS) originally created at the Haute école du Paysage d'Ingénierie et d'Architecture de Genève (Hepia), and further developed through different projects as it is now within the G2Solaire, INTERREG V project. This tool provides an estimate of the irradiation received on the roofs of the Greater Geneva agglomeration (2000 km<sup>2</sup>). A detailed presentation of the tool can be found in Desthieux et al. (2018).

### ***CitySim***

CitySim was initially developed at EPFL (the Swiss Federal Institute of Technology in Lausanne) and the solver is currently maintained and further developed as an open-source tool at the Idiap Research Institute. A Graphical User Interface (CitySim Pro) is released as commercial software by Kaemco LLC. CitySim is a complete tool for dynamic urban energy simulation, including solar potential, building energy demand, district heating networks and outdoor comfort. For solar radiation, it includes the Simplified Radiosity Algorithm by Robinson & Stone (2005) and the Perez All-Weather model for the sky radiance distribution.

### ***DL-Light***

DL-Light is the software suite developed by De Luminæ to help the evaluation of the intake and distribution of natural light in architectural and urban spaces. It is based on Radiance (De Luminae, 2021).

### ***Diva***

DIVA-for-Rhino is a highly optimised daylighting and energy modelling plug-in for Rhinoceros. This software uses ray-tracing and light-backwards algorithms based on the physical behaviour of light in a 3D volumetric model. For hourly solar radiation, the Daysim interface is used (Reinhart & Walkenhorst, 2001).

### ***ENVI-met***

ENVI-met is a software aiming at simulating the urban microclimate by taking into consideration all the complex phenomena that occur in an urban environment. It is based on coupled balance equations (including those of mass, momentum, and energy). This involves taking the built and natural environment into account (Simon et al., 2021).

### ***htrdr***

htrdr-ModRadUrb is a numerical tool developed from the free and open-source software htrdr-0.6.1 (ADEME, 2021) that implements a Backward Monte-Carlo algorithm to compute longwave or shortwave radiative intensities in urban geometry by solving the monochromatic radiative transfer equation in the semi-transparent atmosphere with Lambertian or specular surfaces. The htrdr-ModRadUrb tool used for this specific study includes a uniform and isotropic model of the sky for the computation of shortwave radiative fluxes as well as grey and Lambertian surfaces. A Lambertian surface is an ideal matte or diffusely reflecting surface.

### ***HoneyBee***

Honeybee is an open-source plug-in part of the Ladybug Tools, working inside visual programming environments such as Grasshopper and Dynamo. It supports detailed daylight and solar irradiation simulations using Radiance and energy simulations using EnergyPlus and OpenStudio (Sadeghipour Roudsari & Pak, 2013). The study was performed using the improved two-phase Radiance method, available in the Honeybee [+] version of the plug-in.

### ***IDAice***

IDA ICE is a whole-year detailed and dynamic multi-zone simulation application for study of thermal indoor climate as well as the energy consumption of the entire building.

### ***Indalux***

INDALUX is an open-source software package using RADIANCE as a calculation engine to produce particular images characterizing the urban fabric and sky radiance distributions. Various numerical indicators characterising the access to solar radiation (e.g. solar irradiation) and daylight in urban areas can be visually estimated or precisely calculated by overlaying these particular images (Raphaël Compagnon & Chatzipoulka, 2018).

### ***Ladybug***

Ladybug provides climate graphics based on weather files and supports solar radiation studies, view analyses, and sunlight-hours modelling. It is embedded within the visual programming language environment Grasshopper, linked to Rhino3D (Sadeghipour Roudsari & Pak, 2013).

### Spacemaker

Spacemaker’s photovoltaic analysis is a prototype and is still under active development. However, it will be available to users in a Beta release in the Spacemaker product soon. The photovoltaic analysis uses local solar radiation data and Spacemaker’s sun analysis to give users the ability to see the potential of their site for solar panel energy generation at the early phases of design (Spacemaker, 2021).

### Solene-Microclimat

The Solene-Microclimat model has been developed to investigate the consequences of urban context on local microclimate and indoor thermal conditions. It is dedicated to modeling urban microclimate and building thermal behavior at the district scale. The district’s geometry can be discretized with triangular meshes making it possible to get a simulation close the 3D realistic urban form. Among the capacities of this tool, it can calculate the radiation exchanges between the urban surfaces and with the sky vault.

## 3.3.1. Workflows

In this section, workflows describing the process of simulation are described for several of the used tools.

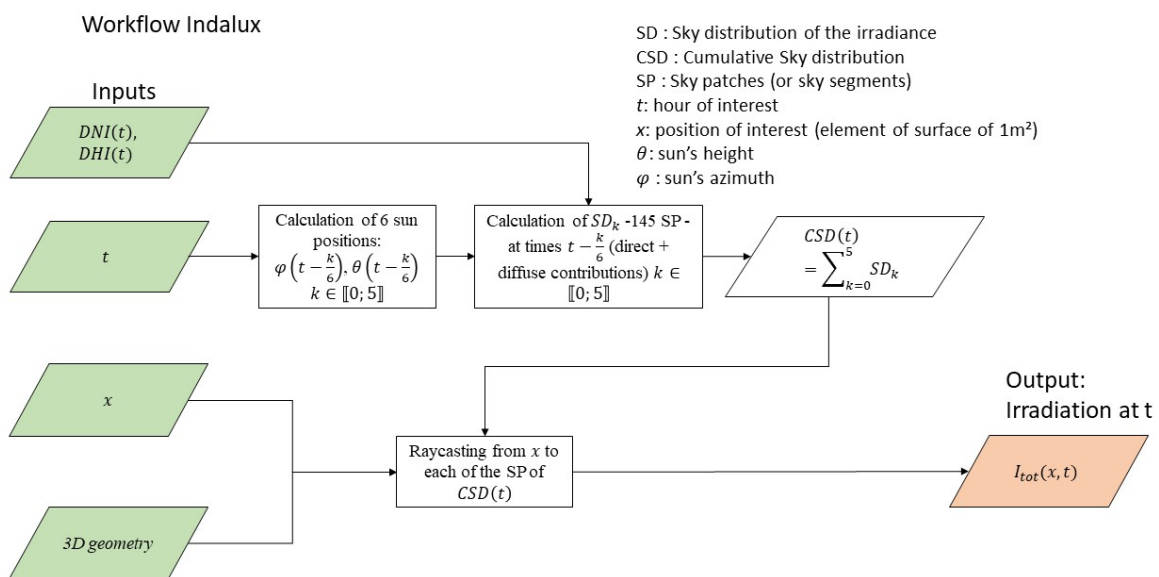

Figure 13 Workflow of Indalux



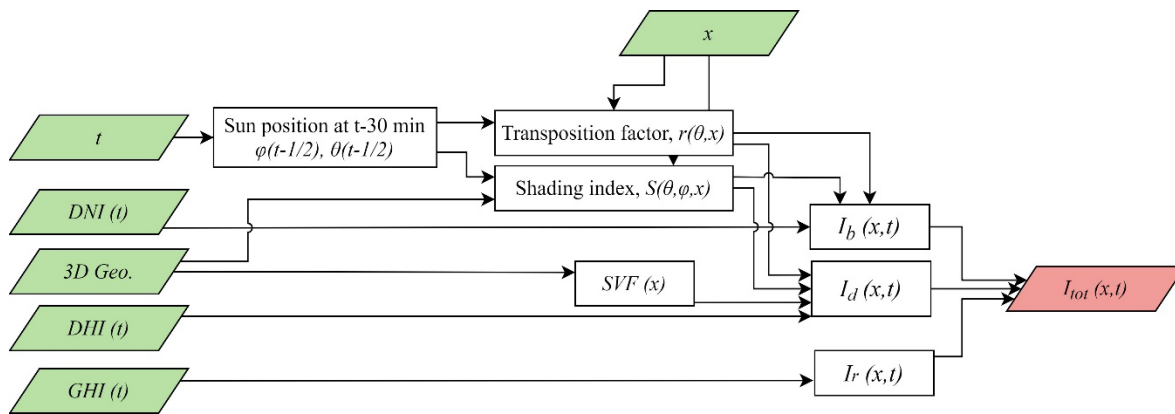

Figure 14 Workflow of the Solar Cadastre of Geneva

The detailed workflow highlights some significant differences that exist between the tools. The green elements represent the inputs (weather, geometry, spatial and temporal resolutions) as defined in the instructions. The output required is here the hourly irradiation on the façades ( $I_{tot}$ ). One of the main differences is the presence of a sub-hourly evaluation of the irradiance for Indalux. Indeed, for each hour, Indalux evaluates the sun position at six different positions within the hour (approximately every 10 min, with a random noise to avoid alignment effect).

### 3.4. Results

To compare results obtained with the different tools, various levels of complexity will be analysed. First, we will consider the case of an unshaded building, then the case of a homogeneous district and finally the case of a more random distribution of buildings.

#### 3.4.1. Cumulative Energy

The cumulated energy for each façade and each tool for the 15<sup>th</sup> of February, homogeneous district were reported in Table 16. Variations for the (unshaded) roof are relatively low, with a maximum difference of 7%. This relative difference can reach up to 134% on the north façade with values between 20 and 30 % for east, south, and west façades. However, these differences are nearly twice lower when considering the second order maximum difference which shows that this maximum difference may not be the most representative indicator of the dataset.

Table 16. Cumulative solar energy received on façades, case of the 15<sup>th</sup> of February, homogeneous district. For each façade, the maximum value is highlighted in red, and the minimum in blue

	East	West	North	Roof	South
CadSol	950	742	353	1986	1554
Envimet	784	707	377	1992	1261
Diva	794	747	322	1949	1509
LadyBug	735	677	217	1962	1484
CitySim	845	792	367	1973	1611
Indalux	855	797	366	1958	1569
HoneyBee	877	710	302	1967	1561
DeLuminae	864	806	367	1964	1599
htrdr	835	739	462	1972	1315
Spacemaker	777	823	507	1856	1345
Solene microclimat	666	863	249	1991	1574
IDA Ice	949	867	464	1949	1665
Relative maximum difference (%)	43	27	134	7	28
Second order maximum difference (%)*	19	16	86	2	22
Absolute maximum difference (Wh)	284	186	290	136	349

\* Defined as the relative difference between the second largest and second smallest values.

### 3.4.2. Unshaded roof

Unlike the geometry presented in Figure 12, the building considered in this section has no adjacent buildings around it and, therefore, is not subject to any shadings or reflection from the surrounding built environment, except those from the ground. Hence, these results can be used as a reference to assess the impact of the surrounding geometry on the received solar irradiation. The hourly solar irradiation received on the flat roof in the case of an isolated building is presented for the day of February in Figure 15.

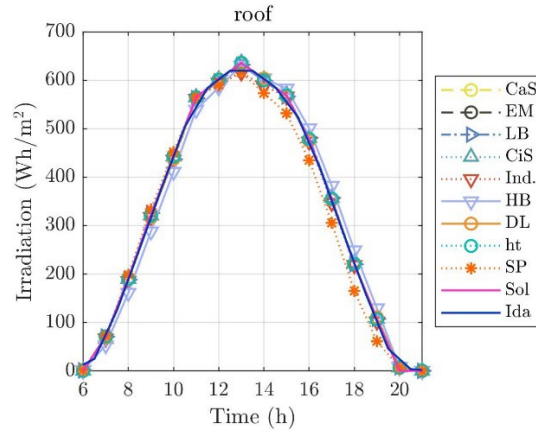

Figure 15 Hourly irradiation received on the roof in February

Here all the tools provide similar results. This is expected since in the present case the surface of interest is horizontal without any shadings or potential solar reflections. Therefore, the results should be almost identical to the global horizontal radiation ( $G_h$ ) provided in the weather file. However, it can be observed that results are non-identical. This is mostly due to how each tool handles the input information. Indeed, based on the .epw data dictionary (NREL, 2021), the meteorological quantity provided at the hour  $h$  corresponds to the integral/average of this quantity over the previous hour. To account for this, some tools shift the sun position by approximately 30 min before the required hour. Consequently, for a result at hour  $h$ , the sun position at  $h-30\text{min}$  is sometimes used. However, unless we have total access to the source code, it is sometimes difficult to know whether this shift is done or not in the tool. Furthermore, this correction can be relevant with epw files, but it may not be relevant for other input files.

### 3.4.3. Unshaded facades

The irradiation on the North, West and South façades for the unshaded case in February is presented in Figure 16. Here it can be observed that the results on the North façades are relatively more sensitive with differences that can reach more than 100% at 1.00 p.m. However, this only represents an absolute difference of  $60\text{Wh/m}^2$ . Given that there is no direct sun on this façade, the observed differences will mainly come from the diffuse model and the reflections. For example, for the present simulations, htrdr used intentionally an isotropic sky which results in a higher predicted irradiation on the North and a lower value on the southern façade. On the other hand, the LB tool does not consider reflections, which results in a lower prediction of the solar irradiation. On the southern façades, differences by up to  $150\text{Wh/m}^2$  are observed at 2.00 p.m., which corresponds here to a relative difference of 50%.

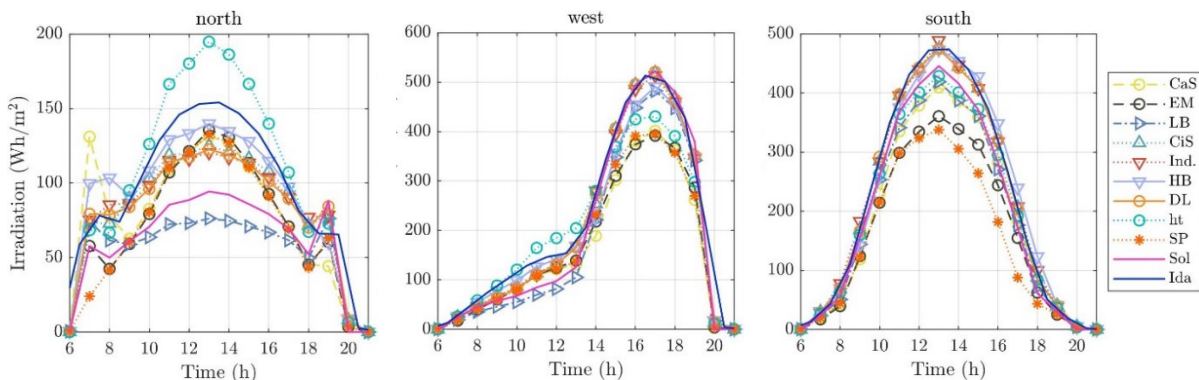

Figure 16: North, West and South façades for the unshaded case in February

### 3.4.4. Homogeneous district

The spatially averaged hourly irradiation received on the southern façade for the homogeneous district is shown in Figure 17 for February (left) and August (right).

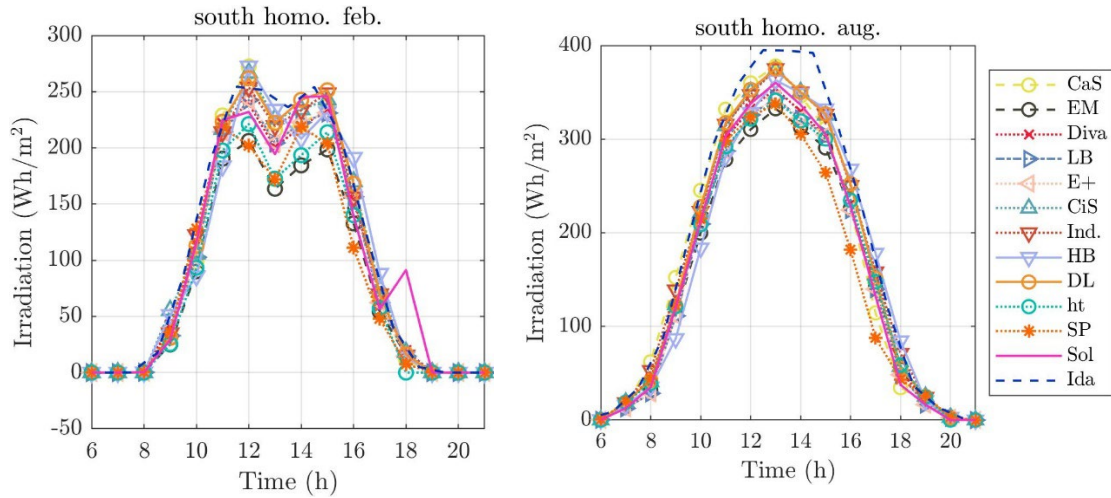

Figure 17: Irradiation on the southern face of the homogeneous district (left) February, (right) August

The impact of surrounding buildings can be seen in February since they generate a 'double hump' shape around 1.00 p.m. A maximum absolute difference of 100 Wh/m<sup>2</sup> is observed at 1.00 p.m. This represents a relative difference of 43% which is less than the maximum relative difference observed in the unshaded case.

### 3.4.5. Heterogeneous district

For the heterogeneous district (Figure 18) the predictions of the different tools are once again in good agreement. However, in winter, the solar irradiation is more sensitive to the district because of the lower position of the sun. Despite the relatively good agreement, the peaks (minimum or maximum values) are not predicted at the same time. For example, according to SP or Indalux the minimum during the day is reached at 10 a.m. whereas CaS or HB predict it the next hour. Similarly, the second peak is not predicted at the same time by all the tools. Finally, it can also be seen that in this more complex scenario, there is no tool that either provides maximum or minimum results for all timesteps compared to the other tools. For example, at 1.00 p.m., SP provides the maximum predicted irradiation, whereas at 2.00 p.m. and 3.00 p.m. it is respectively CaS and HB that predict the highest irradiation.

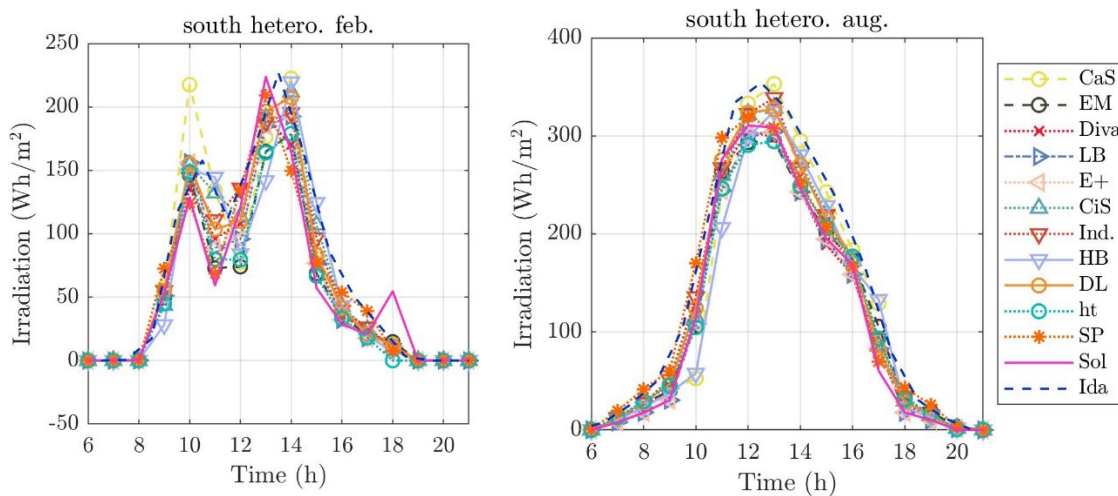

Figure 18 Irradiation on the southern face of the heterogeneous district (left) February, (right) August

### 3.4.6. Prediction variability

To better assess the variation of the results, we define here the variation of hourly irradiation  $I(h)$  of the  $k^{ith}$  tool by:

$$I'_k(h) = I_k(h) - \frac{1}{N_T} \sum_{n=1}^{N_T} I_n(h)$$

$N_T$  being the number of investigated tools here  $N_T = 10$ .

The daily evolution of the distribution of  $I'_k(h)$  is plotted in Figure 19 for the West façade for the four different scenarios (February, August, homogeneous/heterogeneous). Here the minimum and maximum values of  $I'_k(h)$  (defined as  $\min/\max(I'_k(h), k \in N_T)$ ) as well as the 25th and 75th percentile of  $I'_k(h)$  are plotted. It can be observed that the difference between the maximum and minimum predicted value can be significant, up to  $150 \text{ Wh/m}^2$ . This represents the largest deviation observed in the results.

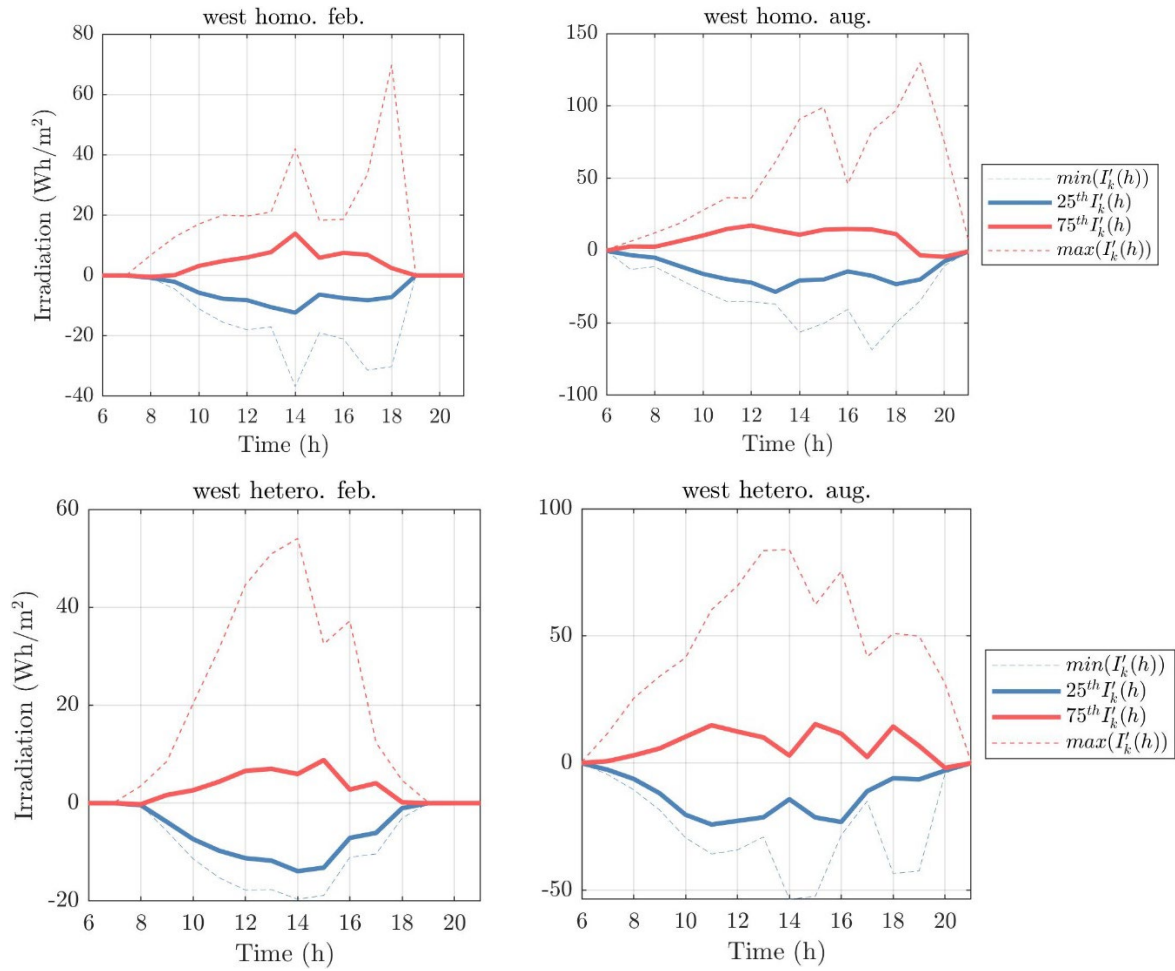

Figure 19: Evolution of the variation of  $I'_k(h)$  during the day for the West façade in the four different scenarios.

To have a better overview of the variations in the irradiation for all tested configurations, we define a global indicator called the deviation intensity (DI). It is defined here as:

$$DI = \frac{\sum_{h=1}^{24} \sqrt{\sum_{n=1}^{N_t} I'_k(h)^2}}{\sum_{h=1}^{24} \sum_{n=1}^{N_t} I_k(h)},$$

which can be seen as the daily average of the standard deviation divided by the daily average of the tool-averaged irradiation. This allows scaling the standard deviation by the mean daily irradiation which provides a better insight into the variability between the results.

Table 17. *DI values for the different periods and scenarios*

Period of analysis	February			August		
Scenario	unshaded	homo.	hetero.	unshaded	homo.	hetero.
<b>East</b>	17.4 %	14.0 %	37.0 %	17.5 %	14.5 %	33.0 %
<b>West</b>	14.1 %	12.9 %	49.0 %	13.5 %	18.1 %	38.7 %
<b>North</b>	17.6 %	26.0 %	46.4 %	24.3 %	36.0 %	45.5 %
<b>Roof</b>	3.4 %	3.4 %	8.3 %	3.0 %	3.0 %	8.4 %
<b>South</b>	14.2 %	10.7 %	16.8 %	13.8 %	7.9 %	10.0 %

For the day of February, it should be noted that, except for the North façade, the *DI* is lower for the homogeneous district than for the unshaded building. These results might seem slightly counter-intuitive since by increasing the complexity of the geometry, i.e., by adding buildings to the district, one would expect a higher diversity in the results. In August there are no special trends since, in the homogeneous district, the *DI* is higher for the North and West façade, whereas it is less for the South and East façade.

However, for both the investigated days, the *DI* is significantly higher in the heterogeneous district. This could be explained by two factors:

- The geometry is relatively random, without any symmetries, therefore increasing the complexity of the shadow castings.
- The analysed building (i.e. central building in the heterogeneous district) is small compared to its neighbours. As a result, it is highly shaded by the other buildings. In this case, the impact of the modelling of the reflection and the diffuse components are predominant.

### 3.4.7. Façade Mapping

One of the issues with the spatial averaging performed for previous figures is that it can erase or smooth some behaviours. To have a better idea of the difference between the tools, the distribution of the irradiation on the façade can be studied. This is illustrated in Figure 20 with the East façade of the homogeneous district in February. The three rows respectively correspond to 9.00 a.m., 10.00 a.m. and 11.00 a.m. As mentioned in sections The façade is 30-m high and 20-m long, and the spatial resolution is 1 m<sup>2</sup>.

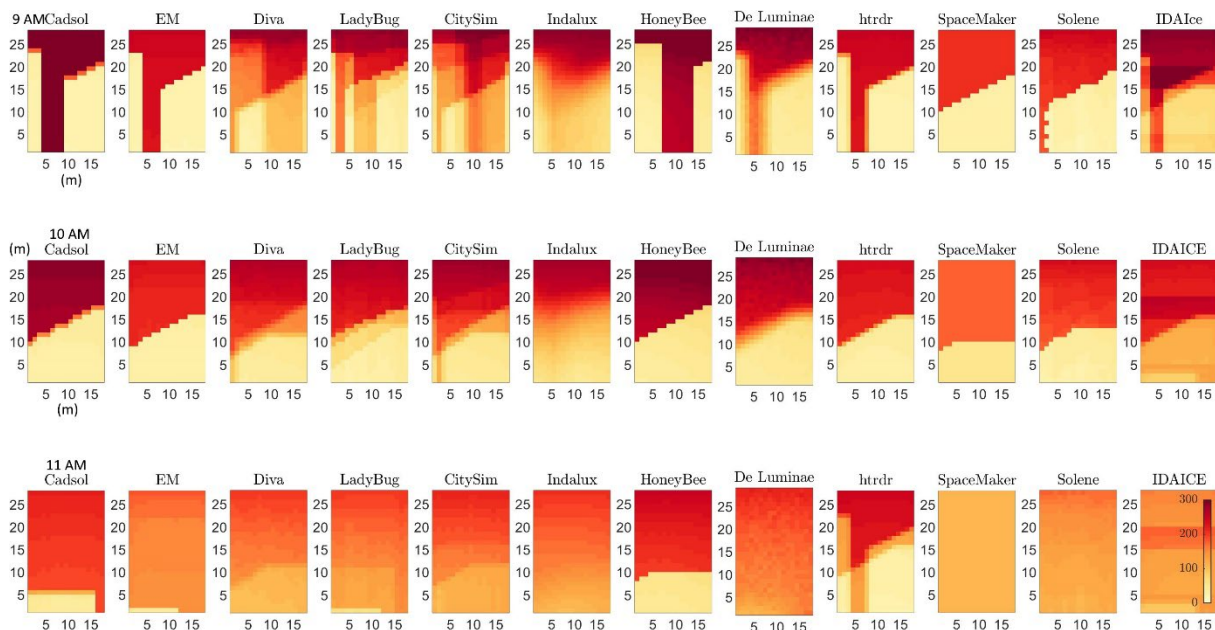

Figure 20: *Distribution of the irradiation at 9.00, 10.00 et 11.00 a.m. (1st, 2nd and 3rd lines). Case of the East façade of the homogeneous district in February. The colour scale, ranges from 0 to 300 Wh/m<sup>2</sup>, displays the hourly irradiation (in Wh/m<sup>2</sup>).*

First, it can be observed that all tools provide a different distribution of irradiance. Nevertheless, some common features are visible:

- Some tools predict a sharp distribution of solar irradiance. It is here the case of Spacemaker, htrdr, HoneyBee, CadSol and ENVI-met. Indeed, for these tools, it is possible to visualize and localize which parts of the building envelope (façades and roof) are hit by the direct component at the evaluated hour.

However, even between these tools, differences in the shape occur. This is due to a difference in the sun position. Indeed, depending on when within the hour the sun position is evaluated, the distribution of the direct radiation on the façade is impacted. This is particularly striking when comparing HB, htrdr and SP. Considering the results at 10.00 a.m., htrdr evaluates the sun position 30 min behind the required hour, therefore at 9.30 a.m. Based on that, the shape of the irradiance distributions, suggests that HB evaluates the sun position at a later time, here maybe at 10.00 a.m., whereas SP evaluates it an earlier time, maybe at 9.00 a.m.

- A more continuous spatial distribution is observed in Indalux. The reason for this is that Indalux proceeds to a sub-hourly evaluation of the sun path at six intermediate positions within the hour. From this, six distributions of solar irradiances are calculated and averaged to provide the final hourly outcomes.
- It is interesting to observe that there are no significant differences in the distribution of the solar irradiation between tools using radiosity methods (e.g. Cadsol, CitySim, ENVI-met) from those using a ray-tracing approach (htrdr, HB, Diva). However, for all tools, reflections were diffuse. Introducing specular reflections (by adding glass walls for example), could have provided another outcome since classic radiosity approaches cannot account for the incidence angle (and therefore the specular reflections).

---

## 6 Discussion and Conclusions

---

In this report, data is gathered on the current state-of-the-art of tools for solar neighborhoods through a literature review, an analysis of National Common Indicators, and Workflow Stories (a model describing a specific design and / or planning project showcasing how tools were used during this process).

### National Common indicators

National Common Indicators or NCIs, indicators measuring the performance of a solar neighborhood, have been gathered through the participation of the Task experts of the participating countries. In general, it can be concluded that:

- I. In the European Union member states, there is an extensive range of different NCIs. However, there is a development towards more (advanced) climate-based Common Indicators (Performance Indicators) and legislations for daylight, direct solar access, view out and visual comfort. An example is the new European norm EN 17037 that proposes a new norm how to assess good day- and sunlight access in buildings. The new norm will make the legislation on daylight and solar energy-related indicators more coherent with the EU. The focus of the new EN 17037 is however mainly on daylight in buildings and does not specify anything on daylight and solar access outdoors.
- II. Much of the legislation is based on day- and sunlight availability around the solstices (~21 December, 21 June) and equinoxes (21 March / September).
- III. Overall, there is hardly any legislation on (direct) solar access or other related indicators for outdoor environments.
- IV. As far as this report has shown, only Switzerland has legal requirements on the installation of active solar energy production for new buildings.
- V. There can be big differences of day- and sunlight access requirements between countries even though they have very similar geographic conditions.
- VI. At a similar latitude, different thresholds and definition of a same indicator can lead to significant differences of urban and building designs.
- VII. Daylight and Solar access can be conflicting with thermal indoor comfort. However, in the legislation, there are very few indoor thermal comfort indicators.

### Tools overview and Workflow stories:

In the workflow stories section in this report, experts have gathered interesting examples of projects and / or workflows where tools have played an important role.

Although the sample is low, it can be concluded from the workflow stories that tools within the visual programming environments are extensively used in the industry and academics and that there are not many examples of GIS tools that are able to provide the same assessment possibilities.

From the workflow stories, CAD & BIM environments seem to be the most common choice as modelling environment when designing new neighborhoods. Combined with the possibilities of a visual programming language like Grasshopper, advanced daylight and solar energy analyses have become closer to the tool workflow of architects. Another clear benefit is that in most cases, only one model has to be constructed for multiple types of analyses. However, data handling for larger neighborhoods in those environments can still be a challenge. Therefore, GIS is the common tool of choice for existing buildings and larger neighborhoods, but it might be difficult to convert the geometry to a fitting format. Also, data handling processes are more advanced.

The field of advanced simulation is evolving quickly and will be influenced by Artificial Intelligence and Machine Learning enabling to run quicker, more advanced analyses for larger neighborhoods.

For an optimal solar neighborhood design, a district should be planned considering not only the district itself, but also how it could complement other districts or the entire city. Whereas GIS enables to work at such scale, the resolution (spatial, temporal, LOD) is usually much coarser than this reached by district scale tools. It would therefore be relevant to identify possibilities to work with high definition tools.

### Comparative study of numerical tools

This study shows a critical comparison of the results obtained with some popular simulation tools for urban solar radiation studies. In total ten tools were studied for three scenarios, an isolated building (Unshaded), a building in an aligned district (Homogeneous), and a building in a more random district (Heterogeneous). Each tool simulated the hourly solar irradiation on the envelope (façades and roof), for two representative days, one in August and the



other in February.

- One of the striking points of this study is that, for similar input conditions and standard inputs, there are as many different results as tools. However, it should be noted that, despite using the same settings, the instructions sent to the contributors (and co-authors) did not specify an explicit sun position for each hour, which led to possible differences in dealing with the input parameters, notably due to the consideration of the hourly weather data as instantaneous or time-integrated values.
- There are small variations between the tools' outcomes when predicting the solar irradiation received on an unobstructed flat roof. However, predicted solar irradiation can largely vary for the façade, by up to 150 Wh/m<sup>2</sup> in the present case (40% in relative error).
- No single tool constantly over- or under-estimates hourly spatially-aggregated results with respect to the other tools. In principle, this would suggest lower deviations if results were integrated over larger time scales.
- When comparing the relative difference of the mean solar irradiation there are no significant differences in the tools' results between the unshaded and the homogeneous scenarios. However, the deviation in the predicted irradiation significantly increases in the heterogeneous district. The reason is that the heterogeneous district is more complex, and the studied building in this scenario is smaller than its neighbours, and therefore subject to more shading.
- In some specific cases, explanations have been found to observed differences in the predicted solar irradiation (i.e. time at which the sun position is calculated, type of diffuse model, absence of reflection). However, some differences and behaviours remain unexplained, as this would require a more thorough analysis of the backend simulation engine/source code of each tool.

This work finally highlights that, depending on the tool and settings that are used, unneglectable deviations in the hourly results can be expected, especially for complex geometry.

---

## 7 Acknowledgements

---

The authors thank their respective funding agencies for supporting their work:

- APVI Knowledge Sharing Small Project Grant through funding support from Australian Renewable Energy Agency (ARENA) as part of ARENA's International Engagement Program (Mark Snow)
- Swedish Energy Agency (Nicholas Baker, Rafael Campamà Pizarro, Agnieszka Czachura, Jouri Kanters, Maria Wall, and Viktor Sjöberg)
- European Union's Horizon 2020 (Giuseppe Peronato: grant agreement N°884161)
- The Research Council of Norway (project no. 257660 FME ZEN (Johannes Brozovsky) & project no. 324243 HELIOS) (Matteo Formolli)
- French National Research Agency, ANR-18-EURE-0016 - Solar Academy (Christophe Ménézo, Alessia Boccalate, Karine Bouty, Martin Thebault)
- INTERREG V Suisse-France G2Solaire (Gilles Desthieux, Victor Guillot, Stéphanie Giroux-Julien, Christophe Ménézo, Benjamin Govehovitch, Alessia Boccalate, Karine Bouty, Martin Thebault)
- Faculty of Engineering and Architectural Science, Ryerson University\* (name change in progress) (Javeriya Hassan, Miljana Horvat)

---

## 8 References

---

- Abanda, F. H., Sibilla, M., Garstecki, P., & Anteneh, B. M. (2021). A literature review on BIM for cities Distributed Renewable and Interactive Energy Systems. *International Journal of Urban Sustainable Development*, 1–19. <https://doi.org/10.1080/19463138.2020.1865971>
- ADEME. (2021). *htrdr - the Monte-Carlo radiative transfert simulator*.
- Ali, U., Shamsi, M. H., Bohacek, M., Purcell, K., Hoare, C., Mangina, E., & O'Donnell, J. (2020). A data-driven approach for multi-scale GIS-based building energy modeling for analysis, planning and support decision making. *Applied Energy*, 279, 115834.
- Andriamamonjy, A., Saelens, D., & Klein, R. (2019). A combined scientometric and conventional literature review to grasp the entire BIM knowledge and its integration with energy simulation. *Journal of Building Engineering*, 22, 513–527. <https://doi.org/https://doi.org/10.1016/j.jobe.2018.12.021>
- Arsano, A. Y., & Reinhart, C. (2021). *ClimaPlus Beta*.
- Biljecki, Filip, Ledoux, H., & Stoter, J. (2016). An improved LOD specification for 3D building models. -, *Accepted m*. [https://filipbiljecki.com/publications/2016\\_ceus\\_improved\\_lod.pdf](https://filipbiljecki.com/publications/2016_ceus_improved_lod.pdf)
- Boccalatte, A., Fossa, M., & Ménézo, C. (2020). Best arrangement of BIPV surfaces for future NZEB districts while considering urban heat island effects and the reduction of reflected radiation from solar façades. *Renewable Energy*, 160, 686–697. <https://doi.org/https://doi.org/10.1016/j.renene.2020.07.057>
- Bouyer, J., Musy, M., Huang, Y., & Athamena, K. (2011). *Mitigating Urban Heat Island Effect by Urban Design: Forms and Materials* (pp. 164–181).
- EN 17037. Daylight of buildings, (2017).
- Chatzipoulka, C., Compagnon, R., Kaempf, J., & Nikolopoulou, M. (2018). Sky view factor as predictor of solar availability on building façades. *Solar Energy*, 170, 1026–1038. <https://doi.org/https://doi.org/10.1016/j.solener.2018.06.028>
- Ciocia, A., Amato, A., Di Leo, P., Fichera, S., Malgaroli, G., Spertino, F., & Tzanova, S. (2021). Self-Consumption and self-sufficiency in photovoltaic systems: Effect of grid limitation and storage installation. *Energies*, 14(6), 1591.
- Compagnon, R. (2004). Solar and daylight availability in the urban fabric. *Energy and Buildings*, 36(4), 321–328. <https://doi.org/https://doi.org/10.1016/j.enbuild.2004.01.009>
- Compagnon, Raphaël, & Chatzipoulka, C. (2018). *A Simple Tool for Assessing Solar and Daylight Access in Urban Canyons* (E. 2018 (ed.)).
- De Luca, F., Naboni, E., & Lobaccaro, G. (2021). Tall buildings cluster form rationalization in a Nordic climate by factoring in indoor-outdoor comfort and energy. *Energy and Buildings*, 238, 110831. <https://doi.org/https://doi.org/10.1016/j.enbuild.2021.110831>
- De Luminae. (2021). *DL-LIGHT*.
- Desthieux, G., Carneiro, C., Camponovo, R., Ineichen, P., Morello, E., Boulmier, A., Abdennadher, N., Dervey, S., & Ellert, C. (2018). Solar Energy Potential Assessment on Rooftops and Facades in Large Built Environments Based on LiDAR Data, Image Processing, and Cloud Computing. Methodological Background, Application, and Validation in Geneva (Solar Cadaster) . In *Frontiers in Built Environment* (Vol. 4, p. 14). <https://www.frontiersin.org/article/10.3389/fbuil.2018.00014>
- Desthieux, G., Carneiro, C., Camponovo, R., Ineichen, P., Morello, E., Boulmier, A., Abdennadher, N., Dervey, S., Ellert, C., Ratti, C., Baker, N., Steemers, K., Florio, P., Munari Probst, M. C., Schüler, A., Roecker, C., & Scartezzini, J.-L. (2018). Solar Energy Potential Assessment on Rooftops and Facades in Large Built Environments Based on LiDAR Data, Image Processing, and Cloud Computing. Methodological Background, Application, and Validation in Geneva (Solar Cadaster) . *Frontiers in Built Environment* , 4(7), 762–776. <https://doi.org/https://doi.org/10.1016/j.enbuild.2004.10.010>

- Dirksen, M., Ronda, R. J., Theeuwes, N. E., & Pagani, G. A. (2019). Sky view factor calculations and its application in urban heat island studies. *Urban Climate*, 30, 100498. <https://doi.org/https://doi.org/10.1016/j.uclim.2019.100498>
- Dogan, T., Reinhart, C., & Michalatos, P. (2012). *Urban Daylight simulation Calculating the daylit area of urban designs*.
- Eriksson, H., & Harrie, L. (2021). Versioning of 3D City Models for Municipality Applications: Needs, Obstacles and Recommendations. *ISPRS International Journal of Geo-Information*, 10(2), 55. <https://doi.org/10.3390/ijgi10020055>
- Florio, P., Munari Probst, M. C., Schüler, A., Roecker, C., & Scartezzini, J.-L. (2018). Assessing visibility in multi-scale urban planning: A contribution to a method enhancing social acceptability of solar energy in cities. *Solar Energy*, 173, 97–109. <https://doi.org/https://doi.org/10.1016/j.solener.2018.07.059>
- Florio, P., Peronato, G., Perera, A. T. D., Di Blasi, A., Poon, K. H., & Kämpf, J. H. (2021). Designing and assessing solar energy neighborhoods from visual impact. *Sustainable Cities and Society*, 71, 102959.
- Freitas, S., Catita, C., Redweik, P., & Brito, M. C. (2015). Modelling solar potential in the urban environment: State-of-the-art review. *Renewable and Sustainable Energy Reviews*, 41, 915–931. <https://doi.org/https://doi.org/10.1016/j.rser.2014.08.060>
- Greco, S., Figueira, J., & Ehrgott, M. (2016). *Multiple criteria decision analysis* (Vol. 37). Springer.
- GRIMMOND, S. U. E. (2007). Urbanization and global environmental change: local effects of urban warming. *The Geographical Journal*, 173(1), 83–88. [https://doi.org/https://doi.org/10.1111/j.1475-4959.2007.232\\_3.x](https://doi.org/https://doi.org/10.1111/j.1475-4959.2007.232_3.x)
- Gupta, R., Pena-Bello, A., Streicher, K. N., Roduner, C., Farhat, Y., Thöni, D., Patel, M. K., & Parra, D. (2021). Spatial analysis of distribution grid capacity and costs to enable massive deployment of PV, electric mobility and electric heating. *Applied Energy*, 287, 116504.
- Iversen, A., Roy, N., Hvass, M., Jørgensen, M., Christoffersen, J., Osterhaus, W., & Johnsen, K. (2013). *Daylight calculations in practice: An investigation of the ability of nine daylight simulation programs to calculate the daylight factor in five typical rooms*.
- Jakica, N. (2017). State-of-the-art review of solar design tools and methods for assessing daylighting and solar potential for building-integrated photovoltaics. *Renewable and Sustainable Energy Reviews*. <https://doi.org/10.1016/j.rser.2017.05.080>
- Jakubiec, J. A., & Reinhart, C. F. (2013). A method for predicting city-wide electricity gains from photovoltaic panels based on LiDAR and GIS data combined with hourly Daysim simulations. *Solar Energy*, 93, 127–143. <https://doi.org/10.1016/j.solener.2013.03.022>
- Kanters, J., Dubois, M.-C., & Wall, M. (2013). Architects' design process in solar-integrated architecture in Sweden. *Architectural Science Review*, 56(2), 141–151. <https://doi.org/10.1080/00038628.2012.681031>
- Kanters, J., & Wall, M. (2016). A planning process map for solar buildings in urban environments. In *Renewable and Sustainable Energy Reviews* (Vol. 57, pp. 173–185). Elsevier Ltd.
- Kanters, J., Wall, M., & Kjellsson, E. (2014). The solar map as a knowledge base for solar energy use. *Energy Procedia*, 48, 1597–1606.
- Klein, S. A. (1977). Calculation of monthly average insolation on tilted surfaces. *Solar Energy*, 19(4), 325–329.
- Kosorić, V., Lau, S.-K., Tablada, A., & Lau, S. S.-Y. (2018). General model of Photovoltaic (PV) integration into existing public high-rise residential buildings in Singapore—Challenges and benefits. *Renewable and Sustainable Energy Reviews*, 91, 70–89.
- Larson, G. W., & Shakespeare, R. (1998). *Rendering with Radiance : the art and science of lighting visualization*. Morgan Kaufmann.
- Lauzet, N., Rodler, A., Musy, M., Azam, M.-H., Guernouti, S., Mauree, D., & Colinart, T. (2019). How building energy models take the local climate into account in an urban context—A review. *Renewable and Sustainable Energy Reviews*, 116, 109390.

- Lee, M., Hong, T., Jeong, J., & Jeong, K. (2018). Development of a rooftop solar photovoltaic rating system considering the technical and economic suitability criteria at the building level. *Energy*, *160*, 213–224.
- Lima, F. J. L. de, Martins, F. R., Costa, R. S., Gonçalves, A. R., dos Santos, A. P. P., & Pereira, E. B. (2019). The seasonal variability and trends for the surface solar irradiation in northeastern region of Brazil. *Sustainable Energy Technologies and Assessments*, *35*, 335–346. <https://doi.org/https://doi.org/10.1016/j.seta.2019.08.006>
- Lobaccaro, G., Lisowska, M. M., Saretta, E., Bonomo, P., & Frontini, F. (2019). A Methodological Analysis Approach to Assess Solar Energy Potential at the Neighborhood Scale. In *Energies* (Vol. 12, Issue 18). <https://doi.org/10.3390/en12183554>
- Machete, R., Falcão, A. P., Gomes, M. G., & Moret Rodrigues, A. (2018). The use of 3D GIS to analyse the influence of urban context on buildings' solar energy potential. *Energy and Buildings*, *177*, 290–302. <https://doi.org/https://doi.org/10.1016/j.enbuild.2018.07.064>
- Maurer, C., Cappel, C., & Kuhn, T. E. (2017). Progress in building-integrated solar thermal systems. *Solar Energy*, *154*, 158–186.
- Morganti, M., Salvati, A., Coch, H., & Cecere, C. (2017). Urban morphology indicators for solar energy analysis. *Energy Procedia*, *134*(Supplement C), 807–814. <https://doi.org/https://doi.org/10.1016/j.egypro.2017.09.533>
- Naboni, E., Natanian, J., Brizzi, G., Florio, P., Chokhachian, A., Galanos, T., & Rastogi, P. (2019). A digital workflow to quantify regenerative urban design in the context of a changing climate. *Renewable and Sustainable Energy Reviews*, *113*, 109255. <https://doi.org/https://doi.org/10.1016/j.rser.2019.109255>
- Natanian, J., Kastner, P., Dogan, T., & Auer, T. (2020). From energy performative to livable Mediterranean cities: An annual outdoor thermal comfort and energy balance cross-climatic typological study. *Energy and Buildings*, *224*, 110283. <https://doi.org/https://doi.org/10.1016/j.enbuild.2020.110283>
- Nault, E., Peronato, G., Rey, E., & Andersen, M. (2015). Review and critical analysis of early-design phase evaluation metrics for the solar potential of neighborhood designs. *Building and Environment*, *92*, 679–691. <https://doi.org/https://doi.org/10.1016/j.buildenv.2015.05.012>
- Nault, E., Waibel, C., Carmeliet, J., & Andersen, M. (2018). Development and test application of the UrbanSOLve decision-support prototype for early-stage neighborhood design. *Building and Environment*, *137*, 58–72. <https://doi.org/https://doi.org/10.1016/j.buildenv.2018.03.033>
- Nex, F., Macay Moreira, J., Agugiaro, G., Remondino, F., & Lim, N. J. (2013). From DSM to 3D building models: A quantitative evaluation. In *ISPRS - International Archives of the Photogrammetry, Remote Sensing and Spatial Information Sciences: Vols. XL-1/W1*. <https://doi.org/10.5194/isprsarchives-XL-1-W1-213-2013>
- Nouvel, R., Schulte, C., Eicker, U., Pietruschka, D., & Coors, V. (2013). CityGML-based 3D City Model for Energy Diagnostics and Urban Energy Policy Support. In *IBPSA World* (Vol. 2013).
- NREL. (2021). *EnergyPlus | EnergyPlus*.
- Palme, M., Inostroza, L., Villacreses, G., Lobato-Cordero, A., & Carrasco, C. (2017). From urban climate to energy consumption. Enhancing building performance simulation by including the urban heat island effect. *Energy and Buildings*, *145*, 107–120.
- Peronato, G., Bonjour, S., Stoeckli, J., Rey, E., & Andersen, M. (2016). Sensitivity of calculated solar irradiation to the level of detail: insights from the simulation of four sample buildings in urban areas. In *Proceedings of PLEA 2016, 32th international Conference on Passive and Low Energy Architecture*. <https://infoscience.epfl.ch/record/218046/files/1048-Peronato03.pdf>
- Peronato, G., Rastogi, P., Rey, E., & Andersen, M. (2018). A toolkit for multi-scale mapping of the solar energy-generation potential of buildings in urban environments under uncertainty. *Solar Energy*, *173*, 861–874.
- Pillai, D. S., Shabunko, V., & Krishna, A. (2022). A comprehensive review on building integrated photovoltaic systems: Emphasis to technological advancements, outdoor testing, and predictive maintenance. *Renewable and Sustainable Energy Reviews*, *156*, 111946. <https://doi.org/https://doi.org/10.1016/j.rser.2021.111946>

- Ratti, C., Baker, N., & Steemers, K. (2005). Energy consumption and urban texture. *Energy and Buildings*, 37(7), 762–776. <https://doi.org/https://doi.org/10.1016/j.enbuild.2004.10.010>
- Ratti, C., & Richens, P. (2004). Raster Analysis of Urban Form. *Environment and Planning B: Planning and Design*, 31(2), 297–309. <https://doi.org/10.1068/b2665>
- Redweik, P., Catita, C., & Brito, M. (2013). Solar energy potential on roofs and facades in an urban landscape. *Solar Energy*, 97, 332–341.
- Reinhart, C. F., & Walkenhorst, O. (2001). Validation of dynamic RADIANCE-based daylight simulations for a test office with external blinds. *Energy and Buildings*, 33(7), 683–697. [https://doi.org/10.1016/S0378-7788\(01\)00058-5](https://doi.org/10.1016/S0378-7788(01)00058-5)
- Ren, Z., Paevere, P., & Chen, D. (2019). Feasibility of off-grid housing under current and future climates. *Applied Energy*, 241, 196–211. <https://doi.org/https://doi.org/10.1016/j.apenergy.2019.03.068>
- Robert, A., & Kummert, M. (2012). Designing net-zero energy buildings for the future climate, not for the past. *Building and Environment*, 55, 150–158. <https://doi.org/https://doi.org/10.1016/j.buildenv.2011.12.014>
- Robinson, D., & Stone, A. (2005). A simplified radiosity algorithm for general urban radiation exchange. *Building Services Engineering Research and Technology*, 26(4), 271–284. <https://doi.org/10.1191/0143624405bt133oa>
- Sadeghipour Roudsari, M., & Pak, M. (2013). Ladybug: A parametric environmental plugin for grasshopper to help designers create an environmentally-conscious design. *Proceedings of BS 2013: 13th Conference of the International Building Performance Simulation Association*, 3128–3135.
- Saretta, E., Bonomo, P., & Frontini, F. (2020). A calculation method for the BIPV potential of Swiss façades at LOD2.5 in urban areas: A case from Ticino region. *Solar Energy*, 195, 150–165. <https://doi.org/https://doi.org/10.1016/j.solener.2019.11.062>
- Simon, H., Sinsel, T., & Bruse, M. (2021). Advances in Simulating Radiative Transfer in Complex Environments. *Applied Sciences*, 11(12), 5449.
- Spacemaker. (2021). *Spacemaker - AI Architecture Design | Building Information Modelling*. <https://www.spacemakerai.com/>
- Sun, J., Olsson, P., Eriksson, H., & Harrie, L. (2019). *Evaluating the geometric aspects of integrating BIM data into city models*. <https://doi.org/10.1080/14498596.2019.1636722>
- Sward, J. A., Nilson, R. S., Katkar, V. V., Stedman, R. C., Kay, D. L., Ifft, J. E., & Zhang, K. M. (2021). Integrating social considerations in multicriteria decision analysis for utility-scale solar photovoltaic siting. *Applied Energy*, 288, 116543.
- Thebault, M., Clivillé, V., Berrah, L.-A., Gaillard, L., Desthieux, G., & Ménézo, C. (2021). Multi-criteria decision aiding for the integration of photovoltaic systems in the urban environment: the case of the Greater Geneva agglomeration. *Territorio*.
- Thebault, M., Clivillé, V., Berrah, L., & Desthieux, G. (2020). Multicriteria roof sorting for the integration of photovoltaic systems in urban environments. *Sustainable Cities and Society*, 60, 102259.
- Thebault, M., & Gaillard, L. (2021). Optimization of the integration of photovoltaic systems on buildings for self-consumption—Case study in France. *City and Environment Interactions*, 10, 100057.
- Tsangrassoulis, A., & Bourdakis, V. (2003). Comparison of radiosity and ray-tracing techniques with a practical design procedure for the prediction of daylight levels in atria. *Renewable Energy*, 28(13), 2157–2162. [https://doi.org/https://doi.org/10.1016/S0960-1481\(03\)00078-8](https://doi.org/https://doi.org/10.1016/S0960-1481(03)00078-8)
- Zhang, J., Heng, C. K., Malone-Lee, L. C., Hii, D. J. C., Janssen, P., Leung, K. S., & Tan, B. K. (2012). Evaluating environmental implications of density: A comparative case study on the relationship between density, urban block typology and sky exposure. *Automation in Construction*, 22, 90–101. <https://doi.org/https://doi.org/10.1016/j.autcon.2011.06.011>