



HAL
open science

Supercritical CO₂ sterilization under low temperature and pressure conditions

Victorine Warambourg, Adil Mouahid, Christelle Crampon, Anne Galinier, Magalie Claeys-Bruno, Elisabeth Badens

► **To cite this version:**

Victorine Warambourg, Adil Mouahid, Christelle Crampon, Anne Galinier, Magalie Claeys-Bruno, et al.. Supercritical CO₂ sterilization under low temperature and pressure conditions. *Journal of Supercritical Fluids*, 2023, 203, pp.106084. 10.1016/j.supflu.2023.106084 . hal-04233306

HAL Id: hal-04233306

<https://hal.science/hal-04233306v1>

Submitted on 10 Oct 2023

HAL is a multi-disciplinary open access archive for the deposit and dissemination of scientific research documents, whether they are published or not. The documents may come from teaching and research institutions in France or abroad, or from public or private research centers.

L'archive ouverte pluridisciplinaire **HAL**, est destinée au dépôt et à la diffusion de documents scientifiques de niveau recherche, publiés ou non, émanant des établissements d'enseignement et de recherche français ou étrangers, des laboratoires publics ou privés.

Supercritical CO₂ sterilization under low temperature and pressure conditions

Victorine Warambourg^a, Adil Mouahid^a, Christelle Crampon^a, Anne Galinier^b, Magalie Claeys-Bruno^c, Elisabeth Badens^{a*}

^a Aix Marseille Univ, CNRS, Centrale Marseille, M2P2, Marseille, France

^b Aix Marseille Univ, CNRS, LCB, Marseille, France

^c Aix Marseille Univ, Avignon Université, CNRS, IRD, IMBE, Marseille, France

* Corresponding author: E-mail address: elisabeth.badens@univ-amu.fr

Abstract

Sterilization using supercritical carbon dioxide has been proven to be efficient for decades now. The aim of this work was to implement a process of sterilization adapted to thermosensitive polymeric materials and highlight the lowest conditions of pressure and temperature which would enable a bacterial reduction higher than 6-log. Inactivation experiments were performed on spores of *Bacillus subtilis* over a pressure range lying from 60 to 200 bar, and a temperature varying from 35 to 60 °C, with and without additive. Preliminary experiments allowed us to determine a restricted experimental domain used for the design of the experiments, investigating the influence of pressure, temperature, process duration, and additive content on bacterial reduction. It was shown that sterilization conducted at 110 bar, 40 °C, for 20 minutes with 200 ppm of H₂O₂, leading to a bacterial reduction of 8.73-log, may be considered as optimal for IMD sterilization.

Keywords: Supercritical fluid, Sterilization, *Bacillus subtilis*, Carbon dioxide, Hydrogen peroxide

1 Introduction

Implantable medical devices (IMD) are defined as medical devices (MD) totally or partially introduced inside the body to act as or replace a part of a whole biological structure for a short or long-term period [1]. These IMD are currently produced with polymeric materials, sometimes biodegradable, such as polyesters or polycarbonates. The IMD market is currently booming, due to the great advances in biomedical engineering and new production methods such as additive fabrication (3D printing). In this context, the need for efficient methods for IMD elaboration is growing.

Sterilization is obviously a critical step in IMD production because it is required to avoid safety issues during implantation. A sterilization process must respect the Sterility Assurance Level (SAL) imposed by ISO 14937:2009 standards. The SAL corresponds to the probability that a single viable microorganism stays present on a product after a sterilization process. This probability must be less than 10^{-6} to validate product sterility [2], [3]. The corresponding bacterial reduction must be then higher than 6 log₁₀ or 6-log. In addition, to be efficient, the sterilization process must preserve polymer integrity and IMD effectiveness, which can be tricky if the polymer is thermosensitive. Different standard sterilization methods are currently used for IMD, such as moist (ISO 17665-1:2006 standard, soon to be replaced by ISO/DIS 17665) [4] or dry heat (ISO 20857:2010 standard) [5], irradiation (Beta, Gamma, or X-rays), Ethylene Oxide (EtO), Cold Plasma, Vaporized Hydrogen Peroxide (VHP) and Formaldehyde.

Moist and dry heat methods cannot be applied to thermally sensitive products such as polymeric IMD. EtO gas sterilization (ISO 11135:2014 standard (soon replaced to be by ISO/CD 11135)) is the method currently used in the industry for the sterilization of about 50% of the IMD produced worldwide [6]. One of the main advantages of this technique is that it does not alter the integrity of polymers [3], allowing the sterilization of thermosensitive devices. Nevertheless, even if this method is commonly used for sterilization, some gas residues can be found in the devices after treatment. EtO is considered carcinogenic for humans and can cause health issues. To limit these effects, treated MD must undergo aeration to remove residual EtO for 8 to 12 hours [3]. This sterilization treatment could be prohibited in the coming years due, among other things, to its carcinogenic effects. Thus, alternative sterilization methods must be found for MD, and more particularly for IMD.

The VHP sterilization method can also be used on IMD; this is a technique used by health establishments for the sterilization of thermally sensitive products. There is no regulatory standard specific to this treatment, so it should refer to ISO 14937:2009. Hydrogen peroxide cold plasma is now also employed. The gas molecules are excited in an enclosed chamber, under deep vacuum, using radio frequency of microwave energy to generate charged particles, such as free radicals. These molecules will interact with essential cell components and therefore disturb the microorganism metabolism [3]. Nevertheless, these free radicals can react with the device materials and impact their integrity [7]. Irradiation is also a low-temperature sterilization method that may be used on thermosensitive devices.

However, the degradation of polymers can occur and some residues may be found in the treated materials [3].

In sum, different drawbacks can be highlighted for these different methods when applied to polymeric materials: alteration of MD properties, degradation of polymers, presence of chemical residues after treatment... In this context, new sterilization methods are currently emerging and being tested on IMD, such as High Hydrostatic Pressure (HHP), Nitrogen Dioxide, UV, pulsed light, or finally, sterilization using scCO₂ which is investigated in this study.

Supercritical fluid technology is of particular interest for MD since it allows processing without the use of any toxic solvent compared to most conventional methods. Moreover, supercritical carbon dioxide (scCO₂) is already used in the IMD industry for cleaning processes [8], [9].

Over the past three decades, the use of scCO₂ as an efficient sterilization method has been considered and studied [10], [11]. Sterilization using scCO₂ has many advantages compared to other methods: CO₂ is non-toxic, non-flammable, abundant, and its use as a supercritical fluid constitutes an additional means of carbon reuse. Furthermore, scCO₂ can be used to treat thermosensitive materials due to its low critical temperature of 31.06 °C. At the end of the process, CO₂ is spontaneously separated from the MD during depressurization and can be recycled. In addition, the U.S. Food and Drug Administration considers scCO₂ as being a “Generally Recognized As Safe” (GRAS) solvent. Thanks to the specific properties of supercritical fluids, scCO₂ penetrates easily inside various solid materials, in cells, and even diffuses into polymeric matrices. This latter point is of interest for IMD when they are entirely or partly made of polymers and moreover, sterilization is often carried out in pouches or blisters, also made of polymers. In addition, due to the conditions of pressure, there are no dead volumes in the treated materials. Lastly, the temperature and pressure can be conveniently modulated to achieve the targeted bioburden lowering.

The studies focused on scCO₂ sterilization reported in the literature have shown an effectiveness in inactivating several types of microorganisms (bacteria, fungi, parasites, viruses, ...). The inactivation mechanisms of scCO₂ highlighted and discussed in the literature are acidification of the extracellular (if appropriate) or intracellular media, modification of the cell membrane properties, dysregulation of enzyme activity, electrolyte disturbances, and removal of essential cell compounds [11].

2 Reminders on Supercritical Sterilization of Spores

To determine treatment conditions effective on all microorganisms that could be found on the MD, it is more advisable to realize experiments on resistant organisms. Among the most resistant life forms known, are the spores of the *Bacillus* species. These spores regularly cause concerns in the medical product industry – including MD – because the spores are involved in several human diseases and are resistant to a large number of sterilization treatments and agents. Many studies dealing with scCO₂ sterilization have used the *Bacillus* species as models [12]–[28] such as *B. atrophaeus*, *B. subtilis*, *B. cereus* and *Geobacillus stearothermophilus*, among others. These Gram-positive bacteria are commonly used as biological indicators for the validation of sterilization processes (steam, EtO, dry heat and irradiation).

The investigation of *Bacillus* species inactivation was conducted either on stripes, on inoculated microorganisms (on slides or specific supports) or on microorganisms in their natural environments using static or dynamic modes following a wide range of procedures for efficiency enhancement.

2.1 Sterilization with pressurization cycles for efficiency enhancement

In the framework of MD sterilization, Dillow *et al.* [12] studied the inactivation of either Gram-positive or Gram-negative bacteria. The resistance of spores was studied on the sporulated forms of *B. cereus*. A SAL of 9-log was obtained for spore treatment at 60 °C for 4 hours at 205 bar with 6 pressurization cycles ($\Delta P \geq 100$ bar). The authors enriched their study by investigating the potential of supercritical nitrogen and supercritical tetrafluoroethane (TFE) as sterilizing agents. In both cases, no bioburden lowering was achieved highlighting the specific properties of CO₂ partly due to its chemical nature. Lastly, no damage was noticed when such treatment was employed on PLGA (50:50) and PLA.

2.2 Sterilization with increased temperature and pressure for efficiency enhancement

Since pressurization cycles are not simple to implement at large scale, some authors have studied higher temperatures or pressures to achieve a high bioburden lowering [13]–[18]. Spilimbergo *et al.* [13] achieved a complete inactivation of a suspension of *B. subtilis* spores (10^7 CFU·mL⁻¹) by increasing the

temperature from 50 to 75 °C at 70 bar. The rise in sterilization efficiency through an increase in temperature was confirmed more recently by Rao *et al.* [14], [15] on *B. subtilis* spores at temperatures ranging from 82 to 91 °C and pressure varying from 65 to 250 bar. However, such rather high temperatures cannot be applied to most thermosensitive polymers used for medical devices.

An increase in pressure can also lead to a SAL increase. Furukawa *et al.* [16] studied the inactivation of vegetative cells as well as spores using scCO₂. Higher temperatures, pressures, and process durations were required to obtain an efficient inactivation of *B. cereus* (a mixture of vegetative cells and spores). A SAL of about 6-log was achieved at 75 °C, 300 bar, and 120 minutes of suspension treatment.

Lastly, a thorough study was carried out by Hossain *et al.* [18] on clinical solid wastes inoculated with different strains treated over a pressure ranging from 50 to 400 bar, a temperature varying from 35 to 80 °C and a processing time ranging from 5 to 90 minutes. Gram-positive as well as Gram-negative bacteria were studied. The complete inactivation of the most resistant organism in this study, *B. subtilis*, was achieved at 200 bar, 60 °C for 60 minutes.

For all the works quoted above, the pressure conditions used for a complete inactivation of spores can be an issue when it comes to the treatment of polymers easily plasticized by scCO₂.

2.3 Sterilization with additives for efficiency enhancement

Some authors have reported that water, considered as a “passive” additive, has an impact on scCO₂ treatment efficiency. When the sterilization treatment is performed in wet conditions, a reaction between CO₂ and water in the extracellular medium leads to the formation of carbonic acid, which reduces the extracellular pH impacting bacterial viability [19]–[21]. The use of scCO₂ saturated with H₂O could enhance the inactivation but seems not to be effective enough, as presented in Zhang *et al.* [22] study.

In this context, several “active” additives have been used in literature such as: hydrogen peroxide (H₂O₂), trifluoroacetic acid (TFA), peracetic acid (PAA), ethanol, methanol, and nisin. The utilization of these additives, for some in aqueous solutions, allowed significant increases in bacterial reduction with scCO₂ treatments at mild pressure and temperature compared to the same treatments without additives. This is of great interest for the present study which was carried out intending to treat polymers sensitive to high temperature and high pressure.

Zhang *et al.* reported in 2006 [22] that an inactivation higher than 6-log can be achieved for *B. pumilus* at 275 bar, 60 °C for a process duration of 4 hours using 200 ppm of H₂O₂ (in aqueous solution) as an additive. In 2006, the same authors [23] worked with a less resistant strain, *B. atrophaeus*, and obtained a SAL higher than 6-log at 275 bar, 40 °C, and 4 hours of treatment with 200 ppm of H₂O₂. They investigated the mechanisms of inactivation, analyzing the quantity of dipicolinic acid (which composes a certain fraction of bacterial spore dry weight) released after treatment. They observed a significant release from spores treated in the presence of additives in comparison with untreated spores or the ones inactivated with pure CO₂. The authors assumed that the spore envelope was damaged by scCO₂ resulting in a facilitated diffusion of H₂O₂ leading to the oxidation of vital internal structures and thus subsequent death.

Later, in 2007, the same authors [24] went deeply into the influence of the scCO₂+H₂O₂ treatment on the damage of spore structure. They studied the inactivation of *B. anthracis* at 275.8 bar, 40 °C with 200 ppm of H₂O₂ and 4 hours. A SAL of 6.4-log was achieved. It was observed by BacLight fluorescence that about half of the spores lost their membrane integrity but concluded the spores were mostly intact after treatment and thus that scCO₂ sterilization can be considered as a milder treatment than conventional steam autoclaving.

Furthermore, Hemmer *et al.* [25] showed that spores of *G. stearothermophilus* and *B. atrophaeus* were completely inactivated with scCO₂ without additive at 304 bar, 105 °C with a process duration of 25 minutes. The use of H₂O₂ (<100 ppm) made it possible to achieve a 6-log reduction at a lower temperature of 40 °C for a 1 hour-treatment.

Based on this literature overview, few studies report scCO₂ sterilization experiments on a dry inoculum which is more our focus in the context of MD treatment. Among them, the study of Checinska *et al.* [26], dedicated to desiccated bacteria biofilms (*Aspergillus* or *Pseudomonas*) and bacteria spores (*B. pumilus*) on a cover glass slip, performed a treatment at pressures ranging from 70 to 100 bar and 50 °C achieved at best a 5.73-log reduction. For their part, Da Silva *et al.* [27] realized the inoculation of two sporulating bacteria (*B. subtilis* and *G. stearothermophilus*) over metal surfaces and treated them at 300 bar and 60 °C obtaining a higher SAL of 7-log and 5-log, respectively, for the two strains.

Following all these previous works reported in the literature, it can be highlighted that a complete inactivation (SAL of at least 6-log) of spores is achieved: i) via the use of pressurization cycles [12], ii) via the use of high temperatures or high pressures [13]–[18], iii) via the use of an active additive such as H₂O₂ [23]–[25], [28].

In the present study, it was decided to not use pressurization cycles since their implementation at industrial scale can be challenging. The sterilization process to be implemented must be adapted to thermosensitive polymers. In addition to have a less energy-intensive process, the objective was to work at rather low pressures to implement a process suitable to polymeric medical devices for which degradation/deformation or property modifications may occur when subject to treatments under too high CO₂ pressures. Hence the use of an active additive was preferred. The goal of this study was to optimize the sterilization pressure in comparison with previous works for which pressures higher than 200 bar were used for a complete inactivation of spores. An upstream work was realized by investigating a few critical points such as: the experimental protocol repeatability, the operating mode, the working pressure and temperature, or the additive used. Then, a design of experiments was conducted to investigate the influence of four parameters on bacterial reduction: the pressure (110 to 140 bar), treatment duration (20 to 120 minutes), additive content (0 to 200 ppm), and temperature variation (35 to 45 °C). These operating conditions were selected since they are adapted to the thermosensitive polymers usually used for medical devices.

As no biological indicator has yet been highlighted for scCO₂ sterilization, *B. subtilis* was selected for this work since its cultivation is rapid (spore obtention in about 20 hours) and requires mild conditions of temperature. The study was performed mainly with glass slides inoculated with spores of this bacterium. Some experiments were performed with strains inoculated on medical device polymers under selected operating conditions ensuring a high bacterial reduction (SAL > 6-log).

3 Materials and Methods

3.1 Materials

B. subtilis 168 (NCBI:txid224308) is a Gram-positive spore-forming bacterium [29]. Spore strips of *B. atrophaeus* 9272 ($2.0 \cdot 10^6$ spores per unit), a biological indicator for EtO and dry heat sterilization, were obtained from MesaLabs (USA).

Pressurized liquid CO₂ (99.95%) was supplied by Air Liquide (France). Water, used as an additive, was distilled and sterilized (steam) in our laboratory. H₂O₂ (Fisher, France) was purchased at a concentration of 30% (w/v) (into water) and the solution used was prepared by dilution with sterile distilled water. Water and H₂O₂ were added into the autoclave by deposit on a pad (Fisher, France), volume was variable depending on the experiment. The content of H₂O₂ is expressed in parts per million (ppm), such as 100 ppm corresponds to 0.01 g of H₂O₂ for 100 g of CO₂.

3.2 Spore culture and sample preparation

3.2.1 Vegetative cells and sporulation

B. subtilis vegetative cells were cultivated on lysogeny broth (LB) (Invitrogen, USA) agar plates at 37 °C. Sporulation was promoted by inoculation, with an isolated colony from LB agar plate, of liquid Difco Sporulation Media (DSM) ($3 \text{ g} \cdot \text{L}^{-1}$ Bacto beef extract; $5 \text{ g} \cdot \text{L}^{-1}$ Bacto peptone; 13.4 mM KCl; 1 mM MgSO₄; 1 μM MnCl₂; 1 mM CaCl₂; 0.2 μM FeSO₄; 2 mg·L⁻¹ ferric ammonium citrate) incubated at 37 °C with an agitation of 130 rpm for at least 48 hours. To verify the sporulation efficiency, phase microscopy (B-190TB, OPTIKA, Italy) was realized on a sample of the culture in DSM. Microscopy images of vegetative cells, sporulated bacteria and spores (Figure 1) were performed using a Zeiss AxioImager M2 equipped with an OrcaR2 digital camera (Hamamatsu). Sporulated cells were harvested

by centrifugation at 5,000 rpm for 5 minutes. The supernatant was discarded, and the pellet was kept at room temperature. The sporulated cell stock was renewed at least every month.

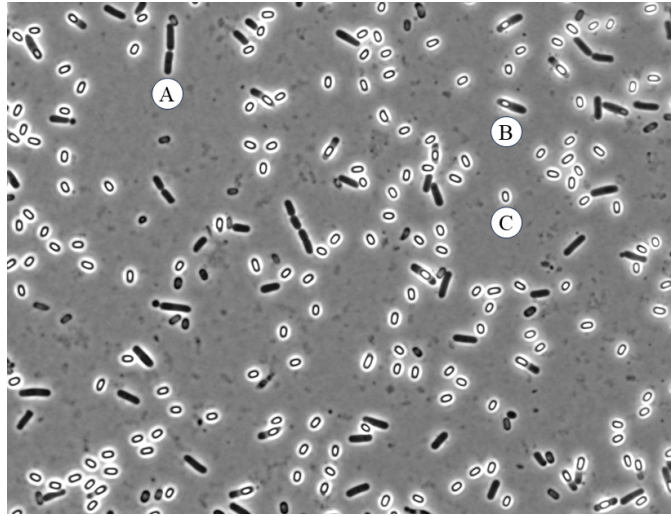

Figure 1: Optical microscopy observation of *B. subtilis* growth in DSM at 37 °C, 130 rpm in different states of sporulation: vegetative cell (A), sporulating cell (B), and spore (C)

3.2.2 Sample preparation

To prepare the experimental sample, a pellet of sporulated cells was resuspended with sterile distilled water and heated at 85 °C for 25 minutes to ensure the elimination of vegetative cells. The initial sample preparation contained approximately 10^9 CFU·mL⁻¹, determined by standard plating technique.

To realize the sterilization experiments, the bacterial spores were inoculated on glass slides (1.5 mm x 2.5 cm x 7.5 cm) with a 40 µL droplet of the initial heated sample. The glass slides were left inside a laminar flow chamber until the droplet was completely dried (approximately 40 minutes). After the drying step, the insertion of the glass slides into the autoclave was achieved thanks to a support crafted with a steel profile: two slides are back-to-back and two other slides are above with the same configuration. A photo of the support of the glass slides is given in Figure 2. When required, a pad with the additive was placed into the autoclave. For each experiment, four inoculated glass slides were treated (except if specified).

For the experiments performed on the polymer used for manufacturing the medical devices, 3D printed PLA:PCL 70:30 (Poly(L-Lactide-co-e-Caprolactone)) (1.0 mm x 2.5 cm x 7.3 cm) provided by

Lattice Medical (Loos, France) were inoculated with a 40 μL droplet of the initial heated sample. As for glass slides, the 3D printed polymer samples were inserted into the vessel thanks to a support crafted with a steel profile (Figure 2).

3.2.3 *B. atrophaeus* spore strips preparation and growth

Spore strips of *B. subtilis* were placed inside the vessel with their glycine envelope. After sterilization treatment, spore strips were aseptically withdrawn from the envelope, transferred to sterile tryptic soy broth (17 g·L⁻¹ casein peptone (pancreatic); 2.5 g·L⁻¹ dipotassium hydrogen phosphate; 2.5 g·L⁻¹ glucose; 5 g·L⁻¹ sodium chloride; 3 g·L⁻¹ soya peptone (papain digest.)) and incubated at 32°C with an agitation of 130 rpm for seven days. Cultures were observed daily for growth. In case of a complete sterilization, no growth must be observed. If turbidity and bacteria growth are observed, it suggests that spores survived during the sterilization treatment, and this treatment did not achieve a 6-log bacterial reduction.

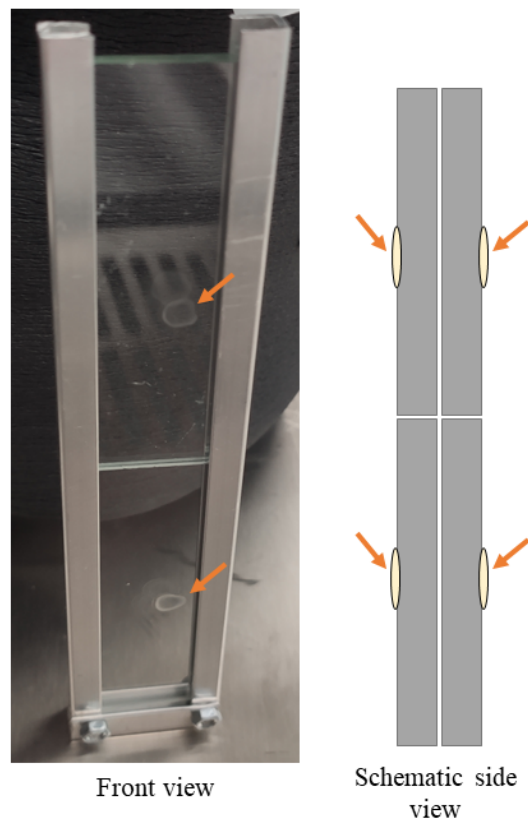

Figure 2: Front and schematic side view of the solid support allowing insertion and positioning of the glass slides inside the autoclave. Orange arrows indicate inoculum on frontal slides.

3.3 ScCO₂ sterilization pilot

The experimental apparatus used for this study is presented in Figure 3. It was composed of a 460 mL (A in Figure 3, internal diameter: 60 mm) autoclave equipped with a double jacket for temperature control (model 14830000, Top Industrie, France). The double jacket was connected to a liquid heat exchanger (type ME v.2, Julabo, Germany) (E2 in Figure 3) set to ensure the working temperature in the autoclave. Silicon oil was selected as heating liquid. The maximum allowable pressure was 300 bar at a temperature of 150 °C. The autoclave was equipped with a 340 bar high-pressure proportional relief valve as well as pressure (type A-10 pressure transmitter, Wika, United Kingdom) and temperature (type K thermocouple, TC direct, France) sensors. A magnetic stirrer was used to ensure the homogenization of the medium in the autoclave at 300 rpm. A high-pressure CO₂ liquid piston pump (Separex, France) allowed the injection of CO₂ at the top of the autoclave. The CO₂ was previously cooled at 0 °C before its introduction in the CO₂ pump to ensure its liquid state. The pressurized CO₂ was preheated close to the working temperature thanks to a stainless-steel coil immersed in the heat exchanger (E2 in Figure 3). The autoclave was heated at working temperature 3 hours before the experiments to ensure temperature stability. All the experiments were realized in batch mode (except if specified). The pressurization rate was set to 2.5 bar·min⁻¹ in all experiments. When the pressure reached the pre-determined value in the autoclave, the pump was switched off and the inlet valve (V2 in Figure 3) was closed. At the end of the treatment time, the outlet valves (V3 and V4 in Figure 3) were opened to depressurize the system. A low depressurization rate (around 2 bar·min⁻¹) was used by Ongkasin *et al.* [30] for polymeric medical devices in order to prevent foaming and permanent swelling. In our study, it was decided to use an intermediary depressurization rate of 7.5 bar·min⁻¹, for all experiments, not too fast to prevent the polymer from foaming and not too slow to limit the duration of this step. For that, a micrometric valve (V4 in Figure 3) was used to ensure a constant pressure depressurization rate.

If an additive was added, the fluid phase (CO₂ + additive) in the autoclave had to be renewed by pure CO₂ before depressurization to avoid condensation of the additive solution on the glass slides. Finally, the vessel was opened and the support with the glass slides were withdrawn to realize bacterial

counting. The treatment time was defined as the time of the batch part (when the autoclave was isolated and the feed and exit line were closed), without including time of pressurization, CO₂ renewal (when required), and depressurization.

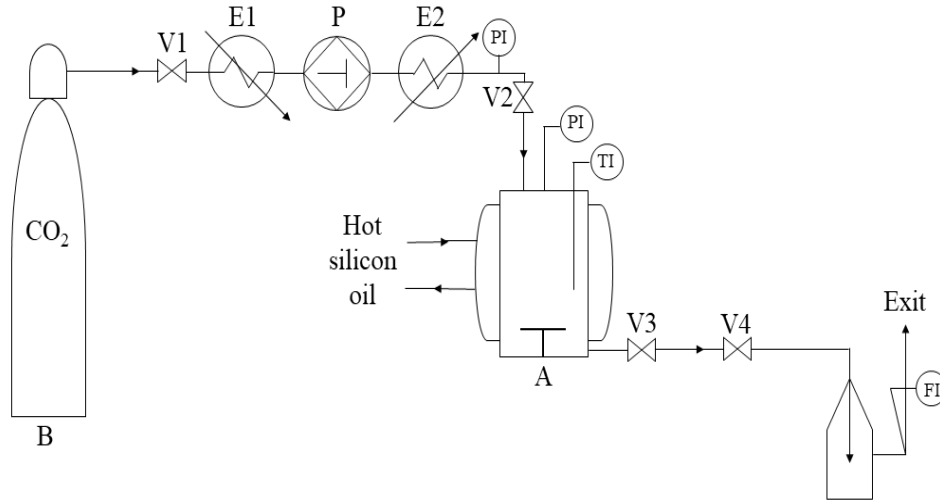

Figure 3: Apparatus for sterilization. B: CO₂ pressurized bottle (60 bar); V1 to V3: valves; V4: micrometric valve; E1 and E2: heat exchangers respectively cold and hot; P: high-pressure CO₂ liquid piston pump; A: agitated autoclave; PI: pressure indicator; TI: temperature indicator; FI: CO₂ mass flow indicator.

3.4 Viable spore counting

To determine the efficiency of the sterilization process, six glass slides were inoculated: four were used for the scCO₂ treatment and two as controls (inoculated but not treated). After the treatment duration, the deposits present on the test and control glass slides were collected by hydration with 200 μL of sterile distilled water and transferred to sterile Eppendorf tubes. The surviving spores were counted using the standard plating technique. The sample was diluted by serial dilution (1:10) with sterile LB medium, then pour-plated on LB agar plates incubated at 37 °C overnight. After incubation, the colonies were enumerated. The bacterial reduction was calculated considering Eq. (1) where N₀ and N are respectively the number of viable spores before and after the treatment expressed in CFU·mL⁻¹.

$$\text{Bacterial reduction} = -\log_{10} \left(\frac{N}{N_0} \right) \quad (1)$$

All values reported are the averages of the four experimental measurements achieved simultaneously in the autoclave.

For experiments performed on inoculated 3D printed polymers, after the $\text{scCO}_2 + \text{H}_2\text{O}_2$ treatment, the deposits are rehydrated by vortexing the polymer sample into a tube containing 5 mL of sterile distilled water.

3.5 Experimental design

Design of Experiments (DoE) is a statistical method used for optimal selection and planning of experiments. They are used to identify the quantitative influence of chosen parameters (factors) by investigating the measured responses of the experiments within a well-defined experimental domain.

As mentioned above (cf 3.2.2), during each experiment, four inoculated glass slides were treated. Hence, the response studied (Y) corresponds to the average value of the bacterial reductions obtained, allowing the optimization of the sterilization process. This response Y was modeled using a second-order polynomial model (Eq. (2)) where X_1 , X_2 , X_3 , and X_4 are coded values, representing respectively the pressure, the duration, the H_2O_2 content, and the temperature, and b_0 , b_1 , b_{12} , and b_{11} are respectively constant coefficients of intercept, linear, interaction and quadratic terms.

$$Y = b_0 + b_1X_1 + b_2X_2 + b_3X_3 + b_4X_4 + b_{11}X_1^2 + b_{22}X_2^2 + b_{33}X_3^2 + b_{44}X_4^2 + b_{12}X_1X_2 + b_{13}X_1X_3 + b_{14}X_1X_4 + b_{23}X_2X_3 + b_{24}X_2X_4 + b_{34}X_3X_4 \quad (2)$$

To evaluate the different coefficients, a set of 20 experiments, already conducted upstream, was completed to obtain a set of 39 experiments by using an exchange algorithm based on D-optimality criteria [31], [32]. Experiments 1, 10, 13, and 14 were repeated twice and experiments 2, and 11 were repeated three times to calculate the experimental variance and reinforce the reliability of the final model validations. This experimental design was set, and the parameters calculated, using Azurad software.

The desirability approach was carried out to find the best conditions for response Y: in any point of the domain, the predicted response value was transformed into a desirability function (DF) representing the degree of satisfaction. To maximize the bacterial reduction (Y), an individual desirability curve was drawn: the DF was set at 0 % when the response is unacceptable (bacterial reduction $< 6\text{-log}$), and at 100 % when the value is equal to or higher than 10-log . When $0\% < d < 100\%$, an acceptable value for the bacterial reduction was obtained ($>6\text{-log}$).

4 Results and discussion

Before using the DoE approach, a preliminary experimental work was conducted focusing on the experimental process repeatability and on the influence of the operating mode, the working pressure and temperature, or the additive use. It was checked that the efficiency of the additive was due to its synergy with the scCO₂ and not just due to its own action. Then, to define a restricted operating area (domain of interest) for the DoE, a set of experiments was performed under different operating conditions, a pressure ranging from 80 to 200 bar and a temperature ranging from 35 to 50 °C, for different treatment durations, with and without additive.

4.1 Preliminary experiments

4.1.1 Repeatability of the experimental protocol

To validate the experimental protocol, a repeatability test was achieved. Three experiments were repeated under the same conditions: 200 bar, 50 °C for 2 hours of treatment, without additive. The results are presented in Table 1. The deviation of the bacterial reduction for the twelve experiments (four glass slides in three experiments with the same treatment conditions) is about 0.07. This deviation was considered as satisfactory. Qiu *et al.* [33] showed in their study a similar deviation for the CFU reduction obtained after a scCO₂ sterilization treatment applied to *B. atrophaeus*.

Table 1: Repeatability tests of the scCO₂ treatment efficiency (200 bar, 50 °C, 2 hours) for the inactivation of *B. subtilis* inoculated over glass slides.

Experiments	Counting (CFU·mL ⁻¹)		Bacterial reduction (log)
	Before treatment	After treatment	
1	2.64×10^7	1.05×10^7	0.40±0.01
2	2.42×10^7	9.14×10^6	0.42±0.07
3	2.36×10^7	7.30×10^6	0.51±0.06

4.1.2 Operating mode

To investigate the influence of the operating mode on the sterilization efficiency, tests were conducted in continuous mode and batch mode at 200 bar, 50 °C for 4 hours (Table 2). The bacterial reduction of the continuous mode tests was not increased in comparison to the batch mode. So, all the other experiments of this present study were carried out in batch mode.

Table 2: ScCO₂ treatment on *B. subtilis* inoculated over glass slides at 200 bar, 50 °C for 4 hours to investigate two types of operating mode: batch mode and continuous mode.

Operating mode		Counting (CFU·mL ⁻¹)		Bacterial reduction (log)
		Before treatment	After treatment	
Batch		7.83×10^5	2.82×10^5	0.53±0.05
Continuous	Set 1	7.83×10^7	4.54×10^7	0.24±0.05
	Set 2	8.43×10^7	6.53×10^7	0.12±0.05

4.1.3 Working temperature

Considering our first experiments (Table 1 and Table 2), the bacterial reduction was low (less than 1-log). Increasing the temperature could be a solution to improve the efficiency of the treatment based on the literature [13]–[15]. To check this, an experiment at 200 bar for 4 hours increasing the temperature to 60 °C was performed, despite the fact that this temperature may be too high for some thermosensitive MD. The bacterial reduction obtained was 0.41-log (±0.05). Compared to the experiment performed in similar conditions but at 50 °C making it possible to obtain a bacterial reduction of 0.53-log (±0.05) (Table 2, batch mode), this temperature increase did not improve the efficiency of the sterilization treatment. This observation is consistent with the literature: Da Silva *et al.* [27], who also used a dry inoculum, reported a very low bacterial reduction (less than 1-log) after scCO₂ treatment at 300 bar and 60 °C for up to 3 hours. Nevertheless, the present study is focused on sterilization adapted to thermosensitive materials, meaning that the working temperature must be ideally less than 50 °C.

4.1.4 Additive selection and repeatability with additive

Considering the limitation of the working temperature and the meager efficiency of the treatment in tested conditions (Table 1 and Table 2), it was decided to use an additive to work synergically with the scCO₂ to improve sterilization efficiency. The first additive tested was water. An experiment at 200 bar, 50 °C for 2 hours with 2780 ppm (1 g) of sterile water was conducted. This amount of water corresponds to a saturation of the CO₂-rich phase of 82 % [34]. This treatment led to a bacterial reduction of 0.46-log (± 0.08). The same treatment but without additive made it possible to obtain, on average, a bacterial reduction of 0.49-log (± 0.12) (Table 1). So, the use of this passive additive does not improve the sterilization efficiency in the studied conditions. This observation is consistent with the study of Zhang *et al.* [22] who showed that scCO₂ treatment with a low amount of water at 50 – 60 °C and 275 bar on *B. pumilus* led to a low bacterial reduction (less than 3-log).

An aqueous H₂O₂ solution was then considered as an additive to replace pure water. This active additive has shown interesting results in the literature [22]–[24]. Some studies associated H₂O₂ with PAA [35], [36], but it was preferred to avoid the use of an acid in the framework of MD treatment. In this way, a 10% w/v H₂O₂ solution was added by deposit (various volumes for achieving the targeted H₂O₂ content) on a pad placed into the autoclave. The first tests with this additive were very encouraging, with a bacterial reduction higher than 4-log. Three experiments were conducted at 140 bar, 40 °C with 40 ppm of H₂O₂ for 30 minutes (Table 3). The deviation of the bacterial reduction for the twelve experiments (four glass slides in three sets of experiments) was about 0.65; this value can be considered as satisfactory, making it possible to confirm the repeatability of the sterilization protocol with H₂O₂ as additive.

Table 3: Repeatability study scCO₂+H₂O₂ treatment efficiency to inactivate *B. subtilis* inoculated over glass slides at 140 bar, 40 °C for 30 minutes, and with 40 ppm of H₂O₂.

Experiments	Counting (CFU·mL ⁻¹)		Bacterial reduction (log ₁₀)
	Before treatment	After treatment	

1	4.08×10^9	1.94×10^4	5.67 ± 0.57
2	1.53×10^9	3.58×10^3	5.67 ± 0.25
3	8.33×10^8	3.22×10^4	4.75 ± 0.67

4.1.5 Use of H₂O₂ as an additive in CO₂

An experiment was carried out using CO₂ at 60 bar, 40 °C for 4 hours, and with 200 ppm of H₂O₂. In those conditions, the CO₂ is gaseous. The bacterial reduction obtained was 0.53-log (± 0.12), far from the objective of 6-log but consistent with the literature. Zhang *et al.* [22] showed that the treatment of *B. pumilus* with 200 ppm of H₂O₂ at 60 °C, P_{atm} for 4 hours led to a bacterial reduction of around 2.8-log.

This result confirms that the effectiveness of the sterilization treatment with scCO₂ and H₂O₂ is also due to the specific properties of scCO₂. Furthermore, the major interest of this treatment is its effectiveness with a low content of additive. Indeed, for other sterilization processes using H₂O₂, such as VHP, the quantities used are higher (between 400 and 1200 ppm for usual VHP treatments) highlighting the interest in the scCO₂-H₂O₂ method to sterilize MD.

4.1.6 Operating conditions and Widom line

It is known that working in the vicinity of the critical point and/or of the Widom line may lead to issues of repeatability [37]. Indeed, important variations of the supercritical fluid properties for small changes in pressure and temperature can be observed in these areas.

It can be admitted that the ternary system CO₂-H₂O₂-H₂O Widom line is the same as that of pure CO₂ since the amount of H₂O₂ and H₂O in CO₂ is extremely low. It can be seen on the CO₂ phase diagram shown in Figure 4 that the experimental domain selected in this study covers two distinct zones: one where scCO₂ has a gas-like behavior and one zone where it behaves more like a liquid. The first experiments presented above were carried out in operating conditions corresponding to the liquid-like behavior. By way of comparison, experiments were performed using scCO₂ with gas-like properties at 80 bar and 40 °C (Table 4). An interesting bacterial reduction for such a low pressure was obtained.

Nevertheless, in this condition, the repeatability was not satisfactory. This observation could be explained because of the vicinity of the Widom line.

Table 4: Repeatability study scCO₂+H₂O₂ treatment efficiency to inactivate *B. subtilis* inoculated over glass slides at 80 bar, 40 °C for 20 minutes, and with 40 ppm of H₂O₂.

Experiments	Counting (CFU·mL ⁻¹)		Bacterial reduction
	Before treatment	After treatment	(log ₁₀)
1	2.26 × 10 ⁹	3.10 × 10 ⁶	3.19±0.63
2	2.29 × 10 ⁹	4.23 × 10 ⁵	4.78±1.14
3	2.30 × 10 ⁹	9.83 × 10 ⁵	6.37±0.59

Since temperatures lower than 50 °C were preferred for this study and since it is preferable to avoid the vicinity of the Widom line, the subsequent experiments in this study were carried out using scCO₂ with liquid-like properties. The repeatability of the sterilization process in this operating domain was validated (Table 3). In addition, since the objective of this work is to implement a low pressure and temperature process well adapted to polymeric medical devices, the following restricted operating domain was selected for the DoE: a temperature ranging from 35 to 45 °C and a pressure ranging from 110 to 140 bar (Figure 4).

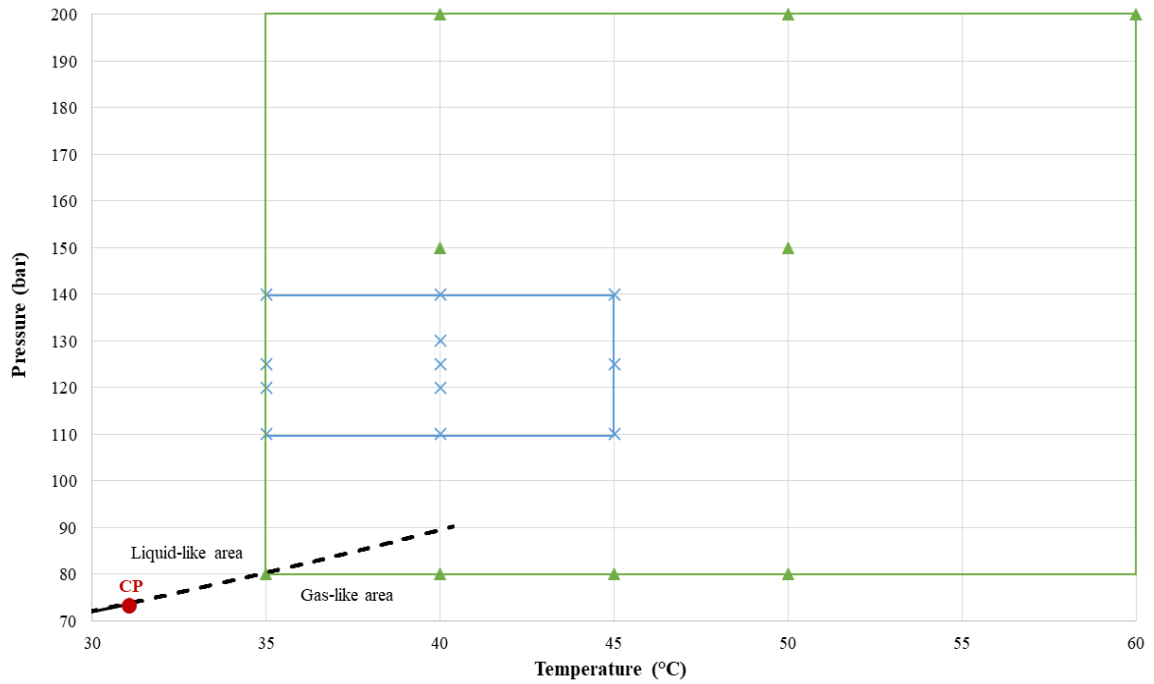

Figure 4: Representation of the CO₂ Widom line (dash line) delimiting the two different zones in the supercritical domain, where CP is the critical point. Delimitation of the experimental area of the study (green lines) and the experimental domain of the experimental design (blue lines). Experiments achieved during this study are represented by blue cross and green triangle respectively for experiments included in and experiments outside the experimental design.

4.2 Design of experiments

A DoE was carried out to highlight the optimal pressure and temperature enabling a bacterial reduction higher than 6-log. The experimental conditions were designed as presented in Table 5. This DoE makes it possible to study the influence of the variations of these four factors on bacterial reduction, and it was designed to include the results of some preliminary observations presented above and thus optimize the number of experiments (Table 6).

Table 5: Studied factors within the operating domain.

Variable	Factors	Operating domain
X ₁	Pressure	[110 – 140] bar
X ₂	Duration	[20 – 120] minutes
X ₃	Additive content	[0 – 200] ppm

X ₄	Temperature	[35 – 45] °C
----------------	-------------	--------------

First of all, it can be highlighted that the targeted bacterial reduction higher than 6-log was obtained for over a third of the experiments (Table 6).

Table 6: Experiments performed to study the effect of pressure (P), duration (D), additive content (A), and temperature (T) on bacterial reduction. Shaded cells correspond to experiments where the bacterial reduction is higher than 6-log.

Experiments	X ₁ : P (bar)	X ₂ : D (min)	X ₃ : A (ppm)	X ₄ : T (°C)	Y: Bacterial Reduction (log)
1	110	45	70	40	5.32±0.42
1bis					4.91±0.0
2	110	60	70	40	5.31±0.39
2bis					4.97±0.13
2ter					4.97±0.19
3	110	60	90	40	5.68±0.08
4	110	90	70	40	5.39±0.51
5	110	120	90	40	5.71±0.32
6	120	60	70	40	5.24±0.10
7	120	120	70	40	5.71±0.53
8	120	120	90	40	6.62±0.66
9	130	120	90	40	5.86±0.18
10	140	20	70	40	5.52±0.42
10bis					5.08±0.34
11	140	30	40	40	5.67±0.57
11bis					5.67±0.25
11ter					4.75±0.67
12	140	37.5	0	40	0

13	140	37.5	50	40	3.17±0.32
13bis					4.39±0.24
14	140	37.5	100	40	6.44±0.24
14bis					6.07±0.47
15	140	60	50	40	5.68±0.39
16	140	60	150	40	7.31±0.73
17	140	60	200	40	7.33±0.018
18	140	80	40	40	5.40±0.86
19	140	60	90	40	5.86±0.25
20	140	20	70	35	4.69±0.28
21	140	20	200	40	8.46±0.0
22	110	120	200	35	8.37±0.36
23	140	120	200	35	8.14±0.95
24	110	20	0	35	0
25	110	20	0	45	0.01±0.02
26	125	20	0	45	0
27	140	120	0	45	0.02±0.03
28	125	20	200	35	8.13±0.77
29	110	120	0	45	0.07±0.1
30	140	120	0	35	0
31	110	20	200	35	7.66±0.45
32	140	20	100	45	4.99±0.66
33	110	20	200	45	8.42±0.035
34	110	120	200	45	7.92±0.62
35	125	70	200	45	8.11±0.66
36	110	120	0	35	0.07±0.03
37	140	120	200	45	8.36±0.20

38	125	70	100	40	7.58±1.0
39	140	20	70	45	7.51±0.74

The polynomial coefficients of Eq. (2) were calculated allowing us to determine the bacterial reduction in any point of the experimental domain, represented by Eq. (3). The R² value is 0.939 which means that the model is efficient. Thanks to the expression of the response (Eq. (3)), it is possible to obtain iso-response curves illustrating the bacterial reduction in any point of the experiment field with color variation: the darker the red, the higher the bacterial reduction. Results for four pressures (110, 120, 130, and 140 bar) and three temperatures (35, 40, and 45 °C) have been illustrated in Figure 5. It can be observed that for all pressures and temperatures, increasing the duration has no significant impact on the bacterial reduction. In contrast, increasing the H₂O₂ content leads to an increase in bacterial reduction. Concerning the pressure, its increase, at a set temperature, leads to an increase in the bacterial reduction for low H₂O₂ content and a decrease for high additive content. However, pressure does not seem to have a strong influence on bacterial reduction for the studied operating conditions. Finally, at a set pressure, temperature variation has little influence on bacterial reduction even if it can be highlighted that the highest bacterial reduction is obtained at 40 °C. In the studied experimental field, the response (Y) is globally highly influenced by the H₂O₂ content, slightly impacted by the pressure and the temperature, and the treatment duration has no significant impact on it.

$$Y = 6.8720 + 0.05652X_1 + 0.05628X_2 + 3.7704X_3 - 0.08320X_4 - 0.28941X_1^2 + 0.03744X_2^2 - 1.6972X_3^2 - 0.90262X_4^2 + 0.01883X_1X_2 - 0.32426X_1X_3 - 0.08440X_1X_4 + 0.18781X_2X_3 + 0.06114X_2X_4 + 0.06265X_3X_4 \quad (3)$$

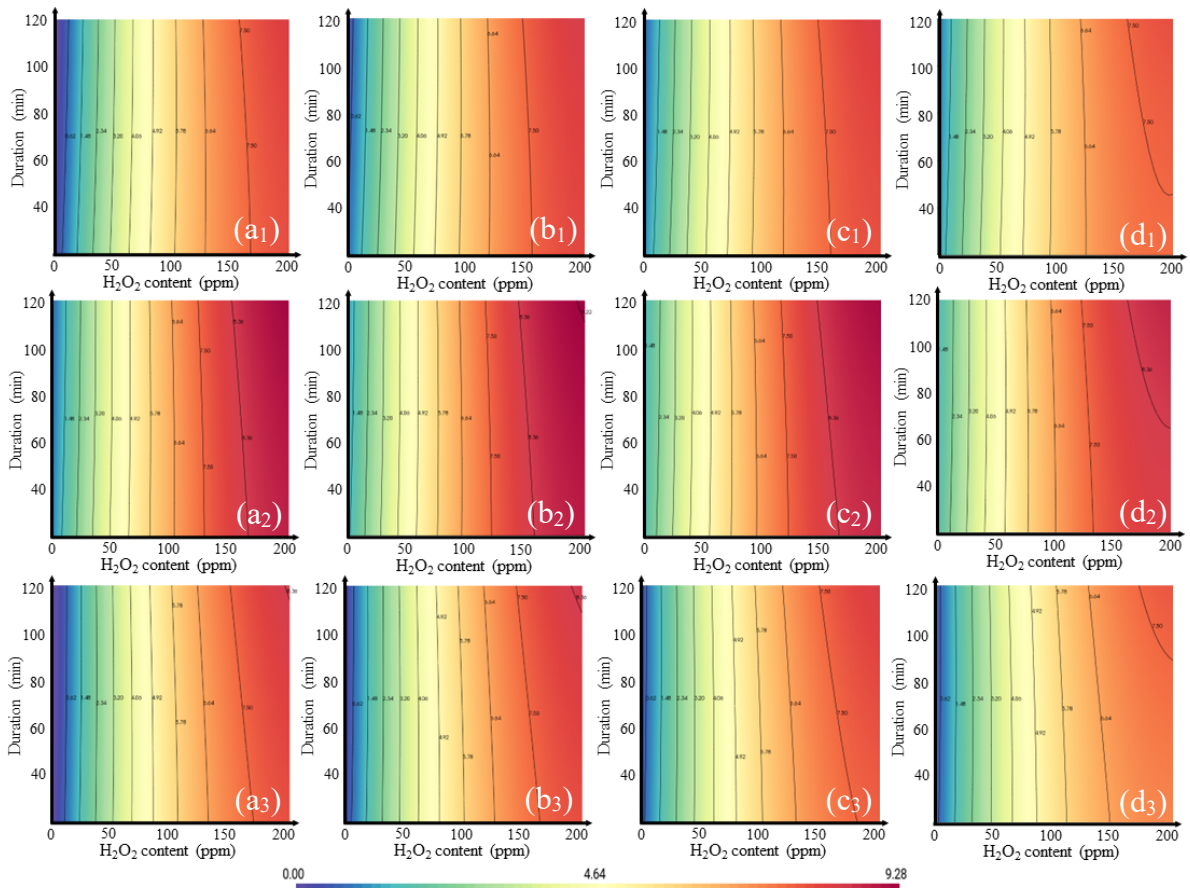

Figure 5: Iso-response curves of bacterial reduction achieved by scCO₂ treatment as a function of additive content and time at 110 at 35 °C (a₁), 40 °C (a₂), and 45 °C (a₃), at 120 bar at 35 °C (b₁), 40 °C (b₂) and 45 °C (b₃), at 130 bar at 35 °C (c₁), 40 °C (c₂) and 45 °C (c₃) and at 140 bar at 35 °C (d₁), 40 °C (d₂) and 45 °C (d₃).

The objective of this experimental design was to find the optimal conditions (pressure, duration, H₂O₂ content, and temperature) that maximize bacterial reduction. For this reason, the desirability approach (cf 3.5) was used. The 3D plots of the optimum areas are represented in Figure 6 with color variation: the darker the red, the higher the desirability. Visually on the 3D plots (Figure 6 (b)), the optimal conditions correspond to a high duration treatment at low/medium pressure, at 40 °C, and with the highest H₂O₂ content studied. Thanks to the desirability approach, optimal conditions could be identified for treatment at 118.5 bar, 40 °C for 120 minutes with 200 ppm of H₂O₂. The bacterial reduction associated is higher than 9-log. Nevertheless, all the areas outside of the dark blue one (Figure 6) can be considered to have a bacterial reduction greater than 6-log and respect the SAL standards. This

result makes it possible to have a large panel of treatment condition possibilities adaptable for several materials.

To stay advantageous industrially, it was decided for the rest of the study to minimize duration and pressure and the optimal sterilization treatment was considered as 110 bar, 40 °C for 20 minutes with 200 ppm of H₂O₂. The bacterial reduction associated was 8.73-log, still greatly higher than 6-log.

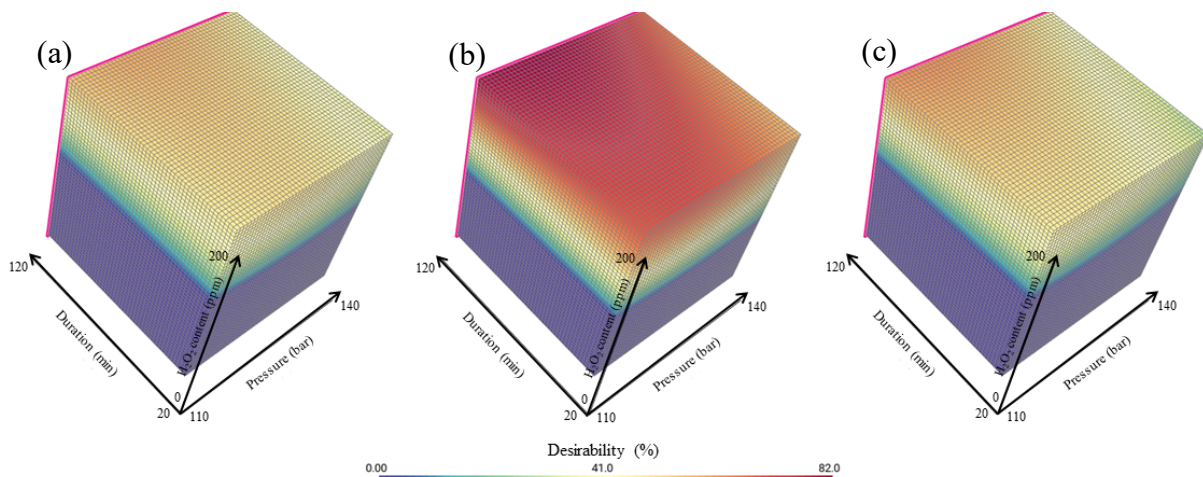

Figure 6: 3D surface plots of desirability (%) to maximize bacterial reduction. Presentation of three temperatures: 35 °C (a), 40 °C (b), and 45 °C (c).

Lastly, an additional test was performed on spore strips of *B. atrophaeus* to validate the sterilization process as done by industrialists. The treatment conditions were the optimal conditions previously highlighted: 110 bar, 40 °C, for 20 minutes with 200 ppm of H₂O₂. Positive control with *B. subtilis* spore inoculum ensured that the culture conditions were optimal and negative control with non-inoculated liquid media validated the absence of contamination. After seven days of inoculation of liquid media with sterilized spore strips, no bacterial growth was observed. It could then be concluded that the optimal sterilization process identified in our study is also efficient on calibrated sterilization biological indicators.

Kinetic models are common illustrations for sterilization treatments to understand their inactivation efficiency, it is the case for example for moist or dry heat sterilization treatment. The kinetics must illustrate the linear decrease in the number of viable spores over time. However, in our study and the studied area, we showed that treatment duration has no significant impact on bacterial reduction while the amount of H_2O_2 does. Therefore, the increase of the bacterial reduction as a function of the additive content was plotted (Figure 7) using Eq. 3, for the optimal conditions determined above which is a treatment at 110 bar, 40 °C for 20 minutes with 200 ppm of H_2O_2 . A linear increase of the treatment efficiency can be observed for the lowest additive contents (approximately up to 50 ppm).

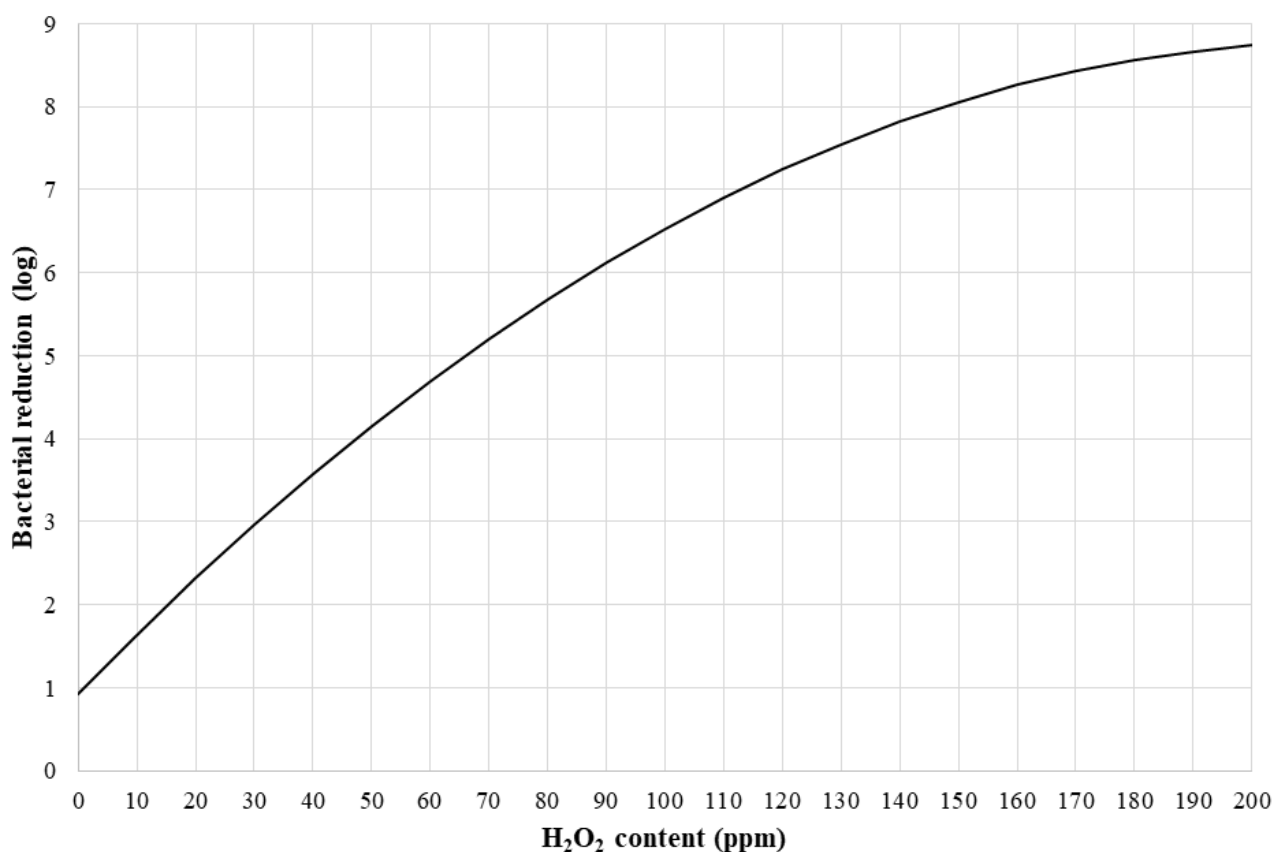

Figure 7: Bacterial reduction according to additive content (0 to 200 ppm) at 110 bar, 40 °C during 20 minutes of treatment with $scCO_2$ in presence of a H_2O_2 aqueous solution.

4.3 Sterilization of inoculated polymers

To investigate the influence of the inoculated support material on the treatment efficiency, an experiment has been performed using 3D printed PLA:PCL (70:30) support in the optimal conditions previously highlighted: 110 bar, 40 °C for 20 minutes with 200 ppm of H_2O_2 . A control has been included in the vessel with inoculated glass slides (as for other experiments) to confirm the inactivation efficiency of the $scCO_2$ treatment in presence of a H_2O_2 aqueous solution. After this treatment, no more

spores were alive, neither on inoculated polymers, nor on control slides and the determined bacterial reduction was greater than 8.45-log. This result suggests that the treatment is equally efficient to sterilize inoculated glass or PLA:PCL sample, meaning that the nature of the inoculated support seems to have no impact on treatment efficiency.

5 Conclusion

Sterilization with scCO₂ has been investigated in the context of IMD. These devices are mainly made of polymers and require soft sterilization treatments, requiring low temperatures and pressures. To implement a supercritical sterilization process adapted to such sensitive materials, this study focused on the treatment of *B. subtilis* spores inoculated on glass slides. During the first part of the work, preliminary experiments were conducted to investigate critical points. It was shown that pure CO₂ is not sufficient to achieve the 6-log bacterial reduction goal. A slight increase in temperature up to 60 °C does not make it possible to improve the efficiency of the treatment and a higher temperature was not tested due to the IMD thermosensitivity. Using an additive was then considered. Water was not sufficient to improve the bacterial reduction while H₂O₂ solution showed convincing results, even at low temperatures. The repeatability of the sterilization process, with and without additive, was confirmed supporting the possibility of using this sterilization treatment on IMD at an industrial scale. To complete this work, a DOE allowed us to identify an operating domain where the 6-log bacterial reduction is reached. It was shown that, in the studied experimental field, sterilization efficiency is highly influenced by the amount of H₂O₂. The more this additive is used, the more effective the treatment is. The temperature and the pressure also have an impact on the treatment effectiveness, but to a lesser extent. If the additive content is sufficient, then the pressure, temperature, and duration can be low, compared to other sterilization treatments. Optimal sterilization process conditions were highlighted at 110 bar, 40 °C for 20 minutes with 200 ppm of H₂O₂, corresponding to a high sterilization efficiency of the treatment with low pressure and treatment duration, which is advantageous at industrial scale. These results are of great interest. Moreover, the treatment has been proven to be as effective on an inoculated PLA:PCL sample, a polymer used for medical devices, as on inoculated glass slides, reference supports used in this study. The process implemented is a real alternative to current sterilization methods, which

can present some drawbacks such as toxic residues in the treated products or modification of the MD properties.

Acknowledgments

The authors are grateful for the financial support of BPI France and the Region Sud PACA in the framework of the project FASTECO₂. They particularly thank Valentine Pepe (Cousin Surgery, Wervicq-Sud, France) and Megann Le Rest (Lattice Medical, Loos, France) for the fruitful discussions. They also thank Dr. Elodie Foulquier (LCB, Marseille, France) for her expertise in *B. subtilis* physiology.

References

- [1] International Organization for Standardization, 2016. ‘Medical devices - Quality management systems - Requirements for regulatory purposes’ (ISO 13485:2016).
- [2] International Organization for Standardization, 2009. ‘Sterilization of health care products — General requirements for characterization of a sterilizing agent and the development, validation and routine control of a sterilization process for medical devices’ (ISO 143927:2009).
- [3] W. A. Rutala and D. J. Weber, ‘Guideline for disinfection and sterilization in healthcare facilities, 2008’, 2008.
- [4] ‘Sterilization of health care products — Moist heat — Part 3: Guidance on the designation of a medical device to a product family and processing category for steam sterilization’. Apr. 2013.
- [5] ‘Sterilization of health care products — Dry heat — Requirements for the development, validation and routine control of a sterilization process for medical devices’. Aug. 2010.
- [6] ‘Sterilization with EtO: the inevitable march towards a reasoned use’, DeviceMed.fr.
- [7] S. D. Ferreira, W S. Dernell, B. E. Powers, R. A. Schochet, C. A. Kuntz, S. J. Withrow, R. M. Wilkins, ‘Effect of Gas-Plasma Sterilization on the Osteoinductive Capacity of Demineralized Bone Matrix’, *Clin. Orthop.*, vol. 388, pp. 233–239, 2001, doi: 10.1097/00003086-200107000-00032.
- [8] ‘Supercritical CO₂: For an ecological cleaning of medical devices’, *DeviceMed*, no. 6, p. 50, 2016.
- [9] ‘Supercritical CO₂ cleaning reduces the bioburden and gets closer to sterilization’, *DeviceMed*, no. 2, pp. 52–53, 2018.
- [10] M. Perrut, ‘Sterilization and virus inactivation by supercritical fluids (a review)’, *J. Supercrit. Fluids*, vol. 66, pp. 359–371, 2012, doi: 10.1016/j.supflu.2011.07.007.
- [11] G. C. Soares, D. A. Learmonth, M. C. Vallejo, S. P. Davila, P. Gonzalez, R. A. Sousa, A. L. Oliveira, ‘Supercritical CO₂ technology: The next standard sterilization technique?’, *Mater. Sci. Eng. C*, vol. 99, pp. 520–540, 2019, doi: 10.1016/j.msec.2019.01.121.
- [12] A. K. Dillow, F. Dehghani, J. S. Hrkach, N. R. Foster, and R. Langer, ‘Bacterial inactivation by using near-and-supercritical carbon dioxide’, *Proc. Natl. Acad. Sci.*, vol. 96, no. 18, pp. 10344–10348, 1999.
- [13] S. Spilimbergo, A. Bertucco, F. M. Lauro, and G. Bertoloni, ‘Inactivation of *Bacillus subtilis* spores by supercritical CO₂ treatment’, *Innov. Food Sci. Emerg. Technol.*, vol. 4, no. 2, pp. 161–165, 2003, doi: 10.1016/S1466-8564(02)00089-9.

- [14] L. Rao, Z. Xu, Y. Wang, F. Zhao, X. Hu, and X. Liao, 'Inactivation of *Bacillus subtilis* spores by high pressure CO₂ with high temperature', *Int. J. Food Microbiol.*, vol. 205, pp. 73–80, 2015, doi: 10.1016/j.ijfoodmicro.2015.04.012.
- [15] L. Rao, F. Zhao, Y. Wang, F. Chen, X. Hu, and X. Liao, 'Investigating the Inactivation Mechanism of *Bacillus subtilis* Spores by High Pressure CO₂', *Front. Microbiol.*, vol. 7, 2016, doi: 10.3389/fmicb.2016.01411.
- [16] S. Furukawa, T. Watanabe, T. Koyama, J. Hirata, N. Narisawa, H. Ogihara, M. Yamasaki, 'Inactivation of food poisoning bacteria and *Geobacillus stearothermophilus* spores by high pressure carbon dioxide treatment', *Food Control*, vol. 20, no. 1, pp. 53–58, 2009, doi: 10.1016/j.foodcont.2008.02.002.
- [17] D. Soares, L. A. Lerin, R. L. Cansian, J. V. Oliveira, and M. A. Mazutti, 'Inactivation of *Listeria monocytogenes* using supercritical carbon dioxide in a high-pressure variable-volume reactor', *Food Control*, vol. 31, no. 2, pp. 514–518, 2013, doi: 10.1016/j.foodcont.2012.11.045.
- [18] Md. S. Hossain, N. N. Nik Ab Rahman, V. Balakrishnan, A. F.M. Alkarkhi, Z. Ahmad Rajion, and M. O. Ab Kadir, 'Optimizing supercritical carbon dioxide in the inactivation of bacteria in clinical solid waste by using response surface methodology', *Waste Manag.*, vol. 38, pp. 462–473, 2015, doi: 10.1016/j.wasman.2015.01.003.
- [19] L. Garcia-Gonzalez, A. H. Geeraerd, S. Spilimbergo, K. Elst, L. Van Ginneken, J. Debevere, J. F. Van Impe, F. Devlieghere, 'High pressure carbon dioxide inactivation of microorganisms in foods: The past, the present and the future', *Int. J. Food Microbiol.*, vol. 117, no. 1, pp. 1–28, 2007, doi: 10.1016/j.ijfoodmicro.2007.02.018.
- [20] S. -I. Hong and Y. -R. Pyun, 'Inactivation Kinetics of *Lactobacillus plantarum* by High Pressure Carbon Dioxide', *J. Food Sci.*, vol. 64, no. 4, pp. 728–733, 1999, doi: 10.1111/j.1365-2621.1999.tb15120.x.
- [21] R. W. Hutkins and N. L. Nannen, 'pH Homeostasis in Lactic Acid Bacteria', *J. Ser. Neb. Agric. Exp. Stn.*, vol. 76, no. 8, 1993, doi: 10.3168/jds.S0022-0302(93)77573-6.
- [22] J. Zhang, S. Burrows, C. Gleason, M. A. Matthews, M. J. Drews, M. La Berge, Y. H. An, 'Sterilizing *Bacillus pumilus* spores using supercritical carbon dioxide', *J. Microbiol. Methods*, vol. 66, no. 3, pp. 479–485, 2006, doi: 10.1016/j.mimet.2006.01.012.
- [23] J. Zhang, N. Dalal, C. Gleason, M. A. Matthews, L. N. Waller, K. F. Fox, A. Fox, M. J. Drews, M. La Berge, Y. H. An, 'On the mechanisms of deactivation of *Bacillus atrophaeus* spores using supercritical carbon dioxide', *J. Supercrit. Fluids*, vol. 38, no. 2, pp. 268–273, 2006, doi: 10.1016/j.supflu.2006.02.015.
- [24] J. Zhang, N. Dalal, M. A. Matthews, L. N. Waller, C. Saunders, K. F. Fox, A. Fox, 'Supercritical carbon dioxide and hydrogen peroxide cause mild changes in spore structures associated with high killing rate of *Bacillus anthracis*', *J. Microbiol. Methods*, vol. 70, no. 3, pp. 442–451, 2007, doi: 10.1016/j.mimet.2007.05.019.
- [25] J. D. Hemmer, M. J. Drews, M. LaBerge, and M. A. Matthews, 'Sterilization of bacterial spores by using supercritical carbon dioxide and hydrogen peroxide', *J. Biomed. Mater. Res. B Appl. Biomater.*, vol. 80B, no. 2, pp. 511–518, 2007, doi: 10.1002/jbm.b.30625.
- [26] A. Checinska, I. A. Fruth, T. L. Green, R. L. Crawford, and A. J. Paszczynski, 'Sterilization of biological pathogens using supercritical fluid carbon dioxide containing water and hydrogen peroxide', *J. Microbiol. Methods*, vol. 87, no. 1, pp. 70–75, 2011, doi: 10.1016/j.mimet.2011.07.008.
- [27] M. A. da Silva, A. P. de Araujo, J. de Souza Ferreira, and T. G. Kieckbusch, 'Inactivation of *Bacillus subtilis* and *Geobacillus stearothermophilus* inoculated over metal surfaces using supercritical CO₂ process and nisin', *J. Supercrit. Fluids*, vol. 109, pp. 87–94, 2016, doi: 10.1016/j.supflu.2015.11.013.
- [28] J. Zhang, T. A. Davis, M. A. Matthews, M. J. Drews, M. LaBerge, and Y. H. An, 'Sterilization using high-pressure carbon dioxide', *J. Supercrit. Fluids*, vol. 38, no. 3, pp. 354–372, 2006, doi: 10.1016/j.supflu.2005.05.005.
- [29] D. R. Zeigler, Z. Pragai, S. Rodriguez, B. Chevreux, A. Muffler, T. Albert, R. Bai, M. Wyss, J. B. Perkins, 'The Origins of 168, W23, and Other *Bacillus subtilis* Legacy Strains', *J. Bacteriol.*, vol. 190, no. 21, pp. 6983–6995, Nov. 2008, doi: 10.1128/JB.00722-08.

- [30] K. Ongkasin, Y. Masmoudi, C. M. Wertheimer, A. Hillenmayer, K. H. Eibl-Lindner, and E. Badens, ‘Supercritical fluid technology for the development of innovative ophthalmic medical devices: Drug loaded intraocular lenses to mitigate posterior capsule opacification’, *Eur. J. Pharm. Biopharm.*, vol. 149, pp. 248–256, Apr. 2020, doi: 10.1016/j.ejpb.2020.02.011.
- [31] V. V. Fedorov, ‘Theory of Optimal Experiments’, *New-York Acad. Press*, 1972.
- [32] T. J. Mitchell, ‘An Algorithm for the Construction of “*D* -Optimal” Experimental Designs’, *Technometrics*, vol. 42, no. 1, pp. 48–54, 2000, doi: 10.1080/00401706.2000.10485978.
- [33] Q.-Q. Qiu, P. Leamy, J. Brittingham, J. Pomerleau, N. Kabaria, and J. Connor, ‘Inactivation of bacterial spores and viruses in biological material using supercritical carbon dioxide with sterilant’, *J. Biomed. Mater. Res. B Appl. Biomater.*, vol. 91B, no. 2, pp. 572–578, 2009, doi: 10.1002/jbm.b.31431.
- [34] Z. Wang, Q. Zhou, H. Guo, P. Yang, and W. Lu, ‘Determination of water solubility in supercritical CO₂ from 313.15 to 473.15 K and from 10 to 50 MPa by in-situ quantitative Raman spectroscopy’, *Fluid Phase Equilibria*, vol. 476, pp. 170–178, 2018, doi: 10.1016/j.fluid.2018.08.006.
- [35] B. Setlow, G. Korza, K. M. S. Blatt, J. P. Fey, and P. Setlow, ‘Mechanism of *Bacillus subtilis* spore inactivation by and resistance to supercritical CO₂ plus peracetic acid’, *J. Appl. Microbiol.*, vol. 120, no. 1, pp. 57–69, 2016, doi: 10.1111/jam.12995.
- [36] A. Bernhardt, M. Wehrl, B. Paul, T. Hochmuth, M. Schumacher, K. Schutz, M. Gelinsky, ‘Improved Sterilization of Sensitive Biomaterials with Supercritical Carbon Dioxide at Low Temperature’, *PLoS ONE*, vol. 10, no. 6, p. e0129205, Jun. 2015, doi: 10.1371/journal.pone.0129205.
- [37] A. Mouahid, P. Boivin, S. Diaw, and E. Badens, ‘Widom and extrema lines as criteria for optimizing operating conditions in supercritical processes’, *J. Supercrit. Fluids*, vol. 186, p. 105587, 2022, doi: 10.1016/j.supflu.2022.105587.