



**HAL**  
open science

## Dielectric relaxation in open circuit: Theory, simulations, and some experiments

Philippe Molinié

► **To cite this version:**

Philippe Molinié. Dielectric relaxation in open circuit: Theory, simulations, and some experiments. Journal of Applied Physics, 2023, 134 (13), pp.134101. 10.1063/5.0170968 . hal-04227497

**HAL Id: hal-04227497**

**<https://hal.science/hal-04227497v1>**

Submitted on 3 Oct 2023

**HAL** is a multi-disciplinary open access archive for the deposit and dissemination of scientific research documents, whether they are published or not. The documents may come from teaching and research institutions in France or abroad, or from public or private research centers.

L'archive ouverte pluridisciplinaire **HAL**, est destinée au dépôt et à la diffusion de documents scientifiques de niveau recherche, publiés ou non, émanant des établissements d'enseignement et de recherche français ou étrangers, des laboratoires publics ou privés.

# Dielectric relaxation in open circuit. Theory, simulations and some experiments.

P. Molinié<sup>1a)</sup>

<sup>1</sup>*Laboratoire de Génie Electrique et Electronique de Paris (GeePs), Université Paris-Saclay, CentraleSupélec, CNRS, Gif-sur-Yvette, 91192, France*

Static charge on insulating material surfaces may be a source of nuisance as well as an operational requirement in many devices. It induces a potential which evolves with time, due to conduction and polarization processes in the dielectric. We analyze here from a theoretical and experimental point of view the response of an insulator subjected to a charging pulse, within the frame of linear system theory. The surface potential decay and the return voltage after a brief neutralization, that can be easily measured using an electrostatic probe, are usually following time power laws. We consider here a dielectric following the classical Cole-Cole response function in the frequency domain, and we derive an exact analytic formula for the potential decay, which involves a Mittag-Leffler function. The relationship between the potential decay and the absorption current when a constant voltage is applied on the dielectric is also analyzed. Experiments on several common insulating materials are analyzed according to this theory, using a numerical simulation with a two cell model. Return voltage measurements are used to check which materials behave according to the linear model. We underline that an equivalent circuit using constant-phase elements, corresponding to several cells following the Cole-Cole response, can represent as well dipolar motions in the dielectric as charge hopping between energy-distributed traps.

## I. INTRODUCTION

Of particular importance is the characterization of the time-domain electrical response of a dielectric in open circuit. High voltage that may be induced on insulating surfaces by tribocharging, ionic or electron impact, is a well-known risk in countless areas, from hydrocarbon handling to grain storage silos or rocket propellant manufacturing. Spacecraft charging is also one of the main causes of satellite failure<sup>1</sup>. The fast development of HVDC systems and networks in electrical engineering also causes a renewed interest in the electrostatic behavior of insulating materials subjected during a long period to a DC polarization, since it determines the electric field distribution at their surfaces<sup>2,3</sup>. Significant ongoing research also aims to develop or improve applications relying on the control of the electrostatic charge trapped on the surface or in the volume of a material, such as electret devices for mobile telephone microphones<sup>4</sup>, energy harvesting generators based on the piezoelectric properties of newly developed polymers<sup>5</sup>, or

---

<sup>a</sup> Author to whom correspondence should be addressed. Electronic mail: philippe.molinie@centralesupelec.fr

electrostatic separators for plastic waste treatment<sup>6</sup>. The measurement of return voltage in open circuit is also a technique allowing ageing monitoring of large industrial transformers<sup>7, 8</sup>.

Using commercial electrostatic probes, the measurement of the surface potential in open circuit is quite simple to perform. Surface potential decay and voltage return measurements are classic techniques for characterizing insulating materials, and, by measurement at several temperatures, to some extent determine the trapping energies<sup>9, 10</sup>. Their main advantages are on the one hand to allow the precise monitoring of very slow charge motion and relaxation processes, and on the other hand to allow surface mapping and detection of weak points.

The theoretical interpretation of surface potential measurements relies on a quite abundant literature<sup>11</sup>. Most theoretical research work on this topic is also ancient, dating back to the 1970s. This is due in a large part to the development in that decade of xerography and then laser printing. It required precise control of charge stability and removal in insulating or photoconductive drums, and was also at the origin of the first reliable commercial electrostatic probes. This literature was mainly devoted to link space charge motion within a dielectric with or without traps with the surface potential observable<sup>12, 13</sup>. In 1967 Japanese researchers had reported that on a polymer film charged at high field, an initial higher charging potential leads after a given decay time to a lower potential<sup>14</sup>. In the following years, many theoretical papers attempted to find an explanation for this “cross-over” phenomenon which is ultimately due to the occurrence of charge injection from the surface to the bulk above a given field threshold<sup>15</sup>. The possibility of deducing from potential decay curves the trap distribution in energy of a material was also explored later<sup>16</sup> and was widely exploited in the field of electret development, where, unlike xerography, maximum charge trapping stability was sought<sup>17</sup>.

The practical difficulty is however to discriminate in the measured signal what is due to space charge motion into the bulk from the dielectric response to the electric field. Slow polarization processes cannot indeed be ruled out in polymers and polycrystalline ceramics, and at low fields, they are usually dominant in the time range concerned (typically from one second to a few hours). While this component of the insulator response to the field is central concerning dielectric spectroscopy, it is however often neglected in the interpretation of surface potential data, despite studies showing on some materials the predominance of this response<sup>18, 19</sup>. Dielectric spectroscopy and time domain

measurements are often considered by experimenters as complementary techniques, but they generally lack theoretical tools to analyze the dielectric response in the time domain comparable to what exists in the frequency domain.

One explanation for this comes from the greater mathematical complexity involved in processing the response in the time domain. In the frequency domain, dielectric spectroscopy data are commonly fitted using the phenomenological relaxation models of Cole-Cole<sup>20</sup>, Havriliak-Negami<sup>21</sup> or Kohlrausch-Williams-Watts<sup>22</sup>, which reproduce well this dielectric behavior by simple transfer functions involving one, two or three parameters. In the time domain, it is known from the pioneering works of Rudolf Kohlrausch<sup>23</sup> and Jacques Curie<sup>24</sup> in the nineteenth century that this response involves a time power law. This concerns both the decrease in the absorption current after the application of a DC voltage (Curie-Von Schweidler law) and the potential decay after a surface charge deposit. However, to describe the complete dynamics of relaxation, at least two exponents are usually necessary, an exponent lower than one at short times, and another larger than one at long times<sup>25</sup>. A correct mathematical treatment of this problem requires the calculation of the inverse Laplace transform of the transfer functions describing the spectroscopic data. The mathematical form of the result involves Mittag-Leffler functions<sup>26</sup>.

The mathematical features of the “anomalous discharge” of a condenser in the time domain were published in the literature more than eighty years ago by Gross<sup>27</sup> and de Oliveira Castro<sup>28</sup>, as recalled by a recent review<sup>29</sup>. They developed a detailed analysis of the response of an insulator in open circuit, assuming a response following the Curie-Von Schweidler law, and obtained Mittag-Leffler functions. However, in the modern literature dedicated to time domain measurements on solid dielectrics, to our knowledge, no mathematical description of the potential decay or return dynamics based on Mittag-Leffler functions can be found. This is probably a delayed consequence of the complexity of Mittag-Leffler functions, which can only be given as an infinite sum of a convergent series. In one of their well-known seminal papers published in 1942, the Cole brothers made the following comment on Gross work: “the analysis of dielectric phenomena in terms of potential rather than current variations does not appear to be very useful experimentally as the mathematical expressions involved are difficult to handle in numerical form.”<sup>30</sup>

However, modern software nowadays makes it possible to quickly and accurately calculate Mittag-Leffler functions or perform various tasks in the broader domain of fractional calculus<sup>31</sup>. Fractional components and Mittag-Leffler functions are quite commonly mentioned and implemented in the fields of electrochemistry<sup>32, 33</sup> and impedance

studies in biological systems<sup>34</sup>. They should also be used in the field of dielectric characterization in the time domain. This article is a contribution in this direction.

## II. THEORETICAL ANALYSIS OF THE DIELECTRIC RESPONSE IN THE TIME DOMAIN

### A. The dielectric as a linear system in closed and open circuit

#### 1. Response functions

At the surface of a dielectric, assuming the electric field to be null outside, the following relationship may be written between the surface charge density  $q(t)$  and the internal field  $E(t)$  in the material:

$$q(t) = \varepsilon_{\infty}E(t) + P(t) \quad (1)$$

$P(t)$  being the polarization in the material and  $\varepsilon_{\infty}$  its permittivity including the polarization phenomena fast enough to follow the electric field variations, the other being included in  $P(t)$ .

It will be assumed here that the surface charge cannot be supplied or evacuated by any means other than an external circuit, which implies that the dielectric conductivity is negligible and that the surface charge cannot drift inside the material during the experiment. Besides, we assume the dielectric to be a linear system obeying to the superposition principle. These assertions are valid in many usual configurations, especially when the electric field is moderate. This last requirement means that the system physical properties are assumed to be invariant in time, and the static polarization  $P_s$  to be proportional to a static applied field  $E_s$ :

$$P_s = (\varepsilon_s - \varepsilon_{\infty})E_s \quad (2)$$

This does not imply however that at a given instant  $P(t)$  is proportional to  $E(t)$ , since the polarization process may have a delayed component. The surface charge at a given time will then depend on the past values of the electric field according to a convolution relationship<sup>35</sup>, for instance:

$$q(t) = \varepsilon_{\infty}E(t) + (\varepsilon_s - \varepsilon_{\infty}) \int_0^{\infty} \phi(\theta)E(t - \theta)d\theta \quad (3)$$

$\varepsilon_s$  being the static permittivity and  $\phi(t)$  a dielectric response function of the material.

A complementary relationship may be written between the charge and the field, involving another dielectric response function  $\phi_*$ :

$$E(t) = \frac{q(t)}{\varepsilon_\infty} + \left( \frac{1}{\varepsilon_s} - \frac{1}{\varepsilon_\infty} \right) \int_0^\infty \phi_*(\theta) q(t - \theta) d\theta \quad (4)$$

Several forms may be chosen for the relaxation functions. The definitions for  $\phi$  and  $\phi_*$  are chosen here for normalization ( $\int_0^\infty \phi(t) dt = \int_0^\infty \phi_*(\theta) d\theta = 1$ )

### 2. Closed circuit: absorption and resorption currents

Applying a potential  $V(t) = V_0 \Gamma_0(t)$  ( $\Gamma_0(t)$  being the Heaviside step function) to a dielectric slab of thickness  $d$  through conductive electrodes at  $t = 0$ , the current density  $j_{abs}(t)$  flowing into the dielectric is proportional to  $\phi(t)$ , after the initial current peak due to the vacuum and fast polarization phenomena:

$$j_{abs}(t) = dq(t)/dt = V_0/d (\varepsilon_\infty \delta_0(t) + (\varepsilon_s - \varepsilon_\infty) \phi(t)) \quad (5)$$

$\delta_0(t)$  being the Dirac function centered in  $t=0$

The measurement of this “absorption current” provides a direct image of the dielectric response function. A short circuit of the insulator may then be performed after a given polarization time (figure 1). In close circuit, because of the delayed component of the polarization, a resorption current  $j_{res}(t)$  will then flow which is very similar to the absorption current. Linearity implies that, after short circuiting at  $t = 0$ :

$$j_{res}(t) = j_{abs}(t + t_n) - j_{abs}(t) \quad (6)$$

Assuming the polarization time before short circuit long enough to lead to static polarization equilibrium, the first term vanishes, and the resorption current has the same expression, with an opposite sign, than the absorption current.

### 3. Open circuit: potential decay and return

We consider here the same dielectric slab in open circuit. This implies not only a physical opening of the electric circuit, but also the absence of any external disturbing electrostatic influence through this opening. That practically means that the electric field must be zero on one of the dielectric surfaces. This boundary condition is usually met by

the use of an electrostatic probe connected with a voltage supply and operating on the Kelvin-Zisman feedback principle, which allows the probe to be constantly at surface voltage. The dielectric surface will be charged or discharged, for instance by contact or corona, during a temporary removal of the probe.

Applying at  $t = 0$  a charge step  $q(t) = q_0 \Gamma_0(t)$  on the surface of the insulator, an initial potential  $V_0 = dq_0/\epsilon_\infty$  is induced on the insulator surface (assuming its opposite surface to be grounded). Letting it evolve in open circuit, we may derive from (4) an equation describing the field:

$$E(t) = \frac{q_0}{\epsilon_\infty} \Gamma_0(t) + \left( \frac{1}{\epsilon_s} - \frac{1}{\epsilon_\infty} \right) q_0 \int_0^t \phi_*(\theta) d\theta \quad (7)$$

The time derivative of the voltage decay  $V_{DP}(t)$  is thus proportional to the response function  $\phi_*(t)$ :

$$\frac{dV_{DP}(t)}{dt} = V_0 \delta_0(t) + V_0 \left( \frac{\epsilon_\infty}{\epsilon_s} - 1 \right) \phi_*(t) \quad (8)$$

The delayed component of the polarization will induce a return voltage<sup>36</sup> after a temporary short-circuit of the charged insulator (figure 1). Considering this neutralization to be performed after a given relaxation time  $t_n$ , and this moment as the new time origin, we now get  $q(t) = q_0 \Gamma_{-t_n}(t) - q_0 [V_{DP}(t_n)/V_0] \Gamma_0(t)$  and the return voltage  $V_{RP}(t)$  may be deduced from the voltage decay using the superposition principle:

$$V_{RP}(t) = V_{DP}(t + t_n) - [V_{DP}(t_n)/V_0] V_{DP}(t) \quad (9)$$

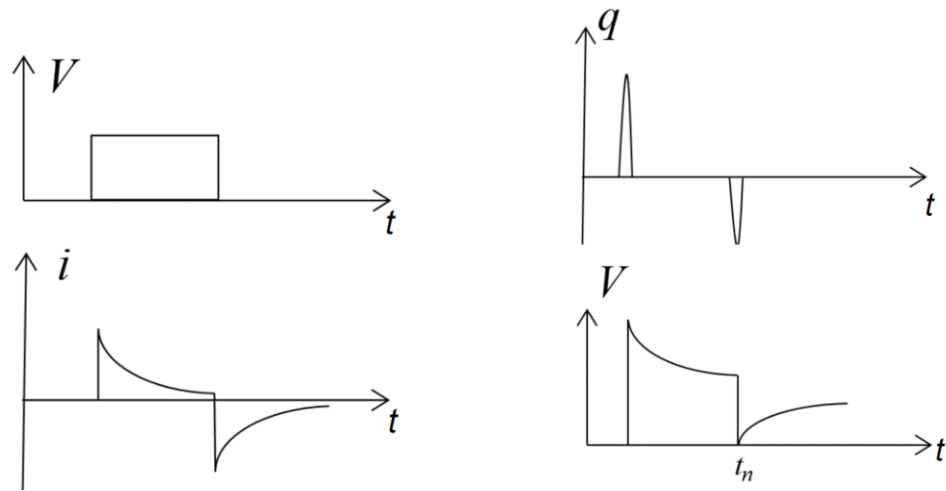

FIG. 1. Closed and open circuit measurements: (left) absorption/resorption current (right) voltage decay and return

The Laplace transform of the convolution product of two functions is equal to the product of the Laplace transforms of these functions. Hence from (3) and (4), it may easily be deduced that the Laplace transform of  $\phi_*$  may be deduced from the Laplace transform of  $\phi$ :

$$\tilde{\phi}_*(s) = \frac{\varepsilon_s \tilde{\phi}(s)}{\varepsilon_\infty + (\varepsilon_s - \varepsilon_\infty) \tilde{\phi}(s)} \quad (10)$$

This relationship is the key equation linking the response in open circuit with the response in closed circuit. The response function  $\phi(t)$  and its Laplace transform are usually better known, since they may be obtained by AC or DC current measurements in close circuit.

From (5), the Laplace transform of the absorption current is directly linked to  $\tilde{\phi}(s)$ :

$$\tilde{j}(s) = \frac{V_0}{d} (\varepsilon_\infty + (\varepsilon_s - \varepsilon_\infty) \tilde{\phi}(s)) \quad (11)$$

From (8) and (10), the Laplace transform of the potential decay derivative may also be expressed as a function of  $\tilde{\phi}(s)$ :

$$\left(\frac{dV}{dt}\right)(s) = V_0 \left[1 + \left(\frac{\varepsilon_\infty}{\varepsilon_s} - 1\right) \tilde{\phi}_*(s)\right] = V_0 \left[\frac{1}{1 + (\varepsilon_s/\varepsilon_\infty - 1) \tilde{\phi}(s)}\right] \quad (12)$$

In the s-domain, a simple relationship may be therefore deduced between the absorption current in closed circuit and the voltage decay in open circuit:

$$\tilde{j}(s) \frac{d\tilde{V}}{dt}(s) = q_0 V_0 \quad (13)$$

The calculation of the potential decay and its derivative from the response function  $\phi$  or from the absorption current involves an inverse Laplace transform calculation. An analytical solution for this problem may be found for some usual response functions, as will be shown in the next section.



#### 4. RC equivalent circuit

On the same insulator, closed and open circuit measurements lead to slightly different dynamics. This may be illustrated by the equivalent circuit shown figure 2. Lowercase  $c$  and  $z$  notations correspond to capacitance and impedance per unit area.

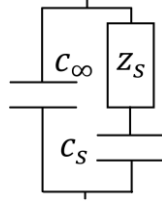

FIG. 2. Equivalent circuit for the insulator.

The Laplace transform of the current density flowing through this dipole subjected to a voltage step  $V_0 \Gamma_0(t)$  is:

$$\tilde{j}(s) = \frac{V_0}{s} \left( s c_\infty + \frac{s c_s}{1 + s \tilde{z}_s c_s} \right) = V_0 \left( c_\infty + c_s \frac{1}{1 + s \tilde{z}_s c_s} \right) \quad (14)$$

Comparing (14) with (11), it is clear that the equivalent circuit shown figure 2 may represent any dielectric which response function may be written in the following polynomial form:

$$\tilde{\phi}(s) = (1 + s \tilde{z}_s c_s)^{-1} \quad (15)$$

The physical significance of this model is that the capacitance  $c_\infty = \epsilon_\infty/d$  includes the instantaneous and fast polarization phenomena while the series dipole formed by  $z_s$  and  $c_s = (\epsilon_s - \epsilon_\infty)/d$  represents the polarization phenomena occurring during the experiment. During an absorption current measurement, after an initial peak allowing to charge  $c_\infty$ , the current decay is determined by the progressive charge of  $c_s$ , while during a potential decay experiment the system discharges the series association of  $c_s$  and  $c_\infty$ . This capacitance is smaller, hence the relaxation time of the potential decay will be smaller than that of the absorption current.

### B. Cole-Cole relaxation in the time domain

#### 1. Response function and behavior in closed circuit

The relaxation occurring in a diluted and homogeneous medium, which can be viewed as the relaxation of non-interacting dipoles, has been described by Debye. When the applied field is cancelled, assuming proportionality of the

rate of the phenomenon to its deviation from equilibrium, an exponential decay of the polarization occurs, following a characteristic time  $\tau$ . The Debye response function  $\phi_D(t) = (1/\tau)e^{-t/\tau}$  decays exponentially with time, as well as the absorption and resorption currents. In the complex frequency domain, the Laplace transform of the Debye response function is

$$\tilde{\phi}_D(s) = (1 + s\tau)^{-1} \quad (16)$$

In a solid or a liquid dielectric, interacting dipoles and disorder usually produce a non-exponential response involving power laws. A phenomenological analysis of dielectric spectroscopy data has led to several mathematical descriptions of the response functions, the most famous being associated to the names of Cole and Cole, Havriliak and Negami or Kohlrausch, Williams and Watts. For practical reasons, we will limit our treatment here to a dielectric model following a Cole-Cole response function. It is the only one of these functions that could be fitted by an equation analog to (15) and therefore suitable to be represented by a dipole that could then quite easily be included in a network.

The Laplace transform of the Cole-Cole response function may be written:

$$\tilde{\phi}_{CC}(s) = (1 + s^\alpha \tau^\alpha)^{-1} \quad \text{with } 0 \leq \alpha \leq 1 \quad (17)$$

For practical reasons, we have chosen this definition of  $\alpha$  rather than the  $(1 - \alpha)$  exponent coming from the original paper<sup>20</sup>. This choice is in agreement with many recent publications<sup>26</sup>. Debye relaxation is a particular case of (17) with  $\alpha = 1$ .

It has been established several decades ago<sup>29</sup> that the response in the time domain corresponding to (17) involves a Mittag-Leffler function:

$$\phi_{CC}(t) = \frac{1}{\tau} (t/\tau)^{\alpha-1} E_{\alpha,\alpha}(-(t/\tau)^\alpha) \quad (18)$$

The generalized Mittag-Leffler function  $E_{\alpha,\beta}$  is a complex function of the complex variable  $z$  defined by the following series involving the Euler gamma function  $\Gamma(z)$ :

$$E_{\alpha,\beta}(z) = \sum_{k=0}^{\infty} \frac{z^k}{\Gamma(\alpha k + \beta)} \quad \text{with } \Gamma(z) = \int_0^{\infty} t^{z-1} e^{-t} dt \quad (19)$$

Its asymptotic behavior involves time power laws, as follows<sup>26</sup>:

$$\phi_{CC}(t) \approx \frac{1}{\tau\Gamma(\alpha)} (t/\tau)^{\alpha-1} \quad \text{for } t/\tau \ll 1 \quad (20)$$

$$\phi_{CC}(t) \approx \frac{1}{\tau\Gamma(-\alpha)} (t/\tau)^{-\alpha-1} \quad \text{for } t/\tau \gg 1 \quad (21)$$

The  $\alpha$  parameter may be deduced from dielectric spectroscopy measurements as well as from time domain measurements in closed or open circuit. For  $\alpha = 1$  the Mittag-Leffler function  $E_{\alpha,\alpha}$  is reduced to the classical exponential.

In closed circuit, assuming Cole-Cole relaxation, from (5) we deduce that absorption currents will decay following a Mittag-Leffler function:

$$j = \frac{V_0}{d} \left[ \epsilon_\infty \delta_0(t) + (\epsilon_s - \epsilon_\infty) \frac{1}{\tau} (t/\tau)^{\alpha-1} E_{\alpha,\alpha}(-(t/\tau)^\alpha) \right] \quad (22)$$

Assuming Debye relaxation, absorption and desorption currents are decaying exponentially with time. The Cole-Cole relaxation behavior leads to asymptotic lines of slope  $(-1 + \alpha)$  at short times and  $(-\alpha - 1)$  slope at long times on a bilogarithmic plot of the absorption or desorption current. As mentioned in the introduction, this experimental behavior involving power laws is a general feature in condensed matter.

A material following the Cole-Cole dielectric behavior may be modelled by the circuit given figure 2, the dipole  $\tilde{z}_s = \tau^\alpha s^{\alpha-1}/c_s$  being a constant phase element (CPE): the ratio between its imaginary and real parts does not depend on frequency<sup>20</sup>. This kind of dipole is in common use as a series element in electrochemistry and bioimpedance studies. It is however much less common concerning electrical engineering. Let us remark again that the possibility to use of this kind of element is a particular property of the Cole-Cole response function. Considering for instance the stretched exponential involved in the Kohlrausch-Williams-Watts relaxation function defined in the time domain by  $\phi_{KWW}(t) = \gamma/\tau (t/\tau)^{\gamma-1} e^{-(t/\tau)^\gamma}$  or the Havriliak-Negami relaxation function defined in the s-domain by  $\tilde{\phi}_{HN}(s) = \tau^{-\alpha\gamma} (s^\alpha + \tau^{-\alpha})^{-\gamma}$ , it is not possible to use a simple representation like this.

## 2. Potential decay

Combining (12) and (17), and considering  $\tau_1 = \tau \left( \frac{\varepsilon_\infty}{\varepsilon_s} \right)^{1/\alpha}$  we obtain the Laplace transform of the voltage derivative obtained in open circuit after charging at  $V_0$  at  $t = 0$ :

$$\mathcal{L}\left\{\frac{dV}{dt}\right\} = V_0 \left(1 + \frac{\varepsilon_\infty/\varepsilon_s - 1}{1 + s^\alpha \tau_1^\alpha}\right) \quad (23)$$

From the known properties of the generalized Mittag-Leffler functions<sup>26</sup>:

$$\mathcal{L}\{t^{\beta-1} E_{\alpha,\beta}[-(t/\tau)^\alpha]\} = \frac{s^{\alpha-\beta} \tau^\alpha}{1 + s^\alpha \tau^\alpha} \quad (24)$$

$$(t/\tau_1)^\alpha E_{\alpha,\alpha+1}(-(t/\tau_1)^\alpha) = 1 - E_{\alpha,1}(-(t/\tau_1)^\alpha) \quad (25)$$

Considering (23) and (24) with  $\beta = \alpha$  we get:

$$\frac{dV(t)}{dt} = V_0 \left\{ \delta_0(t) - \frac{1}{\tau_1} \left(1 - \frac{\varepsilon_\infty}{\varepsilon_s}\right) (t/\tau_1)^{\alpha-1} E_{\alpha,\alpha}[-(t/\tau_1)^\alpha] \right\} \quad (26)$$

Considering the voltage, from (23) and (24) with  $\beta = \alpha + 1$  we get:

$$\mathcal{L}\{V(t)\} = V_0 \left( \frac{1}{s} + \frac{1}{s} \frac{\varepsilon_\infty/\varepsilon_s - 1}{1 + s^\alpha \tau_1^\alpha} \right) = V_0 \mathcal{L}\left\{ \Gamma_0(t) - \left(1 - \frac{\varepsilon_\infty}{\varepsilon_s}\right) (t/\tau_1)^\alpha E_{\alpha,\alpha+1}[-(t/\tau_1)^\alpha] \right\} \quad (27)$$

Using (25):

$$V(t) = V_0 \left[ \Gamma_0(t) - \left(1 - \frac{\varepsilon_\infty}{\varepsilon_s}\right) [1 - E_{\alpha,1}(-(t/\tau_1)^\alpha)] \right] \quad (28)$$

Hence, for  $t > 0$ , considering  $\Delta V = V_0 \left(1 - \frac{\varepsilon_\infty}{\varepsilon_s}\right)$ , we may write:

$$V(t) = V_0 - \Delta V [1 - E_{\alpha,1}(-(t/\tau_1)^\alpha)] \quad (29)$$

$$\frac{dV(t)}{dt} = -\Delta V \frac{1}{\tau_1} (t/\tau_1)^{\alpha-1} E_{\alpha,\alpha}(-(t/\tau_1)^\alpha) \quad (30)$$

The voltage decay and its derivative may hence be analytically given using simple Mittag-Leffler functions. They depend on three main parameters:  $\tau_1$  (characteristic time),  $\Delta V/V_0 = (1 - \varepsilon_\infty/\varepsilon_s)$  (slow polarization relative amplitude), and  $\alpha$  (shape of the potential decay). A computation of the voltage decay and its time derivative is given

figure 3 for  $\Delta V/V_0 = 0.5$  and several values of  $\alpha$ . The time derivative of the potential is decaying as  $(t/\tau_1)^{1-\alpha}$  for  $t/\tau_1 \ll 1$  and as  $(t/\tau_1)^{-1-\alpha}$  for  $t/\tau_1 \gg 1$ .

It has to be noticed that the current obtained multiplying the potential derivative given in (30) by the capacitance per unit area  $\epsilon_s/d$  is the absorption current flowing when the same  $V_0$  voltage is applied, except that the time constant has to be replaced by  $\tau_1 = \tau(\epsilon_\infty/\epsilon_s)^{1/\alpha}$ .

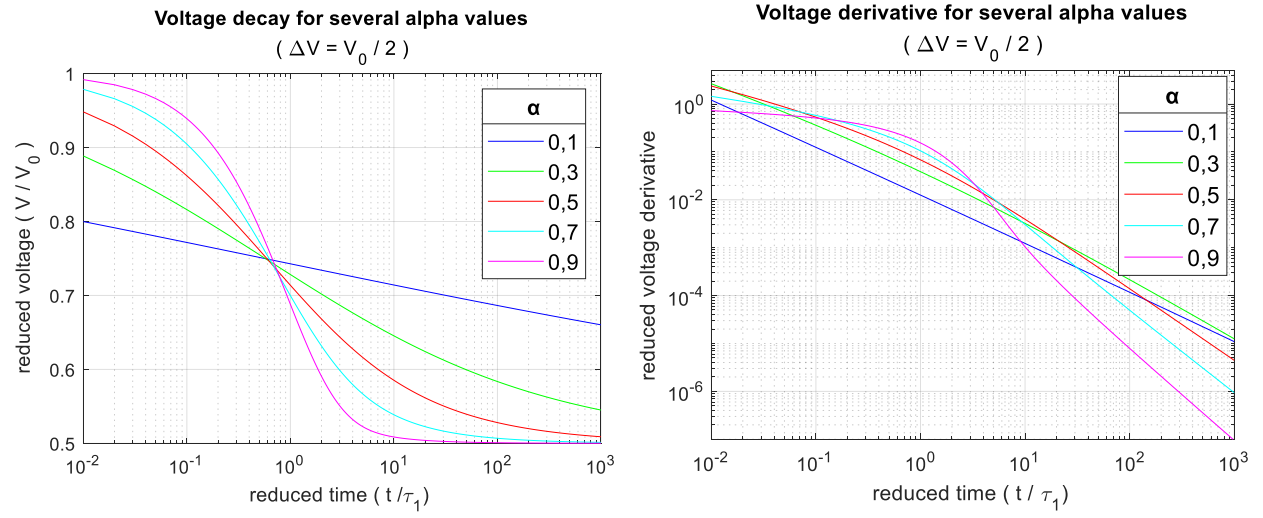

FIG. 3. Computation of the voltage decay given by equation (29) and its derivative (30) for several values of  $\alpha$  and for  $\epsilon_s/\epsilon_\infty = 2$

From (9) and (29), the return voltage after a short time neutralization may be deduced. It is given figure 4 for a neutralization performed at  $t = \tau_1$  after the voltage decay given figure 3 for  $t < \tau_1$ .

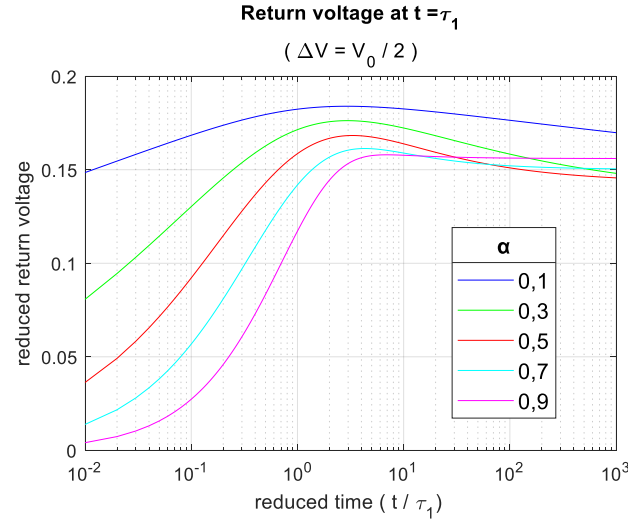

FIG. 4. Computation of the return voltage following a neutralization at  $t = \tau_1$  after the voltage decay given figure 3 for  $t < \tau_1$

### III. VOLTAGE DECAY INDUCED BY MULTIPLE COLE-COLE RELAXATIONS

On several time decades, the response of an insulator is rarely depending on a single physical phenomenon. Broadband dielectric spectroscopy measurements may be analyzed in terms of elementary relaxation processes, which may be Debye, Cole-Cole, or Havriliak-Negami. For an elementary Cole-Cole relaxation, the imaginary part of the permittivity may be easily calculated from equation (17):

$$\varepsilon'' = (\varepsilon_s - \varepsilon_\infty) \frac{\omega^\alpha \tau^\alpha \sin(\pi\alpha/2)}{1 + (\omega^\alpha \tau^\alpha)^2 + 2\omega^\alpha \tau^\alpha \cos(\pi\alpha/2)} \quad (31)$$

Each peak represented in dashed lines figure 5 has been computed using equation (31) with three different sets of parameters. The global frequency dependence of the permittivity may then be fitted by a sum of several such processes, as described figure 5. This is a classical procedure<sup>37</sup> which may be used to identify a wide variety of polarization processes, including space charge motion, each presenting its own activation energy, dependence on relative humidity, or material ageing<sup>38</sup>. These elementary relaxation processes are assumed to contribute by adding their currents when the material is subjected to a given AC voltage. The underlying assumption is thus that the material may be considered as a circuit composed of several parallel cells, each corresponding to an elementary relaxation process.

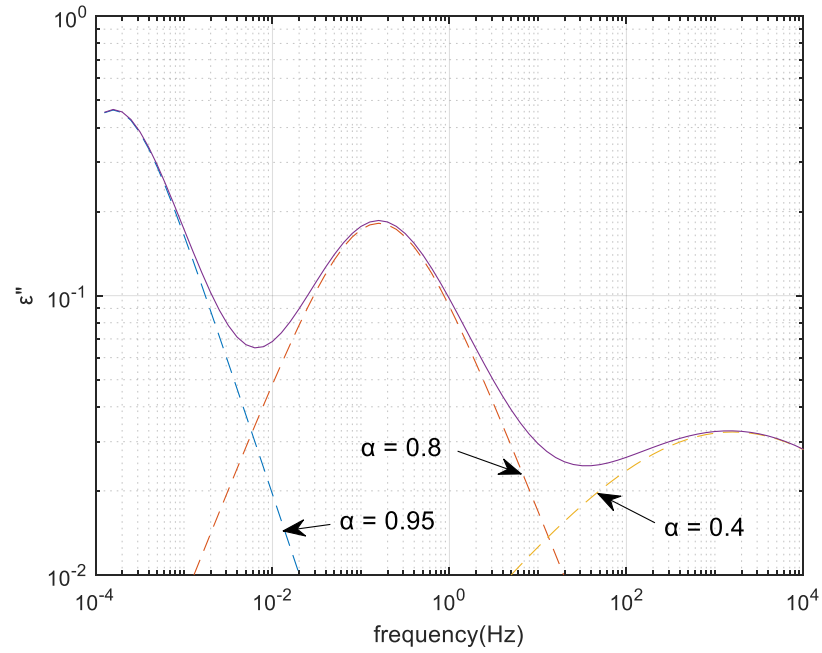

FIG. 5. Complex spectrum due to three Cole-Cole relaxation processes ( $\alpha = 0.95, 0.8, 0.4$  ;  $\tau = 1000s, 1s, 10^{-4}s$  ;  $(\epsilon_s - \epsilon_\infty) = 1, 0.5, 0.2$ )

Concerning open-circuit measurements, the insulator global response may also be seen as the sum of several elementary Cole-Cole relaxation processes, each described by equation (30) with its own parameters  $\alpha_i, \tau_i$  and  $\Delta V_i$ , as shown figure 6 for the same relaxation cells than figure 5. Since voltage are measured, we will here consider the insulator as a circuit composed of several series cells, as shown on the right part of figure 6.

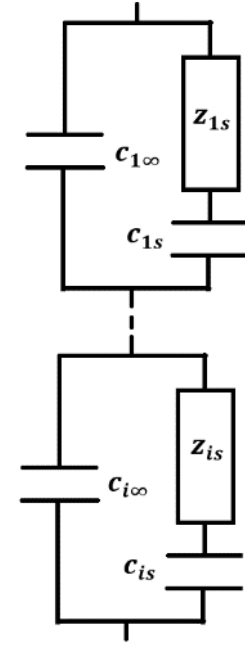
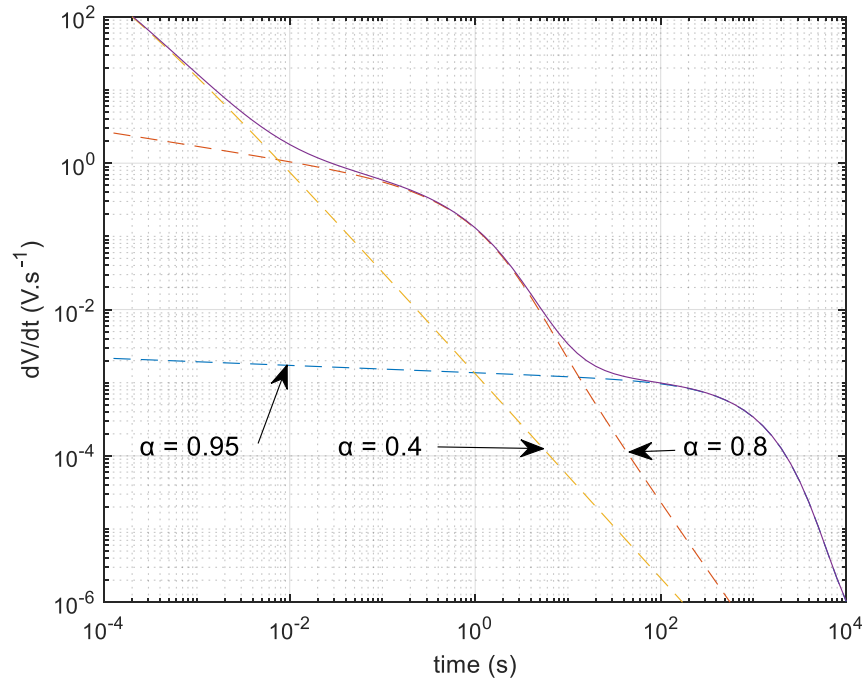

FIG. 6. Voltage decay due to the Cole-Cole relaxation processes considered figure 5 and series cells model.

The potential decay after an initial charging at  $V_0$  of a system made of  $n$  series cells like these may be written:

$$V(t) = V_0 - \sum_{i=1}^n \Delta V_i [1 - E_{\alpha_i, 1}(-(t/\tau_i)^{\alpha_i})] \quad (32)$$

$\alpha_i$ ,  $\tau_i$  and  $\Delta V_i$  being parameters associated with the  $i$  cell.

For a system at  $n$  cells,  $3n+1$  parameters have to be determined from the experimental data, including the value of  $V_0$  which is not easy to determine directly from the experiment (because of the charging duration and the transit time during which the polarization processes have begun before the first potential measurement). The choice of  $n$  is somewhat arbitrary,  $n$  should be minimum but should lead to a good fit of the measurements. Concerning the experiments described below, two cells were sufficient for that (figure 7).

Assuming the cells time constants to differ one from another by more than a decade, and numbering the cells in ascending order for  $\tau_i$ , it is possible to assume that the responses are unfolding successively, so that we may write, in the interval  $t_{1i} \leq t \leq t_{2i}$ :

$$V(t) = (V_0 - \sum_{j=1}^{i-1} \Delta V_j) - \Delta V_i [1 - E_{\alpha_i, 1}(-(t/\tau_i)^{\alpha_i})] \quad (33)$$



Using this simplifying assumption, three parameters may be roughly estimated from the experimental results at  $t_{1i}$  and  $t_{2i}$ . First,  $\alpha_i$  may be deduced from the slope of  $\log(-dV(t)/dt) = f(\log t)$  plot, since, assuming  $t \ll \tau_i$ , it will be  $(-1 + \alpha_i)$ , while, assuming  $t \gg \tau_i$ , it will be  $(-1 - \alpha_i)$ . It is however quite difficult to implement one of these conditions, especially for an intermediary cell in the circuit, so this first estimation of  $\alpha_i$  may be quite arbitrary.

Then a system with 3 equations may be deduced from the measured voltages at  $t_{1i}$  and  $t_{2i}$ .

$$V(t_{1i}) = (V_0 - \sum_{j=1}^{i-1} \Delta V_j) - \Delta V_i [1 - E_{\alpha_i,1}(-(t_{1i}/\tau_i)^{\alpha_i})] \quad (34)$$

$$V(t_{2i}) = (V_0 - \sum_{j=1}^{i-1} \Delta V_j) - \Delta V_i [1 - E_{\alpha_i,1}(-(t_{2i}/\tau_i)^{\alpha_i})] \quad (35)$$

$$\left[ \frac{dV}{dt} \right]_{t_{1i}} = -\frac{\Delta V_i}{\tau_i} (t_{1i}/\tau_i)^{\alpha_i-1} E_{\alpha_i, \alpha_i}(-(t_{1i}/\tau_i)^{\alpha_i}) \quad (36)$$

NB:  $\sum_{j=1}^{i-1} \Delta V_j$  has to be removed in the equations (34) and (35) for  $i = 1$

From (34) and (35) may be deduced:

$$\Delta V_i = \frac{V(t_{1i}) - V(t_{2i})}{E_{\alpha_i,1}(-(t_{1i}/\tau_i)^{\alpha_i}) - E_{\alpha_i,1}(-(t_{2i}/\tau_i)^{\alpha_i})} \quad (37)$$

and from (36), a function of  $\tau_i$  that should be equal to 1:

$$f(\tau_i) = -\frac{\Delta V_i}{\tau_i \left[ \frac{dV}{dt} \right]_{t_{1i}}} (t_{1i}/\tau_i)^{\alpha_i-1} E_{\alpha_i, \alpha_i}(-(t_{1i}/\tau_i)^{\alpha_i}) \quad (38)$$

This function is easy to compute numerically and represent on a graph in order to find the value of  $\tau_i$  solution of  $f(\tau_i) = 1$ .

From equations (34) and (35) for the first cell, knowing  $\Delta V_1$ ,  $\alpha_1$  and  $\tau_1$ ,  $V_0$  may also be deduced.

Using these first rough estimation of the  $3n+1$  parameters involved in the problem, a nonlinear regression software using the least square method may be used to provide the best fit possible for the voltage and the voltage derivative curve. We applied this method to get a good fit with a 2 cell model for our experimental results described in the next section, with also a frequent help of a manual fitting of the parameters, which is time consuming but proved to be useful.

#### IV. ANALYSIS OF EXPERIMENTAL SURFACE POTENTIAL DECAY AND RETURN DATA

##### A. Extraction of Cole-Cole parameters from experimental data

###### 1. Experiments

We applied the same experimental procedure to four plates made of common insulating materials: alumina (96 pure polycrystalline  $\text{Al}_2\text{O}_3$ , 1mm thick), epoxy (DGEBA resin + anhydride hardener, 7mm thick), epoxy with a mineral filler (same resin, with  $\text{SiO}_2$ , 7mm thick) and polydimethylsiloxane (PDMS LSR 4301, 150 $\mu\text{m}$  thick).

These plates were grounded on their back side. At ambient temperature (25°C 45% RH) a charge was deposited on their upper surface by a corona triode. In this classical device, ions emitted during a short time (one second here) by a sharp point wired to an HV positive source, drift to the insulator surface through a grid whose potential is fixed at 3kV, thus ensuring an homogeneous initial charge of the surface at about the same potential. The charged plate was then immediately transferred under a non-contacting electrostatic probe by the means of a pneumatic jack. The measuring probe is set to the potential of the surface being studied by a feedback circuit allowing the field in front to the probe to be reduced to zero, according to the Kelvin-Zisman principle, which allows minimum disturbance of the potential. The potential decay was then recorded during 1000s. Then the surface was neutralized by a charge deposit of an opposite polarity and the return voltage measured during 1000s.

The experimental results are represented figure 7 for the potential decay, and figure 9 for the return voltage, together with simulation results. The experimental data are in colored plain lines, while the simulations are represented using black dotted or dashed lines.

These results are quite typical of what could be obtained in the time domain for many insulating materials. The data acquisition rate was 10 measurements per second but concerning this set of experiments, given the transfer time and the rise time of the probe, no reliable measurement was available before 1 or 2 seconds (depending on the experiment), so that the time measurement range is here less than three decades. It would be clearly interesting to perform measurements on a broader time scale, and with many other materials, but the purpose is here to provide a simple illustration of what could be done with the mathematical tools developed in the previous sections.

###### 2. Parameter identification for the experimental results using a two-cell model

The calculations have been made using a common mathematical software. Codes for the computation of Mittag-Leffler functions are nowadays easy to find and implement, are operating fast and with a great accuracy (we used a routine developed by Roberto Garrappa). The results of this parameter identification procedure for the measurements described above are given table 1.

TABLE I. Best suited parameters for the two-cells model.

Material	$V_0$ (V)	$\alpha_1$	$\tau_{11}$ (s)	$\Delta V_1$ (V)	$\alpha_2$	$\tau_{12}$ (s)	$\Delta V_2$ (V)
Al <sub>2</sub> O <sub>3</sub>	3044	0,70	1,00	20	0,48	50000	1680
Pure epoxy	3185	0,70	3,00	20	0,35	35000	72
Epoxy+filler	3700	0,80	2,00	675	0,50	1500	2600
PDMS	3580	0,90	0,30	600	0,80	8000	2850

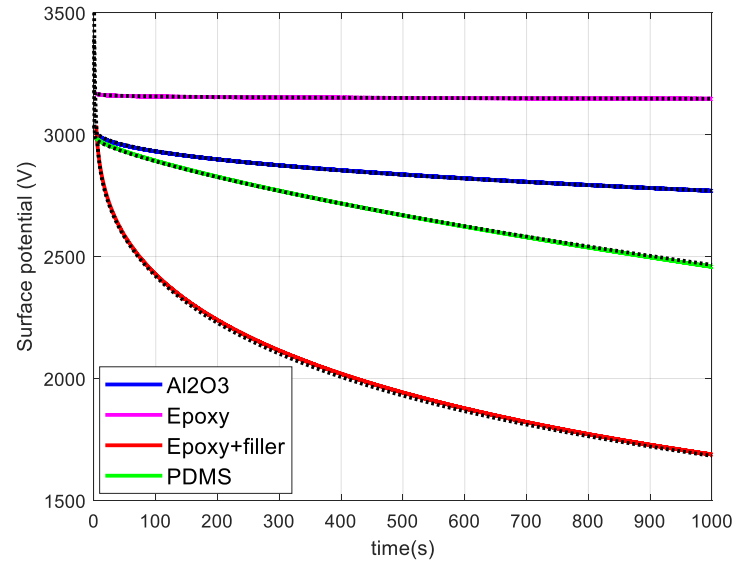

FIG. 7. Measurement and computation of the potential decay on four insulating plates using parameters from table 1.

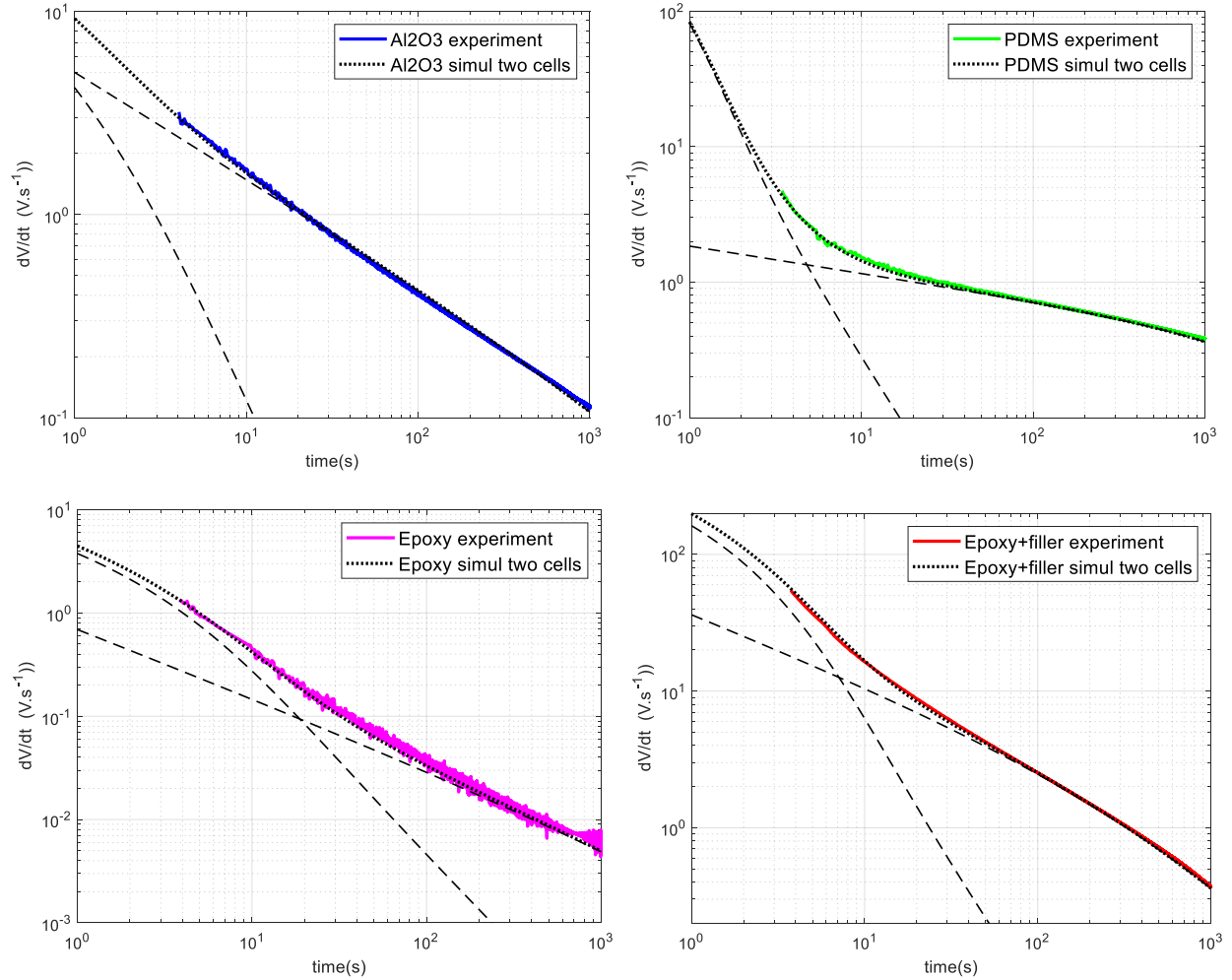

FIG. 8. Measurement and computation of the potential decay derivatives on four insulating plates using parameters from table 1. Dashed lines represent the contribution of each cell.

Figure 7 and 8 show the good fit that may be obtained using two cells for the voltage and voltage derivative decay curves using these parameters. The contribution of each of these two cells is detailed figure 8 for each material, and it may clearly be seen that two cells were necessary to represent the relaxation in the measured time range.

### B. Return voltage calculation and comparison with experimental data

Using the parameters listed in table 1, the return voltage was computed using equations (9) and (32). The result of this calculation is given figure 9, for the four materials. The experimental value of the return voltage is compared with the response computed using the two-cell model and a one-cell model keeping only the cell with the highest value of  $\tau_i$ . For three materials (alumina and epoxy with or without filler), the simulation allows an approximate prediction of

the return voltage shape and amplitude. The prediction is improved by removing the short time cell. For PDMS, the experimental return voltage is much lower than what could be predicted by the linear model. This model is obviously not suitable for this latter material.

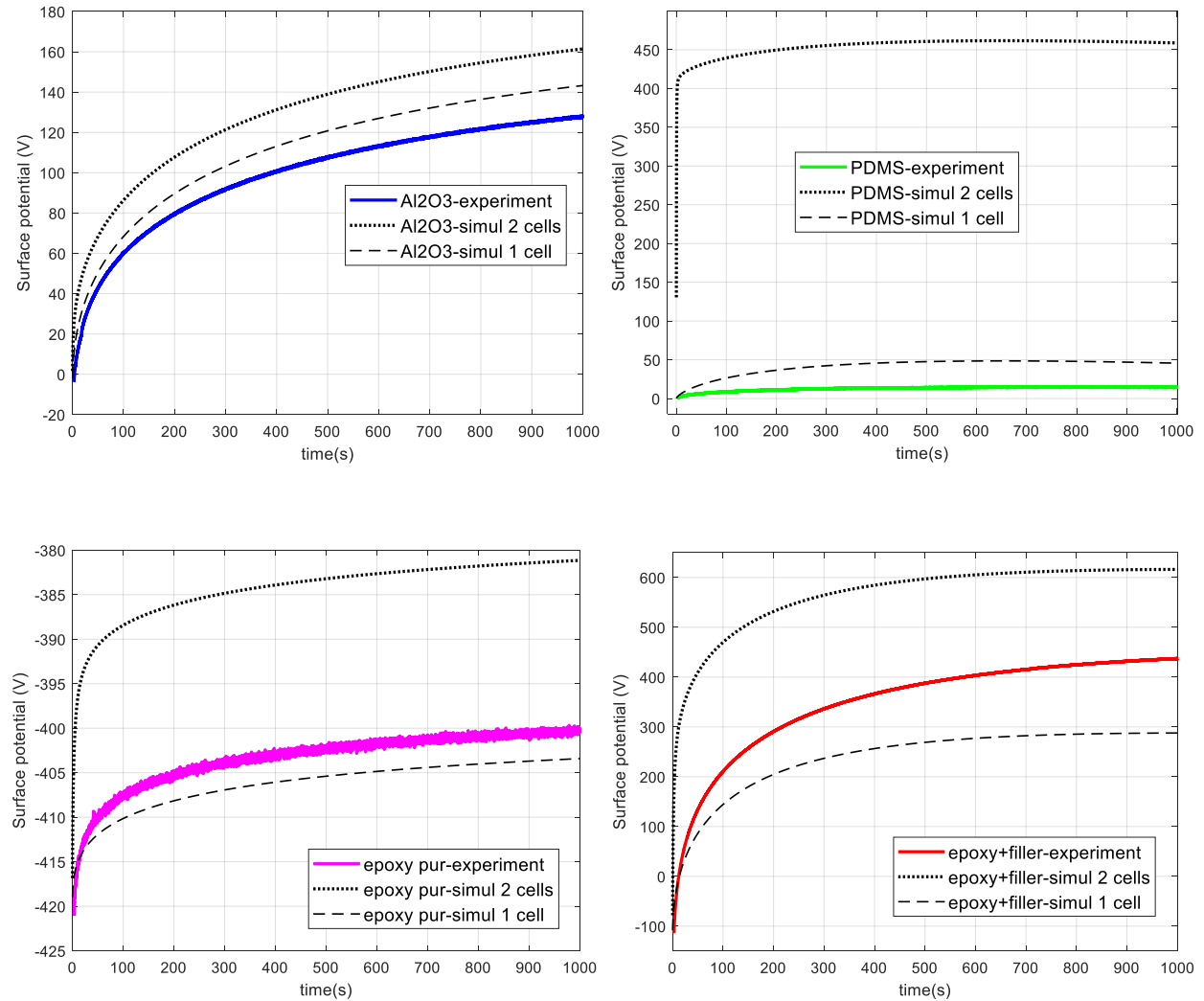

FIG. 9. Measurement and computation of the return voltage on four insulating plates

### C. Discussion

The response of a real material is always complex, involves several physical phenomena, and may be strongly nonlinear. The interest of a simple linear, phenomenological model like the one described here may thus not be obvious for the reader. However, considering dielectric measurements, in the time domain as well as in the frequency domain,

it is useful to isolate the linear response, when it exists (it is usually the case) to study the nonlinear processes, and to determine their particular features. Considering for instance the experiments described here, it may be suggested that on alumina and epoxy, the second cell, corresponding to large time values, provides a convenient description of the linear dielectric response of the sample in the time domain, since it allows an approximate prediction of the return voltage. The first cell however, especially for epoxy, is clearly of a different, nonlinear, nature, whereas considering PDMS, both cells are clearly dominated by conduction processes that do not give birth to a return voltage. Hence a phenomenological model can provide elements for the development of a physical understanding of the dielectric behavior.

It is difficult to go further into the physical interpretation of the limited experimental results described here. What has been shown is the interest of using Mittag-Leffler functions to obtain a good phenomenological description of the decay, and a quantitative separation of several relaxations occurring in a material. The return voltage then adds an additional information. This procedure has to be understood as a starting point for the development of a physical model of charge relaxation and transport in the material, but it has to be accompanied by other measurements, as checking the influence of the temperature, the interfaces, the charging polarity and the dependence on the applied voltage.

The choice of Cole-Cole transfer function may seem somewhat arbitrary. In some cases, this description may not be the best way to capture the response. But in condensed matter, most of the physical processes involved in relaxation lead to a time (or frequency) response much closer to Cole-Cole than to Debye. It may be the collective behavior of dipoles coming back to equilibrium, as well as charge drift in a disordered environment characterized by a broad distribution in energy of the trapping centers. This multiple-trapping (MT) charge transport problem for an insulator with an exponentially decreasing density of trapping states below the electronic conduction levels leads to a potential decay curve very similar to what is shown figure 3<sup>39</sup>, which is not surprising, since it turned out to be mathematically equivalent to the Cole-Cole relaxation model<sup>40</sup>. The Cole-Cole response function is therefore a fairly general description of the dielectric behavior in its various aspects. Besides, it has to be kept in mind that many current models for the insulator response are based on arrays of parallel RC cells aiming at reproducing the distribution of the relaxation times. Considering constant-phase elements (or modeling the voltage decay in terms of sums of a few Mittag

Leffler functions, which is equivalent and has been done here) may greatly reduce the number of cells necessary for the same precision.

## V. CONCLUSIONS

This article intends to fill an existing gap concerning the lack of convincing models available for the dielectric behavior in the time domain and in open circuit, a very common situation in many applications. We developed a mathematical analysis of this common problem which was – to the author's knowledge – not available in the present literature, and suggest ways to implement it to analyze and predict the dielectric surface potential in a more reliable way than what currently exists. We hope it will be useful to researchers and engineers trying to understand and model dielectric behavior over long time periods.

We did not detail here the physical reasons for the omnipresence in condensed matter of responses described by time power laws. The interested reader may refer to the many books and articles written about what may be called the universal relaxation law<sup>25</sup>. We only underlined in this paper the interest and the practical implementation of a treatment of the potential data obtained in open circuit and in the time domain taking into account this behavior, through Mittag-Leffler functions.

Many developments may be considered from this work, since it deals with the general relationship that exists between a charge and the potentials and fields that it induces in condensed matter. In the time domain, the delayed component of the material polarization may be large, due for instance to slow chain relaxation motion in polymers or to interfacial polarization in semi crystalline materials. It has therefore to be taken into account. A logical development may concern 3D field calculation software for DC or electrostatic applications, for which setting up a realistic evolution over time of the permittivity of insulating materials involves the use of Mittag-Leffler functions. It may also concern dynamical situations. For instance, surface potential measurements may be used to investigate prebreakdown phenomena such as charge injection in the material, usually occurring above a given field threshold. Understanding the behavior of this internal space charge is a real concern, given its role in insulator ageing and failure mechanisms. Numerical models exist to account for charge transport into the dielectric, taking into account trapping and detrapping

This is the author's peer reviewed, accepted manuscript. However, the online version of record will be different from this version once it has been copyedited and typeset.  
PLEASE CITE THIS ARTICLE AS DOI: 10.1063/5.0170968

events. A possible development would be to replace the static permittivity surrounding the injected charge by a dynamic value calculated using Mittag-Leffler functions.

The main idea that must be retained from this work is that what we observe performing experiments on materials in the time domain are not deviations from a “normal” exponential behavior, but a general behavior of relaxation that requires specific tools to be described, which are the Mittag-Leffler functions, special functions that are now quite easy to manipulate for a non-mathematician scientist.



## REFERENCES

- <sup>1</sup>P. Molinié and G. Touchard, IEEE Tr. Dielectrics El. Ins. **16**, 587 (2009)
- <sup>2</sup>S. Alam, Y. V. Serdyuk, and S. M. Gubanski, Energies **13**, 2982 (2020)
- <sup>3</sup>F. Wang, F. Liang, S. Chen, L. Zhong, Q. Sun, B. Zhang, and P. Xiao, IEEE Tr. Dielectrics El. Ins **28**, 1053 (2021)
- <sup>4</sup>A. Gerlach, M. Liebler, G. M. Sessler, H. Von Seggern, B. Scheufele, and E. Hirth, AIP Advances **10**, 095313 (2020)
- <sup>5</sup>C. Wang, H. Guo, P. Wang, J. Li, Y. Sun, and D. Zhang, Advanced Materials **35**, 2209895 (2023)
- <sup>6</sup>O. Tilmatine, T. Zeghloul, K. Medles, L. Dascalescu, and A. Fatu, J. Electrostatics **115**, 103651 (2022)
- <sup>7</sup>T. K. Saha and Z.T. Yao, IEEE Tr. Power Delivery **18**, 128 (2003)
- <sup>8</sup>S. Wolny and M. Zdanowski, IEEE Tr. Dielectrics El. Ins. **16**, 1676 (2009)
- <sup>9</sup>A. Rychkov, A. Kuznetsov, A. Gulyakova, and D. Rychkov, IEEE Tr. Dielectrics El. Ins. **28**, 1933 (2021)
- <sup>10</sup>N. Amieur, Z. Ziari, and S. Sahli, J. Electrostatics **109**, 103551 (2021)
- <sup>11</sup>P. Molinié, IEEE Tr. Dielectrics El. Ins. **12**, 939 (2005)
- <sup>12</sup>H. J. Wintle, J. Appl. Phys., **43**, 2927 (1972)
- <sup>13</sup>I. P. Batra, J. Appl. Phys. **41**, 3416 (1970)
- <sup>14</sup>M. Ieda, G. Sawa, and U. Shinohara, Jpn. J. Appl. Phys. **6**, 793 (1967)
- <sup>15</sup>T. J. Sonnonstine and M. M. Perlman, J. Appl. Phys. **46**, 3975 (1975)
- <sup>16</sup>P. K. Watson, IEEE Tr. Dielectrics El. Ins. **2**, 915 (1995)
- <sup>17</sup>D. Rychkov, A. Kuznetsov, and A. Rychkov, IEEE Tr. Dielectrics El. Ins **18**, 8 (2011)
- <sup>18</sup>D. K. Das-Gupta, IEEE Tr. Elec. Insulation **25**, 503 (1990)
- <sup>19</sup>P. Molinié, M. Goldman, and J. Gattellet, J. Phys. D **28**, 1601 (1995)

This is the author's peer reviewed, accepted manuscript. However, the online version of record will be different from this version once it has been copyedited and typeset.  
PLEASE CITE THIS ARTICLE AS DOI: 10.1063/5.0170968

- <sup>20</sup>K. S. Cole and R. H. Cole, J. Chem. Phys. **9**, 341 (1941)
- <sup>21</sup>S. Havriliak and S. Negami, Polymer **8**, 161 (1967)
- <sup>22</sup>G. Williams and D. C. Watts, Trans. Faraday Soc. **66**, 80 (1970)
- <sup>23</sup>R. Kohlrausch, Ann. Phys. Chem. **167**, 56 (1854)
- <sup>24</sup>J. Curie, PhD Thesis, Faculté des sciences de Paris (1888)
- <sup>25</sup>A. K. Jonscher, Nature **267**, 673 (1977)
- <sup>26</sup>R. Garrappa, F. Mainardi, and G. Maione, Fractional Calc. Appl. Analysis **19**, 1105 (2016)
- <sup>27</sup>B. Gross, Z. Physik **107**, 217 (1937)
- <sup>28</sup>F. M. de Oliveira Castro, Z. Physik **114**, 116 (1939)
- <sup>29</sup>F. Mainardi and A. Consiglio, WSEAS Tr. Mathematics **19**, 289 (2020)
- <sup>30</sup>K. S. Cole and R. H. Cole, J. Chem. Phys. **10**, 98 (1942)
- <sup>31</sup>A. Elwakil, IEEE Circuits Syst. Mag. **10**, 40 (2010)
- <sup>32</sup>A. Allagui, H. Benaoum, A. S. Elwakil, and M. Alshabi, IEEE Tr. Electron Devices **69**, 5792 (2022)
- <sup>33</sup>M. E. Fouda, A. Allagui, A. S. Elwakil, A. Eltawil, and F. Kurdahi, J. Power Sources **435**, 226829 (2019)
- <sup>34</sup>E. Hernández-Balaguera, H. Vara, and J. L. Polo, J. Electrochem. Soc. **165**, G3104 (2018)
- <sup>35</sup>S. L. M. Berleze and R. Robert, IEEE Tr. Dielectrics El. Ins. **10**, 665 (2003)
- <sup>36</sup>P. Molinié, J. Electrostatics **115**, 103674 (2022)
- <sup>37</sup>F. Kremer and A. Schönhal, *Broadband Dielectric Spectroscopy* (Springer Berlin Heidelberg, 2003), chapter 3
- <sup>38</sup>D. K. Das-Gupta and P. C. N. Scarpa, IEEE Tr. Dielectrics El. Ins. **3**, 366 (1996)
- <sup>39</sup>V. I. Arkhipov, J. A. Popova, and A. I. Rudenko, J. Electrostatics **18**, 23 (1986)
- <sup>40</sup>F. Mady, J. M. Reboul, and R. Renoud, J. Phys. D **38**, 2271 (2005)

This is the author's peer reviewed, accepted manuscript. However, the online version of record will be different from this version once it has been copyedited and typeset.  
PLEASE CITE THIS ARTICLE AS DOI: 10.1063/5.0170968

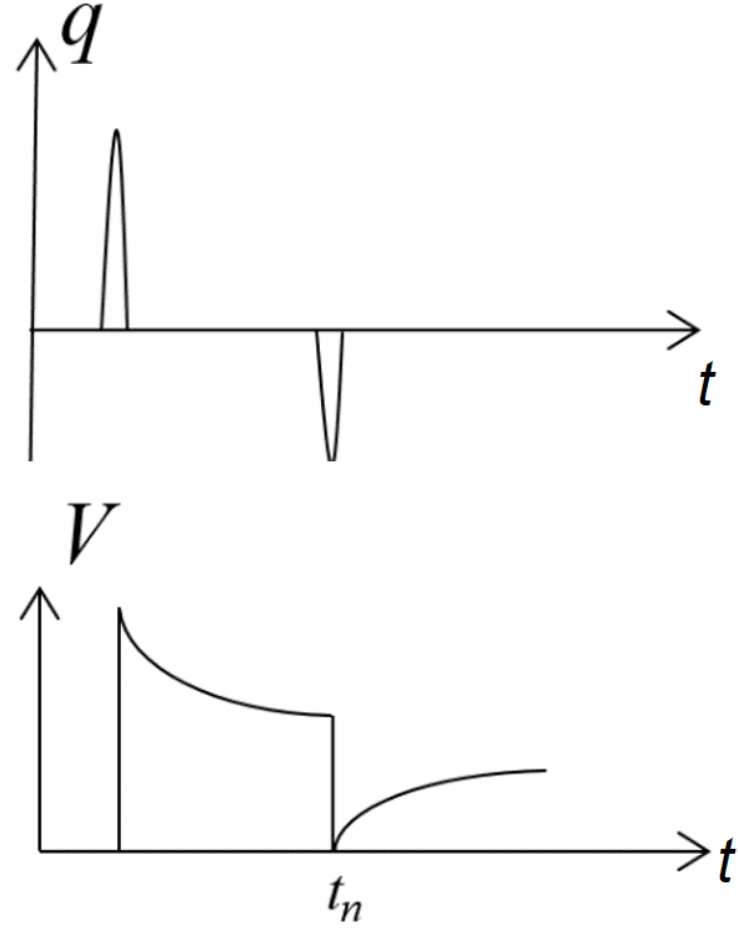
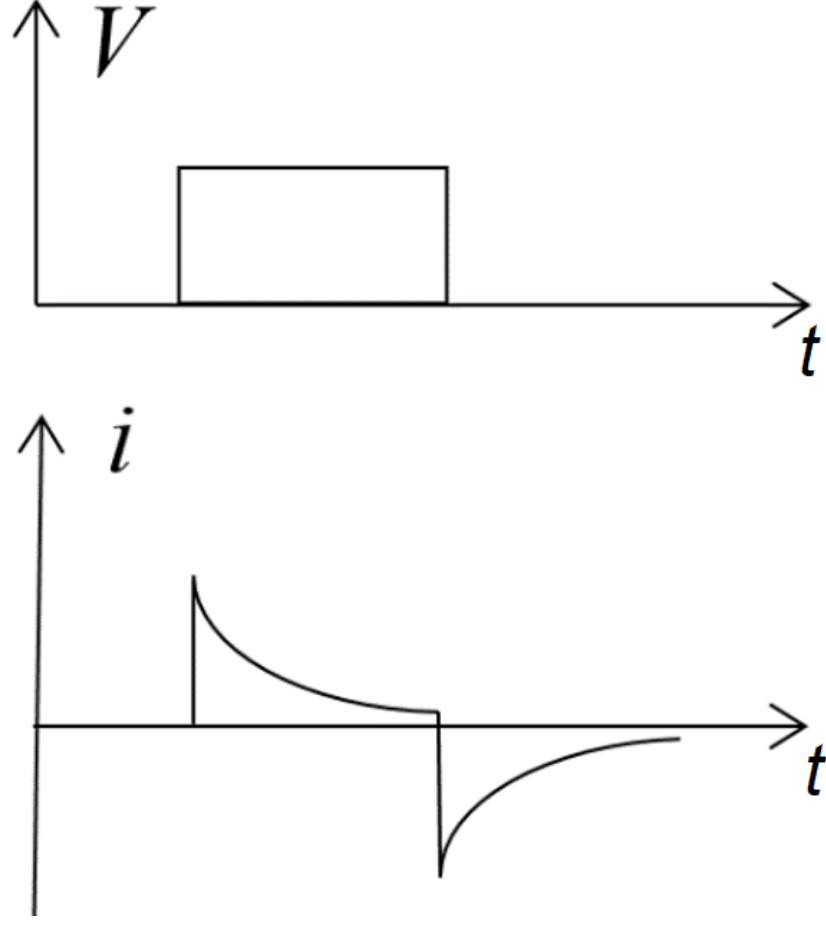

This is the author's peer reviewed, accepted manuscript. However, the online version of record will be different from this version once it has been copyedited and typeset.  
PLEASE CITE THIS ARTICLE AS DOI: 10.1063/5.0170968

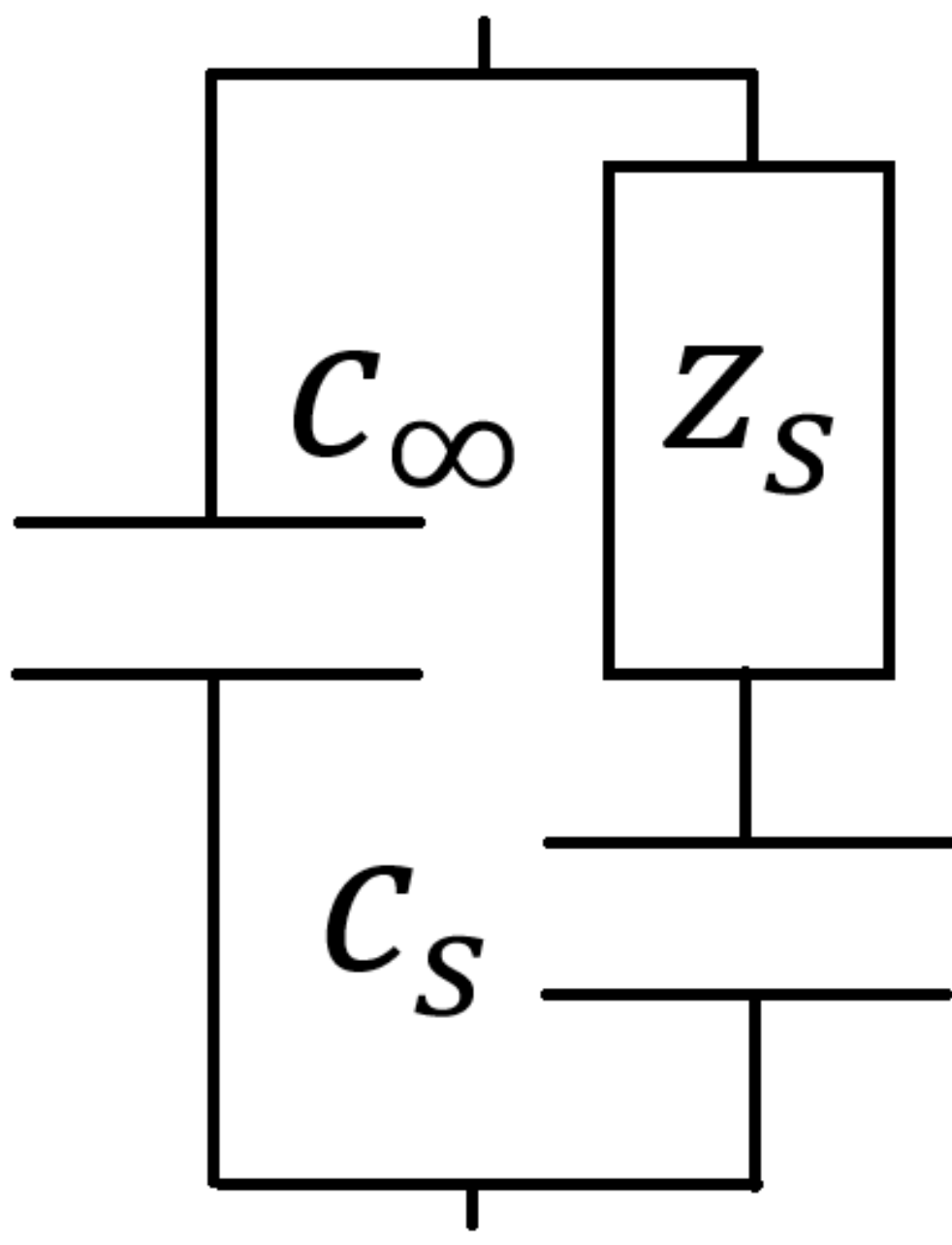

This is the author's peer reviewed, accepted manuscript. However, the online version of record will be different from this version once it has been copyedited and typeset.  
PLEASE CITE THIS ARTICLE AS DOI: 10.1063/5.0170968

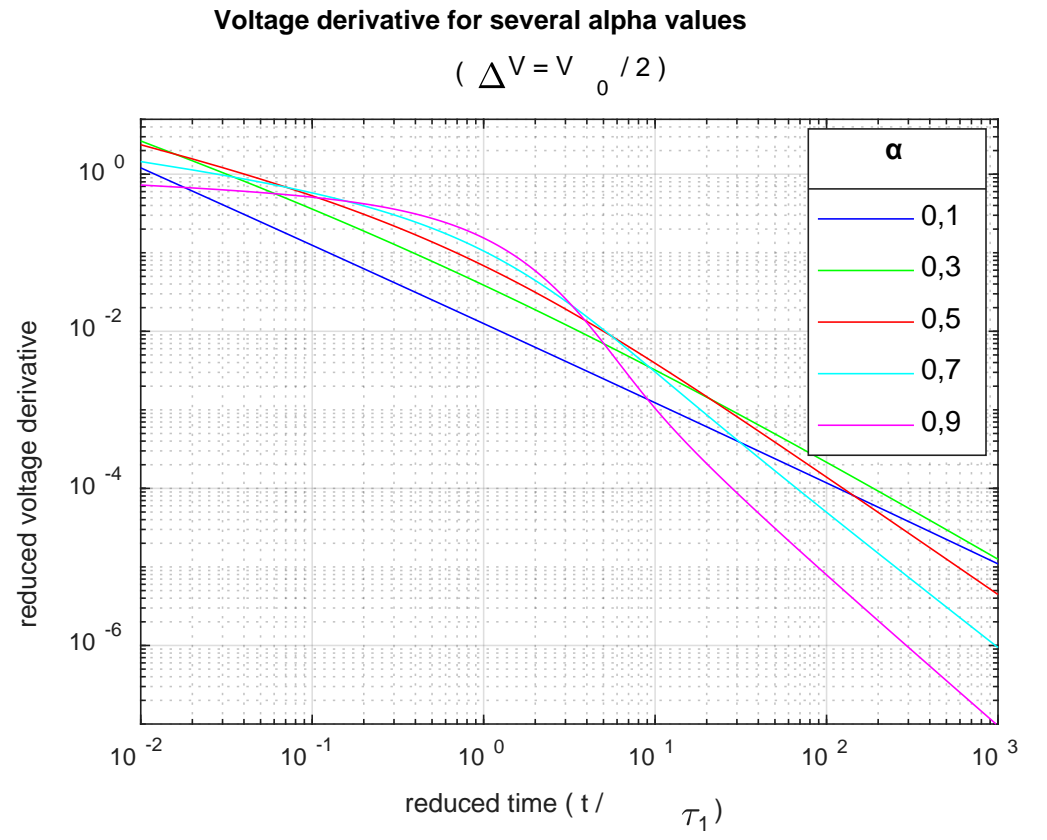
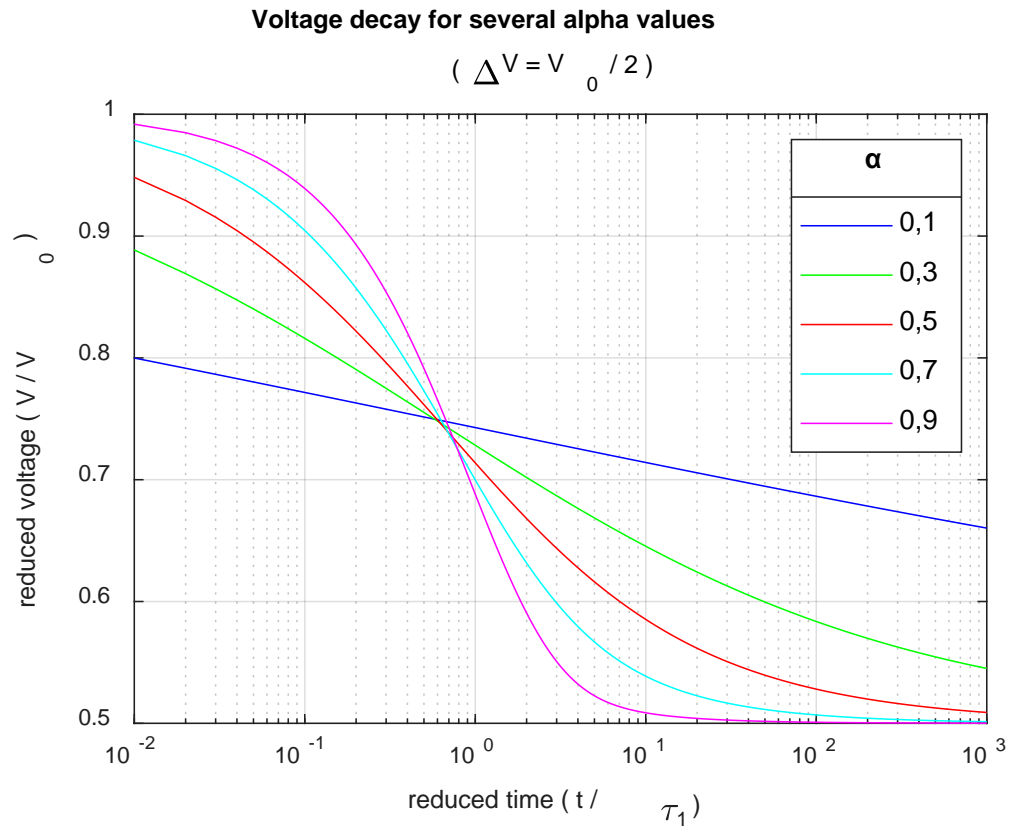

This is the author's peer reviewed, accepted manuscript. However, the online version of record will be different from this version once it has been copyedited and typeset.  
PLEASE CITE THIS ARTICLE AS DOI: 10.1063/5.0170968

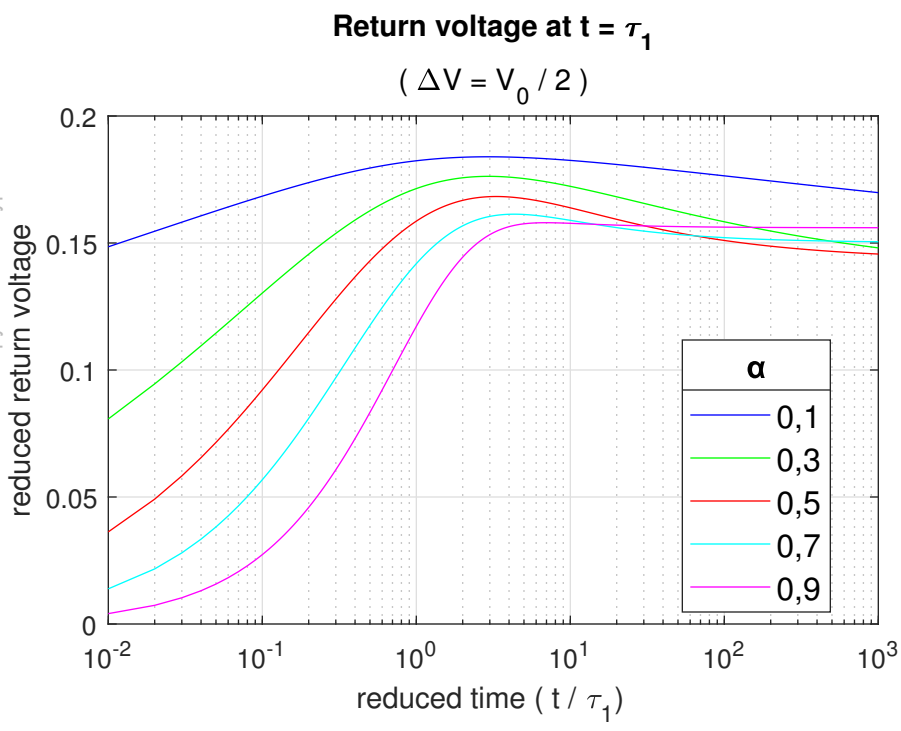

This is the author's peer reviewed, accepted manuscript. However, the online version of record will be different from this version once it has been copyedited and typeset.  
PLEASE CITE THIS ARTICLE AS DOI: 10.1063/5.0170968

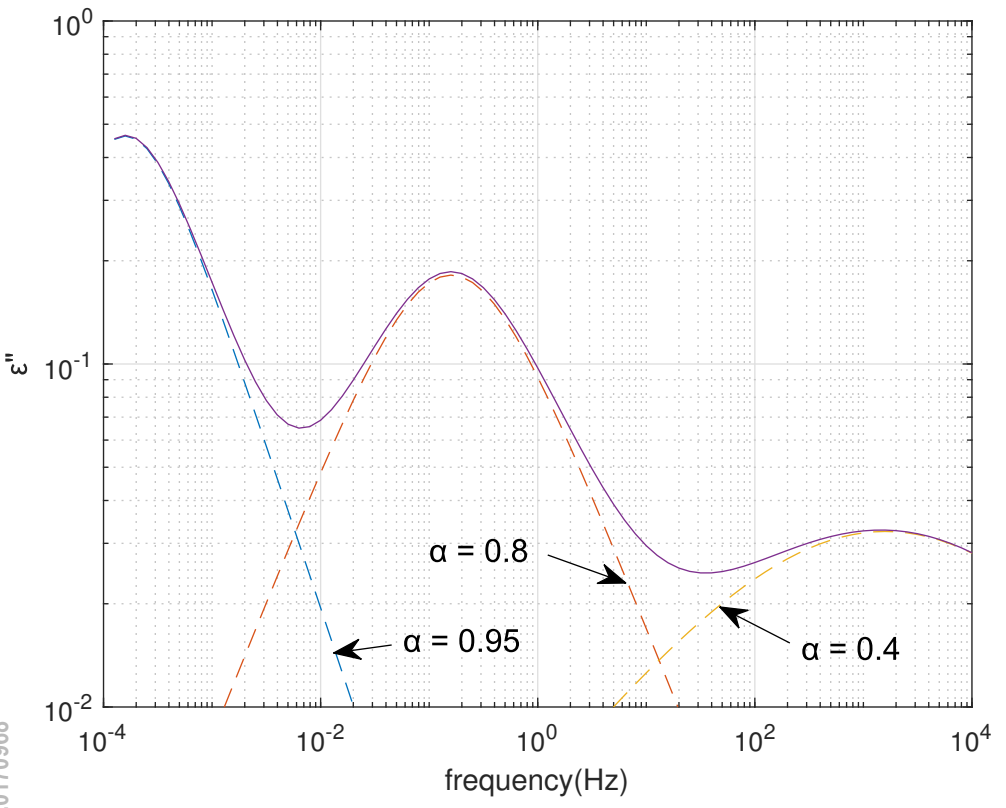

This is the author's peer reviewed, accepted manuscript. However, the online version of record will be different from this version once it has been copyedited and typeset.  
PLEASE CITE THIS ARTICLE AS DOI: 10.1063/5.0170968

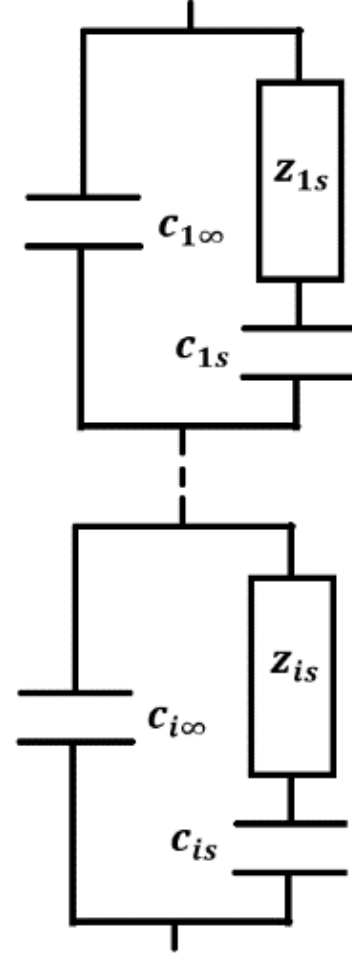
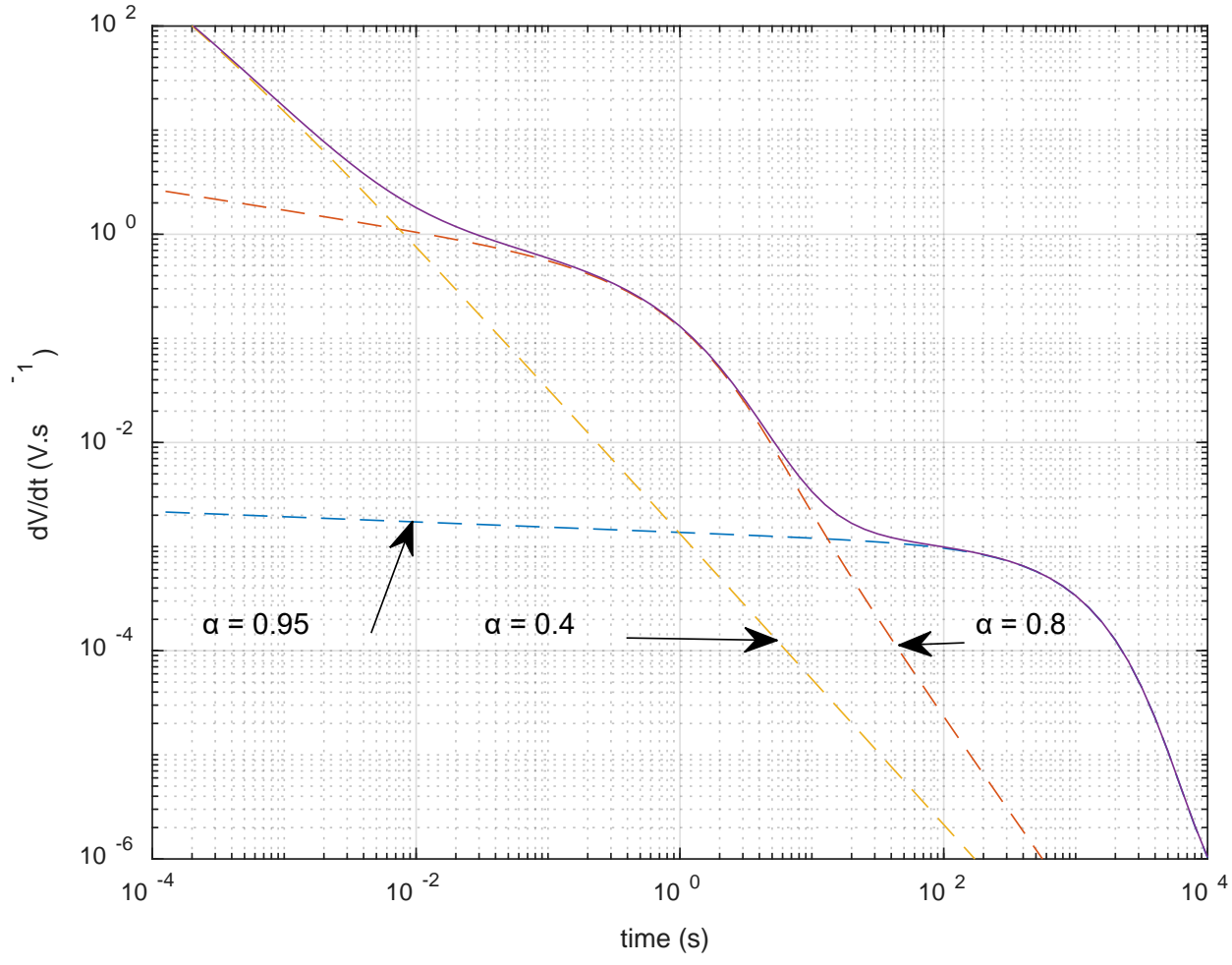



This is the author's peer reviewed, accepted manuscript. However, the online version of record will be different from this version once it has been copyedited and typeset.  
PLEASE CITE THIS ARTICLE AS DOI: 10.1063/5.0170968

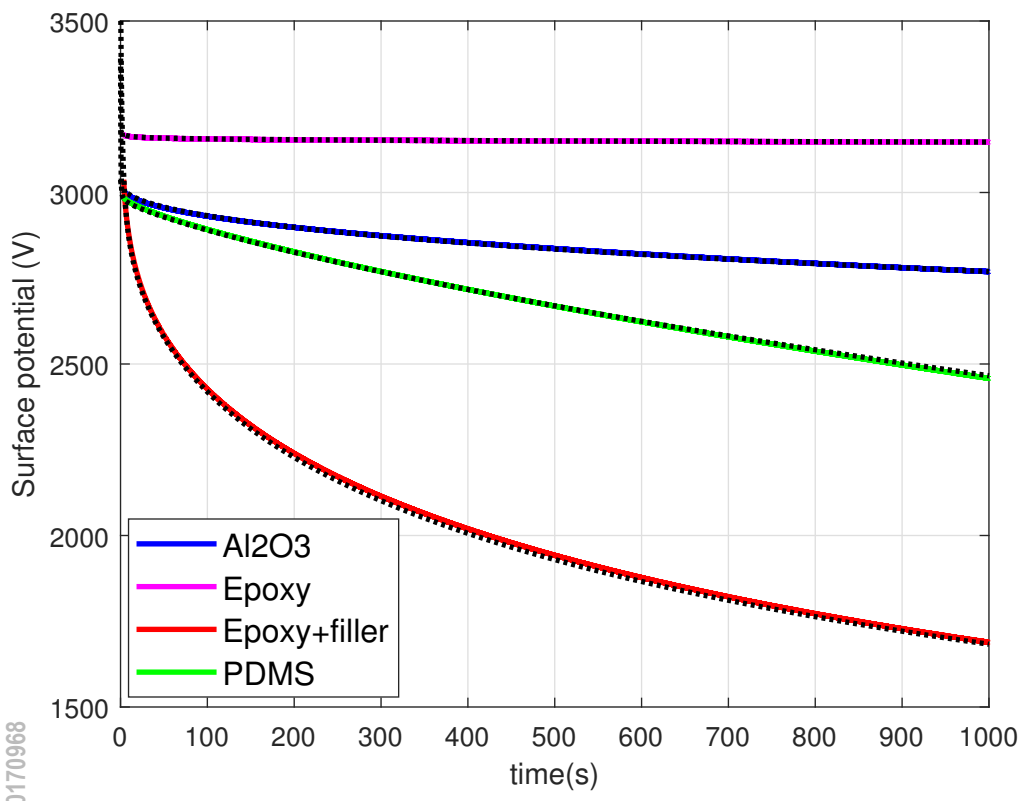

This is the author's peer reviewed, accepted manuscript. However, the online version of record will be different from this version once it has been copyedited and typeset.  
 PLEASE CITE THIS ARTICLE AS DOI: 10.1063/5.0170968

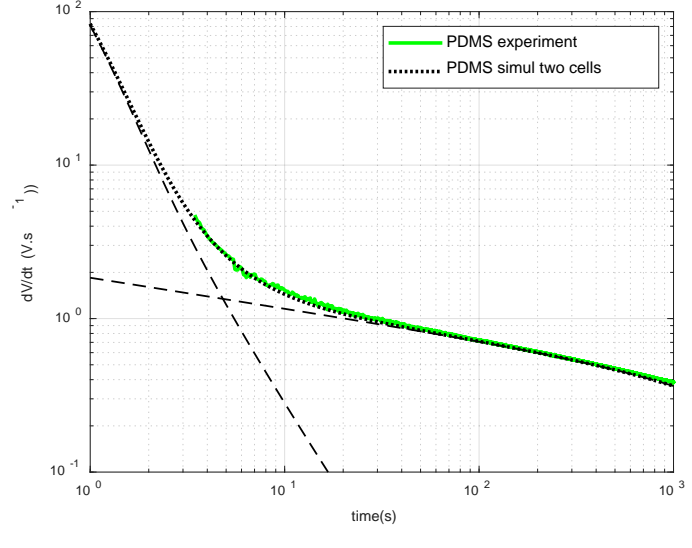
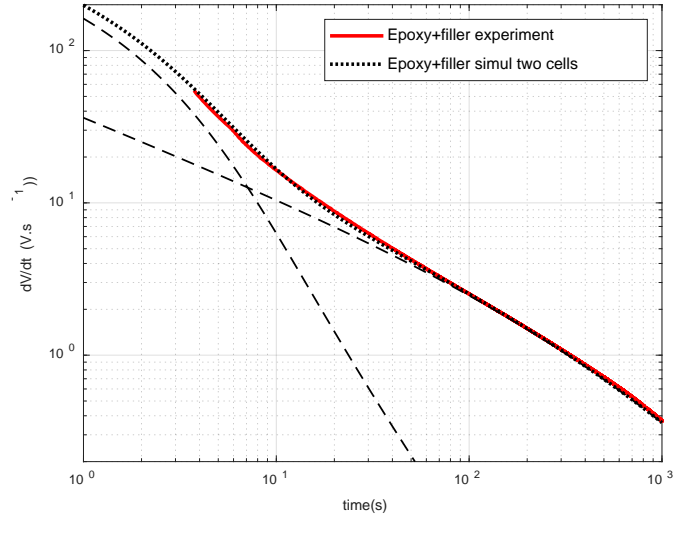
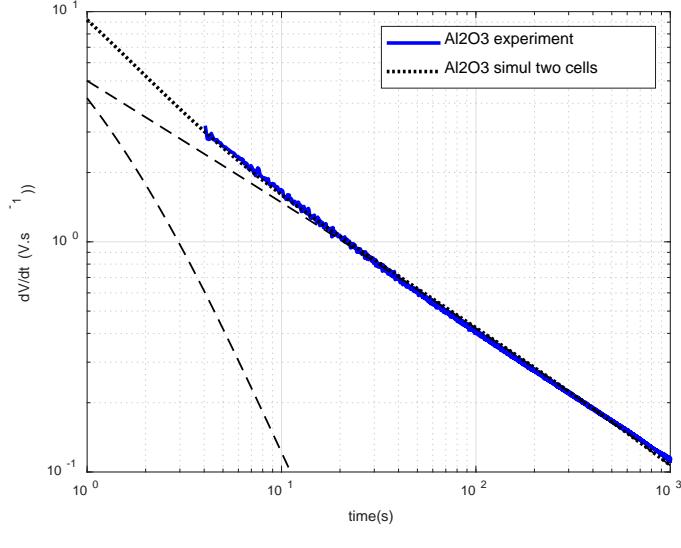
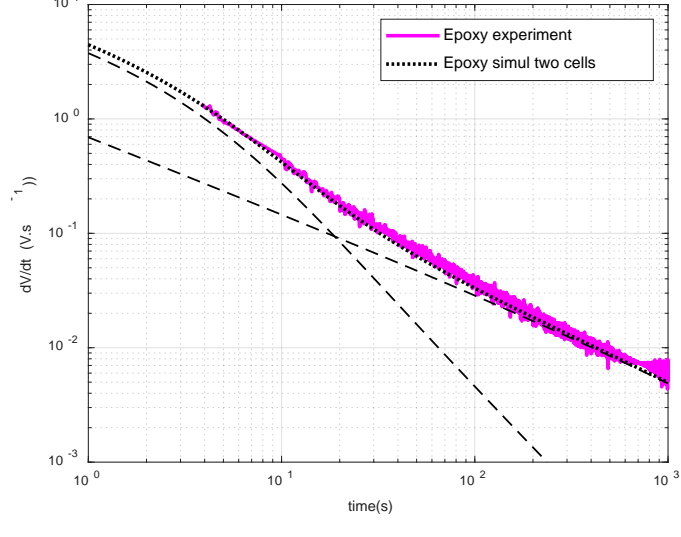

This is the author's peer reviewed, accepted manuscript. However, the online version of record will be different from this version once it has been copyedited and typeset.  
 PLEASE CITE THIS ARTICLE AS DOI: 10.1063/5.0170968

