

2023 IEEE PES ISGT-Europe

October 23rd-26th, 2023, Grenoble, France

Weather-Based Quasi Dynamic Thermal Ratings for Power Transformers

Sergio Montana(*) / Andrea Michiorri

Mines Paris - PERSEE

Paper N°: A8875SM



CONTEXT

Grid length development in advanced economies in the Announced Pledges Scenario, 2021-2050

Open 

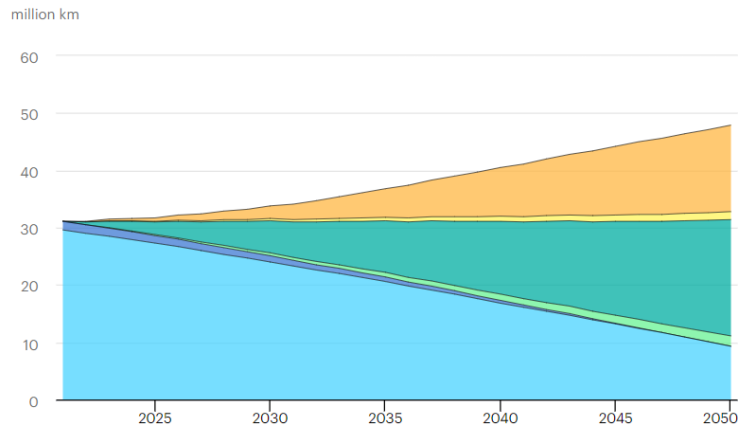

IEA. Licence: CC BY 4.0

- Existing Dx
- Existing Tx
- Replaced Tx
- Replaced Dx
- Additional Tx
- Additional Dx

Share of solar PV and wind in power generation worldwide in the Grid Delay Case and the Announced Pledges Scenario, 2010-2050

Open 

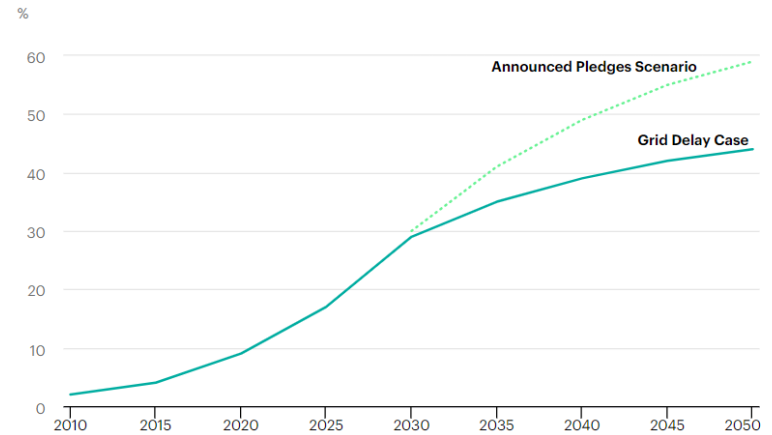

IEA. Licence: CC BY 4.0

- Announced Pledges Scenario
- Grid Delay Case

[1a]

Outline

- Introduction and Context
- Results
- Methodology
- Conclusion

THERMAL RATINGS

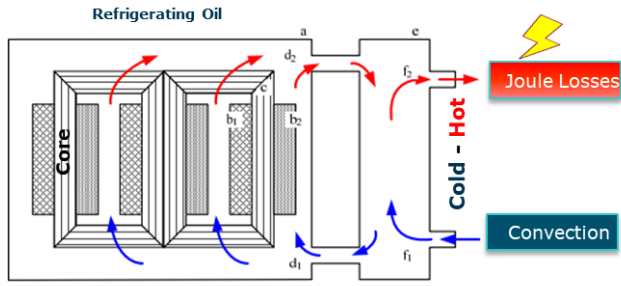

- [1]
- | | | | |
|-------------------------------|-----------------------|-------------------------------|---------------------------------|
| a | Oil tank | d ₁ d ₂ | Coolant oil flow (cold, hot) |
| b ₁ b ₂ | Windings (+-) | e | Heat exchanger |
| c | Ferromagnetic circuit | f ₁ f ₂ | Refrigerating fluid (cold, hot) |

THERMAL RATINGS

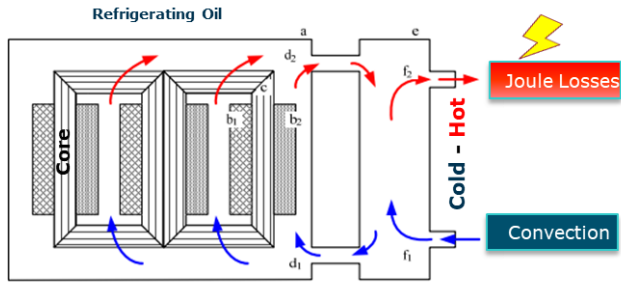

- [1]
- | | | | |
|-------------------------------|-----------------------|-------------------------------|---------------------------------|
| a | Oil tank | d ₁ d ₂ | Coolant oil flow (cold, hot) |
| b ₁ b ₂ | Windings (+-) | e | Heat exchanger |
| c | Ferromagnetic circuit | f ₁ f ₂ | Refrigerating fluid (cold, hot) |

Operating
Thermal
Limit

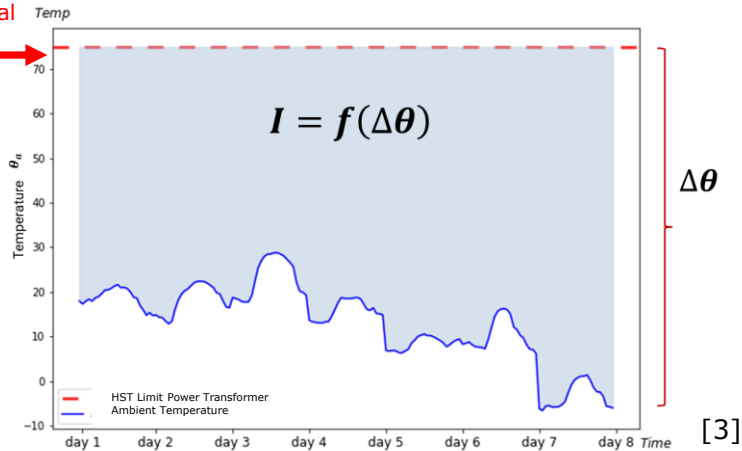

THERMAL RATINGS

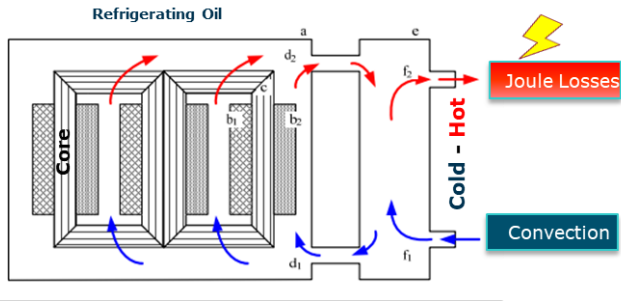

- [1]
- | | | | |
|-------------------------------|-----------------------|-------------------------------|---------------------------------|
| a | Oil tank | d ₁ d ₂ | Coolant oil flow (cold, hot) |
| b ₁ b ₂ | Windings (+/-) | e | Heat exchanger |
| c | Ferromagnetic circuit | f ₁ f ₂ | Refrigerating fluid (cold, hot) |

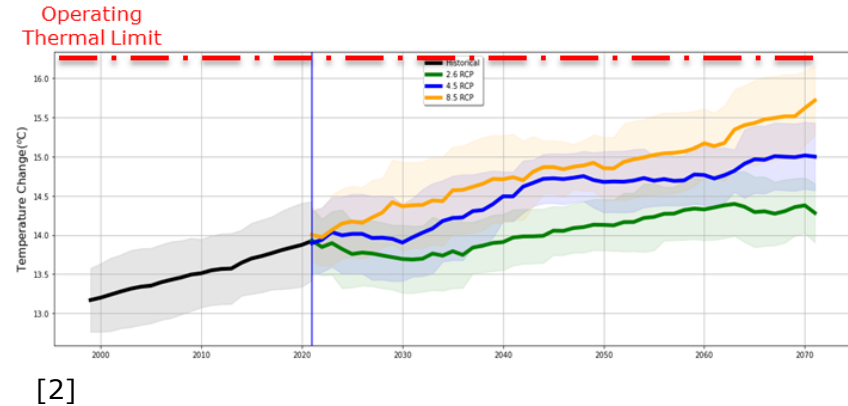
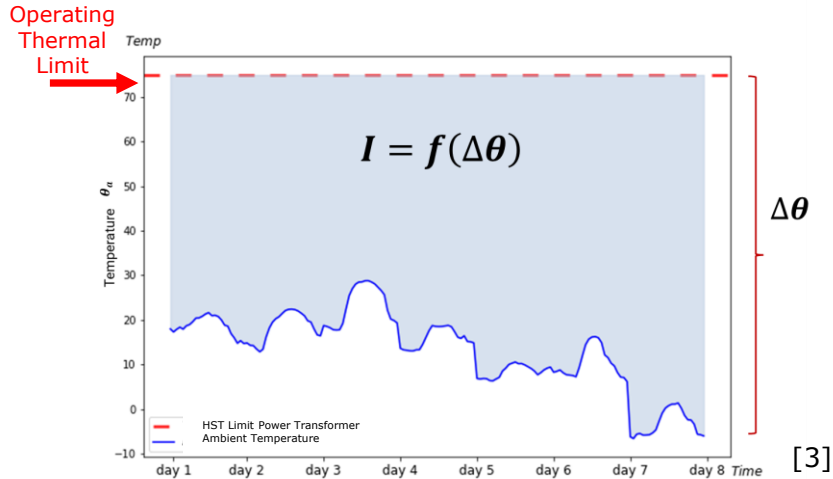

THERMAL RATINGS

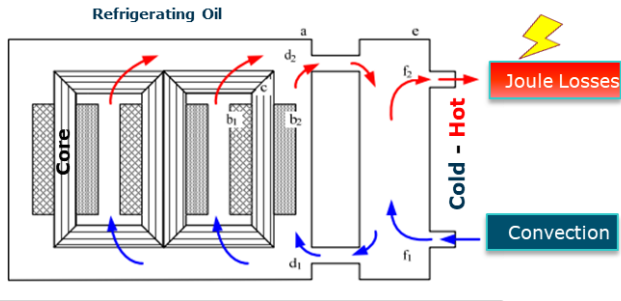

- [1]
- | | | | |
|-------------------------------|-----------------------|-------------------------------|---------------------------------|
| a | Oil tank | d ₁ d ₂ | Coolant oil flow (cold, hot) |
| b ₁ b ₂ | Windings (+/-) | e | Heat exchanger |
| c | Ferromagnetic circuit | f ₁ f ₂ | Refrigerating fluid (cold, hot) |

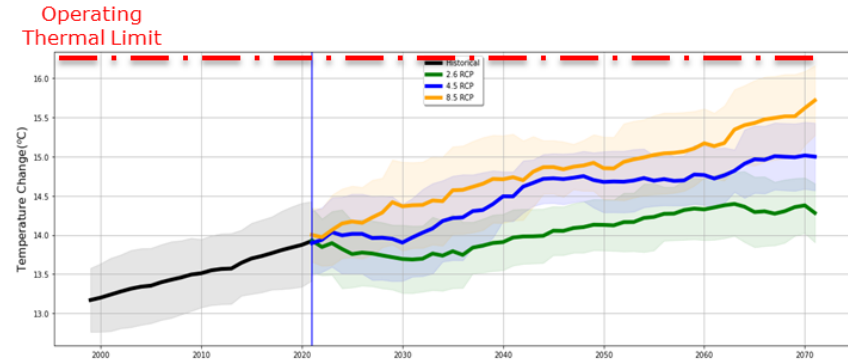
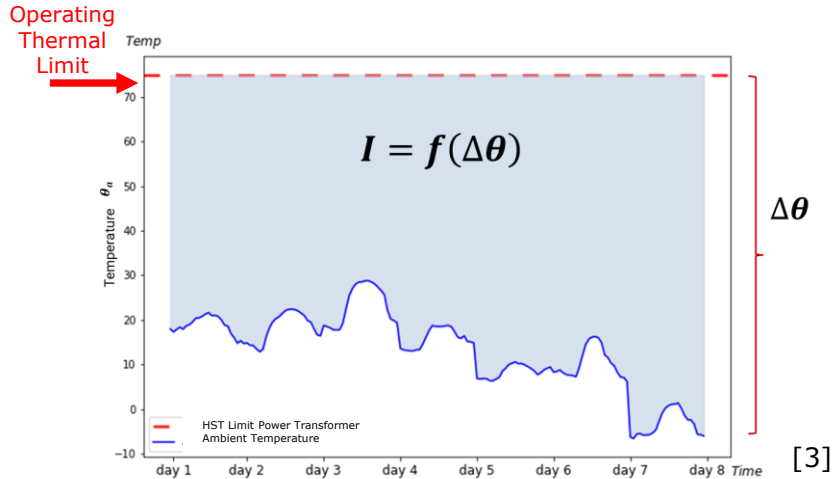

[2]

What will be the impact of climate change?





How to estimate the impact?

Outline

- Introduction and Context
- **Results**
- Methodology
- Conclusion

RESULTS

TABLE III: Average, minimum and maximum qDTR values compared to historical values

Description	Realtor 	Biaçon 	Broc-Carros 	Tamareu 	Tavel 
Hist Avg (A)	1716	1652	1711	1575	1636
Hist Max (A)	1851	1787	1862	1706	1805
Hist Min (A)	1543	1455	1519	1363	1340
2.6 RCP Avg	-0.3%	-0.2%	-0.2%	-0.3%	-0.4%
2.6 RCP Max	0.18%	0.45%	0.013%	0.6%	0.31%
2.6 RCP Min	0.06%	-0.8%	-1.0%	-2.1%	-0.8%
4.5 RCP Avg	-0.9%	-0.73%	-0.74%	-0.5%	-0.8%
4.5 RCP Max	-0.5%	0.647%	-0.8%	0.28%	-0.08%
4.5 RCP Min	-0.7%	-1.379%	-0.5%	-1.69%	-0.68%
8.5 RCP Avg	-1.67%	-1.69%	-1.62%	-1.01%	-2.07%
8.5 RCP Max	-1.03%	0.16%	-1.41%	-0.23%	-0.84%
8.5 RCP Min	-3.72%	-3.44%	-3.86%	-2.21%	-1.87%

Answer # 1 – Climate change could reduce average rating up to 2%

Map Of Provence Transmission Network With A Location Of PT

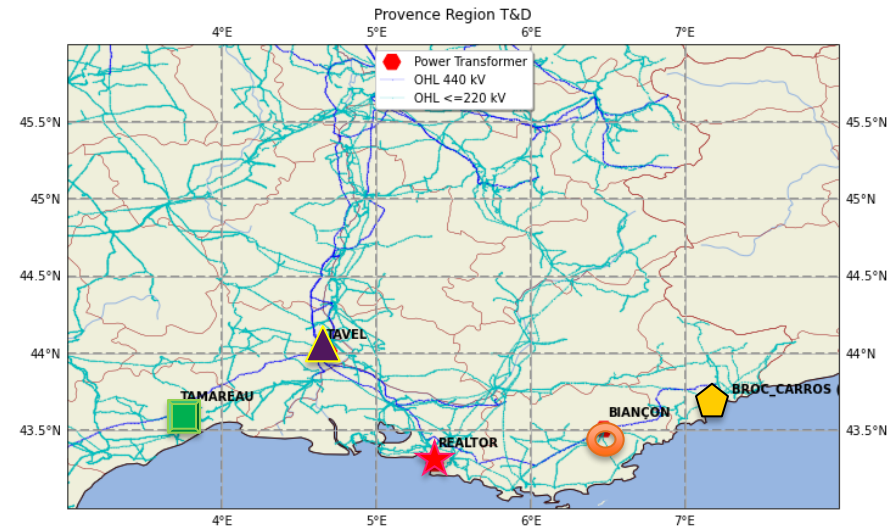

Results Broc-Carros with an exceedance probability of 0.1%

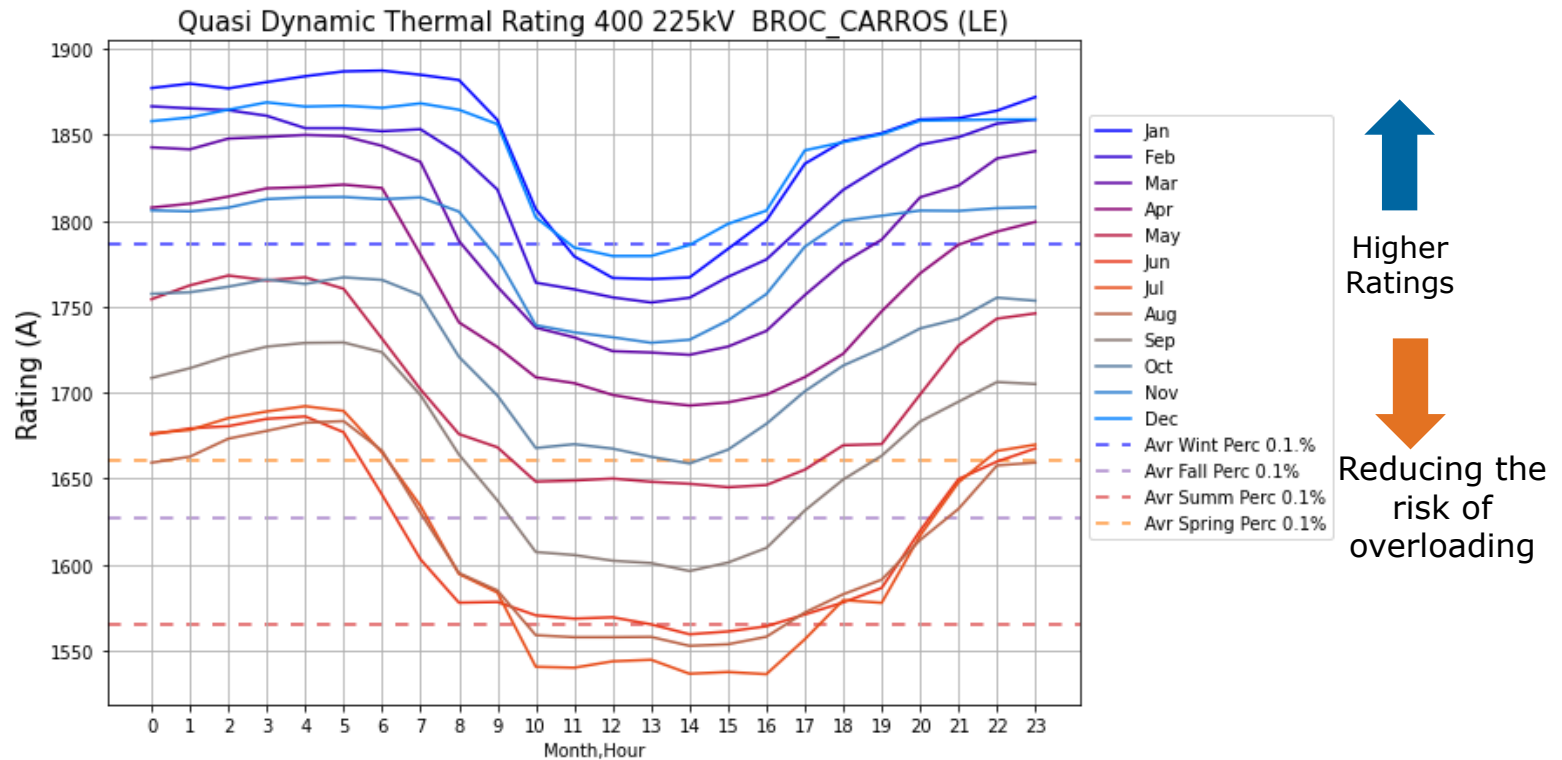

Answer # 2 – The qDTRs methodology introduced an average uplift in the region of 7.7%

Outline

- Introduction and Context
- Results
- **Methodology**
- Conclusion

Dynamic Thermal Rating: approaches

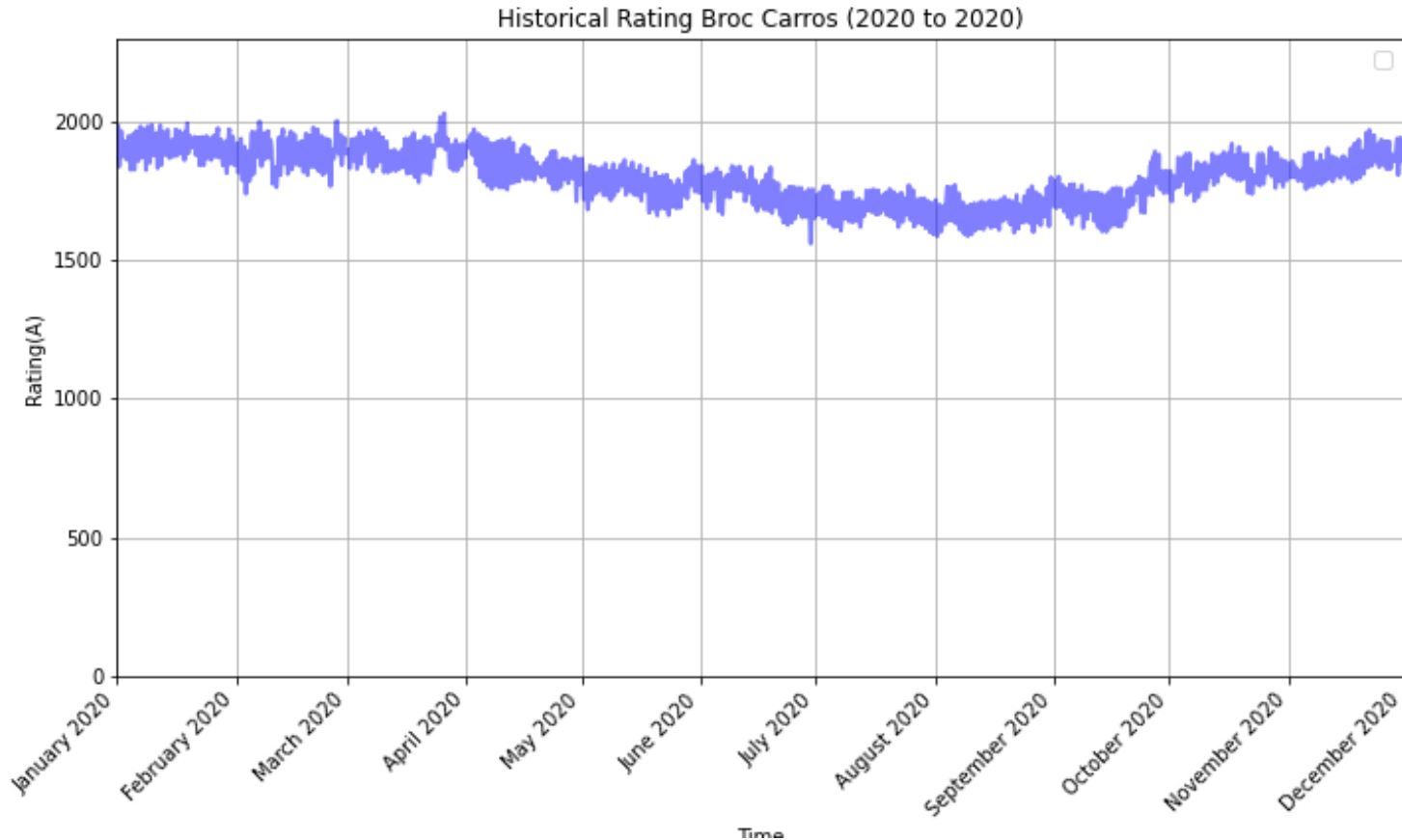

$$I_{qDTR}(\theta_a) \forall t \in [1, 2 \dots 24]$$

Dynamic Thermal Rating: approaches

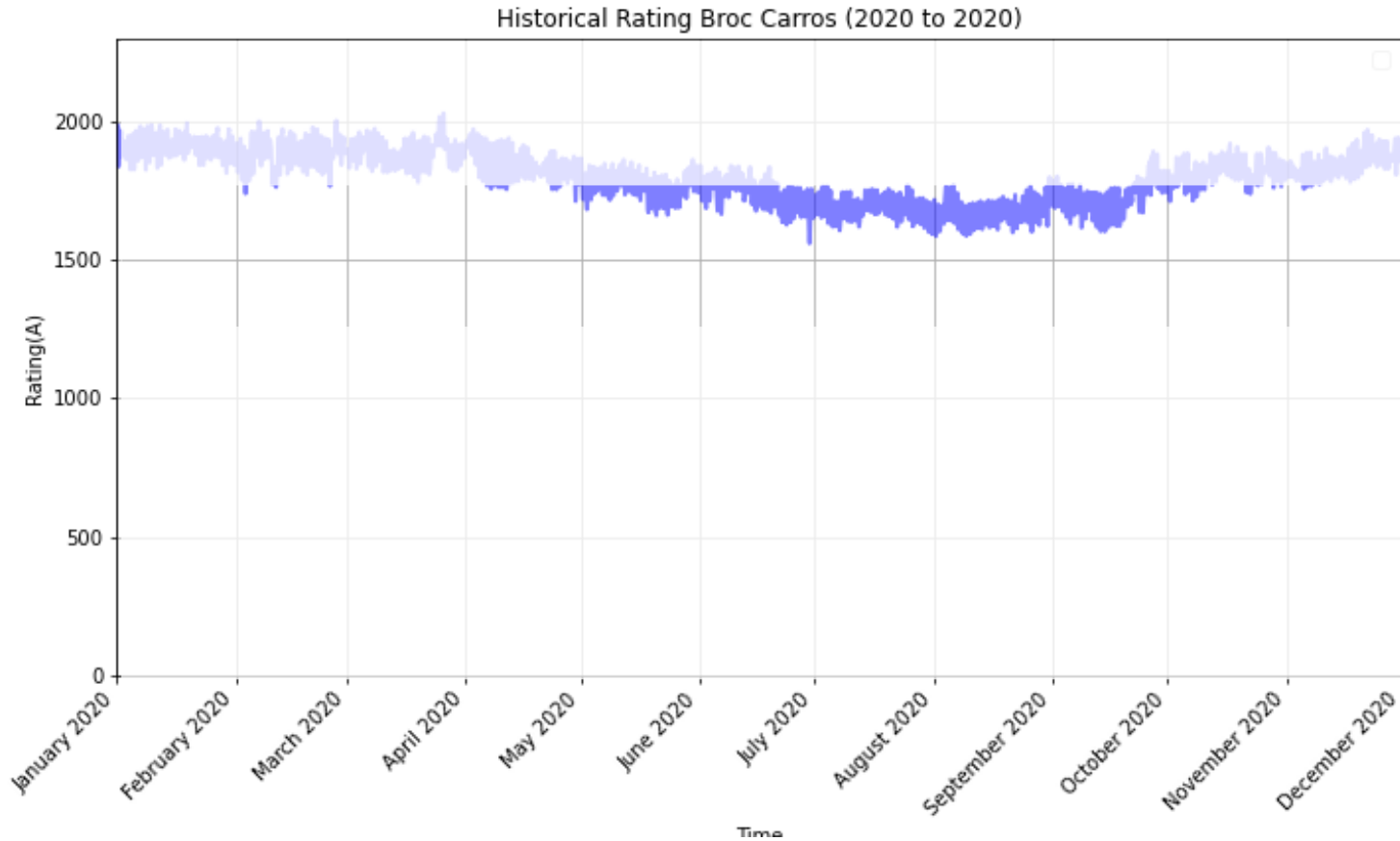

$$I_{qDTR}(\theta_a) \forall t \in [1,2 \dots 24]$$

Dynamic Thermal Rating: approaches

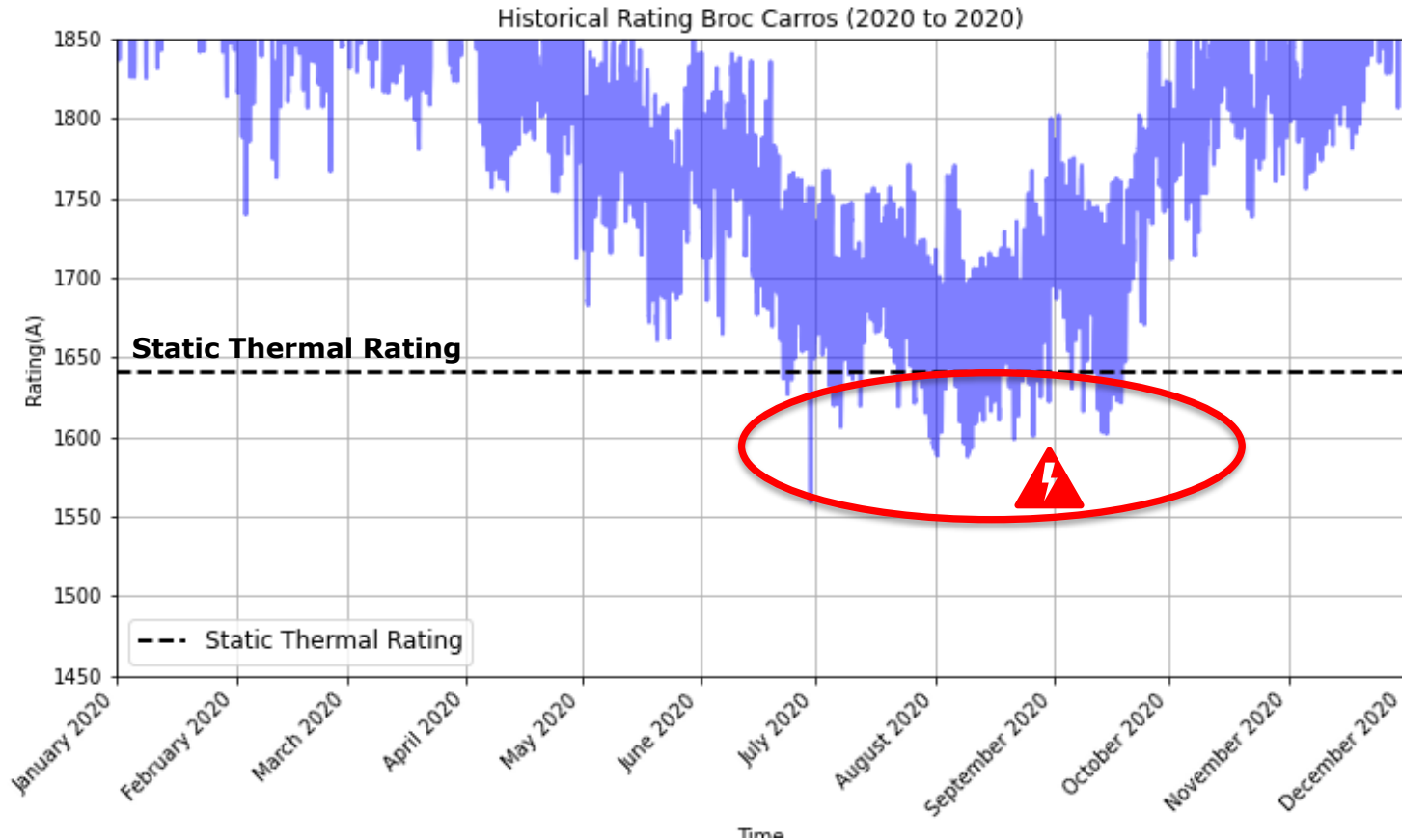

$$I_{qDTR}(\theta_a) \forall t \in [1, 2 \dots 24]$$

Dynamic Thermal Rating: approaches

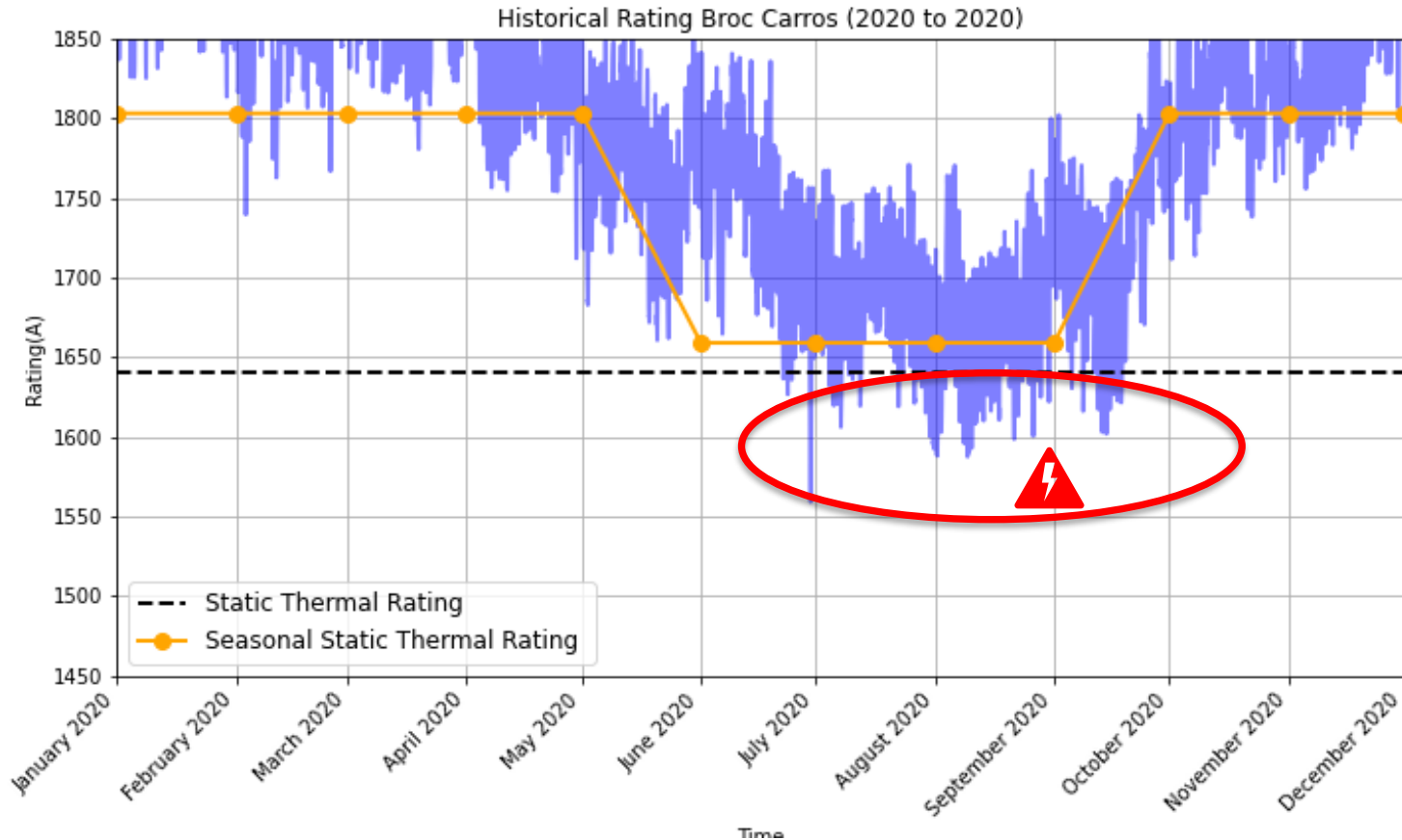

$$I_{qDTR}(\theta_a) \forall t \in [1, 2 \dots 24]$$

Dynamic Thermal Rating: approaches

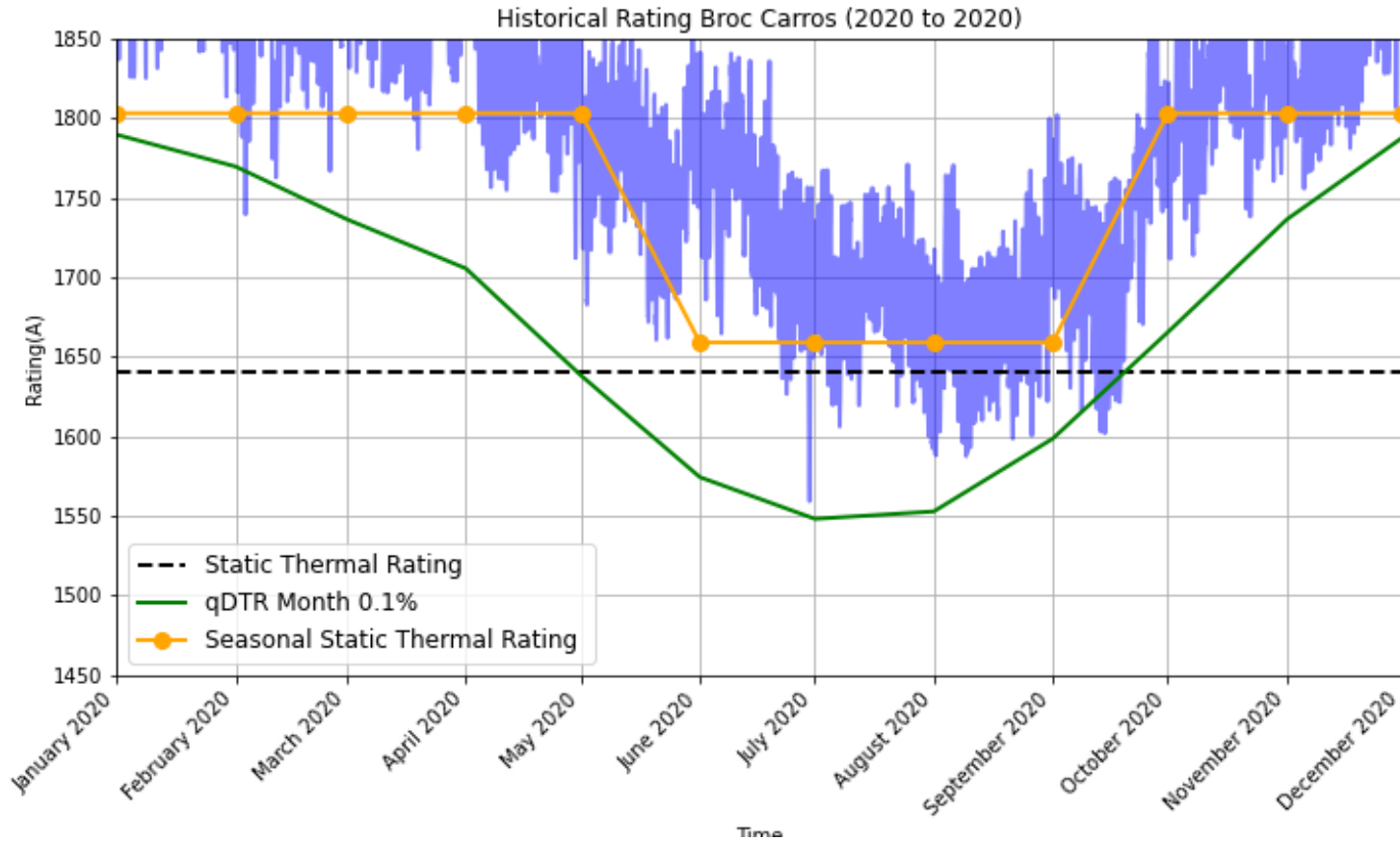

$$I_{qDTR}(\theta_a) \forall t \in [1, 2 \dots 24]$$

Dynamic Thermal Rating: approaches

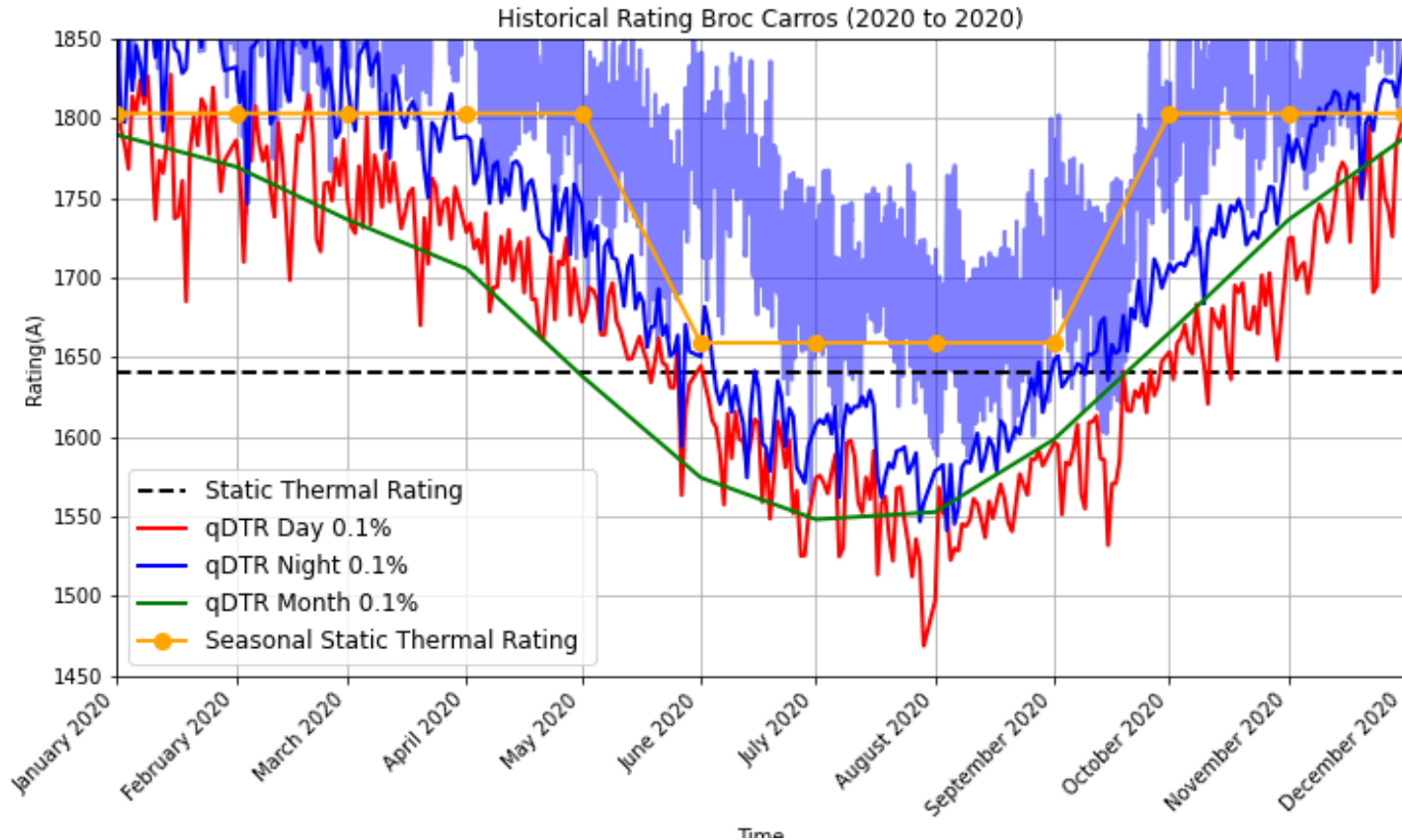

$$I_{qDTR}(\theta_a) \forall t \in [1, 2 \dots 24]$$

THERMAL MODELS PT



EEP ELECTRICAL EQUIPMENT PORTAL

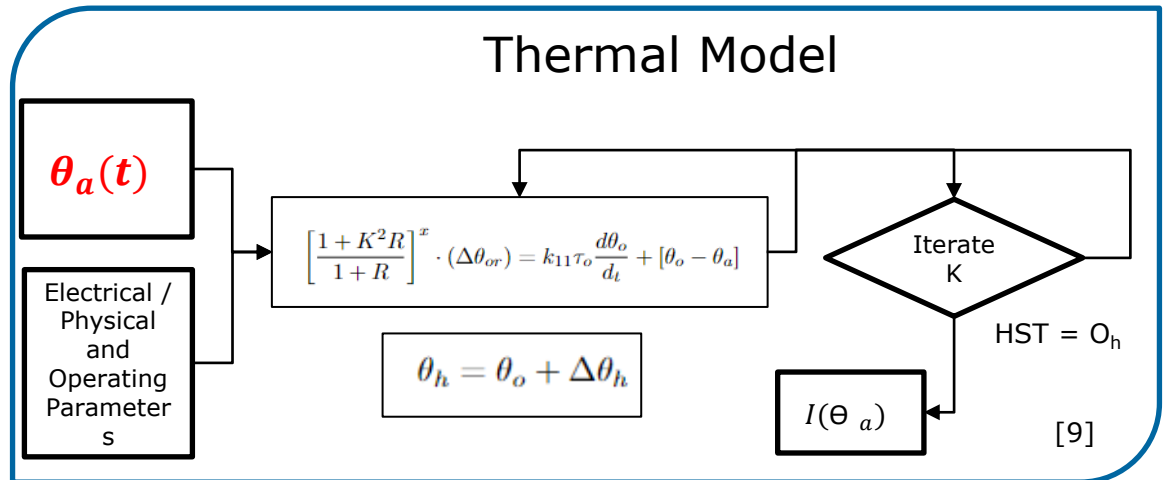
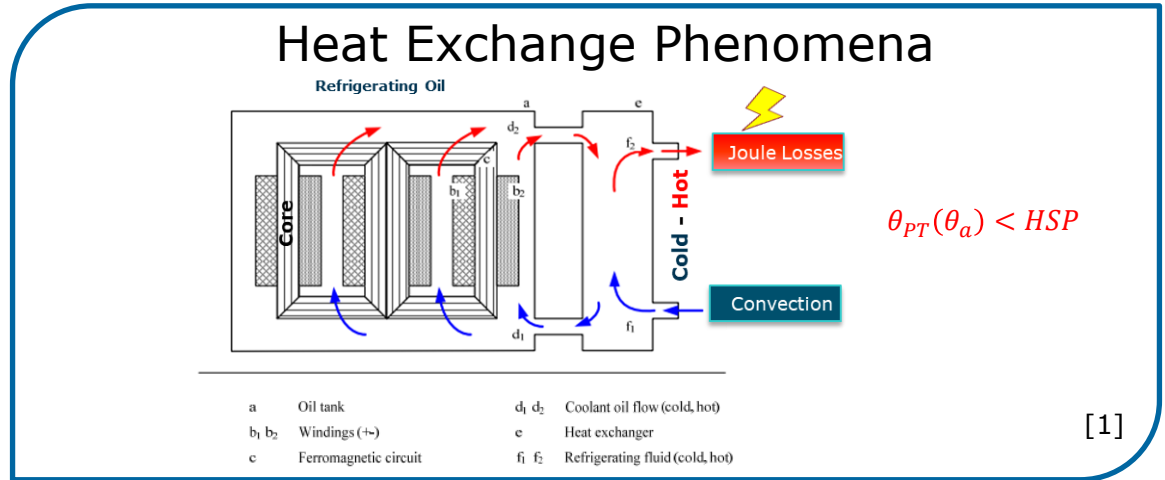

DATA

TABLE I: Thermal Characteristic listed in IEC 60076-7 used in PT model equations

Parameter, Units	Symbol or Reference	Value
Oil exponent	x	0.8
Winding Exponent	y	1.3
Loss Ratio	R	6
Hot-Spot Temperature (oC)	θ_h	98
Hot-Spot to top-oil (oC)	$\Delta\theta_{hr}$	26
Tap-Oil Temperature Raise (oC)	$\Delta\theta_{or}$	52
Constant	K_{21}	2

[9]

TABLE II: Power transformer list with parameters for qDTR analysis

Unit	Name	Calculated Power (MVA)	Resistance R(Ω)	Reactance X(Ω)
T_1	Le Broc-Carros	1194	0.1	42.3
T_2	Biaçon	1168	0.24	43.1
T_3	Realtor	1210	0.12	41.7
T_4	Tamareau	1119	0.25	45
T_5	Tavel	1184	0.14	42.6

[6,7]

ERA5 Hourly Data On Single Levels From 1940 To The Present

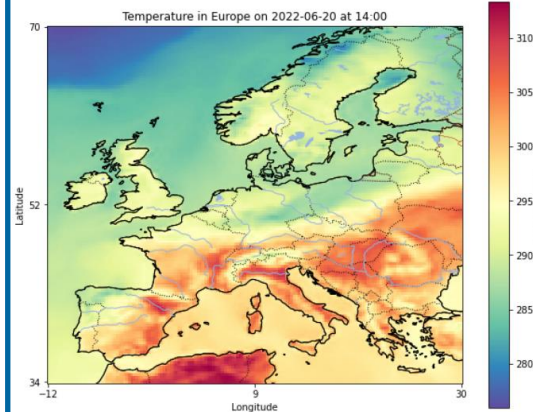

[10]



Climate And Energy Indicators For Europe From 2005 To 2100 Derived From Climate Projections

2100 temperature anomaly (RCP 8.5)

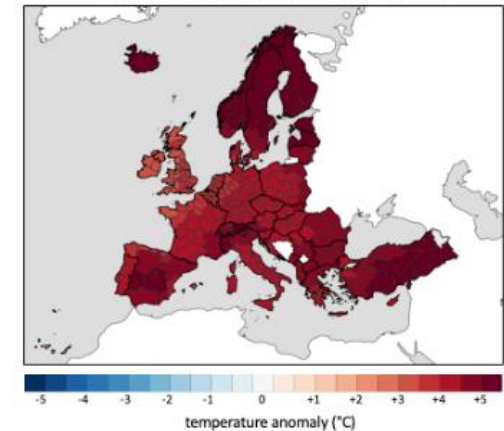

[11]



RESOURCE ESTIMATION : qDTR

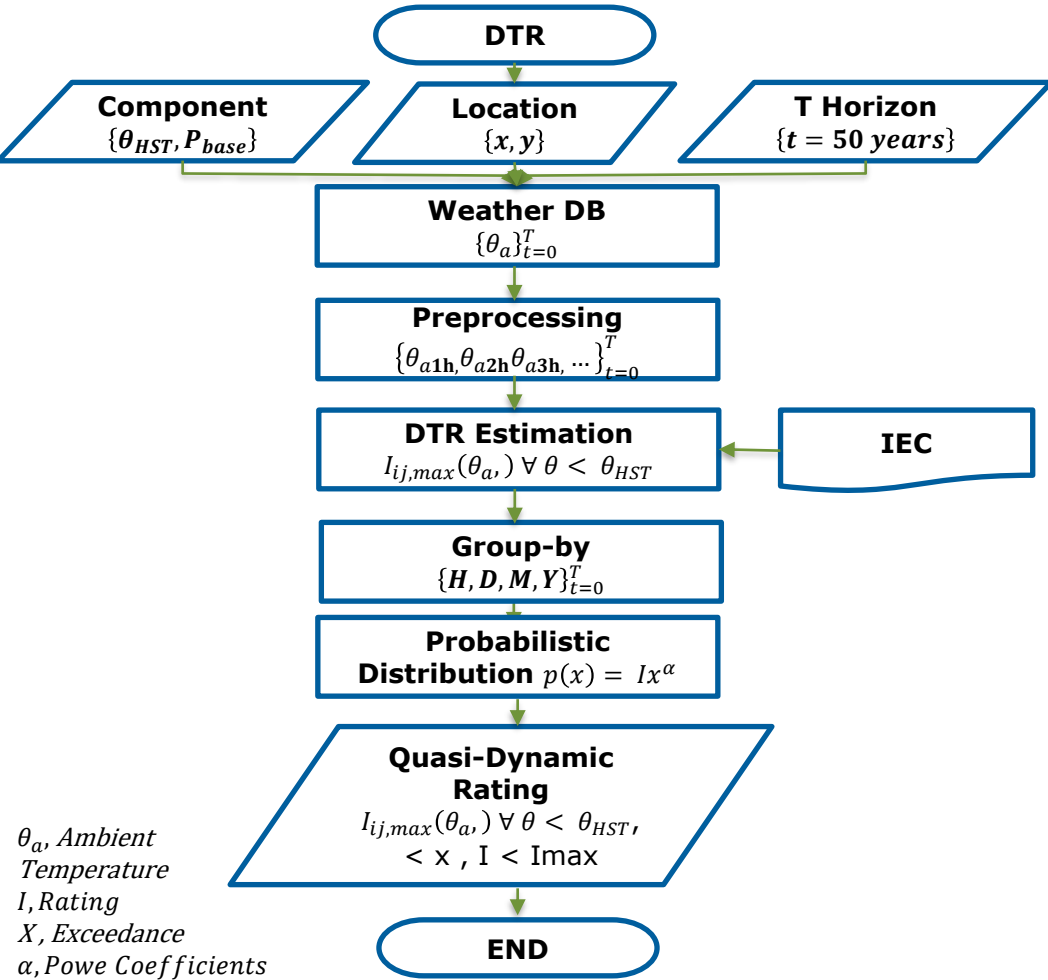

Broc-Carros Power law distribution fitting and calculating dots of the lower quantile $p(x) = Ix^\alpha$

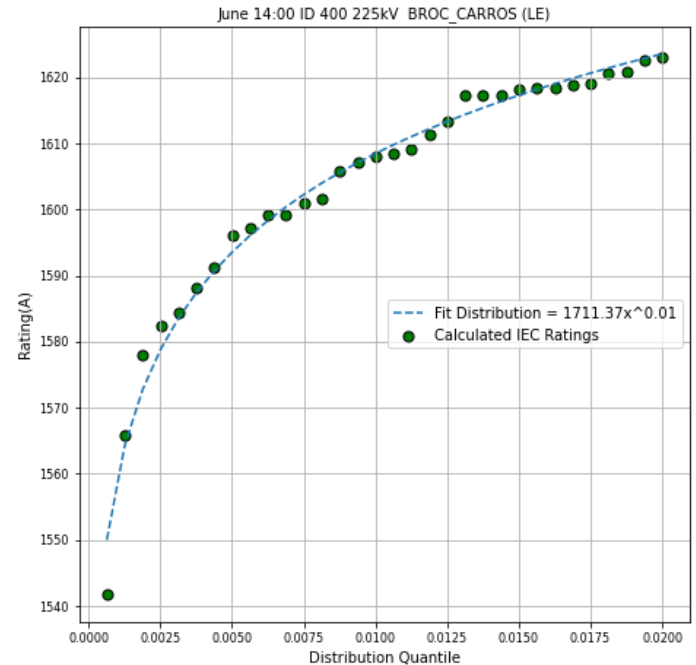

[8]

Outline

- Introduction and Context
- Results
- Methodology
- **Conclusion**

CONCLUSIONS

What will be the impact of climate change?

- Climate change could reduce average rating up to 2%
- The qDTRs methodology introduced an average uplift in the region of 7.7%

How to estimate the impact?

- qDTRs are calculated hourly/month in this work considering an exceedance probability level set at 0.1%.

Outlook

- Integrate thermal analysis into other components such as Overhead Lines and Underground Cables.
- Implement other meteorological variables such as solar irradiance and wind speed and conduct regional analyses
- Perform an economic analysis of investment and operating costs.

Sergio Daniel Montaña Salas
sergio-daniel.montana-salas@minesparis.psl.eu

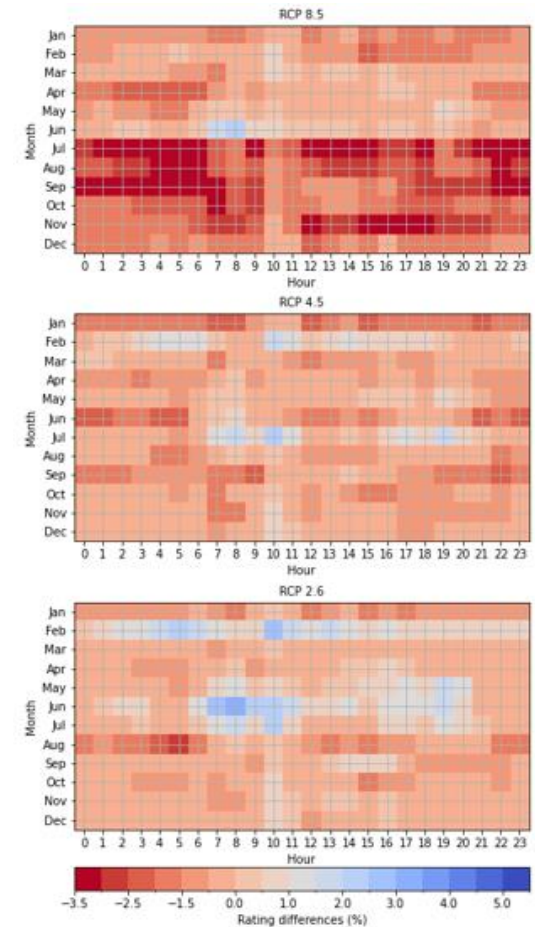

BIBLIOGRAPHY

- [1a] IEA (2023), Electricity Grids and Secure Energy Transitions, IEA, Paris <https://www.iea.org/reports/electricity-grids-and-secure-energy-transitions>, License: CC BY 4.0
- [1] Michiorri, A. (2010). Power system real-time thermal rating estimation (Doctoral dissertation, Durham University).
- [2] Copernicus Climate Change Service (C3S) - June - 2009 - Coordinates (43.80311, 7.1813) Climate Data Store (CDS), 10.24381/cds.adbb2d47 (Accessed on 14-03-2023)
- [3] IEA, Weather impact on electricity demand in the European Union per region, 2022, IEA, Paris <https://www.iea.org/data-and-statistics/charts/weather-impact-on-electricity-demand-in-the-european-union-per-region-2022>, IEA. Licence: CC BY 4.0
- [4] Ildar Daminov, Anton Prokhorov, Raphael Caire, and Marie-Cécile Alvarez-Herault. Assessment of dynamic transformer rating, considering current and temperature limitations. International Journal of Electrical Power & Energy Systems, 129:106886, 2021
- [6] RTE.France's Transmission System Operator, 'Electrical features of the network of RTE', Published. [Online]. Available: <https://www.services-rte.com/en/learn-more-about-our-services/static-grid-model.html>. [Accessed: 05- Feb- 2023]
- [7] Enedis. Enedis Open Data, 'Cartographie des réseaux exploités par Enedis', Published. [Online] Available: <https://data.enedis.fr/pages/cartographie-des-reseaux-contenu/>. [Accessed: 13- Mar- 2023]
- [8] S. Hadiwidjaja, S. Montana-Salas, A. Michiorri 'Quasi-Dynamic Line Rating spatial and temporal analysis for network planning'. CIRED 2023
- [9] IEC 60076-7:2018 - Power transformers - Part 7: Loading guide for mineral-oil-immersed power transformers, 2018
- [10] Hersbach, H., Bell, B., Berrisford, P., Biavati, G., Horányi, A., Muñoz Sabater, J., Nicolas, J., Peubey, C., Radu, R., Rozum, I., Schepers, D., Simmons, A., Soci, C., Dee, D., Thépaut, J.-N. (2023): ERA5 hourly data on single levels from 1940 to present. Copernicus Climate Change Service (C3S) Climate Data Store (CDS), DOI: [10.24381/cds.adbb2d47](https://doi.org/10.24381/cds.adbb2d47)
- [11] Copernicus Climate Change Service (2021): Climate and energy indicators for Europe from 2005 to 2100 derived from climate projections. Copernicus Climate Change Service (C3S) Climate Data Store (CDS). DOI: [10.24381/cds.f6951a62](https://doi.org/10.24381/cds.f6951a62)

