



HAL
open science

The WP16 - Multi-Scale Laboratories: The Analog Modelling Community

Stephane Dominguez

► **To cite this version:**

Stephane Dominguez. The WP16 - Multi-Scale Laboratories: The Analog Modelling Community. 2021. ⟨hal-04224282⟩

HAL Id: hal-04224282

<https://hal.science/hal-04224282v1>

Preprint submitted on 1 Oct 2023

HAL is a multi-disciplinary open access archive for the deposit and dissemination of scientific research documents, whether they are published or not. The documents may come from teaching and research institutions in France or abroad, or from public or private research centers.

L'archive ouverte pluridisciplinaire HAL, est destinée au dépôt et à la diffusion de documents scientifiques de niveau recherche, publiés ou non, émanant des établissements d'enseignement et de recherche français ou étrangers, des laboratoires publics ou privés.



Distributed under a Creative Commons CC BY-NC-ND 4.0 - Attribution - Non-commercial use - No Derivative Works - International License

S. Dominguez

12/10/2021

The EPOS-MSL Consortium: 11 members, >85 laboratories from 12 countries

**ANALOG
MODELLING**

**ROCK AND MELT
PHYSICAL PROPERTIES**

**PALEOMAGNETIC
MAGNETIC DATA**

**ANALYTICAL AND
MICROSCOPY DATA**

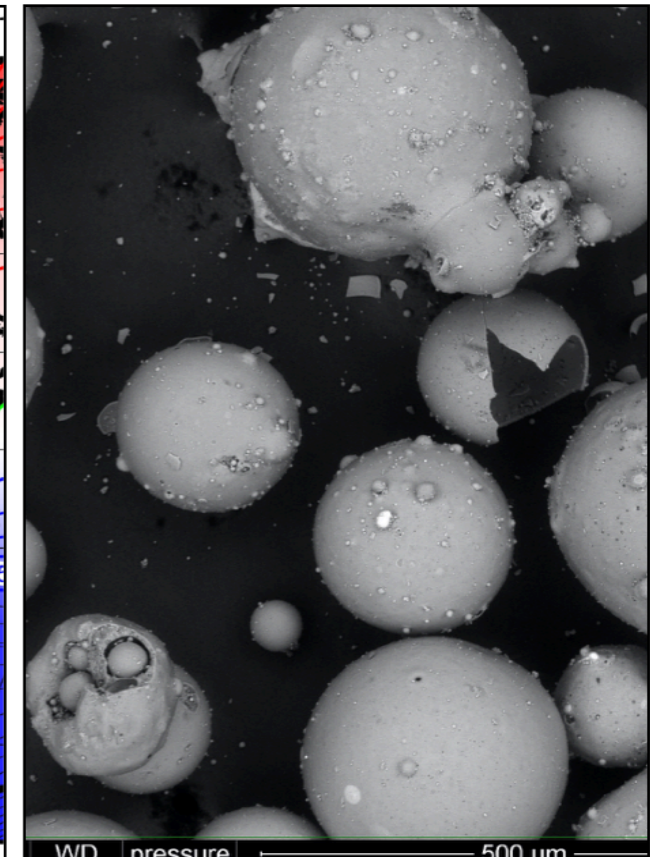
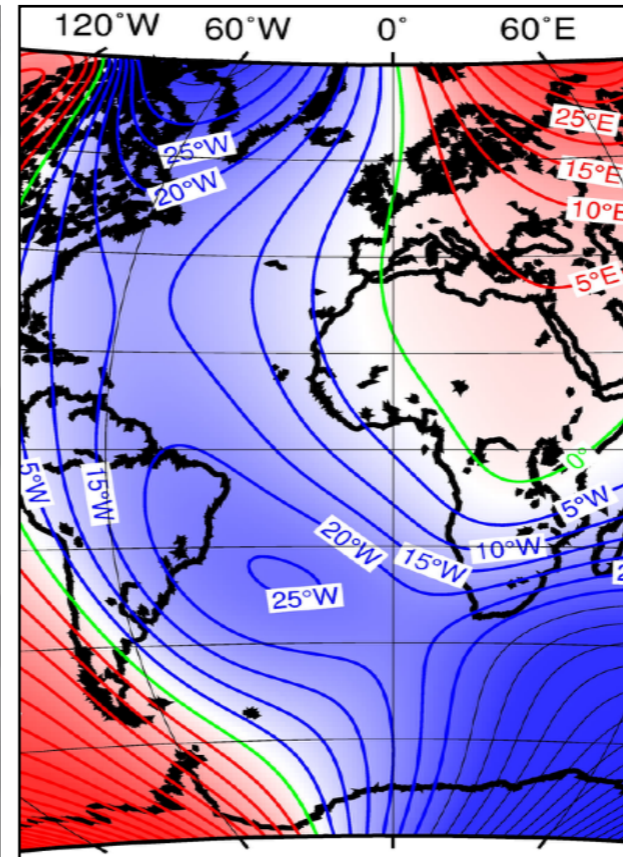
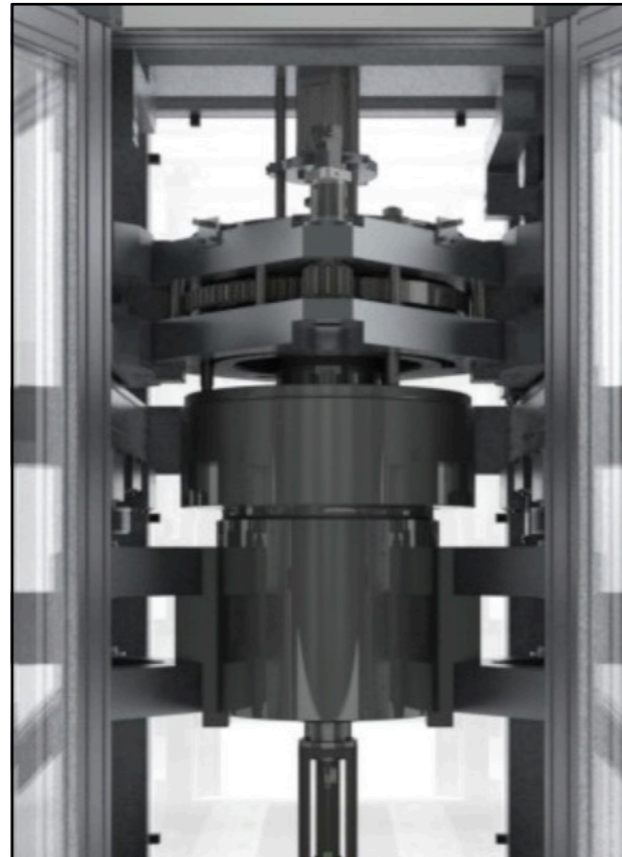

The EPOS-MSL research infrastructures and the data that they produce, are currently grouped into four subdomains: 1-Analogue modelling of geologic processes, 2-Rock and melt physical properties, 3-Paleomagnetic and magnetic data, and 4- Analytical and Microscopy data.

MSL - ANALOG MODELING

The research activities cover a (very) wide range of geological processes, time and space scales

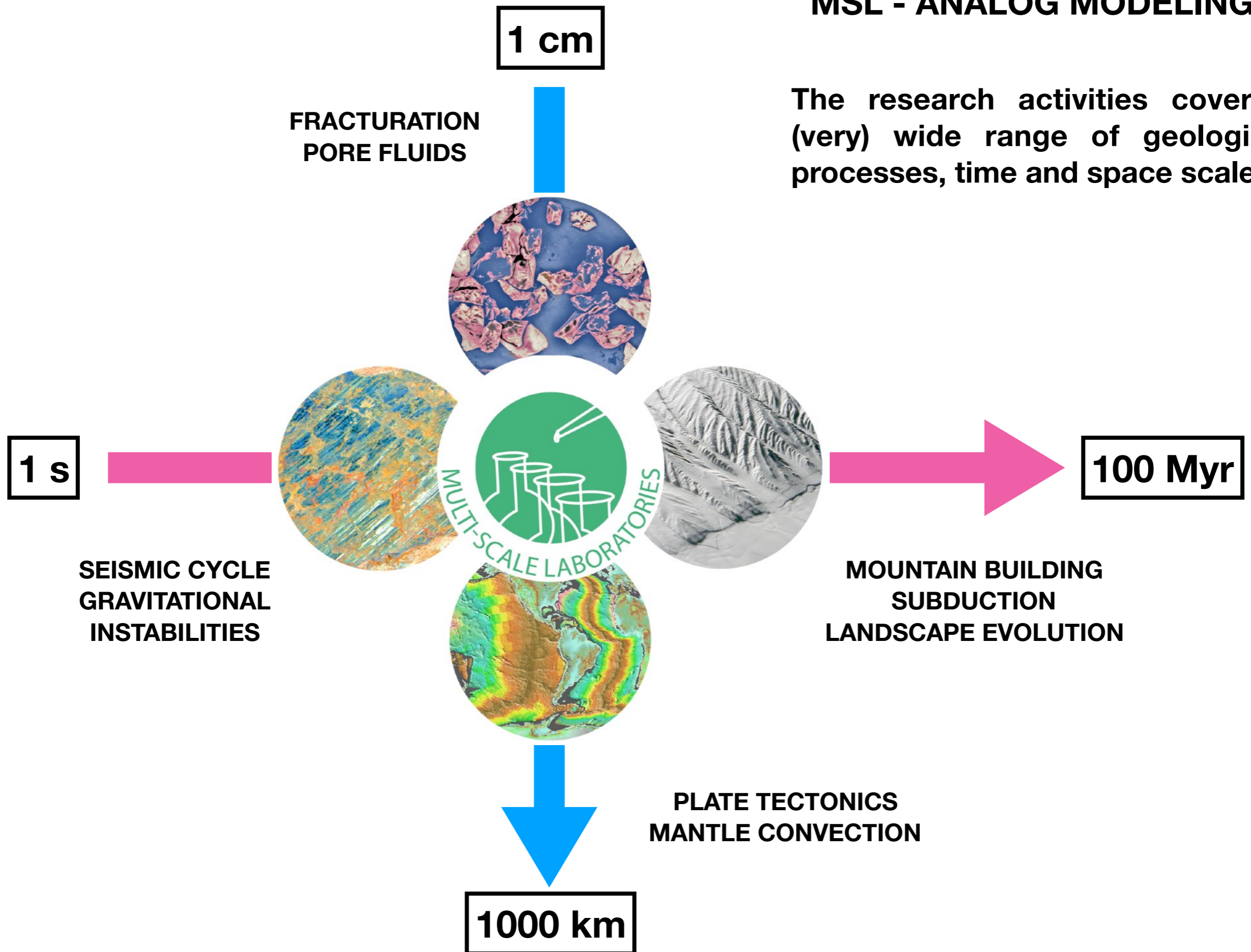



Analytical microscopy



Paleomagnetism



Analog modelling



Rock physics

EPOS - MSL ANALOG MODELING

9 Countries

~30 Laboratories

> 100 people





SPAIN



5 LABORATORIES



UNIVERSITAT DE BARCELONA

GEOMODELS Research Institute
Oriol Ferrer GARCIA and Oscar GRATACOS TORRA

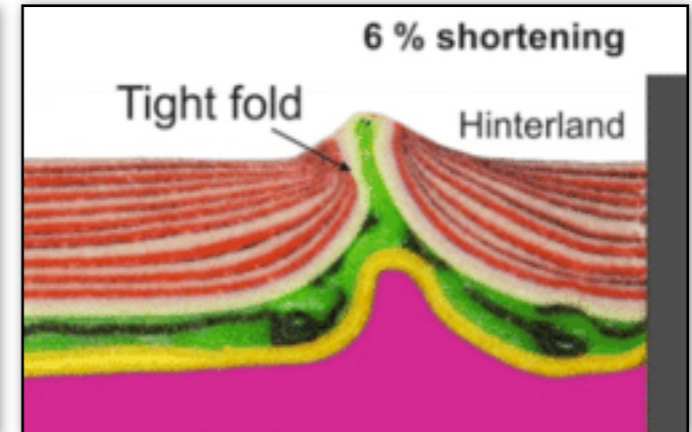
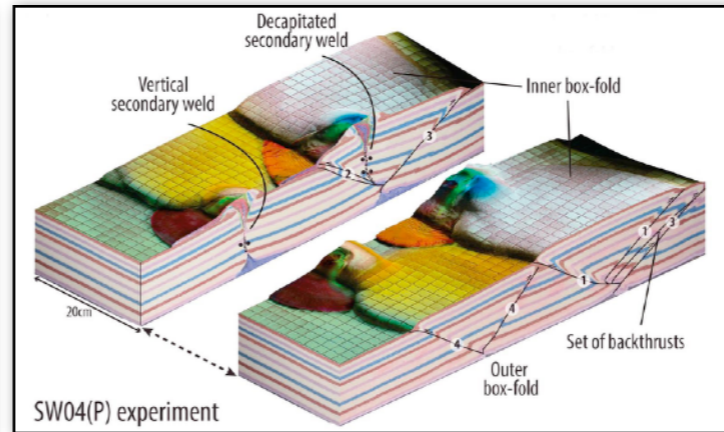

Highlights: Salt Tectonics, Orogenic wedge, Tectonic Inversion, ...



GEOSCIENCIAS BARCELONA-CSIC
SIMGEO Facilities
Joan Martí MOLIST (CSIC) and Ferran COLOMBO (UB)

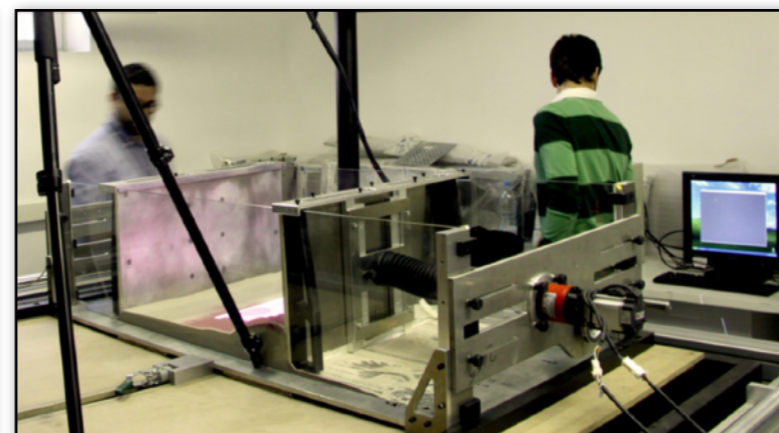

Highlights: Accretionary wedge, Magma Chamber, ...

UAB

Universitat Autònoma de Barcelona

Laboratorio de Deformació Experimental - MIET

Jordi CARRERAS PLANELLS

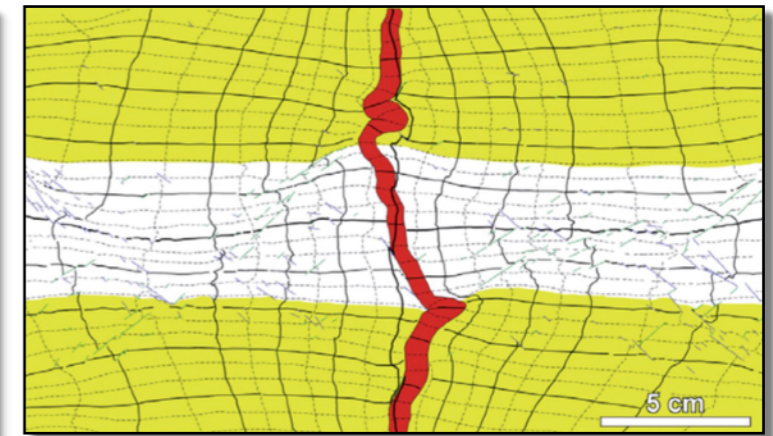
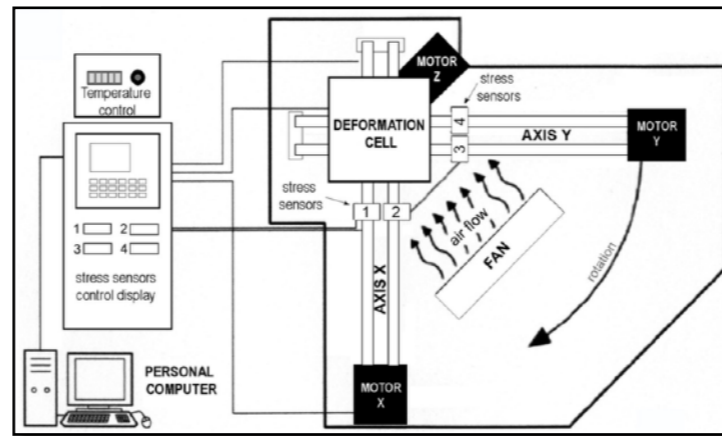
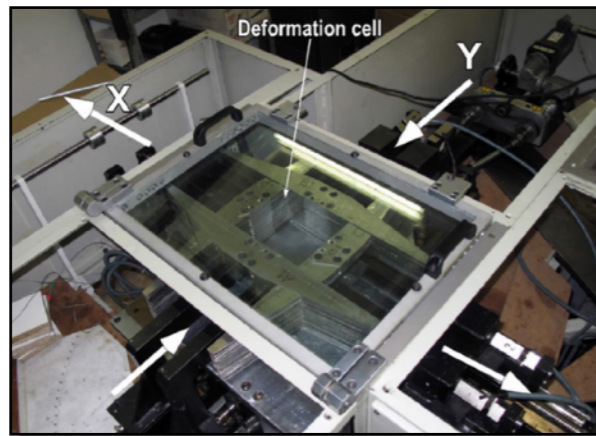

Highlights: Shear Fracture modelling, Ductile deformation, ...



**UNIVERSIDAD
DE GRANADA**

**Laboratorio de Modelización Analógica de
Estructuras Geológicas**

Ana CRESPO-BLANC

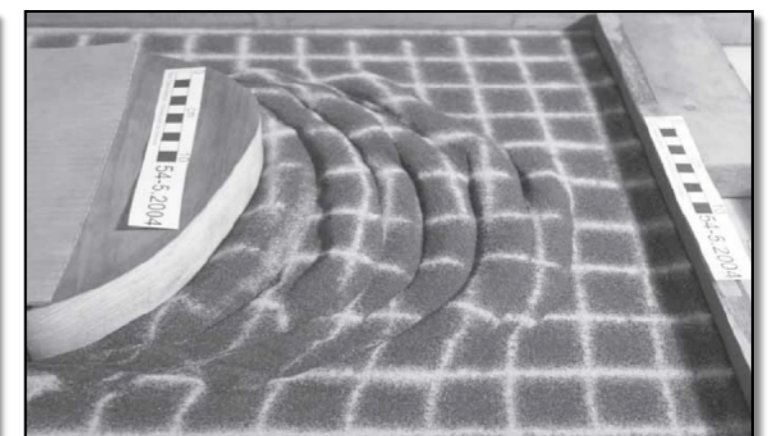
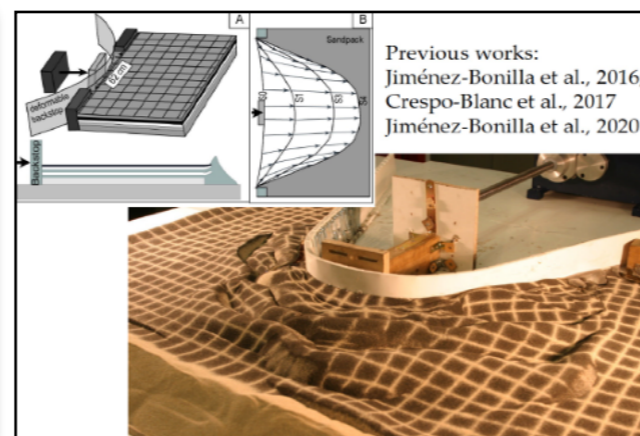
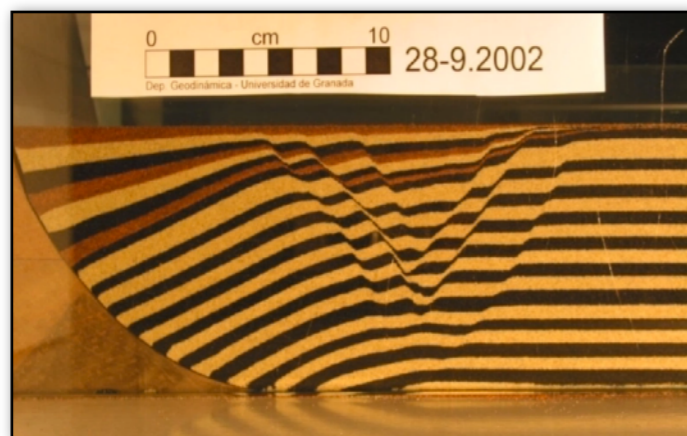

Highlights: Crustal Extension, Folding, Orogenic wedge, ...



SPAIN



Departamento de
Ciencias de la Tierra
Universidad Zaragoza

Laboratorio de Modelización Analógica - U Zaragoza

Tereasa ROMAN-BERDIEL and Antonio CASAS-SAINZ



Highlights: Continental extension and Compression, Folding , ...



SWITZERLAND



1 LABORATORY

u^b

TECTONIC MODELLING LABORATORY BERN

Guido SCHREURS and Frank ZWAAN

**UNIVERSITÄT
BERN**

X-ray computed tomography is used to analyze the 3-D geometry and kinematic evolution of model structures

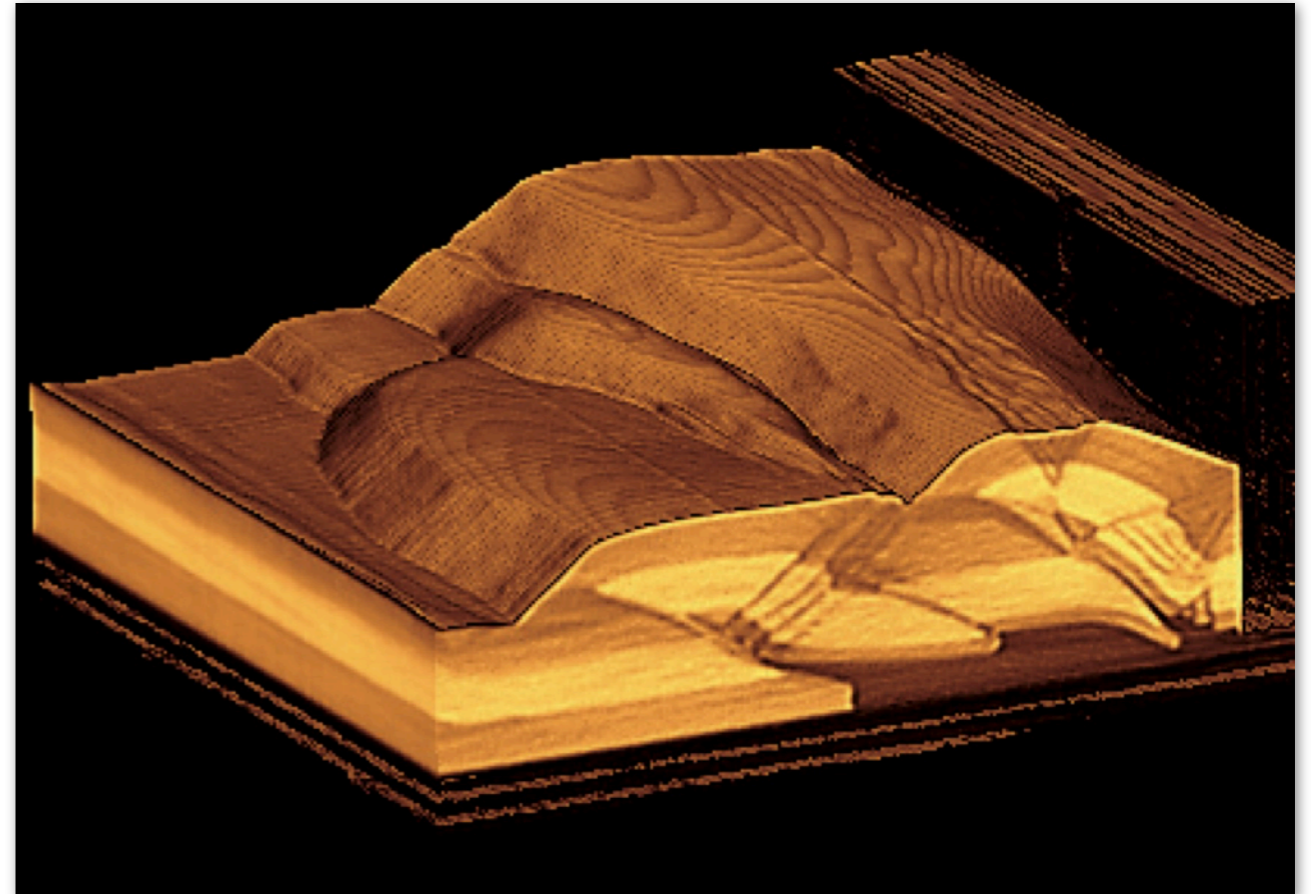

Highlights: Transpression/Transtension, Salt Tectonics, Basin Inversion, ...



MULTI-SCALE LABORATORIES



FRANCE



TEC MOD F

French Tectonic Analog Modeling network



A NETWORK of 10 LABS

S. DOMINGUEZ



Géosciences - University Rennes 1

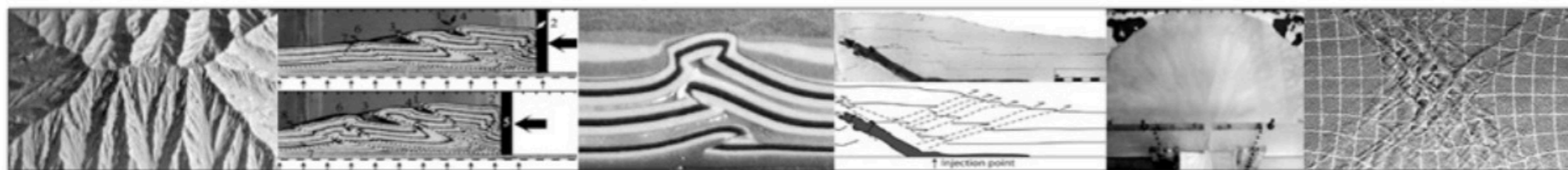

Lithospheric deformation. Salt tectonics. Fluvial incision. Fluid/deformation interactions

**Benjamin
GUILLAUME**



Géosciences - University of Montpellier

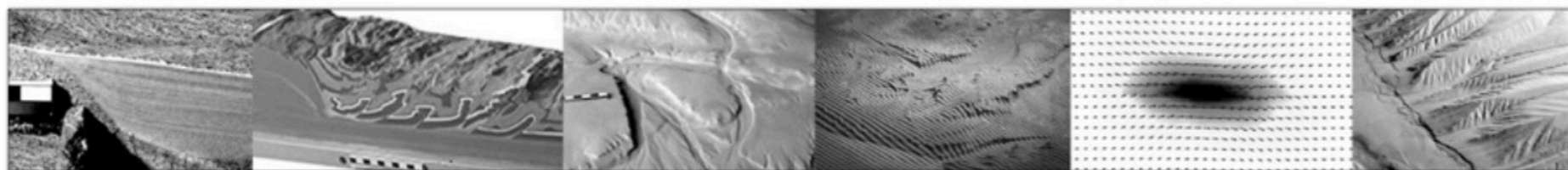

Subduction-collision, Relief dynamics, Fault kinematics, Seismic cycle, Tectonic/Climate interactions

**Stephane
DOMINGUEZ**



LOG - University Lille 1



Salt tectonics/fluids, Mountain foreland dynamics, Deformation/Sedimentation interactions

**Fabien
GRAVELEAU**



Géosciences et Environnement - University of Cergy-Pontoise

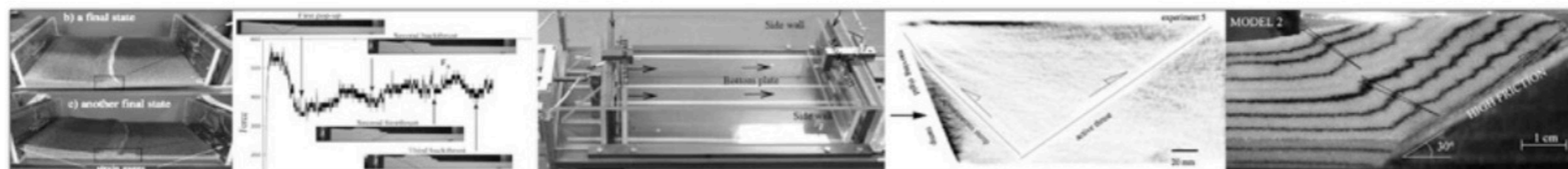

Deformation mechanics, Faulting and folding, Numerical modelling, Inverse problem

**Pauline SOULOUMIAC
Bertrand MAILLOT**



TEC MOD F
French Tectonic Analog Modeling network



Geolab - University of Maine

Régis MOURGUES

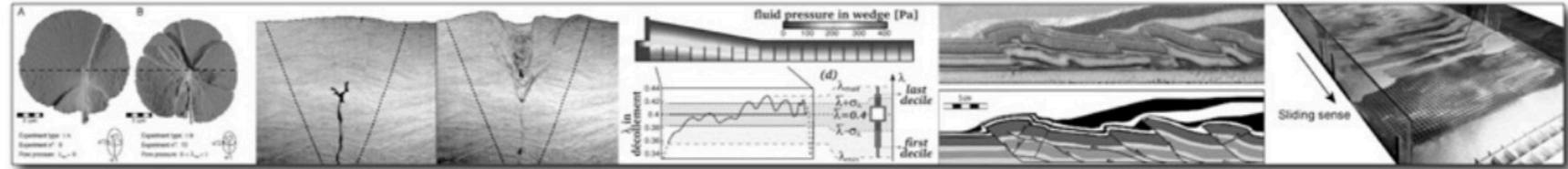

Reservoir tectonics, Hydraulic fracturation, Magma/injectite intrusions, Gravitational instability

Géosciences Environnement - University of Toulouse

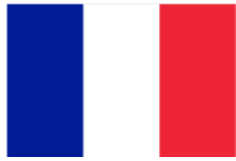

MULTI-SCALE LABORATORIES



GeoAzur - University of Nice Sophia Antipolis

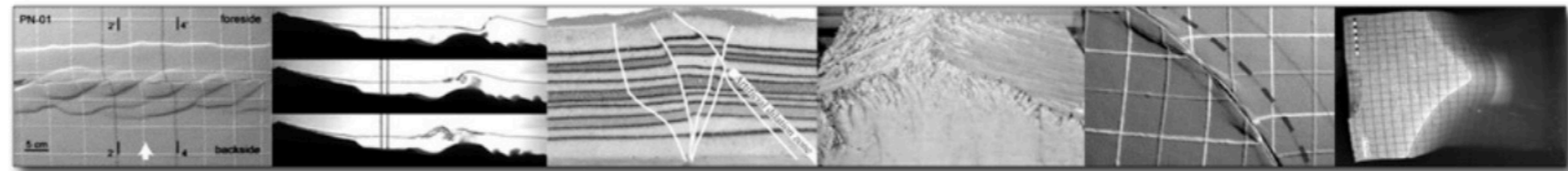

Continental and coastal geomorphology, Tectonics, Relief Dynamics, Piedmont, Erosion

Stephane BONNET

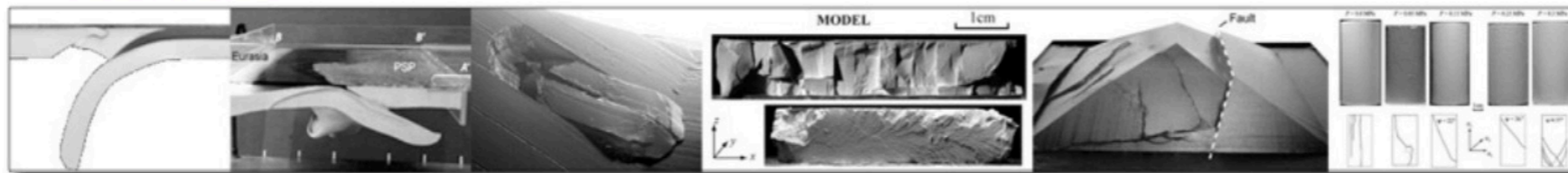

Rupture mechanics, Landslides, Fractured reservoirs, Oceanic/continental subduction

Alexandre CHEMENDA



Fluides, Automatique et Systèmes Thermiques

FAST - University of Paris Sud Orsay

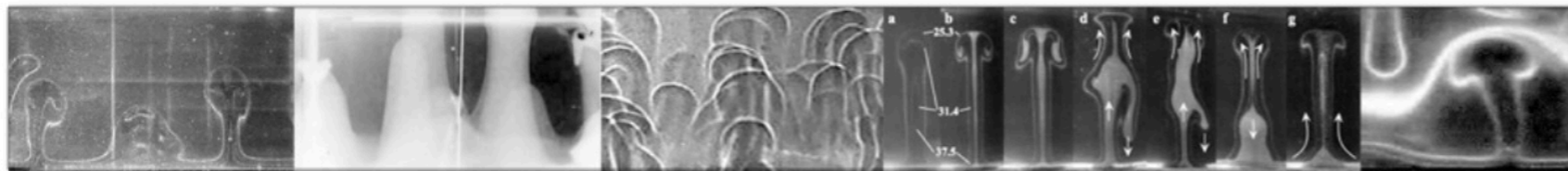

Mantle dynamics, Mantle diapirs, Multi-scale convection, Instabilities, waves and turbulence, heat flow

Anne DAVAILLE

NEW

**Joseph MARTINOD
Virginie PINEL**



Laboratoire Magmas & Volcans

Magmas et Volcans - University of Clermont-Ferrand

Olivier ROCHE



ISTerre Chambéry - Université de Savoie Mont-Blanc

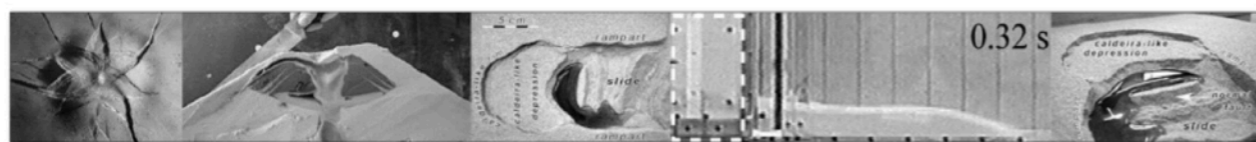

Volcanology, plumbing systems, Instabilities, Pyroclastic density current, Debris flows

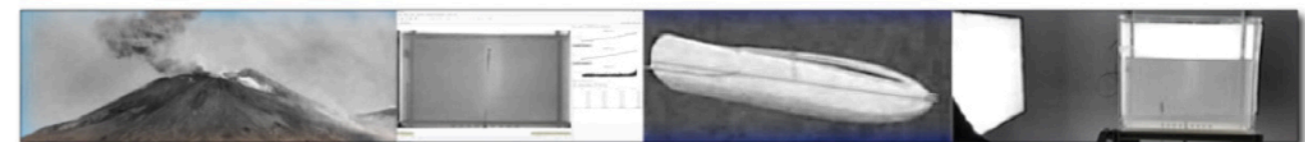

Volcanology, Subduction zone, Fracture, Fluid injection



NETHERLANDS



2 LABORATORIES

EARTH SIMULATION Laboratory (ESL)



Utrecht
University

TECTONIC MODELLING LABORATORY (TecLab)

Ernst WILLINGSHOFER

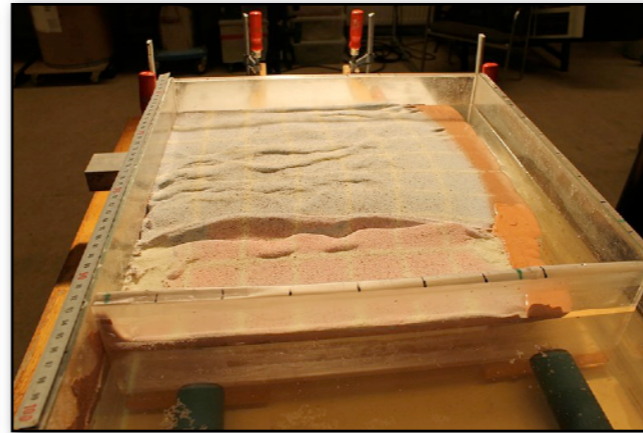
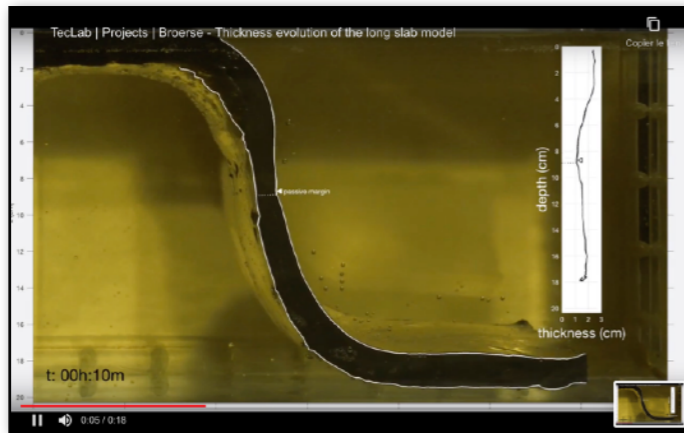

Highlights: Subduction, Lithosphere Rheology and Plate Deformation, ...



Utrecht
University

FLUME FACILITIES Metronome & Eurotank

Maarten KLEINHANS and Joris EGGENHUISEN



Highlights: Tidal Flow, Sediment Transport, River Estuaries, Deltas...



ITALY



2 LABORATORIES



LABORATORY OF EXPERIMENTAL TECTONICS (LET)
Francesca FUNICIELLO and Claudio FACCENNA

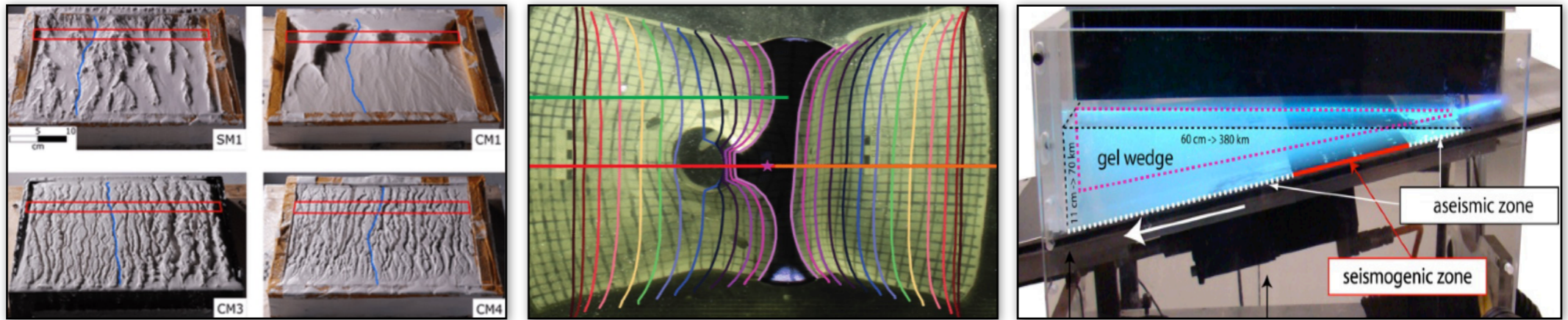

Highlights: Earthquakes, Subduction/Mantle convection, Volcano-Tectonics, Geomorphology, ...



TECTONIC MODELLING Lab. - IGG Florence
Marco BONINI, Giacomo CORTI and Domenico MONTANARI

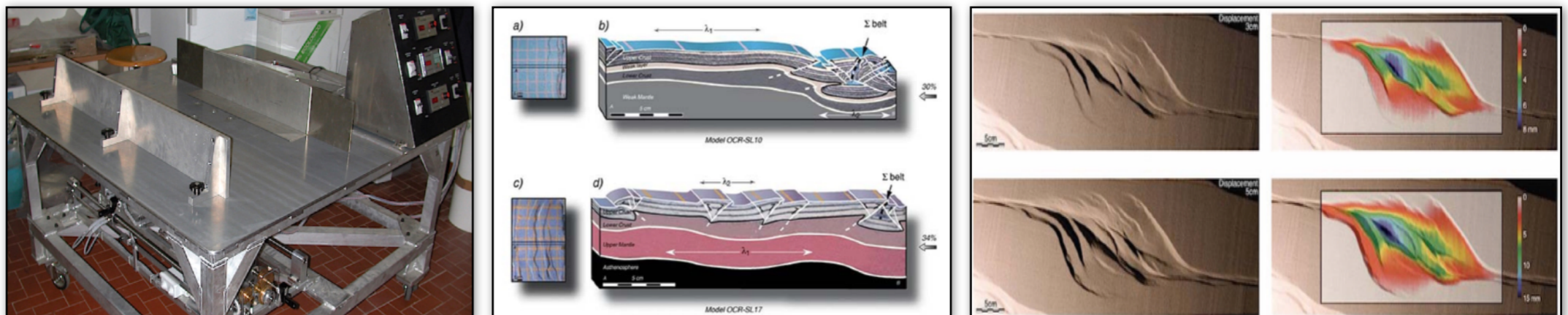

Highlights: Continental Extension, Orogeny, Volcano-Tectonics, Geomorphology...



HelTec - HELMHOLTZ Lab. for TECTONIC MODELLING

Matthias ROSENAU, Onno Oncken and Claudio FACCENNA

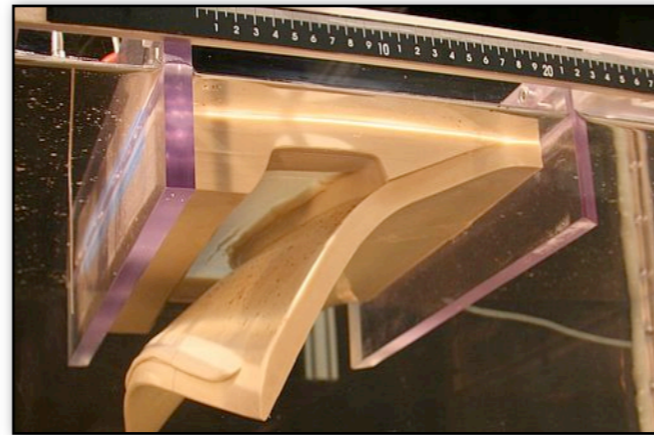
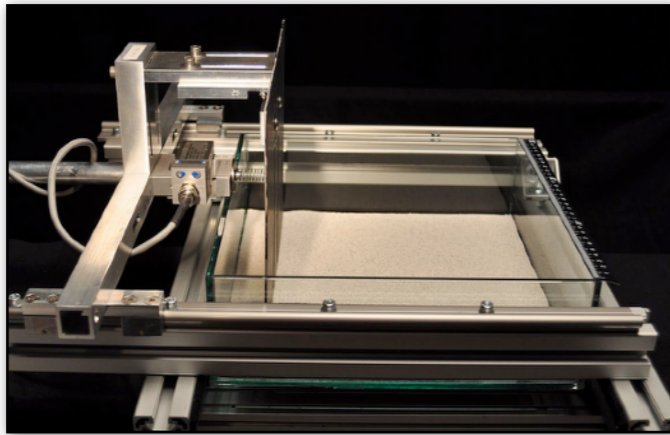

Highlights: Mantle dynamics, Subduction, Seismic cycle, ...



Universität Hamburg
DER FORSCHUNG | DER LEHRE | DER BILDUNG

UHH-Tec - EXPERIMENTAL TECTONICS LABORATORY

Ulrich RILLER and Jan Oliver EISERMANN

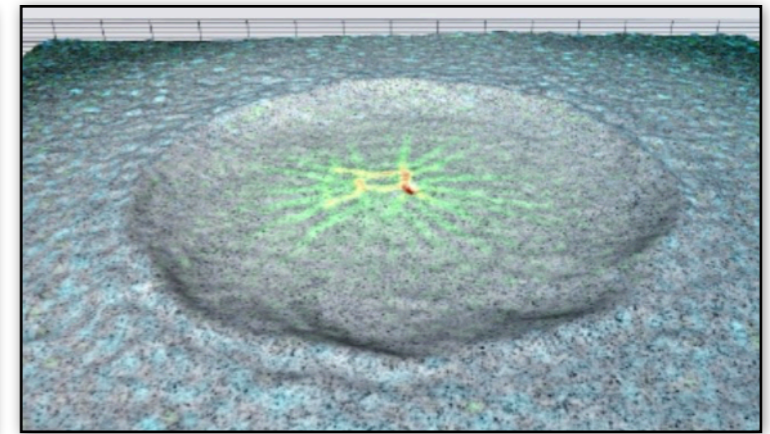
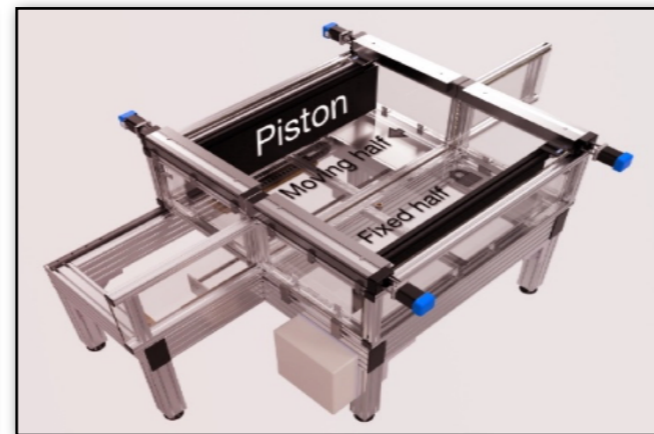
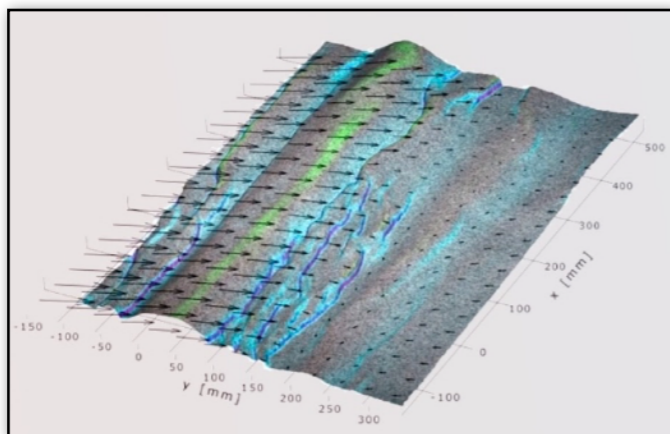

Highlights: Mantle dynamics, Subduction, Orogenic wedge, ...



LMU - FRAGMENTATION LAB and ANALOG MODELLING LAB.

Corrado CIMARELLI and Don DINGWELL, Sara CARENA

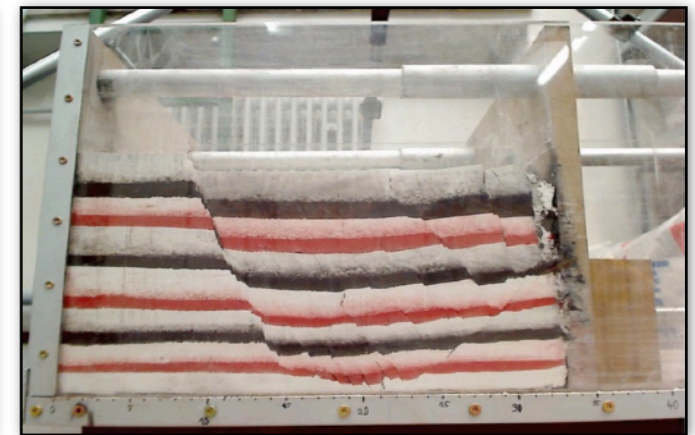
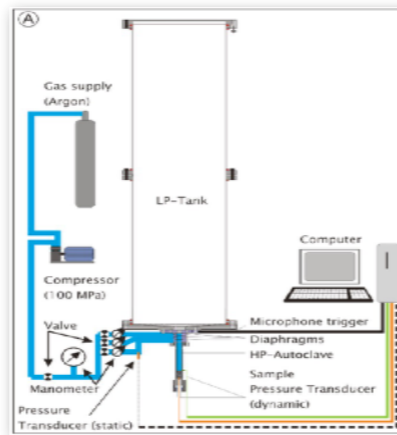
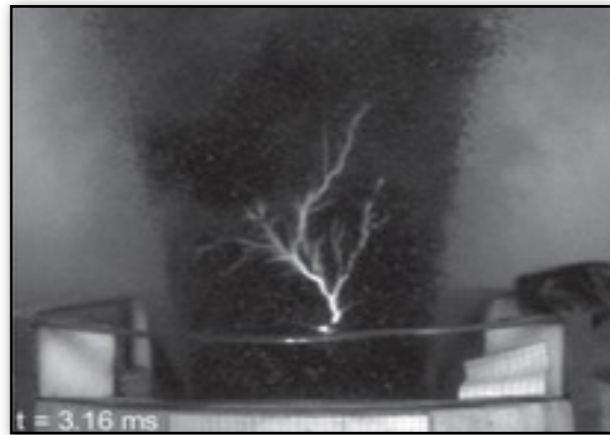

Highlights: Volcanic processes, Pyroclastic flow, Magma Analog / Rifting, Normal Faulting, ...

Lehr- und Forschungsgebiet für
Geologie – Endogene Dynamik
Structural Geology – Tectonics – Geomechanics



RWTH-AACHEN ANALOG MODELLING LAB.

Susanne BUITERS and Nicolas MOLNAR

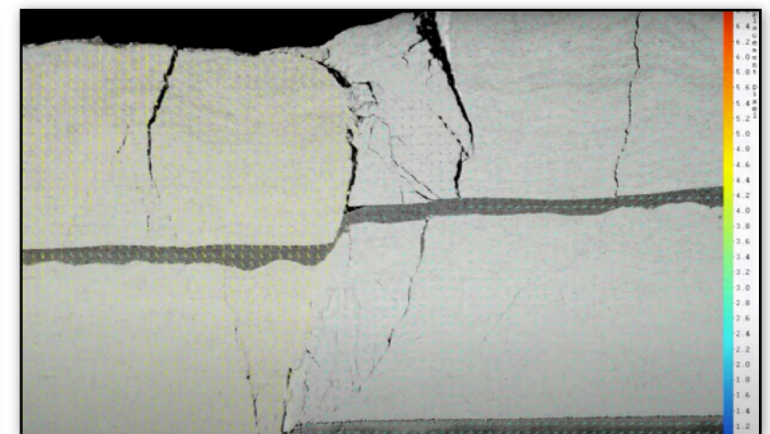
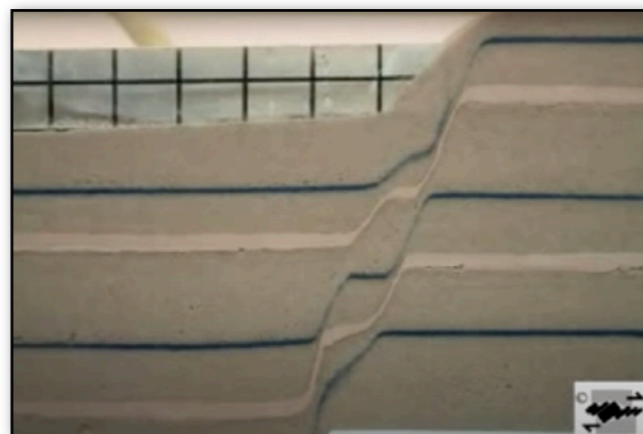

Highlights: Crustal Extension, Fracturation, Ductile Deformation, ...

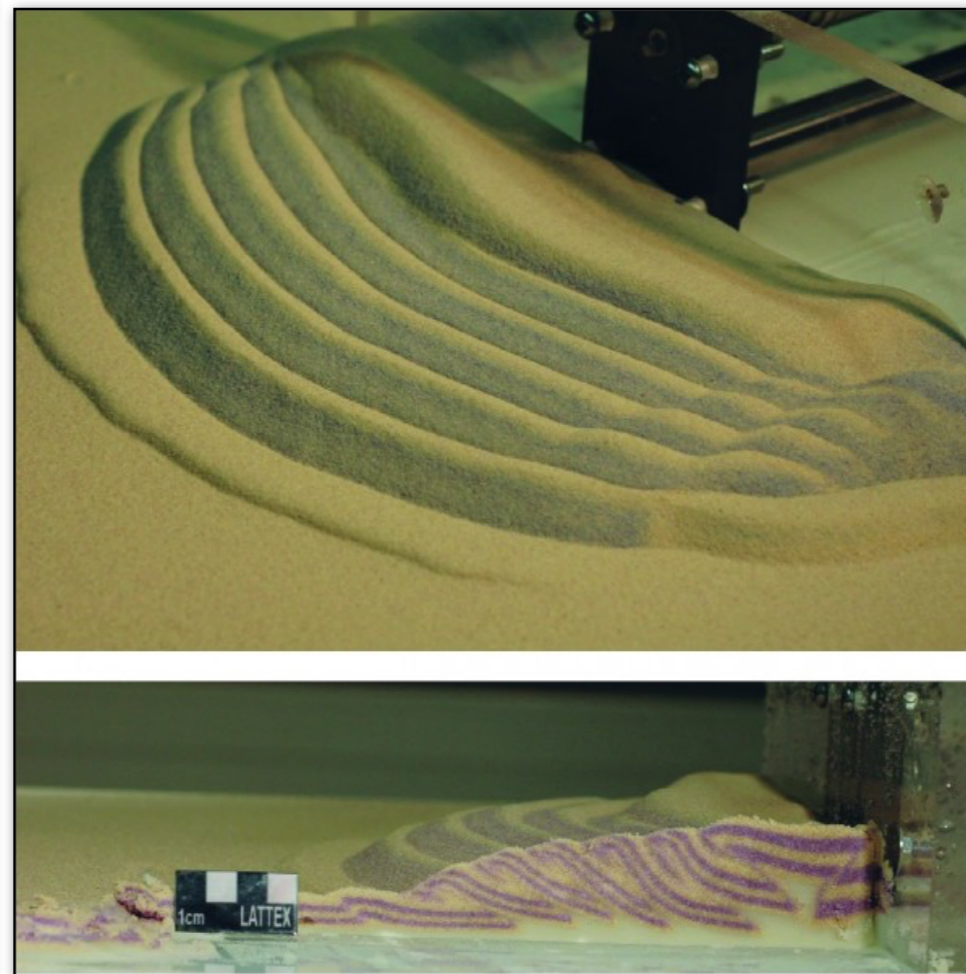
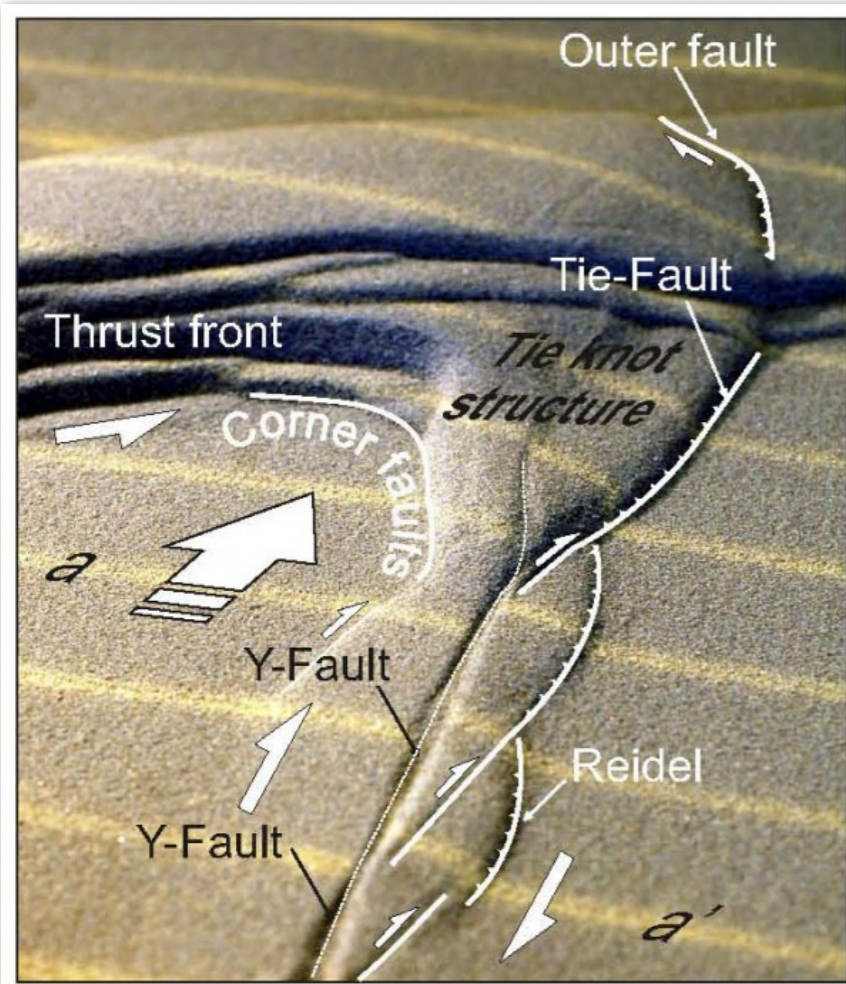

Highlights: Continental Tectonics, Ductile deformation, ...

OTHER LABS IN THE PROCESS OF JOINING THE EPOS-MSL Analog Modeling Community



UNITED-KINGDOM



UNIVERSITY OF LONDON
FAULT DYNAMICS ANALOG
MODELLING LABORATORIES

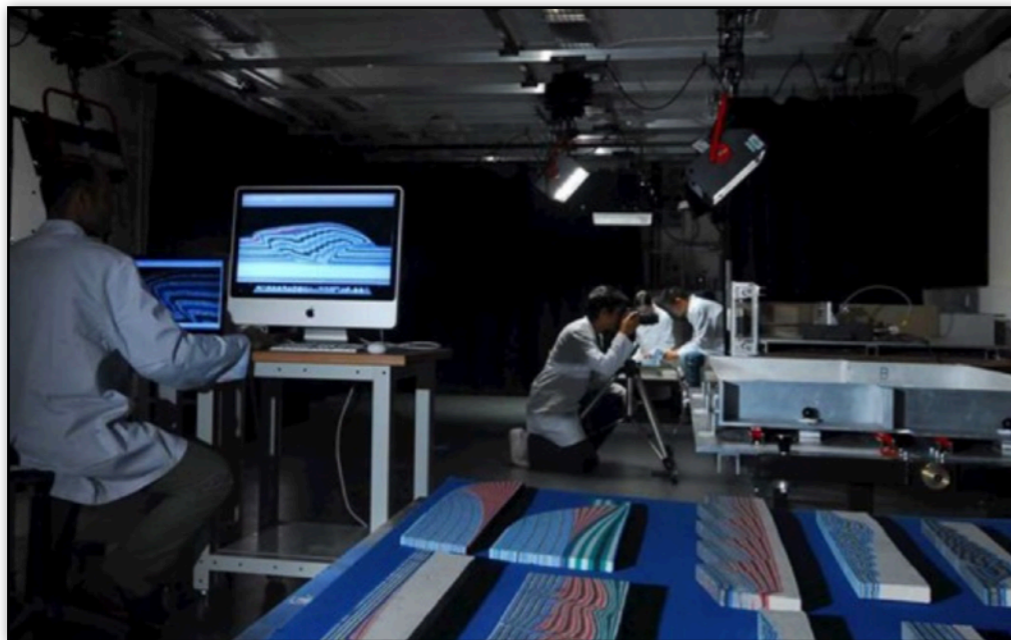

CZECH



INSTITUTE OF GEOPHYSICS
OF THE CZECH ACADEMY OF SCIENCES

ANALOG MODELLING LAB.

Michael WARSITZKA

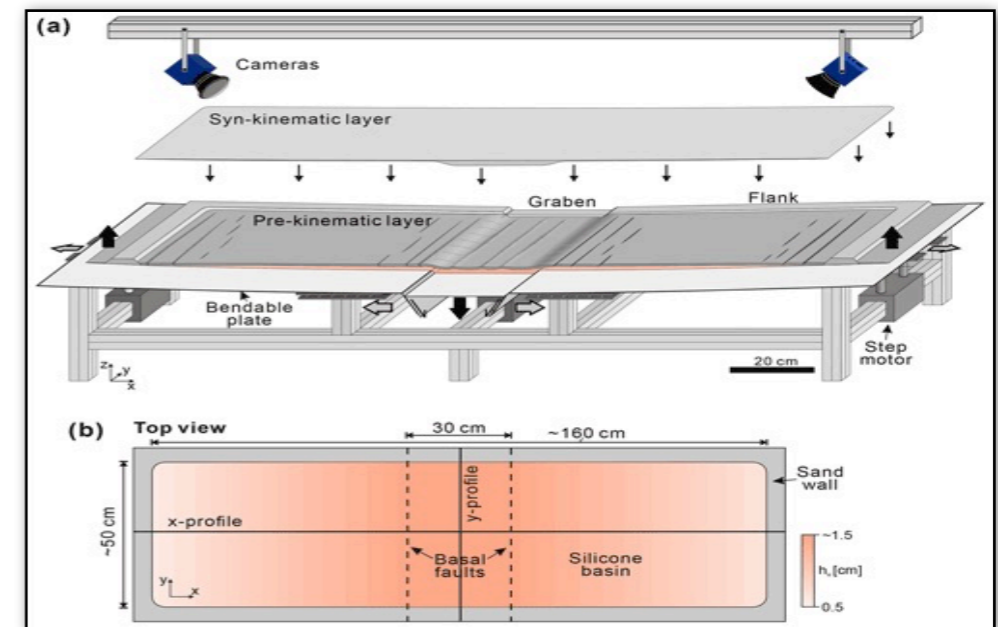

FACULTY OF SCIENCE
Charles University



CZECH

Charles University
Laboratory of
Experimental Tectonics

Jaroslava HAJNA

+ ?



TYPICAL WORKFLOW FOR ANALOG MODELLING INVESTIGATIONS

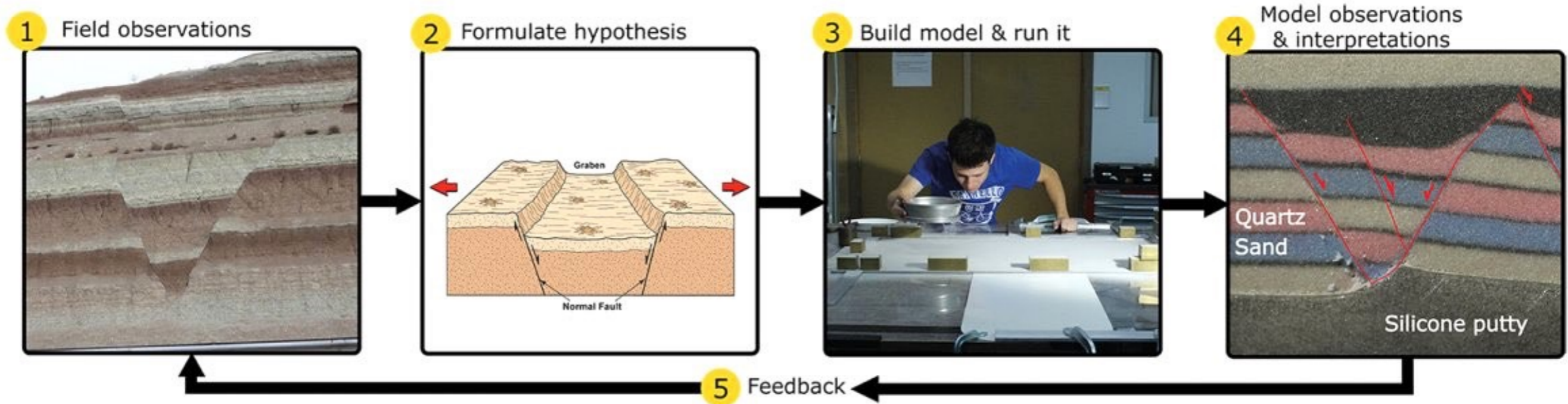

(After TecLab, Utrecht)

REQUIREMENTS

- ➔ **GEOLOGICAL AND GEOPHYSICAL CONSTRAINTS ON THE STUDIED NATURAL CASE**
- ➔ **RELIABLE MODEL SCALING INTEGRATING THE CONSIDERED TIME AND SPACE SCALES**
- ➔ **APPROPRIATE ANALOGUE MATERIALS AND BOUNDARY CONDITIONS**
- ➔ **ACCURATE AND MULTI-METHODS MONITORING TO QUANTIFY MODEL EVOLUTION**

GEOLOGICAL AND GEOPHYSICAL CONSTRAINTS



Field-trip observations, measurements and sampling, ...

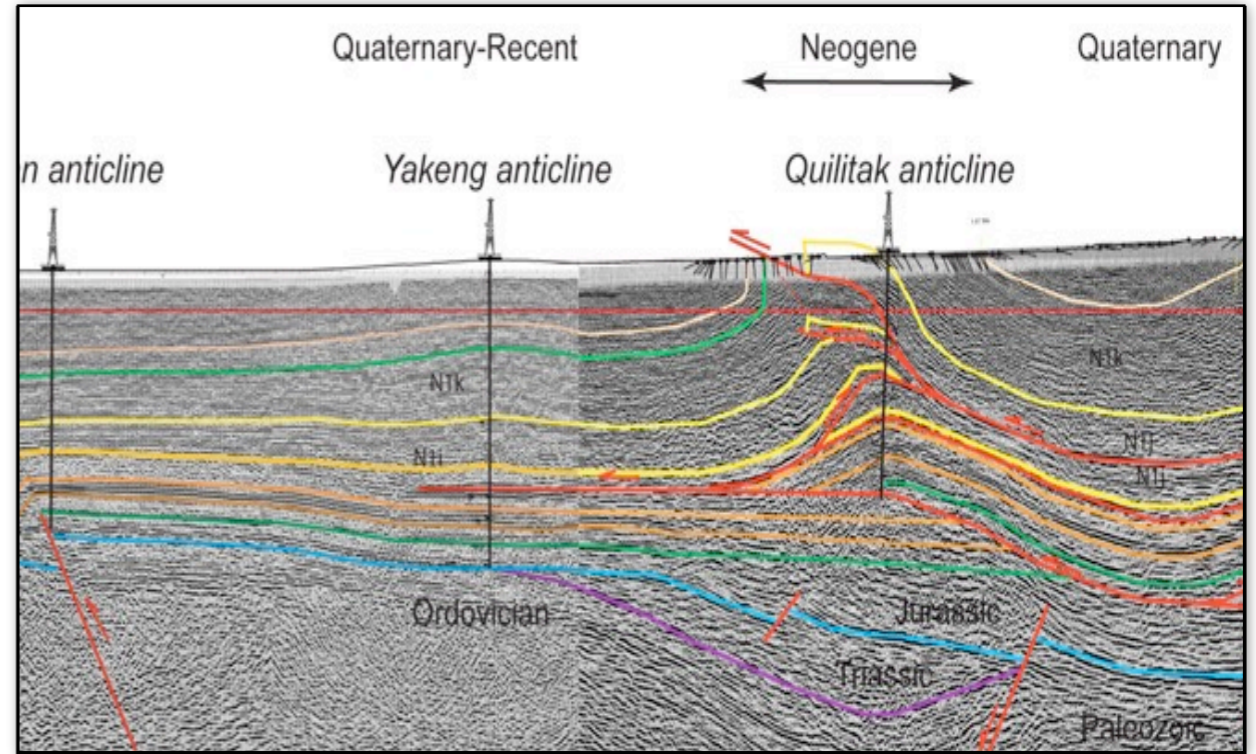
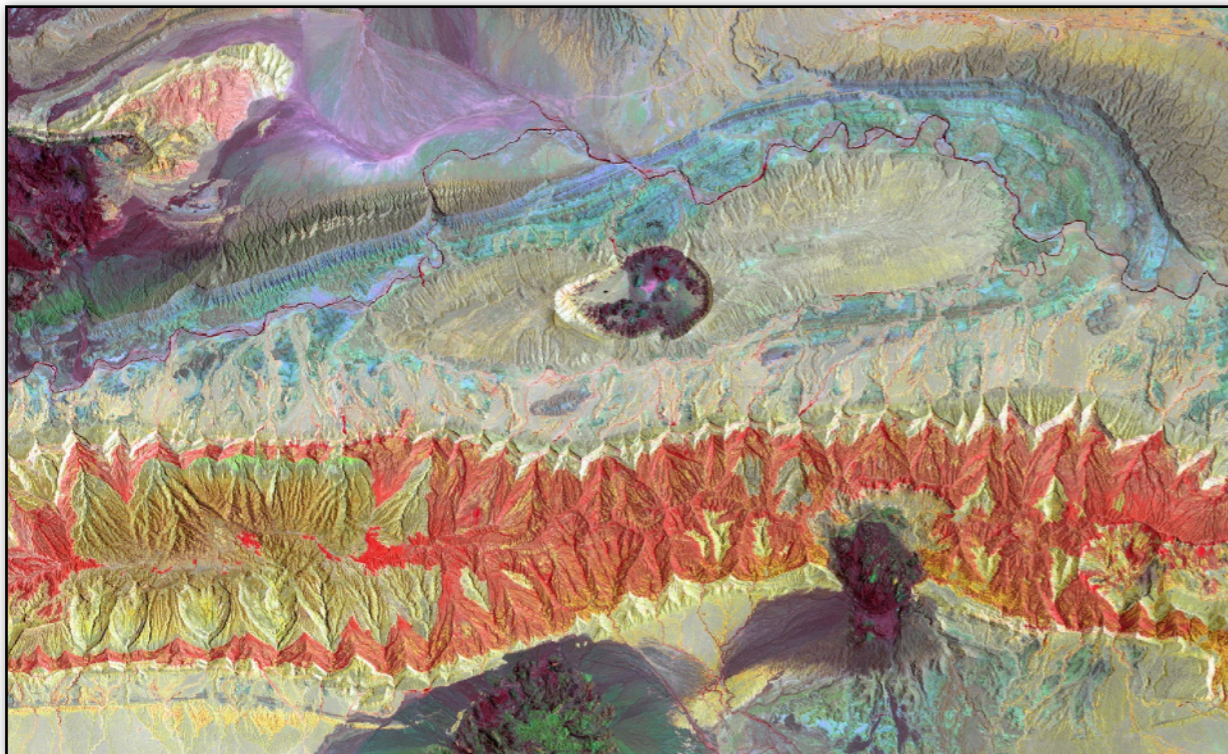

Geophysics data: geodesy, seismology, satellite -> acquisition, processing and analysis

USING SCALED ANALOGUE MATERIALS AND BOUNDARY CONDITIONS

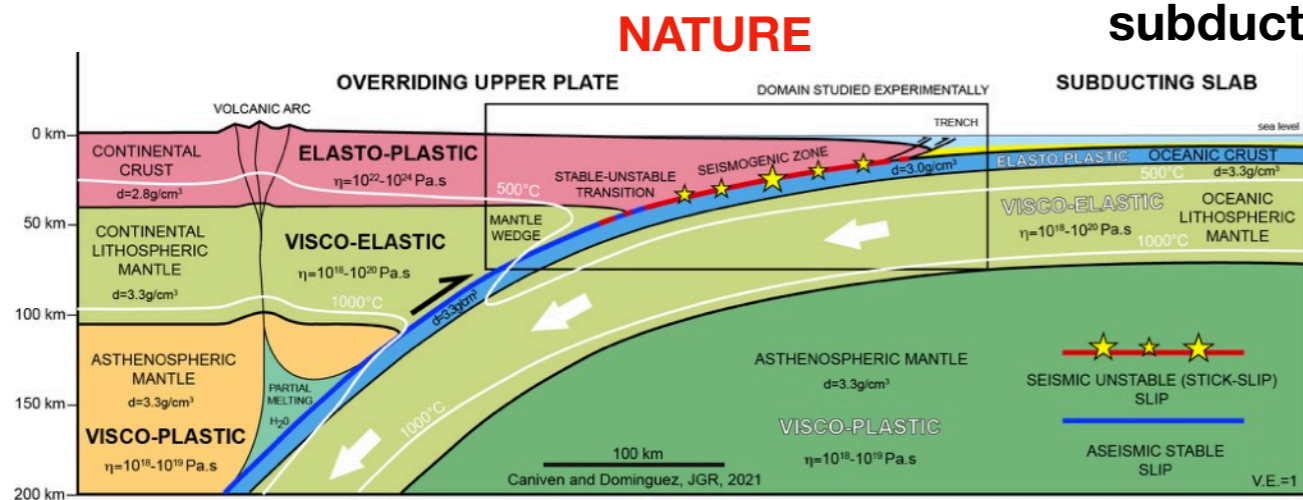

MODEL and EXPERIMENTAL Set-up

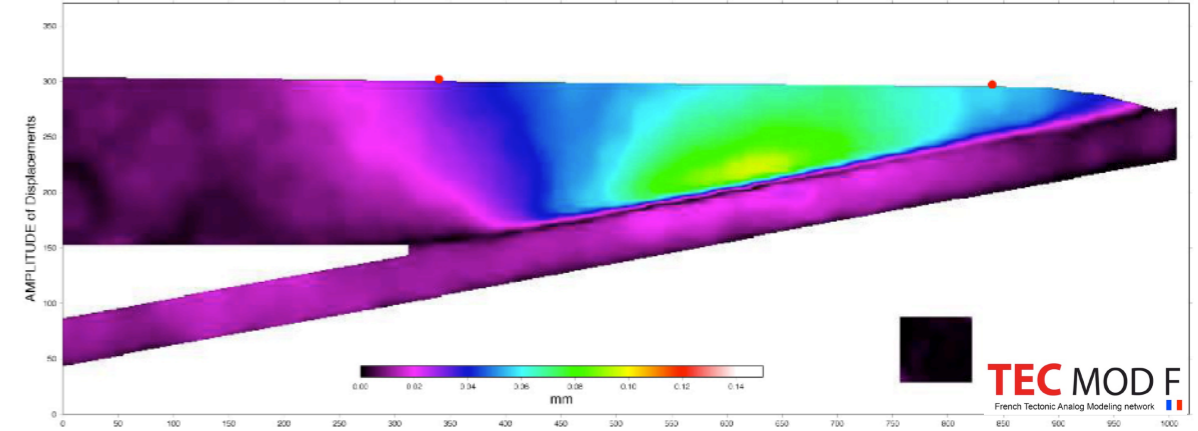
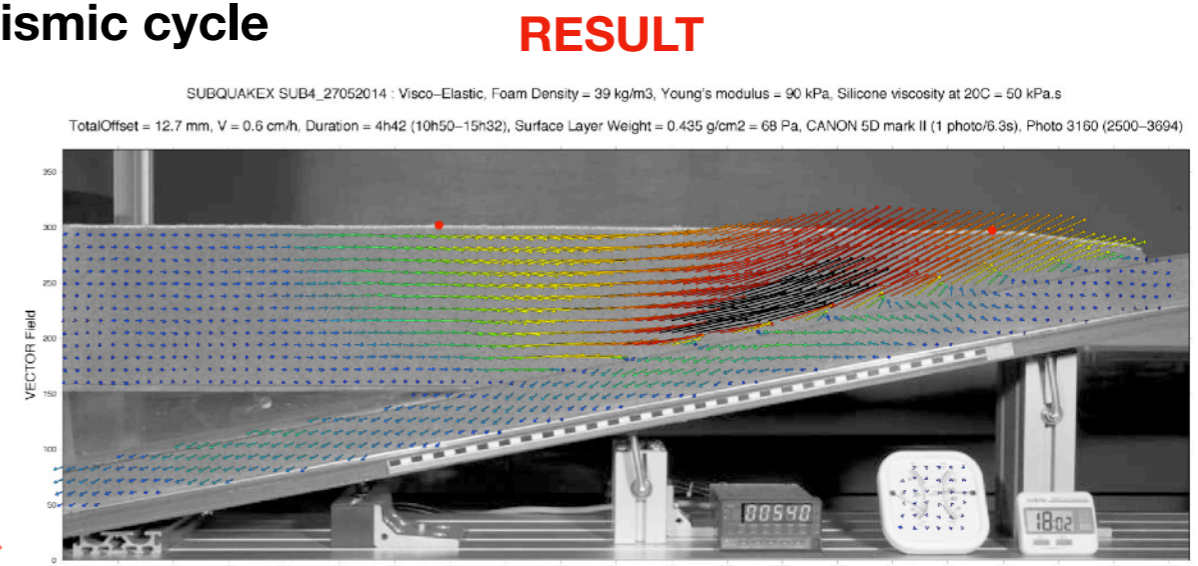
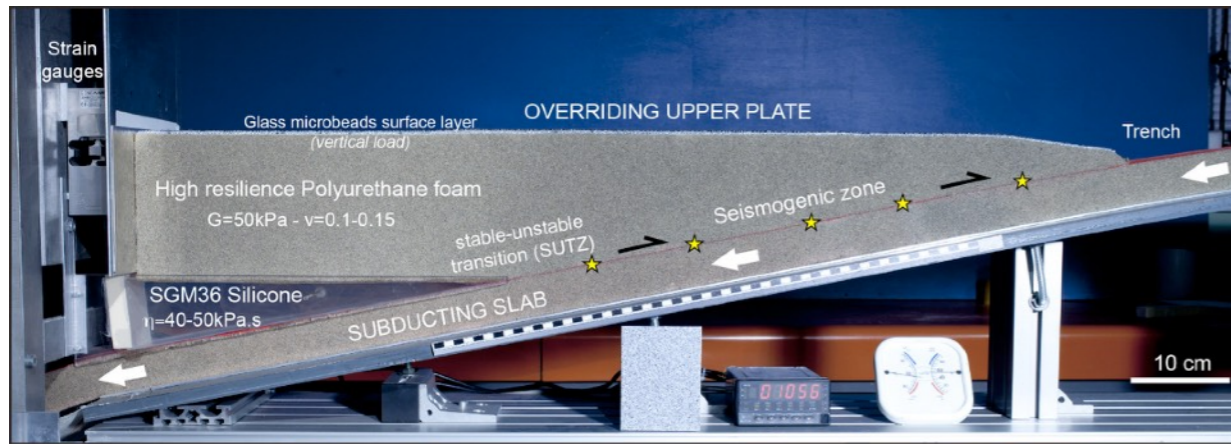

NATURE

TES Interactions

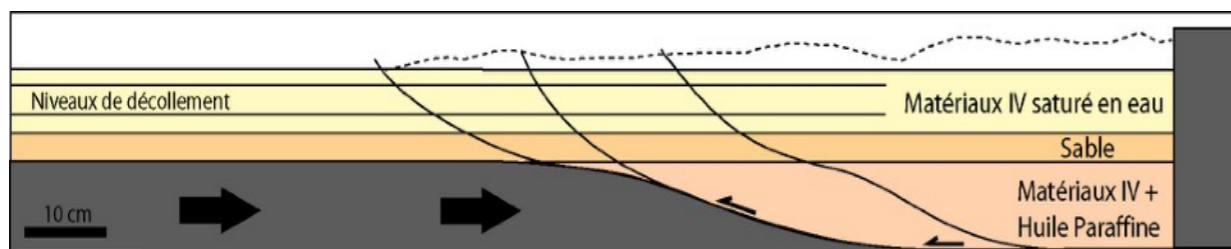
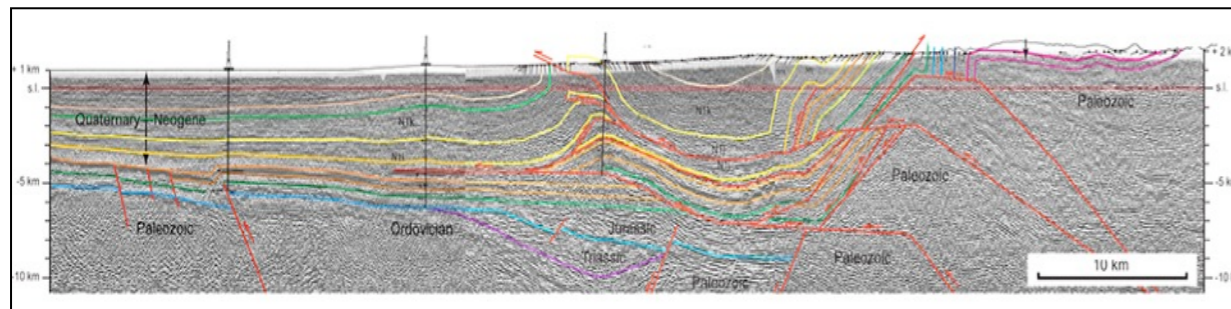

MODEL and EXPERIMENTAL Set-up

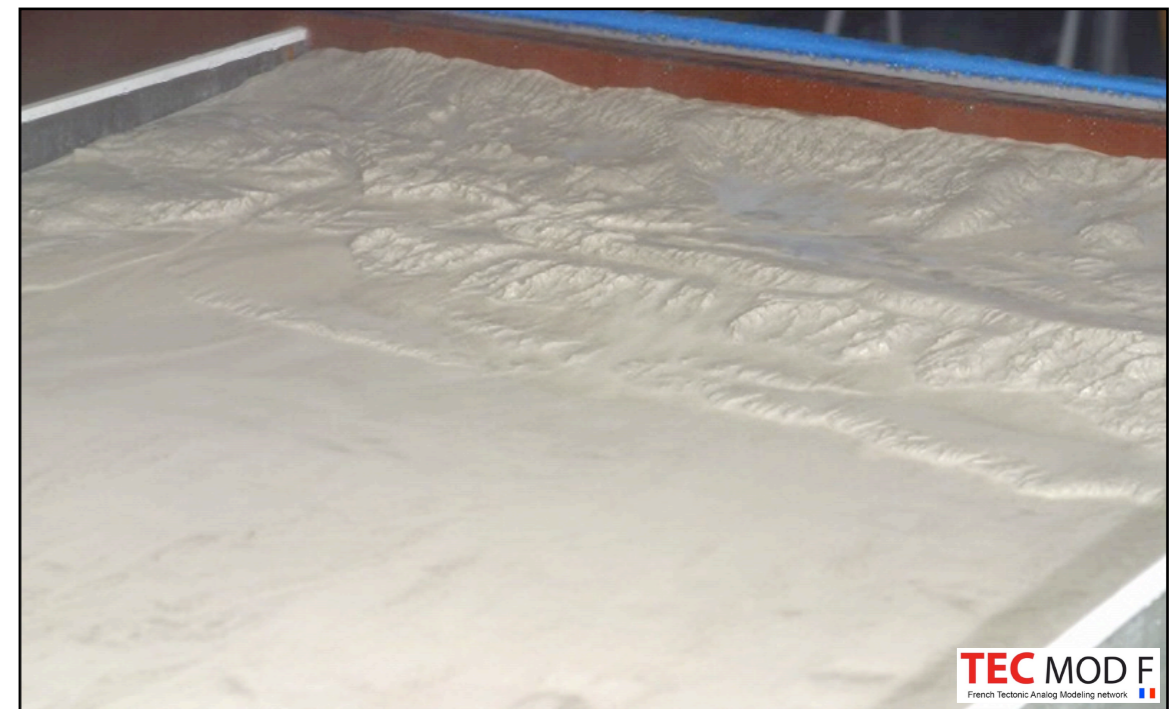

EXPERIMENTAL SET-UPS: Use of custom-made devices and High-Tech instruments

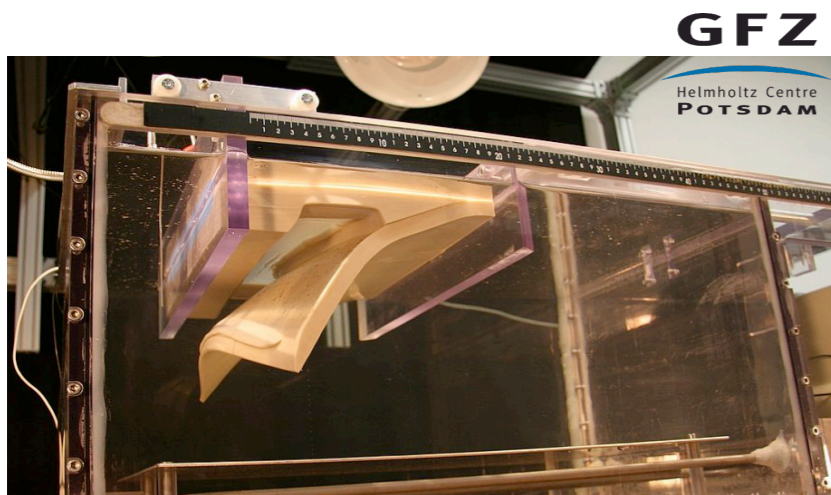

3D thermomechanical device

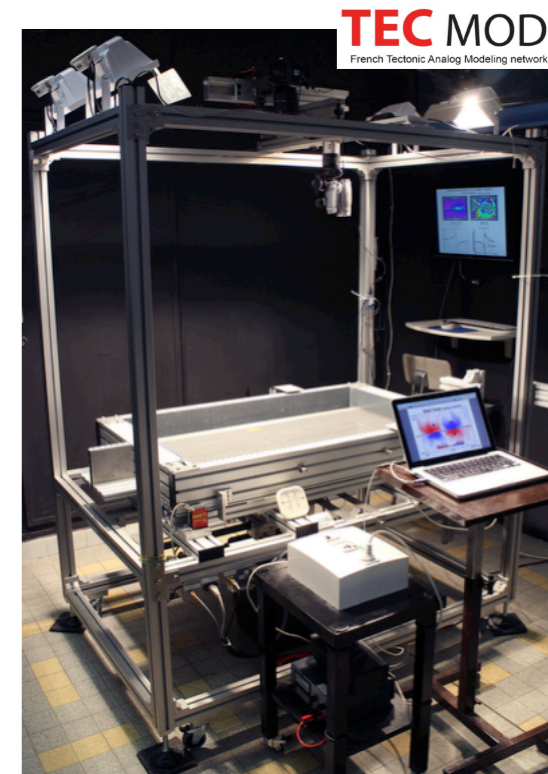
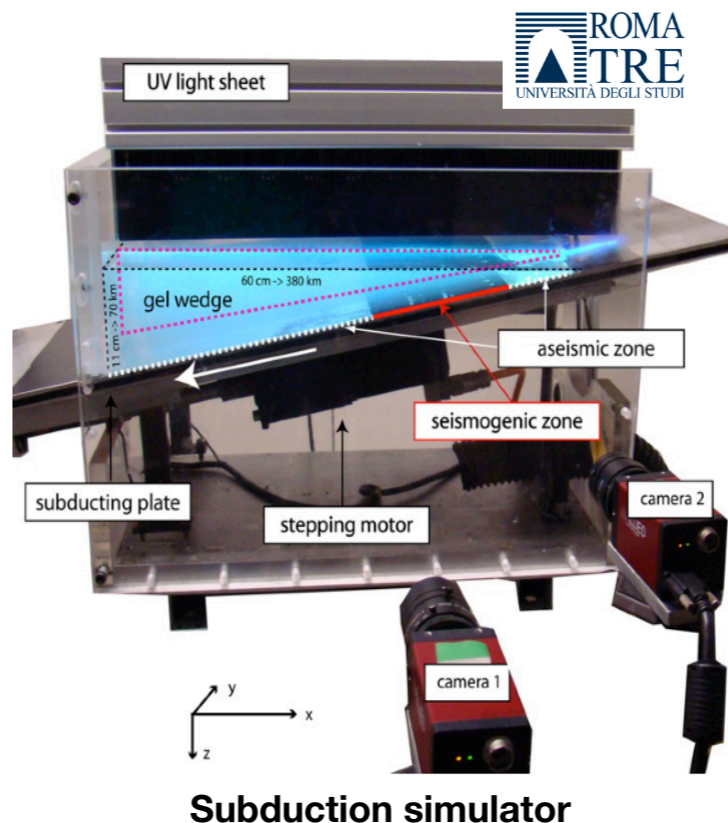

Strike-slip fault earthquake simulator



Shock-tube

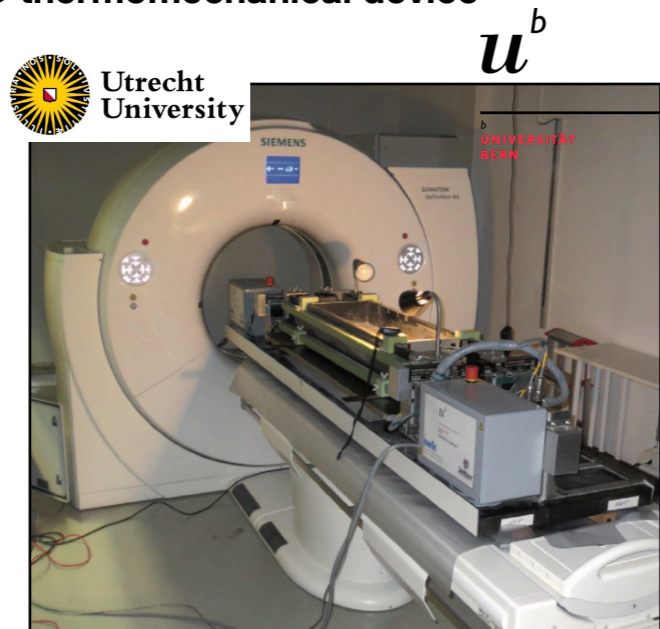

X-ray computed tomography

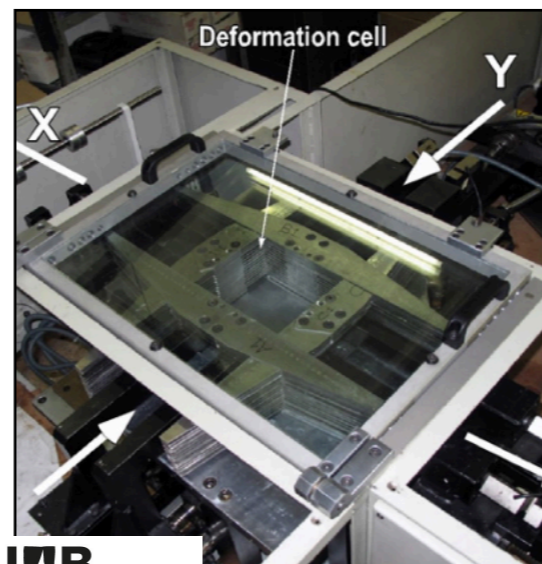

Shear cell device

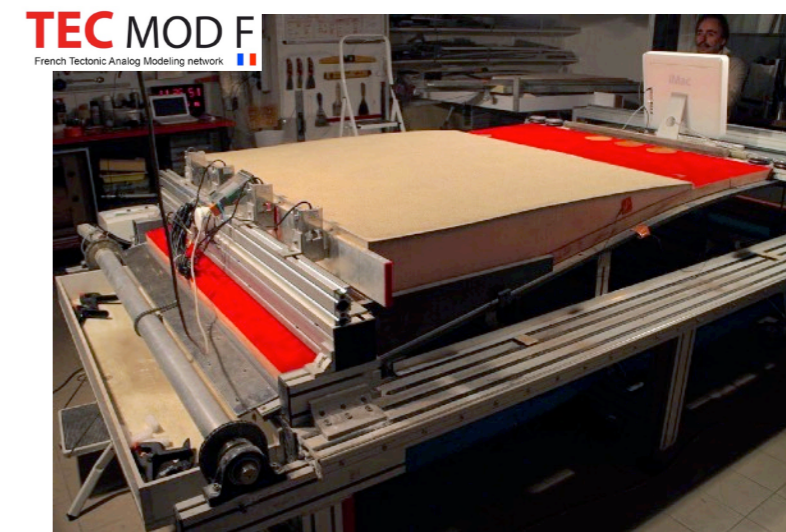

Subduction seismic cycle 3D simulator



Metronome: Very large river estuaries simulator



Subduction simulator tank

MODEL MONITORING AND ANALOG MATERIAL TESTING

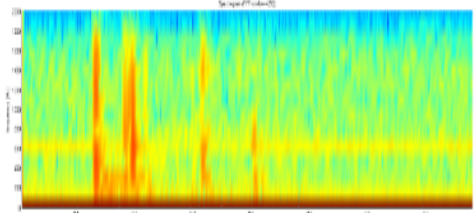
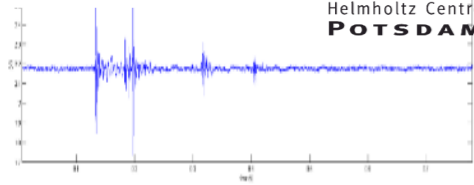
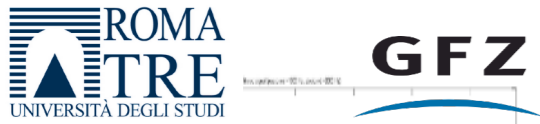

MEMS accelerometers



Centrifuge

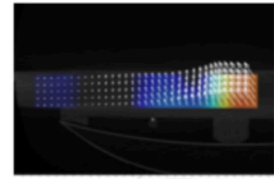
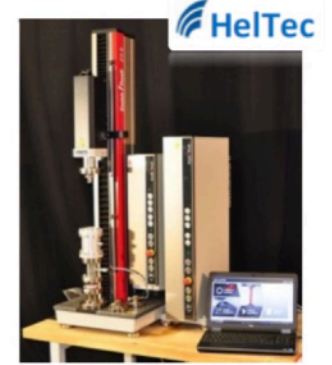
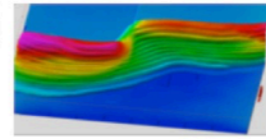

Image correlation



Axial testing



Vibrometer

Multilayer setup



CT scanning

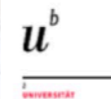
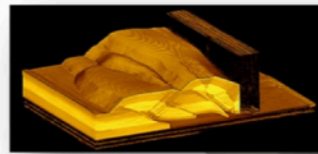

Rheometry



(Updated after Willingshofer et al., EGU2021)



High speed imaging

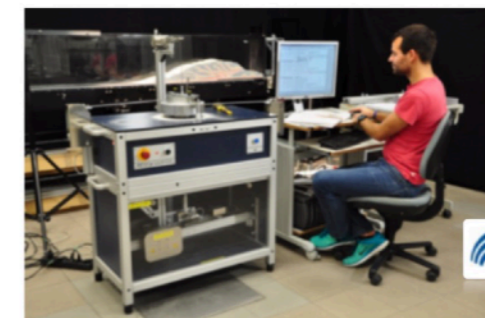

Ring-shear testing

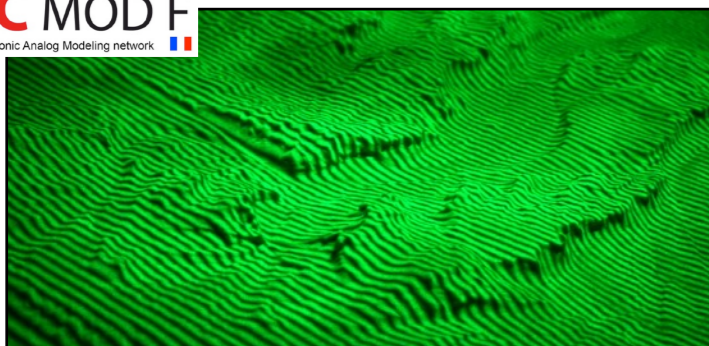

Laser Interferometer



Laser Scanner

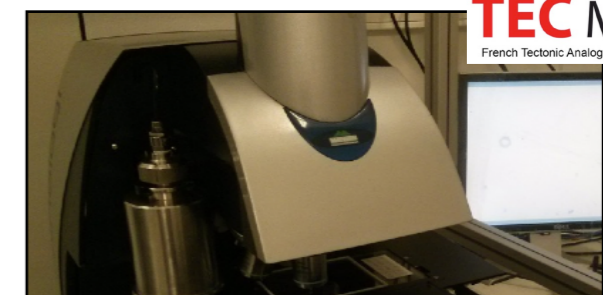

MorphologicG3 Granulometer



Use of highly technical monitoring and image processing methods : From qualitative to quantitative!

-> Use of numerous Commercial and Custom-made SOFTWARES

Digital image correlation (DIC) / particle image velocimetry (PIV)

MatPIV, MicMac, PIVlab, StrainMaster, TecPIV, Matlab, Envi-IDL, ...

Structure from motion (SfM) / 3D e-scan / Lidar

Apero, MicMac, Photoscan/MetaShape, OpenMVS, Remake, Pix4d, ...

Data viewer and processing / 3D geomodelling /

Labview, GeoSec, GeoTools, GOCAD, Move, Python, ArcInfo, Erdas, CloudCompare, ...

-> **INCREASED** use of joint approaches combining **ANALOG/NUMERICAL** Modelling

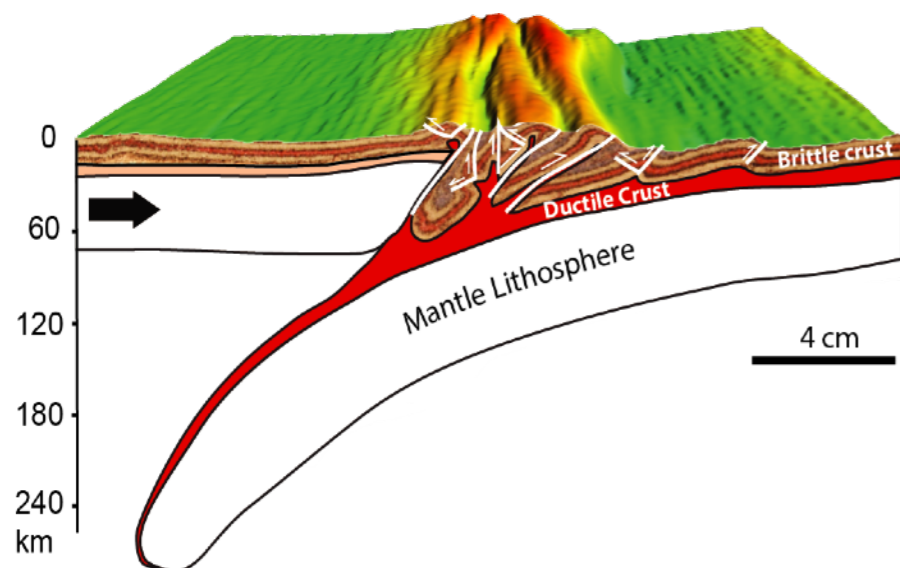

Numerical Experiments

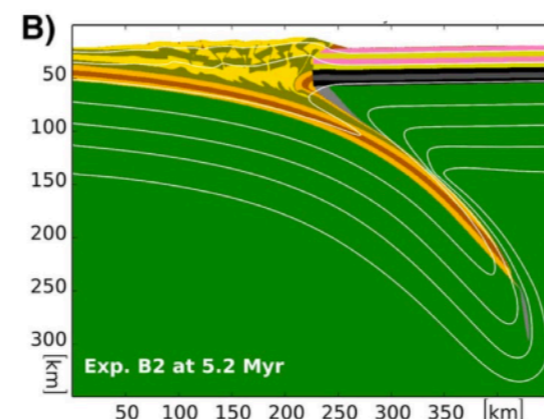
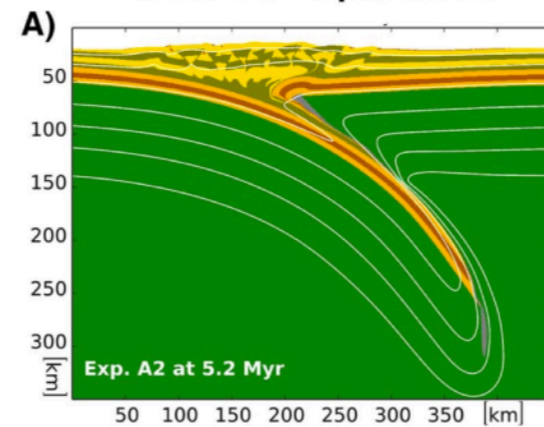

Analogue Experiments

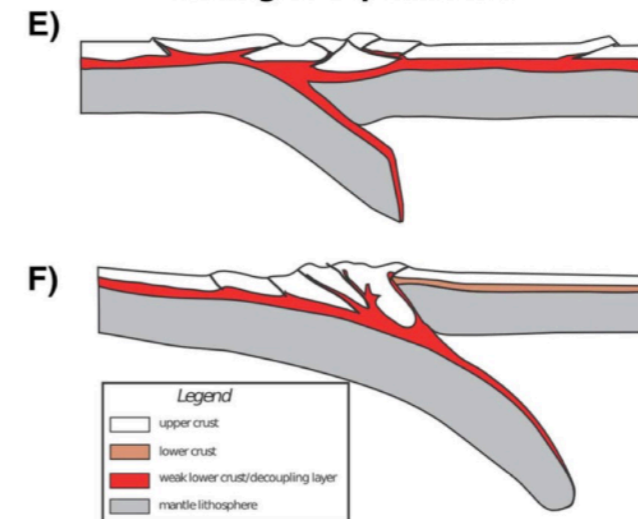

Natural Examples

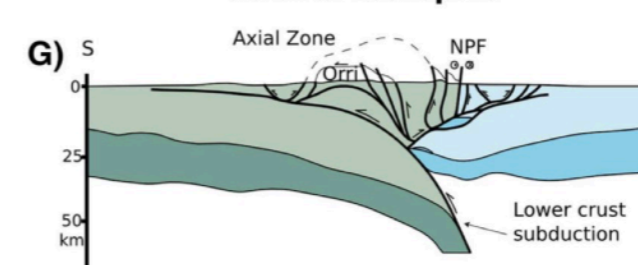

**TIME
SCALES**

INTEGRATING THE TIME AND SPACE SCALES

**SPATIAL
SCALES**

LONG

**1-100
of Myr**

**Mountain
building
Rifting**

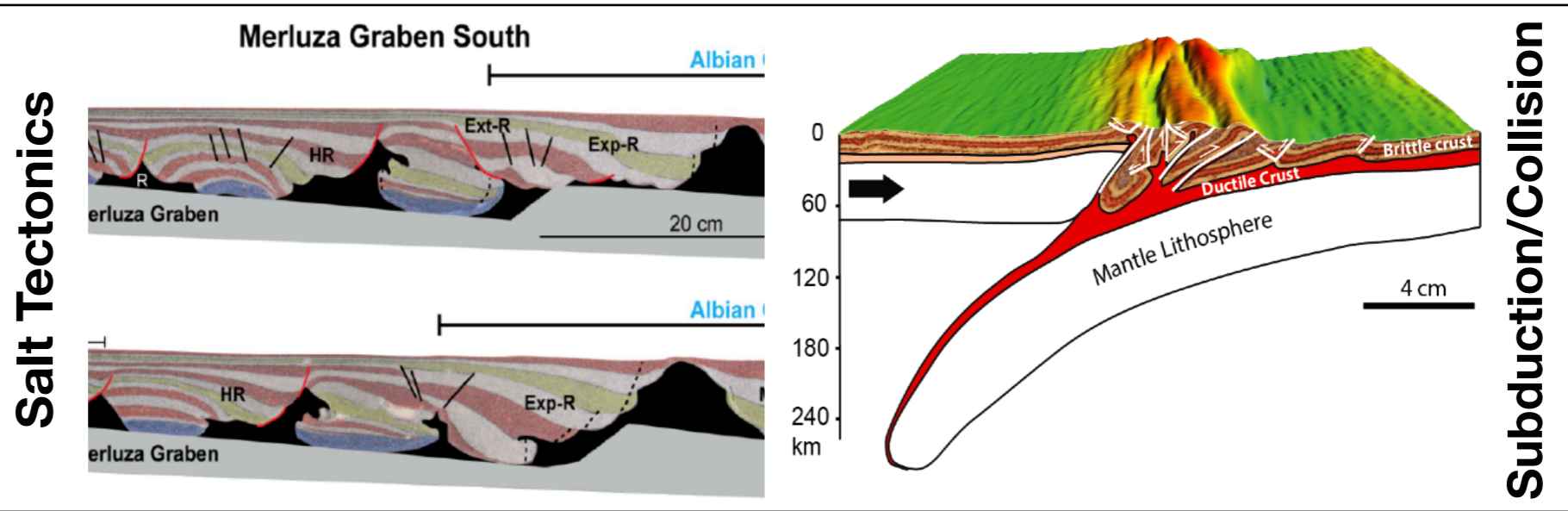

Subduction/Collision

**LARGE
10-100
of Km**

INTERMEDIATE

**1-100
of Kyr**

**Landform
and Relief
Evolution**



TES Couplings

**LARGE
to SMALL
<1-100
of Km**

SHORT

**1s-100
of yr**

**Earthquake
Landslide
Tsunami**

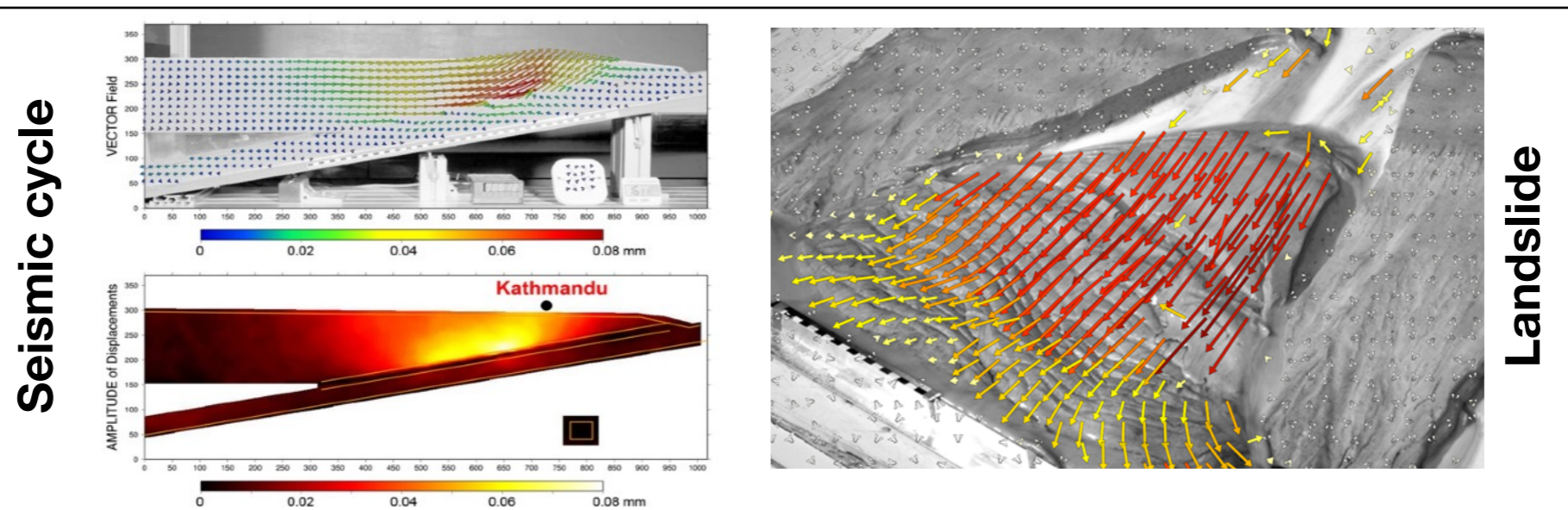

Landslide

**LARGE
to SMALL
<1-100
of Km**



DATA and TNA SERVICES



DATA REPOSITORIES used by the Analog Modeling

GFZ (Potsdam) DATA REPOSITORY

Open in 2018. Contain > 65 Datasets

UU (Utrecht) DATA REPOSITORY

Will open in 2022?

The screenshot shows the GFZ Data Services interface. It includes a search bar, a spatial filter with a map, and a list of datasets. The search results show 59 datasets found for the query 'analog modelling'. The first dataset is 'Digital image correlation data from analogue modelling experiments addressing extension of weakened crust' by Osagiede, Edoseghe E., Rosenau, Matthias, Rudolf, Michael et al.

The screenshot shows the EPOS Multi-Scale Laboratories website. It displays search results for 'analog modelling', showing 18 datasets found. The results are categorized by labs (other-lab, Laboratory of Exper., Tectonic Modelling, HeITec, TectLab, TecMOD) and subdomains (analogue models). The first dataset is 'Supplement to: Rheological benchmark of silicone oils used for analog modelin...'.

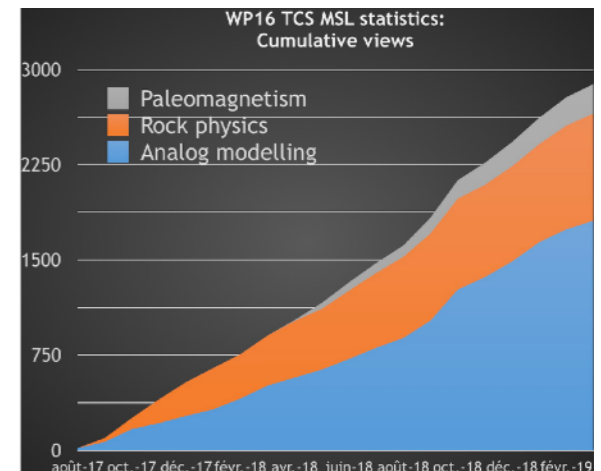
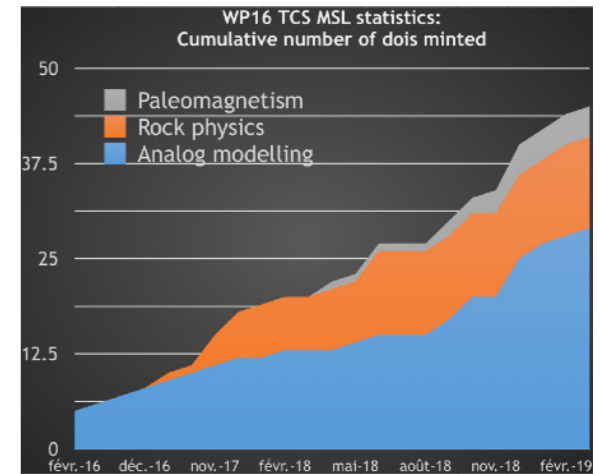

Active Participation to the **THREE TNA PILOT CALLS (2017, 2018, 2019)**

TNA-derived data gets published through the MSL data publication chain

OUTREACH ACTIVITIES

The EPOS-MSL Analog Modeling Community is maintained active through stimulating actions, among those:

-> On-line annual Community Meeting, Monthly Seminars, SE-special volume, Book with Cambridge ed.

+ Introducing Experimental tectonics in our classes and in outreach activities.

The EPOS-MSL AMC is also actively participating to the main international conferences



and plays a key role in organizing the bi-annual GEOMOD workshops

