



**HAL**  
open science

# What brings diamond compared to wide bandgap materials in power semiconductor devices?

Nicolas C. Rouger

► **To cite this version:**

Nicolas C. Rouger. What brings diamond compared to wide bandgap materials in power semiconductor devices?. 33rd International Conference on Diamond and Carbon Materials, Elsevier, Sep 2023, Mallorca (Spain), Spain. hal-04221279

**HAL Id: hal-04221279**

**<https://hal.science/hal-04221279>**

Submitted on 28 Sep 2023

**HAL** is a multi-disciplinary open access archive for the deposit and dissemination of scientific research documents, whether they are published or not. The documents may come from teaching and research institutions in France or abroad, or from public or private research centers.

L'archive ouverte pluridisciplinaire **HAL**, est destinée au dépôt et à la diffusion de documents scientifiques de niveau recherche, publiés ou non, émanant des établissements d'enseignement et de recherche français ou étrangers, des laboratoires publics ou privés.



Distributed under a Creative Commons Attribution - ShareAlike 4.0 International License

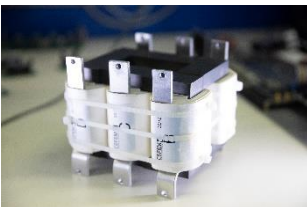
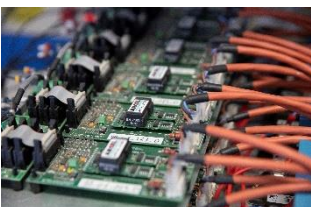
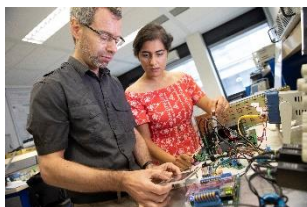

# What brings diamond compared to wide bandgap materials in power semiconductor devices?

*Session 4A: Diamond Power Devices I*

*\*Invited speaker*

*Sept 11<sup>th</sup> 2023*

Nicolas ROUGER, CNRS Research scientist

[Nicolas.rouger@laplace.univ-tlse.fr](mailto:Nicolas.rouger@laplace.univ-tlse.fr)



# Outline

## 1. Power semiconductor devices

- A. Specificities and benchmarking
- B. Impact of WBG power devices vs. Silicon

## 2. Diamond for power electronics

- A. Unique properties of diamond
- B. Benefits & benchmark of diamond

## 3. What's next?



This project has received funding from the Clean Sky 2 Joint Undertaking (JU) under grant agreement No 101007868. The JU receives support from the European Union's Horizon 2020 research and innovation program and the Clean Sky 2 JU members other than the Union.





Part 1

# Power semiconductor devices

N. Rouger

# Power electronics

## e.g. Half bridge / Buck Converter (DC/DC)

- Target 100 % efficiency
- Constraints on weight (volume), safety & reliability, cost, standards, adaptability to operating conditions, ...

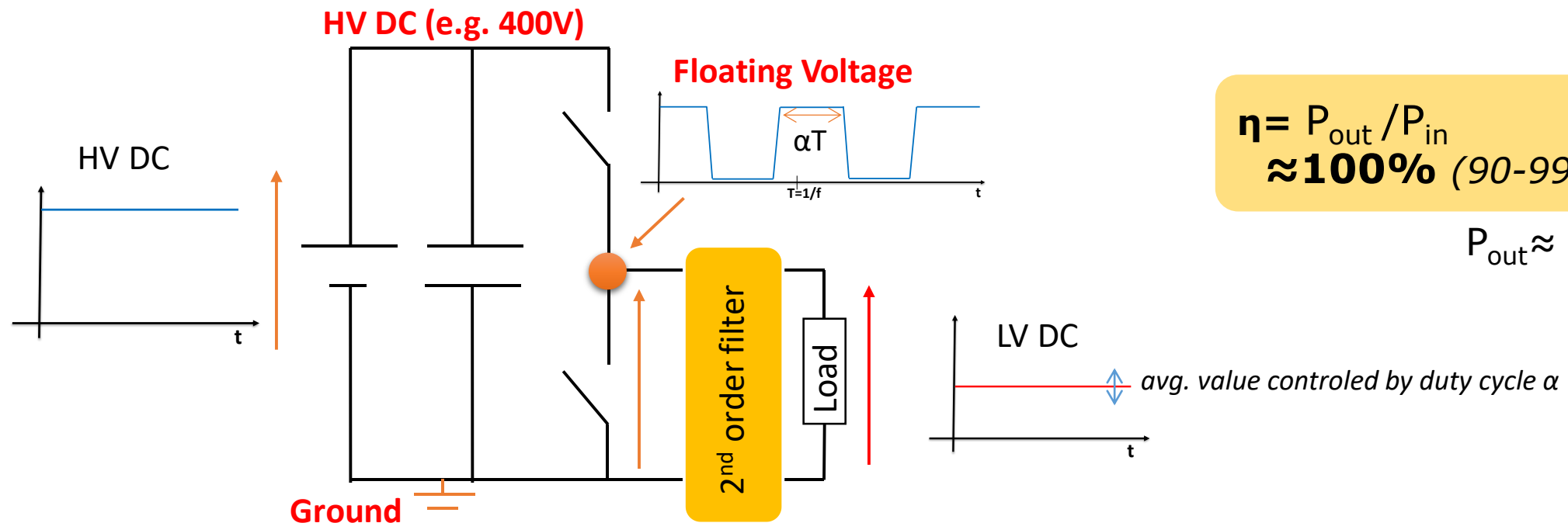

$$\eta = P_{out} / P_{in} \approx 100\% \text{ (90-99\%)}$$

$$P_{out} \approx P_{in}$$

# Power semiconductor devices

How to compare / Benchmark?

e.g. Si vs. SiC (WBG)

Same  $V_{on}$  @  $I_{on}$   $\longrightarrow$  Same conduction losses  
Same Breakdown Voltage  
Same  $T_j$

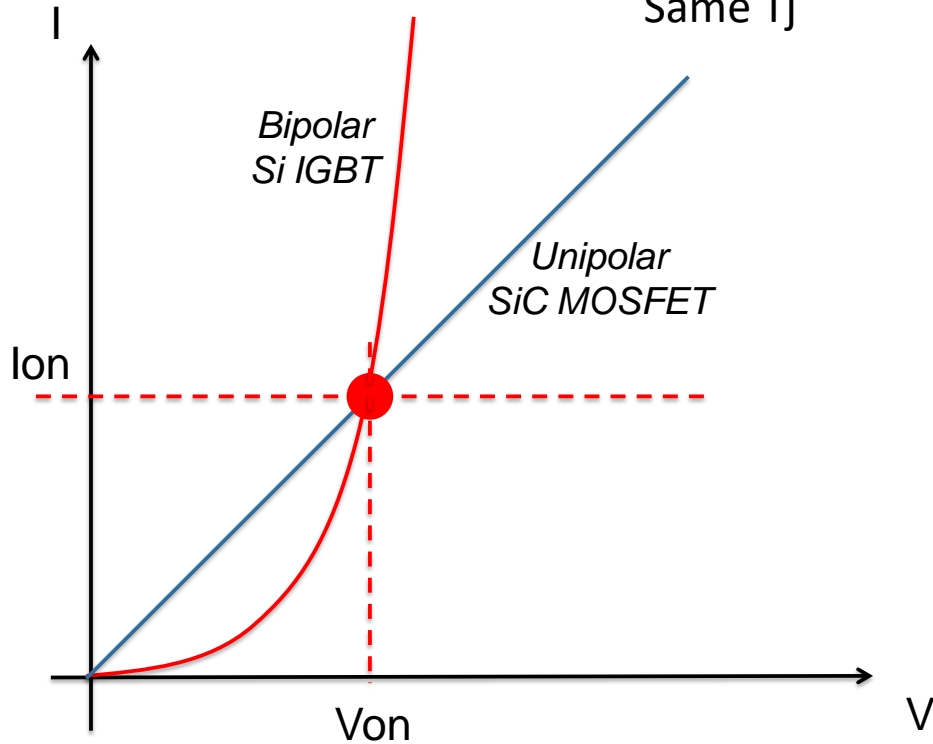

***What are the benefits of (U)WBG vs. Si?***

# Power semiconductor devices

## How to compare / Benchmark?

e.g. Carrier Lifetime Control and optimal area

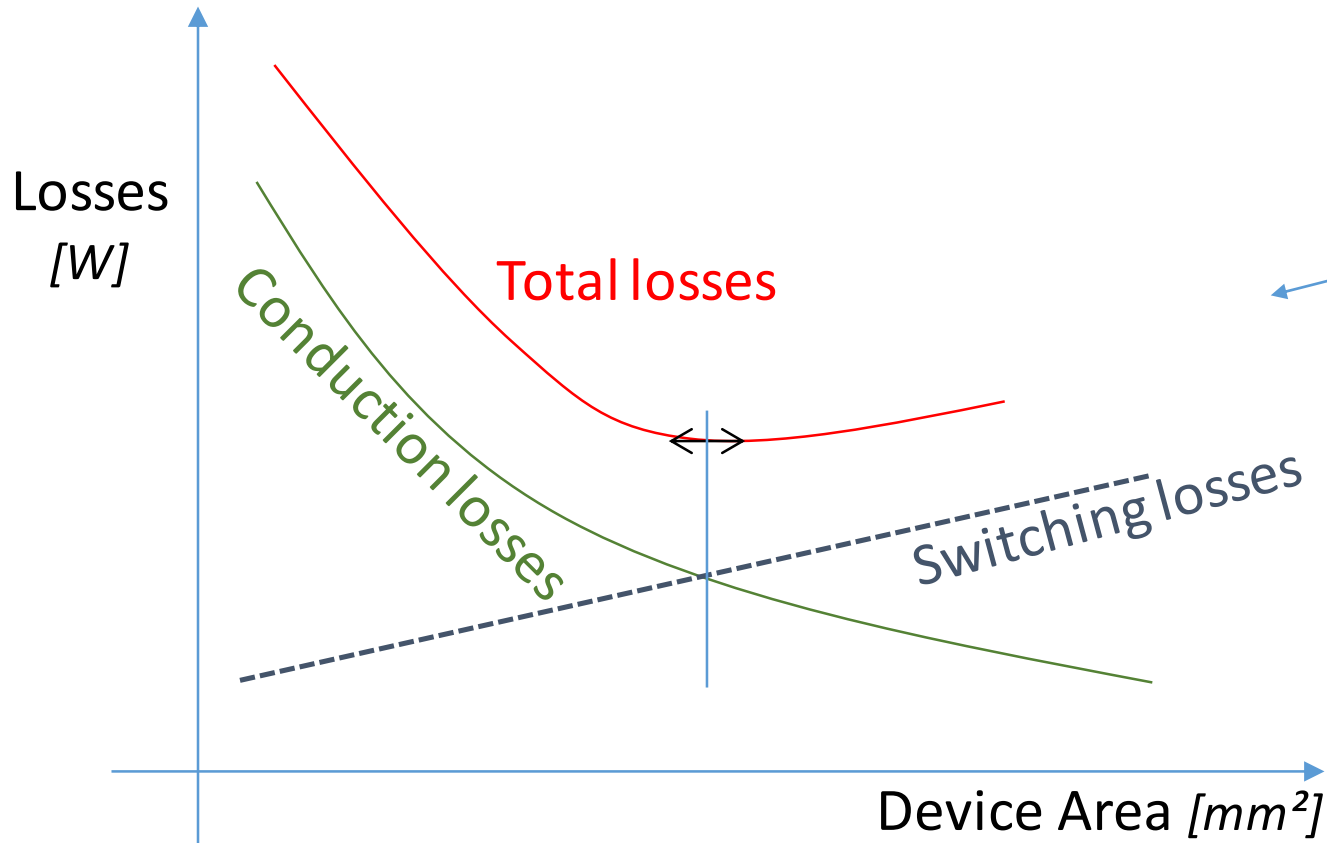

**Same specifications**  
**Same technology**  
**Same T<sub>j</sub>**  
**Same Carrier Lifetime**



**Trade off and optimization!**  
**Multiple variables**





Part 2

# Diamond for power electronics

N. Rouger



# Benchmark: Diamond

## Critical Electric Field of Diamond?

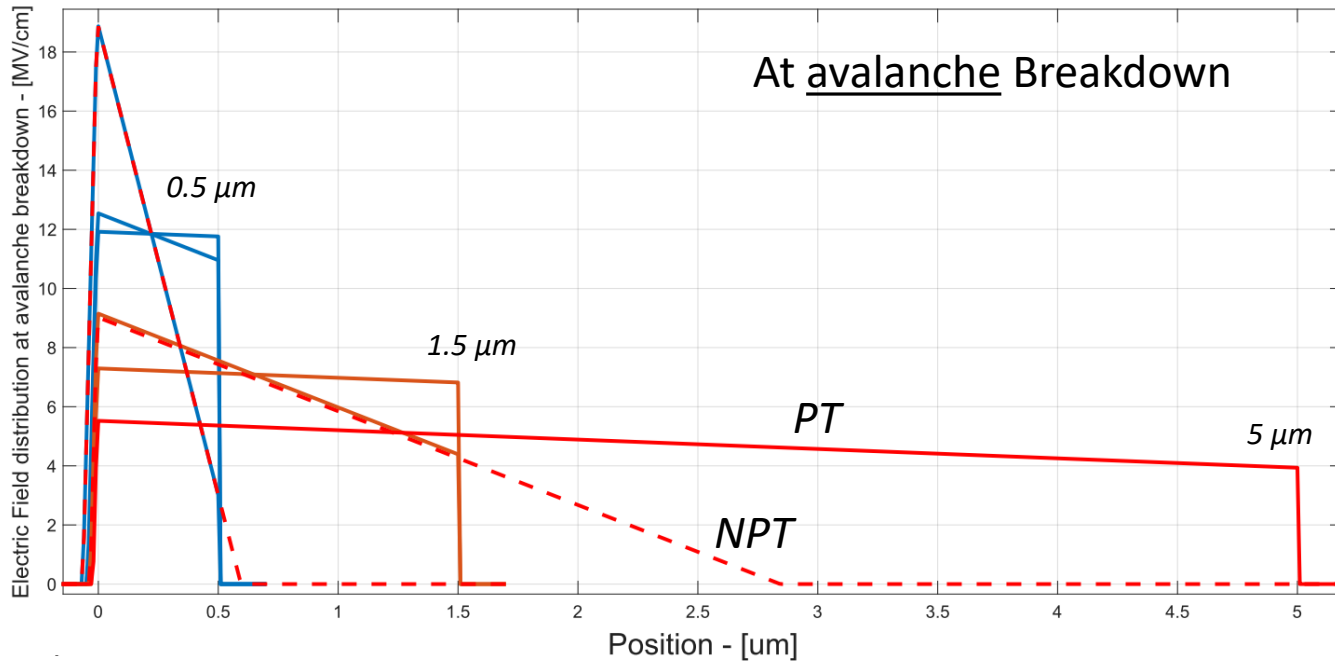

$$\alpha_p = a_p \exp\left(\frac{-b_p}{|E|}\right), \alpha_n = a_n \exp\left(\frac{-b_n}{|E|}\right)$$

[A. Hiraiwa, H. Kawarada, 2013, JAP 114 034506]

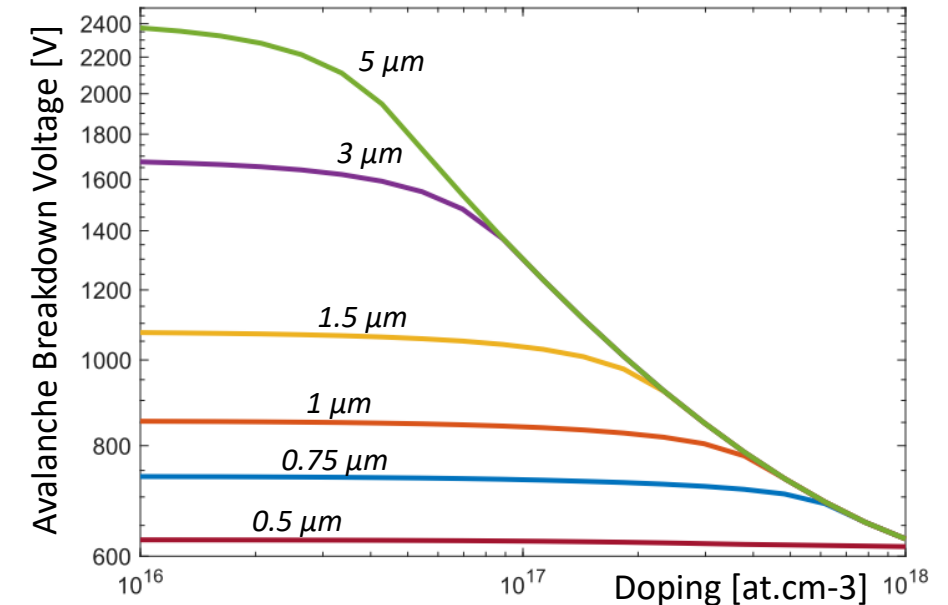
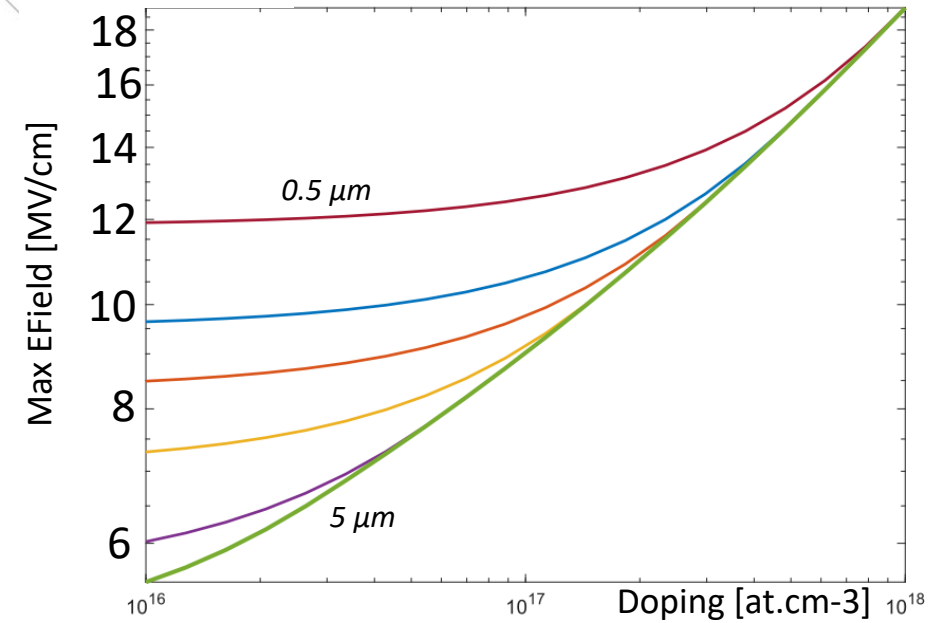

# Benchmark: Diamond

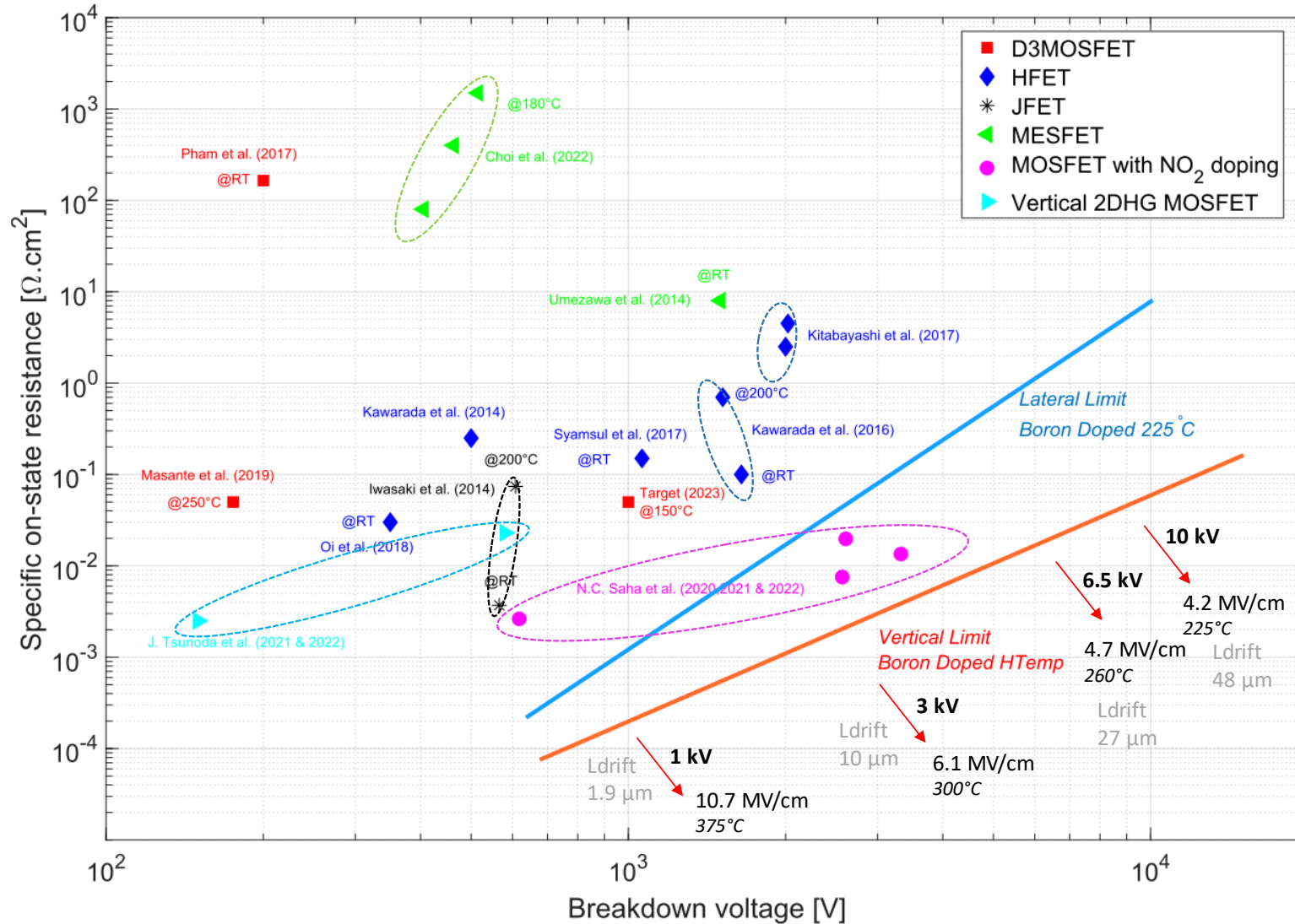

Models for diamond limits:

1D Avalanche Breakdown & NPT

Inc. Ionization diamond  
[B] Doped diamond

Drift region only

...

[M. Couret et al, 2023, Diamond & Related Materials Vol 135, 109 827, 10.1016/j.diamond.2023.109827]



# Benchmark: Diamond vs. SiC

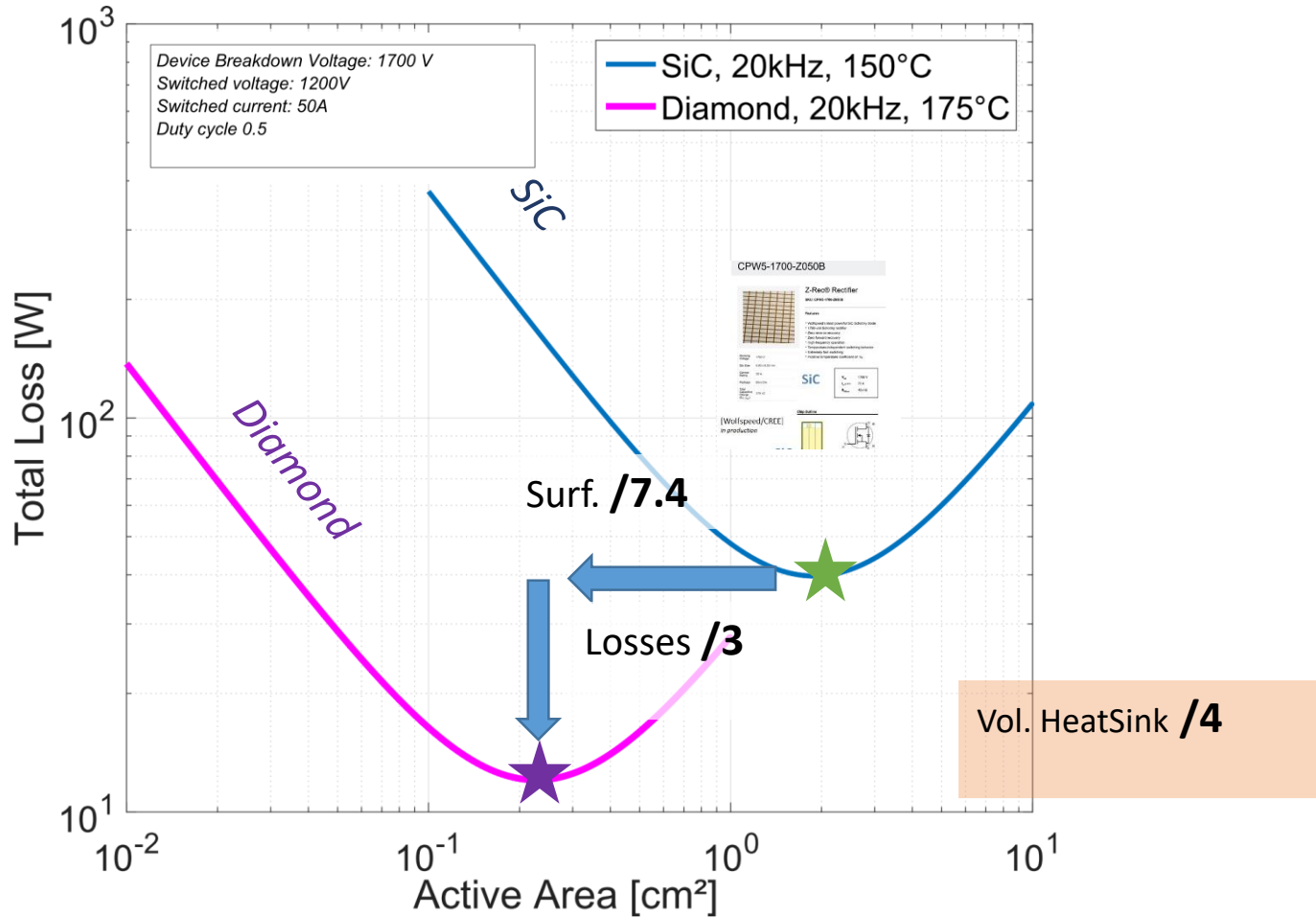

[N Donato, N. Rouger et al 2020 J. Phys. D: Appl. Phys. 53 093001]

1D Avalanche Breakdown & NPT

Inc. Ionization diamond  
[B] Doped diamond

Non linear Coss for Eon switching energy

$E_{off}=0$

Vertical architecture

Drift region only

300K Ambient w/ natural convection

...

**Fair but still to be discussed**



# Benchmark: Diamond vs. SiC

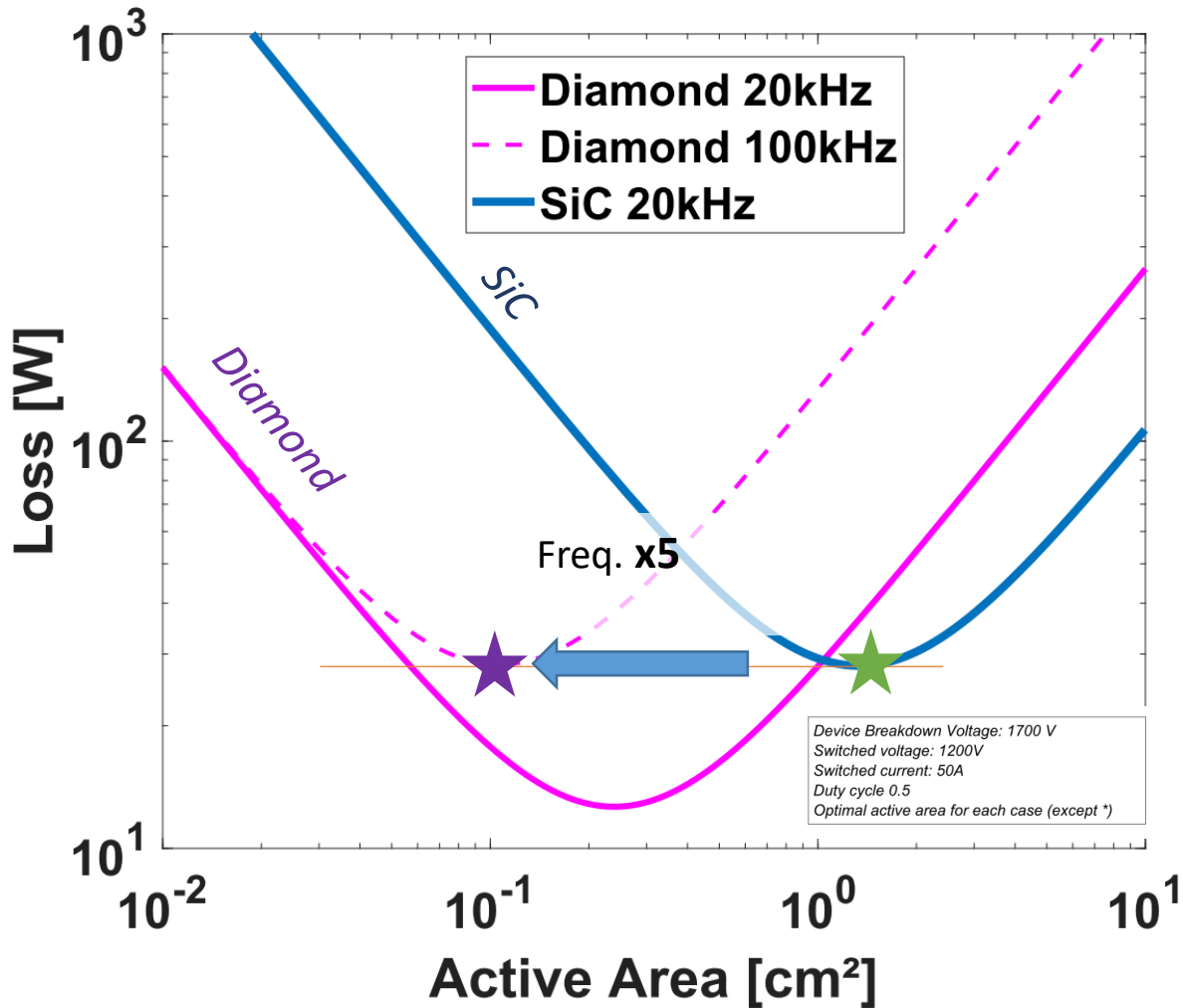

[N Donato, N. Rouger et al 2020 J. Phys. D: Appl. Phys. 53 093001]

Other design:  
 If  $P_{Diam.} = P_{SiC}$  then  
**f x5** => Passive Volume /3 to 5  
 HeatSink Volume **-16% to -30%**



  
 (Losses / Area) x 10!



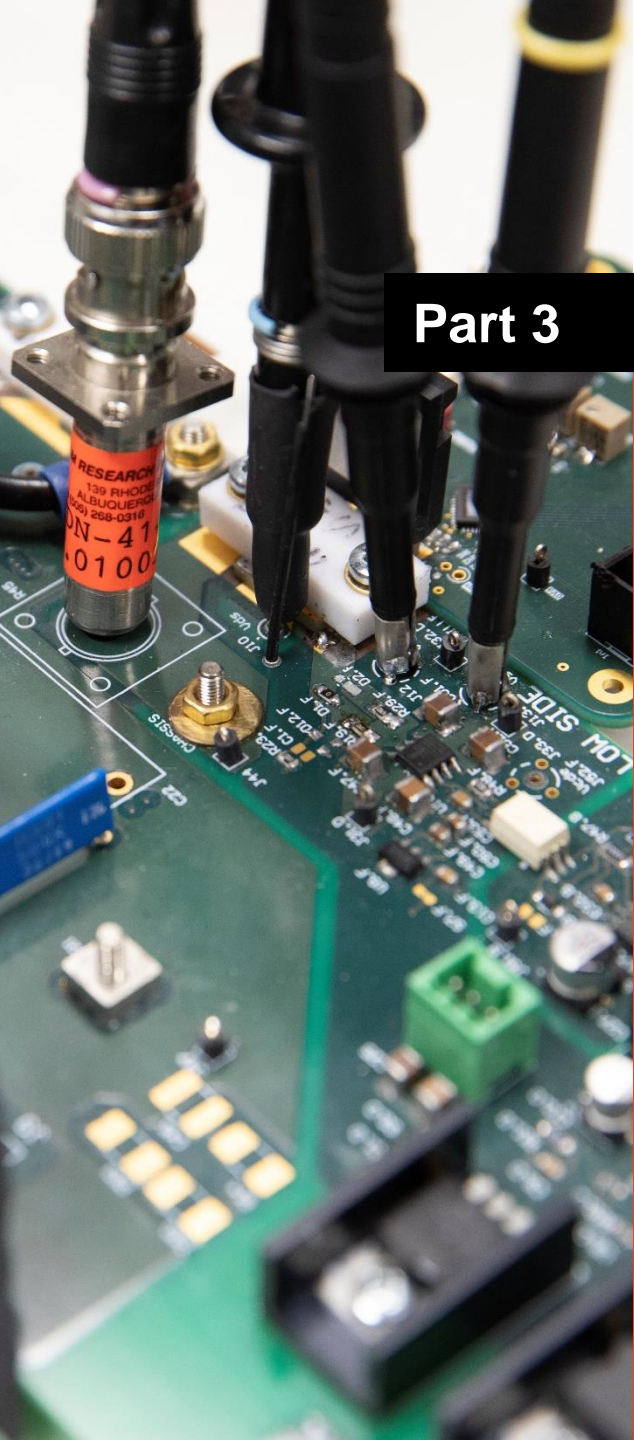

## Part 3

# What's next?

N. Rouger

# Improved FOM *Lateral D3MOSFET* O-term

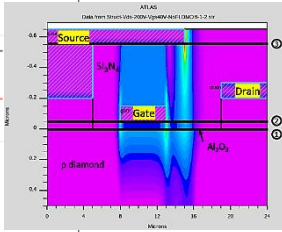
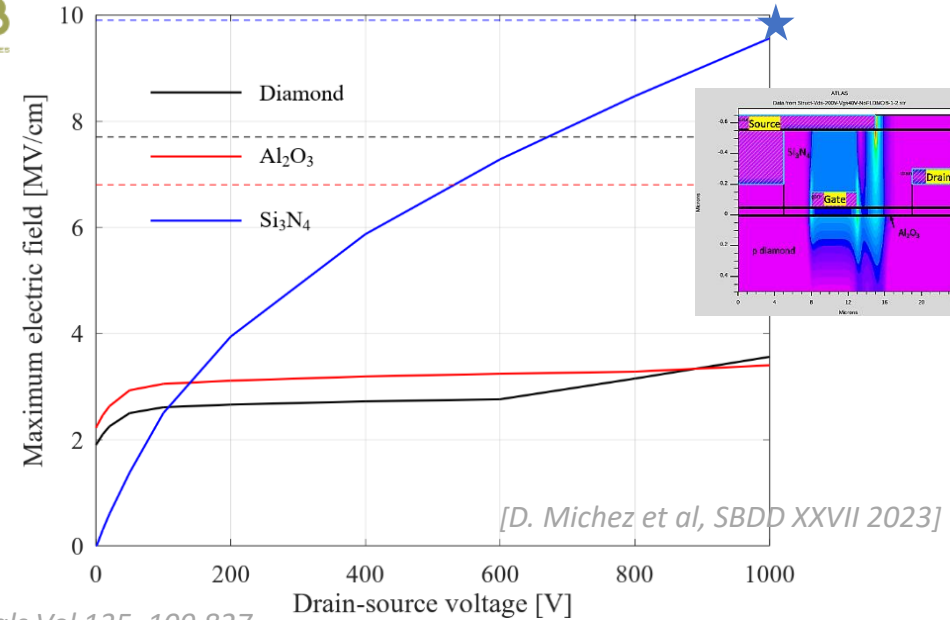
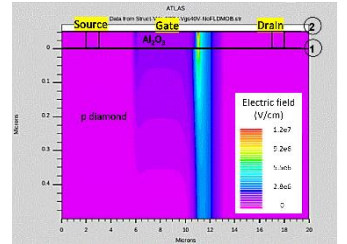
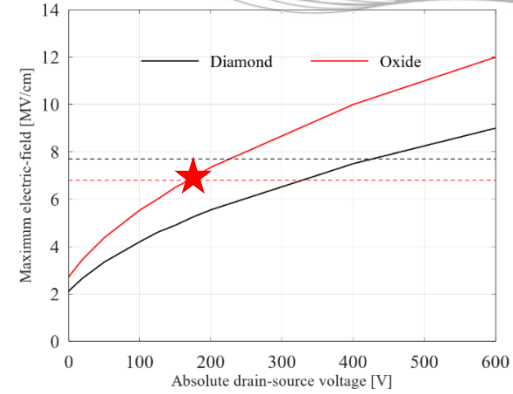
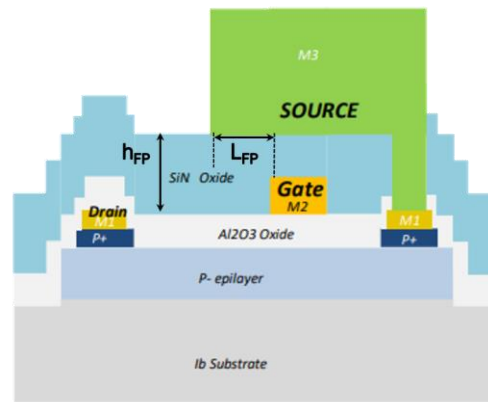
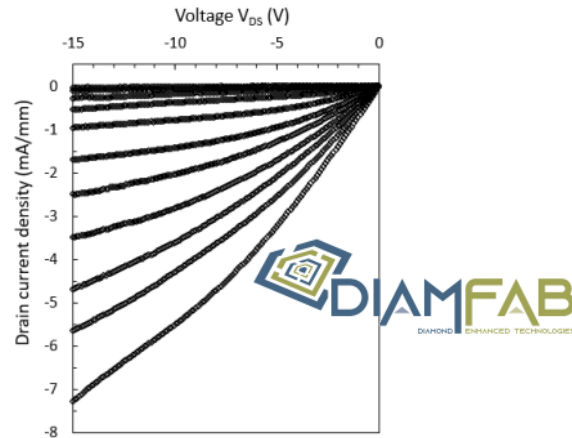
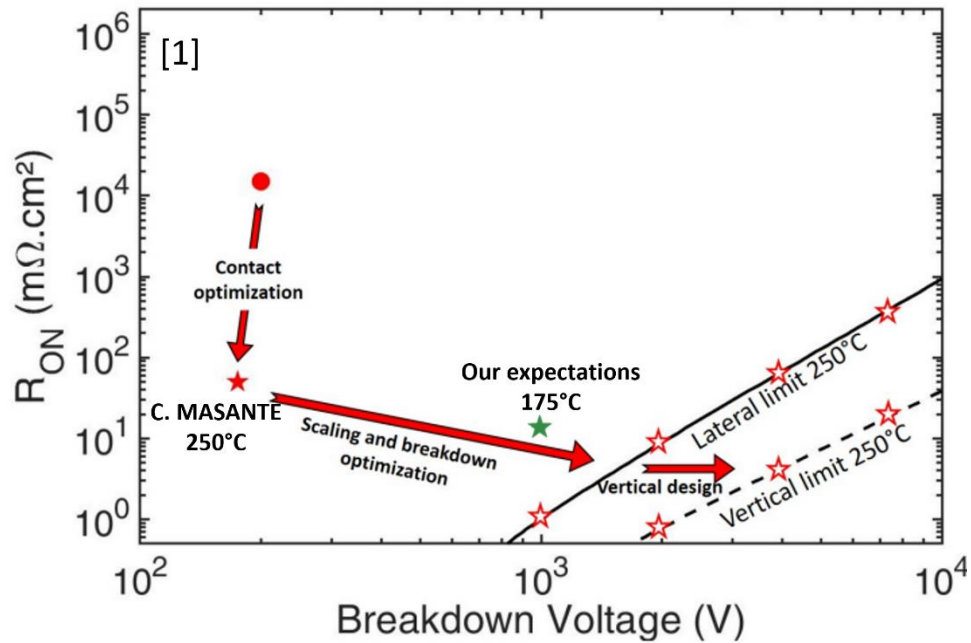

[M. Couret et al, 2023, Diamond & Related Materials Vol 135, 109 827, 10.1016/j.diamond.2023.109827]

[D. Michez et al, SBDD XXVII 2023]



# Conclusion

## Benefits of Diamond e.g. vs. SiC

- **7 times smaller** die, with **3 times less total losses**
- **4 times smaller heatsink** or **5 times higher switching frequency**



## Challenges

- **Ecrit** for lightly doped and thick diamond?
- How to reach highest 1D **BV** with actual **3D** devices?
- **Large area** diamond devices with good FOM
- High quality & conductive substrate for **vertical** devices?
- **Switching losses** of diamond devices are unknown
- **Power loss density** P/S is expected to increase





# Acknowledgements

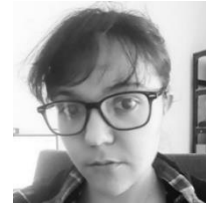

*Dr. M. Couret Dr. A. Castelan Dr. D. Risaletto Dr. E. Sarraute*



DCADE

2021-2023

This project has received funding from the Clean Sky 2 Joint Undertaking (JU) under grant agreement No 101007868. The JU receives support from the European Union's Horizon 2020 research and innovation program and the Clean Sky 2 JU members other than the Union.



*Dr. G. Longobardi Pr. F. Udrea*



*Dr. N. Donato*



*M. Kah*



*Dr. C. Masante Pr. J. Pernot*



*Dr. D. Eon*



*Pr. E. Gheeraert*



*D. Michez*



*Dr. J. Letellier*



*Dr. K. Driche & Dr. G. Chicot*





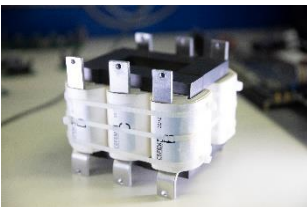
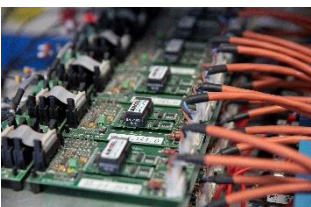
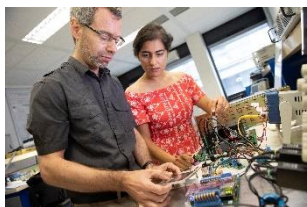
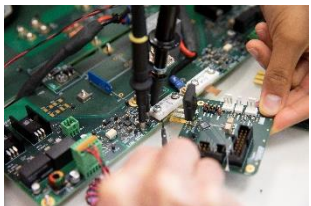

# What brings diamond compared to wide bandgap materials in power semiconductor devices?

*Session 4A: Diamond Power Devices I*

*\*Invited speaker*

*Sept 11<sup>th</sup> 2023*

Nicolas ROUGER, CNRS Research scientist

[Nicolas.rouger@laplace.univ-tlse.fr](mailto:Nicolas.rouger@laplace.univ-tlse.fr)

