



HAL
open science

HYDRODYNAMIC SHOCK IN RIVERS: PHYSICAL AND NUMERICAL MODELLING OF FLOW STRUCTURES IN TSUNAMI-LIKE BORES

Bruno Simon, Pierre Lubin, Hubert Chanson

► **To cite this version:**

Bruno Simon, Pierre Lubin, Hubert Chanson. HYDRODYNAMIC SHOCK IN RIVERS: PHYSICAL AND NUMERICAL MODELLING OF FLOW STRUCTURES IN TSUNAMI-LIKE BORES. 2023. hal-04213736

HAL Id: hal-04213736

<https://hal.science/hal-04213736v1>

Preprint submitted on 21 Sep 2023

HAL is a multi-disciplinary open access archive for the deposit and dissemination of scientific research documents, whether they are published or not. The documents may come from teaching and research institutions in France or abroad, or from public or private research centers.

L'archive ouverte pluridisciplinaire **HAL**, est destinée au dépôt et à la diffusion de documents scientifiques de niveau recherche, publiés ou non, émanant des établissements d'enseignement et de recherche français ou étrangers, des laboratoires publics ou privés.

1 **HYDRODYNAMIC SHOCK IN RIVERS: PHYSICAL AND NUMERICAL**
2 **MODELLING OF FLOW STRUCTURES IN TSUNAMI-LIKE BORES**

3 by Bruno Simon⁽¹⁻²⁾, Pierre Lubin⁽¹⁻³⁾ and Hubert Chanson⁽¹⁾

4 (1) The University of Queensland, School of Civil Engineering, Brisbane QLD 4072, Australia

5 (2) University of Bordeaux, CNRS, Arts et Metiers Institute of Technology, Bordeaux INP,
6 INRAE, I2M Bordeaux, F-33400 Talence, France

7 (3) Bordeaux INP, University of Bordeaux, CNRS, Arts et Metiers Institute of Technology,
8 INRAE, I2M Bordeaux, F-33400 Talence, France

9 Corresponding author, Email: h.chanson@uq.edu.au, Ph.: (61 7) 3365 3619, Fax: (61 7) 3365 4599

10
11 **ORCID numbers**

12 H. CHANSON 0000-0002-2016-9650

13 P. LUBIN 0000-0003-1957-6854

14
15 Abstract: The aim of this work is to provide convincing evidence on the turbulent processes induced by
16 three-dimensional (3D) bores, based on physical and computational fluid dynamics (CFD) studies of
17 undular tidal bores, a phenomenon very similar to a tsunami-like bore propagating inland along a river.
18 The numerical study is performed by solving the Navier-Stokes equations with a large eddy simulation
19 method in order to access the turbulent flow evolution during the bore passage. Two and three
20 dimensional simulations are performed with and without turbulence before bore generations to inspect
21 the effect of coherent structures on the bore propagation. A complex three dimensional flow takes place
22 during the bore passage. Beneath the undulation crests, a strong shear is observed near the channel bed.
23 Moreover, ejection of turbulent structures occurs during the propagation of undular bores depending on
24 the initial flow conditions. These simulations provide the first detailed three dimensional data of undular
25 bores intricate flow structure. The results showed that the propagation of the bore front drastically
26 changes the properties of the water column. It is also highlighted that for an upstream current exceeding
27 a threshold value, near-bed eddies are generated and ejected in the water column independently of the

28 free surface characteristics. Our simulations improve the understanding of positive surges which could
29 be extended to tsunami-like bores studies.

30

31 Keywords: Undular bores, Physical modelling, Numerical CFD modelling, In-river tsunami
32 propagation.

33

34 **I) INTRODUCTION**

35 All the catastrophic events inherent to tsunamis reported in the literature have highlighted the extremely
36 rapid propagation of tsunami waters along rivers and canals, causing very significant damage inland. A
37 tsunami is an ocean wave triggered by volcanic eruptions, submarine landslide, onshore landslides in
38 which large volumes of debris fall into the water, or large earthquakes occurring near or under the ocean.
39 This infamous phenomenon takes the form of a shallow water wave of infinite wavelength, compared
40 to the water depth of the water it is traveling through. Tsunamis propagate at high speeds and travel
41 great, transoceanic distances with limited energy loss, thus striking coastlines from several continents
42 for each recorded event. While tsunamis propagate in deep ocean water depths, they will slow down in
43 speed and their amplitudes will dramatically increase as they reach the shorelines. MADSEN et al.
44 (2008) discussed the reproduction of tsunami-like bores in a variety of conditions. The amount of energy
45 released in the catastrophic impact between the tsunamis and the landforms then cause massive damage
46 and casualties, as the waves break leading to the formation of walls of water running quickly over the
47 land (YEH et al. 1996, HEBENSTREIT 1997). Subsequently, large land areas can be inundated. After
48 breaking, a tsunami wave propagating in shallow waters is preceded by a breaking front. In these shallow
49 rivers and bays, the breaking bore propagation is associated with strong mixing and massive upstream
50 sedimentary processes. ARNASON et al. (2009) experimentally studied the interactions between a
51 broken tsunami wave and structures of different cross sections and sought to further the understanding
52 of interactions between the bore-like flow generated by a dam-break flow. If eventually a river mouth
53 is located in the impacted area, the flooded areas can be much greater, due to the penetration of the
54 tsunami in the river which can then travel inland on much larger distances (YEH et al., 2012;
55 CHANSON & LUBIN, 2013; TOLKOVA et al., 2015; TOLKOVA, 2018). Several examples have been

56 documented on video (see Tsunami at Okawa River in Kesennuma city, video cited in reference), and
57 many unsuccessful attempts have been made to protect the coastal areas. LIU et al. (2013) documented
58 several strategies locally implemented, as a “tsunami control forest” which was planted to protect the
59 local community, or tsunami shelters to provide nearby and accessible shelter for people trying to escape
60 from directly threatened areas. Moreover, a nearby river was armed with a tsunami gate, which was
61 supposed to be closed in the event of an approaching tsunami. LIU et al. (2013) reported that all these
62 strategies failed to protect against the 11 March 2011 Tohoku Tsunami event, supported by many
63 pictures of the remains of the buildings, bridges and structures which have been massively over-washed
64 by the catastrophic event which exceeded the estimates in the designs. But it remains impossible to
65 perform any full scale measurements of the hydrodynamics of bores due to tsunamis.

66 CHANSON & LUBIN (2013) discussed the possible analogies between in-river tsunami bores and tidal
67 bores, which is another intense and powerful natural phenomenon observed in rivers when the tidal flow
68 turns to rising, leading to the generation of a positive surge propagating upstream the river to form the
69 tidal bore. Even if a tsunami and a tidal wave are obviously two different and unrelated phenomena,
70 both present very similar features when propagating in shallow waters, and even more upstream rivers.
71 Both tsunami and tidal bores are defined as a hydrodynamic shock wave progressing upstream in
72 estuaries and rivers. A tidal bore is a specific type of positive surge propagating upstream estuaries and
73 rivers (Fig. 1), appearing at the leading front of the rising tide as it propagates upstream estuaries. Its
74 propagation induces large turbulences and sediment resuspension (KHEZRI, 2014; SIMON, 2014;
75 FURGEROT, 2014; LENG, 2018; SHI 2022). Famous tidal bores include the Silver Dragon bore in the
76 Qiantang River (China), the Pororoca in the Amazon River (Brazil) and the Bono in the Kampar River
77 (Indonesia) (CHANSON, 2011a). In the Qiantang River, bores could reach a height of 6 m (BARTSCH-
78 WINKLER and LYNCH, 1988) while in India, bores could propagate at a celerity of 12 ms^{-1} (given a
79 10.7 ms^{-1} analytic estimation) (CHUGH, 1961). Recently, tidal bores have gained in popularity by the
80 release of surf videos and the increase of news coverages. Several reasons make tidal bores attracting:
81 their large size, the roaring sound they make, the scenic spectacle Nature offers, the folklore associated
82 or their shape variations. Bores can take various form but two shapes are most recognizable: the undular
83 bore, when the wave consists of a series of undular whelps and the breaking bore, when a breaking roller
84 rushes loudly upriver without undular waves following the front. As Figure 1 illustrates, the shape can

85 be more complex when breaking roller forms on the crest of the undulations making the bore a mix of
86 undular and breaking. Figure 1 also shows that many surfers come to surf a wave that propagates for far
87 longer than classical wave. There are even more surfers when bores form at their biggest sizes when
88 river conditions combine spring tides and low-water discharge usually during summer (CHANSON,
89 2011a). This is also the occasion for tourists to watch a unique show that local populations consider as
90 a cultural heritage organising special events and celebrations during 'bore season'. Figure 2 presents
91 sketches and photographs of breaking and undular bores.

92 The phenomenon also has an impact on other human activities and on the life of the estuarine system in
93 terms of flow management (JIANG et al., 2014), navigation (MOORE, 1893) and wildlife (RULIFSON
94 and TULL, 1999). Therefore, the studies on tidal bores have increased. Simple visual observations show
95 that tidal bores participate in the mixing and resuspension of sediments and large particles. This is
96 induced by the rapid and lasting flow reversal observed following the bore passage and causing an
97 intensification of the turbulence (CHANSON et al., 2011; SIMPSON et al., 2004; FURGEROT et al.,
98 2013, 2016). The sudden change in flow conditions due to the bore induces an increase in sediment
99 concentration (CHANSON et al., 2011; MOUAZE et al., 2010; KEEVIL et al., 2015), as well as the
100 resuspension of fish eggs (RULIFSON and TULL, 1999; CHANSON and TAN, 2010) and the
101 dispersion of microfossils (LAUT et al., 2010). The effects of the bore are known, but the structure of
102 the flow beneath the free-surface and the subsequent processes are yet to be completely detailed and
103 analysed. Numerical models give the opportunity to study tidal bore in controlled domains with selected
104 parameters, and without damaging or losing equipment (SIMPSON et al., 2004; MOUAZE et al., 2010;
105 REUNGOAT et al., 2014) or encountering dangerous animals (e.g. crocodiles, sharks, snakes), as it
106 previously happened in the field (WOLANSKI et al., 2004). A complex three dimensional flow takes
107 place during the bore passage (Fig. 2). Beneath the undulation crests, a strong shear is observed near the
108 channel bed. Moreover, ejection of turbulent structures occurs during the propagation of undular bores
109 depending on the initial flow conditions. But, despite the strong impact of the mixing on the wildlife
110 and the river sediment transport, the turbulent mechanisms involved still need to be detailed. This is due
111 to the limited numbers of observations and the difficulty to obtain detailed measurements.

112 Beneath the free surface, a complete flow reversal usually occurs as the bore passes (CHANSON et al.,
113 2011; MOUAZE et al., 2010; SIMPSON et al., 2004). Nevertheless, it was also observed that the current

114 dynamics can be different from just a reversal with the front (DARCY and BAZIN, 1865; REUNGOAT
115 et al., 2014, 2017). For example: downstream a meander, a bore can split into two fronts, with a first
116 front producing a flow deceleration with no change of direction and the second front inducing a flow
117 reversal (KJERFVE and FERREIRA, 1993). Another example is an island dividing the river in a main
118 channel and a smaller branch: the bore front might split between the main river course and the smaller
119 channel, with the faster bore in the main channel entering the arm at its upstream end and forming a
120 counter-bore (BONNETON et al., 2011b; KEEVIL et al., 2015). Most studies, including the present
121 study, try to determine the kernel of the phenomenon with a simple geometry, simple flow
122 considerations and focusing on the moment just before and after the bore passage. The simplest
123 geometry is a rectangular channel with constant dimensions. A few recent experimental works can be
124 highlighted where trapezoidal channel have been used to study the transverse mixing induced by
125 unsteady secondary motion (KIRI et al., 2020a,b; FERNANDO et al., 2020) and will be discussed in the
126 last section of this paper to highlight the perspectives of future works.

127 Experimental studies in a straight rectangular channel have confirmed that the bore passage may induce
128 in some cases a flow reversal beneath the bore as well as an increase of flow turbulence (KOCH and
129 CHANSON, 2008; LENG, 2018; SHI, 2022). However, such studies were mostly conducted with
130 intrusive probes providing pointwise measurements. During the recent decades, studies have been
131 devoted to the characterisation and quantification of the turbulent and sediment mixing processes
132 occurring when tidal bores propagate upstream rivers. Recently, KOBAYACHI and UCHIDA (2022)
133 investigated experimentally and numerically the characteristics of breaking bore in meandering
134 channels, focusing on Froude number consideration. The laboratory experiments were conducted with
135 different Froude number conditions, comparing the meandering channel results with the straight channel
136 results. They also qualitatively explained the factors which could limit the applicability of 2D
137 calculations, comparing 3D calculations using a RANS model.

138 Numerical simulations can thus complement laboratory and field studies, and provide details of the flow
139 evolution in the whole domain of propagation, even considering such a simple configuration than a
140 rectangular channel. Several studies were performed by solving the Saint-Venant equations (MADSEN
141 et al., 2005), Boussinesq equations (ABBOTT and RODENHUIS, 1972; CASTRO-ORGAZ and
142 CHANSON, 2022), Serre-Green-Naghdi equations (CASTRO-ORGAZ and CHANSON, 2020; ROY-

143 BISWAS et al., 2021), the 3D Reynolds-averaging Navier-Stokes equations (AI et al., 2021) or
144 Korteweg-de Vries equations (PEREGRINE, 1966; BJØRNESTAD et al., 2021). Solving these
145 equations gives good approximations for the free-surface, but it does not yet investigate the intricate
146 flow hydrodynamics. Flow reversal and increase of turbulent levels are not taken into account by the
147 previously cited equation systems. However, the Navier-Stokes equations can model the flow in bores
148 with great details, as shown in previous two-dimensional numerical simulations of breaking bores
149 (LUBIN et al., 2010a, 2010b; FURUYAMA and CHANSON, 2008). These studies of breaking bores
150 showed the apparition and ejection of large recirculation structures above the channel bed following the
151 wake of the bore front, but remained simplified two-dimensional studies. Moreover, AI et al. (2021),
152 using a 3D non-hydrostatic model, simulated undular bores in open channels. The model was validated
153 with four typical benchmark problems: undular bore development, an undular bore generated by a
154 sudden discharge, dam-break flow over a triangular bottom sill, and dam-break flow through an L-
155 shaped channel. They showed the capacity of the model to simulate the hydrodynamic features of the
156 flow. The effect of tidal rise on tsunami waves was addressed by KALMBACHER and HILL (2015),
157 using depth-averaged equations, while the effect of channel shape was addressed for a broad class of
158 tsunami-like-long-waves by WINCKLER and LIU (2015), solving Boussinesq-type equations. KANG
159 et al. (2011) simulated the complex structure of the flow in terms of primary and secondary vortices in
160 curved areas of the channels. They discussed the comparison of direct numerical simulation (DNS),
161 large-eddy simulation (LES), or unsteady Reynolds-averaged Navier–Stokes (URANS) modelling, in
162 the case of a 50-m long natural meandering stream using a resolution sufficiently fine to capture vortex
163 shedding from centimetre-scale roughness elements on the bed. Later, PUTRA et al. (2019) studied the
164 impact of tidal bores on the transport of non-cohesive sediment particles on the basis of the earlier works
165 of BERCHET et al. (2018), while ROY-BISWAS & SEN (2022) presented a systematic assessment of
166 2D RANS models compared with 2D LES results on positive surge modelling, showing the great
167 capabilities of such models to successfully describe the hydrodynamics beneath the free-surface.

168 Our present numerical study was based on data from selected laboratory experiments (CHANSON,
169 2010b, 2012). However, it must be noticed that several types of positive surges exist: tidal bores, dam
170 break wave (MARCHE et al., 1995), stationary hydraulic jump (ANDERSEN, 1978) and surges
171 generated by rejection of a flow against an obstacle and propagating upstream (CHANSON, 2010b,

172 2011; KOCH and CHANSON, 2009; SIMON and CHANSON, 2013) (Fig. 3). In this paper, we chose
173 the latter since the bore is propagating against an adverse flow, similarly to most cases in rivers, to detail
174 the 3D turbulent processes under undular bores. Experimental pictures are shown on Figures 4 and 5 to
175 show the closure of the downstream end gate and the bore propagation, respectively.

176 Most tidal bore field studies show an opposite flow (OF) sketched in Figure 3. Surprisingly, when the
177 hydrodynamic effects of the TBs passage are studied in hydraulic flume either experimentally
178 (TRESKE, 1994) or numerically with computational fluid dynamics (CFD) (FURUYAMA and
179 CHANSON, 2010; MADSEN et al., 2005; LUBIN et al., 2010a,b), the studies are based on either dam
180 break (DB) wave, where the wave propagates against still water (HORNUNG et al., 1995; MARCHE
181 et al., 1995; SOAREZ FRAZAO and ZECH, 2002), or a bore generated by placing an obstacle
182 downstream the flume which in turn produces an upstream positive surge, whether the channel is fully
183 closed (FC) or partially closed (PC) (BENET and CUNGE, 1971; KHEZRI and CHANSON, 2012;
184 Koch and CHANSON, 2008). Yet, for a similar Froude number, the shape, determined by the wave
185 amplitude or length, of the free surface could be different depending upon the test case (as in Figure 3
186 in KHEZRI and CHANSON, 2012). Previous simulations (SIMON, 2014) showed that, for nearly-
187 identical Froude numbers, an inversion of the flow near the bed could occur for a PC case or not DB
188 case. One parameter that could influence such differences might be the flow field upstream and
189 downstream the bore.

190 Herein, a numerical study of undular bores is realised with simulations in two and three dimensions, and
191 the data are compared to experimental results. The numerical study is performed by solving the Navier-
192 Stokes equations with a large eddy simulation method in order to access the turbulent flow evolution
193 during the bore passage. Two and three dimensional simulations are performed with and without
194 turbulence before bore generations to inspect the effect of coherent structures on the bore propagation.
195 These simulations provide the first detailed three dimensional data of flow turbulence for undular bores.
196 In this paper, we aim to propose a numerical study to illustrate the hydrodynamics considering different
197 types of bore generation, and provide a thorough discussion on the turbulent processes observed under
198 undular bores, compared to the most recent works. First, we will introduce the equations and the
199 numerical methods, including the method used to inject the turbulent experimental conditions in the 3D
200 numerical simulations. Then, before showing 2D numerical results, the analytical definition of the

201 Froude number is discussed. Based on the Froude number, 2D dam-break bore test-case is validated,
 202 and a 2D positive surge is compared to experimental data. Follows a discussion on different techniques
 203 used to generate bores (dam-break, reflection wave due to an opposing flow, or a partially-closed gate,
 204 or a fully-closed gate, hydraulic jump). Then, the 3D numerical results are presented, leading to a section
 205 dedicated to a discussion and some perspectives will be provided as a conclusion.

206 II) NUMERICAL MODELLING

207 II.1) Equations and numerical methods

208 To simulate the detailed hydrodynamics and turbulence of positive surges, the Navier-Stokes (NS)
 209 equations, in their multiphase forms (KATAOKA, 1986), were solved using the CFD code Thetis
 210 (homemade numerical tool from the University of Bordeaux, as of 2015: Notus, for the open-source
 211 version). Since the Reynolds number for the present simulations is greater than 9×10^4 , a Large Eddy
 212 Simulation (LES) filter is used with the NS equations (SAGAUT, 2006). The air/water interface was
 213 tracked by a Volume Of Fluid (VOF) method using a Piecewise Linear Interface Calculation model
 214 (YOUNGS, 1982). The system of equations yields:

215

$$\nabla \cdot \mathbf{u} = 0 \quad (1)$$

$$\rho \left(\frac{\partial \mathbf{u}}{\partial t} + (\mathbf{u} \cdot \nabla) \mathbf{u} \right) = \rho \mathbf{g} - \nabla p - B_u - \frac{\mu}{K} \mathbf{u} + \nabla \cdot [(\mu + \mu_t)(\nabla \mathbf{u} + \nabla^T \mathbf{u})] \quad (2)$$

$$\frac{\partial C}{\partial t} + \mathbf{u} \cdot \nabla C = 0 \quad (3)$$

216 with \mathbf{u} the filtered velocity vector, p the pressure, μ the fluid viscosity, ρ the fluid density, μ_t the turbulent
 217 viscosity, B_u a matrix forcing the velocity components on the boundary, K a permeability coefficient.
 218 The gravitational vector \mathbf{g} is set to $g = 9.81 \text{ m.s}^{-2}$. The turbulent viscosity is calculated thanks to the
 219 Mixed Scale model (SAGAUT, 2006), which is derived from a weighted geometric average of the
 220 classical Smagorinsky subgrid scale model (SMAGORINSKY, 1963) and the turbulent kinetic energy
 221 subgrid scale model (BARDINA et al., 1980).

222 The VOF-PLIC method has the advantage of building a sharp interface between the air and the water.
 223 The phase function C is used to locate the different fluids. The magnitude of physical characteristics of
 224 the fluids depends on the local phase. The physical characteristics are defined according to C as:

225

$$\rho = C\rho_w + (1 - C)\rho_a \quad (4)$$

$$\mu = C\mu_w + (1 - C)\mu_a$$

226

227 where $\rho_a = 1.1768 \text{ kg.m}^{-3}$ and $\rho_w = 1,000 \text{ kg.m}^{-3}$ are the densities, and $\mu_a = 1.85 \times 10^{-5} \text{ kg.m}^{-1}.\text{s}^{-1}$ and
228 $\mu_w = 1 \times 10^{-3} \text{ kg.m}^{-1}.\text{s}^{-1}$ being the viscosities of air and water, respectively. Since the phase function is not
229 defined at each point where the viscosities and densities are needed for the Navier-Stokes discretization,
230 the physical characteristics are interpolated on the staggered grid corresponding to the marker and cell
231 method. The density on the velocity nodes is calculated with a linear interpolation, whereas harmonic
232 interpolation is used for the viscosity. Time discretization of the momentum equation is implicit and a
233 Euler scheme is used. The velocity/pressure coupling under the incompressible flow constraint is solved
234 with the time splitting pressure correction method (GODA, 1979). The equations are discretized on a
235 staggered grid by means of the finite volume method. The space derivatives of the inertial term are
236 discretized by a hybrid upwind-centered scheme, whereas the viscous term is approximated by a second-
237 order centered scheme (PATANKAR, 1980). The MPI library is used to parallelize the code, the mesh
238 being partitioned into equal size subdomains to ensure load balancing. The HYPRE parallel solver and
239 preconditioner library is used to solve the linear systems (FALGOUT et al., 2006). For faster
240 simulations, the domain was partitioned into 32 subdomains, with one processor per subdomain. The
241 numerical code was previously extensively verified and validated through numerous test-cases,
242 including mesh refinement analysis for coastal applications (LUBIN & GLOCKNER, 2015) and
243 sediment transport by tidal bores (BERCHET et al., 2018) using numerical data from SIMON (2014) as
244 inlet boundary conditions. Moreover, PUTRA et al. (2019) used the open-source software OpenFOAM
245 and successfully compared the numerical results from Thetis, OpenFOAM, using similar numerical
246 settings that those chosen in this study, against several sets of experimental and analytical data, thus
247 validating our numerical approach.

248

249 **II.2) Turbulent inflow conditions for the 3D numerical simulations**

250 To numerically reproduce a turbulent inflow condition, as generated in physical experiments, the
251 numerical code required some turbulence injection in the numerical domain. We chose to use the
252 Synthetic Eddy Method (SEM) (JARRIN et al., 2006; JARRIN, 2008; CHANSON et al., 2012; SIMON,

253 2014; LENG et al., 2018) since it is a relatively simple and efficient method (DHAMANKAR et al.,
254 2018). It explicitly generates large-scale coherent structures and convects them with the mean flow
255 through the inlet plan. This method considers turbulence as a superposition of coherent structures. These
256 eddies are generated over the inlet plane of the calculation domain and defined by a shape function that
257 encompasses the spatial and temporal characteristics of the targeted structures. To compute a coherent
258 stochastic signal, the method only requires the mean velocity and the Reynolds stresses, which are
259 obtained from the experimental data, and the typical size and number of eddies, which can be roughly
260 estimated as detailed by JARRIN et al., 2006. Although the SEM involves the summation of a large
261 number of eddies for each grid point on the inflow, the CPU time required to reconstruct a fluctuating
262 inflow condition corresponding to the experimental one for each iteration is negligible. The SEM
263 reconstructs the velocity signals by adding the velocity fluctuation \mathbf{u}' to the mean velocity $\bar{\mathbf{u}}$. The
264 velocity is computed, as indicated by JARRIN et al. (2006), and the SEM method is reported to perform
265 well on any geometry and for any kind of flow.

266 The SEM generates eddies in an extra sub-domain, also box of eddies, as coined by JARRIN et al., 2006,
267 of the main simulation domain. The velocity signal is extracted from this sub-domain and added to the
268 main simulation. At each time step of the main simulation, the SEM transports eddies within its sub-
269 domain with the modelled velocity. When eddies are convected outside of the sub-domain new eddies
270 are added to maintain their number. The signal generated is thus a stationary ergodic random process.
271 The SEM reproduces the same mean velocity and Reynolds stresses as those given in input. Yet, the
272 turbulence recovers a coherent value after a distance of about 15 times half the SEM's inlet (JARRIN,
273 2008) during which the turbulence decreases (SIMON, 2014). In our 3D numerical simulations, the flow
274 velocity and Reynolds stresses were reconstructed from polynomial approximations of measured
275 vertical profiles realized independently (CHANSON, 2010c, 2011b). The measurements were made at
276 $x = 7.2$ m from the inception zone of the bore, but the recreated turbulence was injected in the numerical
277 domain at $x = 10$ m (see section).

278

279 **II.3) Froude number definition**

280 Focusing only on the instant before and after the bore passage, the bores are upstream positive surges,
281 i.e. a sudden increase of the water level and a sudden change of the current. Figure 3 presents sketches

282 of the various flow conditions associated with upstream positive surges propagation where a bore travels
 283 at velocity $U_b > 0$ upstream a body of water with a depth d_0 and a velocity $V_0 \leq 0$. The mean water level
 284 after the bore, or bore conjugated depth, being d_b , and the bore flow velocity being V_b , either positive or
 285 negative. Figure 4 displays an example of the bore generation by the closure of a Tainter gate, fully-
 286 closed and vertical. Figure 5 presents pictures of an example of experiments conducted in the physical
 287 channel of the University of Queensland. The bore is propagating upstream against the initially-steady
 288 flow and physical observations were conducted about mid-channel (SIMON and CHANSON, 2013).
 289 A summary of the basic flow dynamic in a positive surge are listed in Table 1 with common applications.
 290 Although it has also been used as an analogy for tsunami bore (CHANSON, 2009a), the case of the
 291 static hydraulic jump (HJ) is excluded from this discussion since the bore is not traveling ($U_b = 0$) as a
 292 tsunami-induced bore. Tsunami bores and other positive surges can be solely breaking, or solely undular
 293 or can have some weak breaking on the wave crests. In any case, the propagation of a positive surge can
 294 be simplified assuming a horizontal bottom, hydrostatic pressure and no bed friction. Under the previous
 295 hypotheses and since the flow upstream (subscript 0) and downstream (subscript b) the front must satisfy
 296 the continuity and momentum principles, we can obtain a series of relationships between the flow
 297 properties after integration (BARRE DE SAINT VENANT, 1871; RAYLEIGH, 1908), for a system of
 298 reference moving with the bore, as follows:

$$(V_0 - U_b)d_0 = (V_b - U_b)d_b \quad (5)$$

$$\rho g(d_0^2 - d_b^2) = 2\rho d_0(V_0 - U_b)(V_b - V_0) \quad (6)$$

299 where ρ is the fluid density and g is the gravitational acceleration. The combination of the continuity
 300 and momentum equations gives (HENDERSON 1966, CHANSON 2012):

$$\frac{d_b}{d_0} = \frac{1}{2} \left(\sqrt{1 + 8Fr^2} - 1 \right) \quad (7)$$

301 where Fr is the surge Froude number defined in a horizontal rectangular channel as:

$$Fr = \frac{|V_0 - U_b|}{\sqrt{gd_0}} \quad (8)$$

302 We will evaluate the impact of both V_0 and V_b as initial conditions on positive surges hydrodynamics,
 303 through a 2D numerical exercise. The numerical simulations are performed after selecting an initial
 304 water depth d_0 and a Froude number Fr . Choosing an initial Froude number sets the ratio d_b/d_0 (Eq. 7)

305 and choosing an initial value for the water depth d_0 then sets the initial value for d_b , which in turns set
306 the value of $(V_0 - V_b)$, since:

$$g(d_0^2 - d_b^2) = 2d_0 Fr \sqrt{gd_0} (V_b - V_0) \quad (9)$$

307 All that is left to choose to perform simulations is one of the three initial values for V_0 , V_b or U_b in
308 order to get the remaining two which will fulfil Equations (5) and (6). We set the initial water depth
309 $d_0 = 0.1m$, and for different Froude numbers and various values for V_0 , which set the initial type of
310 flow according to Table 1, we present the subsequent flow hydrodynamics in order to discuss and clarify
311 the impact of the choices for V_0 and V_b when tsunami bores are studied, especially since V_0 and V_b are
312 mostly observed to be in opposite directions in natural processes. We will take the advantages of the
313 present numerical study, to make a comparison of various method to mimic a tidal bore, and discuss the
314 subsequent flow features.

315

316 **II.4) 2D Dam-break surge wave (DB) – Analytical validation**

317 Before further discussing the numerical results of bore generation conditions, we illustrate the capacity
318 of the numerical tool to handle hydrodynamic shocks as later studied in this article. We chose to validate
319 our numerical results against analytical data, i.e. the dam-break (DB) problem over a wet bed. The DB
320 wave is a classic case of bore generation and propagation, which allows to generate a bore and also
321 provides an analytical solution (LUBIN, 2004; FURUYAMA and CHANSON, 2008; SIMON, 2014;
322 PUTRA et al., 2019; BARRANCO and LIU, 2021, 2023), independently of any experimental dynamic
323 inlet boundary conditions of any kind (so the SEM method is not required here). Indeed, the generation
324 process consists of a high reservoir of water into a shallower water (Figure 6). Analytical formulas give
325 the bore celerity U_b and conjugate depth d_b knowing only the water depth at rest, d_0 , the water depth in
326 the dam reservoir, d_1 , under the hypothesis of Eqs. (5) and (6) and in an infinitely long dam reservoir
327 (STOKER, 1957; MONTES, 1998). The computational fluid dynamics (CFD) code is compared with
328 analytical values before discussing the hydrodynamics generated while the subsequent bore propagates.
329 Figure 7 presents the initial flow conditions and the hydrodynamics of the propagating bore in the whole
330 domain and the bore propagation.

331 The dam break is initialised with two zones of quiescent water with a hydrostatic pressure distribution
332 separated by an infinitely thin wall. The higher dam reservoir has a water depth $d_1 = 0.158$ m while the

333 small reservoir is $d_0 = 0.1$ m (Figure 7). The 2D numerical domain is 20 m long and 0.5 m high. At the
334 instant $t = 0$ s, the dam wall located at $x = 0$ m disappears instantaneously.

335 The domain boundaries are set with no slip boundary conditions. In the vertical direction, the mesh grid
336 consists of 500 irregular meshes, with Δz_{\min} starting at 5×10^{-5} m at the bottom and increasing
337 exponentially to the top. In the longitudinal direction, between $x = 0$ to 10 m, the domain is discretised
338 with 4,100 regular cells. Whereas between $x = 0$ to -10 m, 500 non-constant meshes are used with
339 exponential variation, starting with $\Delta x_{\min} = 2.4 \times 10^{-3}$ m at $x = 0$. The Courant-Friedrichs-Lewy (CFL)
340 condition is inferior to $2/3$ to insure the scheme stability. It took approximately 20 hours to perform the
341 parallel simulation with 36 processors. With $d_1 = 0.158$ m and $d_0 = 0.1$ m, the theory (eqs. 5-9) predicts
342 a bore with $U_b = 1.191$ m.s⁻¹ and $d_b = 0.1273$ m. Figure 8 presents the time series of the free surface
343 elevations, showing the numerical results compared to the theoretical bore front position and elevation,
344 and the following wave trains. The simulated bore is undular, with $Fr = 1.20$. As the bore propagates,
345 secondary undulations form and oscillate around d_b with the wave train tail converging toward d_b . The
346 free surface perturbation, produced by the collapse of the dam, remains slightly visible at $t = 3.5$ to 3.7
347 s in the time series measured at $x = 3.2$ m, but later disappears as the bore propagates. The numerical
348 results also show that the bore accelerates progressively to reach a celerity value that is almost constant
349 after the front passes $x = 2.5$ m. The numerical results yield $U_b = 1.190$ m.s⁻¹ and $d_b = 0.1275$ m at $x =$
350 3.2 m. We can then compare the celerity of an idealized bore to the numerical results of an undular bore
351 to demonstrate the results are reasonable, however it has to be mentioned that the undular bore is
352 transient such that its form (i.e. number of secondary undulations or whelps) and the wave celerity (i.e.
353 U_b here) evolve with propagation distance (BRÜHL et al., 2022), whereas an idealized bore has constant
354 values as shown here.

355 Figure 9a presents the longitudinal velocity component time evolutions during the bore passage at
356 several depths. Figure 9b presents a vertical profile of the longitudinal velocity underneath the first crest
357 of the bore. The flow is observed to accelerate during the bore passage. Underneath the bore, the
358 longitudinal velocity component oscillates around a mean value $V_b = 0.255$ m.s⁻¹ for $z > 0.02$ m, which
359 is similar to the analytical data V_b . For $z < 0.02$ m, the longitudinal velocity component oscillates around
360 a mean value depending on the depth. MARCHE et al. (1995) observed similar velocity profiles beneath
361 the wave crest of a breaking DB wave.

362 Figure 10 shows the comparison between the simulated pressure evolution to the hydrostatic pressure
363 calculated from the simulated free surface evolution at $x = 5$ m. Compared to the hydrostatic pressure,
364 the simulated pressure field is lower beneath the crest and larger beneath the troughs (Figure 10). Such
365 a behaviour is predicted by the irrotational flow motion theory (ROUSE 1938, LIGGETT 1994), has
366 been previously reported by MARCHE et al. (1995), while similar findings were documented in undular
367 hydraulic jumps (MONTES and CHANSON, 1998). Altogether, the results show a very good agreement
368 in both free-surface profiles and characteristic times for the simulation of the dam break on a wet bottom,
369 compared to the analytical data. The numerical model gives very satisfactory results for this two-
370 dimensional problem, as illustrated in this section.

371 Before considering 3D numerical simulations of positive surges in section (IV), we first propose in the
372 following sections a fully detailed description and discussion of 2D validation test-cases of several
373 methods to numerically generates proxy tidal bores.

374

375 **II.5) Validation of a 2D positive surge generated by a fully closed gate (FC) compared to** 376 **experimental data**

377 As discussed in the introduction, many experiments found in the literature were performed for positive
378 surges where the mean velocities V_b (fluid velocity flowing from downstream to upstream, when the
379 tide rises upriver) and V_0 (river stream flowing downstream) are in the same direction and with $|V_b| <$
380 $|V_0|$, thus corresponding to either FC (Fully Closed) or PC (Partially Closed) gate cases. This provides
381 relevant test cases for simulations of positive surges. Here, we chose the experimental data set of
382 CHANSON (2009b, 2010b) with a FC case. Note that these data were not specifically made for the
383 validation of simulations, and many required detailed needed to recreate the comparable simulation are
384 not available, although this was one of the most complete where the bore is an experiment involving a
385 fully closed gate experiment in a rectangular channel. For example, the experimental data for initial
386 steady flow include only the discharge, and velocity and turbulence vertical profiles on the channel
387 centreline at only one position. This would be insufficient to set the proper initial conditions to perform
388 a 3D turbulent Navier-Stokes simulation. In the present comparison, the initial velocity is set to a
389 constant velocity V_0 . With the Fully-Closed (FC) gate cases, an analytical solution is available in terms
390 of Fr , U_b and V_b as long as d_0 and V_0 are known under the hypothesis of ideal fluid flow (STOKER,

391 1957, HENDERSON, 1966). Herein, the complete numerical domain consists of a vertical rectangle
392 (Figure 6) where the bore propagation takes place between $x = 0$ to $x = 10$ m. The domain is filled with
393 water, initialized with the depth $d_0 = 0.199$ m and flow with a constant velocity $V_0 = -0.189$ m.s⁻¹. The
394 bore is generated by the impact of the flow against a fully closed vertical boundary, similarly to what is
395 done in the experiment from CHANSON (2010b). The 2D numerical domain is discretized into
396 5,000×500 regular Cartesian mesh cells. The grid is evenly distributed in both longitudinal and vertical
397 directions, giving a mesh grid resolution of $\Delta x = 2 \cdot 10^{-3}$ m and $\Delta z = 10^{-4}$ m. For the bore generation, the
398 outflow boundary is closed with a no-slip boundary to emulate the rapid closure of the channel during
399 the experiments. As the simulation starts, the flow impacts the boundary without splashing, creating an
400 elevation of the water level propagating upstream and forming a bore with secondary undulations.

401 Figure 11a shows the dimensionless time evolution of the free surface at two locations, comparing
402 numerical data and experimental measurements. The 2D numerical simulation reproduces closely the
403 free surface evolution from the experiment. A direct comparison shows that the bore conjugate depth,
404 as well as first undulation maximum height, wave length and first undulation minimum depth are within
405 3% differences with the experimental data. The amplitude is simulated within 15% from the
406 experimental data, while the bore celerity differs by 2% (SIMON, 2014).

407 Figure 11b shows the dimensionless velocity components measured at $x = 7.15$ m and $z = 0.146$ m deep.
408 Both velocity components are compared to the experimental measurements, showing similar trends and
409 evolutions as the bore propagates. The numerical results show again a good agreement with the
410 experimental data. considering the difference between experiment and simulated initial conditions, such
411 as the turbulence (not taken into account in a 2D numerical simulation) and boundary layer development.
412 The validation tests covered several circumstances that lead to the formation of undular bores. However,
413 the proposed model has proved the potential to simulate undular bores resulting from more varied
414 mechanisms.

415 **III) TWO-DIMENSIONAL BASIC FLOW FEATURES – COMPARISON AND DISCUSSION**
416 **OF THE INITIAL SURGE GENERATION PROCEDURES**

417 **III.1) Discussion on different techniques to generate positive surges**

418 In this section, we first discuss on how to generate a bore. We used a 2D numerical domain with the
419 flow conditions listed in Table 2. We carefully compared the free-surface characteristics, and performed
420 a thorough analysis of the hydrodynamics below the waves, considering undular bores and weakly
421 breaking bores.

422 Figure 12 presents the dimensionless time evolutions of the bore free surface profiles at different
423 longitudinal locations for different Froude numbers. The simulation data from the numerical probes are
424 nondimensionalized using the bore celerity U_b to synchronize the bore passage. All the free surface
425 profiles can be observed to exhibit the same features. A characteristic, which is often measured in
426 undular bores, is the bore front shape, characterized by the ratio between the amplitude and the
427 wavelength (a_w/l_w) (CHANSON, 2010a; SIMON, 2014, PUTRA et al. 2019). Figure 13 presents
428 comparisons of the bore's shape with experimental and theoretical data, considering different bore
429 generation methods. When compared with a large number of data, the present numerical results agreed
430 well with the plotted data, quantitatively as well as qualitatively. This was confirmed by PUTRA et al.
431 (2019). In particular, the values remain between the curves given by the linear and cnoidal theories
432 (LEMOINE, 1948; ANDERSEN, 1978). The main observed differences occur for cases Fr1.1PC2 and
433 Fr1.2PC3, when $|V_0|$ increases and induces modifications in the overall hydrodynamics, as detailed in
434 the next section.

435 The following analysis details the hydrodynamics in the non-moving frame of reference. Figures 14, 15
436 and 16 present streamlines and isolines in the non-moving frame of reference that represent the fluid
437 direction and $u_x = 0$, respectively. Three main behaviours of the flow can be summarized hereafter.

- 438 • Complete flow inversion: There is a complete flow inversion beneath the bore when the
439 longitudinal velocity component u_x changes sign over the water column. During the bore front
440 passage, u_x goes from V_0 to a positive value. Beneath the secondary undulations, the velocity
441 magnitudes oscillate around V_b in most of the water column and remains mainly positive. This
442 happens for the DB (Figs. 14a, 15a and 16a) and OF (Figs. 14b-c-d, 15b-c-d and 16b-c-d) Cases

443 which exhibit a complete flow inversion, as seen with the black isolines at the inception of the
444 bore front with the streamlines going in opposite directions from each part of the front.

445 • Alternating flow inversion beneath wave crests and troughs: there is a first inversion beneath
446 the bore front with the flow going against V_0 . Beneath the secondary undulations, u_x is positive
447 beneath the crest and negative beneath the trough over most of the water column. When the
448 undulations pass, the u_x stabilizes around V_b (positive or negative). This happens for the OF
449 (Figs. 14b-c-d, 15b-c-d and 16b-c-d), FC (Figs. 14e, 15e and 16e) and PC (Figs. 14f, 15f and
450 16f) cases. Note that for case Fr1.2PC1, the velocity only alternates under the bore front and the
451 first undulation (Figure 15d). For Fr1.2PC2, the velocity does not alternate over the whole water
452 column (Figure 15e) but the dynamics is close to the other mentioned cases.

453 • No flow inversion: there is no complete change of direction of the current over the water column.
454 The longitudinal velocity u_x remains in the same direction as V_0 in most of the water column
455 and fluctuates around the value of V_b . There can be exceptions near the bed where intense flow
456 reversal occurs under the wave crests. This happens for all PC cases.

457 Note that different hydrodynamics properties might be observed for breaking bores with no secondary
458 undulations. Near the bed, velocity fluctuations and ejections of eddies could appear independently of
459 complete flow reversal.

460 To summarise the observations detailed in this section, Figure 17 presents three sketches outlining the
461 flow hydrodynamics properties, in a non-moving referential, encountered during this two-dimensional
462 study. The discussion is mainly focused on the longitudinal velocity component u_x since the vertical
463 velocity component u_z globally oscillates in relation to the free surface evolution, except when
464 turbulence appears. In the tested configurations, three main situations appeared during the bore passage:

- 465 1. Figure 17a: A complete flow reversal: u_x flows in opposite direction to the initial flow.
- 466 2. Figure 17b: An oscillation of the flow: u_x oscillates under the wave crests of the secondary wave
467 train.
- 468 3. Figure 17c: No flow reversal: u_x mainly stays in the same direction as the initial flow.

469 Some distinctions are to be considered. In the upper part of the water column, for the second sketch
470 presented in Figure 17b, the undulation of zone 1a does not necessarily start on the bore front. Flow
471 reversal can remain unconnected (zone 1b) under the front and the first oscillations independently of the

472 direction of V_b , as we can see in Figure 16d with $V_b > 0$ and Figure 15e with $V_b < 0$. Moreover, in the
473 wake of the secondary wave train, the flow can either remain in the direction of V_0 or flow opposite to
474 it. These situations are not necessarily linked with the changes appearing near the bed.

475 At the bottom, for every cases except the DB, we observe a re-acceleration of u_x near the bed when wave
476 crests pass (zone 2 in Figure 16b or Figure 15c). It seems that zone 2 appears when $|V_0| \neq 0$. This re-
477 acceleration can be followed beneath the wave trough by a complete (zone 3a) or a partial (zone 3b)
478 flow reversal (a good example for this can be seen in Figure 15c or 15d). The re-acceleration in zone 2
479 can also be followed by fluctuations and shedding of eddies moving upward (zone 4) as the flow is
480 simulated with larger $|V_0|$ (Figure 16e or 16f).

481 A change of bore shape together with the occurrence of fluctuations and ejections of eddies (zone 4)
482 occurs in simulation with $|V_0| > 0.5$ to 0.55 m.s^{-1} . For our cases, in which $d_0 = 0.1 \text{ m}$, this corresponds
483 to $Re > 5 \times 10^4$. In the literature, similar behaviour for positive surges can be found in LUBIN et al.
484 (2010b), where the numerical results showed occurrences of large eddies for a simulated steady flow
485 with $Re = 13.8 \times 10^4$ and a breaking bore with $Fr = 1.77$, while in SIMON (2014), no eddies appeared for
486 a simulated steady flow with $Re = 3.8 \times 10^4$ and an undular bore with $Fr = 1.14$, whereas eddies appeared
487 for a simulated steady flow with $Re = 11.5 \times 10^4$ and an undular bore with $Fr = 1.25$. The dependency of
488 eddy shedding with the Reynolds number should then be further studied to see if other parameters might
489 change the threshold of Re around 5×10^4 , especially since the Reynolds number in rivers are often much
490 larger. It may also occur as an interaction between the turbulent boundary layer developed in the river
491 flow, which is not the subject of this study, and the bore front discontinuity propagating upstream.
492 Nonetheless, turbulent behaviours are observed for the three Froude numbers used in this study as well
493 as for other found in previous numerical studies. In summary, looking at bores in the frame of reference
494 moving with V_0 and for a selected Froude number, the hydrodynamics behaviour in bores changes when
495 the Reynolds number of the steady flow becomes larger than a value close to 5×10^4 . Over that threshold,
496 the hydrodynamics near the bed changes significantly with the occurrence of velocity fluctuations and
497 the shedding of eddies, which propagate upwards in the water column eventually changing the shape of
498 the free surface. This also showed that the Froude number is not a reliable indicator of the flow structure,
499 especially near the bed. It may sound as an obvious observation, as the Froude numbers are only related
500 to free surface evolutions, but the striking feature shown in this study is that undular and weakly breaking

501 bores defined for the same Froude numbers exhibit identical free surface evolutions, whereas the flow
502 structures are different, as summarized previously in the three different scenarios sketched in figure 17.
503 This means a great care must be taken when comparing laboratory or numerical studies to the natural
504 flow. TBs are multi-parameters and complex problems that can hardly be decomposed into simple
505 hydrodynamics features. In the future, simulations should be made for larger Froude and Reynolds
506 numbers in order to further generalize our results, to study the interaction of strong wave breaking with
507 eddies generated at the bed and to compare the effects for flow conditions closer to rivers. Tsunami bore
508 conditions of occurrence also have to be analysed at larger scales to get the complete understanding of
509 the phenomenon (BONNETON et al., 2016; FILIPPINI et al., 2019) and to better target the flow
510 conditions to model.

511

512 **IV) THREE-DIMENSIONAL VELOCITY FIELD AND TURBULENCE**

513 **IV.1) Presentation**

514 Based on the previous discussions and validations, we then propose to study the turbulent
515 hydrodynamics under positive surges based upon three-dimensional numerical simulations. The
516 numerical simulations were based on physical experimental data sets (CHANSON, 2008, 2009c, 2010c,
517 2011b). The experiments were performed in a 12-m long 0.5-m wide rectangular flume. The bore
518 propagated upstream against an initially steady open channel flow. The bore generation was controlled
519 by the partial or complete closure of a downstream gate. Figure 19 illustrates the bore generation process
520 in the numerical channel.

521 To numerically simulate bores, the experimental hydraulic channel was idealised into a rectangular
522 numerical domain, which was a vertical rectangle for the two dimensional simulations and a cuboid for
523 the three dimensional simulations. Before starting the 3D numerical simulations, the experimental
524 steady flow conditions had to be recreated considering the SEM numerical procedure prescribed by
525 JARRIN (2006, 2008). The numerical domain was filled with air and water, with a constant water depth
526 d_0 . The velocity of the water was set with a constant velocity V_0 . Both d_0 and V_0 were obtained from the
527 experimental studies (CHANSON, 2010c, 2011b). Then, the bore was experimentally generated by the
528 fast closure of a gate (Fig. 18). For the numerical simulations, the gate instantly appeared at the

529 downstream end of the domain (Fig. 19), blocking the outgoing flow which then impacts a numerical
530 wall. Table 3 presents the initial conditions used for the 3D numerical study. Only two experimental
531 conditions were selected for their completeness and similarity in Froude numbers (Table 3). For each
532 case, three simulations were performed: one 2D simulation, a 3D simulation with a constant uniform
533 steady flow (i.e. $V_0 = \text{constant}$ in all the domain before the bore) and a 3D simulation with turbulent
534 inflow condition (i.e. V_0 & SEM) (Table 3). Each simulation adds a complexity to the problem during
535 the bore propagation. That is, the 2D simulations overlook the three dimensional effects, and the 3D
536 simulations without inflow turbulence ignore the effect of inflow turbulence and turbulent boundary
537 layer, present in the 3D simulations with SEM.

538 The numerical domain was 10 m long by 0.5 m high and for 3D simulations, and the channel was 0.5 m
539 wide to match closely the experimental setup (CHANSON, 2010c, 2011b). The numerical domain was
540 slightly shorter than the experimental channel to save computing cost and to have the inflow condition
541 generated by the SEM propagates on a smaller distance (section II.3.2). The domain was 0.5 m high to
542 avoid water from leaving the numerical domain through the top boundary during the splash happening
543 when the flow runs up the downstream gate. The bed and lateral walls were set with a no-slip boundary.
544 Water and air filled the domain (Fig. 19). The viscosities of air and water were set as in the 2D validation
545 section. The channel inflow continuously injected water between $z = 0$ and d_0 at a velocity V_0 in
546 simulations with uniform inflow velocity (i.e. ond2D, rad2D, ond3D and rad3D, see Table3). For the
547 simulations with inflow turbulence (i.e. ond3DSEM and rad3DSEM, see Table3), a synthetic turbulent
548 inflow condition (section II.3.2) was used at $x = 10$ m to recreate a turbulent boundary layer based upon
549 the experimental observations on the channel centreline at $x = 7.2$ m upstream of the gate. For all the
550 simulations, the remaining inflow condition was set with a no-slip boundary. The top of the domain was
551 set with a Neumann condition and an absorption layer to control any spurious velocities. The absorption
552 layer was a 0.15 m zone located beneath the top boundary with a smaller permeability than the air set to
553 $K = 10^{-5} \text{ m}^2$. For 3D simulations with inflow turbulence (ond3DSEM and rad3DSEM), the outflow
554 boundary at $x = 0$ m was set with a Neumann condition before the bore generation. In order to generate
555 the bore, the outflow boundary was then closed between $z = h_g$ to 0.5 m with a no slip boundary keeping
556 a Neumann condition between $z = 0$ m to h_g . The numerical details of the computations are summarised
557 in Table 4, including the computational times.

558

559 **IV.1.2) Comparison with experimental results for the 3D numerical study**

560 The steady flow conditions of the experiment were first reproduced in the simulation rad3DSEM using
561 the SEM method configured with the mean and RMS velocity profile measured in the hydraulic channel
562 (CHANSON, 2011b). The flow was injected in the numerical domain with an average discharge of
563 $0.0197 \text{ m}^3 \cdot \text{s}^{-1}$ (CHANSON, 2011b). Figure 20 presents dimensionless vertical profiles of the simulated
564 steady flow conditions, in terms of mean longitudinal velocity and RMS velocity, compared to the
565 experiment results (CHANSON, 2011b). In the numerical simulation, the developing boundary layer
566 presents a vertical profile for the longitudinal velocity similar to the one measured in the experiment,
567 with an average error of 2.7%. However, the turbulent normal stresses were largely underestimated by
568 the simulation (Fig. 20). This was expected since the simulations used experimental data measured at x
569 $= 7.2 \text{ m}$ and injected the value at $x = 10 \text{ m}$ in the numerical domain, then compared again at 7.15 m ,
570 leading to some discrepancies (SIMON, 2014). Note that the value of the RMS for the experiments
571 (CHANSON, 2011b) were unusual and did not follow the classical decrease of the fluctuations with the
572 distance from the bed as mentioned by NEZU and NAKAGAWA (1993) or measured in other
573 experiments in hydraulic channel (KOCH and CHANSON, 2008; CHANSON, 2010c). Nevertheless,
574 the SEM method made it possible to obtain a turbulent steady flow, which was the main objective to
575 this study.

576

577 *a) Free-surface description*

578 The bore's free surface evolution and characteristics were calculated and compared to experimental
579 measurements performed on the channel centreline at several distances from the gate (CHANSON,
580 2011b). Figure 21 presents the dimensionless time evolution of the bore's free surface at two distances
581 from the gate when measured in the simulations, the experiment and calculated using Equations (1) and
582 (2). Additionally, the bore celerity (U_b), wave amplitude (a_w), maximum water elevation (d_{\max}) and wave
583 period (T_w) of the bore are reported in Table 5. In Figure 21, the experimental data were synchronised
584 with the numerical simulation at $x = 7.15 \text{ m}$ only, as there was no recording of the exact instant of the
585 manual gate closure.

586 The bore passage is characterised by a sudden evolution of the free surface followed by secondary
587 undulations (Fig. 21). For the 3D simulations, the secondary undulations were mainly two dimensional
588 with little variations in the transverse direction. The free-surface time evolutions are in good agreement
589 between the numerical simulations, experiment and analytical values calculated with Equations (1) and
590 (2). For both 3D simulations, the bore conjugated depth (d_b), the first undulation maximum (d_{max}) and
591 the first undulation minimum (d_{min}) were within 2% of error with the experimental data, while both the
592 wave period (T_w) and wave amplitude (a_w) were simulated within 9% of error from the experimental
593 data. The bore celerity (U_b) was also within 1% of error as seen with the good synchronisation of the
594 bore propagation (Fig. 21). Overall, the simulation reproduced the free surface evolution with a very
595 good agreement.

596

597 *b) Velocity field evolution*

598 Velocity data from the simulations were compared to the physical experimental measurements
599 (CHANSON, 2011b) performed in the channel centreline at $x = 7.15$ m from the gate at several
600 elevations using an ADV with single run measurements. Fig. 22 presents the comparisons for the
601 numerical and experimental data measured at $z \approx 0.036$ m. The experimental velocity measurements are
602 presented with a moving average over 49 points (0.245 s) to display the data trend of the unfiltered ADV
603 signal that shows high frequency fluctuations and spikes. For completeness, these high-frequency
604 fluctuations measured with the ADV are not necessarily representative of the turbulence. ADV signal
605 outputs can record spikes (CEA et al., 2007) and finding the best filtering technique was not the objective
606 here. Moreover, the ADV measures punctual data at 200 Hz whereas the simulation models the
607 turbulence with a LES method which filters the turbulence in both space and time, hence the physical
608 high frequency fluctuations cannot be represented by the LES in terms of time measurements.

609 For the longitudinal velocity component u_x , the numerical data and experiments showed a similar trend
610 for the velocity evolution beneath the bore depending on the vertical elevation. For measurements at
611 $z/d_0 = 0.12$ (see SIMON and CHANSON, 2014) beneath the first crest (Fig. 22a), the longitudinal
612 velocity reached a value underestimated by approximately $0.16 \times V_0$ compared to the experimental data.
613 For other elevations, the difference in velocity values was smaller than $0.1 \times V_0$. A similar evolution was
614 observed beneath the following crests and troughs with a progressive de-synchronisation of the crests

615 and troughs with the experiment, as observed with the free surface measurements. Little differences
616 were found between the two- and three dimensional simulations.

617 The transverse velocities u_y from the three dimensional simulations were compared to the experimental
618 data. For the 3D simulation without inflow turbulence, the maximal variations were of magnitude 10^{-4}
619 $\times V_0$ (Fig. 22b). No significant fluctuations of the transverse velocity were expected for this simulation
620 since there was no initial turbulence in the flow and the data were measured in the channel centreline
621 for an undular wave with a two-dimensional shape. The experimental data showed transverse velocity
622 fluctuations of maximal magnitude up to $0.2 \times V_0$. For comparison, the transverse velocity fluctuations
623 for the 3D simulation with inflow turbulence were approximately $0.05 \times V_0$ (Fig. 22b).

624 For both the numerical simulations and experiments, the vertical velocity component u_z is found positive
625 and negative when the water level increases and decreases respectively. In agreement with the
626 experiment (Fig. 22c), the vertical velocity oscillation magnitudes were the smallest close to the bed and
627 the largest near the free surface.

628 Overall, the numerical results were in good agreement with the experimental results concerning both the
629 free surface and the three velocity component trends on the channel centreline.

630

631 *c) Comments on some limitations of the comparisons*

632 The comparison between numerical simulation results and experimental data showed some limitations.
633 The physical measurements were undertaken with an intrusive probe, i.e. an ADV, with a 1 cm diameter
634 rod and a 5 cm head. Its effects on the flow cannot be dismissed (SIMON and CHANSON 2013). Since
635 the flow was simulated without the presence of an ADV, this resulted in an incomplete reproduction of
636 the domain before bore generation. Future measurements with non-intrusive probes, e.g. PIV and LDV,
637 could be beneficial including giving access to a mapping of the flow hydrodynamics (e.g. PIV), although
638 the temporal resolution might not be the same.

639 Another shortcoming concerned the turbulent inflow conditions: the SEM created a different inflow
640 condition than the experiment due to the interpolation of experimental data measured only in the channel
641 centreline at $x = 7.2$ m and not in a whole channel transection. Since experimental data (i.e. mean and
642 RMS flow velocities) were not available at the channel intake, we choose to use the SEM data measured
643 at $x = 7.2$ m in the experiments and inject them in the numerical simulations in the inlet of the numerical

644 domain ($x = 10$ m). This resulted in a turbulence magnitude underestimated due to SEM, as JARRIN
645 (2008) reported a fast decay of the turbulence downstream the injection of the SEM data before it could
646 reach a stable value. For a better modelling of the turbulence, the SEM should use data measured at the
647 channel intake, when such data are available.

648 As for the comparison of the unsteady data between the experimental and numerical results, the
649 experimental data were based on a single bore generation with measurements solely in the channel
650 centreline. Comparison with ensemble statistics measured at several places across the channel would
651 therefore be necessary to perform a more detailed validation of the simulations.

652 In conclusion, we choose to keep in mind one objective of the study which is to compare the propagation
653 of bore against a steady flow with and without turbulence, using the SEM method.

654

655 **V) DISCUSSION ON 2D AND 3D RESULTS FOR UNDULAR BORES**

656 The initial conditions of the simulation are chosen from physical experiments for their similar bore
657 Froude numbers (Table 1). A key difference is the value of V_0 and the global dynamics of the flow after
658 the bore passage, i.e. the value V_b , if simplified as sketched in Fig. 3. For the case with the gate fully
659 closed ($h_g = 0$), V_b is thus zero, whereas, V_b is strictly negative when the gate is partially closed. In the
660 following, the characteristics of the simulated bores are detailed and compared first by looking at the
661 2D, 3D and 3DSEM numerical simulations with same initial velocities (V_0 ; V_b), then to one another.

662

663 **V.1) Flow pattern under undular bores – fully closed gate (FC)**

664 The results of simulations rad2D, rad3D and rad3DSEM (see Table 3 for the physical values and Table
665 4 for the numerical details) are discussed first. The propagation of the undular bore is illustrated by Fig.
666 23 showing, at two different times, contour maps of the free surface above d_0 for the 3D simulation with
667 inflow turbulence (i.e. rad3DSEM). The flow properties together with the free surface are displayed for
668 the 2D simulation (rad2D) in Figures 24, for 3D simulation (rad3D) in Figure 25 and for 3D simulation
669 with inflow turbulence (rad3DSEM) in Figure 26. In these figures, the zones of flow inversions are
670 enclosed by the black isolines $u_x = 0$. Starting with the free surface evolution, the shapes of the bore's
671 free surface for the two= and three=dimensional simulations were globally similar during the

672 propagation which was coherent with experiments. At gate closure, the flow impacted the gate without
673 splash. Within the first metre of propagation, the bore quickly took the form of an undular bore followed
674 by secondary undulations (Fig. 23). As the bore propagated, the bore front amplitude increased, while
675 smaller undulations appeared one after another at the wave train tail. The amplitude and wave length of
676 the secondary undulations were decreasing from the undulations front to the tail (Figs. 23 and 24).
677 Between the tail of the wave train and the gate ($x = 0$), the water level remained mostly unchanged
678 during the entire bore propagation; the variations of the water level were smaller than the mesh size
679 crossed by the air/water interface (at the interface $\Delta z \approx 1.1$ mm for rad2D and $\Delta z \approx 2:4$ mm for rad3D
680 and rad3DSEM). Moreover, for the simulations, the bore conjugate depths d_b were similar to the
681 experimental U_b and to the analytical value (see Table 5). The use of the third dimension showed the
682 apparition of small cross waves against the lateral walls initiated on the middle of the bore front (Fig.
683 23). Similar patterns were observed in the experiments, although not measured, and, for the simulation
684 rad3D, the cross waves formed a 10.5° angle with the walls and approximately a 7° angle for simulation
685 rad3DSEM. Overall, the three dimensional simulations are observed to keep a two dimensional aspect
686 but allows a more realistic description of the free surface evolution, with three-dimensional features.
687 Focusing now on the velocity field, it closely followed the free surface evolution during the bore passage
688 (Fig. 24, 25a and 26a). As the water level oscillates, the longitudinal velocity alternatively decelerates
689 and accelerates. Beneath the first crest, the longitudinal velocity changed direction flowing upstream on
690 the entire water column (contour line in Fig. 24, 25a and 26a). Beneath the first wave trough, the flow
691 direction changed again, flowing downstream except on a small zone. This zone was detached from the
692 bed and located between $z \approx 1$ to 3 mm for rad2D, $z \approx 2$ to 4 mm for rad3D and appearing between $z \approx$
693 0.5 to 15 mm for rad3DSEM. Altogether, the zone of velocity reversal was observed close to the bed
694 (dotted zone between $x = 4$ to 5 m in Fig. 24). Such a recirculation beneath the wave trough was not
695 measured nor observed in experimental undular bores, probably due to the small height of the area and
696 its proximity to the channel bed. Beneath the following secondary undulations, the longitudinal velocity
697 followed a trend similar to the one observed beneath the first wave crest and trough with a longitudinal
698 velocity flowing alternatively upstream and downstream but with a velocity range progressively
699 decreasing (Fig. 24, 25a and 26a). Nonetheless, after the second or third wave trough, the longitudinal

700 velocity was oriented upstream a few millimetres beneath the free surface of the wave troughs (isoline
701 $u_x = 0$ in Fig. 24, 25a and 26a).

702 The vertical velocity followed the evolution of the free surface as observed in previous physical studies
703 (CHANSON, 2011b; SIMON and CHANSON, 2014). The vertical velocity component u_z was globally
704 positive and negative when the water level increased and decreased respectively (Fig. 24, 25c and 26c),
705 i.e. the trend of u_z globally followed the time derivative of the free surface evolution as predicted by the
706 ideal fluid flow theory. No fluctuation appeared for the 2D and 3D simulations (rad2D and rad3D) (Figs.
707 24 and 25c), whereas the 3D results with inflow turbulence presented fluctuations in both steady and
708 unsteady flows (Fig. 26).

709 The transverse velocity component u_y was zero in most part of the domain for the 3D simulation rad3D
710 except at the corner of the lateral walls and in the vicinity the bore's free surface (Fig. 25b slices 0.01
711 and 0.49 m). For the 3D simulation with inflow turbulence (rad3DSEM), the velocity fluctuations during
712 the unsteady flow remained within the same intensity range as for the steady flow (up to $0.05 \times V_0$) but
713 covered wider areas beneath the bore (Fig. 26b).

714 Looking more into details at the flow evolution beneath the bore crest, strong flow reversals were
715 observed close to the bed and near the free surface (Figs. 24, 25a and 26a). At the flow interface of the
716 bore crest, the flow reversal for u_x was up to $1.7 \times V_0$ for the 2D and 3D simulations, with larger values
717 on the corner of the free-surface and the lateral walls (red zones in Figs. 25a and 26a). Near the bed, a
718 flow reversal with an intensity of 0.9 to $1.1 \times V_0$, with a variable height in the 3D simulation with inflow
719 turbulence due to the turbulence in the steady flow (Figs. 24, 25a and 26a). The flow reversal on the
720 channel centreline of 2D simulation rad3D and 2D simulation rad2D were similar. The zone of flow
721 reversal for the 3D simulation with inflow turbulence (rad3DSEM) was more irregular (black lines
722 beneath crests in Figs. 25a and 26a). Near the lateral wall, a strong flow reversal took place during the
723 bore front passage at 3 mm from the walls. Below the other secondary oscillations, a similar pattern took
724 place with velocity magnitudes progressively decreasing (Figs. 24, 25a and 26a).

725 The flow evolution between 3D simulations (rad3D and rad3DSEM) presented another difference: a
726 zone of flow reversal was observed between the gate and the tail of the secondary undulations at a
727 distance of approximately $3/10 \times W$ (with $W = 0.5$ m being the channel width) from both laterals walls,

728 and beneath $z = 0.6$ m for 3D simulation rad3DSEM (between $x = 0$ and 3.5 m in Fig. 26a), whereas the
729 flow was mainly negative and two dimensional in the 3D simulation rad3D (Fig. 25a).
730 Overall, the flow evolution in the 2D simulation and on the channel centreline of 3D simulation without
731 inflow turbulence presented similar flow characteristics. All the simulations, including 3D with inflow
732 turbulence, showed zones of intense flow reversal taking place during the bore passage, beneath the
733 wave crests. The 3D simulations gave access to the flow evolution near the wall, and the use of a
734 turbulent inflow condition (i.e. rad3DSEM) allowed a more complete description of the unsteady flow
735 motion.

736

737 **V.2) Flow pattern – partially closed gate (PC)**

738 The results of 2D and 3D simulations ond2D, ond3D and ond3DSEM (Table 1) are detailed here. Figure
739 27 presents the propagation of the undular bore for the 3D simulations with inflow turbulence at two
740 different times by focusing on the free-surface. The flow evolution is displayed for the 2D simulation in
741 Fig. 28, for 3D simulation in Fig. 29 and for 3D simulations with inflow turbulence in Fig. 30. The
742 regions of flow reversal are enclosed by black isolines $u_x = 0$. The bore propagation in the simulations
743 was similar to the experiments on positive surges (CHANSON, 2010b). As the flow impacted the gate,
744 a splash occurred with some air bubbles entrained below the gate. The water accumulating against the
745 gate remained chaotic and bubbly during the first metre of propagation (Fig. 28). Then the unsteady free
746 surface became smooth and propagated as an undular bore. As it propagated, more secondary
747 undulations appeared. For three-dimensional simulations, small whirlpools appeared at the corners of
748 the lateral walls and at the gate (mostly spinning with the centreline-gate-wall direction). The mean
749 average water depth near the gate slightly increased by 2 to 3 cm as the bore propagated between 2 to 8
750 m from the gate. From a secondary undulation to another, both the wave amplitude and the wave length
751 decreased from front to wave tail (Figs. 27 and 28). The bores propagated at a celerity $U_b = 0.625$ m.s⁻¹
752 in 2D simulations (ond2D), 0.626 m.s⁻¹ in 2D simulations (ond3D) and 0.640 m.s⁻¹ in 3D simulations
753 with inflow turbulence (ond3DSEM), with the bore Froude numbers of $Fr = 1.25$, $Fr = 125$ and $Fr =$
754 1.27 respectively. Hence, the bore propagated faster for 3D simulation case with inflow turbulence in
755 the initially steady flow. The 3D simulations (ond3D and ond3DSEM) showed the presence of cross-
756 waves at the bore front, similarly to physical observations (MONTES and CHANSON, 1998; KOCH

757 and CHANSON, 2008). The cross-waves deformed the shape of the secondary undulations (Fig. 27)
758 whereas the 2D simulation (ond2D) presented regular smooth shaped undulations (Fig. 28).

759 Overall, the three dimensional simulations presented a more complex free surface and velocity field than
760 the two dimensional simulation for this set of initial configuration (d_0 , V_0 , h_g). The longitudinal velocity
761 component u_x decelerated beneath the crests and re-accelerated beneath the troughs (Figs. 28, 29a and
762 30a). Beneath the bore crest, the water continuously flowed downstream, except close to the bed: i.e.
763 for $z < 20$ mm for ond2D, for $z < 15$ mm for ond3D and for $z < 35$ mm for ond3DSEM (Figs. 28 and
764 red zones in Fig. 29a and 30a). A flow reversal also took place within approximately 5 mm from the
765 lateral walls. Beneath the first wave crest of the bore, the maximum velocity reversal in the recirculation
766 reached up to $0.84 \times V_0$ ($u_x = 0.7 \text{ m.s}^{-1}$) in the 2D simulation (ond2D), $0.54 \times V_0$ (0.45 m.s^{-1}) for the 3D
767 simulation (ond3D) and 0.48 to $0.72 \times V_0$ (0.4 to 0.6 m.s^{-1}) in the 3D simulation with inflow turbulence
768 (ond3DSEM). Similar recirculation was observed during experiments on undular bores (RYABENKO,
769 1998) and for breaking bores (KOCH and CHANSON, 2008), but not specifically for the experimental
770 study (CHANSON, 2010c) that the simulation configuration was chosen from. Downstream of the
771 velocity reversal, the velocity fluctuations appeared in the 2D and 3D simulations. In addition to the
772 flow reversal next the bed and walls, a strong flow deceleration took place 1 cm beneath the free-surface
773 crest with the longitudinal velocity component u_x reaching $\approx 0.1 \text{ m.s}^{-1}$. Note that the flow patterns were
774 different from those in the FC simulations (rad2D/3D/3DSEM), where the longitudinal velocity
775 completely changed direction between crests and troughs (section V.1).

776 In terms of the vertical velocity component, u_z was globally positive and negative as the water level
777 increased and decreased respectively (Figs. 28, 29c and 30c). Close to the bed, the fluctuations induced
778 sporadic vertical velocity values down to $\approx 0.4 \text{ m.s}^{-1}$ or up to 0.6 m.s^{-1} (≈ 0.5 to $0.7 \times V_0$) for the 2D
779 simulations (ond2D) and smaller values were reached $0.12 \times V_0$ for the 3D simulations (ond3D) ($\approx \pm 0.1$
780 m.s^{-1}) and $0.24 \times V_0$ for the 3D simulations with inflow turbulence (ond3DSEM) ($\approx \pm 0.2 \text{ m.s}^{-1}$). It is
781 conceivable that the 2D simulation overestimated the vertical velocity due to a two dimensional
782 confinement.

783 The transverse velocity component u_y in 3D simulations fluctuated largely after the bore passage
784 particularly close to the bed and lateral walls, downstream of the longitudinal velocity reversal. For
785 simulation with inflow turbulence (ond3DSEM), u_y fluctuated with values of magnitudes up to $0.1 \times V_0$

786 at a depth $z = 6.3$ mm. Looking at the transverse velocity variations downstream the flow reversal, the
787 successive positive and negative values of u_y indicated the generation of coherent structures which were
788 smaller near the sidewalls than near the channel centreline (Figs. 29b and 30b).

789 Concerning the apparition of coherent structures near the bed, the 2D simulation (ond2D) presented
790 velocity fluctuations with stronger intensity than the 3D simulations (ond3D and ond3DSEM). This
791 could be an effect of the fluctuations developing only in a two dimensional domain. For the 3D
792 simulations, the inflow turbulence in ond3DSEM seemed to have an effect on the flow velocity
793 particularly beneath the bore front. The velocity fluctuations tended to move higher in the water column
794 than in absence of inflow turbulence. In the 3D simulation ond3D, the zone of flow reversal beneath the
795 crest was mainly two dimensional over the channel width, whereas the flow reversal zone was strongly
796 deformed by the initial turbulence for ond3DSEM.

797 Overall, the bore passage induced a strong flow reversal near the bed and generated fluctuations that
798 were not observed in the bore presented in section (V.1). For the 2D simulation, the intensity of the
799 fluctuations was overestimated showing that three dimensional simulations were required. The use of
800 the third dimension allowed modelling of the turbulence effects in the steady flow with the SEM. The
801 steady flow turbulence might have an effect on bore celerity and induce a more turbulent flow after the
802 bore passage. Moreover, the 3D simulations reproduced the effect of the cross-waves also observed in
803 experiments.

804

805 **V.3) Discussion on the turbulence in undular positive surges**

806 Different inflow-bore interactions were observed depending on the flow conditions, i.e. the initial steady
807 flow, with or without SEM addition, and the bore generation parameters, d_0 , V_0 , h_g . For the simulations
808 ond2D/3D/SEM, a flow detachment was observed in the wake of the flow reversal near the bed, thus
809 creating coherent turbulent structures, whereas, for the simulations rad2D/3D/SEM, a flow reversal
810 occurred on the whole water column without the turbulent structures. For the simulation ond2D in
811 particular, the coherent structures appeared with a frequency $f = 10.5$ Hz as the bore propagated. For the
812 3D simulations, a frequency could not be calculated since small structures appeared one next to the other
813 towards the transverse direction and no distinct recurring pattern seemed to appear. An association of
814 the shape of the zone of flow reversal, given by the black lines in Figs. 28, 25a and 26a, could be made

815 with bumps on a flat plate (MARQUILLIE and EHRENSTEIN, 2003). The flow reversal zone created
816 a downstream moving flow detachment similar to what can be observed in studies with a bump on a flat
817 plate. However, for flow detachments downstream a bump, a reattachment of the flow occurs
818 downstream the bump, whereas in positive surges, the generated detachments move upward in the water
819 column, a motion possibly induced by the secondary undulations. The patterns observed for undular
820 bores were also different than for the 2D case of breaking bore presented by LUBIN et al.(2010b). For
821 the breaking bore, larger structures were formed near the bed, downstream the bore front and ejected in
822 the flow. However, the simulation of the breaking bore was in two dimension and the present study
823 showed large differences in velocity intensities in the ejected eddies between two dimensional and three
824 dimensional simulations (cases ond2D and ond3D).

825 The use of the SEM showed that the initial steady flow turbulence was not responsible for the turbulence
826 generated downstream the flow reversal. The apparition of coherent turbulent structures was rather a
827 consequence of the choice of the flow conditions for which, in some simulations, a zone of flow reversal
828 associated with a strong shear appeared. For both cases, the Froude number was relatively similar (1.13
829 and 1.25), but the turbulent processes associated with the undular bore passage were completely
830 different.

831

832 **VI) DISCUSSION COMPARED TO RECENT RESULTS - CHALLENGES AND** 833 **PERSPECTIVES TOWARDS FULL SCALE NATURAL CONFIGURATIONS**

834 KEYLOCK (2005) discussed the potential applications of the LES for fluvial geomorphology studies
835 and presented the large interest in accessing a lot of information for small details in the case of highly
836 variable bathymetries, considering zones of different roughness, as well as configurations involving
837 meanders or confluences, and even when dealing with the presence of hydraulic structures or obstacles
838 is needed, numerical simulation provides information on the dynamics of large scales and their impact
839 on suspension and sediment mixing.

840 Very recent experimental results, using non-intrusive experimental techniques, can be highlighted and
841 compared to some of our conclusions. LIN et al. (2020a,b) highlighted the complexity of surges due to
842 dam-break generated undular bores, using high-speed particle image velocimetry (HSPIV) system. They

843 confirmed our numerical results by reporting that the maximum and minimum values for the horizontal
844 velocities were observed at the crest and trough phases, respectively, the vertical velocity profiles being
845 almost zero. On the contrary, the maximum and minimum vertical velocities are observed at the
846 ascent/descent phases. THOMAS and DAVID (2022) also used a non-intrusive experimental technique
847 (particle image velocimetry - PIV). They studied an undulating bore, partially breaking at the leading
848 wave. They noted that a significant effect was the thickening of the boundary layer after the jump front
849 and observed a negative velocity under the jump. They were also able to identify vortices interacting
850 with the roller front, these vortices would eventually descend into the main stream. They accelerate and
851 small structures are invading the entire flow, establishing a connection with the boundary layer,
852 confirming the potential of sediment suspension and advection when undular bores propagate upstream
853 rivers. We were able to observe such a dynamic, as shown in Figs. 32 A & B, where coherent structures
854 are observed to rise in the water column from the boundary layer, as the bore front propagates.
855 BARRANCO and LIU (2021) also studied experimentally dam-break generated bores, using a high-
856 speed particle image velocimetry system. They investigated the dependency of inundation depth, run-
857 up height and flood duration on the reservoir length and the bore strength at the beach toe. They noted
858 that the scale effects between large-scale and small-scale experiments are insignificant, due to Reynolds
859 and Froude numbers consideration. They suggested that their results are thus applicable to ‘real world’
860 conditions. Later, the same authors (BARRANCO and LIU, 2023) used a wave-maker to generated the
861 bores and presented similar free-surface profiles and velocity field measurements than those discussed
862 in the present study.

863 Whether the studies are carried out with physical modelling in laboratories or numerically, there will
864 always be the question of representativeness, i.e. boundary conditions, validation, geometric
865 assumptions, scale effects. Even *in situ* measurements suffer some limitations for generalisation. As
866 discussed in the introduction, field studies are often dependent on when the measurements are made
867 (tide conditions, weather conditions, including rain and wind, sudden climatic events, floods, drought,
868 etc.) or on the location (particular bathymetry, specific flow condition due to the presence of an island
869 or a pontoon, etc.). Many technical limitations are also to be deployed, as it is extremely rare to have
870 access to all the planned instrumentation, or even to be able to deploy it adequately or effectively. It

871 often happens that, on a scheduled survey, the planned data is also incomplete (failures, measurement
872 interruptions, etc.).

873 Altogether, some questions need to be clarified concerning the characterisation of the unsteady flow
874 motion when looking at the field observations only: how can a tsunami-like bore (TB) be reproduced in
875 laboratories to obtain an accurate physical modelling of the bore passage? What are the effects of the
876 tidal rise, the estuary shape or the bathymetry on the bore which is only the front of the tide? Is there a
877 unique simplification of the TB flow, and are all geophysical TBs comparable? Is it possible to simplify
878 the natural flow as a physical model and is the outcome still comparable to the prototype flow? When
879 modelling the general features of the flow, the initial and boundary conditions (geometric, kinematic
880 and dynamics parameters) are of paramount importance, and their selection is governed by non-
881 dimensional numbers ensuring analogy (complete or not). While MADSEN et al. (2008) addressed some
882 of these questions, turbulence was not taken in account in the discussion, so far.

883 However, it has to be emphasised that detailed numerical simulations of tidal bores in full scale rivers
884 are not yet possible to perform for a study of flow turbulence. This is in part due to lack of data (such as
885 detailed river bathymetry or complete flow hydrodynamics for the boundary and initial conditions to
886 perform numerical simulations) and the numerical cost of such simulations. BONNETON et al. (2011a)
887 experimentally showed, from field data, the significant cross-section variability of undular bores in
888 contrast to what is observed in existing rectangular channel experiments, which has also been confirmed
889 by KOBAYASHI and UCHIDA (2022) who showed the strong variability of the Froude number when
890 bores are flowing through an experimental meandering channel, yet considering a constant cross-
891 section. Moreover, the parameters defining the intensity of a tidal bore can be complex, with rapid local
892 variability (BONNETON et al., 2015), but these parameters do not encompass the turbulent processes
893 which are even more unsteady (not the same time and spatial scales of interest). As shown in this
894 numerical study, similar Froude numbers can lead to some different turbulent flows, which is driven by
895 the Reynolds number associated to local scales and may greatly vary all along the propagation of a bore
896 upstream a river. Thus, numerical simulations of natural systems require the ability to model intricate
897 domains such as open channels with curvature, sharp-bends and channel branching (NACHBIN and
898 SIMOES, 2012), as well as non-uniform channels with arbitrary cross-sections (WINCKLER and LIU,
899 2015; KOBAYASHI and UCHIDA, 2022).

900 When an undular tsunami bores propagate upstream along an estuarine zone, the first few wave crests
901 are much higher than the conjugate water elevation (BENJAMIN and LIGHTHILL 1954, PEREGRINE
902 1966) and river bank overtopping and flooding may occur. The presence of secondary waves results in
903 rapid and more frequent pressure fluctuations and higher loads on man-made structures such as bridge
904 piers, jetty piers, and lock gates (TRESKE, 1994). In the case of navigation channels, ships and barges
905 are adversely hindered during manoeuvre, as well as during loading/unloading of cargo. High mooring
906 forces might result for ships breaking up their mooring, as well documented in the Qiantang and Seine
907 Rivers (MALANDAIN 1988, CHANSON 2011).

908 However, even if full scale rivers are not yet possible to consider numerically, the consideration of more
909 complicated geometrical channel configurations is needed. In trapezoidal channels, the bore propagation
910 becomes three-dimensional (SANDOVER and ZIENKIEWICZ 1957, ZIENKIEWICZ and
911 SANDOVER 1957) (Fig. 31). The bore celerity is smaller, with a higher water surface elevation and
912 "fishtail" waves (BENET and CUNGE 1971, SANDOVER and TAYLOR 1962, VIOLEAU 2022). The
913 resulting effect is a lesser freeboard, with a higher risk of river bank overtopping (TRESKE, 1994) (Fig.
914 32A) and the drownings of individuals standing on the river banks, as well-documented in the Seine and
915 Qiantang River (MALANDAIN 1988, PAN and CHANSON 2015). Physical measurements showed a
916 complicated transient motion down the transverse slopes underneath the leading edge of the undular
917 bore (SANDOVER and TAYLOR 1962, KIRI et al. 2022a,b). These studies highlighted a 3D unsteady
918 flow motion, with an intense transient recirculation next to the invert at the base of the transverse slope
919 and in the shallow flow zones, associated with intense secondary currents on the transverse slope during
920 a relatively short period corresponding to the passage of the bore front and secondary waves
921 (FERNANDO et al. 2020, KIRI et al. 2022a) (Fig. 32B). This was numerically confirmed by
922 CHASSAGNE et al. (2019).

923 Another major challenge concerns the aeration in bores. While the above development mostly focused
924 on undular tsunami bore (Fig. 5a), a breaking tsunami bore is characterised by very turbulent transient
925 front with a marked roller (Fig. 5b). The strong turbulence induces rapid spatial and temporal
926 deformations of the roller free-surface, in response to the dual-interactions between entrained air and
927 vortical structures (WÜTHRICH et al., 2021). Recent physical experiments showed large void fraction
928 values in the bore's leading edge (LENG 2018, LENG and CHANSON 2019; SHI et al., 2023a,b). The

929 temporal evolution of vertical profiles of void fraction presented a rapid shift from convex to concave
930 shape (SHI 2022, SHI et al. 2023b). Depth-averaged void fractions across the roller height of 0.60 were
931 recorded in breaking bore roller, followed by an exponential decay in mean void fraction with time
932 (CHANSON 2022). The data implies a very rapid relative de-aeration of the roller region across the
933 upper flow region.

934 The presence of air in the breaking bore is of significance for several physical processes, including the
935 impact forces on man-made structures (e.g. bridges, jetties, groynes), the turbulent dissipation of bore
936 energy as well as heat and mass exchange (e.g. marine aerosols) from free-surface water. Air
937 entrainment, combined with debris transport and impact, will greatly affect the hydrodynamic loads
938 estimation when a bore impacts dykes, or even buildings when overtopping occurs. KRAUTWALD et
939 al. (2022) described the importance to connect the knowledge of broken-bore flows to design non-
940 elevated and elevated coastal structures, and to deepen insight into forces, overturning moments and
941 pressure distributions with a focus on the building's elevation above ground.

942

943 **CONCLUSION**

944 The objective of this paper was to detail the complicated flow structure when undular bores propagate
945 upstream a uniform flow in a rectangular channel.

946 We first compared and discussed the free-surface characteristics and the flow structures below the
947 waves, considering undular bores and weakly breaking bores, using different methods to generate bores
948 (dam-break, reflection wave due to an opposing flow, a partially-closed gate, or a fully-closed gate,
949 hydraulic jump). A detailed study using various initial flow conditions (V_0 , V_b) was proposed to
950 highlight the limits and possibilities of the considered model. The discussion concerned mainly the
951 longitudinal velocity component u_x which allowed to identify three scenarios:

- 952 1. a complete flow reversal, as the bore propagates upstream;
- 953 2. an oscillation of the longitudinal flow: u_x oscillates under the wave crests of the secondary wave
954 train.
- 955 3. no flow reversal, with the longitudinal velocity remaining in the same direction as the initial
956 flow.

957 The main finding was that, looking at bores in the frame of reference moving with V_0 and for a selected
958 Froude number, the hydrodynamics behavior in bores changes when the Reynolds number of the steady
959 flow becomes larger than a value close to 5×10^4 . Over that threshold, the hydrodynamics near the bed
960 changes significantly with occurrence of fluctuations and shedding of eddies which propagate upward
961 in the water columns. The most striking feature shown in this study is that undular and weakly breaking
962 bores, defined for the same Froude numbers, exhibited identical free surface evolutions, but the flow
963 structures were observed to be different, as summarized previously in the three different scenarios
964 sketched in figure 17.

965 Then, the numerical simulations of undular bores were performed by solving the Navier-Stokes
966 equations in two and three dimensions. Using physical laboratory data, unsteady inlet boundary
967 conditions were reconstructed thanks to the SEM method. Although the turbulent flow conditions
968 slightly differed, it is sought to be representative, considering the large CPU time cost. The simulations
969 compared positive surges propagating against a turbulent and non-turbulent steady flow, in order to see
970 the bore-turbulence interactions. The bore propagation against an adverse flow created a transient flow
971 reversal next to the bed and lateral walls of the channel. The results show that the flow reversal and its
972 turbulent wake differs pending upon the selection of initial turbulence conditions (SEM).

973 Then, the first 3D numerical simulations of undular bores were presented solving the Navier-Stokes
974 equations. Two dimensional and three dimensional simulations were compared. Even though the 2D
975 simulations followed the same trends as the 3D simulations, the complete detailed processes of bores
976 could only be accurately represented by 3D simulations since the 2D simulations seemed to overestimate
977 the velocity intensities in turbulent structures. Even if some limitations can be acknowledged, the flow
978 conditions are considered to be in a reasonably good agreement. In particular, the capacity of the
979 numerical model to reproduce cross-waves provides confidence in the numerical results. The use of
980 inflow turbulence (SEM) showed the importance of the initially-steady flow turbulence on the bore
981 properties. The goal of this work was not to assess the best method for inlet turbulence generation, but
982 rather to demonstrate the necessity to use turbulent inflow conditions and accurate thorough
983 experimental data, if possible, when turbulence processes are targeted by the numerical simulations.
984 This was confirmed by LENG et al. (2018) who showed, using the same numerical tool, the importance
985 to ensure some in-depth knowledge of the physical model, including its characteristics (channel

986 construction, gate closure mechanism and procedure, presence of joints or not, etc.) as well as its
987 instrumentation (sizes and positioning, sampling frequencies, etc.). The CFD validation can be highly
988 sensitive to any variations in the use of the experimental data.

989 Beneath the bore front, the flow velocity was observed to follow a similar evolution in all simulations.
990 However, the flow below the secondary undulations showed significant differences whether the steady
991 flow turbulence was introduced or not.

992 The two different initial conditions (with or without SEM) tested herein also resulted in significantly
993 different hydrodynamics processes during the bore propagation. This finding highlights the needs to
994 define which experimental models are closer to geophysical tsunami-like bores, since the variations of
995 the initial conditions induce drastic different unsteady flow evolutions. All the details presented,
996 concerning the three-dimensional hydrodynamics of the flow in the whole water column beneath the
997 bore front and the following wave train, are believed to be similar of tsunami-like bores, as discussed
998 by MADSEN et al. (2008). Altogether, the numerical simulations gave access to the 3D hydrodynamic
999 details, which highlighted the possible knowledge that can be transferred to the study of the dynamics
1000 of tsunamis propagating in rivers. Numerical simulations can thus be used in complement to existing
1001 experimental studies.

1002

1003 **ACKNOWLEDGMENTS**

1004 The authors wish to thank the Aquitaine Regional Council for the financial support towards a 512-
1005 processor cluster investment, located in the I2M laboratory. The first author was financially supported
1006 by the Aquitaine Regional Council and the University of Queensland. This work was granted access to
1007 the HPC resources of CINES, under allocation 2013-x2012026104 made by GENCI (Grand Equipement
1008 National de Calcul Intensif), and the computing facilities MCIA (Mesocentre de Calcul Intensif
1009 Aquitain) of the Universite de Bordeaux and of the Universite de Pau et des Pays de l'Adour. The authors
1010 also acknowledge the financial assistance of the Agence Nationale de la Recherche (Projet ANR
1011 MASCARET 10-BLAN-0911-01).

1012

1013 **DATA AVAILABILITY STATEMENT**

1014 Some or all data, or models that support the findings of this study are available from the corresponding
1015 author upon reasonable request.

1016

1017 **REFERENCES**

1018 ABBOTT, M.B., and RODENHUIS, G.S. (1972) A numerical simulation of the undular hydraulic jump.
1019 *Journal of Hydraulic Research* 10(3):239{257, DOI 10.1080/00221687209500160.

1020 ANDERSEN, V. (1978). "Undular hydraulic jump". *Journal of the Hydraulics Division-ASCE*
1021 104(8):1185{1188.

1022 AI, C., MA, Y., DING, W., XIE, Z., and DONG, G., (2021). "An efficient three-dimensional non-
1023 hydrostatic model for undular bores in open channels". *Physics of Fluids*, 33 (12): 127111.
1024 <https://doi.org/10.1063/5.0073241>.

1025 ARNASON, H., PETROFF, C., and YEH, H. (2009). "Tsunami bore impingement onto a vertical
1026 column." *Journal of Disaster Research*, Vol.4, pp. 391-403.

1027 BARDINA, J., FERZIGER, J., and REYNOLDS, W. C. (1980). "Improved subgrid-scale models for
1028 large-eddy simulation," in 13th Fluid and Plasma Dynamics Conference, Fluid Dynamics and Co-
1029 located Conferences (American Institute of Aeronautics and Astronautics, Snowmass, USA).

1030 BARRANCO, I., & LIU, P. L. F. (2021). "Run-up and inundation generated by non-decaying dam-
1031 break bores on a planar beach." *Journal of Fluid Mechanics*, 915, A81.

1032 BARRANCO, I., & LIU, P. L. F. (2023). "Inundation, runup and flow velocity of wavemaker generated
1033 bores on a planar beach." *Journal of Fluid Mechanics*, 959, A5.

1034 BARRE DE SAINT VENANT, A. (1871). "Théorie et équations générales du mouvement non
1035 permanent des eaux courantes." *Comptes rendus des séances de l'Académie des Sciences, Paris,*
1036 *France, Séance 17 Juillet 1871, Volume 73, pages 147-154.*

1037 BARTSCH-WINKLER, S., AND LYNCH, D.K. (1988). "Catalog of worldwide tidal bore occurrences
1038 and characteristics". USGS Numbered Series Ci no. 1022, U.S. Government Printing Office.

1039 BENET, F. and CUNGE, J. A. (1971). "Analysis of experiments on secondary undulations caused by
1040 surge waves in trapezoidal channels." *Journal of Hydraulic Research*, Vol. 9, No. 11, pp. 11-33.

1041 BENJAMIN, T.B., and LIGHTHILL, M.J. (1954). "On Cnoidal Waves and Bores." Proc. Royal Soc. of
1042 London, Series A, Math. & Phys. Sc., Vol. 224, No. 1159, pp. 448-460.

1043 BERCHET, A., SIMON, B., BEAUDOIN, A., LUBIN, P., ROUSSEAU, G., and HUBERSON, S.
1044 (2018). "Flow fields and particle trajectories beneath a tidal bore: A numerical study." International
1045 Journal of Sediment Research, Vol. 33, pp. 351-370.

1046 BJØRNESTAD, M., KALISCH, H., ABID, M., KHARIF, C., & BRUN, M. (2021). "Wave Breaking
1047 in Undular Bores with Shear Flows." Water Waves, Vol. 3, pages 473–490.
1048 <https://doi.org/10.1007/s42286-020-00046-6>.

1049 BONNETON, P., VAN DE LOOCK, J., PARISOT, J.-P., BONNETON, N., SOTTOLICHIO, A.,
1050 DETANDT, G., CASTELLE, B., MARIEU, V., AND POCHON, N. (2011a). "On the occurrence of
1051 tidal bores - the Garonne River case." Journal of Coastal Research, Volume SI 64, pp 1462-1466.

1052 BONNETON, P., PARISOT, J.-P., BONNETON, N., SOTTOLICHIO, A., CASTELLE, B., MARIEU,
1053 V., POCHON, N. and VAN DE LOOCK, J. (2011b). "Large amplitude undular tidal bore
1054 propagation in the Garonne River, France." Proceedings of the 21st ISOPE Conference, 870-874,
1055 ISBN 978-1-880653-96-8.

1056 BONNETON, P., BONNETON, N., PARISOT, J.-P., and CASTELLE, B. (2015). "Tidal bore dynamics
1057 in funnel-shaped estuaries." J. Geophys. Res. Oceans, 120, 923– 941, doi:10.1002/2014JC010267.

1058 BONNETON, P., FILIPPINI, A. G., ARPAIA, L., BONNETON, N., AND RICCHIUTO, M. (2016).
1059 "Conditions for tidal bore formation in convergent alluvial estuaries." Estuarine, Coastal and Shelf
1060 Science, Volume 172, pp 121-127.

1061 BRÜHL, M., PRINS, P. J., UJVARY, S., BARRANCO, I., WAHLS, S., and LIU, P. L.-F. (2022).
1062 "Comparative analysis of bore propagation over long distances using conventional linear and KdV-
1063 based nonlinear Fourier transform." Wave Motion, Volume 111, 102905,
1064 <https://doi.org/10.1016/j.wavemoti.2022.102905>.

1065 CASTRO-ORGAZ, O., and CHANSON, H. (2020). "Undular and broken surges in dam-break flows: a
1066 review of wave breaking strategies in a Boussinesq-type framework." Environmental Fluid
1067 Mechanics, Vol. 20, No. 6, Review Article, pp. 1383-1416 (DOI: 10.1007/s10652-020-09749-3).

1068 CASTRO-ORGAZ, O., and CHANSON, H. (2022). "Free surface profiles of near-critical instabilities
1069 in open channel flows: undular hydraulic jumps." *Environmental Fluid Mechanics*, Vol. 22, No. 2-
1070 3, pp. 275–300 (DOI: 10.1007/s10652-021-09797-3).

1071 CEA, L., PUERTAS, J., and PENA, L. (2007). "Velocity measurements on highly turbulent free surface
1072 flow using ADV". *Experiments in Fluids*, Volume 42, Issue 3, pp. 333-348, DOI: 10.1007/s00348-
1073 006-0237-3.

1074 CHANSON, H. (2008). "Turbulence in positive surges and tidal bores. effects of bed roughness and
1075 adverse bed slopes. Department Technical Report CH68/08, School of Civil Engineering, The
1076 University of Queensland, Brisbane, Australia.

1077 CHANSON, H. (2009a). "Current knowledge in hydraulic jumps and related phenomena. a survey of
1078 experimental results." *European Journal of Mechanics - B/Fluids*, Volume 28, pages 191-210.

1079 CHANSON, H. (2009b). "An experimental study of tidal bore propagation: The impact of bridge piers
1080 and channel construction," Hydraulic Model Report CH74/09, School of Civil Engineering, The
1081 University of Queensland, Brisbane, Australia.

1082 CHANSON, H. (2009c). "An experimental study of tidal bore propagation: The impact of bridge piers
1083 and channel construction. Hydraulic Model Report CH74/09, School of Civil Engineering, The
1084 University of Queensland, Brisbane, Australia.

1085 CHANSON, H. (2010a). "Undular tidal bores: basic theory and free-surface characteristics," *Journal of*
1086 *Hydraulic Engineering*, ASCE, Vol. 136, pp. 940-944.

1087 CHANSON, H. (2010b). "Unsteady turbulence in tidal bores: effects of bed roughness". *Journal of*
1088 *Waterway, Port, Coastal, and Ocean Engineering*, ASCE, Volume 136, Issue 5, pages 247-256, DOI
1089 10.1061/(ASCE)WW.1943-5460.0000048.

1090 CHANSON, H. (2010c). "Unsteady turbulence in tidal bores: effects of bed roughness." *Journal of*
1091 *Waterway, Port, Coastal, and Ocean Engineering*, Volume 136, Issue 5, pp. 247-256, DOI
1092 10.1061/(ASCE)WW.1943-5460.0000048.

1093 CHANSON, H. (2011a). "Tidal Bores, Aegir, Eagre, Mascaret, Pororoca: Theory and Observations."
1094 *World Scientific*, Singapore, 220 pages (ISBN 9789814335416).

1095 CHANSON, H. (2011b). "Undular tidal bores: effect of channel constriction and bridge piers.
1096 Environmental Fluid Mechanics, Volume 11, Issue 4, pp. 385-404 (DOI 10.1007/s10652-010-9189-
1097 5).

1098 CHANSON, H. (2012). "Momentum considerations in hydraulic jumps and bores". Journal of Irrigation
1099 and Drainage Engineering, ASCE, Volume 138, Issue 4, pages 382-385, DOI
1100 10.1061/(ASCE)IR.1943-4774.0000409.

1101 CHANSON, H. (2022). "Unsteady air entrainment in dam break waves and bores: theoretical
1102 considerations." Proceedings of 23rd Australasian Fluid Mechanics Conference AFMC2022,
1103 Sydney, Australia, 4-8 December, Editors C. LEI, B. THORNER and S. ARMFELD, Paper
1104 AFMC2022-011, 8 pages.

1105 CHANSON, H., and TAN, K.K. (2010). "Turbulent Mixing of Particles under Tidal Bores: an
1106 Experimental Analysis." Journal of Hydraulic Research, IAHR, Vol. 48, No. 5, pp. 641-649 (DOI:
1107 10.1080/00221686.2010.512779 (ISSN 0022-1686).

1108 CHANSON, H., REUNGOAT, D., SIMON, B., and LUBIN, P. (2011). "High-Frequency Turbulence
1109 and Suspended Sediment Concentration Measurements in the Garonne River Tidal Bore." Estuarine
1110 Coastal and Shelf Science, Vol. 95, No. 2-3, pp. 298-306 (DOI 10.1016/j.ecss.2011.09.012) (ISSN
1111 0272-7714).

1112 CHANSON, H., LUBIN, P., and GLOCKNER, S. (2012). "Unsteady Turbulence in a Shock: Physical
1113 and Numerical Modelling in Tidal Bores and Hydraulic Jumps." in "Turbulence: Theory, Types and
1114 Simulation", Nova Science Publishers, Hauppauge NY, USA, Ed. R.J. MARCUSO, Chapter 3, pp.
1115 113-148 (ISBN 978-1-61761-735-5).

1116 CHANSON, H. and LUBIN, P. (2013). "Mixing and Sediment Processes induced by Tsunamis
1117 propagating Upriver" in "Tsunamis: Economic Impact, Disaster Management and Future
1118 Challenges." Nova Science Publishers, Hauppauge NY, USA, T. CAI Editor, Chapter 3, pages 65-
1119 102 (ISBN 978-1-62808-682-9) (ISBN 978-1-62808-686-7 ebook).

1120 CHASSAGNE, R., FILIPPINI, A., RICCHIUTO, M., & BONNETON, P. (2019). "Dispersive and
1121 dispersive-like bores in channels with sloping banks." Journal of Fluid Mechanics. Volume 870,
1122 pages 595-616. doi:10.1017/jfm.2019.287

1123 CHUGH, R.S. (1961). "Tides in Hooghly River". International Association of Scientific Hydrology
1124 Bulletin, Volume 6, Issue 2, pages 10-26, DOI 10.1080/02626666109493212.

1125 DHAMANKAR, N. S., BLAISDELL, G. A. and LYRINTZIS, A. S. (2018). "Overview of Turbulent
1126 Inflow Boundary Conditions for Large-Eddy Simulations." AIAA Journal, Volume 56, Issue 4, pp.
1127 1317-1334. DOI: 10.2514/1.J055528.

1128 DARCY, H. and BAZIN, H. (1865). "Recherches hydrauliques, 1^{ère} et 2^{ème} parties." (Imprimerie
1129 Impériales, Dunod, Paris, 1865).

1130 DOCHERTY, N. J. and CHANSON, H. (2012). "Physical modeling of unsteady turbulence in breaking
1131 tidal bores," Journal of Hydraulic Engineering, ASCE, Volume 138, pages 412-419.

1132 FALGOUT, R., JONES, J., and YANG, U. (2006). "The design and implementation of HYPRE, a
1133 library of parallel high performance preconditioners," in Numerical solution of partial differential
1134 equations on parallel computers, Lecture notes in computational science and engineering, Volume
1135 51 (Springer Berlin Heidelberg), pages 267-294.

1136 FERNANDO, R., LENG, X., and CHANSON, H. (2020). "On Unsteady Velocity Measurements and
1137 Profiling in Compression Waves in an Asymmetrical Trapezoidal Channel." Experimental Thermal
1138 and Fluid Science, Vol. 112, Paper 109986, 15 pages & 8 video movies (DOI:
1139 10.1016/j.expthermflusci.2019.109986).

1140 FILIPPINI, A. G., ARPAIA, L., BONNETON, P., and RICCHIUTO, M. (2019). "Modeling analysis of
1141 tidal bore formation in convergent estuaries," European Journal of Mechanics - B/Fluids, Volume
1142 73, pages 55-68.

1143 FURGEROT, L. (2014). "Hydrodynamic properties of tidal bore and its influence on sediment
1144 dynamics: Coupled approach in flume and in situ (Sée estuary, Mont Saint Michel bay)." PhD thesis,
1145 Université de Caen, France.

1146 FURGEROT, L., MOUAZE, D., TESSIER, B., PEREZ, L., and HAQUIN, S. (2013). "Suspended
1147 sediment concentration in relation to the passage of a tidal bore (See River Estuary, Mont Saint
1148 Michel Bay, NW France)". In: 7th International Conference on Coastal Dynamics, Arcachon, France

1149 FURGEROT, L., MOUAZÉ, D., TESSIER, B., PEREZ, L., HAQUIN, S., WEILL, P., & CRAVE, A.
1150 (2016). "Sediment transport induced by tidal bores. An estimation from suspended matter

1151 measurements in the Sée River (Mont-Saint-Michel Bay, northwestern France).” *Comptes Rendus*
1152 *Geoscience*, Volume 348, Issue 6, pages 432-441, <https://doi.org/10.1016/j.crte.2015.09.004>.

1153 FURUYAMA, S., and CHANSON, H. (2008). "A Numerical Study of Open Channel Flow
1154 Hydrodynamics and Turbulence of the Tidal Bore and Dam-Break Flows." Hydraulic Model Report
1155 No. CH66/08, Div. of Civil Engineering, The University of Queensland, Brisbane, Australia, May,
1156 88 pages.

1157 GODA, K. (1979). "A multistep technique with implicit difference schemes for calculating two- or
1158 three-dimensional cavity flows," *Journal of Computational Physics*, Volume 30, pages 76-95.

1159 HEBENSTREIT, G. (1997). "Perspectives on Tsunami Hazard Reduction. Observations, Theory and
1160 Planning." Kluwer Academic, Dordrecht, the Netherlands, 218 pages.

1161 HENDERSON, F.M. (1966). "Open Channel Flow." MacMillan Company, New York, USA.

1162 HORNING, H. G., WILLERT, C., and TURNER, S. (1995) "The flow field downstream of a hydraulic
1163 jump." *Journal of Fluid Mechanics*, Volume 287, pages 299-316.

1164 JARRIN N, BENHAMADOUCHE S, LAURENCE D, PROSSER R (2006). "A synthetic-eddy method
1165 for generating inflow conditions for large-eddy simulations. *International Journal of Heat and Fluid*
1166 *Flow*, Volume 27, Issue 4, pp. 585-593. DOI 10.1016/j.ijheatfluidflow.2006.02.006

1167 JARRIN, N. (2008). "Synthetic inflow boundary conditions for the numerical simulation of turbulence."
1168 PhD thesis, School of Mechanical, Aerospace and Civil Engineering, The University of Manchester,
1169 Manchester, UK.

1170 JIANG, H., WANG, L., LI, L., and GUO, Z. (2014). "Safety evaluation of an ancient masonry seawall
1171 structure with modified DDA method". *Computers and Geotechnics*, Volume 55, pages 277-289,
1172 DOI 10.1016/j.compgeo.2013.09.012.

1173 KALMBACHER, K. D., and HILL, D. F. (2015). "Effects of tides and currents on tsunami propagation
1174 in large rivers: Columbia River, United States." *Journal of Waterway, Port, Coastal, and Ocean*
1175 *Engineering*, 141(5), 04014046.

1176 KANG, S., LIGHTBODY, A., HILL, C., and SOTIROPOULOS, F. (2011). "High-resolution numerical
1177 simulation of turbulence in natural waterways." *Advances in Water Resources*, Volume 34, Issue 1,
1178 pp. 98-113, <https://doi.org/10.1016/j.advwatres.2010.09.018>.

1179 KATAOKA, I., (1986). "Local instant formulation of two-phase flow." International Journal of
1180 Multiphase Flow Volume 12, pages 745-758.

1181 KEEVIL, C.E., CHANSON, H., and REUNGOAT, D. (2015). "Fluid Flow and Sediment Entrainment
1182 in the Garonne River Bore and Tidal Bore Collision." Earth Surface Processes and Landforms, Vol.
1183 40, No. 12, pp. 1574-1586 (DOI: 10.1002/esp.3735).

1184 KEYLOCK, C.J., Hardy, R.J., Parsons, D.R., Ferguson, R.I., Lane, S.N., Richards, K.S. (2005). "The
1185 theoretical foundations and potential for large-eddy simulation (LES) in fluvial geomorphic and
1186 sedimentological research." Earth-Science Reviews, Volume 71, Issues 3–4, pp. 271-304,
1187 <https://doi.org/10.1016/j.earscirev.2005.03.001>.

1188 KIRI, U., LENG, X., and CHANSON, H. (2020a). "Transient Secondary Currents behind a
1189 Compression Wave in an Irregular Channel." *Environmental Fluid Mechanics*, Vol. 20, No. 4, pp.
1190 1053-1073 & 1 vide movie (DOI: 10.1007/s10652-020-09740-y).

1191 KIRI, U., LENG, X., and CHANSON, H. (2020b). "Positive Surge Propagating in an Asymmetrical
1192 Canal." *Journal of Hydro-environment Research*, IAHR, Vol. 31, pp. 41-47 & Supplementary
1193 material incl. 4 video movies (DOI: 10.1016/j.jher.2020.04.002).

1194 KHEZRI, N. (2014). "Modelling Turbulent Mixing and Sediment Process Beneath Tidal Bores: Physical
1195 and Numerical Investigations." Ph.D. thesis, School of Civil Engineering, The University of
1196 Queensland, Brisbane, Australia, 267 pages.

1197 KHEZRI, N. and CHANSON, H. (2012). "Undular and breaking bores on fixed and movable gravel
1198 beds." *Journal of Hydraulic Research*, IAHR, Volume 50, pages 353-363.

1199 KJERFVE, B. and FERREIRA, H. O. (1993). "Tidal bores: first ever measurements," *Cincia e Cultura*,
1200 Volume 45, pages 135-138 (1993).

1201 KOBAYASHI, D. & UCHIDA, T. (2022) Experimental and numerical investigation of breaking bores
1202 in straight and meandering channels with different Froude numbers, *Coastal Engineering Journal*,
1203 64:3, 442-457, (DOI: 10.1080/21664250.2022.2118431).

1204 KOCH, C., and CHANSON, H. (2008). "Turbulent Mixing beneath an Undular Bore Front." *Journal of*
1205 *Coastal Research*, Vol. 24, No. 4, pp. 999-1007 (DOI: 10.2112/06-0688.1).

1206 KOCH, C., and CHANSON, H. (2009). "Turbulence Measurements in Positive Surges and Bores."
1207 *Journal of Hydraulic Research*, IAHR, Vol. 47, No. 1, pp. 29-40 (DOI: 10.3826/jhr.2009.2954).

1208 KRAUTWALD, C., VON HÄFEN, H., NIEBUHR, P., VÖGELE, K., SCHÜRENKAMP, D., SIEDER,
1209 M., and GOSEBERG, N. (2022). "Large-scale physical modeling of broken solitary waves impacting
1210 elevated coastal structures", *Coastal Engineering Journal*, Vol. 64, pp. 169-189 (DOI:
1211 10.1080/21664250.2021.2023380).

1212 LAUT, L.L.M., FERREIRA, D.E.D.S., SANTOS, V.F., FIGUEIREDO JR, A.G., CARVALHO,
1213 M.D.A., and MACHADO, O.F. (2010). "Foraminifera, thecamoebians and palynomorphs as
1214 hydrodynamic indicators in Araguari Estuary, Amazonian Coast, Amapa State – Brazil". *Anuario do*
1215 *Instituto de Geociencias*, Volume 33, Issue 2, pages 52-65.

1216 LEMOINE, R. (1948). "Sur les ondes positives de translation dans les canaux et sur le ressaut ondulé
1217 de faible amplitude," *La Houille Blanche*, Volume 2, pages 183-185.

1218 LENG, X. (2018). "A Study of Turbulence: the Unsteady Propagation of Bores and Surges." Ph.D.
1219 thesis, School of Civil Engineering, The University of Queensland, Brisbane, Australia, 364 pages
1220 & 2 Digital Appendices (DOI: 10.14264/uql.2018.501).

1221 LENG, X., and CHANSON, H. (2019). "Air-Water Interaction and Characteristics in Breaking Bores."
1222 *International Journal of Multiphase Flow*, Vol. 120, Paper 103101, 17 pages (DOI:
1223 10.1016/j.ijmultiphaseflow.2019.103101).

1224 LENG, X., SIMON, B., KHEZRI, N., LUBIN, P., and CHANSON, H. (2018). "CFD Modelling of Tidal
1225 Bores: Development and Validation Challenges." *Coastal Engineering Journal*, Vol. 60, No. 4, pp.
1226 423-436 (DOI: 10.1080/21664250.2018.1498211) (ISSN 0578-5634).

1227 LIGGETT, J.A. (1994). "Fluid Mechanics." McGraw-Hill, New York, USA.

1228 LIN, C., KAO, M.J., YUAN, J.M., RAIKAR, R.V., WONG, W.-Y., YANG, J., YANG, R.Y. (2020a).
1229 "Features of the flow velocity and pressure gradient of an undular bore on a horizontal bed." *Physics*
1230 *of Fluids* 1 April 2020; 32 (4): 043603. <https://doi.org/10.1063/5.0001525>.

1231 LIN, C., KAO, M.J., YUAN, J.M., RAIKAR, R.V., HSIEH, S.C., CHUANG, P.Y., SYU, J.M., PAN,
1232 W.C. (2020b). "Similarities in the free-surface elevations and horizontal velocities of undular bores
1233 propagating over a horizontal bed." *Physics of Fluids*, 32 (6): 063605.
1234 <https://doi.org/10.1063/5.0010321>.

1235 LIU, H., SHIMZONO, T., TAKAGAWA, T., OKAYASU, A., FRITZ, H.M., SATO, S., and TAJIMA,
1236 T. (2013). "The 11 March 2011 Tohoku Tsunami Survey in Rikuzentakata and Comparison with
1237 Historical Events." *Pure and Applied Geophysics*, Vol. 170, pp. 1033-1046.

1238 LUBIN, P. (2004). "Large Eddy Simulation of plunging breaking waves". Université Sciences et
1239 Technologies - Bordeaux I. PhD thesis, in English.

1240 LUBIN, P. & GLOCKNER, S. (2015). "Numerical simulations of three-dimensional plunging breaking
1241 waves: generation and evolution of aerated vortex filaments." *Journal of Fluid Mechanics*, Vol. 767,
1242 pp. 364-393.

1243 LUBIN, P., GLOCKNER, S., and CHANSON, H. (2010a). "Numerical Simulation of a Weak Breaking
1244 Tidal Bore." *Mechanics Research Communications*, Vol. 37, No. 1, pp. 119-121 (DOI:
1245 10.1016/j.mechrescom.2009.09.008).

1246 LUBIN, P., CHANSON, H., and GLOCKNER, S. (2010b). "Large Eddy Simulation of Turbulence
1247 Generated by a Weak Breaking Tidal Bore." *Environmental Fluid Mechanics*, Vol. 10, No. 5, pp.
1248 587-602 (DOI: 10.1007/s10652-009-9165-0).

1249 MADSEN, P. A., SIMONSEN, H., and PAN, C.H. (2005). "Numerical simulation of tidal bores and
1250 hydraulic jumps". *Coastal Engineering*, Volume 52, Issue 5, pages 409-433 (DOI:
1251 10.1016/j.coastaleng.2004.12.007).

1252 MADSEN, P. A., FUHRMAN, D. R., and SCHÄFFER, H. A. (2008), "On the solitary wave paradigm
1253 for tsunamis." *J. Geophys. Res.*, 113, C12012, (DOI:10.1029/2008JC004932).

1254 MALANDAIN, J.J. (1988). "La Seine au Temps du Mascaret." ('The Seine River at the Time of the
1255 Mascaret.') *Le Chasse-Marée*, No. 34, pp. 30-45 (in French).

1256 MARCHE, C., BEAUCHEMIN, P., and KAYLOUBI, A.E. (1995). "Etude numérique et expérimentale
1257 des ondes secondaires de Favre consécutives à la rupture d'un barrage". *Canadian Journal of Civil
1258 Engineering*, Volume 22, Issue 4, pages 793-801, DOI 10.1139/195-089

1259 MARQUILLIE, M., and EHRENSTEIN, U. (2003). "On the onset of nonlinear oscillations in a
1260 separating boundary-layer flow". *Journal of Fluid Mechanics*, Volume 490, pp. 169-188, DOI
1261 10.1017/S0022112003005287.

1262 MONTES, J.S. (1998). "Hydraulics of Open Channel Flow." ASCE Press, New-York, USA, 697 pages.

- 1263 MONTES, J. S. and CHANSON, H. (1998). "Characteristics of undular hydraulic jumps: Experiments
1264 and analysis," *Journal of Hydraulic Engineering*, Volume 124, pages 192-205.
- 1265 MOORE, W.U. (1893). "Further report on the bore of Tsien-Tang-Kiang". Hydrographic Office,
1266 Admiralty, London.
- 1267 MOUAZE, D., CHANSON, H., and SIMON, B. (2010). "Field Measurements in the Tidal Bore of the
1268 Sélune River in the Bay of Mont Saint Michel (September 2010)." *Hydraulic Model Report No.*
1269 *CH81/10*, School of Civil Engineering, The University of Queensland, Brisbane, Australia, 72 pages
1270 (ISBN 9781742720210).
- 1271 NACHBIN, A., and SIMOES, V. S. (2012). "Solitary waves in open channels with abrupt turns and
1272 branching points". *J. Nonlinear Math. Phys.* 19 (1), 1240011 (doi: 10.1142/S1402925112400116).
- 1273 NAVARRE, P. (1995). "Aspects physiques du caractère ondulatoire du mascaret en Dordogne", D.E.A.
1274 thesis, Université de Bordeaux, France.
- 1275 NEZU, I., and NAKAGAWA, H. (1993). "Turbulence in open-channel flows." Balkema, Rotterdam;
1276 Brookfield.
- 1277 PAN, D.Z., and CHANSON, H. (2015). "Physical Modelling of Tidal Bore Dyke Overtopping:
1278 Implication on Individuals' Safety." *Proc. 36th IAHR World Congress*, The Hague, The Netherlands,
1279 27 June-3 July, Theme 4, pp. 3824-3831.
- 1280 PATANKAR, S. V. (1980). "Numerical heat transfer and fluid flow." Hemisphere Pub. Corp.; McGraw-
1281 Hill, Washington; New York.
- 1282 PEREGRINE, D.H. (1966). "Calculations of the development of an undular bore". *Journal of Fluid*
1283 *Mechanics*, Volume 25, Issue 2, pages 321-330, DOI 10.1017/S0022112066001678
- 1284 PUTRA, Y. S., BEAUDOIN, A., ROUSSEAUX, G., THOMAS, L., & HUBERSON, S. (2019). "2D
1285 numerical contributions for the study of non-cohesive sediment transport beneath tidal bores."
1286 *Comptes Rendus Mécanique*, Volume 347, Issue 2, pages 166-180,
1287 <https://doi.org/10.1016/j.crme.2018.11.004>.
- 1288 RAYLEIGH, L. (1908). "Note on tidal bores," *Proceedings of the Royal Society A: Mathematical,*
1289 *Physical and Engineering Sciences*, Volume 81, pages 448-449.

1290 REUNGOAT, D., CHANSON, H., and CAPLAIN, B. (2014). "Sediment Processes and Flow Reversal
1291 in the Undular Tidal Bore of the Garonne River (France)." *Environmental Fluid Mechanics*, Volume
1292 14, Issue 3, pages 591–616 (DOI: 10.1007/s10652-013-9319-y).

1293 REUNGOAT, D., LENG, X., and CHANSON, H. (2017). "Successive impact of tidal bores on
1294 sedimentary processes: Arcins channel, Garonne River." *Estuarine Coastal and Shelf Science*, Vol.
1295 188, pp. 163-173 (DOI: 10.1016/j.ecss.2017.02.025).

1296 ROUSE, H. (1938). "Fluid Mechanics for Hydraulic Engineers." McGraw-Hill Publ., New York, USA.

1297 ROY-BISWAS, T., DEY, S., & SEN, D. (2021). "Modeling positive surge propagation in open channels
1298 using the Serre-Green-Naghdi equations." *Applied Mathematical Modelling*, Volume 97, pages 803-
1299 820, <https://doi.org/10.1016/j.apm.2021.04.028>.

1300 ROY-BISWAS, T., & SEN, D. (2022). "Critical analysis of turbulence models for simulating positive
1301 surge waves in open channels in a RANS-VOF setup." *Environ Fluid Mech*. Volume 22, pages 1253–
1302 1281. <https://doi.org/10.1007/s10652-022-09889-8>.

1303 RULIFSON, R.A., and TULL, K.A. (1999) Striped bass spawning in a tidal bore river: The
1304 Shubenacadie Estuary, Atlantic Canada. *Transactions of the American Fisheries Society*, Volume
1305 128, Issue 4, pages 613-624, DOI 10.1577/1548-8659(1999)128<0613:SBSIAT>2.0.CO;2

1306 RYABENKO, A. (1998). "Representation of a wave jump and group of translation waves as a
1307 combination of a solitary wave and cnoidal waves". *Hydrotechnical Construction*, Volume 32, Issue
1308 5, pp. 246-252, DOI 10.1007/BF02918696.

1309 SAGAUT, P. (2006). *Large eddy simulation for incompressible flows: an introduction*, 3rd ed.
1310 (Springer-Verlag Berlin and Heidelberg, Berlin, Heidelberg, New York).

1311 SANDOVER, J.A., and TAYLOR, C. (1962). "Cnoidal waves and bores." *Journal La Houille Blanche*,
1312 No. 3, Sept., pp. 443-445.

1313 SANDOVER, J.A., and ZIENKIEWICZ, O.C. (1957). "Experiments on Surge Waves." *Water Power*,
1314 Vol. 9, Nov., p. 418-424.

1315 SHI, R. (2022). "Modelling Air-Water Turbulence and Properties in Unsteady Breaking Bore." Ph.D.
1316 Thesis, The University of Queensland, School of Civil Engineering, 286 pages (DOI:
1317 10.14264/7f692da).

1318 SHI, R., WÜTHRICH, D., and CHANSON, H. (2023a). "Air-water Properties of Unsteady Breaking
1319 Bores Part 1: Novel Eulerian and Lagrangian Velocity Measurements using Intrusive and Non-
1320 intrusive Techniques." *International Journal of Multiphase Flow*, Vol. 159 Paper 104338, 16 pages
1321 (DOI: 10.1016/j.ijmultiphaseflow.2022.104337).

1322 SHI, R., WÜTHRICH, D., and CHANSON, H. (2023b). "Air-water Properties of Unsteady Breaking
1323 Bore Part 2: Void Fraction and Bubble Statistics." *International Journal of Multiphase Flow*, Vol.
1324 159, Paper 104337, 14 pages (DOI: 10.1016/j.ijmultiphaseflow.2022.104337).

1325 SMAGORINSKY, J. (1963). "General circulation experiments with the primitive equations," *Monthly*
1326 *Weather Review*, Volume 91, pages 99-164.

1327 SIMON, B. (2014). "Effects of Tidal Bores on Turbulent Mixing: a Numerical and Physical Study in
1328 Positive Surges." Ph.D. thesis, School of Civil Engineering, The University of Queensland, Brisbane,
1329 Australia, 259 pages & 7 movies (DOI: 10.14264/uql.2014.19).

1330 SIMON, B., and CHANSON, H. (2013). "Turbulence Measurements in Tidal Bore-like Positive Surges
1331 over a Rough Bed." *Hydraulic Model Report No. CH90/12*, School of Civil Engineering, The
1332 University of Queensland, Brisbane, Australia, 176 pages.

1333 SIMPSON, J.H., FISHER, N.R., AND WILES, P. (2004). "Reynolds stress and TKE production in an
1334 estuary with a tidal bore". *Estuarine, Coastal and Shelf Science*, Volume 60, Issue 4, pages 619-627,
1335 DOI 10.1016/j.ecss.2004.03.006.

1336 SOARES FRAZAO, S. and ZECH, Y. (2002) "Undular bores and secondary waves -experiments and
1337 hybrid finite-volume modelling," *Journal of Hydraulic Research*, Volume 40, pages 33-43.

1338 STOKER, J. J. (1957). "Water waves: The mathematical theory with applications" (Interscience
1339 Publisher, Inc, New York).

1340 THOMAS, L., and DAVID, L. (2022). "Eulerian and Lagrangian coherent structures in a positive
1341 surge." *Experiments in Fluids*, 63, Issue 2, pages 1-16, <https://doi.org/10.1007/s00348-022-03383-z>

1342 TOLKOVA, E. (2018). "Observations of Tsunamis in Rivers. In: *Tsunami Propagation in Tidal Rivers.*"
1343 *SpringerBriefs in Earth Sciences*. Springer, Cham. https://doi.org/10.1007/978-3-319-73287-9_1

1344 TOLKOVA, E., TANAKA, H. & ROH, M. (2015). "Tsunami Observations in Rivers from a Perspective
1345 of Tsunami Interaction with Tide and Riverine Flow." *Pure Applied Geophysics*, Volume 172, pages
1346 953–968. <https://doi.org/10.1007/s00024-014-1017-2>.

1347 TRESKE, A. (1994) "Undular bores (Favre-waves) in open channels - experimental studies." Journal of
1348 Hydraulic Research, Volume 32, pages 355-370.

1349 VIOLEAU, D. (2022). "Contribution to the Theory of Undular Bores. A journey around the Korteweg-
1350 de Vries equation." IAHR Monograph, 96 pages.

1351 WINCKLER, P., and LIU, P. (2015). "Long waves in a straight channel with non-uniform cross-
1352 section". Journal of Fluid Mechanics, 770, pp. 156-188 (doi:10.1017/jfm.2015.147).

1353 WOLANSKI, E., WILLIAMS, D., SPAGNOLA, S., and CHANSON, H. (2004). "Undular Tidal Bore
1354 Dynamics in the Daly Estuary, Northern Australia." Estuarine, Coastal and Shelf Science, Vol. 60,
1355 No. 4, pp. 629-636 (ISSN 0302-3524).

1356 WÜTHRICH, D., SHI, R., and CHANSON, H. (2021). "Strong Free-Surface Turbulence in Breaking
1357 Bores: a Physical Study on the Free-Surface Dynamics and Air-Water Interfacial Features." Journal
1358 of Fluid Mechanics, Vol. 924, Paper A20, 37 pages & Cover page (DOI: 10.1017/jfm.2021.614).

1359 YE H., LIU, P., and SYNOLAKIS, C. (1996). "Long-wave Runup Models." World Scientific,
1360 Singapore, 403 pages.

1361 YE H., TOLKOVA, E., JAY, D., TALKE, S., FRITZ, H. (2012). "Tsunami Hydrodynamics in the
1362 Columbia River," Journal of Disaster Research, Volume7, Issue.5, pages 604-608. DOI:
1363 10.20965/jdr.2012.p0604.

1364 YOUNGS, D. L. (1982). "Time-dependent multi material flow with large fluid distortion," in Numerical
1365 methods for fluid dynamics, Conference series (Institute of Mathematics and Its Applications) (K.
1366 W. Morton, M. J. Baines, Academic Press, London, New York).

1367 ZIENKIEWICZ, O.C., and SANDOVER, J.A. (1957). "The Undular Surge Wave." Proc. 7th IAHR
1368 Congress, Lisbon, Portugal, Vol. II, Paper D25, pp. D1-11.

1369

Table 1 – Simplification of the flow dynamics for positive surges (see Fig. 3).

V_o	V_b	U_b	Applications	Abbreviations
0	>0	>0	Dam break wave	DB
<0	>0	>0	Tsunami bores, Tidal bores	OF / TB
<0	0	>0	Reflection wave on a fully-closed gate	FC
<0	<0	>0	Reflection wave on a partially-closed gate	PC
<0	<0	0	Stationary hydraulic jump	HJ

Table 2 – Numerical simulations initial parameters, $d_0 = 0.1m$. The names of each simulations indicates the initial Froude number value, the type of initial flow configuration (DB stands for dam break, see Table 1) and a number is given to distinguish bores of a similar type (OF1 and OF2, for example).

Fr	d_b (m)	Case	V_0 (m/s)	V_b (m/s)
1.1	0.1134	Fr1.1DB	0	0.1287
		Fr1.1OF1	-0.0429	0.0858
		Fr1.1OF2	-0.0858	0.0429
		Fr1.1FC	-0.1287	0
		Fr1.1PC1	-0.3465	-0.2178
		Fr1.1PC2	-0.5643	-0.4356
		Fr1.1PC3	-0.7821	-0.6534
1.2	0.1269	Fr1.2DB	0	0.2522
		Fr1.2OF1	-0.05	0.2022
		Fr1.2OF2	-0.2022	0.05
		Fr1.2FC	-0.2522	0
		Fr1.2PC1	-0.3022	-0.05
		Fr1.2PC2	-0.3522	-0.1
		Fr1.2PC3	-0.5522	-0.3
1.5	0.1679	Fr1.5DB	0	0.601
		Fr1.5OF1	-0.2003	0.4005
		Fr1.5OF2	-0.4005	0.2003
		Fr1.5OF3	-0.55	0.0508
		Fr1.5FC	-0.6008	0
		Fr1.5PC	-0.8978	-0.2970

Table 3 – List of numerical configurations used in the 3D numerical study, with their initial conditions and related experiments. ⁽¹⁾ stands for CHANSON (2010b); ⁽²⁾ stands for CHANSON (2011b)

Computational configuration	d_0 (m)	V_0 (m.s ⁻¹)	h_g (m)	Experimental run	Exp. Bore Froude Fr	Type of bore	2D / 3D	Inflow turbulence
Ond2D	0.1385	-0.830	0.1	080422 ⁽¹⁾	1.17	undular	2D	NO
Ond3D							3D	NO
Ond3DSEM							3D	YES
Rad2D	0.165	-0.230	0	090427 ⁽²⁾	1.13	undular	2D	NO
Rad3D							3D	NO
Rad3DSEM							3D	YES

Table 4 – Details of the domain meshes and CPU requirements for the simulations made on supercomputers JADE at CINES for the 3D simulations (Intel® Xeon® E5450 4C 3 GHz) and AVAKAS in MCIA for the 2D simulations (Intel® Xeon® X5675 3.06 GHz)

Name	Number of meshes	Number of processors	Number of iterations	Consumed CPU time (h)	Physical time (s)
Ond2D	5000 × 500	36	300,000	1,700	17.1
Ond3D	2,000 × 250 × 100	640	80,000	184,000	13.2
Ond3DSEM	2,000 × 250 × 100	640	95,000	245,000	23.2
Rad2D	5000 × 500	36	25,000	800	9.0
Rad3D	2,000 × 250 × 100	640	45,000	46,000	8.8
Rad3DSEM	2,000 × 250 × 100	640	60,000	230,000	39.4

Table 5 – Bore free surface patterns and characteristics for undular bores generated with a completely closed gate at $x = 7.15$ m (Experimental run 090427)

Results	Fr	U_b (m.s ⁻¹)	d_0 (m)	d_b/d_0	d_{max}/d_0	a_w/d_0	$T_w U_b/d_0$
Analytical solution	1.14	1.22	0.165	1.188	-	-	-
Experimental data (CHANSON 2011b)	1.13	1.21	0.165	1.200	1.303	0.103	8.067
2D simulation Fr1.1FC	1.14	1.23	0.165	1.206	1.327	0.115	7.901
3D simulation (no inflow turbulence) Fr1.1FC3D	1.14	1.22	0.165	1.176	1.312	0.112	7.634
3D simulation with inflow turbulence Fr1.1FC3DSEM	1.15	1.22	0.165	1.194	1.315	0.107	7.321

Fig. 1 - Sequence of a tidal bore propagating in the Dordogne River at Vayres, 2011-04-21 (Photos: B. Simon). The bore is undular with some breaking happening on the wave crest. Most surfers are riding the bore front wave. The sequence read from left to right with photos every 2 seconds.



Fig. 2 - Photography of an undular tidal bore and sketches of the two main shapes taken by positive surges: undular bore (1c) and breaking bore (1d). d_0 , d_b , V_0 , V_b are the water depths and the main current velocities respectively before (subscript 0) and after the bore passage (subscript b), U_b is the bore celerity. (Photos: B. Simon). (a) tidal bore arrival – (b) back side of a tidal bore – (c) undular bore – (d) breaking bore.

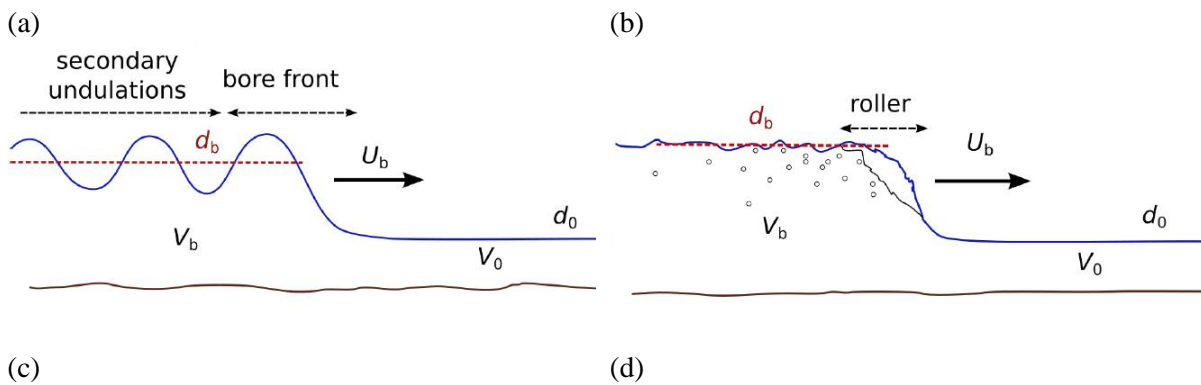

Fig. 3 – Definition sketch of TBs propagating from left to right for an observer standing still.

$d_b > d_0$, $U_b > 0$, $V_0 \leq 0$ whereas V_b is positive or negative.

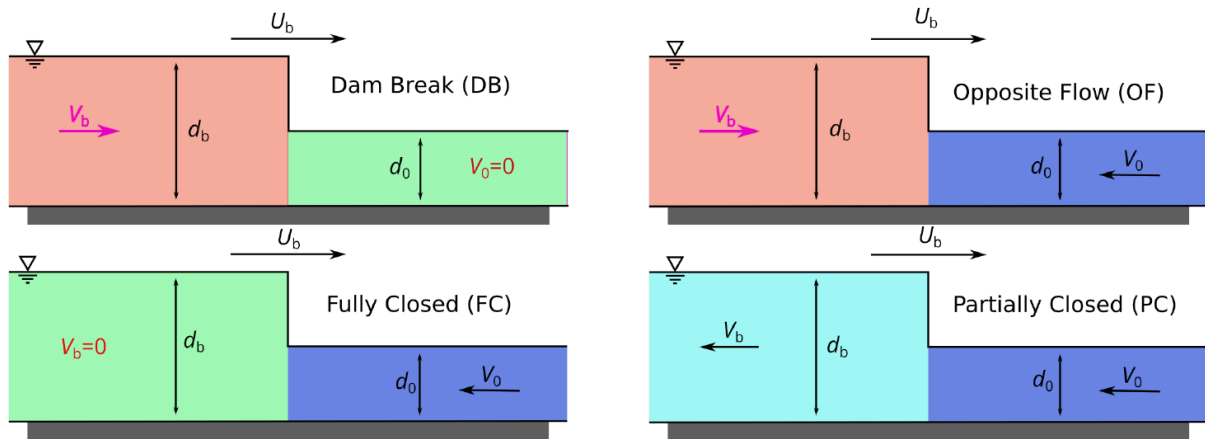

Fig. 4 - Bore generation by rapid Tainter gate closure, with upstream bore propagation from left to right
- $Q=0.0537 \text{ m}^3/\text{s}$, $d_o=0.114 \text{ m}$, $S_o=0.00773$, $h_g = 0.009 \text{ m}$, photographed between $x = 10.2$ to 11.15 m ,
with 192 ms between two successive frames (SIMON and CHANSON, 2013). A-B-C-D.

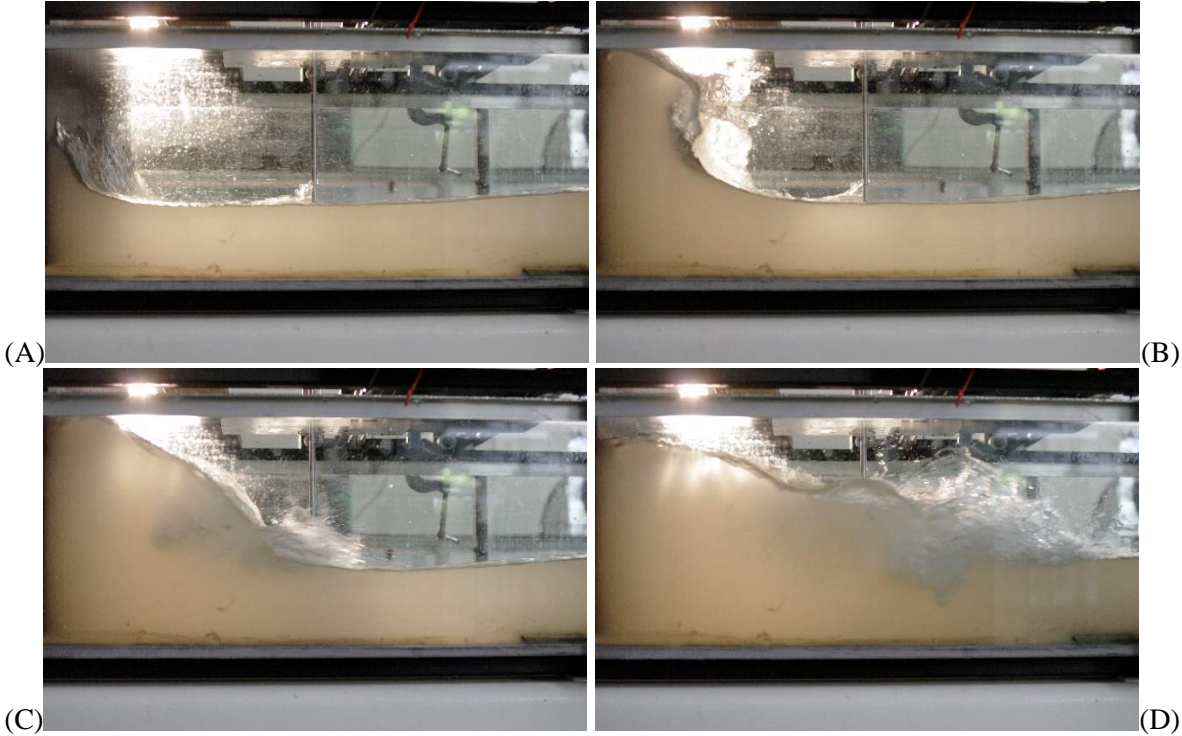
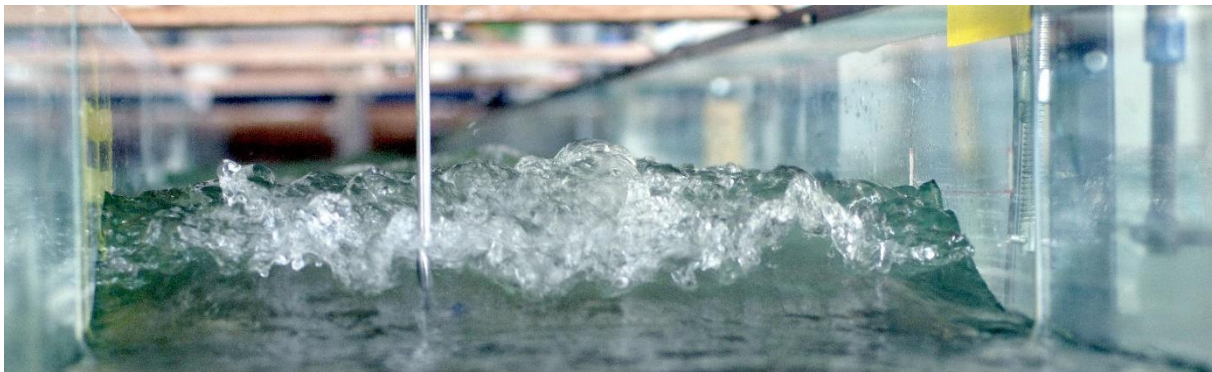

Fig. 5 - Photographs of upstream bore propagation in the rectangular channel (SIMON and CHANSON, 2013): (A) Undular bore ($Fr = 1.3$) propagating from left to right - $Q = 0.0364 \text{ m}^3/\text{s}$, $d_o = 0.084 \text{ m}$, $h_g = 0.043 \text{ m}$. (B) Breaking bore ($Fr = 1.6$) - $Q = 0.0364 \text{ m}^3/\text{s}$, $d_o = 0.084 \text{ m}$, $h = 0 \text{ m}$. (C) Breaking bore ($Fr = 1.7$) - $Q = 0.0536 \text{ m}^3/\text{s}$, $d_o = 0.114 \text{ m}$, $h = 0$ - Note two ADV units mounted side-by-side.



(A)



(B)

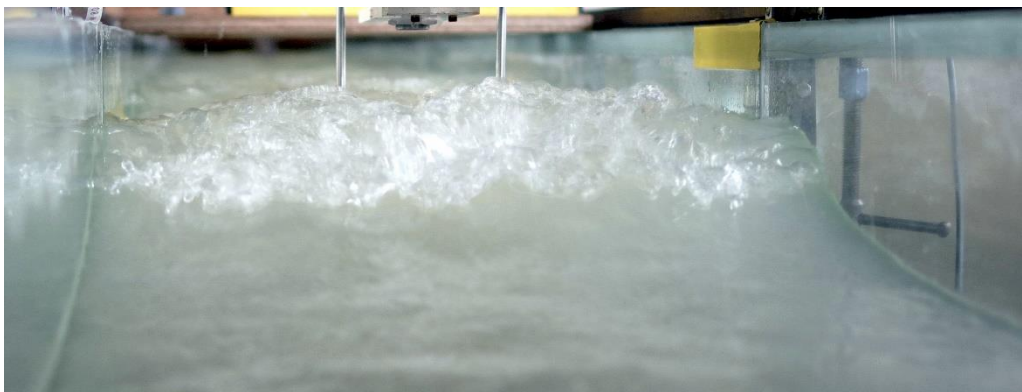

(C)

Fig. 6 – Sketch of the 2D numerical domain, showing the boundary conditions used for the simulations. The right side of the numerical domain is upstream (river flowing downstream) and the left side is downstream (where the tidal flow rises upriver). The flow conditions consist in two rectangles of water initialised with velocities V_0 and V_b before and after $x = 0$ m. The V_0 velocity is either positive (DB – dam break; OF – opposite flow; PC – partially closed gate) or negative, depending on the cases modelled (see Table 2 and Fig 3), while V_b is always negative (modelling the river flowing from downstream to upstream). The resulting hydrodynamic shock is visible as a positive surge is generated with a positive velocity. U_b is always positive, indicating the bore front travelling from downstream to upstream.

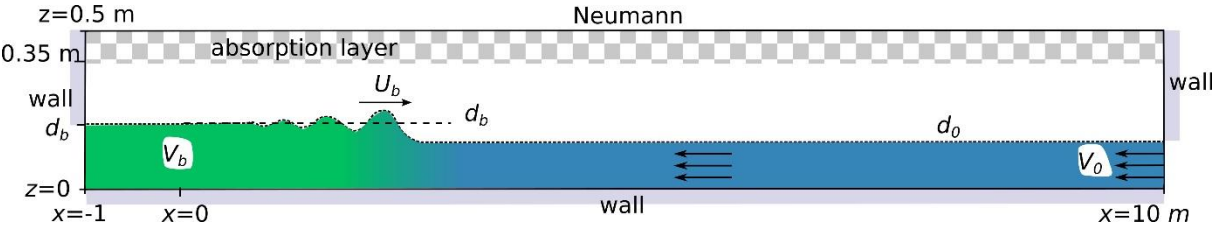

Fig. 7 – Initial condition of the dam break case (DB) and wave propagation in the domain. Mapping of the longitudinal velocity with streamlines.

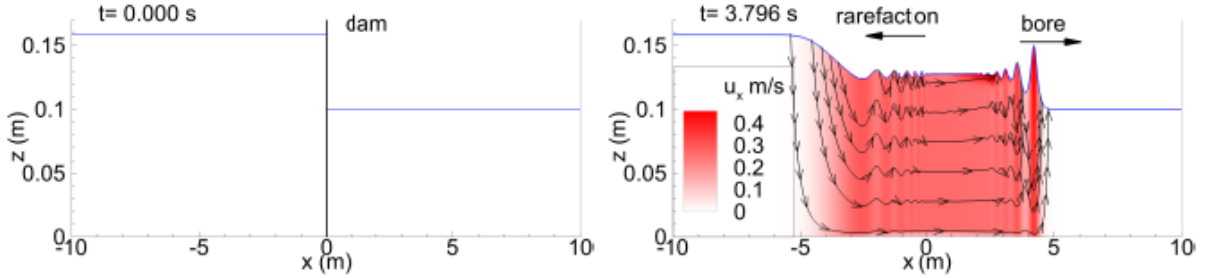

Fig. 8 – Time evolution of the numerical free surface time evolution (num.) compared with theoretical values (analytical) at two different locations.

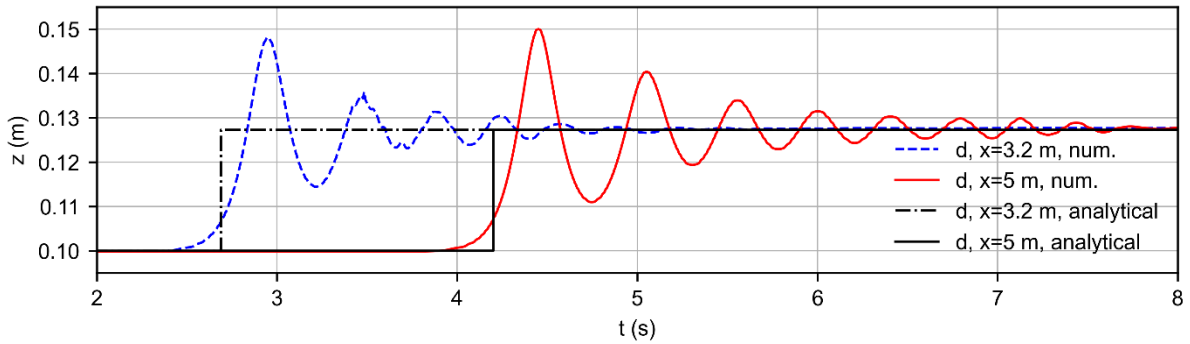
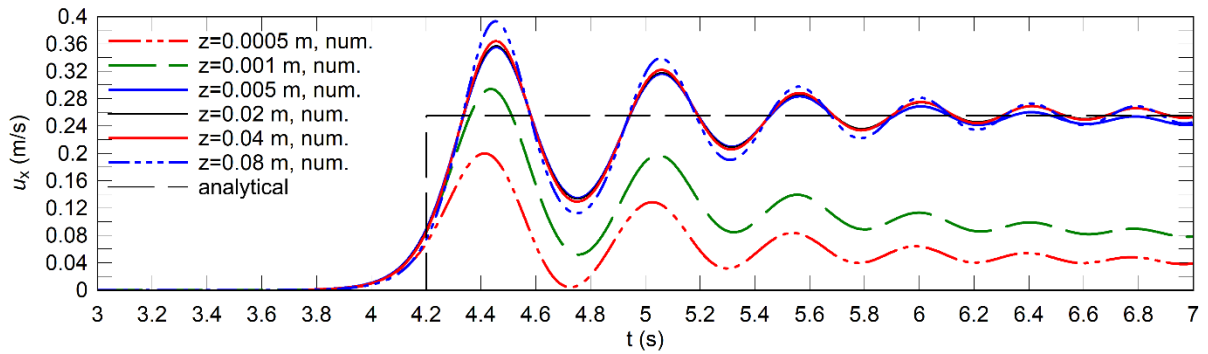
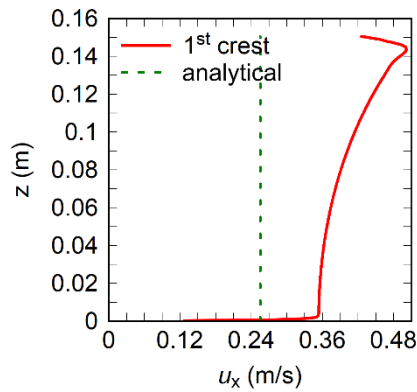

Fig. 9 – Longitudinal velocity component underneath the undular waves generated by DB, (a) comparison between the numerical results (num.) and analytical formula (analytical). (b): vertical profile of the longitudinal velocity component directly under the bore front crest at $x = 4.125$ m.



(a) Time evolution of u_x at $x = 5$ m, at several depths



(b) Vertical profile of u_x

Fig. 10 – DB case - Time evolution of the pressure at two elevations and $x = 5$ m. Comparison between the numerical results (num.) and hydrostatic pressure (hydro.).

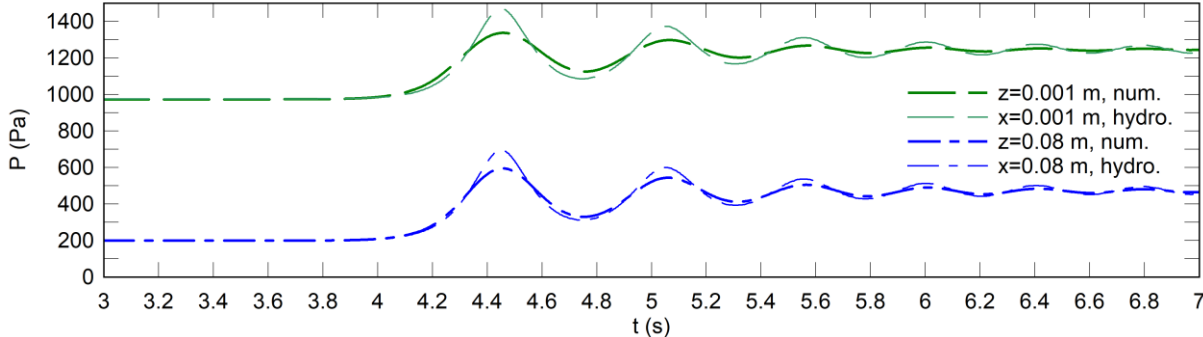
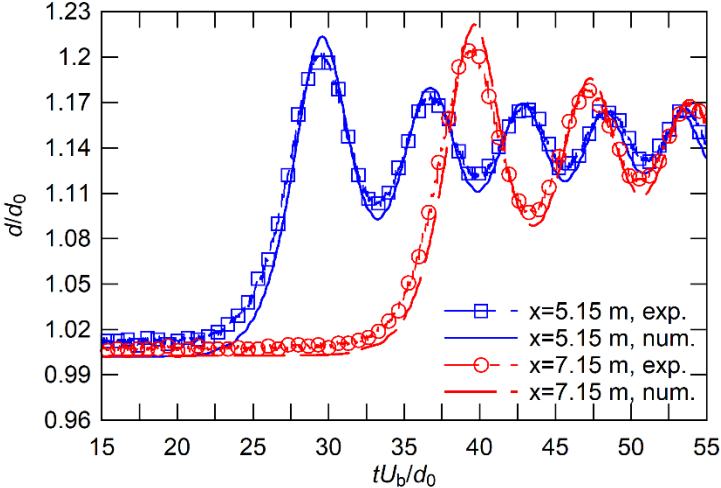
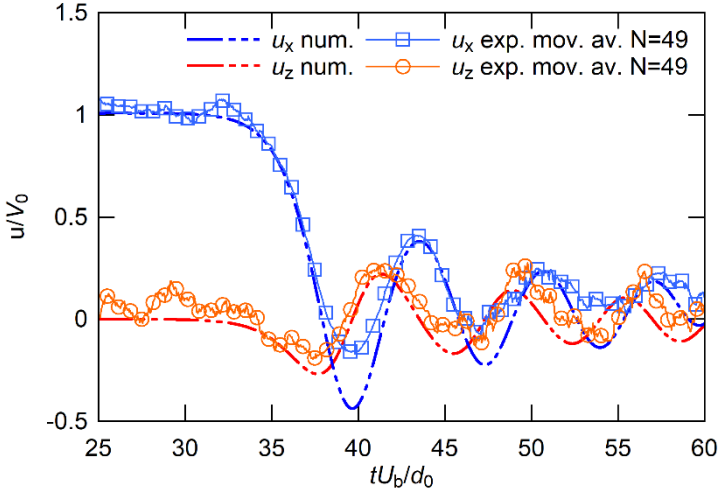

Fig. 11 – FC case - Comparison between numerical (num.) and experimental (exp.) results. (a): non-dimensional time evolution of the free surface d/d_0 of undular bores. (b): non-dimensional time evolution of the dimensionless horizontal and vertical components of the flow velocity, u_x/V_0 and u_z/V_0 , at $z/d_0 = 0.73$ (where mov. av. = moving average and N = number of measured data).



(a) Free-surface



(b) Velocity

Fig. 12 – Comparison of dimensionless time evolutions of the free surface profiles, for the dam break (DB), opposing flow (OF), fully closed (FC) and partially closed gate (PC) bore generation method (see table 2). (a): cases with $Fr=1.1$, at $x=5.8$ m; (b): cases with $Fr=1.2$, at $x=5.8$ m; (c): cases with $Fr=1.5$, at $x=5.8$ m.

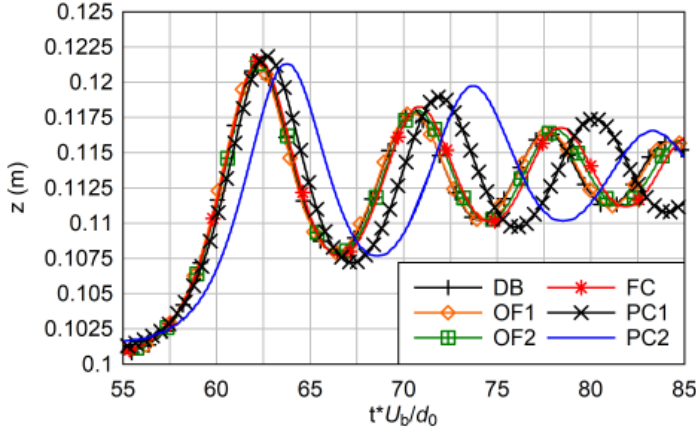

(a) cases $Fr = 1.1, x = 5.8$ m

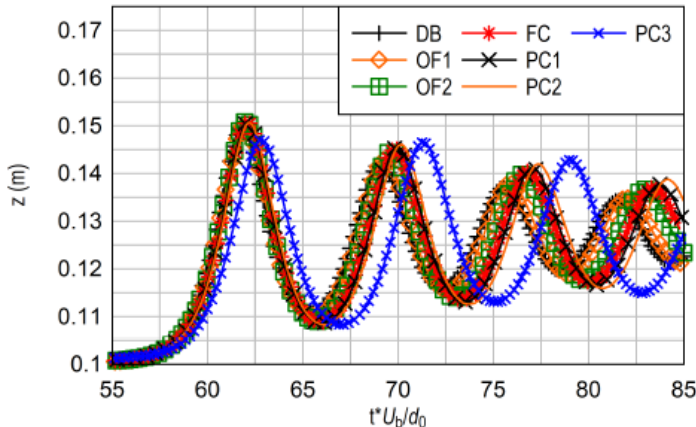

(b) cases $Fr = 1.2, x = 5.8$ m

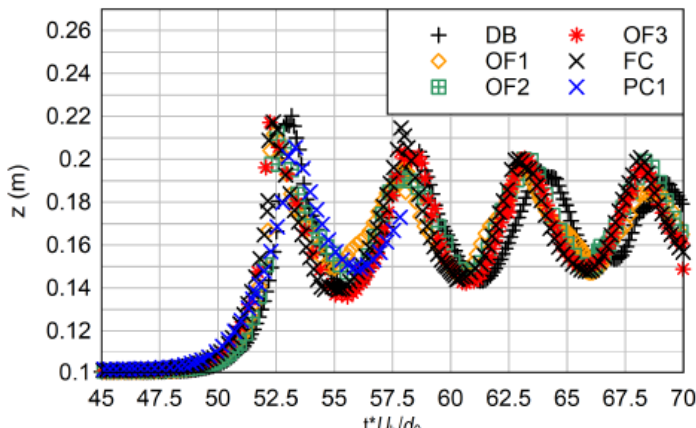

(c) cases $Fr = 1.5, x = 5.15$ m

Fig. 13 – Comparison of the bore front shape with data from theoretical and experimental studies. Linear wave theory (LEMOINE, 1948), cnoidal wave theory (ANDERSEN 1978), laboratory (CHANSON, 2010a; DOCHERTY and CHANSON, 2012; KHEZRI and CHANSON, 2012; KOCH and CHANSON, 2009; TRESKE, 1994; SIMON, 2014) and prototype (NAVARRE, 1995).

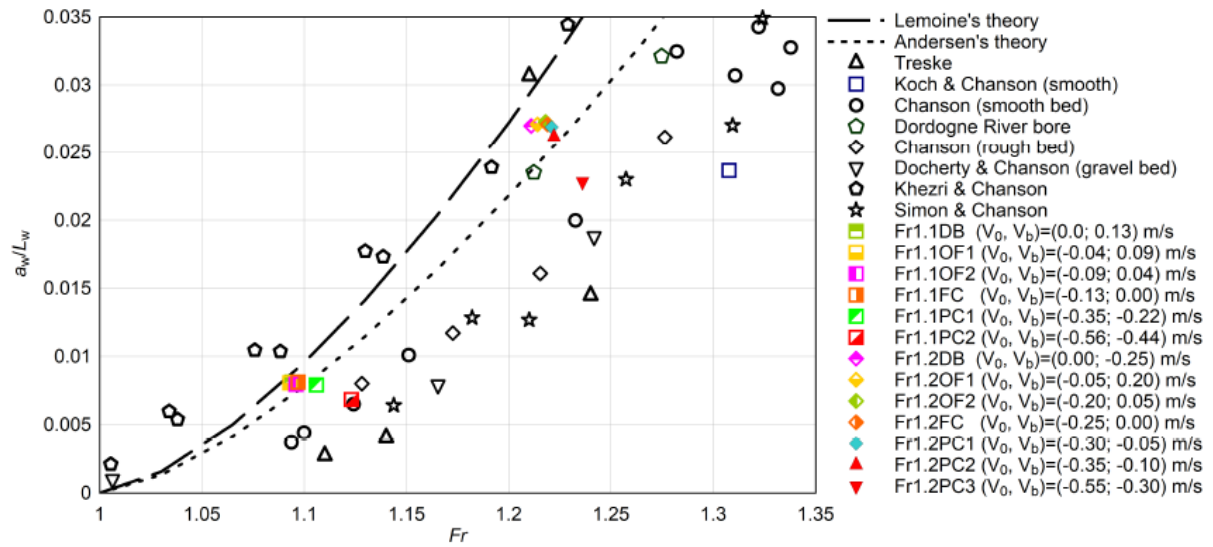

Fig. 14 – Hydrodynamics of the undular bore for $Fr = 1.1$. The color maps show the longitudinal velocity component $u_x - V_0$ to simplify comparison between cases. The black lines are the isolines of $u_x = 0$ which show the flow reversal and recirculations (except for DB case, where V_0 is null). The arrowed lines show the streamlines presenting the direction of \mathbf{u} at the presented time. (a): DB; (b): OF1; (c): FC; (d): PC1; (e): PC2; (f): PC3.

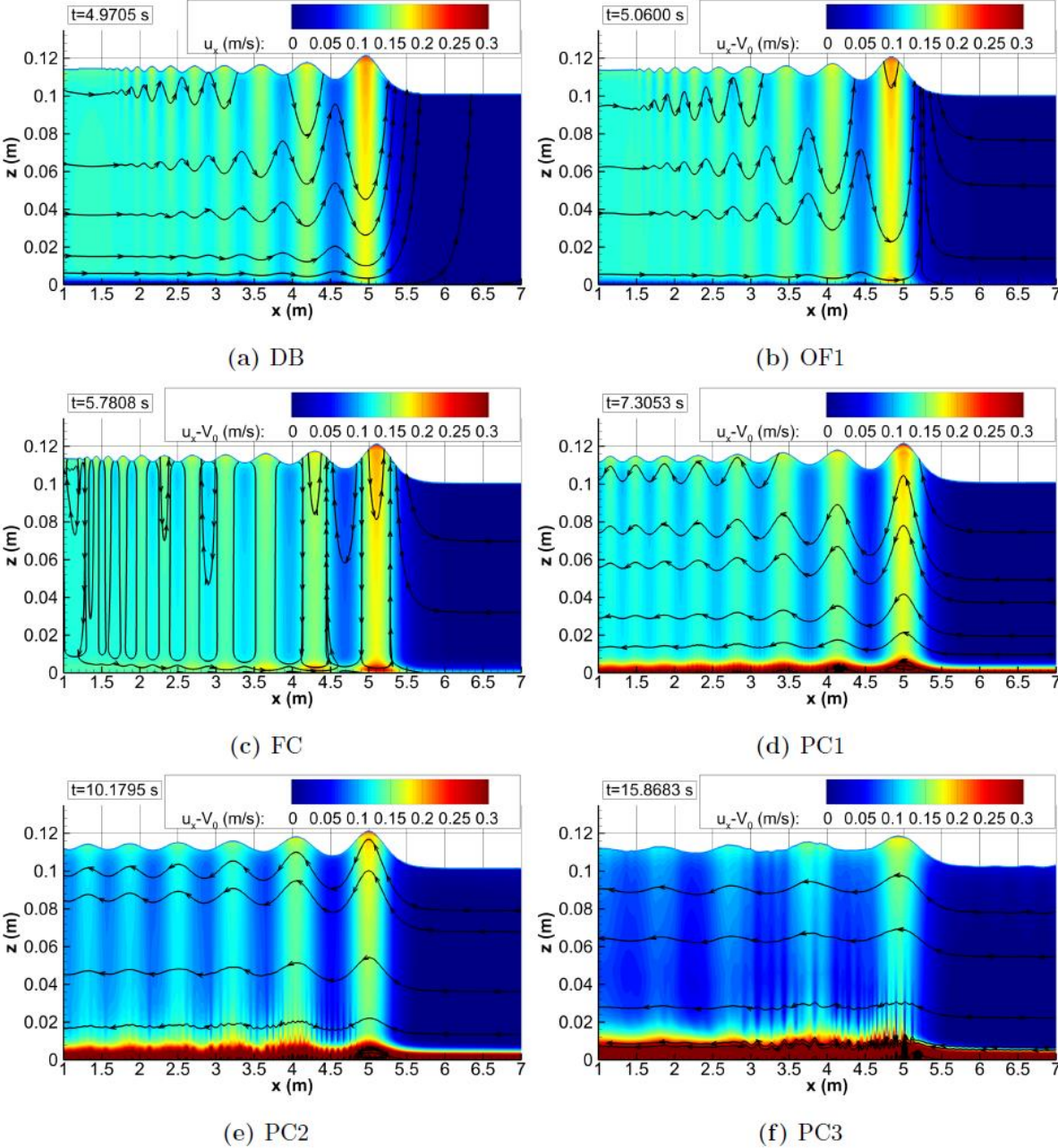

Fig. 15 – Hydrodynamics of the undular bore for $Fr = 1.2$. The color maps show the longitudinal velocity component $u_x - V_0$ to simplify comparison between cases (except for DB case, where V_0 is null). The black lines are the isolines of $u_x = 0$ which show the flow reversal and recirculations. The arrowed lines show the streamlines presenting the direction of \mathbf{u} at the presented time. (a): DB; (b): OF1; (c): FC; (d): PC1; (e): PC2; (f): PC3.

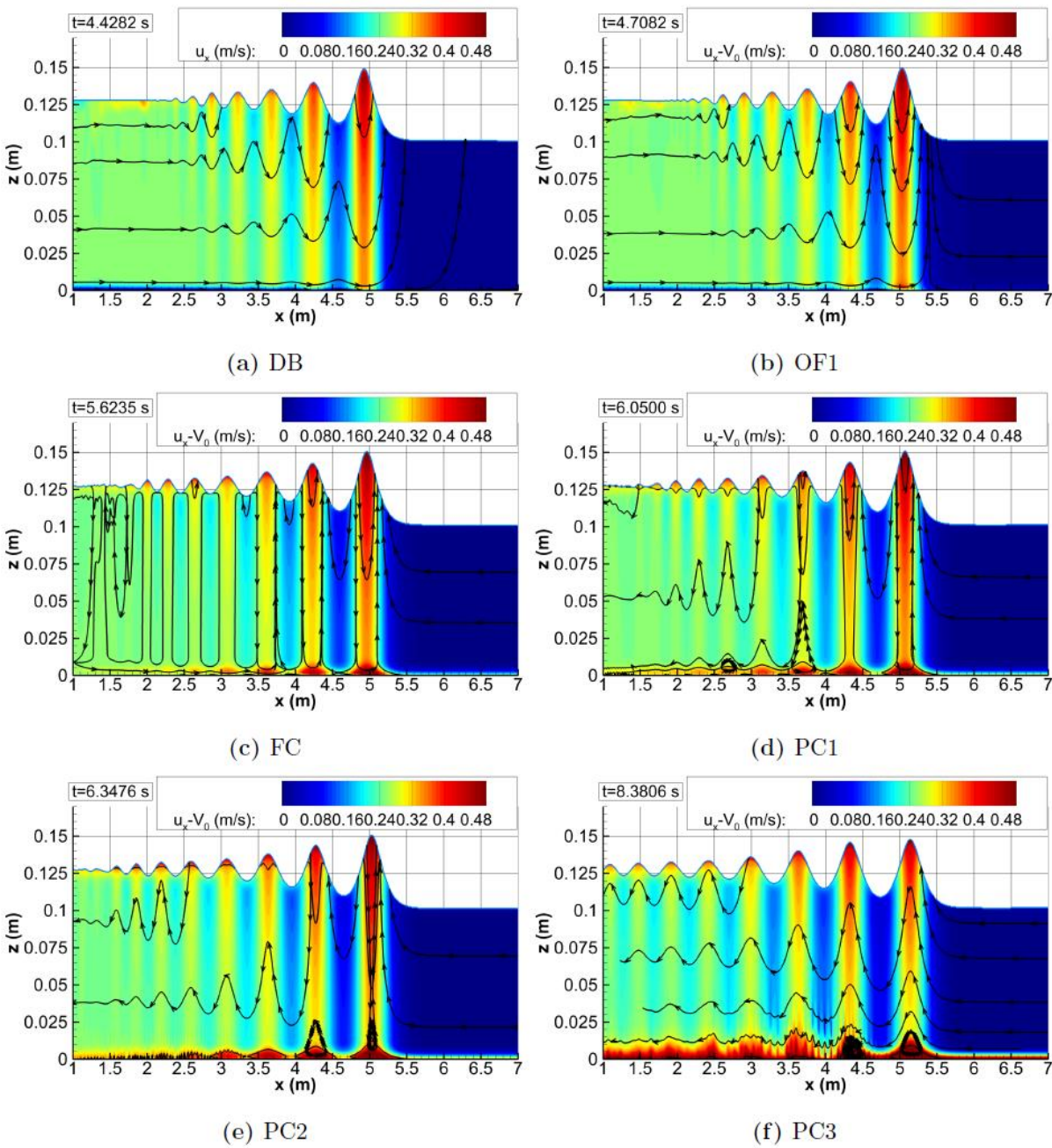

Fig. 16 – Hydrodynamics of the weakly breaking bore for $Fr = 1.5$. The color maps show the longitudinal velocity component $u_x - V_0$ to simplify comparison between cases. The black lines are the isolines of $u_x = 0$ which show the flow reversal and recirculations. The arrowed lines show the streamlines presenting the direction of \mathbf{u} at the presented time. (a): DB; (b): OF1; (c): FC; (d): PC1; (e): PC2; (f): PC3.

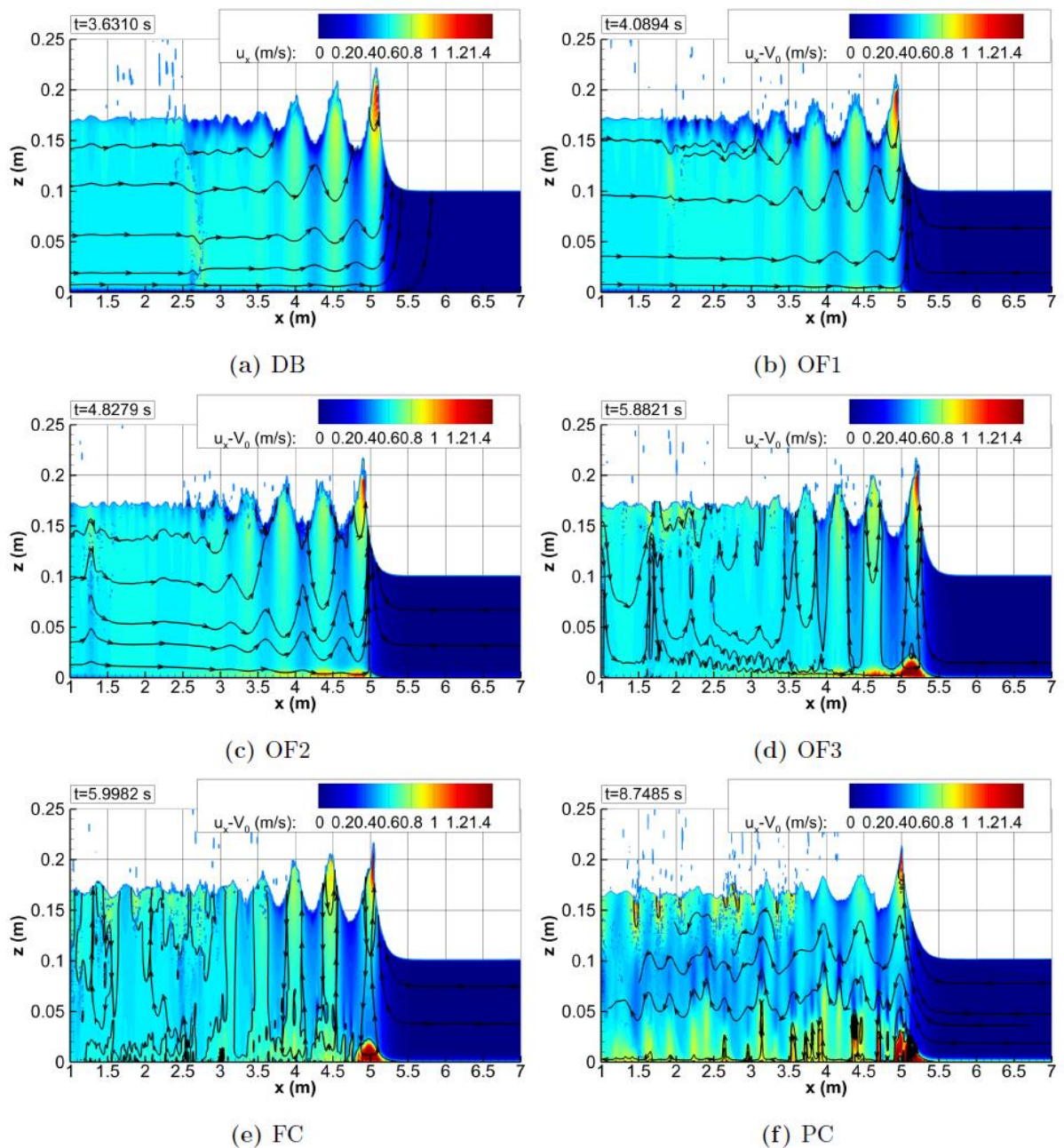
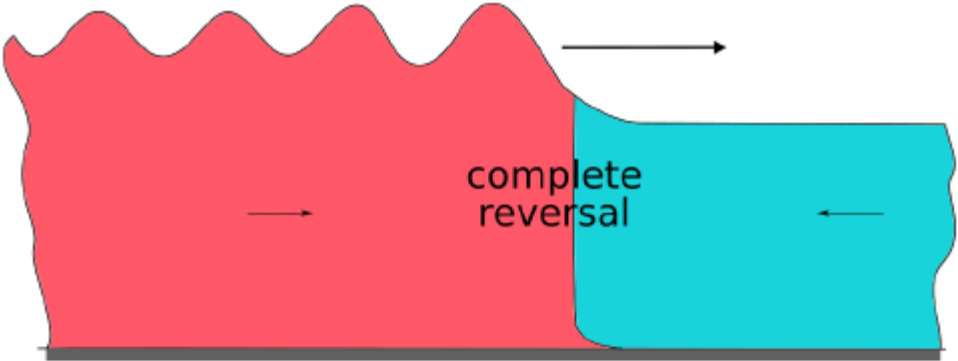
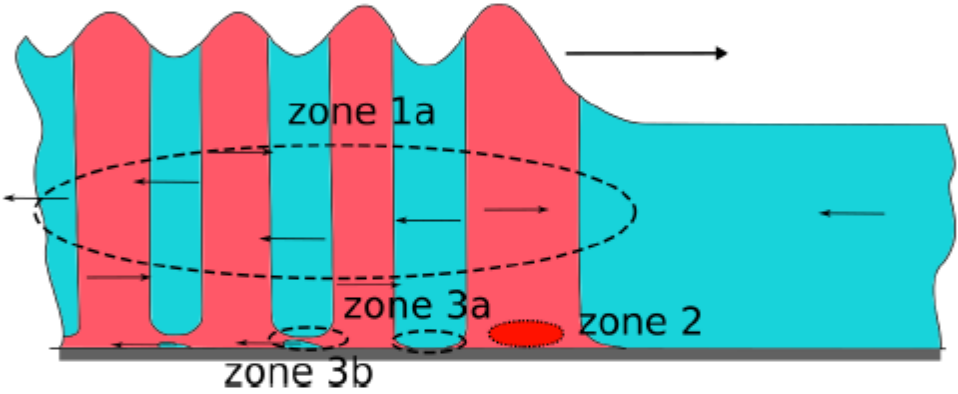

Fig. 17 – Simplification of the hydrodynamics conditions appearing in positive surges. Scenario (a), (b) and (c).



(a) Complete flow reversal



(b) Oscillating flow

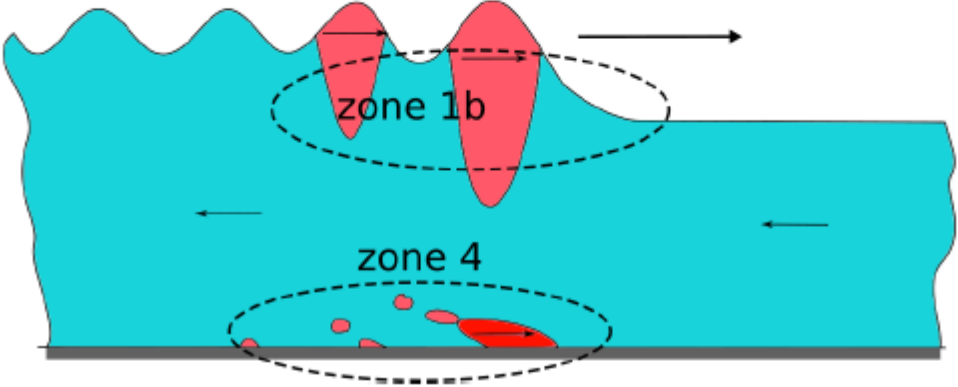

(c) No reversal

Fig. 18 – Experimental generation of positive surge with a similar gate as in experiments (CHANSON, 2010c, 2011b). On the left, the bore is not yet generated, the closing gate just hits the water free surface. As the tainter gate is partially closed (right), the undular bore appears and propagates against the steady flow (Photos: B. Simon).

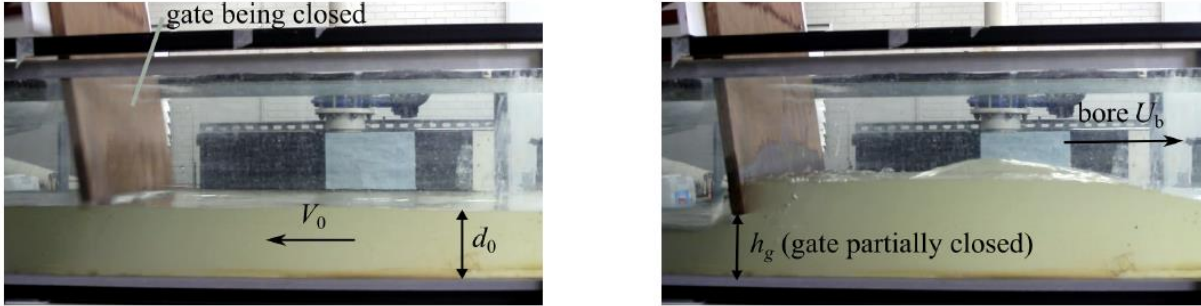

Fig. 19 – 2D definition sketch of the numerical domain used for the simulations with the bore propagating in the 3D numerical domain

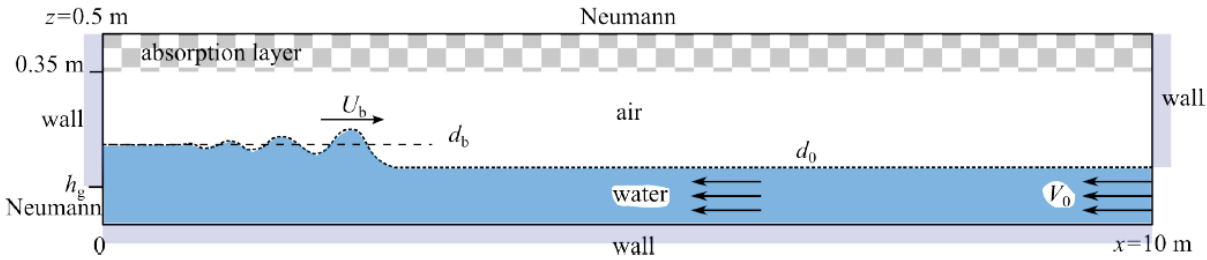

Fig. 20 – Steady flow conditions. Dimensionless mean and RMS of the velocity signal generated using the SEM method (JARRIN, 2006, 2008) and measured in the experiment (CHANSON, 2009b, 2011b). All data are measured at $x = 7.15$ m from the gate on the channel centreline and time averaged

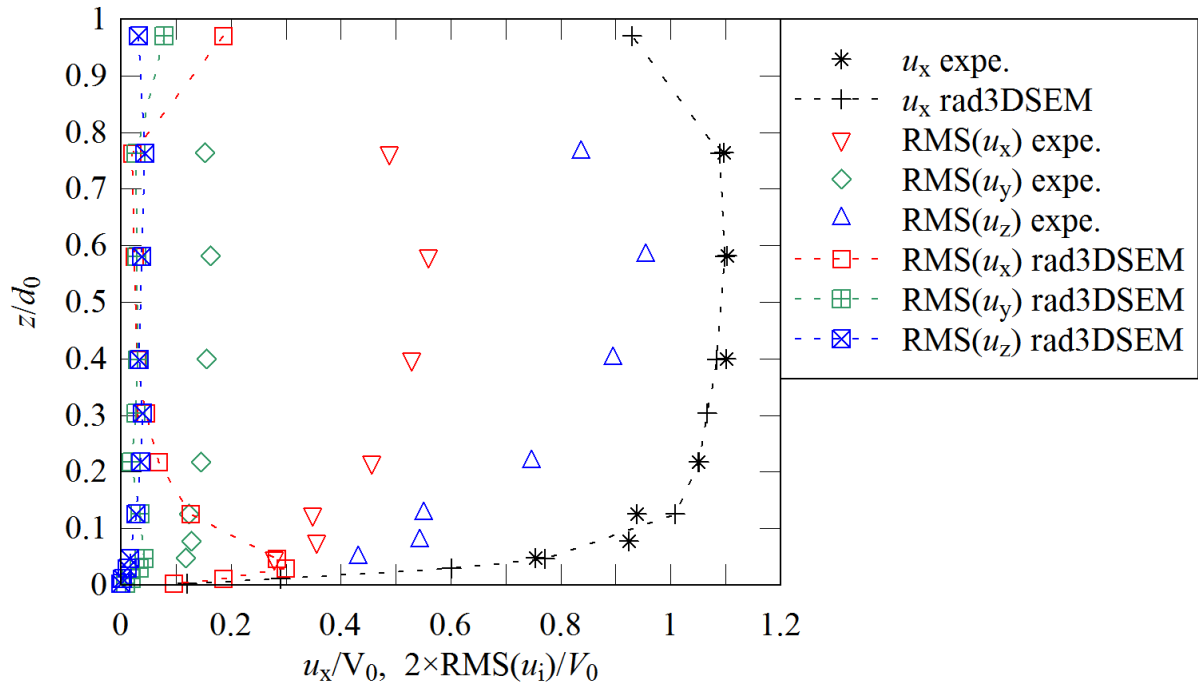

Fig. 21 – Dimensionless free surface time evolution of the 2D and 3D undular bores. Comparison between numerical simulations, experimental data (CHANSON, 2011b) (expe.) and eq. (1) and (2).

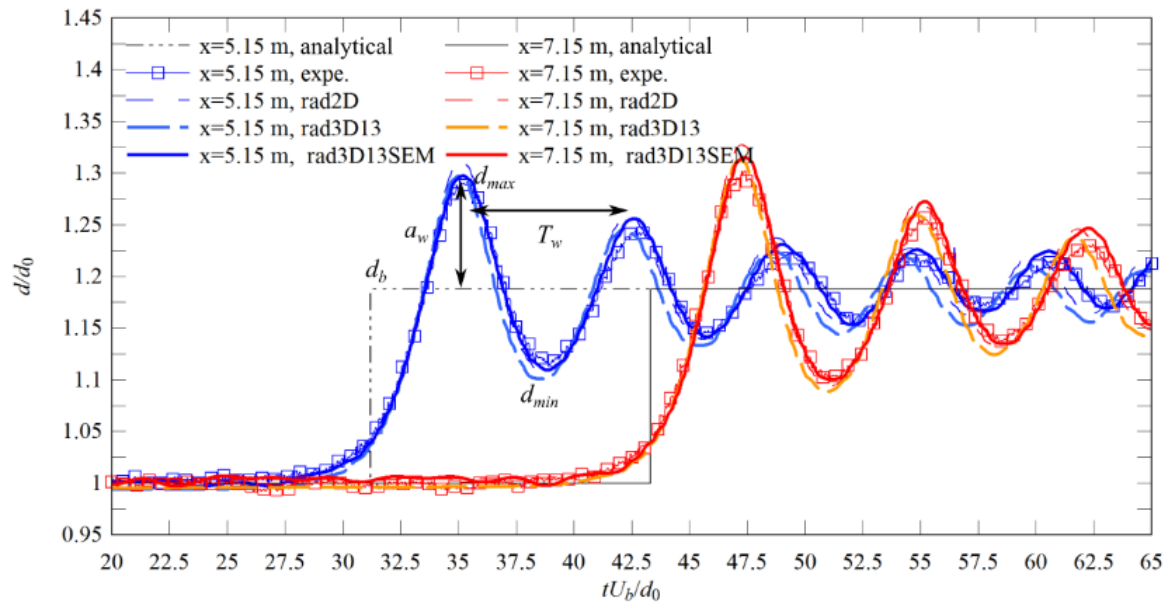

Fig. 22 – Time evolutions of the velocity at $z \approx 0.036$ m with the free surface evolution at $x = 7.15$ m for rad2D, rad3D and rad3DSEM. Comparison between numerical simulations and experiments (CHANSON, 2011b). Legend: “expe.”: raw experimental data and “av., N=49”: moving mean of experimental data. (a) longitudinal, (b) transverse (no 2D data), and (c) vertical velocity components

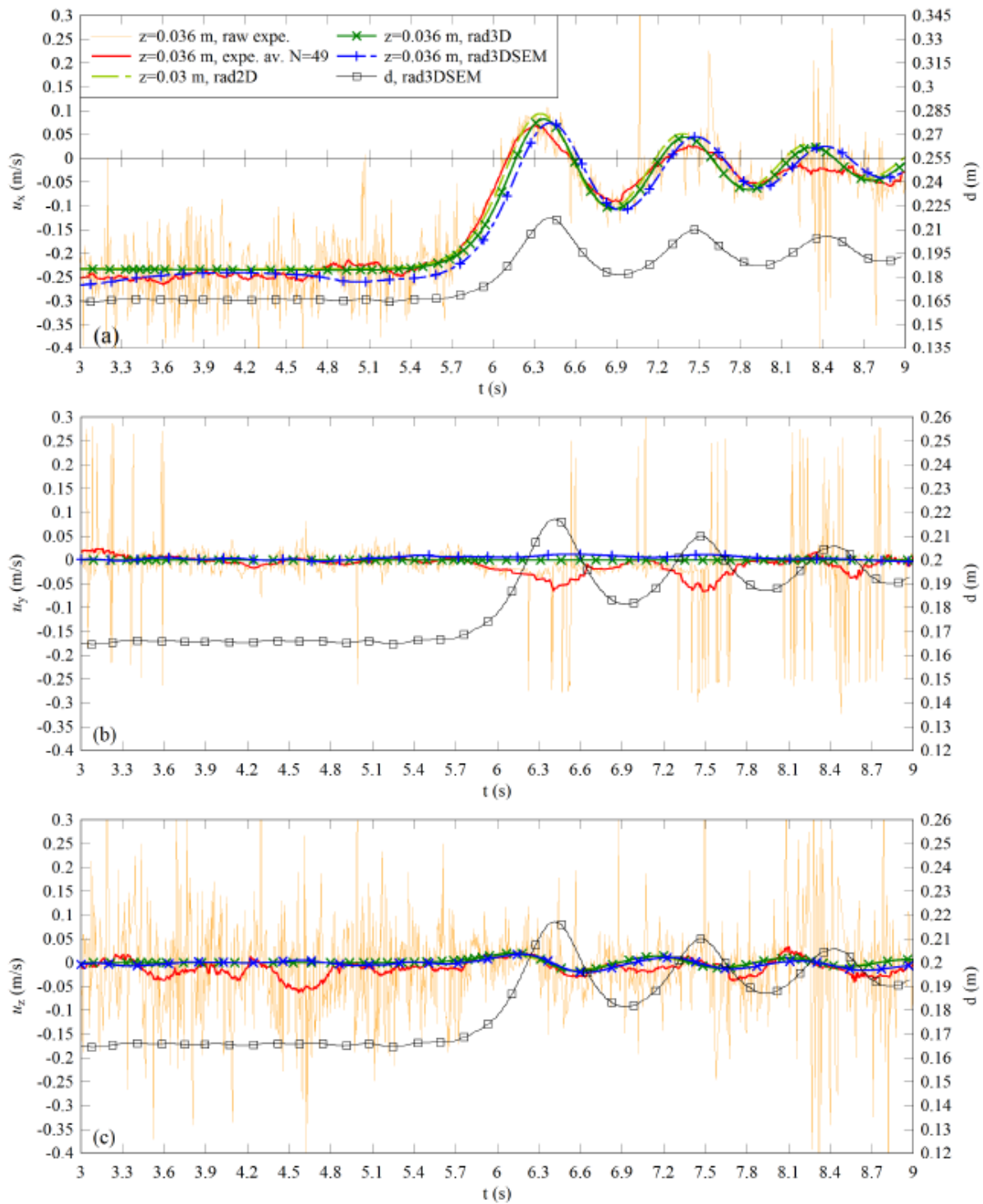

Fig. 23 – Undular bore propagation illustrated by its free-surface elevation above d_0 for the simulation rad3DSEM at two different times. The colour mapping on the free-surface indicates the elevation

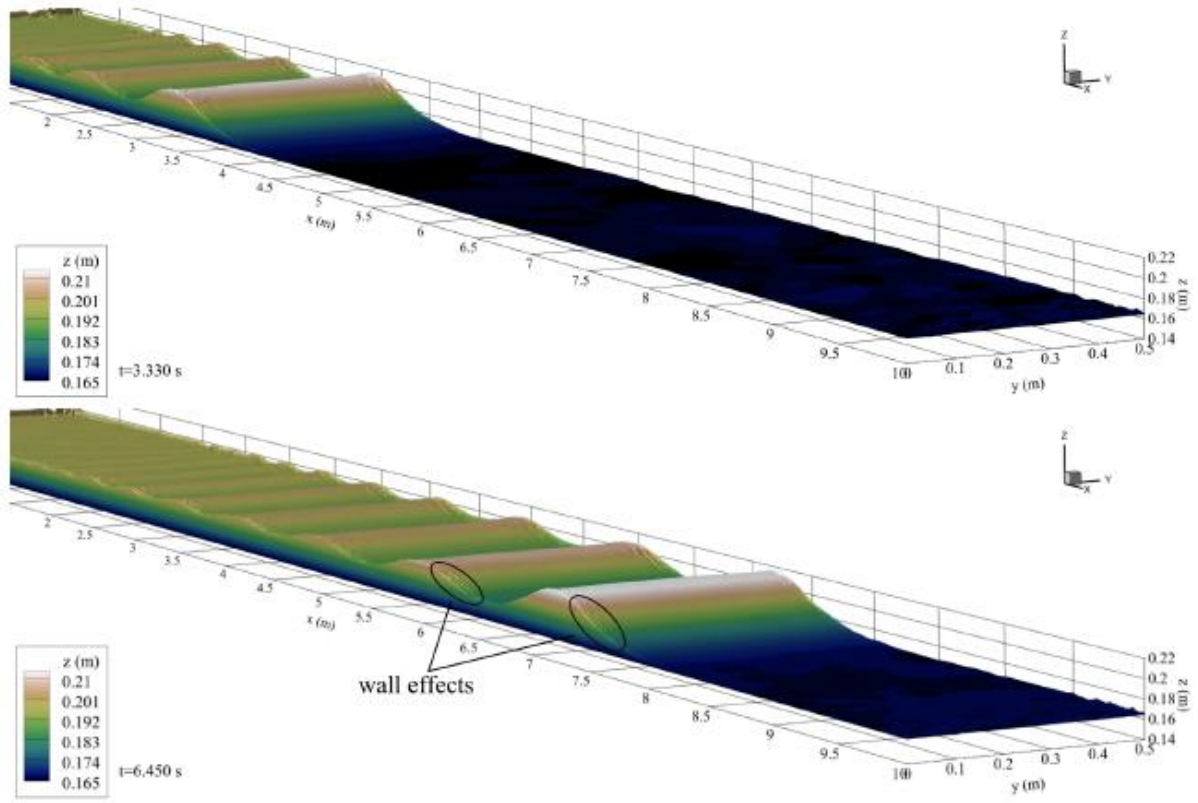

Fig. 24 – Flow evolution beneath the undular bore rad2D. The colour mapping represents the velocity magnitude with velocity streamlines (lines with arrows) and isolines $u_x = 0$ (black lines)

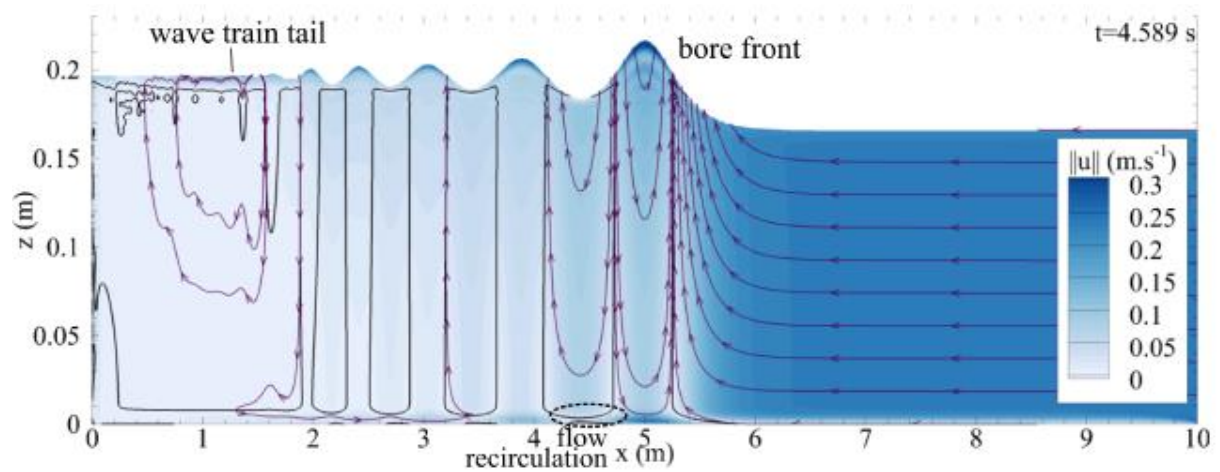
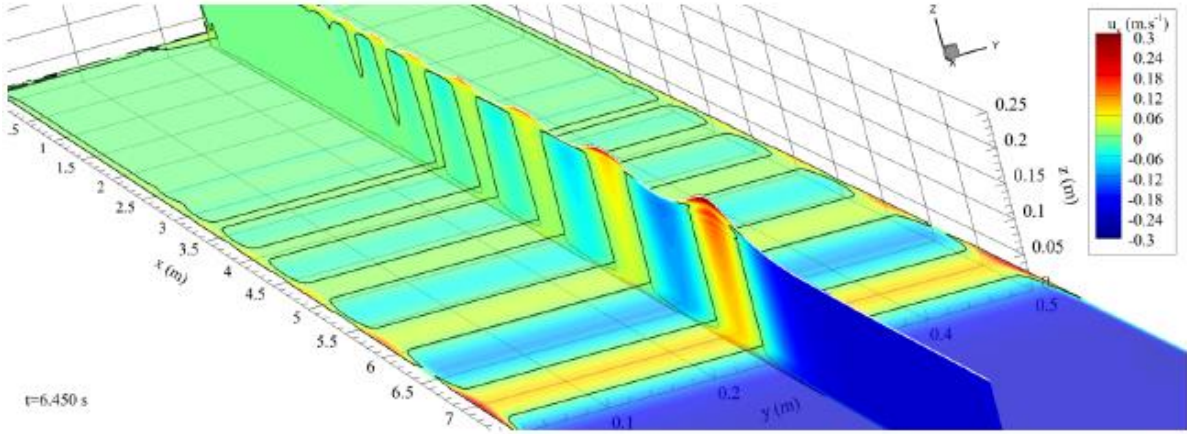
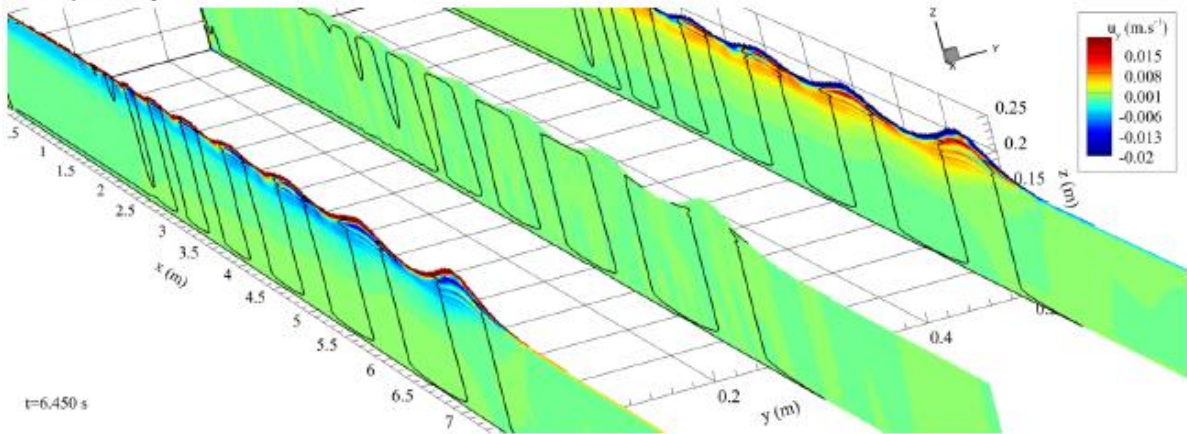

Fig. 25 – Velocity fields in the undular bore rad3D as the bore propagates from left to right. The black lines represent the isolines $u_x = 0$. (a): horizontal component u_x ; (b): transversal component u_y ; (c): vertical component u_z .



(a) u_x , vertical slice on the channel centreline and horizontal slice at $z = 0.025$ m plotted with transparency



(b) u_y , vertical slices at $y = 0.01, 0.25$ and 0.49 m

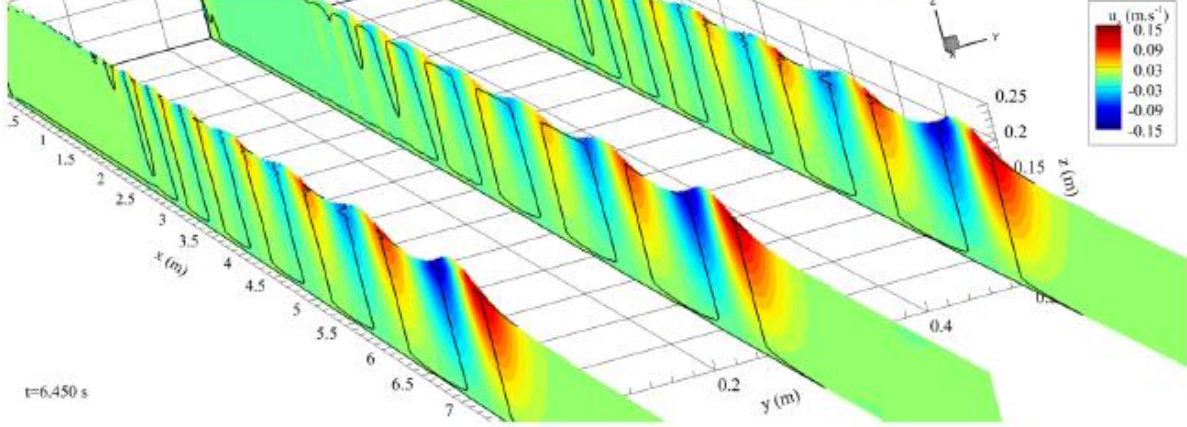

(c) u_z , vertical slices at $y = 0.01, 0.25$ and 0.49 m

Fig. 26 – Velocity fields in the undular bore rad3DSEM as the bore propagates from left to right. Black lines represent the isolines $u_x = 0$. (a): horizontal component u_x ; (b): transversal component u_y ; (c): vertical component u_z .

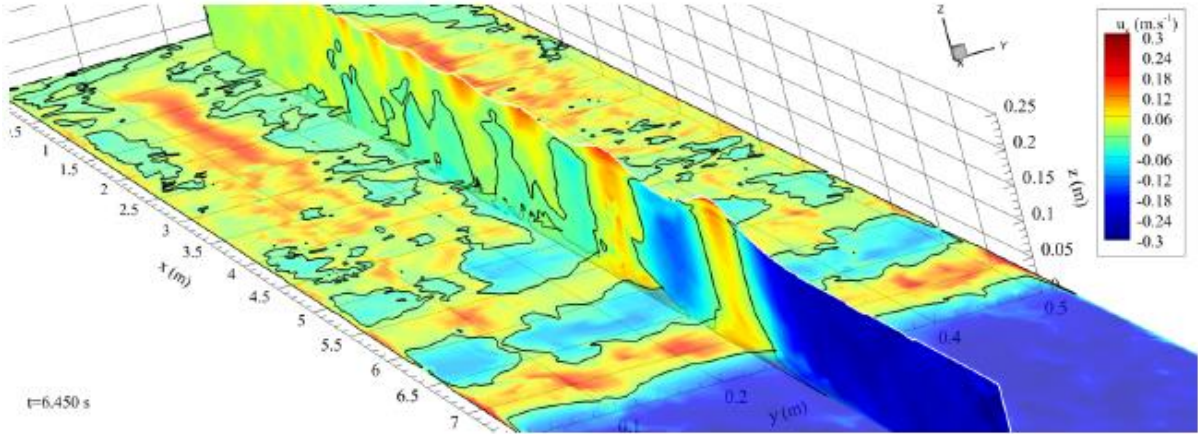

(a) u_x , vertical slice on the channel centreline and horizontal slice at $z = 0.025$ m plotted with transparency

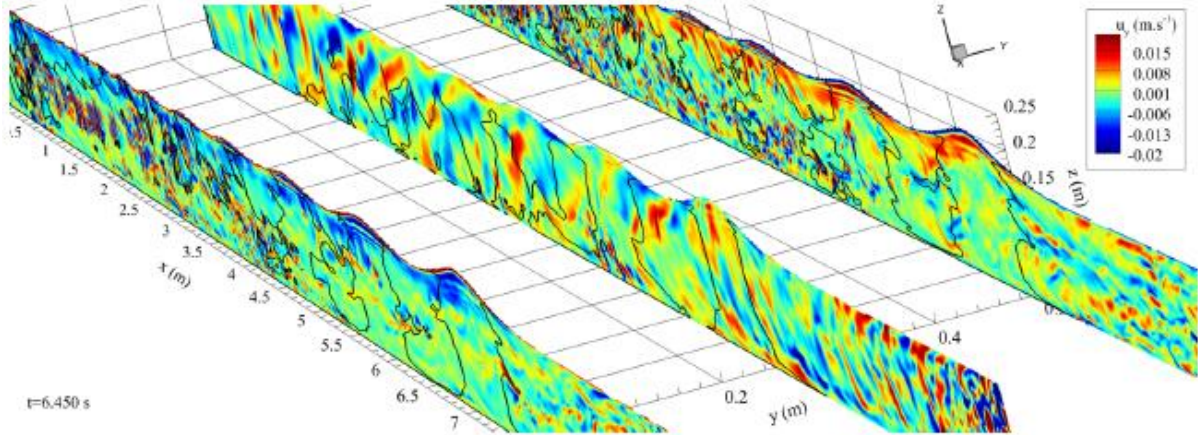

(b) u_y , vertical slices at $y = 0.01, 0.25$ and 0.49 m

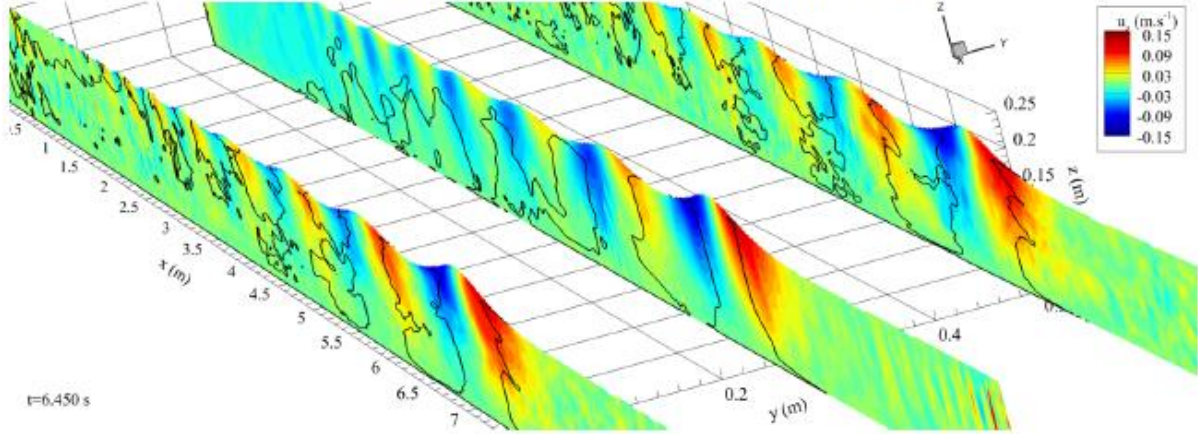

(c) u_z , vertical slices at $y = 0.01, 0.25$ and 0.49 m

Fig. 27 – Elevation of the free-surface for the simulation ond3DSEM with focus on the front between $x = 2$ to 6 m. The colour mapping on the free-surface indicates the elevation and the bore propagates from left to right

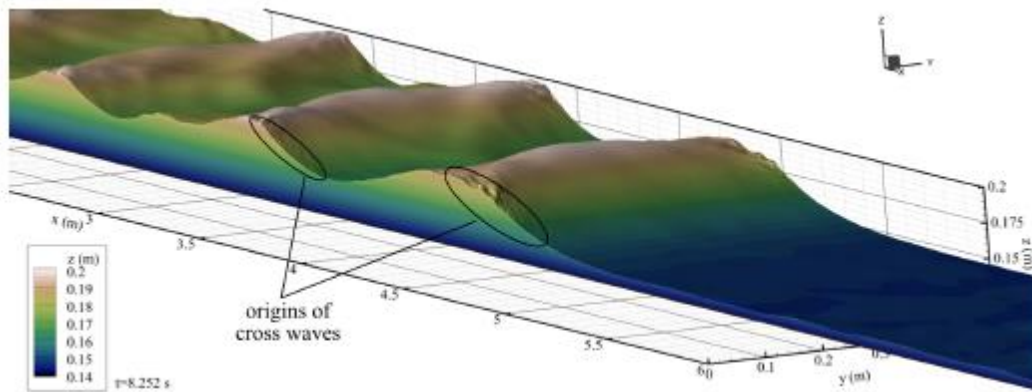

Fig. 28 – Flow evolution beneath the undular bore ond2D. The colour mapping represents the velocity magnitude with velocity streamlines (lines with arrows) and isolines $u_x = 0$ (black lines)

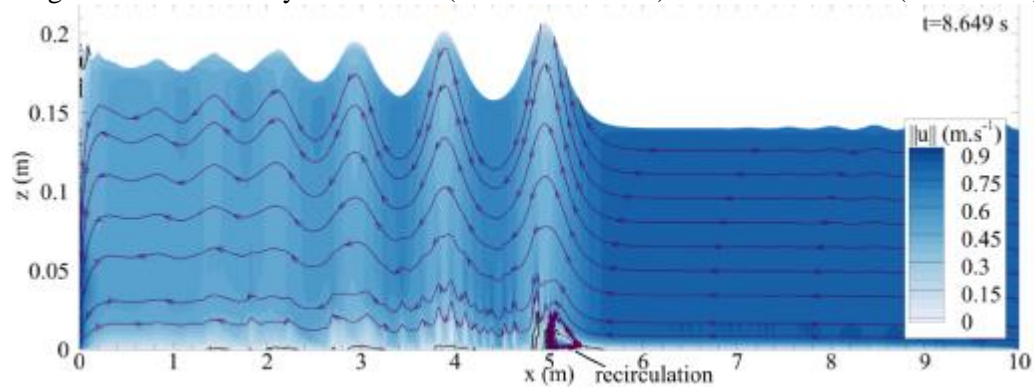

Fig. 29 – Velocity fields in the undular bore on d3D as the bore propagates from left to right. Black lines represent the isolines $u_x = 0$. Slices on the channel centreline and 0.005 m from the lateral walls. (a): horizontal component u_x ; (b): transversal component u_y ; (c): vertical component u_z .

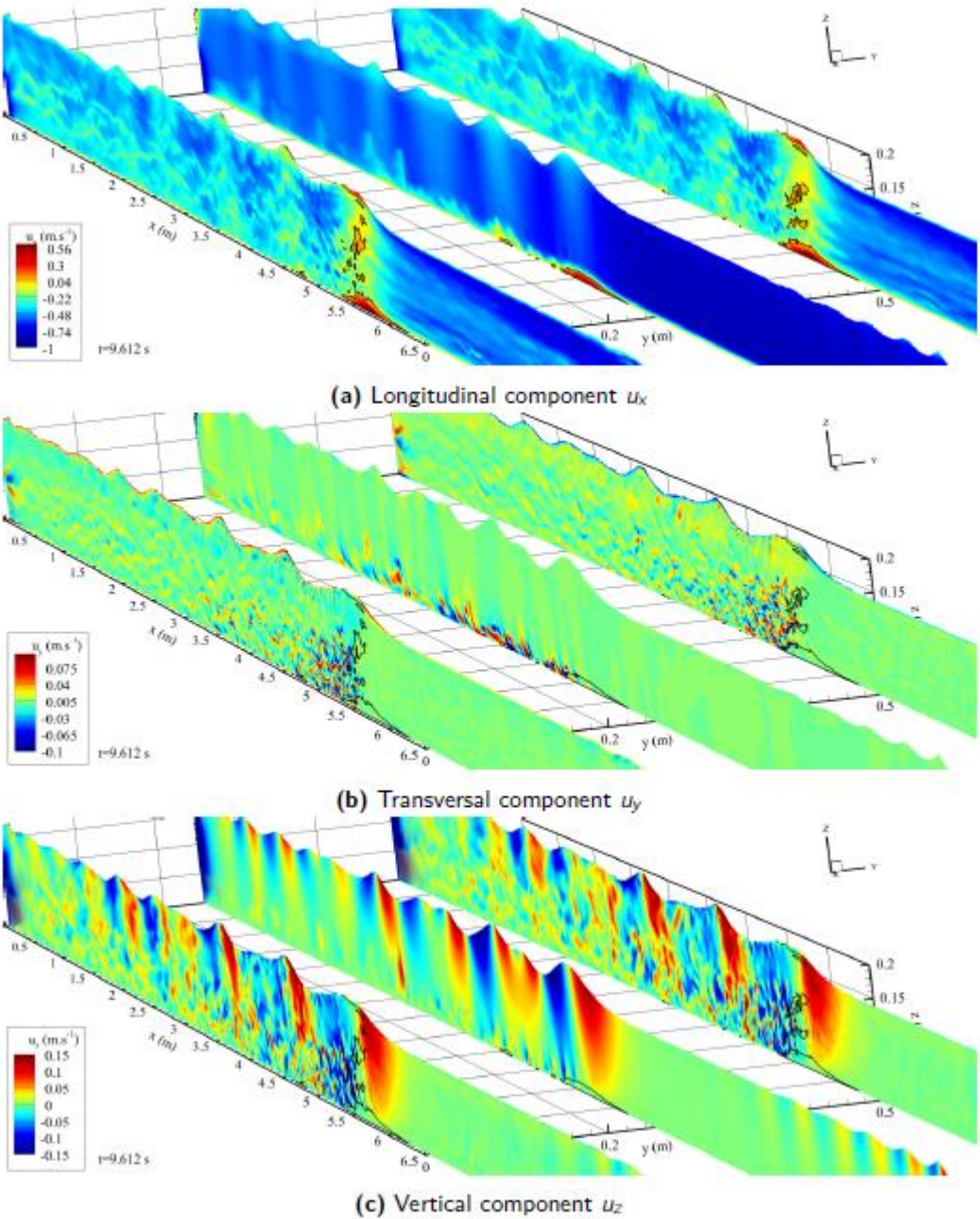

Fig. 30 – Velocity fields in the undular bore on d3DSEM as the bore propagates from left to right. The black lines represent the isolines $u_x = 0$. Slices on the channel centreline and 0.005 m from the lateral walls. (a): horizontal component u_x ; (b): transversal component u_y ; (c): vertical component u_z .

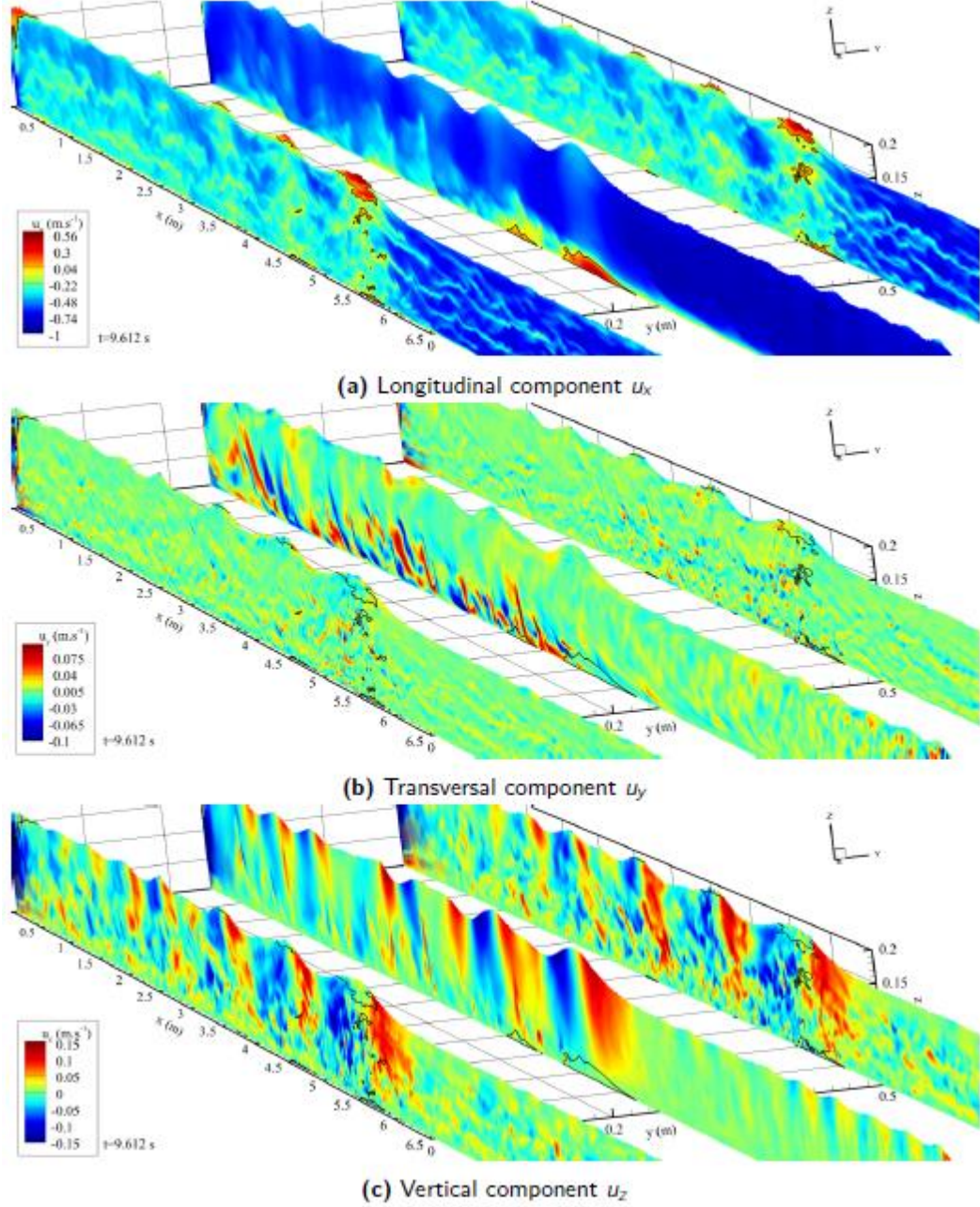
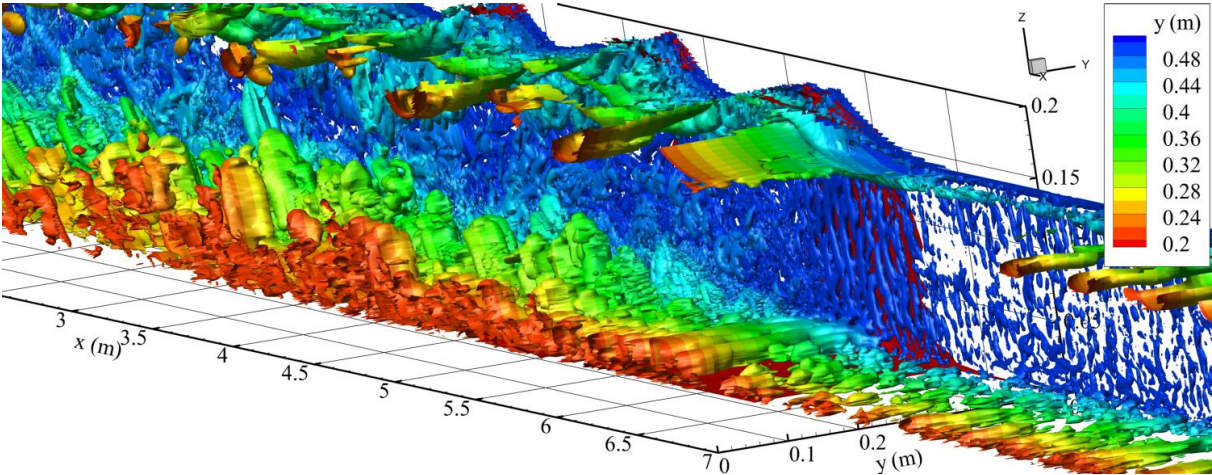
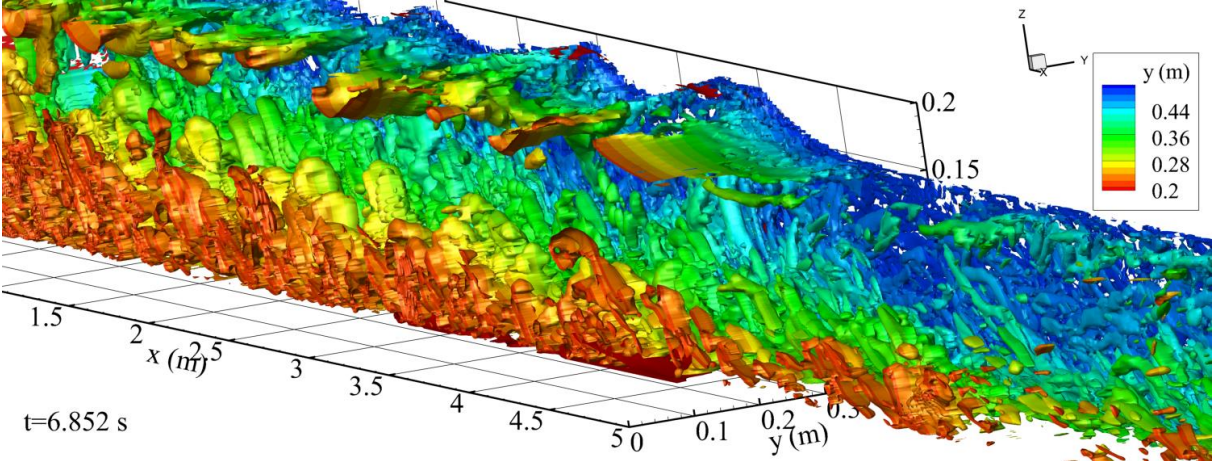

Fig. 31 – Isosurface of the Q-criterion $Q = 2$ beneath bores with colour mappings of the transversal distance and the isosurface of $u_x = 0$ in red. It can be clearly observed that the boundary layer tends to get thicker in the wake of the bore front. Numerical results taking the SEM into account shows more penetration of the eddies from the bottom to the core of the water column. (A) Simulation Ond3D; (B) Simulation Ond3DSEM.



(A) Simulation Ond3D, Q-criterion plotted for $y > 0.2$, bore front located at $x = 5.7$ m, $t = 9.82$ s.



(B) Simulation ond3DSEM, Q-criterion plotted for $y > 0.2$, bore front located at $x = 4.5$ m, $t = 6.852$ s.

Fig. 32 – Bore front propagation in trapezoidal channel. (A): undular bore in France; (B): scheme showing the flow structure.



(A) Undular bore in the hydropower canal of Mallemort (France), looking at the incoming bore (Photo EDF)

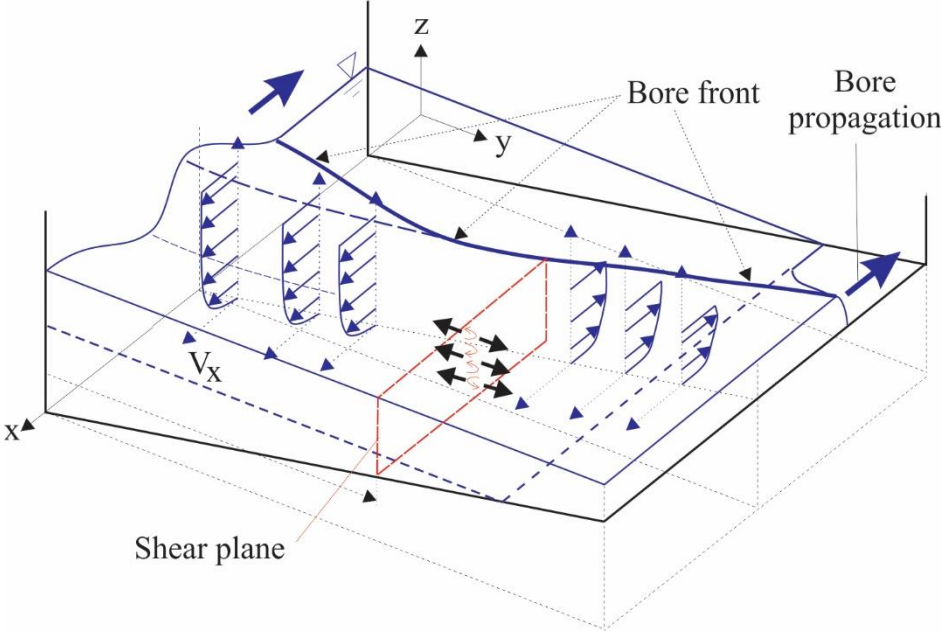

(B) Schematic of transient velocity field on a sideslope of trapezoidal channel