



HAL
open science

Modelling a 3-Port Network in Cavity Magnonics for Nonreciprocal RF Devices

Maxime Ardisson, Romain Lebrun, Vincent Castel, Isabella Boventer

► **To cite this version:**

Maxime Ardisson, Romain Lebrun, Vincent Castel, Isabella Boventer. Modelling a 3-Port Network in Cavity Magnonics for Nonreciprocal RF Devices. Magnonics 2023, international conferences on fundamentals and applications of magnons, Jul 2023, Le Touquet, France. hal-04213525

HAL Id: hal-04213525

<https://hal.science/hal-04213525>

Submitted on 21 Sep 2023

HAL is a multi-disciplinary open access archive for the deposit and dissemination of scientific research documents, whether they are published or not. The documents may come from teaching and research institutions in France or abroad, or from public or private research centers.

L'archive ouverte pluridisciplinaire **HAL**, est destinée au dépôt et à la diffusion de documents scientifiques de niveau recherche, publiés ou non, émanant des établissements d'enseignement et de recherche français ou étrangers, des laboratoires publics ou privés.

Public Domain

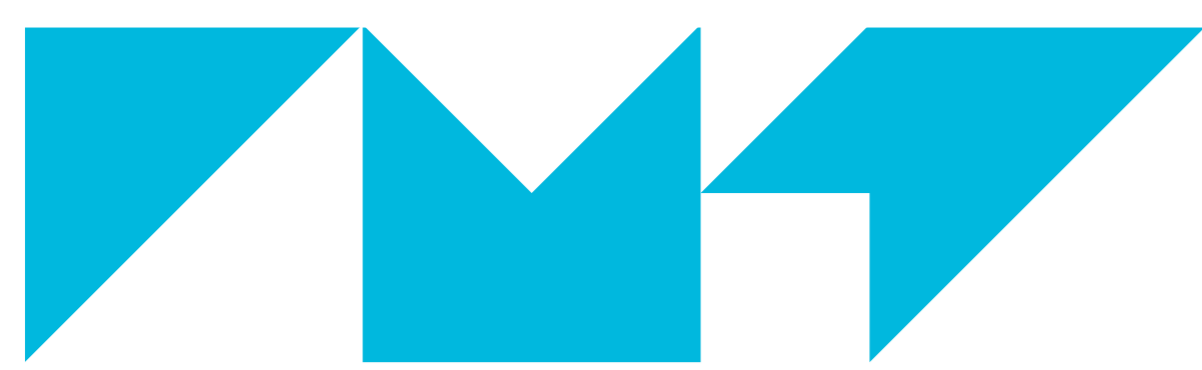

IMT Atlantique
Bretagne-Pays de la Loire
École Mines-Télécom

Modelling a 3-Port Network in Cavity Magnonics for Nonreciprocal RF Devices

Maxime Ardisson^{1,2}, Romain Lebrun³, Vincent Castel^{1,2} and Isabella Boventer³

¹IMT Atlantique, Technopole Brest-Iroise, CS 83818, 29238 Brest Cedex 3, France

²Lab-STICC (UMR 6285), CNRS, Technopole Brest-Iroise, CS 83818, 29238 Brest Cedex 3, France

³Unité Mixte de Physique CNRS, Thales, Université Paris-Saclay, Palaiseau 91767, France

INTRODUCTION

Over the last decade, cavity magnonics has attracted a lot of attention. The study of the associated quasiparticle of cavity magnonics, cavity magnon polaritons which refer to strongly coupled magnon-photon system offers new possibilities of sensing and quantum information processing [1,2] as well as a new interesting platform for disruptive RF applications. In order to further investigate systems for coherent or dissipative cavity magnonics, a simulation toolbox to mimic, optimize and understand better the experiments and underlying physics of cavity magnonics systems for ICT devices is needed. Thus, the goal of this study is to model cavity magnonics experiments [3,4], using the simulation software COMSOL®, for which we use the possibility to tune and combine the regimes of dissipative and coherent coupling control leading to PT symmetry breaking [5] in cavity magnonics devices.

CAVITY DESIGN

- **Exploit the tunability of magnon based applications** to lead the system to the dissipative regime which features non-reciprocity
- **Hybrid system:** The chosen magnetic material is a 1mm diameter YIG sphere loaded in a 3-port microwave network
- **Additional drive:** By using an additional third port (phase port), used as a direct drive for the magnons, the amplitude ratio δ_0 and phase shift ϕ between the cavity input port and the magnon port can be controlled
- **The coupling strength** can be either purely real, complex or purely imaginary, allowing us to tune the system's coupling regime from coherent to dissipative at will $\rightarrow g'(\delta_0, \phi) = g \sqrt{1 + \delta_0 e^{i\phi}}$
- **3-port reentrant microwave cavity:**
 - Homogenous RF magnetic field between the two posts of the cavity The phase port is a loop antenna encircling the YIG sphere
 - By unequally splitting the power and dephasing the input port and the phase port we can control the coupling between magnons and cavity photons

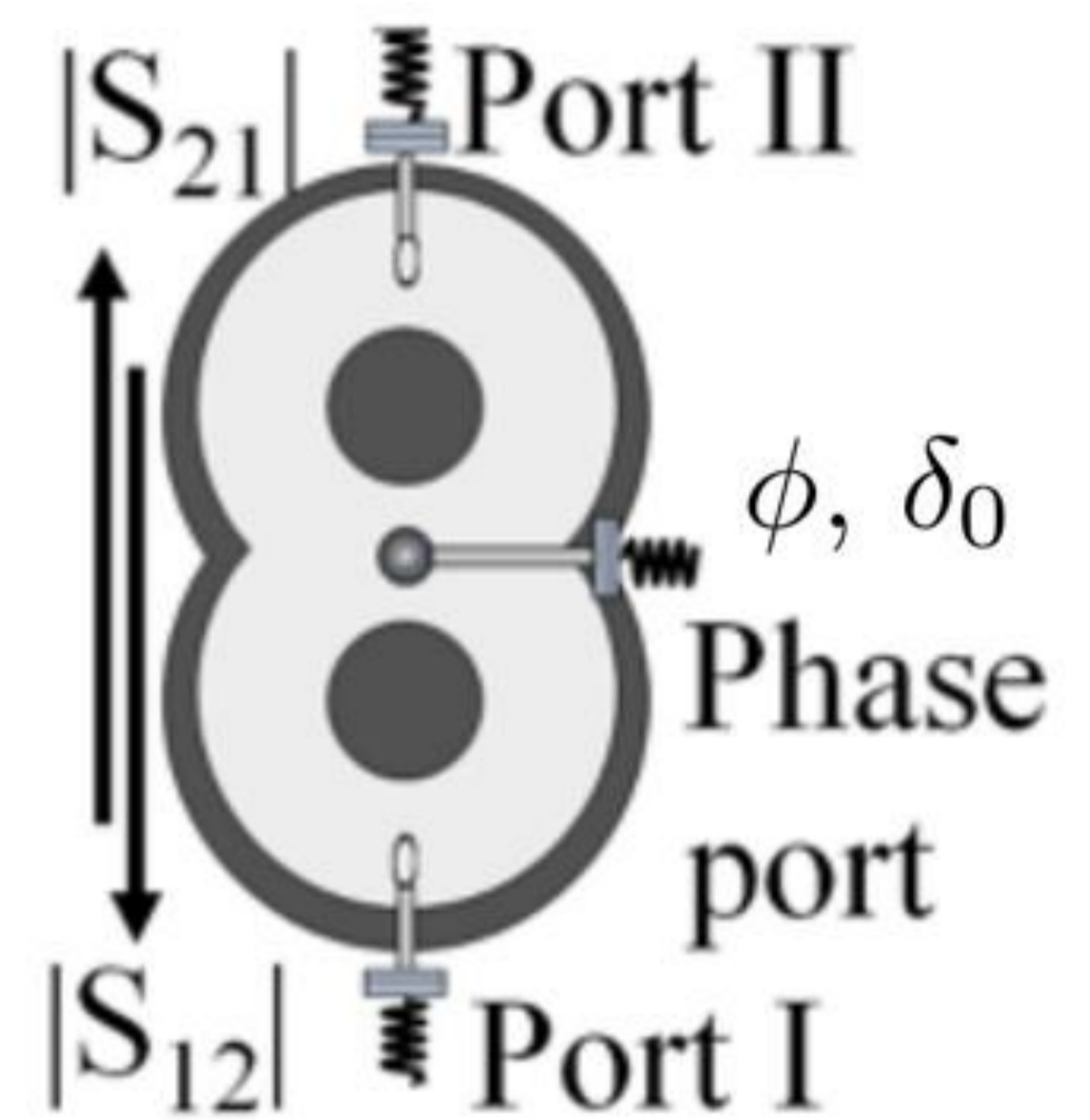
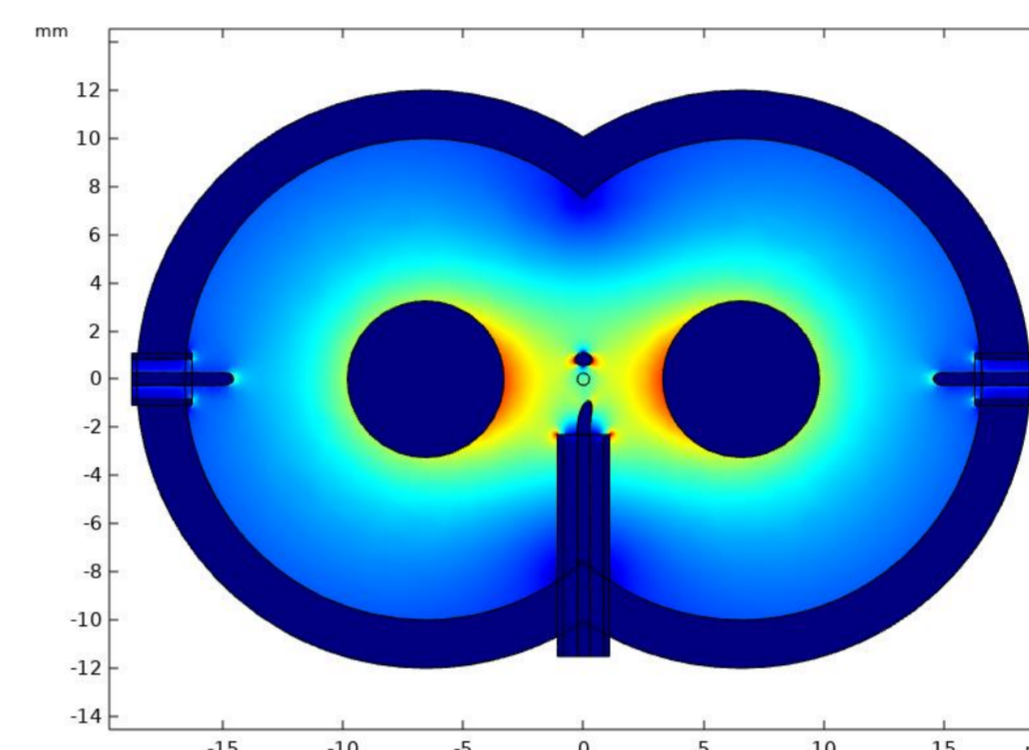

THEORETICAL APPROACH

Input-output formalism:

- The input-output formalism describes the interaction between a cavity system and its environment by allowing the system to couple to external modes
- Three different sets of bath photons are associated to each of the three ports of the cavity

$$H_{\text{sys}} = \hbar\omega_c a^\dagger a + \hbar\omega_m b^\dagger b + \hbar g(b^\dagger a + (1 + \delta_0 e^{i\phi}) a^\dagger b)$$

$$\tilde{\omega}_\pm = \frac{\tilde{\omega}_c + \tilde{\omega}_m}{2} \pm \frac{1}{2} \sqrt{(\tilde{\omega}_c - \tilde{\omega}_m)^2 + 4g^2(1 + \delta_0 e^{i\phi})}$$

$$S_{21} = -\frac{2\sqrt{\kappa_d}(\sqrt{\kappa_c} + \sqrt{\kappa_\mu} \frac{ig\delta_0 e^{i\phi}(1 + \delta_0 e^{i\phi})}{i(\omega - \omega_m) - \kappa_b})}{i(\omega - \omega_c) - \kappa_L + \frac{g^2(1 + \delta_0 e^{i\phi})}{i(\omega - \omega_m) - \kappa_b}}$$

$$S_{12} = -\frac{2\sqrt{\kappa_c \kappa_d}}{i(\omega - \omega_c) - \kappa_L + \frac{g^2(1 + \delta_0 e^{i\phi})}{i(\omega - \omega_m) - \kappa_b}}$$

Exceptional points are special singularities, unique to non-Hermitian systems, which refer to degeneracies of the system with coalescent eigenstates. Those points arise for balanced loss and gain in open systems

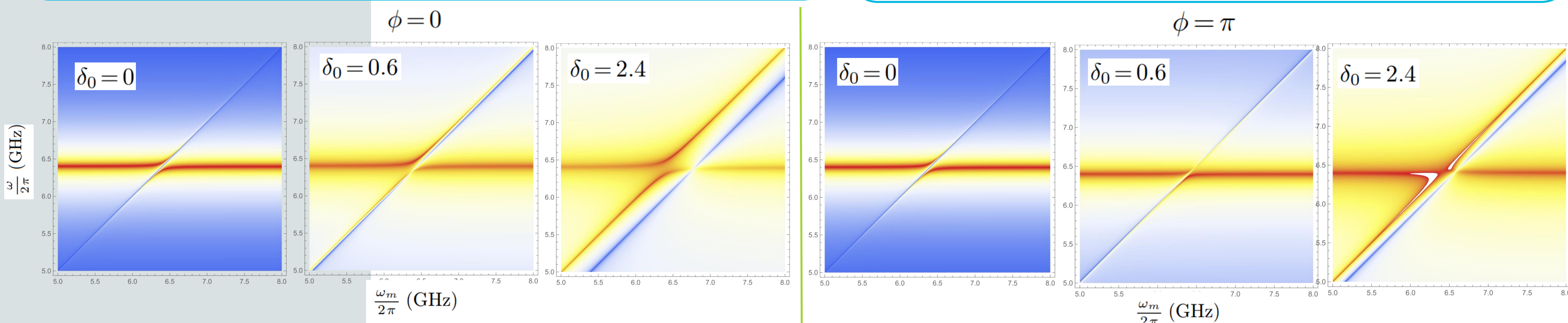
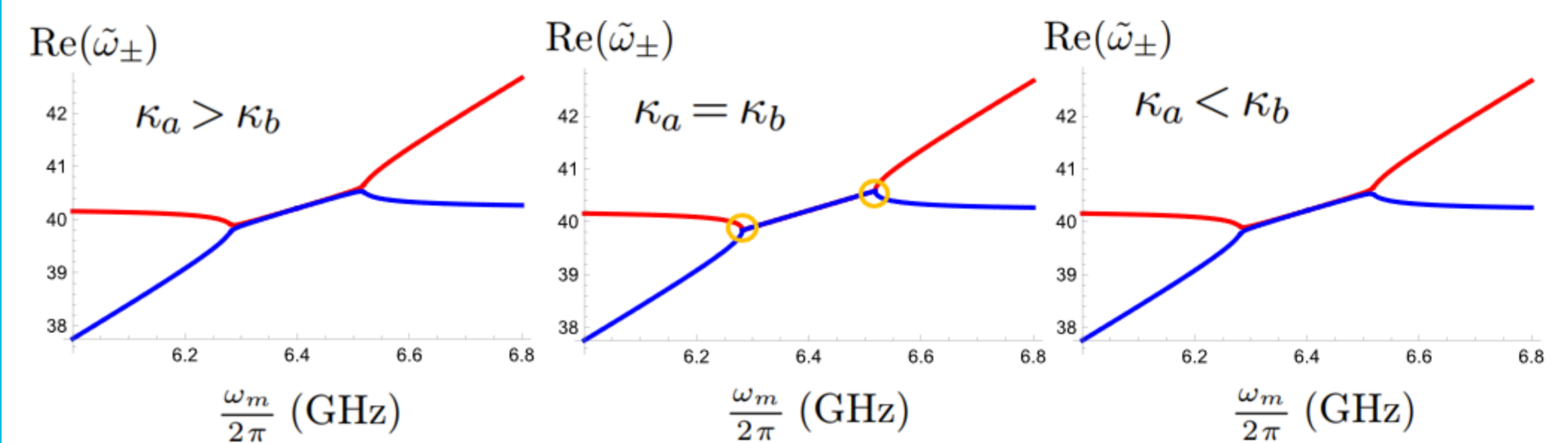

COMSOL® MODELLING

- After determining the tuning parameters with theory, we develop a simulation model
- By using an unequal power splitter and by tuning the phase difference between the two input ports, we can control the coupling value computed by COMSOL®
- We fully model an unequal power splitter directly connected to the cavity
- The phase difference between the cavity port and the phase port is controlled by tuning the dielectric constants of each coaxial cable

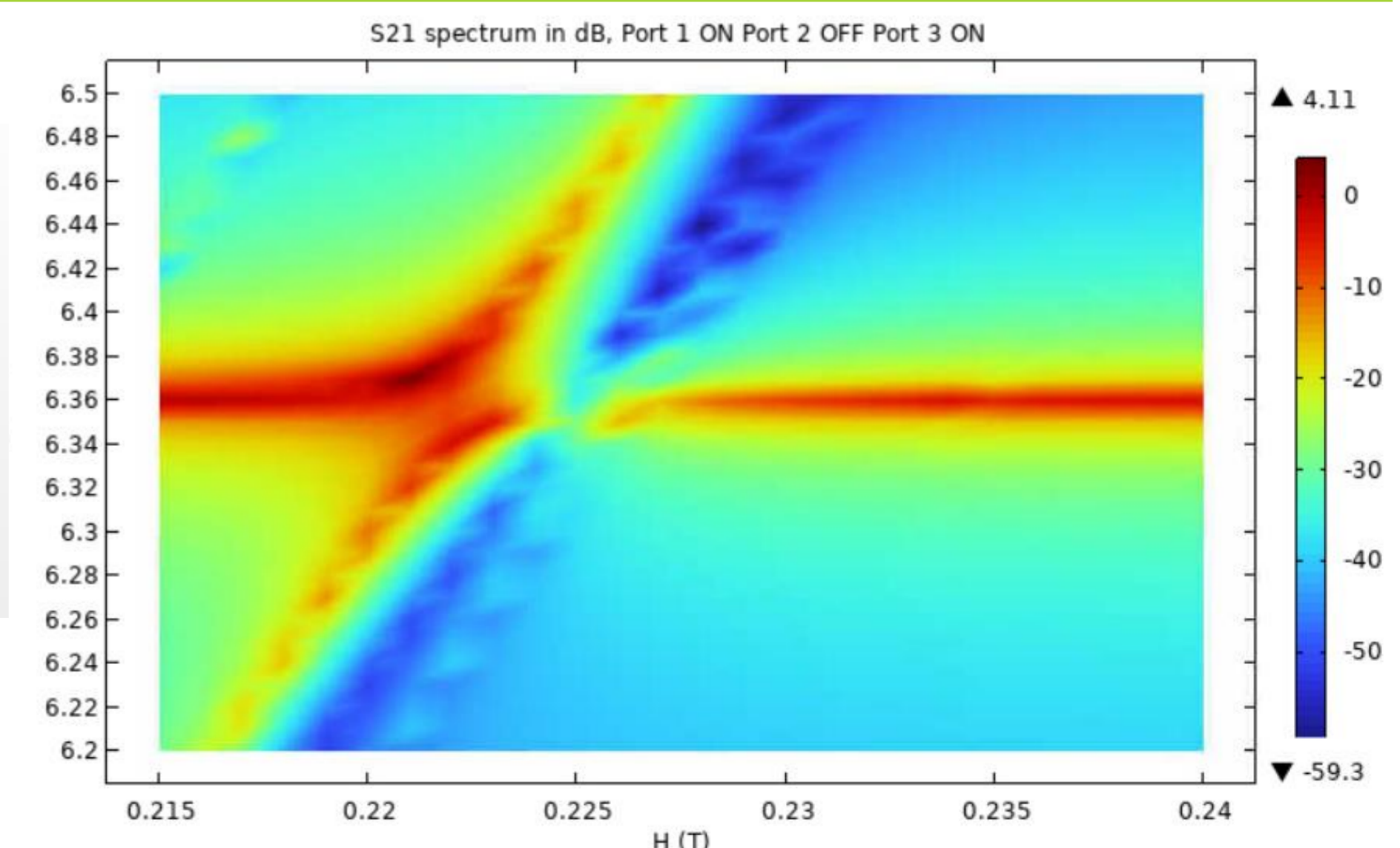
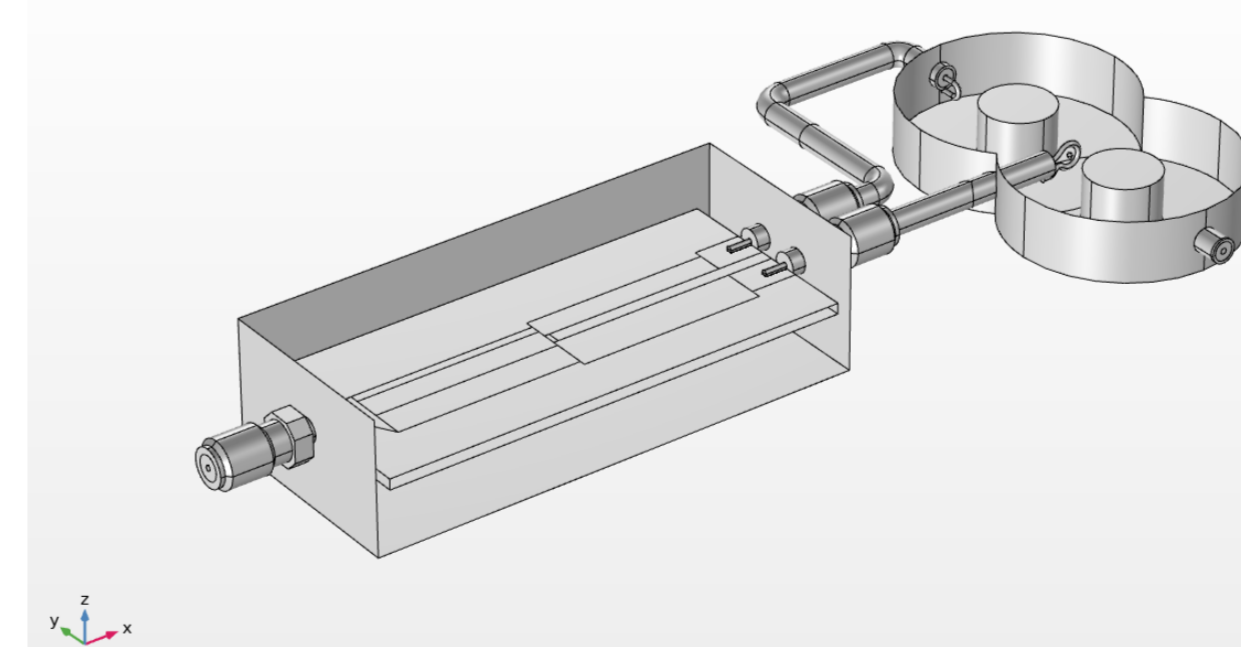

CONCLUSION & PERSPECTIVES

- We manage to build a full model on COMSOL®, combining a power splitter and a reentrant cavity
- Extension of the theoretical model from [3] in order to understand the dissipative coupling in magnon photon two tone driven system
- The coherent coupling has been reached, but the dissipative one has not been achieved yet
- Enhancing of the coupling strength Investigation of new two-tone reentrant cavity designs

REFERENCES

- [1] Lachance-Quirion *et al.*, Appl. Phys. Express 12 (2019) 070101.
- [2] Rameshti *et al.*, Physics Reports 979 (2022) 1–61.
- [3] Boventer *et al.*, Phys. Rev. Research 2, (2020) 013154
- [4] Grigoryan *et al.*, Phys. Rev. B 98, (2018) 024406
- [5] Wang *et al.*, Phys. Rev. Lett. 123 (2019) 127202.

ACKNOWLEDGEMENTS

