



**HAL**  
open science

## On the Sensorless PMSM Rotor Position Estimation Enhancement: Application of ADALINE-PLL

Amirhossein Malekipour, Adrien Corne, Lauric Garbuio, Pierre Granjon,  
Laurent Gerbaud

► **To cite this version:**

Amirhossein Malekipour, Adrien Corne, Lauric Garbuio, Pierre Granjon, Laurent Gerbaud. On the Sensorless PMSM Rotor Position Estimation Enhancement: Application of ADALINE-PLL. EPE'23 ECCE-Europe 2023 - The 25th Conference on power Electronics and Applications, Sep 2023, Aalborg, Denmark. hal-04212173

**HAL Id: hal-04212173**

**<https://hal.science/hal-04212173v1>**

Submitted on 20 Sep 2023

**HAL** is a multi-disciplinary open access archive for the deposit and dissemination of scientific research documents, whether they are published or not. The documents may come from teaching and research institutions in France or abroad, or from public or private research centers.

L'archive ouverte pluridisciplinaire **HAL**, est destinée au dépôt et à la diffusion de documents scientifiques de niveau recherche, publiés ou non, émanant des établissements d'enseignement et de recherche français ou étrangers, des laboratoires publics ou privés.

# On the Sensorless PMSM Rotor Position Estimation Enhancement: Application of ADALINE-PLL

Amirhossein Malekipour<sup>1</sup>, Adrien Corne<sup>1</sup>, Lauric Garbuio<sup>1</sup>, Pierre Granjon<sup>2</sup>, and Laurent Gerbaud<sup>1</sup>

<sup>1</sup>Univ. Grenoble Alpes, CNRS, Grenoble INP, G2ELab, F38000 Grenoble, France

<sup>2</sup>Univ. Grenoble Alpes, CNRS, Grenoble INP, GIPSA-lab, F38402 Saint Martin d'Herès Cedex, France

E-mail: Amirhossein.malekipour@g2elab.grenoble-inp.fr

*Index Terms*—Filtering, Frequency estimation, Harmonics, Neural networks, PLL.

*Abstract*—Considering the sensorless control of PMSM drives, a novel observer for improving the estimation performance is proposed in this paper. An Adaptive linear neuron (ADALINE)-based feed-forward harmonic compensation block is integrated into the classic PLL, which together form an ADALINE-PLL. Firstly, given a general input, the estimation error of a classic PLL is analytically investigated. It is shown that the estimation error contains several distinctive harmonics, which are related to the PLL non-linear structure and input harmonics. These harmonics are able to pass through the loop-filter and appear in the estimated phase and frequency as extra ripple. In light of the estimation error harmonics, the ADALINE-PLL is used for suppression of undesired harmonics. Secondly, the superior performance of ADALINE-PLL, compared to PLL, is verified through simulations in several different conditions. In case of acoustic noise-based or EMF-based PMSM sensorless control, the observer input signals contain several harmonics, which can easily distort the estimation performance if not properly repressed. As the result, the positive impact of ADALINE-PLL on the estimation performance is studied in details.

## I. INTRODUCTION

Phase-locked loop (PLL) is one of the widely-used control blocks in modern power electronics applications, including grid-tied converters, uninterruptible power supplies (UPS), and sensorless control of electric drives. PLL is mainly used for estimation of phase and frequency of the input signal. Each PLL comprises a loop filter (PI regulator for instance), a voltage-controlled oscillator (VCO) realized by an integrator, and a sinusoidal feedback path. The input signal is multiplied by the

sinusoidal output of VCO, this signal is then passed through the loop filter and again fed to the VCO for the loop to be closed[1].

For grid synchronization purposes, where the grid frequency fluctuations are strictly limited, a feed-forward term equal to the nominal grid frequency is added to the estimated frequency and this structure is called synchronous reference frame PLL (SRFPLL). Although SRFPLL has rapid response with low settling time, phase jump at start-up and extra harmonics at the estimated values are observed within its performance.

Consequently, enhanced version of the classical PLL and SRFPLL, known as EPLL, is proposed by which the mentioned problems are approached [2]. It is to be mentioned that, SRFPLL and EPLL cannot be used in sensorless control of electric drives. The reason for that is the input signal frequency, which is directly linked to the rotor speed, varies in a wide range which is beyond the lock-in range of SRFPLL (or EPLL). Consequently, the classical PLL is widely used in such applications.

PLL showcases its peak performance when the input is a pure sinusoidal signal, but it is nearly impossible in real case scenarios (due to the noise, sampling error, etc.). As the result, elimination of the input signal harmonics are essential. Harmonic elimination using passive filters is considered unacceptable in most applications since there would be amplitude attenuation and phase lag in the processed signal. Therefore, finding an alternative way is of paramount importance.

Frequency synchronization of grid-tied converters, while the voltage is highly distorted, is realized by using a multi resonant frequency-locked loop [3]. Adaptive linear neuron (ADALINE)-based filters, also known as LMS filters, are shown to be a promising alternative with rapid response and without amplitude attenuation. For a grid voltage with so many harmonics, ADALINE filter

is used and each harmonic with its actual amplitude is extracted [4]. Application of ADALINE in active power filters and smart grids with the purpose of fundamental frequency extraction are also reported in [5],[6].

In a permanent magnet synchronous motor (PMSM) sensorless control, ADALINE is used for elimination of estimated Back Electromotive Force (EMF) harmonics [7]. Moreover, in a 5-phase PMSM, the PLL is thoroughly replaced by an ADALINE-based observer for rotor position estimation enhancement [8].

Sensorless control of PMSM drives using the machine output acoustic noise is reported in [9]. The inputs to the observer (PLL), in this method, are extracted using a band-pass filter-based signal processing algorithm in such a manner to have the least amount of harmonics. But, there exist extra harmonics in the estimated values which are attributed to the nonlinear structure of PLL.

Regarding the undesired harmonics appeared within the estimated values in PMSM sensorless applications, this paper integrates an ADALINE-based harmonic compensation block into the PLL (ADALINE-PLL). The proposed ADALINE-PLL ensures that the unwanted harmonics in the estimated values are conspicuously alleviated and thus the estimation performance is improved (without filtering or manipulating the input waveforms).

In sensorless control applications and as the estimated speed (frequency) and position (phase) are fed to the coordinate transformation blocks, existence of extra harmonics (extra ripple) leads to the d-axis misplacement and thus the performance degradation. It is worth mentioning that passing the estimated values through a low-pass filter might seem to be a way to suppress the harmonics, but this method slows down the overall current and speed loop dynamics (or could even make the overall system unstable).

This paper is organized as follows: Section II reviews the fundamentals of PLL and ADALINE-based filtering. Following that, Section III describes the structure of the proposed ADALINE-PLL. In Section IV, the performance of ADALINE-PLL is compared with that of conventional PLL topologies in two scenarios (EMF-based and acoustic noise-based sensorless controls). Finally, the conclusion is provided in Section V.

## II. FUNDAMENTALS

### A. PLL Operation

Considering a general PLL shown in Fig. (1) with the input and output signals respectively given in (1), (2):

$$V_{in} = A \cdot \sin(\omega_{in}t + \varphi_{in}) \quad (1)$$

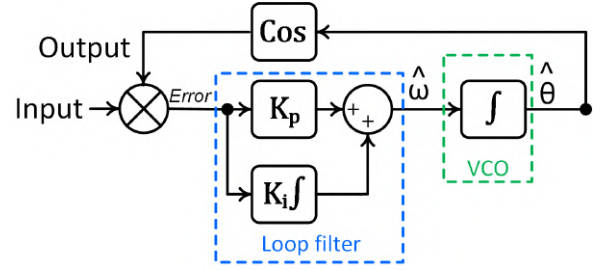

Fig. 1. General structure of a PLL.

$$V_{out} = \cos(\hat{\omega}t + \hat{\varphi}) \quad (2)$$

the error term is obtained as shown in (3), containing a high- and low-frequency term. Amplitude, frequency, and phase for the input signal are respectively denoted by  $A$ ,  $\omega$ ,  $\varphi_{in}$  and the estimated output frequency and phase are respectively defined by  $\hat{\omega}$  and  $\hat{\varphi}$ .

$$Error = \underbrace{\frac{A}{2} \sin((\omega_{in} + \hat{\omega})t + (\varphi_{in} + \varphi))}_{High-frequency} + \underbrace{\frac{A}{2} \sin((\omega_{in} - \hat{\omega})t + (\varphi_{in} - \varphi))}_{Low-frequency} \quad (3)$$

Considering the linearized model and in the steady-state condition, during which the estimated values have reached the actual ones, the error term can be simplified as:

$$Error = \frac{A}{2} \left( \underbrace{\sin[2(\omega_{in}t + \varphi_{in})]}_{e_{2\omega}} + \underbrace{\Delta\varphi}_{dc} \right) \quad (4)$$

where there are a dc term, which is eliminated by the loop filter, and a sinusoidal term, which has double the input frequency and is the most important issue in classical PLL. The sinusoidal term is not diminished through the loop filter and appears in the estimated values as extra ripple [1].

In the actual nonlinear PLL model, even if the input is a pure sinusoidal signal without any distortion, the output contains odd harmonics of the input (among which only the harmonic orders of 1, 3, and 5 are dominant). Given (3) and as the result, the error term always carries even-order harmonics of the input ( $2^{nd}$ ,  $4^{th}$ , and  $6^{th}$ ).

Such a scenario is shown in Fig. (2), where the input is a pure sinusoidal signal with the frequency of  $200Hz$  and the output and error signals (in the steady-state condition of PLL) are shown. As expected, the output

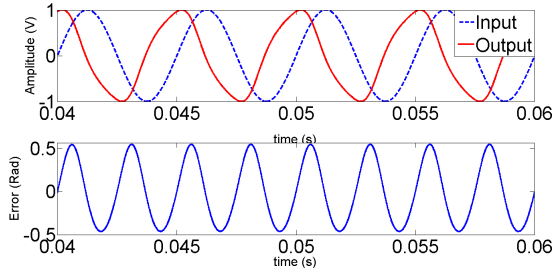

Fig. 2. Input, output , and error waveforms.

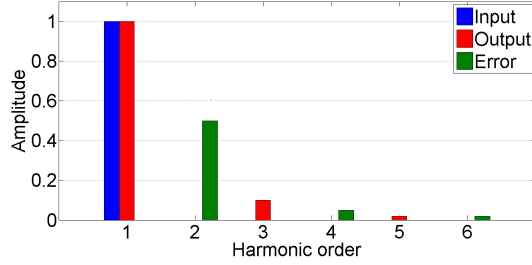

Fig. 3. FFT of the input, output , and error waveforms.

contains odd-order harmonics of the input and the error, as the result, contains even-order harmonics which are shown in Fig. (3).

Considering an input with multiple frequency components, the interaction of input and output yields a distorted error which highly contaminates the estimated values (frequency and phase). Therefore, without input filtering, an ADALINE-based harmonic elimination block is integrated into the PLL by which the undesired error harmonics are suppressed and the estimation performance is improved.

### B. Adaptive Linear Neuron (ADALINE)-Based Filtering

Considering a periodic input signal with any arbitrary waveform and a given Fourier series as:

$$f(t) = f_{dc} + \sum_{n=1}^{\infty} (a_n \sin(n\omega t) + b_n \cos(n\omega t)) \quad (5)$$

The input can be linearly decomposed into the sum of multiple terms shown as [10]:

$$f(t) = W^T \cdot X \quad (6)$$

where  $W$  is the matrix of coefficients, also called the weights matrix, and  $X$  denotes the input defined as follows.

$$W^T = [ \alpha_{dc} \quad \alpha_1 \quad \beta_1 \quad \cdots \quad \alpha_n \quad \beta_n ] \quad (7)$$

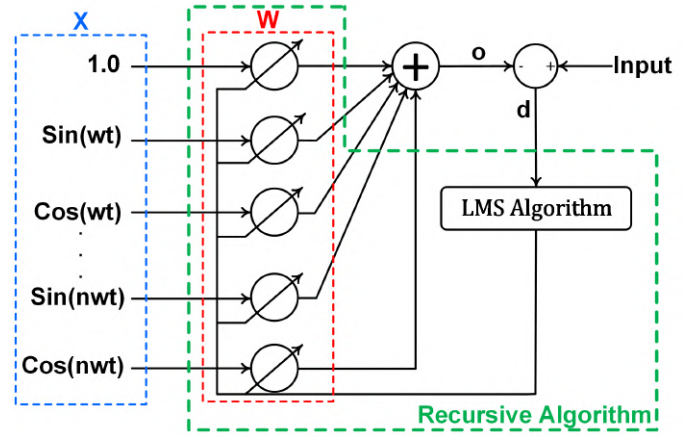

Fig. 4. Configuration of an ADALINE.

$$X = \begin{bmatrix} 1 \\ \sin(\omega t) \\ \cos(\omega t) \\ \vdots \\ \sin(n\omega t) \\ \cos(n\omega t) \end{bmatrix} \quad (8)$$

By using a recursive algorithm, like the Least Mean Square (LMS), the coefficient matrix is continuously updated until its actual values match the actual coefficients of the signal Fourier series (until a one-to-one correspondence is reached). A learning rate ( $\mu$ ) is also included in the LMS algorithm by which the speed of convergence is determined. The value of learning rate is assigned using trial and error in each condition, but must always be positive and lower than unity ( $0 < \mu < 1$ ) to make sure that the system serves as a stable, non-linear negative feedback loop.

The update rule for the coefficient matrix is given in (9) where  $k$  denotes the instance of calculation,  $d$  represents the estimation error of ADALINE (given in (10)), and  $o(t)$  is the ADALINE output [10]. The overall configuration of an ADALINE is also illustrated in Fig. (4).

$$W^{k+1} = W^k + X^k \cdot \mu \cdot d^k \quad (9)$$

$$d(t) = f(t) - o(t) \quad (10)$$

Knowing the input frequency components, ADALINE synthesizes the input waveform at its output by making the error equal to zero (through its iterative algorithm).

Consequently, ADALINE can be used as an iteration-based filter for extracting any desired component from the distorted input.

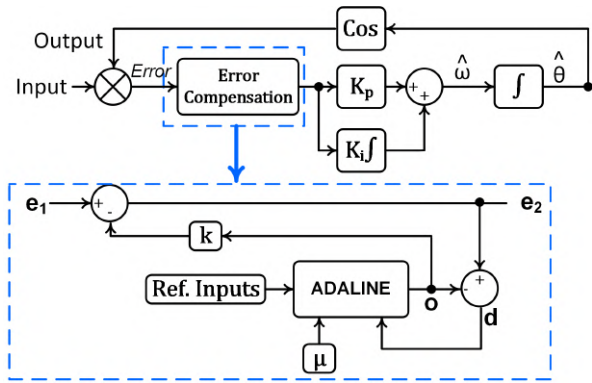

Fig. 5. ADALINE-PLL structure.

### III. ADALINE-PLL

The overall configuration of an ADALINE integrated into a PLL is shown in Fig. (5). The ADALINE-PLL operates as follows:

- Regarding the input signal, undesired frequency components in the PLL error are firstly obtained.
- Reference signals (the matrix  $X$ ), having frequencies equal to the PLL error harmonics, are fed to the ADALINE. Therefore, ADALINE outputs the reference signals.
- ADALINE error ( $d$ ) is fed back to the system for the loop to be closed. ADALINE error contains all the PLL error harmonics except those generated at the ADALINE output.
- An appropriate learning rate is chosen for making sure that the filtering process is accomplished with acceptable transient speed and accuracy.
- The scaled version of ADALINE output is used and fed forward to the PLL error, by which the desired harmonics are actively compensated.
- The coefficient  $k$  is added at the output of the feed-forward path by which the amplitude of the generated signal is scaled and the level of harmonic suppression in the PLL error is controlled accordingly.
- Depending on the level of PLL input harmonic contamination, the coefficients  $k$  and  $\mu$  must be chosen in a trial-and-error manner to achieve the best performance.
- An important design criterion is that the ADALINE convergence speed must be conveniently faster than that of PLL, in order to make sure that the ADALINE learning rate transient does not negatively impact the estimation speed of PLL.
- Given each dominant harmonic within the PLL error, an ADALINE must be used; therefore, in

case the error contains several distinctive harmonics, multiple ADALINES should be paralleled to make sure the impact of each individual harmonic is properly compensated.

In the following section, the effectivity of using ADALINE-PLL is investigated in different scenarios.

### IV. SIMULATION RESULTS

Throughout this section, firstly the ADALINE-PLL performance is inspected in a condition where the input is heavily contaminated with low-order harmonics. This scenario (Scenario I) is included in the paper to represent the cases like grid voltage or EMF waveforms (in model-based PMSM sensorless control) with extra low-order harmonics.

In the second scenario (Scenario II), the disseminated acoustic noise of a PMSM is captured and given the algorithm proposed in [9], two orthogonal speed-dependent signals are extracted which are the PLL inputs. The PLL inputs in this condition (in contrast to Scenario I) do not contain the undesired low-order harmonics, yet the estimated values and PLL error still contain the detrimental even-order harmonics. Consequently, the ADALINE-PLL is used and its superior performance, compared with the classical PLL, is shown.

#### A. Scenario I: Input With Low-order Harmonics - Representing the Grid Voltage or EMF Waveforms

Assuming a system with a per-unit voltage equation as below:

$$V_{in}(t) = \sin(200\pi t) + 0.33 \sin(600\pi t) + 0.2 \sin(1000\pi t) \quad (11)$$

the fundamental component is at  $100\text{Hz}$  and there are the third and fifth harmonic orders, at  $300\text{Hz}$  and  $500\text{Hz}$ , added as distortions.

Given the closed-loop transfer function of a PLL, given in (12), the characteristic equation represents a second-order system with the parameters defined in (13).

$$PLL(s) = \frac{K_p s + K_i}{s^2 + K_p s + K_i} \quad (12)$$

$$\begin{cases} K_p = 2\xi\omega_F \\ \frac{\omega_F^2}{4} \leq K_i \leq \omega_F^2 \\ \omega_F = 2\pi f_F \\ 0 < \xi \leq 1 \end{cases} \quad (13)$$

where  $\xi$  is the damping ratio and  $f_F$  is the fundamental frequency of the PLL input signal.

The loop filter acts as a low-pass filter (LPF) and the high-frequency distortions in the input cannot pass

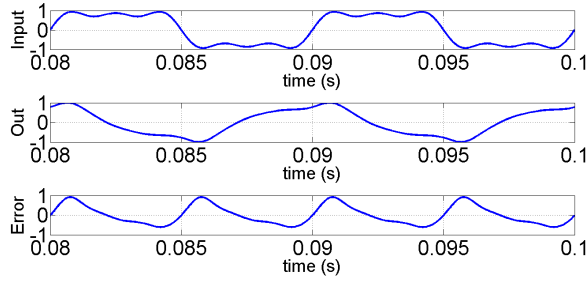

Fig. 6. Waveforms of input, output, and error of PLL.

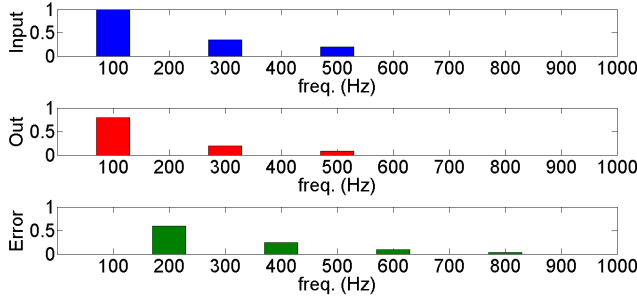

Fig. 7. FFT of input, output, and error of PLL.

through, however, odd multiples of the fundamental frequency are appeared in the output waveform (discussed earlier) as given in (14).

$$V_{out} = A_1 \sin(200\pi t) + A_3 \sin(600\pi t) + A_5 \sin(1000\pi t) \quad (14)$$

As the result, the error is obtained as follows.

$$Error = \frac{A_1 - A_3}{2} \sin(400\pi t) + \frac{A_3 - A_5}{2} \sin(800\pi t) + \frac{A_5}{2} \sin(1200\pi t) \quad (15)$$

It is observed that the error contains the 2<sup>nd</sup>, 4<sup>th</sup>, and 6<sup>th</sup> harmonics of the fundamental frequency, which are passed through the loop filter and appeared in the estimated values. Waveforms of the input, output and PLL error are illustrated in Fig. (6). Moreover, FFT of these waveforms, certifying the analyses done in (11)-(15), are shown in Fig. (7).

Given Fig. (7), the harmonic at 200Hz in the PLL error is dominant, so the ADALINE is tuned at this frequency. The performance of PLL, SRFPLL, and ADALINE-PLL are compared and shown in Fig. (8)-Fig. (11). Error waveforms, in time and frequency domains, are compared in Fig. (8) and Fig. (9). It is obvious that ADALINE-PLL outperforms the PLL since the

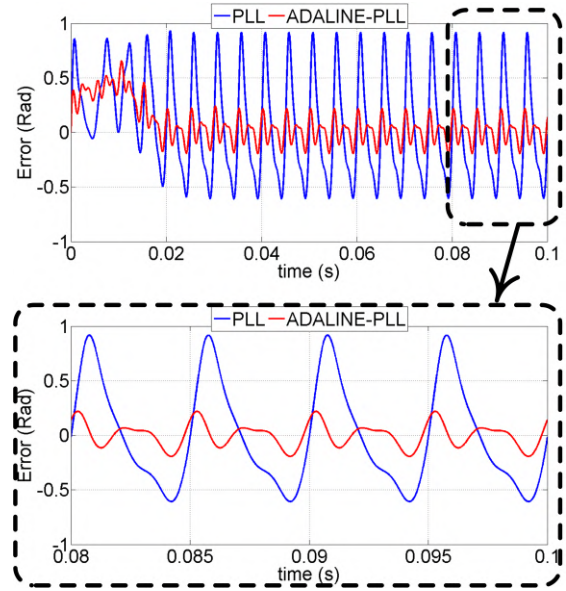

Fig. 8. Error waveform comparison.

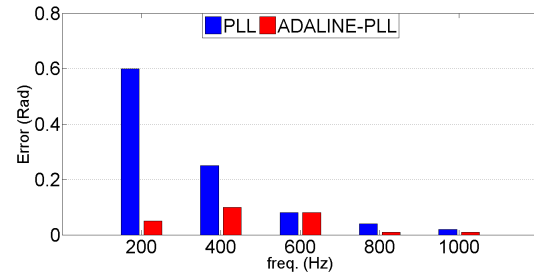

Fig. 9. Error FFT comparison.

magnitude of error harmonics (at 200Hz and 400Hz) are respectively reduced by 91.67% and 60%.

Frequency estimation performance is also investigated in Fig. (10). There is a peak-to-peak ripple of 15Hz in PLL estimation, while it is reduced to around 2Hz in ADALINE-PLL (86% reduction). Performance of SRFPLL is also included in the figure and it is observed that ADALINE-PLL is able to compete with SRFPLL. It should be noted that SRFPLL, due to its structure, cannot be used in sensorless applications since the estimated frequency varies extensively, which is beyond the lock-in range of SRFPLL.

The phase estimation performance is compared in Fig. (11). It can be noticed that there exists a low-frequency ripple in the PLL performance, while there is not any in the SRFPLL and ADALINE-PLL performances. Similar to the frequency estimation, ADALINE-PLL and SRFPLL have provided comparable performances in the phase estimation. A DC phase shift exists

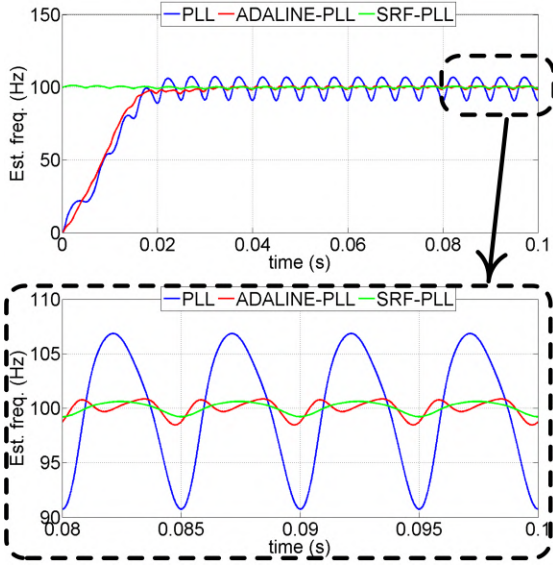

Fig. 10. Estimated frequency comparison.

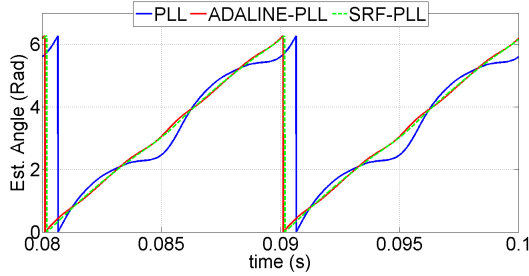

Fig. 11. Estimated phase comparison.

between the PLL and ADALINE-PLL estimated phases, which is attributed to the large frequency fluctuation existing in the PLL condition.

### B. Scenario II: Acoustic Noise-based PMSM Sensorless Control

In the context of PMSM sensorless control, mostly a quadrature-PLL (QPLL) is used. Although QPLL inherently showcases a better estimation performance compared to PLL, there are still low-order harmonics appeared in its error and estimated values. Therefore, ADALINE-QPLL can be used as shown in Fig. (12). In this scenario, the term ADALINE-PLL refers to the integration of ADALINE into QPLL.

The disseminated acoustic noise of PMSM in a condition with a high-frequency injected (HFI) voltage is investigated in [9]. It is shown that in the frequency-domain, in the proximity of the injected component, there are several sidebands with the frequencies directly related to the electrical fundamental frequency of the

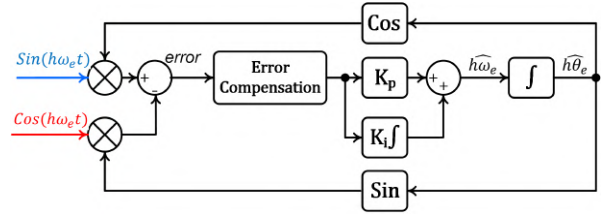

Fig. 12. Integration of ADALINE into QPLL.

TABLE I  
PARAMETERS OF THE STUDIED PMSM.

Parameter	Value
No. of Slots/Poles	9/6
Rated Power	1600W
Rated Speed	1500rpm
d-/q-Axis Inductances	140μH/178μH
Phase Resistance	97mΩ
PM Flux Linkage	39.5mWb

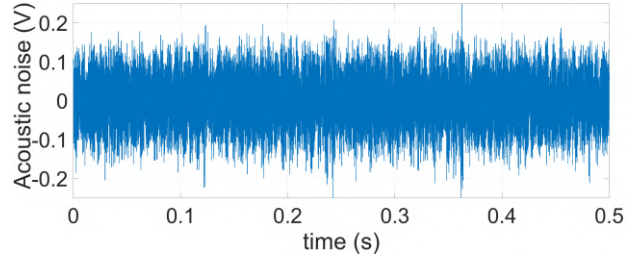

Fig. 13. The raw captured PMSM acoustic noise.

machine. It is shown that for a PMSM with the parameters given in Table. I, even-order harmonics of the fundamental electrical frequency are symmetrically placed around the injected frequency.

For the sake of illustration, the raw acoustic noise in addition to the processed signals are shown in Fig. (13) and Fig. (14). The processed signals, which contain the rotor speed and position information, are directly used as the QPLL input for the phase and frequency to be estimated. The orthogonal processed signals have the fundamental frequency of 150Hz with some small-amplitude, high-order harmonics. FFT of the input, output, and error of the QPLL are illustrated in Fig. (15).

Given the FFT analysis, however the input does not contain any low-order harmonic (multiples of the fundamental component), there is a 3<sup>rd</sup>-order harmonic appeared in the PLL output (at 450Hz) which results in the generation of the 2<sup>nd</sup>- and 4<sup>th</sup>-order harmonics in the error (at 300Hz and 600Hz). Consequently, the ADALINE is tuned for the component at 300Hz and the

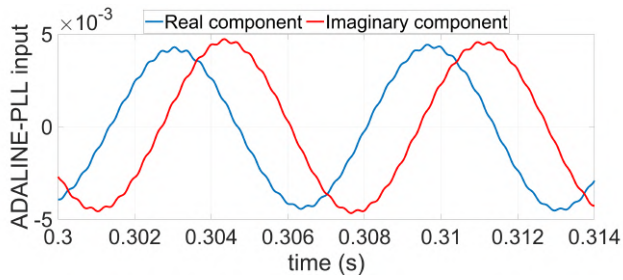

Fig. 14. Extracted speed-dependent orthogonal signals fed to the PLL for speed and position estimation.

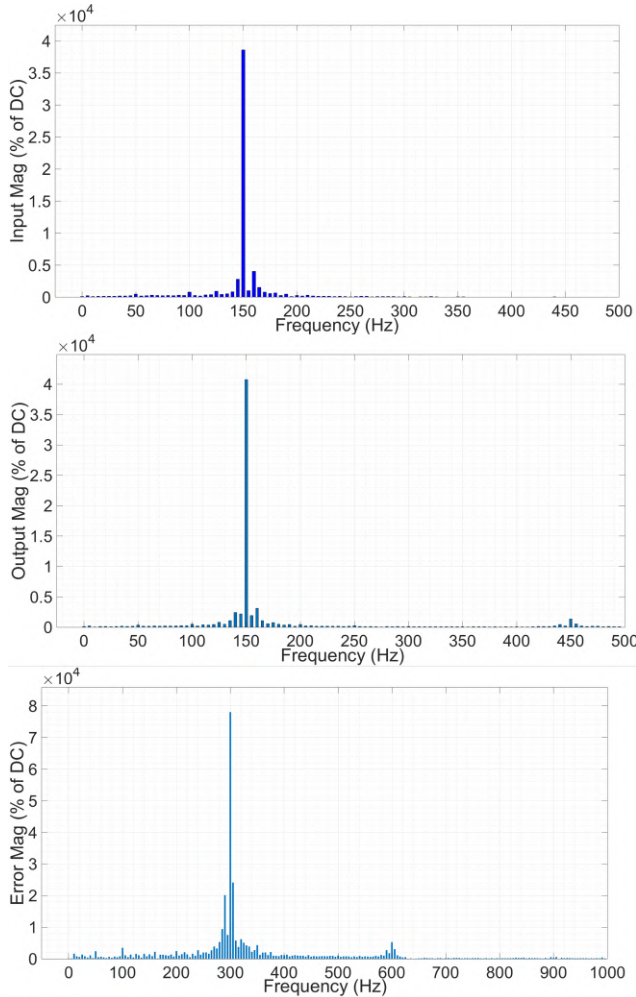

Fig. 15. FFT of input, output, and error of QPLL.

estimation performance of PLL and ADALINE-PLL are compared (the impacts of other components at  $600\text{Hz}$  and  $900\text{Hz}$ , due to their tiny magnitudes, are easily negligible).

Figure (16) compares the estimation error for PLL and ADALINE-PLL conditions. In PLL case, there is a peak-to-peak ripple of around  $0.3^\circ$  which is reduced to

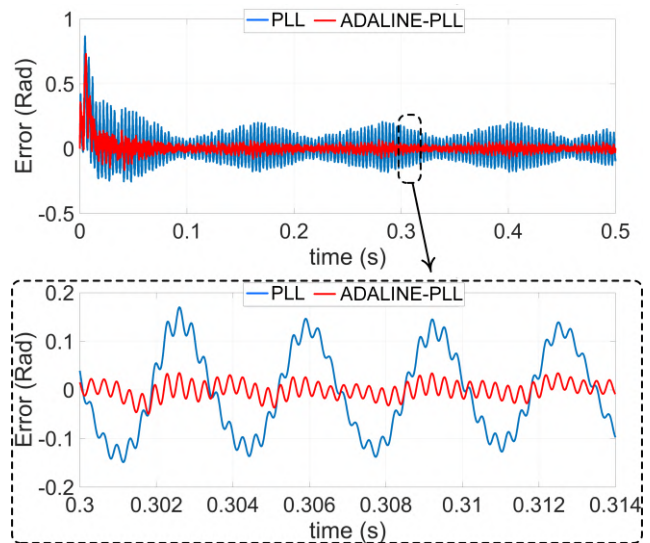

Fig. 16. Comparison of estimation error.

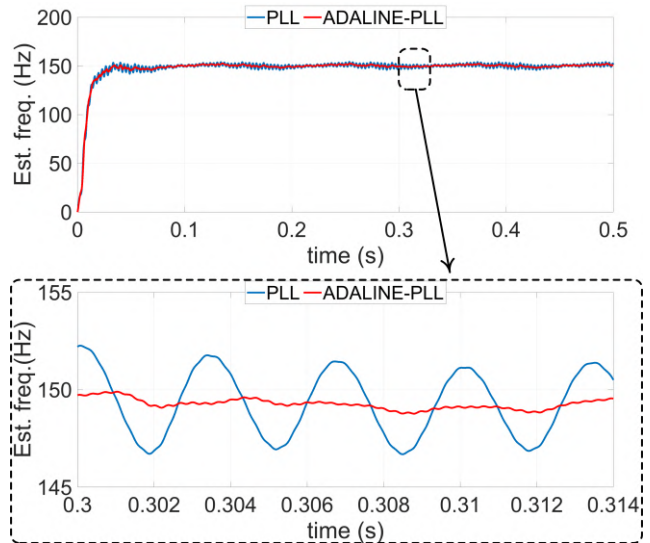

Fig. 17. Comparison of estimated frequency.

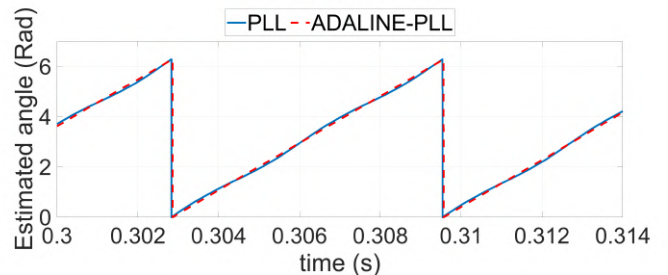

Fig. 18. Comparison of estimated position.

$0.05^\circ$  (equal to 83.3% improvement) when ADALINE-PLL is used.



The estimated frequency is compared in Fig. (17) where the frequency ripple is reduced from  $5Hz$  to less than  $1Hz$ , equal to 80% improvement. In addition, there is a double-frequency ripple on the estimated position which is almost repressed when ADALINE-PLL is used as shown in Fig. (18).

## V. CONCLUSION

In acoustic noise-based (or even EMF-based) sensorless control of PMSM drives, a pair of quadrature signals are extracted and fed to the PLL (by which the rotor position is estimated). Even if the extracted signals are perfectly extracted not to be polluted with low-order harmonics, there would be low-order harmonics in the PLL error and accordingly in the estimated values.

Therefore, an ADALINE-based harmonic compensation block is integrated into the PLL structure (called ADALINE-PLL) with the aim of alleviating the undesired error harmonics and enhancing the estimation performance.

The fundamentals of PLL and ADALINE-based filtering are firstly reviewed, then the structure of ADALINE-PLL is presented. Finally, the estimation performance of PLL and ADALINE-PLL (considering PMSM sensorless control) are compared. It is finally verified that the undesired low-order harmonics, appeared in the PLL estimated values, are noticeably repressed when ADALINE-PLL is used.

## REFERENCES

- [1] M. Karimi-Ghartemani, *Enhanced phase-locked loop structures for power and energy applications*. John Wiley Sons, 2014.
- [2] M. K. Ghartemani, S. A. Khajehoddin, P. K. Jain, and A. Bakhshai, "Problems of startup and phase jumps in PLL systems," *IEEE Transactions on Power Electronics*, vol. 27, no. 4, pp. 1830-1838, 2011.
- [3] P. Rodríguez, A. Luna, I. Candela, R. Mujal, R. Teodorescu, and F. Blaabjerg, "Multiresonant frequency-locked loop for grid synchronization of power converters under distorted grid conditions," *IEEE Transactions on Industrial Electronics*, vol. 58, no. 1, pp. 127-138, 2010.
- [4] P. Dash, D. Swain, A. Liew, and S. Rahman, "An adaptive linear combiner for on-line tracking of power system harmonics," *IEEE Transactions on Power Systems*, vol. 11, no. 4, pp. 1730-1735, 1996.
- [5] D. O. Abdeslam, P. Wira, J. Mercklé, D. Flieller, and Y.-A. Chapuis, "A unified artificial neural network architecture for active power filters," *IEEE transactions on industrial electronics*, vol. 54, no. 1, pp. 61-76, 2007.

- [6] Y. Han, "On Using ADALINE Algorithm for Harmonic Estimation and Phase-Synchronization for the Grid-Connected Converters in Smart Grid Applications," in *Adaptive Filtering-Theories and Applications: IntechOpen*, 2013.
- [7] G. Zhang, G. Wang, D. Xu, and N. Zhao, "ADALINE-network-based PLL for position sensorless interior permanent magnet synchronous motor drives," *IEEE Transactions on Power Electronics*, vol. 31, no. 2, pp. 1450-1460, 2015.
- [8] N. K. Nguyen, E. Semail, F. De Belie, and X. Kestelyn, "Adaline Neural Networks-based sensorless control of five-phase PMSM drives," in *IECON 2016-42nd Annual Conference of the IEEE Industrial Electronics Society*, 2016, pp. 5741-5746: IEEE.
- [9] A. Malekipour, A. Corne, L. Garbuio, P. Granjon, and L. Gerbaud, "A closed-loop pmsm sensorless control based on the machine acoustic noise," *IEEE Transactions on Industrial Electronics*, DOI 10.1109/TIE.200.3206755, pp. 1-10, 2022.
- [10] B. Widrow and M. A. Lehr, "30 years of adaptive neural networks: perceptron, madaline, and backpropagation," *Proceedings of the IEEE*, vol. 78, no. 9, pp. 1415-1442, 1990.