



HAL
open science

Feasibility study of a cryogenic power supply for superconducting DC devices

Lauro Ferreira, Yasmine Baazizi, Simon Meunier, Tanguy Phulpin, Richard Beljio, Frederic Trillaud, Tian-Yong Gong, Gustavo Henn, Loic Queval

► To cite this version:

Lauro Ferreira, Yasmine Baazizi, Simon Meunier, Tanguy Phulpin, Richard Beljio, et al.. Feasibility study of a cryogenic power supply for superconducting DC devices. MT-28 International Conference on Magnet Technology, Sep 2023, Aix-en-Provence (France), France. hal-04210294

HAL Id: hal-04210294

<https://hal.science/hal-04210294>

Submitted on 18 Sep 2023

HAL is a multi-disciplinary open access archive for the deposit and dissemination of scientific research documents, whether they are published or not. The documents may come from teaching and research institutions in France or abroad, or from public or private research centers.

L'archive ouverte pluridisciplinaire **HAL**, est destinée au dépôt et à la diffusion de documents scientifiques de niveau recherche, publiés ou non, émanant des établissements d'enseignement et de recherche français ou étrangers, des laboratoires publics ou privés.

Feasibility study of a cryogenic power supply for superconducting DC devices

Lauro FERREIRA^{1,2}, Yasmine BAAZIZI^{1,2}, Simon MEUNIER^{1,2}, Tanguy PHULPIN^{1,2}, Richard BELJIO^{1,2}, Frederic TRILLAUD³, Tian-Yong GONG^{1,2}, Gustavo HENN^{1,2}, Loic QUÉVAL^{1,2}

¹Université Paris-Saclay, CentraleSupélec, CNRS, GeePs, 91192, Gif-sur-Yvette, France. ²Sorbonne Université, CNRS, GeePs, 75272, Paris, France. ³Instituto de Ingeniería, UNAM, Mexico City, MEXICO.

Purposes

- Alternative option to **dispense the current leads**, responsible of high losses in superconducting systems [1].
- Design of a **superconducting transformer** with its **diode rectifier** operational at cryogenic temperature.

System design

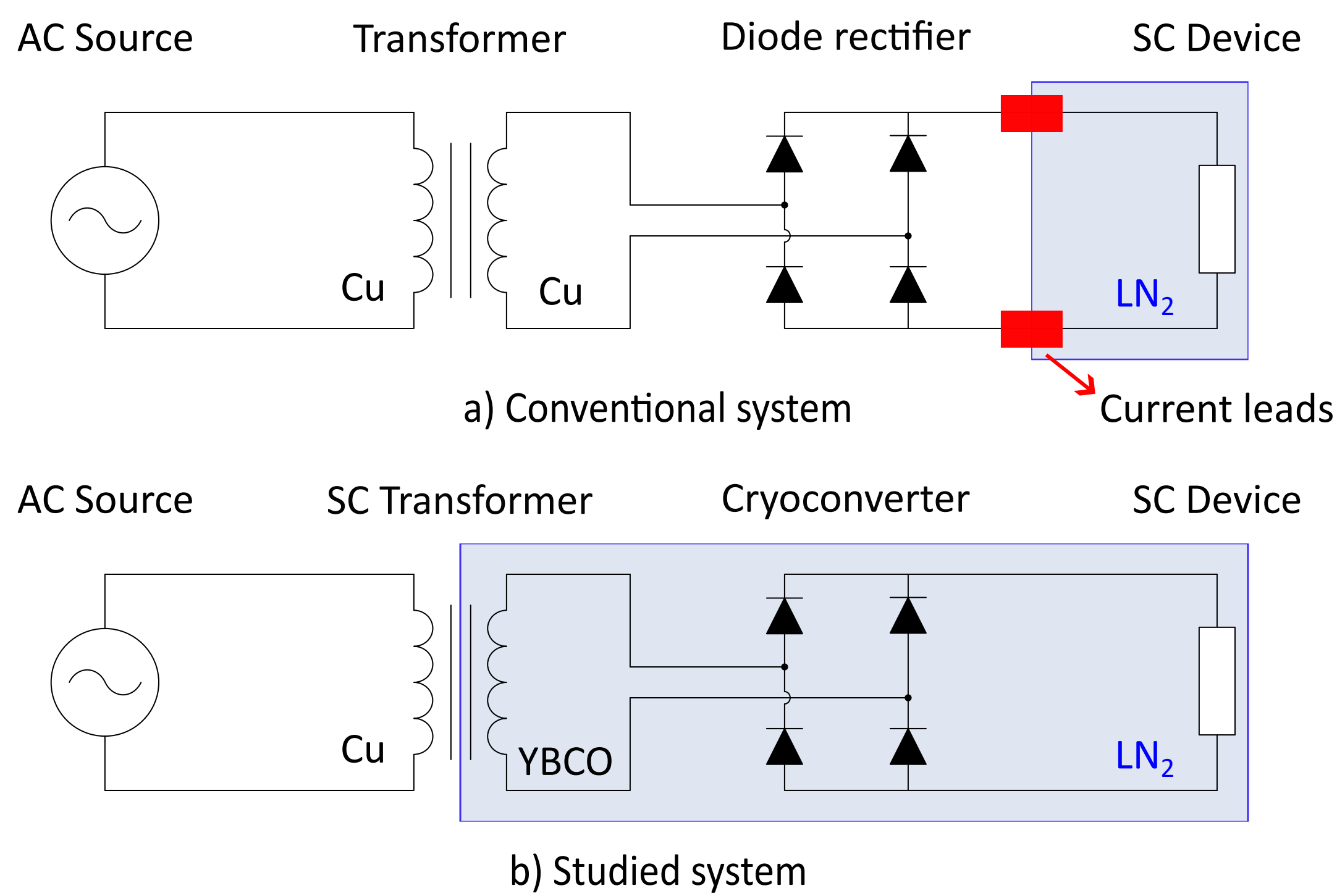

Fig. 1 - DC superconducting device power supply system.

Superconducting transformer

Double pancake coil

- A **coil winding configuration** where two pancake coils are stacked on top of each other.
- After the coil characterization in LN₂, we measured a **critical current of ~ 40 A**.

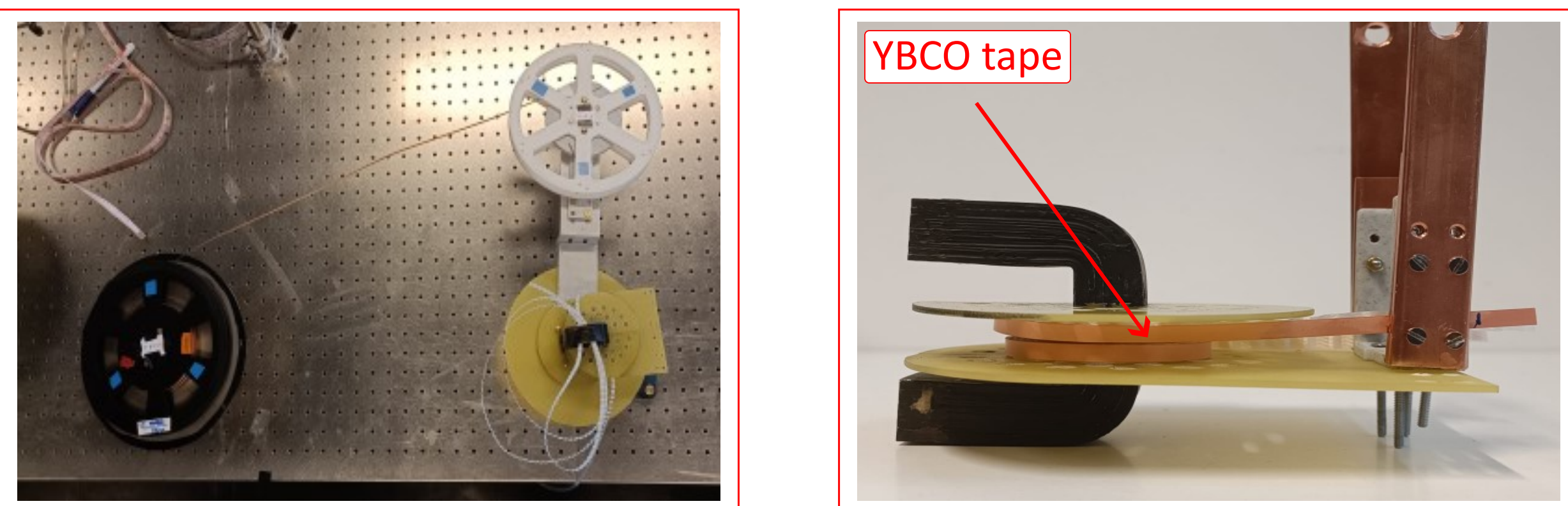

Fig. 2 - Realization of the SC double pancake coil.

Transformer test

- The SC transformer consists of the DPC as secondary winding, separated from the primary copper winding by an **airgap of 4mm thick plastic** serving as cryostat to retain the LN₂.

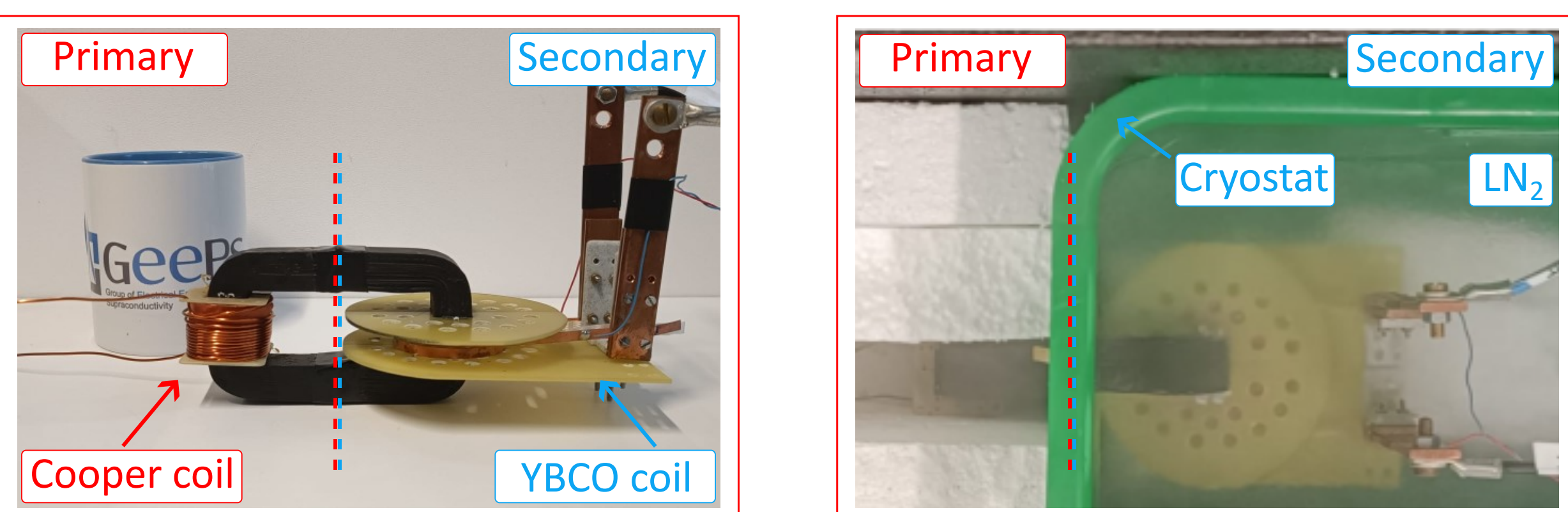

Fig. 3 - Transformer prototype.

- Following an equivalent circuit of a single-phase transformer (Fig.4), **open-circuit** and **short-circuit tests** were performed to obtain the **transformer parameters** (Tab.1).

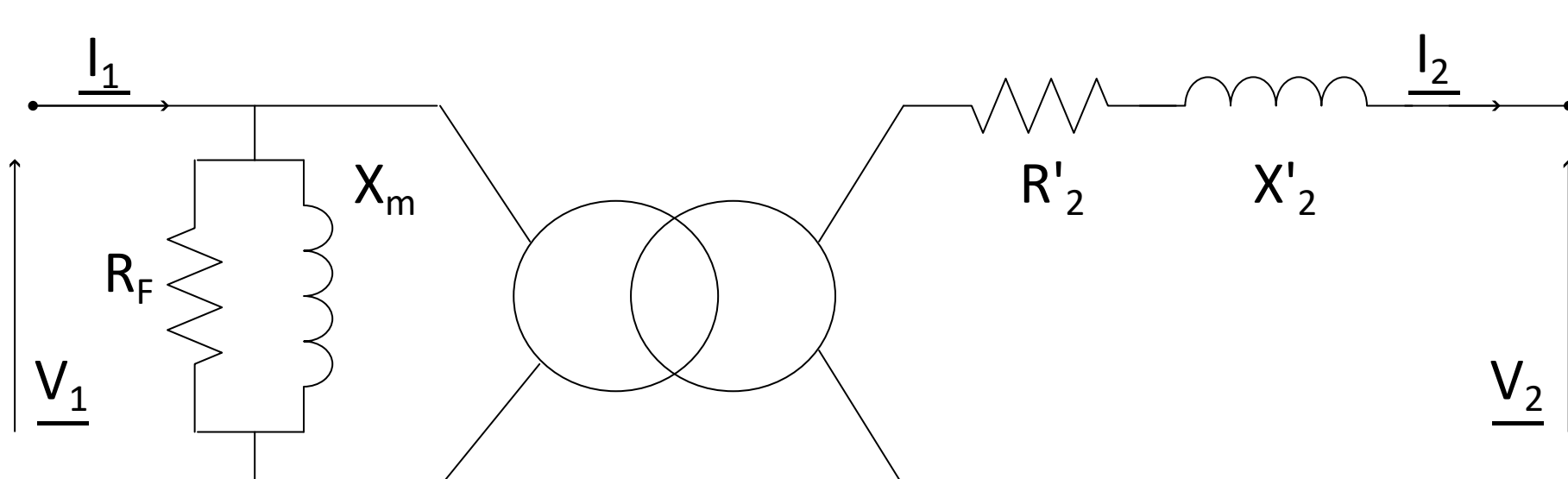

Fig. 4 - Single-phase transformer equivalent model.

Tab.1 - Transformers parameters

	V_2/V_1	η_t [%]	R_f [Ω]	X_m [Ω]	R'_2 [Ω]	X'_2 [Ω]
Conventional	0.11	1.5	1.13	0.42	3.76	4.24
Superconducting	0.09	25.8	1.74	0.38	0.05	0.16

Note: Efficiency does not take into account the cooling system power (i.e. $\eta_t = P_2/P_1$).

Cryoconverter

Diode characterization

- Different semiconductor technologies **behave differently** at cryogenic temperatures [2].
- **Some diode technologies are more suitable** for operation at cryogenic temperature.

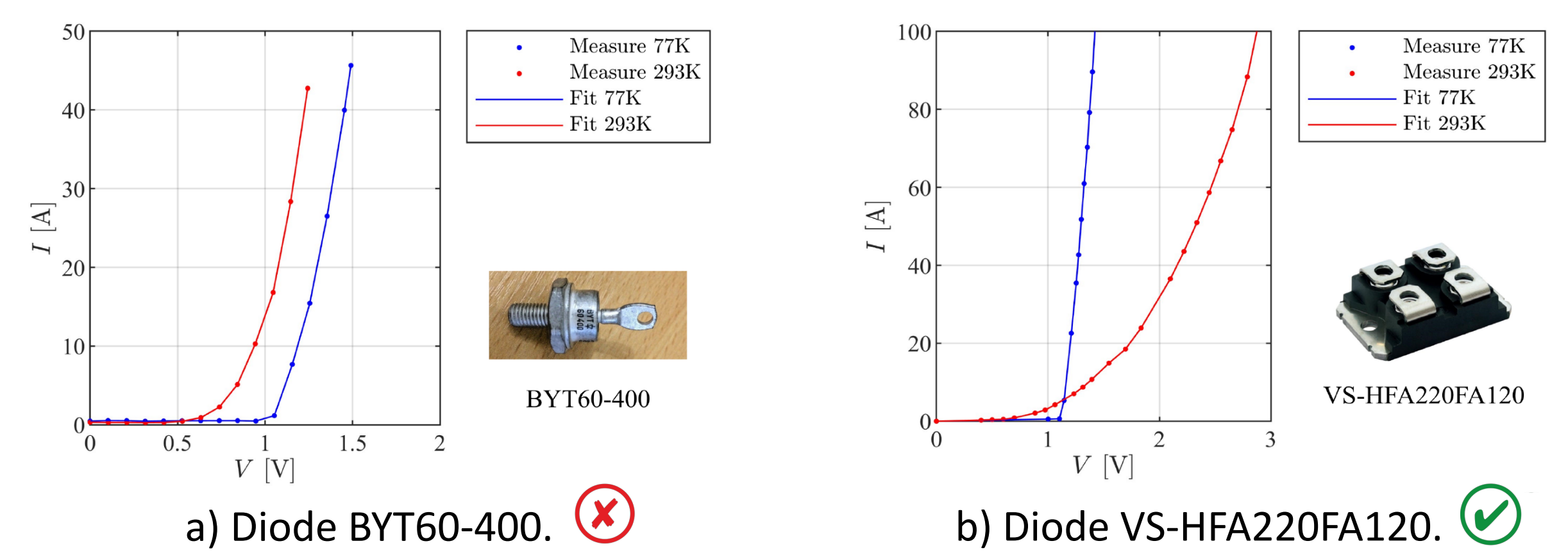

Fig. 5 - Measured diode current-voltage curve.

Cryoconverter test

- The diodes with favorable behavior in LN₂ are connected as 4 diodes **single-phase rectifier** on top of an aluminum heatsink to improve heat dissipation.
- A sinusoidal voltage of 50 V RMS was applied and the efficiency was studied for several load and hence power.

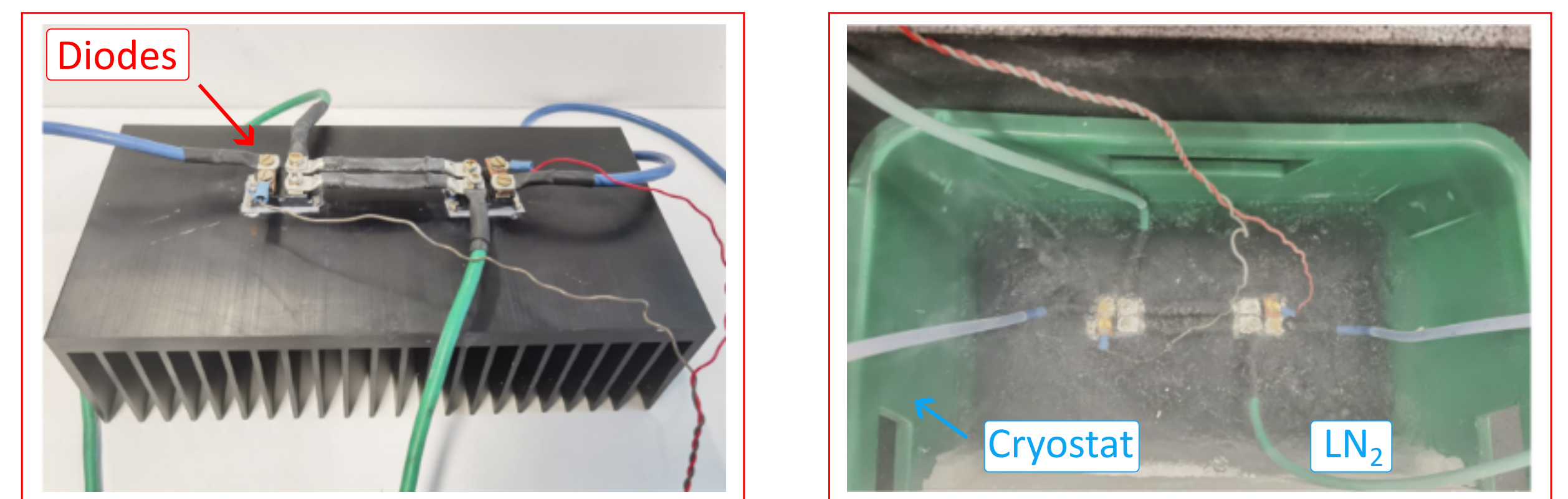

Fig. 6 - Diode bridge test at cryogenic temperature.

- Diode rectifier **losses reduced by an average of 27.6%**.
- Diode rectifier **efficiency improved by 2%** for a DC power of 1kW.

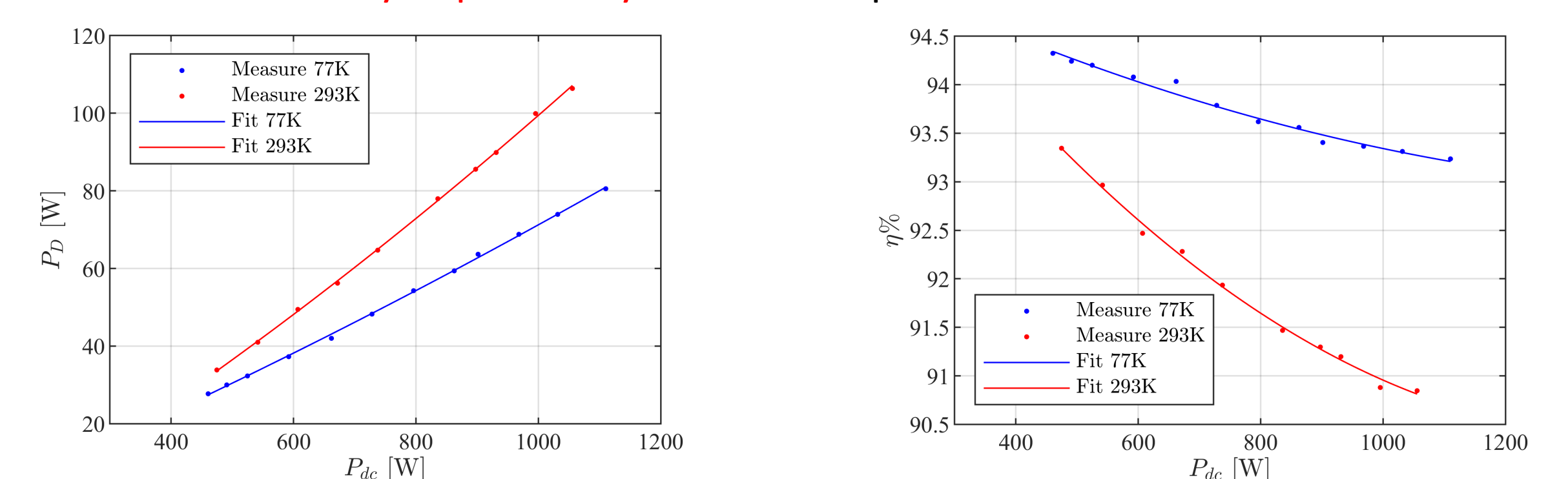

Fig. 7 - Cryoconverter performances at room and cryogenic temperatures.

Conclusion

- Development of the superconducting **double pancake coil**.
- Realization of a **first superconducting transformer**.
- Power transfer through the cryostat between different temperatures.
- **Characterization of diodes** at cryogenic temperature.
- Realization and test of the **diode rectifier** operational at cryogenic temperature.

Next steps

- Further **assembly of the system** improving the output level of the transformer to 1kW.
- **Improvements of the cryostat** for the reduction of the airgap.
- Make a **techno-economic analysis** between systems under study.

References

- [1] A. Ballarino, "Current Leads, Links and Buses," *Proc CAS-CERN Accel. Sch. Supercond Accel.*, pp. 547–558, 2013.
- [2] A. Elwakeel, Z. Feng, N. McNeill, M. Zhang, B. Williams, W. Yuan, "Study of power devices for use in phase-leg at cryogenic temperature," *IEEE Trans. Appl. Supercond.*, vol. 31, no. 5, pp. 1–5, Aug. 2021.

The project was financed by the French government under the "Plan de Relance" and the "Programme d'investissements d'avenir".