



**HAL**  
open science

## Experimental validation of the energy ship concept for far-offshore wind energy conversion

Aurélien Babarit, N. Abdul Ghani, E. Brouillette, S. Delvoeye, M. Weber, A. Merrien, M. Michou, J.-C. Gilloteaux

► **To cite this version:**

Aurélien Babarit, N. Abdul Ghani, E. Brouillette, S. Delvoeye, M. Weber, et al.. Experimental validation of the energy ship concept for far-offshore wind energy conversion. *Ocean Engineering*, 2021, 239, pp.109830. 10.1016/j.oceaneng.2021.109830 . hal-04208641

**HAL Id: hal-04208641**

**<https://hal.science/hal-04208641>**

Submitted on 22 Jul 2024

**HAL** is a multi-disciplinary open access archive for the deposit and dissemination of scientific research documents, whether they are published or not. The documents may come from teaching and research institutions in France or abroad, or from public or private research centers.

L'archive ouverte pluridisciplinaire **HAL**, est destinée au dépôt et à la diffusion de documents scientifiques de niveau recherche, publiés ou non, émanant des établissements d'enseignement et de recherche français ou étrangers, des laboratoires publics ou privés.



Distributed under a Creative Commons Attribution - NonCommercial 4.0 International License

# 1 Experimental validation of the energy ship concept for far-offshore wind 2 energy conversion

3 A. Babarit<sup>a\*1</sup>, N. Abdul Ghani<sup>a,b</sup>, E. Brouillette<sup>a</sup>, S. Delvoye<sup>a</sup>, M. Weber<sup>a</sup>, A. Merrien<sup>a</sup>, M. Michou<sup>c</sup>, J-C.  
4 Gilloteaux<sup>a</sup>

5 <sup>a</sup> LHEEA, Ecole Centrale de Nantes - CNRS, Nantes, France

6 <sup>b</sup> Universiti Pertahanan Nasional Malaysia, Kuala Lumpur, Malaysia

7 <sup>c</sup> Watt&Sea, La Rochelle, France

8 \* Corresponding author: aurelien.babarit@ec-nantes.fr

## 9 Abstract

10 The energy ship is a new concept for offshore wind energy capture. It consists of a wind-propelled  
11 ship that generates electricity using water turbines attached underneath its hull. Since it is not grid-  
12 connected, the generated energy is stored aboard the ship (for instance, using batteries or through  
13 conversion to hydrogen using an electrolyzer).

14 This concept has received little attention until today. Particularly, there had not been yet an  
15 experimental proof-of-concept. In order to bridge this gap, an experimental platform has been  
16 developed at Centrale Nantes. It consists of a 5.5 m long catamaran equipped with a 240 mm  
17 diameter water turbine. The platform was tested in July 2019 on the river Erdre (France). Results  
18 show that a full-scale energy ship could deliver high levels of power production (megawatts); and  
19 that it is essential to optimize the water turbine induced drag in order to maximize energy  
20 production.

21 **Keywords:** offshore wind energy, energy ship, experiments

## 22 1. Introduction

---

<sup>1</sup> Now with Farwind Energy, 1 rue de la Noë, 44300 Nantes, France

23 With a global installed capacity over 35 GW [1] and the first floating wind farm having entered  
 24 operation in 2017, the development of offshore wind has been a tremendous success. Nevertheless,  
 25 with current technologies (bottom-fixed and floating wind turbines), offshore wind is limited to near-  
 26 shore and relatively shallow water areas because grid-connection costs, installation costs and  
 27 maintenance costs increase dramatically as the distance to shore and the water depth increase [2].  
 28 Therefore, the next frontier for offshore wind is to develop new technologies for far-offshore wind  
 29 energy conversion.

30 In this respect, since 2017, the LHEEA lab. has been investigating the energy ship concept. This  
 31 concept consists of a ship propelled by the wind (using sails) that generate electricity using water  
 32 turbines attached underneath its hull. The electricity produced is stored on board, either in batteries  
 33 [3] or in the form of fuel (hydrogen, ammonia, methanol, etc.[4] -[7]).

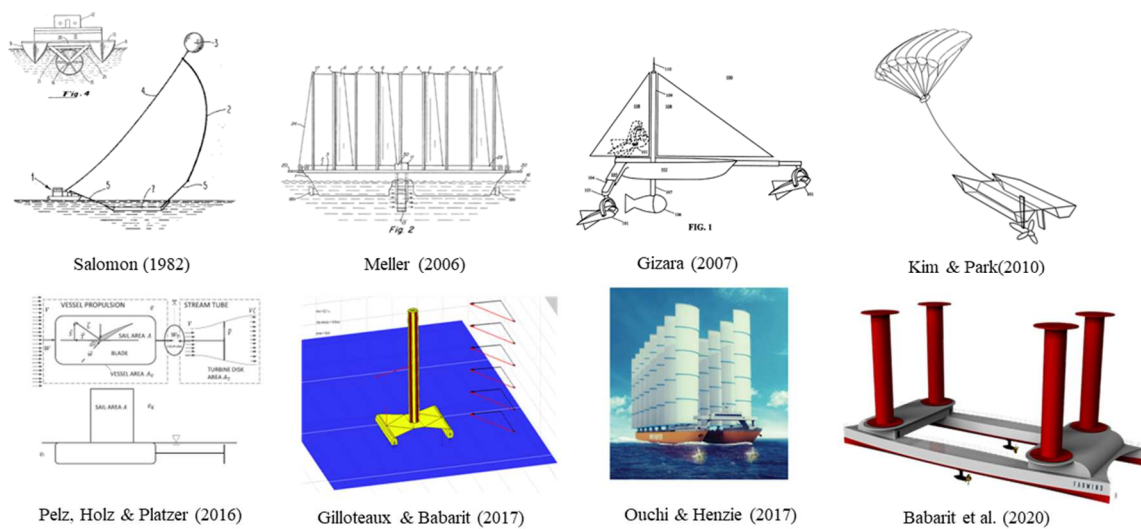

34  
35 *Figure 1. Pictures of concepts of energy ships.*

36 Although the energy ship concept was patented in 1982 [4], it did not receive much attention  
 37 until the end of the first decade of the 2000s. Thus, there has been only a limited number of energy  
 38 ship proposals to date [4][8]-[13]. They are shown in Figure 1.

39 Regarding academic works, the energy ship has also been the focus of only few studies [3][5]-  
 40 [7][10]-[16]. In 2009, Platzer and Sarigul-Klijn were the first to discuss the energy ship concept in a

41 scientific publication [14], proposing it as a way to increase hydrokinetic energy sources for water  
42 turbines. The following year, Kim and Park presented a concept that included kite sails flown at high  
43 altitude (1500 m) for wind propulsion, a catamaran for the hull, and hydrogen or methanol for the  
44 energy vector [5]. Using analytical and numerical modelling, they showed that an energy ship  
45 propelled by a 3,000 m<sup>2</sup> kite could generate approximately 1.2 MW if sailing in a wind of 20 knots.  
46 In [13], we showed that in the same wind conditions, an 80 m long catamaran equipped with four 30  
47 m high rotor sails (Flettner rotors) and two 4 m diameter water turbines could generate 1.6 MW.

48 Furthermore, Pelz et al. [13] showed that a key parameter for maximizing energy recovery is the  
49 drag induced by the water turbine. This is because the power absorbed by the water turbine is equal  
50 to the product of the induced drag times the cube of the average flow velocity across the propeller  
51 disc, which is proportional to the ship velocity. If the induced drag is very large, then the ship velocity  
52 is very small, and the power absorbed tends towards zero. Conversely, if the drag is very small, the  
53 ship velocity tends towards that without the water turbine, but the power absorbed also tends  
54 towards zero. Between these two extremes, there is an optimum. We showed in [13] that this  
55 optimum can be significantly different from that for wind turbines or tidal turbines (because the  
56 input flow speed - the ship-velocity - depends on the induced drag).

57 The aim of the present study is two-fold. First, it aims to achieve an experimental proof-of-  
58 concept of the energy ship. Indeed, to our best knowledge, all studies carried out so far are desktop  
59 studies or based on numerical models. In this respect, we believe that it is of utmost importance to  
60 validate experimentally that significant amounts of energy can be produced with energy ships.  
61 Second, the aim is to investigate experimentally the effect of drag on energy production.

62 The remainder of the paper is organized as follows. The experimental platform is described in  
63 section 2. The tests and the experimental results are presented in section 3. Finally, in section 4, the  
64 energy performance of large-scale energy ships is extrapolated from the experimental data.

## 65 **2 Description of the experimental platform**

66 **2.1 General arrangement**

67 A second-hand Hobie Cat Tiger catamaran served as the base for the experimental platform  
68 (Figure 2). Her length is 5.51 m (18 feet). The rig consists of a 17 m<sup>2</sup> mainsail and a 4.15 m<sup>2</sup> jib. It has  
69 been designed to be handled by a crew of two people. This type of catamaran was selected for its  
70 low water resistance (which is essential to maximize energy production [10][13]), its low cost on the  
71 second-hand market, and because it fairly corresponds to a 1:14 scale version of the energy ship  
72 design described in [13].

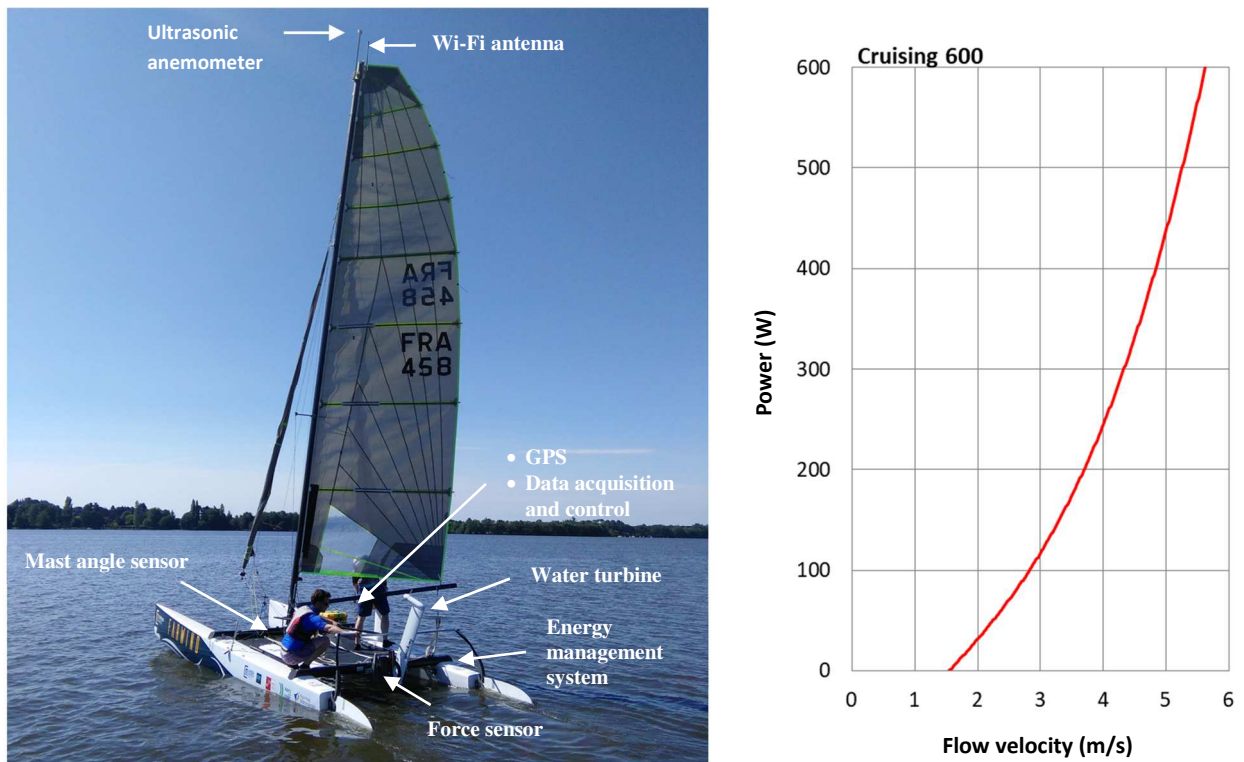

73

74 *Figure 2. Left: picture of the experimental platform. Right: performance of the Watt & Sea*

75

*Cruising 600 water turbine*

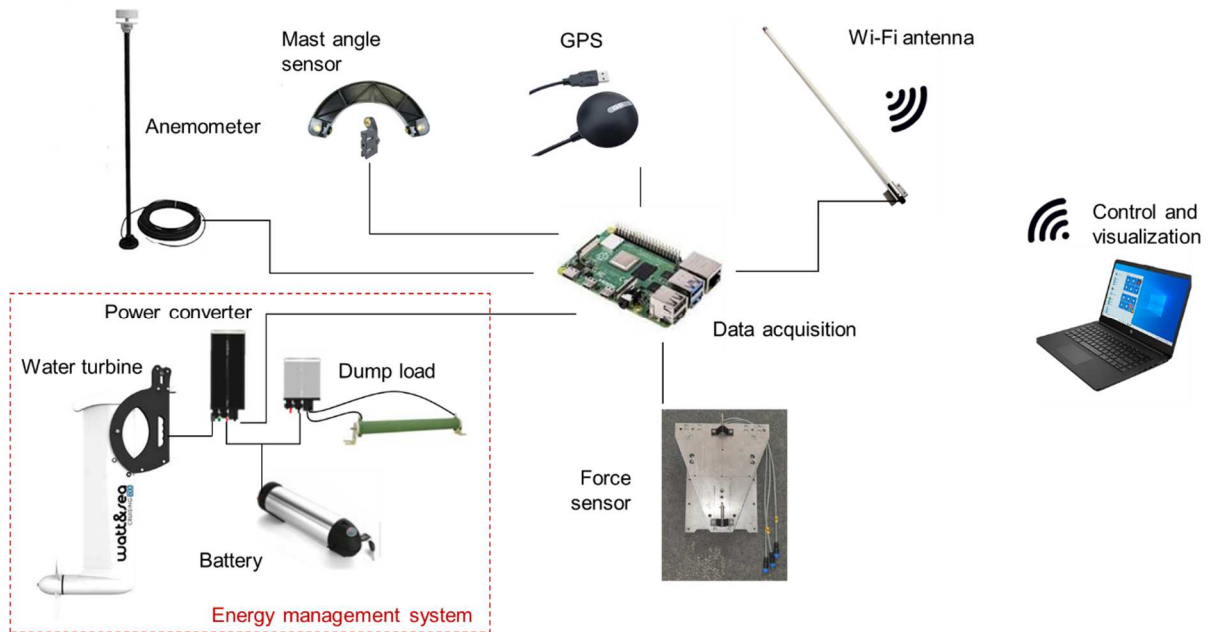

76

77

*Figure 3. Synoptic view of the instrumentation and equipment*

78

Figure 3 shows a synoptic view of the instrumentation and equipment which have been installed.

79

A Watt & Sea Cruising 600 hydro-generator [19] was used for the water turbine. It has been mounted at the middle of the rear beam. The propeller diameter is 240 mm. According to the supplier, this configuration allows the production of 250 W of electrical power at a vessel speed of 4 m/s (Figure 2).

83

One of the objectives of the experimental campaign being to investigate the relationship between the drag induced by the water turbine and the energy production, a custom force sensor has been installed between the hydro-generator and the hull. The force sensor was designed and built at LHEEA (Figure 4). It consists of three HBM Z6 strain gauges mounted between two aluminum plates. Calibration results show that its accuracy is 0.4% of the maximal force (100 N).

87

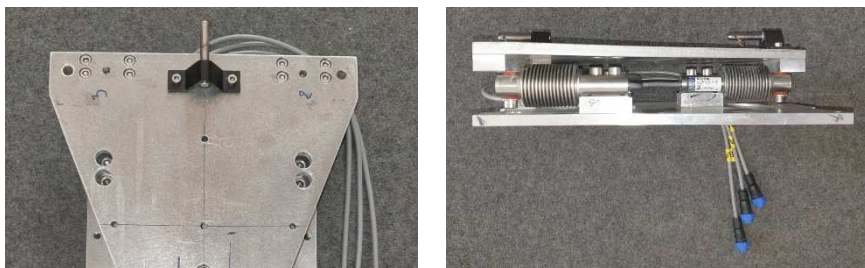

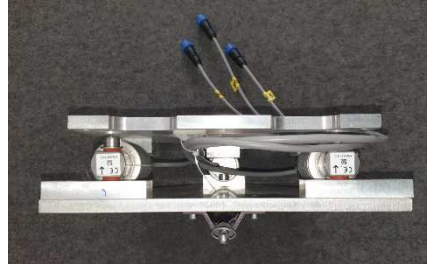

Figure 4. Force sensor

88

89 The energy management system has been integrated inside the starboard float. It includes a  
90 converter which controls the generator of the water turbine, a battery, and a discharge resistor  
91 (which was included to avoid overload in case of excess energy). The energy management system  
92 includes sensors to measure the energy production (voltage, current, power) and the rotational  
93 velocity of the water turbine. The resistive torque generated by the generator at the shaft of the  
94 propeller ( $P_{shaft}$ ) is estimated from the measurement of the output current of the generator.

95 To measure the wind, a CV7-LCJ ultrasonic anemometer was installed at the top of the mast. As  
96 the Hobie Cat Tiger is equipped with a rotating wing mast, a mast angle sensor was positioned at the  
97 bottom of the mast in order to be able to correct the wind angle measurement.

98 The control and data acquisition system is based on a Raspberry Pi 3. It is integrated in a  
99 waterproof case (Pelicase) on the starboard float deck. It is connected to the various sensors by wire  
100 links. The acquisition software was developed at LHEEA in Python. It allows the continuous recording  
101 and storage of the measured data in an ASCII file in a memory card on board the platform, as well as  
102 the broadcast of the data through Wi-Fi (a Wi-Fi antenna was installed at the top of the mast). This  
103 feature allowed the experiments to be monitored and controlled in real-time by a team which stayed  
104 on the riverbank. In particular, the output voltage of the generator of the water turbine (and  
105 therefore the drag, see following section) was controlled remotely, which allowed the crew on board  
106 the catamaran to focus on navigation.

## 107 2.2 Water turbine calibration

108 The generator output voltage of the water turbine is controlled by the converter of the energy  
109 management system. This allows controlling the generator current and therefore the resistive torque  
110 on the shaft of the propeller, thus the propeller rotational velocity, thus the induced drag and energy  
111 production.

112 By default, the controller of the converter automatically optimizes the generator output voltage  
113 in order to extract the maximum power from the water turbine. For the experiments, it was modified  
114 in order to enable a given value of the generator output voltage to be prescribed (and thus the water  
115 turbine drag force).

116 To determine the characteristics of the water turbine (drag force and generated power as  
117 function of the generator setting and flow velocity), experiments were carried out in the towing tank  
118 of Ecole Centrale de Nantes. The experimental setup is shown in Figure 5. The water turbine and its  
119 force sensor were mounted on the carriage. The propeller shaft was submerged 520 mm deep. Tests  
120 were carried out for a range of carriage velocities of 1.5 - 6.0 m/s. The generator output voltage was  
121 varied in the range 10 to 50 V. The drag force was measured using the same sensor as that used for  
122 the experimental platform (Figure 4).



123 *Figure 5. Experimental set-up for the characterization of the water turbine*



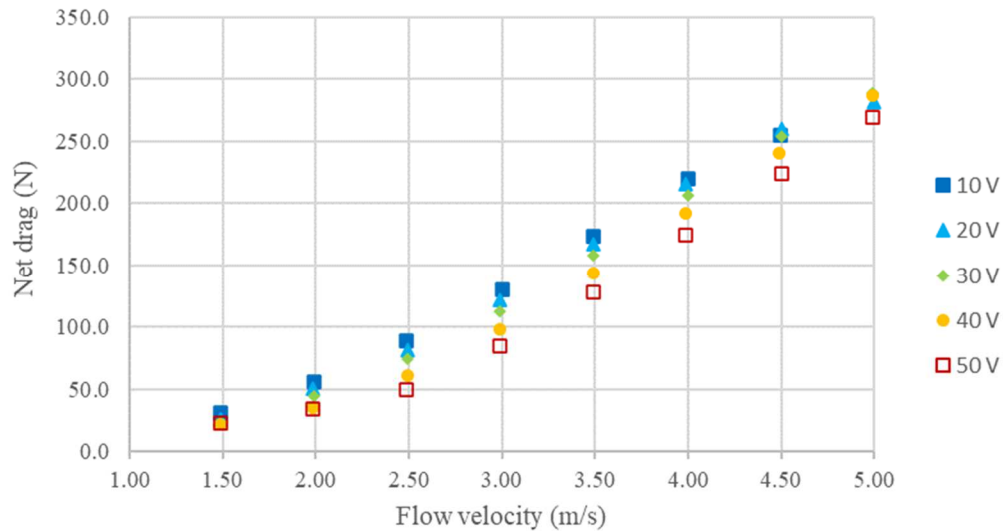

124

125 *Figure 6. Water turbine's net drag force as function of the flow velocity and generator output*  
 126 *voltage.*

127 Figure 6 shows the measured water turbine net drag force as function of the flow velocity and  
 128 generator output voltage. The net drag force is the measured drag force minus the measured drag  
 129 force without the propeller. One can see that, as expected, the drag force decreases with increasing  
 130 output voltage. However, the controllability of the drag force appears to be limited as, for a given  
 131 flow velocity, the minimum drag force (which is obtained for an output voltage of 50 V) is at least  
 132 56% of the maximum drag force (obtained for output voltage 10 V).

### 133 3 Experiments

134 Tests were carried out on July 2<sup>nd</sup>, 2019 at Plaine de Mazerolles on the Erdre river (France). At  
 135 this location, the river is wide, and the current is negligible. The wind conditions were light (1 to 7  
 136 m/s).

#### 137 3.1 Method

138 The experimental method consisted of a series of roundtrips on beam reach (see example in  
 139 Figure 7). This wind direction was chosen because it corresponds to the point of sail for which the  
 140 performance of energy ship is maximum[13]. On each round trip, the control setting (generator

141 output voltage) was changed in order to study its effect on energy production. Eventually, four  
142 usable data records were obtained (labelled Run02, Run03, Run04, Run05, See Figure 7). Of these  
143 four recordings, a total of seventeen crossings of the river were made.

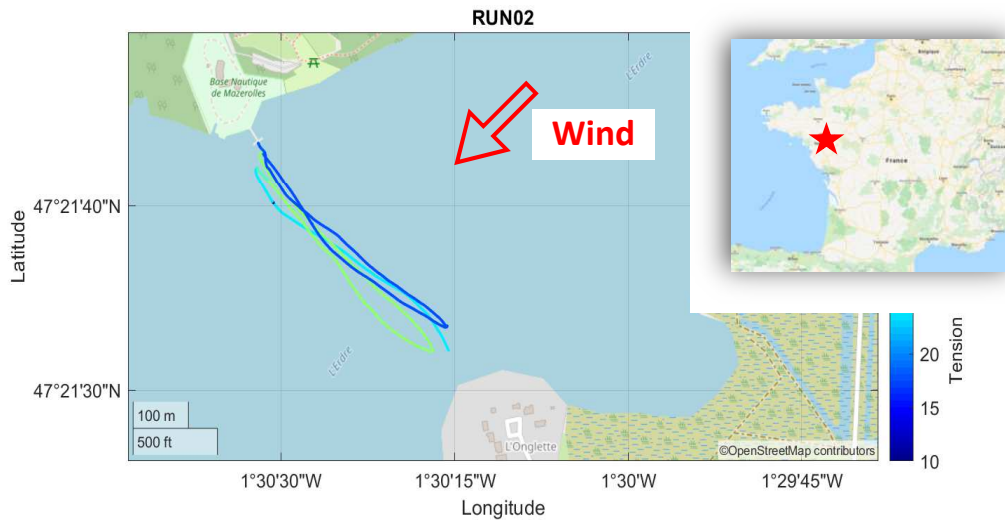

144

145 *Figure 7. Example of GPS trajectories during the experiments. The colors indicate the setting*  
146 *(output voltage) of the generator of the water turbine. Background picture and map:*

147

*OpenStreetMap*

### 148 3.2 Data processing

149 Figure 9 shows the time recording of some of the data collected during Run02 (true wind  
150 speed, boat velocity, generator output voltage, true wind angle). One can see that there are  
151 significant oscillations. They are related on the one hand to the inability of the crew to perfectly  
152 maintain heading, but also and above all also to significant variations in the wind (both in strength  
153 and direction) over the test area (inland waters).

154 The seventeen river crossings were analyzed one by one in order to identify measurement  
155 intervals during which the experimental signals were stable (shaded areas in Figure 9). The signals  
156 were then averaged over each of these intervals. Standard deviations were also calculated in order to  
157 keep trace of the data quality.

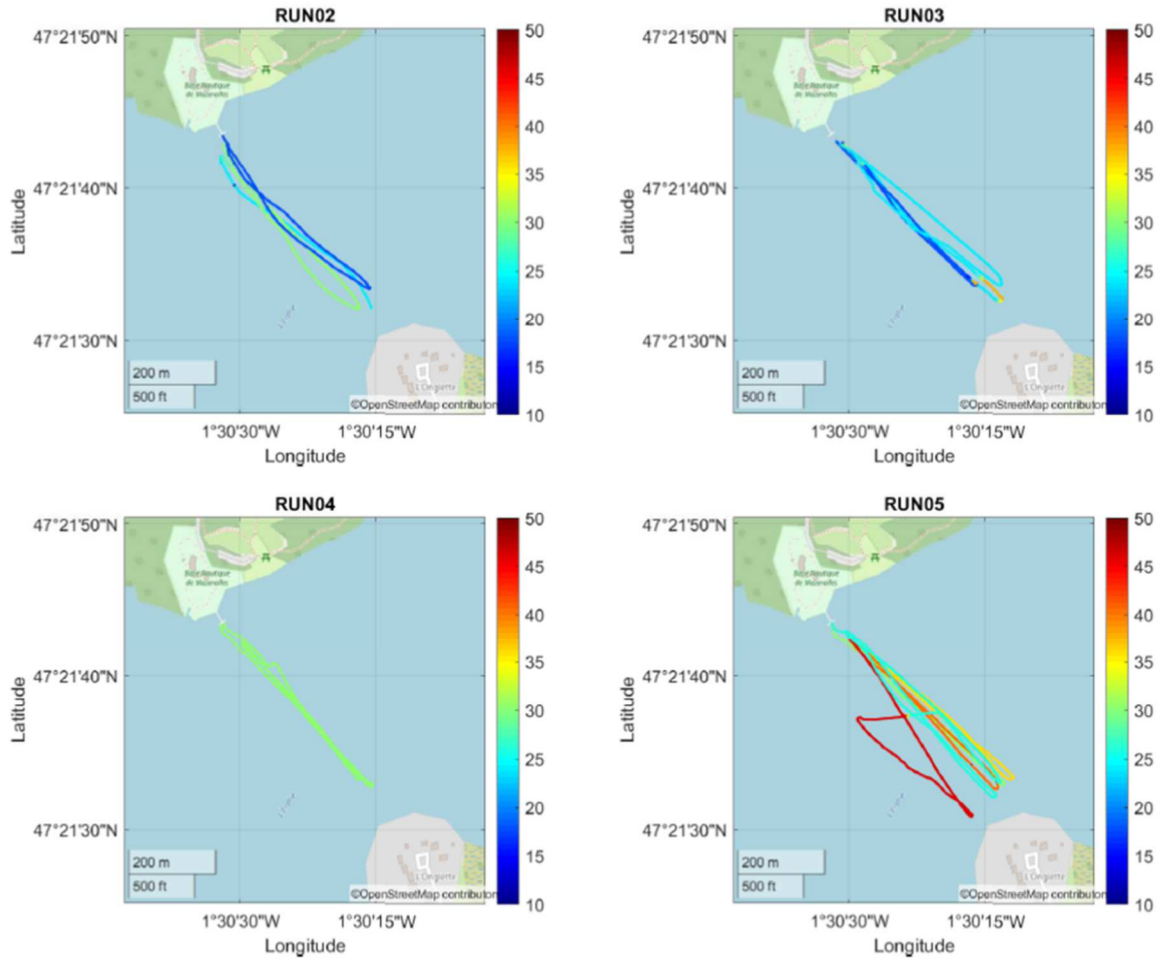

158 *Figure 8. GPS traces of the experiments. The colors indicate the setting (output voltage) of the*  
 159 *generator of the water turbine. Background picture: OpenStreetMap*

160 Based on the processed data, the water turbine drag coefficient  $C_T$  and the energy ship power  
 161 coefficient  $C_P$  were calculated. For the water turbine drag coefficient, we used the usual definition:

$$162 \quad C_T = \frac{D_{net}}{\frac{1}{2}\rho_{water}A_{WT}SOG^2} \quad (1)$$

163 where  $D_{net}$  is the net water turbine drag force (measured drag force minus drag force on the water  
 164 turbine mast),  $A_{WT}$  is the water turbine disc surface area, and  $SOG$  is the boat velocity.

165 For the power coefficient  $C_P$ , the usual definition for a water turbine is:

167

$$C_P = \frac{P_{shaft}}{\frac{1}{2}\rho_{water}A_{WT}SOG^3}$$

168

(2)

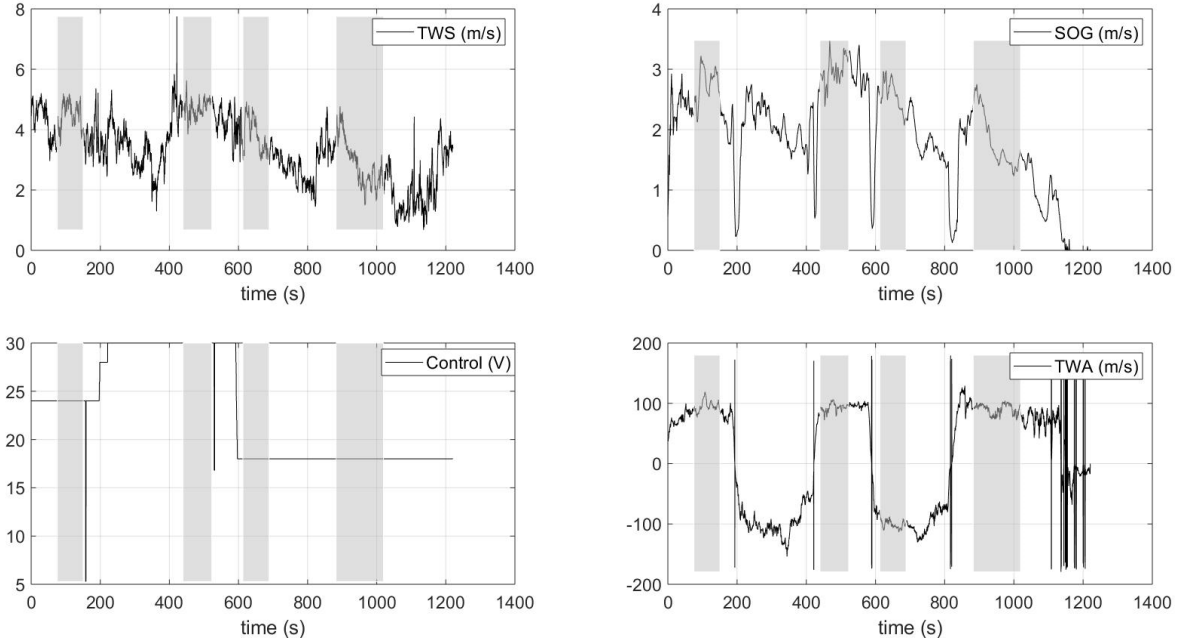
169 where  $P_{shaft}$  is the mechanical power at the shaft of the water turbine generator.

170

171

*Figure 9. Example of raw data measured Run02. Top left panel: true wind speed. Top right*

172

*panel: boat speed. Bottom left: generator output voltage. Bottom right: true wind angle. The*

173

*shaded areas correspond to the time windows which were retained for analysis.*

174

However, we think that this definition is not appropriate for the energy ship because it is not

175

based on the actual energy source (which is the wind). Therefore, for an energy ship, we instead

176

propose to define the power coefficient as:

177

$$\tilde{C}_P = \frac{P_{shaft}}{\frac{1}{2}\rho_{air}A_sTWS^3}$$

178

(3)

179 where  $A_s$  is the sail area (21.15 m<sup>2</sup> in the experiments).

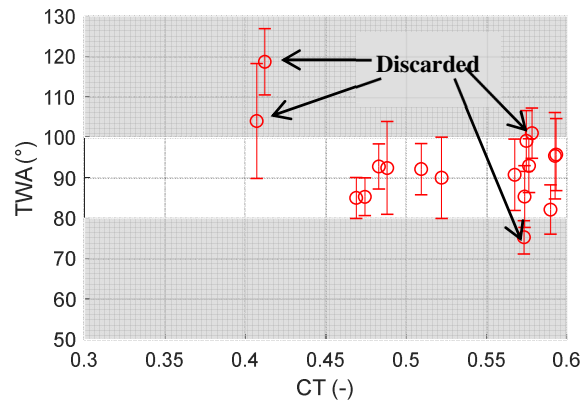

180

181 *Figure 10. Illustration of the data obtained after analysis. The figure shows the average true*  
182 *wind angle as function of the water turbine drag coefficient.*

183 Figure 10 shows an example of the data obtained after processing. One can see that despite  
184 the crew's best effort to keep the true wind angle close to 90 degrees during the experiments, there  
185 are data points that deviate significantly from this objective. Since the true wind angle is a key driver  
186 of energy ships' velocity and energy performance[13], and since the aim of the paper is to investigate  
187 the effect of the water turbine's drag force on performance, only the data for which the average true  
188 wind angle is between 80 ° and 100 ° is retained in what follows.

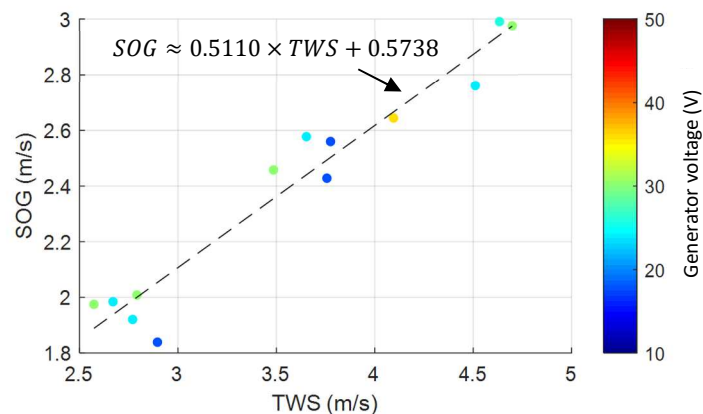

189

190 *Figure 11. Boat velocity (SOG) as function of the true wind speed (TWS) and generator output*  
191 *voltage. The water turbine was in operation.*

192 Figure 11 shows the average boat velocity as function of the average true wind speed and the  
 193 generator output voltage. The range of average wind speed is 2.5 - 5.0 m/s. It appears that, when the  
 194 water turbine is in operation, the boat speed is approximately equal to half the true wind speed.  
 195 Unfortunately, no recording of the boat speed without the water turbine was made. Nevertheless, it  
 196 is typical for a sport boat (such as the catamaran used in the experiments) sailing at a 90 degrees true  
 197 wind angle that its speed is in the order of the true wind speed (if not exceeding).

### 198 3.3 Results

199 Table 1 summarizes the results of the data processing. The data for each row corresponds to  
 200 the average of the raw data over the intervals selected for analysis (see Figure 9).

201 Figure 12 shows the drag coefficient and power coefficient as function of the output voltage.  
 202 In the left panel, one can see that the drag coefficient decreases with increasing voltage (as observed  
 203 in the towing tank experiments). Note also that the range of variation of the drag coefficient is  
 204 relatively limited as it drops by only 20% when the output voltage goes from 18 to 36 V. If the full  
 205 range of variation of the voltage had been used (10 to 50V), the drag coefficient could have varied by  
 206 about 40%

Crossing	Run number	TWS (m/s)	TWA (°)	SOG (m/s)	Output voltage (V)	$C_T$	$\tilde{C}_P$
1	3	3.77 (0.20)	82.2 (6.1)	2.56 (0.14)	18	0.590 (0.034)	0.133 (0.026)
2	4	2.57 (0.43)	85.0 (5.1)	1.97 (0.21)	30	0.469 (0.053)	0.263 (0.097)
3	4	2.79 (0.48)	85.3 (4.7)	2.01 (0.14)	30	0.474 (0.057)	0.230 (0.083)
4	3	3.65 (0.63)	85.4 (7.6)	2.58 (0.29)	24	0.573 (0.058)	0.214 (0.080)
5	3	2.77 (0.63)	90.0 (10.0)	1.92 (0.27)	24	0.522 (0.050)	0.219 (0.139)
6	2	2.90 (0.74)	90.8 (8.9)	1.84 (0.44)	18	0.567 (0.071)	0.138 (0.495)
7	5	4.10 (0.29)	92.2 (6.4)	2.64 (0.23)	36	0.509 (0.052)	0.189 (0.046)
8	3	2.67 (0.53)	92.5 (11.5)	1.98 (0.37)	24	0.488 (0.056)	0.217 (0.097)
9	5	3.49 (0.25)	92.8 (5.6)	2.46 (0.15)	30	0.483 (0.044)	0.217 (0.044)
10	2	4.70	93.0 (6.7)	2.98	30	0.576	0.180

		(0.59)		(0.22)		(0.051)	(0.044)
11	5	4.63 (0.95)	95.5 (10.7)	2.99 (0.47)	26	0.592 (0.045)	0.174 (0.048)
12	2	4.51 (0.43)	95.8 (8.9)	2.76 (0.28)	24	0.593 (0.045)	0.137 (0.036)
13	3	3.76 (0.64)	99.1 (7.5)	2.43 (0.35)	18	0.575 (0.048)	0.116 (0.032)

207 *Table 1. Experimental results. The numbers between parenthesis are the standard deviations.*

208 In the right panel, one can see that, as expected, varying the output voltage - and therefore the  
 209 drag - influences energy production. For the range of tested voltage, the power output appears to  
 210 increase with increasing voltage (and thus decreasing water turbine drag). Unfortunately, the  
 211 experimental results do not allow to determine what is the optimal drag value (since the maximum  
 212 production is obtained for the upper bound of the test interval). Further testing with higher voltage  
 213 would be necessary.

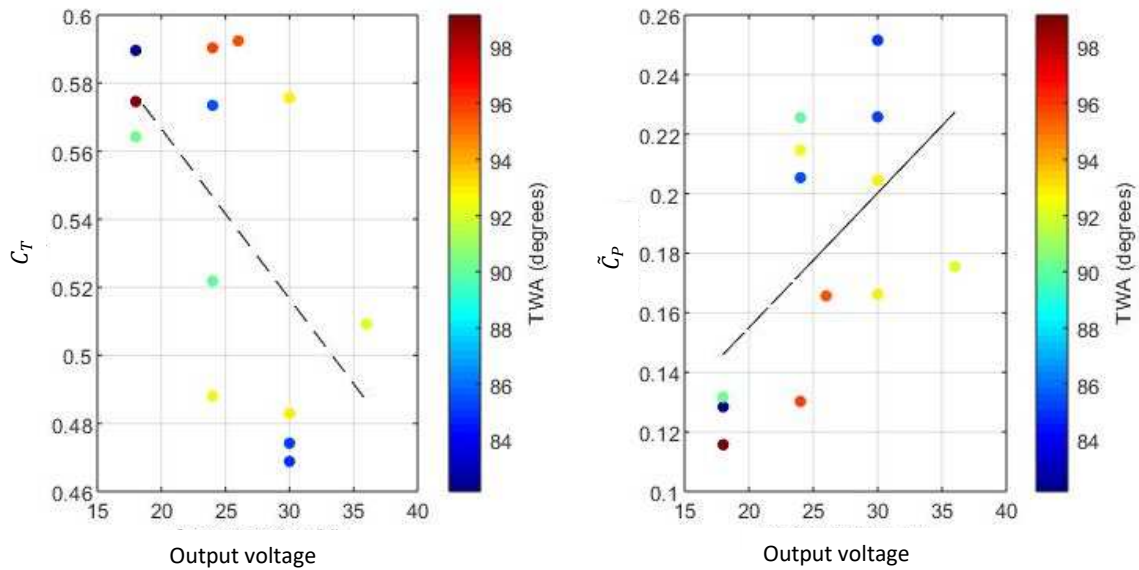

214  
 215 *Figure 12. Drag and power coefficient of the water turbine as function of the generator output*  
 216 *voltage and true wind angle (TWA).*

## 217 **4 Energy performance of a large-scale energy ship**

### 218 **4.1 Estimate based on the experimental data.**

219 Based on the experimental results, let us estimate the energy performance of a large-scale  
 220 energy ship. It is assumed that the scale of the experiments is 1:14, as for this scale the length of the  
 221 1:1 ship would be 77 m which is close to that of the energy ship design shown in Figure 1 (80 m). It is  
 222 further assumed that the design of the water turbine of the large-scale energy ship has the same  
 223 hydrodynamic characteristics (drag coefficients, power coefficients) as that of the water turbine used  
 224 in the experiments. Finally, the estimate is based on the data of crossing #3 in Table 1 despite  
 225 crossing #2 has the best power coefficient  $\tilde{C}_p$ , because the latter looks like an outlier.

		Experiments (1:14 scale)	1:1 scale
Length	<i>m</i>	5.51	77
Sail area	<i>m</i> <sup>2</sup>	21.15	4 145
Displacement (estimate)	<i>kg</i>	350	960 000
Wetted surface area (estimate)	<i>m</i> <sup>2</sup>	4.7	921
Water turbine diameter	<i>m</i>	0.24	3.36
$C_T$	-	0.474 (0.057)	0.474 (0.057)
$\tilde{C}_p$	-	0.230 (0.083)	0.230 (0.083)
$TWS_{10}$	<i>m/s</i>	2.79 (0.48)	7.21 (1.25)
TWA	°	85.3 (4.7)	85.3 (4.7)
SOG	<i>m/s</i>	2.01 (0.14)	7.5 (0.5)
Froude number	-	0.27	0.27
Reynolds number	-	1.1E+07	5.8E+08
Shaft power without correction (Reynolds)	<i>kW</i>	<b>0.063 (0.032)</b>	650 (330)
Shaft power with correction (Reynolds)	<i>kW</i>	N/A	<b>830 (450)</b>

226 *Table 2. Estimate of the energy production of a full-scale energy ship based on the*  
 227 *experimental results.*

228 The estimates are presented in Table 2. The data for the 1:1 scale were obtained using Froude-  
 229 scaling except for the true wind speed at 10 m altitude ( $TWS_{10}$ ), and for the energy production.  
 230 Indeed, for the true wind speed, the direct application would give the true wind speed at 140 m



231 altitude. Because of the Earth atmospheric boundary layer, the actual value at 10 m altitude is  
232 significantly smaller. In the present study, it is estimated using the classical power law:

$$233 \quad TWS(z) = TWS_{10} \left( \frac{z}{10} \right)^{0.14}$$

234 (4)

235 where  $z$  is the altitude.

236 For the energy production (mechanical power on the shaft), two values were calculated: one  
237 without considering that the Reynolds numbers are different between scale 1:14 and scale 1:1, and  
238 the other taking it into account. The first case corresponds to the direct application of the Froude  
239 scale. In the second case, a correction is applied to consider the effect of scale distortion. Indeed, at  
240 the 1:14 scale, the drag force of the hull can be written:

$$241 \quad R_{W,1:14} = \frac{1}{2} \rho_{water} A_{W,1:14} C_{W,1:14} U_{1:14}^2$$

242 (5)

243 where  $A_{W,1:14}$  is the wetted surface of the hull,  $C_{W,1:14}$  is the hull resistance coefficient, and  $U_{1:14}$  is  
244 the ship velocity. As the forward speed was moderate in the tests ( $F_n \sim 0.27$ ) and since the hull  
245 consists of two thin floats, the component of the hull resistance coefficient associated with wave  
246 resistance is neglected. Thus, the hull resistance coefficient reduces to its friction component  $C_{f,1:14}$ .  
247 According to ITTC [18], it can be written:

$$248 \quad C_f = \frac{0.075}{(\log_{10} Re - 2)^2}$$

249 (6)

250 The application of the ITTC formula shows that the friction coefficient is of the order of  
251 0.0029 at scale 1:14, whereas it is 0.0016 at scale 1:1. Therefore, the direct application of Froude  
252 scaling overestimates the full-scale hull resistance by up to 80%.

253 Let us then estimate energy production considering this effect. Let us denote  $\Delta R_W$  the  
254 difference in hull resistance between that obtained using Froude scaling and that estimated  
255 considering the full-scale Reynolds number:

$$\begin{aligned} 256 \quad \Delta R_W &= 14^3 R_{W1:14} - \frac{1}{2} \rho S_{W,1:1} C_{W,1:1} U_{1:1}^2 \\ 257 \quad \Delta R_W &= 14^3 \left( R_{W1:14} - \frac{1}{2} \rho S_{W,1:14} C_{W,1:1} U_{1:14}^2 \right) \\ 258 \end{aligned} \tag{7}$$

259 To estimate the additional power available to the water turbine, let us consider the equation  
260 of motion of the ship at equilibrium:

$$\begin{aligned} 261 \quad T &= R_W + D \\ 262 \end{aligned} \tag{8}$$

263 Where  $T$  is the thrust delivered by the sails and  $D$  is the water turbine drag force. Equation 8 can be  
264 rewritten:

$$\begin{aligned} 265 \quad D &= T - R_W \\ 266 \end{aligned} \tag{9}$$

267 In particular, at the 1:14 scale:

$$\begin{aligned} 268 \quad D_{1:14} &= T_{1:14} - R_{W1:14} \\ 269 \end{aligned} \tag{10}$$

270 And at scale 1:1:

$$\begin{aligned} 271 \quad D_{1:1} &= T_{1:1} - R_{W1:1} \\ 272 \end{aligned} \tag{11}$$

273 For the thrust delivered by the sails, the Reynolds number at the 1:14 scale is of the order of  
274  $10^5$  against  $10^6$  for scale 1:1. Thus, the air flow is fully turbulent, and we can therefore assume that  
275 there is no effect of scale. Therefore:

276 
$$D_{1:1} = 14^3 T_{1:14} - R_{W1:1}$$

277 (12)

278 By injecting Equation 10 into Equation 12:

279 
$$D_{1:1} = 14^3 (D_{1:14} + R_{W1:14}) - R_{W1:1}$$

280 (13)

281 Finally:

282 
$$D_{1:1} = 14^3 \left( D_{1:14} + \frac{1}{2} \rho S_{W,1:14} C_{f,1:14} U_{1:14}^2 \right) - \frac{1}{2} \rho S_{W,1:1} C_{f,1:1} U_{1:1}^2$$

283 
$$D_{1:1} = 14^3 \times \frac{1}{2} \rho \left( \frac{\pi}{4} D_{1:14}^2 C_T + S_{W,1:14} (C_{f,1:14} - C_{f,1:1}) \right) U_{1:14}^2$$

284 (14)

285 The numerical application of this latter equation shows that the drag induced by the water  
 286 turbine must be increased by 28% for the speed of the ship at scale 1:1 to correspond to that of the  
 287 ship at scale 1:14. The power production being proportional to the water turbine drag, it is also  
 288 increased by 28%. Thus, by a wind of force 4 (7.2 m/s) on the Beaufort scale, the 1:1 scale energy  
 289 ship may therefore be capable of producing over 800 kW.

#### 290 **4.2 Estimate based on a numerical model validated against the present experiments.**

291 Another approach to estimate the energy performance of a large-scale energy ship is to use a  
 292 numerical model. In such approach, the experimental results are used to validate the model. Then,  
 293 the model can be used to determine the velocity and power performance at large scale.

294 In the present study, the numerical model is based on that presented in[13]. That model  
 295 requires as inputs the characteristics of the rig (dimensions, aerodynamic coefficients), of the hull  
 296 (dimensions and residuary coefficients) and of the water turbine. They are described in what follows.

297 As mentioned previously, the rig of the Hobie Cat Tiger consists of a mainsail (17 m<sup>2</sup>) and a jib  
 298 (4.15 m<sup>2</sup>). Unfortunately, to our knowledge, the aerodynamic coefficients for this exact configuration

299 are not available in the literature. Therefore, we used as an approximation the aerodynamic  
 300 coefficients of a mainsail of aspect ratio 6 (Figure 13).

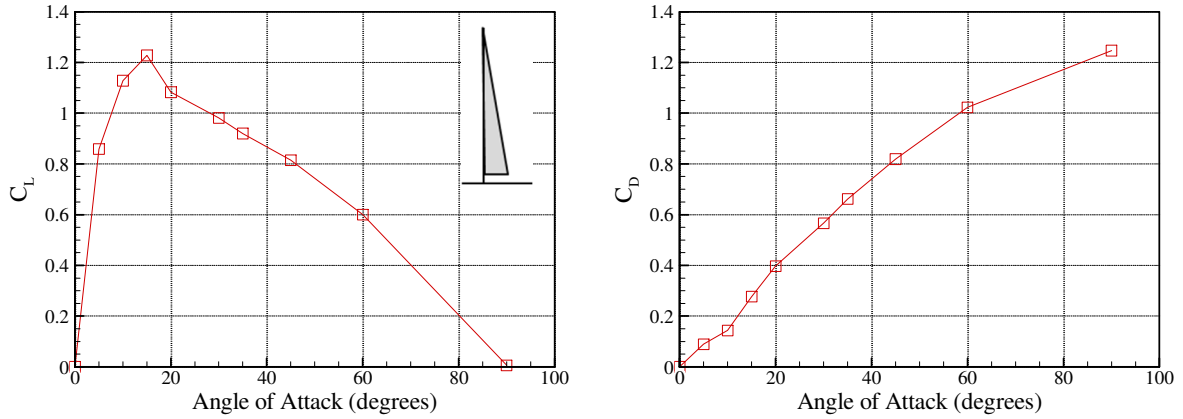

301

302 *Figure 13. Lift (left) and drag (right) coefficients of a Bermudan sail of aspect ratio 6. Source:*

303 *Figure 127 in [20]*

304 The hull was 3D-scanned in order to achieve a digital-twin. Her estimated displacement during  
 305 the experiments is 350 kg (light ship: 180 kg, crew: 150 kg, force sensor: 6kg, water turbine: 9 kg,  
 306 other sensors and equipment: 5 kg). For that displacement, the hull wetted surface is 4.7 m<sup>2</sup>. The hull  
 307 residuary resistance coefficients were obtained using the REVA software [21] (Figure 14).

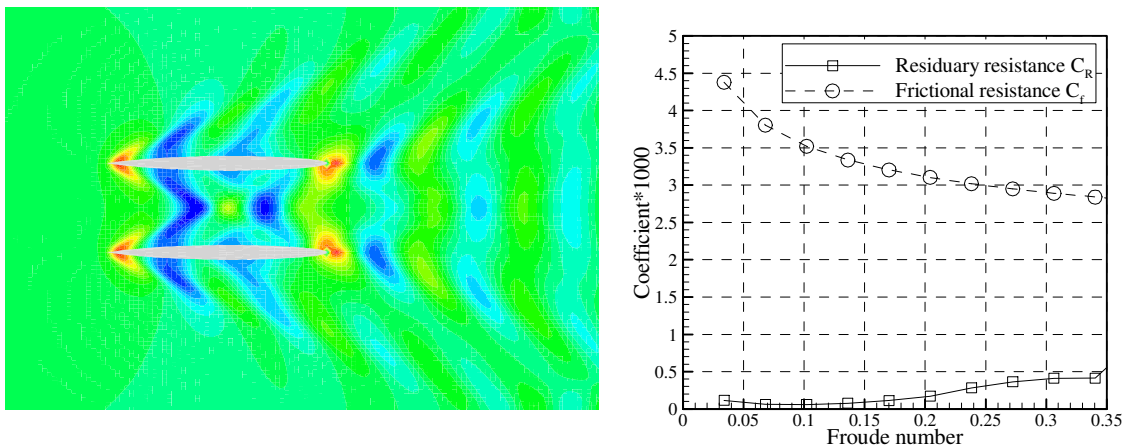

308

309 *Figure 14. Left: Picture of the wave field for ship velocity 2 m/s (Froude number 0.272). Right:*

310 *hydrodynamic coefficients.*

311 To accurately estimate the water resistance, it is also important to take into account the  
 312 appendages. In this respect, the Hobie Cat Tiger is equipped with two daggerboards (0.42 m<sup>2</sup>) and  
 313 two rudders (0.27 m<sup>2</sup>). They were modelled as NACA 0009 profile.

314 For the water turbine coefficients, the results obtained in the towing tank experiments were  
 315 used (see section 2.2).

316 Table 3 shows the comparison of the experimental results and of the numerical model for wind  
 317 conditions corresponding to crossing #3 ( $TWS_{10} = 10$  m/s, TWA = 85.3°). The velocity predicted by  
 318 the numerical model is 2.12 m/s, which is 5% greater than in the experiments (while falling in the  
 319 uncertainty range). The predicted power is 57 W, thus 10% smaller than in the experiments.  
 320 Therefore, the agreement between the numerical model and the experiments is very good.

		1 :14 scale		1 :1 scale	
		Experiments	Numerical model	Scaled water turbine	Optimized water turbines
<b>Length</b>	<i>m</i>	5.51	5.5	77	77
<b>Sail area</b>	<i>m<sup>2</sup></i>	21.15	21.15	4 145	4 145
<b>Displacement</b>	<i>kg</i>	350 (estimate)	350	960 000	960 000
<b>Wetted surface area</b>	<i>m<sup>2</sup></i>	4.7 (estimate)	4.7	921	921
<b>Water turbine diameter</b>	<i>m</i>	0.24	0.24	3.36	4.
$C_T$	-	0.474 (0.057)	0.508	0.508	0.274
$TWS_{10}$	<i>m/s</i>	2.79 (0.48)	2.79	10.	10.
<b>TWA</b>	°	85.3 (4.7)	85.3	90	90
<b>SOG</b>	<i>m/s</i>	2.01 (0.14)	2.12	8.53	9.61
<b>Froude number</b>	-	0.27	0.29	0.31	0.35
<b>Reynolds number</b>	-	1.1E+07	1.2E+07	6.7E+08	7.4E+08
<b>Shaft power</b>	<i>kW</i>	0.063 (0.032)	0.057	1 460	2 320

321 *Table 3. Comparison of the experimental results and the numerical results at 1:14 scale, and*  
 322 *estimates of power production of a large-scale energy ship with the scaled water turbine and*  
 323 *optimized water turbines.*

324 Table 3 also shows velocity and power performance results for the large-scale energy ship. Note  
325 that for the large-scale ship, it is assumed that the sail area is distributed over two masts of height 90  
326 m each. This is because the total sail area of the 1:1 ship is 4 145 m<sup>2</sup>, which is 73% more than the  
327 world greatest Bermudan rig (2 385 m<sup>2</sup>, [22]). Thus, 45 m has been used for the reference altitude for  
328 the calculation of the wind speed in Equation 4 (instead of 63 m for the direct application of the  
329 Froude-scale).

330 Two versions of the large-scale scale energy ship were considered. In the first one (scaled water  
331 turbine), it is assumed that the ship is equipped with a water turbine whose hydrodynamic  
332 coefficients are the same as in the experiments (as in the previous section). According to the model,  
333 that ship would sail at a velocity of 8.53 m/s (16.5 knots) and it could deliver 1 460 kW of mechanical  
334 power on the shaft of the generator for a true wind speed of 10 m/s at 10 m altitude and a true wind  
335 angle of 90 degrees.

336 In the second version, it is assumed that the ship is equipped with two water turbines of 4 m  
337 diameter, and that the design of the rotor of the turbines is optimized. Indeed, it was shown in Pelz  
338 et al. [10] that a key parameter for maximizing energy recovery is the drag induced by the water  
339 turbine, and that the optimal drag can be significantly different from that for wind turbines or tidal  
340 turbines[13]. Therefore, in the present study, it is assumed that the water turbine's rotor is such that  
341 it can deliver the same thrust and power as an actuator disc with 80% efficiency, and the induction  
342 factor is optimized in order to maximize power. Results show that that ship could produce 2 320 kW  
343 for a true wind speed of 10 m/s and a true wind angle of 90°. Thus, despite sailing slower than the  
344 ship with the scaled water turbine, it would produce 37% more power. This can be explained by the  
345 significantly smaller induction factor of the turbines' rotors which minimizes the hydrodynamic losses  
346 (see section 2.2 in[13]).

347 Finally, in agreement with [13], it appears that power production of order of a few megawatts is  
348 feasible for large-scale energy ships for wind conditions of force 5 on the Beaufort scale, wind  
349 conditions which are very common in the high seas.

## 350 **5 Conclusion**

351 In this paper, we presented an experimental proof-of-concept of the energy ship concept. It is  
352 based on a 5.5 m long sailing catamaran equipped with a 600 W hydro-generator. A power  
353 production (mechanical power) of 63 W was measured in the experiments for a true wind speed of  
354 2.79 m/s and a true wind angle of 85.3°. It corresponds to approximately 2 MW for a wind of force 5  
355 on the Beaufort scale for a large-scale energy ship. Thus, the experiments confirm that the energy  
356 ship concept can lead to power production levels comparable to wind turbines.

357 The experimental results also confirm the importance of optimizing the water turbine drag to  
358 maximize power production. However, unfortunately, it was not possible to determine the optimum  
359 drag in the experiments as it is out of the range achievable by the used water turbine. This issue may  
360 be addressed in future work. Note that it may require the development of new water turbine rotor  
361 designs dedicated to energy ships as their optimal induction factor may be significantly different  
362 from that of wind turbines or tidal turbines. Such turbine design studies have already been started by  
363 Siddappaji and Turner [23]. Also, it will be important to reduce the ship drag to a bare minimum and  
364 to optimize the sail aerodynamics, which may be achieved by switching to hydrofoil boats, as  
365 proposed by Platzer and Sarigul-Klijn [24]. Furthermore, it will be crucial to optimize the technical  
366 and economic aspects by using autonomously operating energy ships. In this respect, the techno-  
367 economic optimization studies already performed by Pelz et al. [10] for displacement boats may be  
368 extended to hydrofoil boats.

## 369 **Acknowledgements**

370 This work was supported by the Pays de la Loire Region, France; and Nantes Métropole, Nantes,  
371 France [WEAMEC project WEREVER\_DEMO].

372 **References**

- 373 [1] J. Lee, P. Zhao (2021) GWEC Global wind report 2021, Global Wind Energy Council
- 374 [2] Offshore wind programme board, Transmission costs for offshore wind - final report, April  
375 2016
- 376 [3] M.F. Platzer and N. Sarigul-Klijn (2015) Energy ships and plug-in electric vehicles: are they the  
377 key for a rapid transition to an emission-free economy?, in Proc. Of the ASME 2015  
378 International Mechanical Engineering Congress and Exposition (IMECE), Houston, Texas, USA.
- 379 [4] R.E. Salomon (1982) Process of converting wind energy to elemental hydrogen and apparatus  
380 therefore. U.S. Patent 4335093A
- 381 [5] J. Kim, C. Park (2010) Wind power generation with a parawing on ships, a proposal. Energy,  
382 Vol. 35, pp. 1425-1432
- 383 [6] A. Babarit, J-C. Gilloteaux, G. Clodic, M. Duchet, A. Simoneau, M.F. Platzer (2018) Techno-  
384 economic feasibility of fleets of far offshore hydrogen-producing wind energy converters.  
385 International Journal of Hydrogen Energy, Vol. 43(15), pp. 7266-7289
- 386 [7] A. Babarit, J-C. Gilloteaux, E. Body, J-F. Hétet (2019) Energy and economic performance of  
387 the FARWIND energy system for sustainable fuel production from the far-offshore wind  
388 energy resource. In Proc. Of the 14th International Conference on Ecological Vehicles and  
389 Renewable Energies (EVER), Monaco
- 390 [8] M. Meller (2006) Wind-power linear motion hydrogen production systems. U.S. Patent  
391 7,146,918 B2
- 392 [9] A.R. Gizara (2007) Turbine-integrated hydrofoil. U.S. Patent 2007/0046028A1
- 393 [10] P.F. Pelz, M. Holl, M. Platzer (2016) Analytical method towards an optimal energetic and  
394 commercial wind-energy converter. Energy, Vol. 94, pp. 344-351
- 395 [11] J.C. Gilloteaux, A. Babarit (2017) Preliminary design of a wind driven vessel dedicated to  
396 hydrogen production. In Proc. of the ASME 36th International Conference on Ocean,  
397 Offshore and Arctic Engineering (OMAE2017), Trondheim, Norway.
- 398 [12] K. Ouchi, J. Henzie (2017) Hydrogen generation sailing ship: conceptual design and feasibility  
399 study. In Proc. of IEEE OCEANS 2017



- 400 [13]A. Babarit, G. Clodic, S. Delvoye, J-C. Gilloteaux (2020) Exploitation of the far-offshore wind  
401 energy resource by fleets of energy ships. Part I. Energy ship design and performance. Wind  
402 Energy Science, Vol. 5, pp. 839-853A. Babarit, J.C. Gilloteaux, G. Clodic, M. Duchet, A.  
403 Simoneau, M.F. Platzer (2018) Techno-economic feasibility of far offshore hydrogen-  
404 producing wind energy converters. International Journal of Hydrogen Energy, Vol. 43(15), pp.  
405 7266-7289
- 406 [14] M.F. Platzer and N. Sarigul-Klijn (2009) A novel approach to extract power from free-flowing  
407 water and high-altitude jet streams. In Proc. Of the ASME 2009 3rd International conference  
408 on energy sustainability, Vol. 1, San Francisco, California, USA.
- 409 [15]M.F. Platzer, N. Sarigul-Klijn, J. Young, M.A. Ashraf, J.C.S. Lai (2014) Renewable hydrogen  
410 production using sailing ships. ASME Journal of Energy Resources Technology, Vol. 136
- 411 [16]R. Abd-Jamil, A. Chaigneau, J-C. Gilloteaux, P. Lelong, A. Babarit (2019) Comparison of the  
412 capacity factor of stationary wind turbines and weather-routed energy ships in the far-  
413 offshore. Journal of Physics: conference series, Vol. 1356
- 414 [17]ITTC: General guidelines for uncertainty analysis in resistance tests. ITTC – Recommended  
415 procedures 7.5-02-02-02, 2014
- 416 [18]<https://www.wattandsea.com/fr/produits/hydro-cruising/hydro-cruising-600>
- 417 [19]C.A. Marchaj (2010) Sail performance: techniques to maximise sail power. Adlard coles  
418 nautical, London, UK.
- 419 [20]G. Delhommeau, J-J. Maisonneuve (1987) Extensions du code de calcul de résistance de  
420 vagues REVA: prise en compte des effets de fond et de portance. Compte rendu des 1ères  
421 journées de l'hydrodynamique, Nantes, 1987
- 422 [21] [https://en.wikipedia.org/wiki/Mirabella\\_V](https://en.wikipedia.org/wiki/Mirabella_V)
- 423 [22]K. Siddappaji and M. Turner (2015) Revolutionary Geometries of Mobile Hydrokinetic  
424 Turbines for Wind Energy Applications. ASME International Gas Turbine Congress, Montreal,  
425 Canada

426 [23]M.F. Platzzer and N. Sarigul-Klijn (2021) The Green Energy Ship: Renewable Energy from Wind  
427 over Water. Springer Briefs in Applied Sciences and Technology, Springer 2021