



HAL
open science

Spin Cavitronics System: From Strong to Ultra-Strong Coupling Design steps Machining Metallization 3D printing SolidWorks gap Probe

Guillaume Bourcin, V. Vlaminck, Jeremy Bourhill, Vincent Castel

► **To cite this version:**

Guillaume Bourcin, V. Vlaminck, Jeremy Bourhill, Vincent Castel. Spin Cavitronics System: From Strong to Ultra-Strong Coupling Design steps Machining Metallization 3D printing SolidWorks gap Probe. JEMS 2023, Aug 2023, Madrid, Spain. hal-04206305

HAL Id: hal-04206305

<https://hal.science/hal-04206305>

Submitted on 13 Sep 2023

HAL is a multi-disciplinary open access archive for the deposit and dissemination of scientific research documents, whether they are published or not. The documents may come from teaching and research institutions in France or abroad, or from public or private research centers.

L'archive ouverte pluridisciplinaire **HAL**, est destinée au dépôt et à la diffusion de documents scientifiques de niveau recherche, publiés ou non, émanant des établissements d'enseignement et de recherche français ou étrangers, des laboratoires publics ou privés.

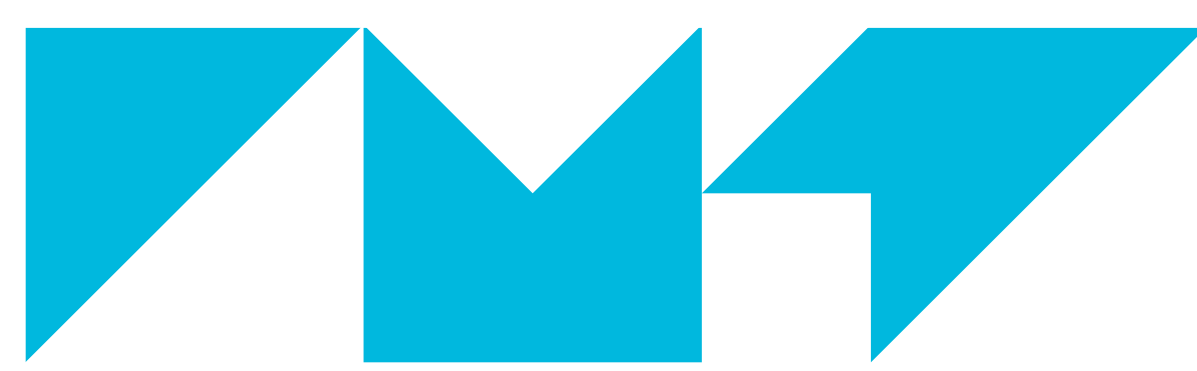

IMT Atlantique
Bretagne-Pays de la Loire
École Mines-Télécom



Spin Cavitronics System: From Strong to Ultra-Strong Coupling



Guillaume Bourcin^{1,2,*}, Vincent Vlaminc^{1,2}, Jeremy Bourhill³, Vincent Castel^{1,2}

¹Lab-STICC (UMR 6285), CNRS, France

²IMT Atlantique, Technopole Brest Iroise, France

³University of Western Australia, 35 Stirling Highway, Crawley, Western Australia 6009, Australia

*Guillaume.bourcin@imt-atlantique.fr

Introduction

Experimental study of ultra strong coupling (up to 60%) at room temperature with reconfigurable double re-entrant cavities and a millimetric YIG slab.

Currently used models no longer describe the observed hybridization between cavity photon and magnon above the strong coupling regime.

Advantages:

- ▶ Tunable (magnons and photons)
- ▶ Long coherence times (YIG)
- ▶ Ability to be coupled to other systems (e.g. qubits)

Cavity Design & Optimization

Double re-entrant cavity [1]:

- ▶ RF H -field in the YIG
- ▶ RF H and E -fields separated

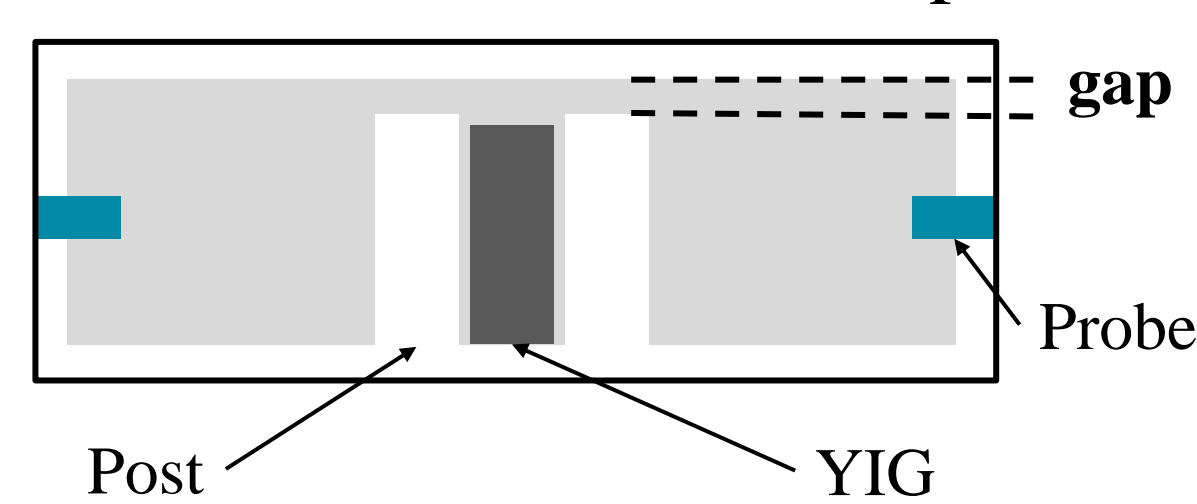

Slab dimensions:

3.82×6.09×0.61 mm³

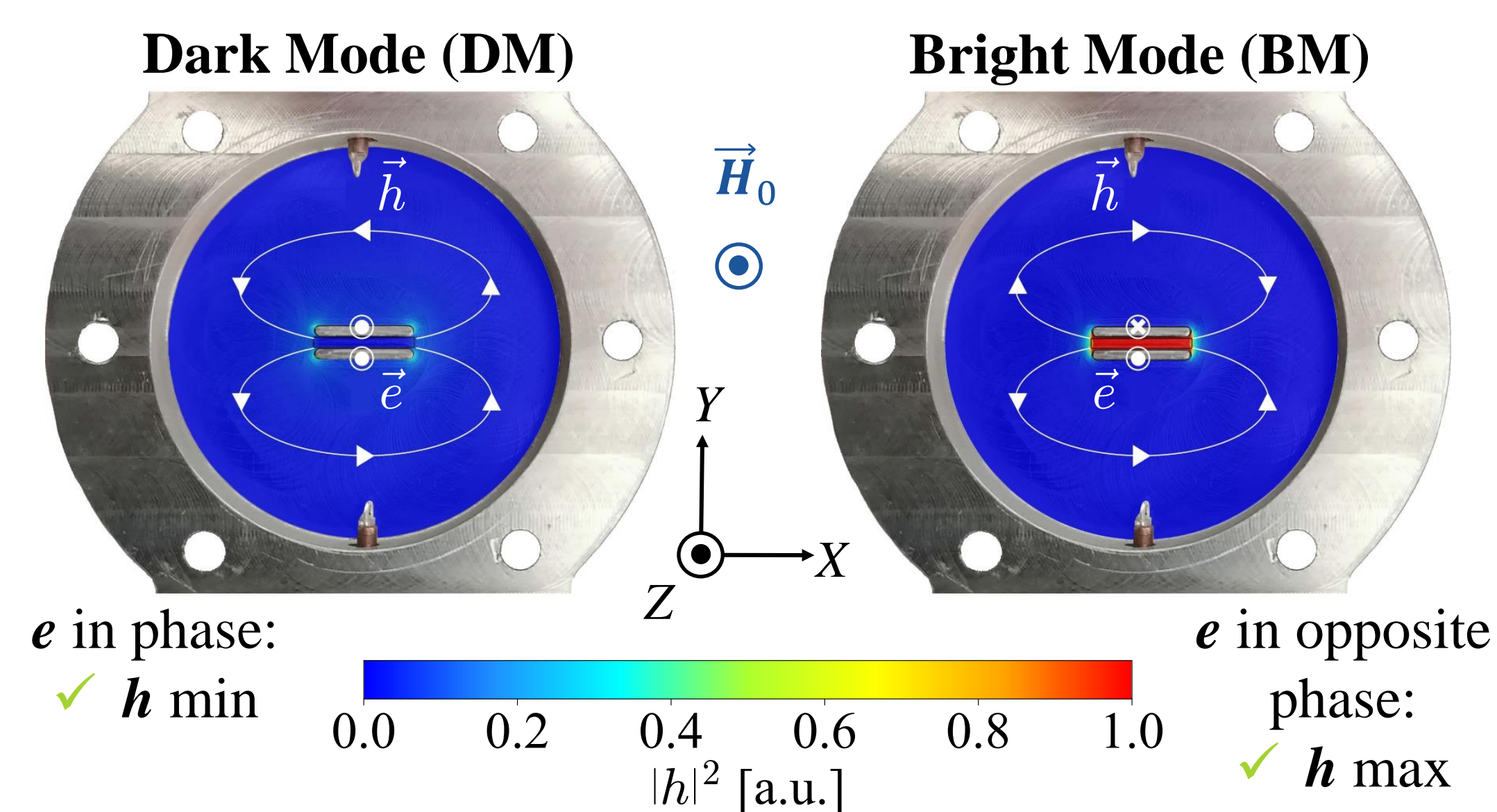

Coupling strength:

$$\frac{g}{2\pi} = \eta \sqrt{\omega} \frac{\gamma}{4\pi} \sqrt{\frac{\mu}{g_l \mu_B}} \mu_0 \hbar n_s \quad \omega/2\pi: \text{Cavity frequency}$$

$$\eta: \text{Filling factor}$$



Optimization:

COMSOL simulation with EigenMode (EM) Solver:

- ▶ Maximize η

$$\eta = \frac{\left(\int_{V_m} \mathbf{h} \cdot \mathbf{x} dV \right)^2 + \left(\int_{V_m} \mathbf{h} \cdot \mathbf{y} dV \right)^2}{V_m \cdot \int_{V_c} |\mathbf{h}|^2 dV} \quad [2]$$

Gap dependence of the coupling strength

Post dimensions:
6×4.2×0.6 mm³
Cavity radius:
12 mm

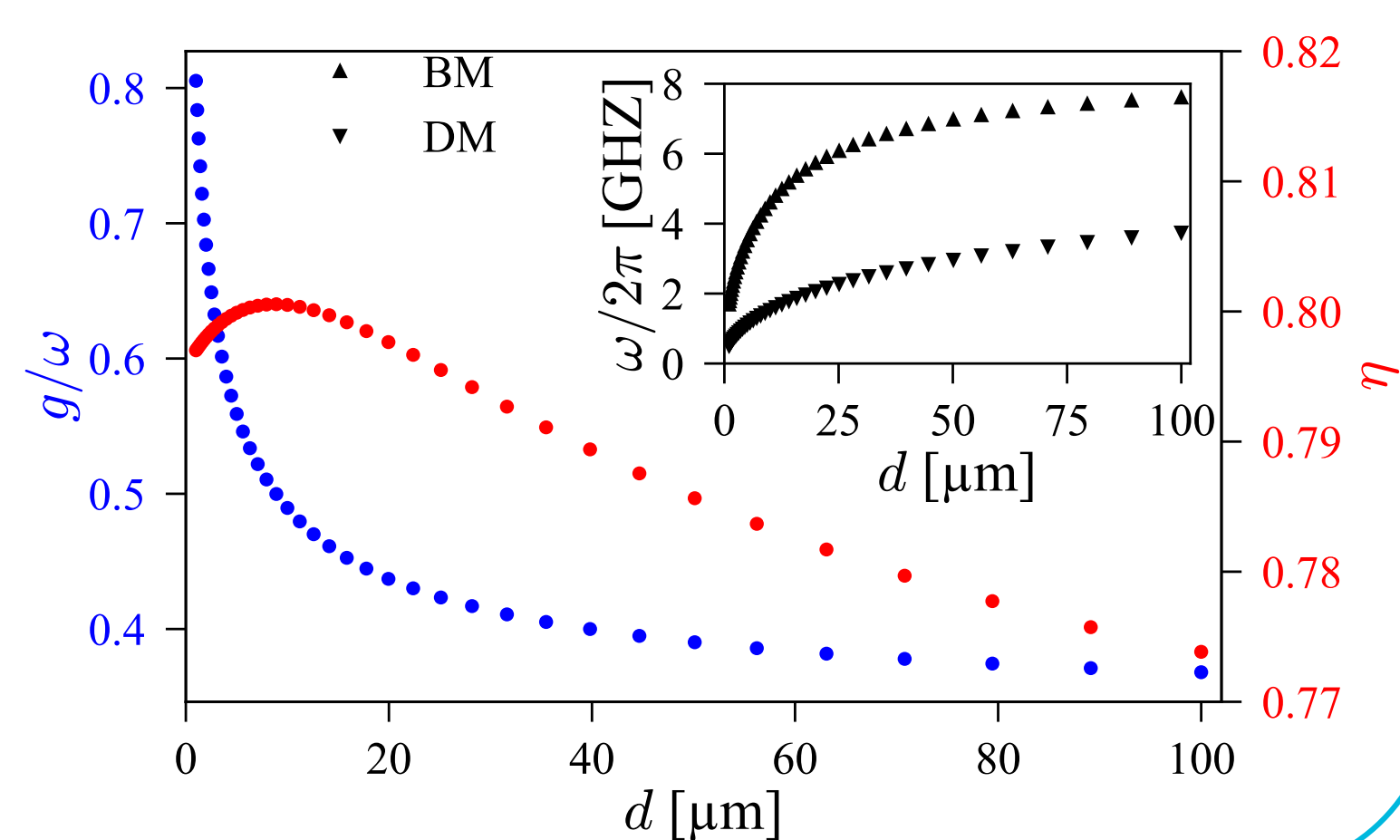

Measurements & Modelling

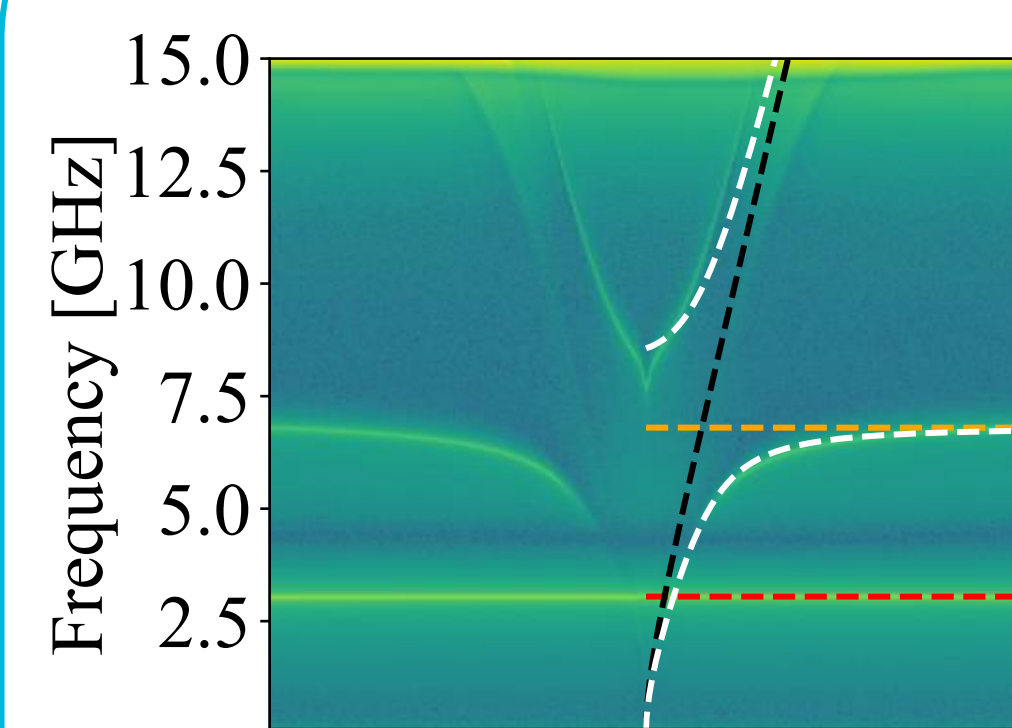

Hopfield model [3]:

$$\hbar \omega_c \hat{a}^\dagger \hat{a} + \hbar \omega_m \hat{b}^\dagger \hat{b} + \hbar g (\hat{a}^\dagger + \hat{a})(\hat{b}^\dagger + \hat{b}) + \hbar D (\hat{a}^\dagger + \hat{a})^2$$

Eigen frequencies:

$$2\omega_{\pm}^2 = \omega^2 + \omega_m^2 + 4g^2 \pm \sqrt{(\omega^2 - \omega_m^2 + 4g^2)^2 + 16g^2\omega_m^2}$$

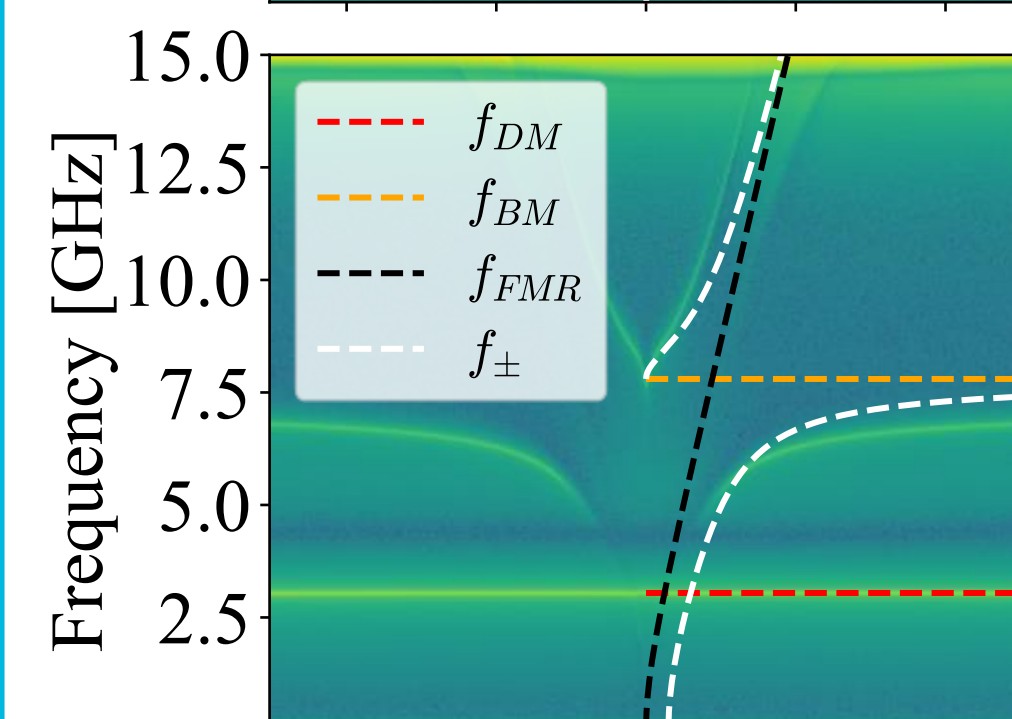

Dicke model [3]:

$$\hbar \omega_c \hat{a}^\dagger \hat{a} + \hbar \omega_m \hat{b}^\dagger \hat{b} + \hbar g (\hat{a}^\dagger + \hat{a})(\hat{b}^\dagger + \hat{b})$$

Eigen frequencies:

$$2\omega_{\pm}^2 = \omega^2 + \omega_m^2 \pm \sqrt{(\omega^2 - \omega_m^2)^2 + 16g^2\omega\omega_m}$$

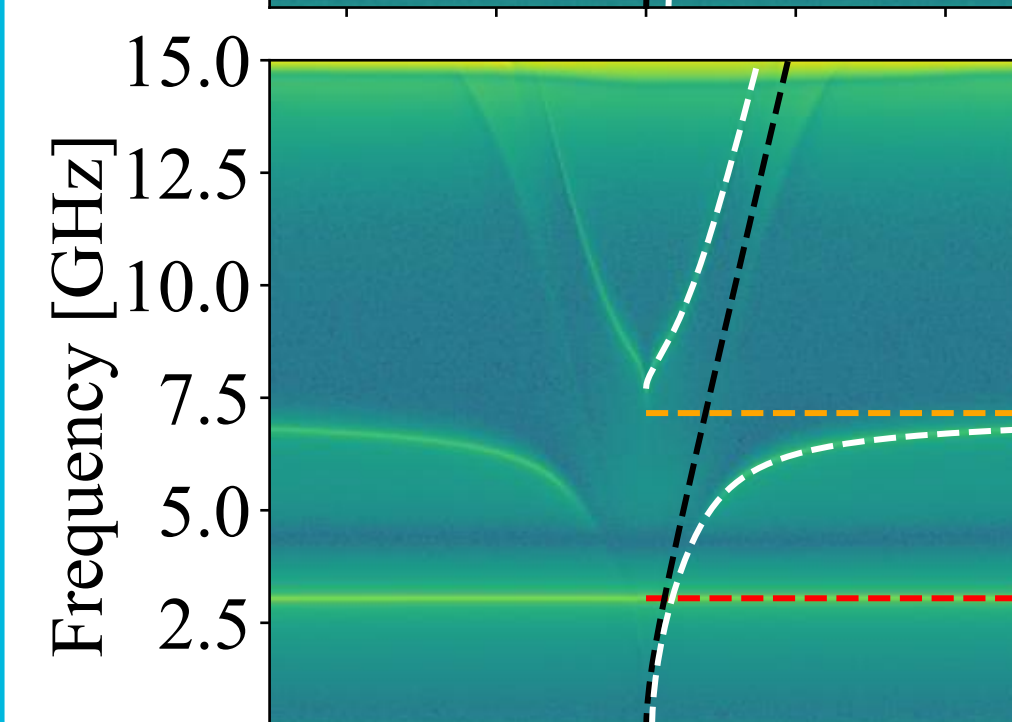

Modified Dicke model:

Following [3] and [4], it was also necessary to modify standard model:

$$\omega_{MD}^\pm = \omega_D^\pm (\omega_m \rightarrow \omega_m + \Delta_m)$$

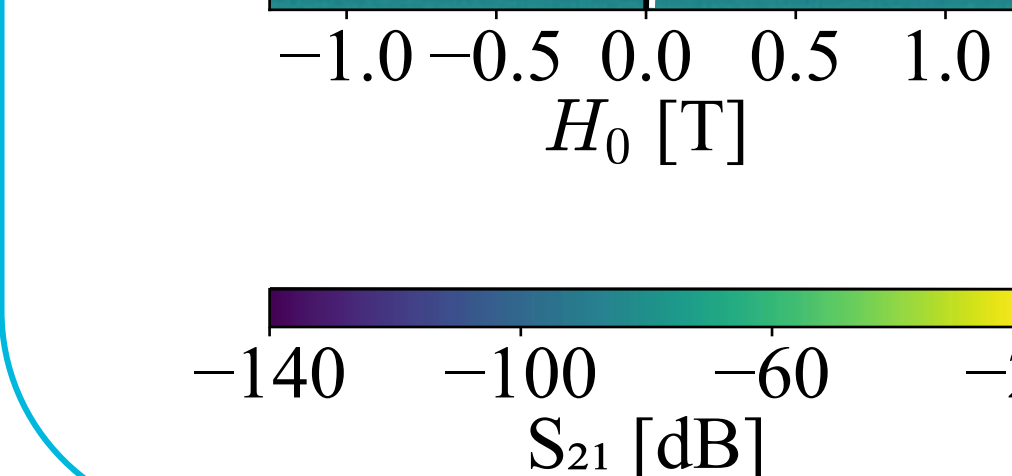

- ✗ Standard model can not be used
- ✓ Adding a frequency shift to the Dicke model is useful

Measurements & Simulations

COMSOL simulation with Frequency Domain (FD) Solver:

- ▶ S-parameters extraction through static field H_0 sweep.
- ▶ Including Polder tensor permeability, excitation probes, cavity electric losses, and demagnetizing field [5].

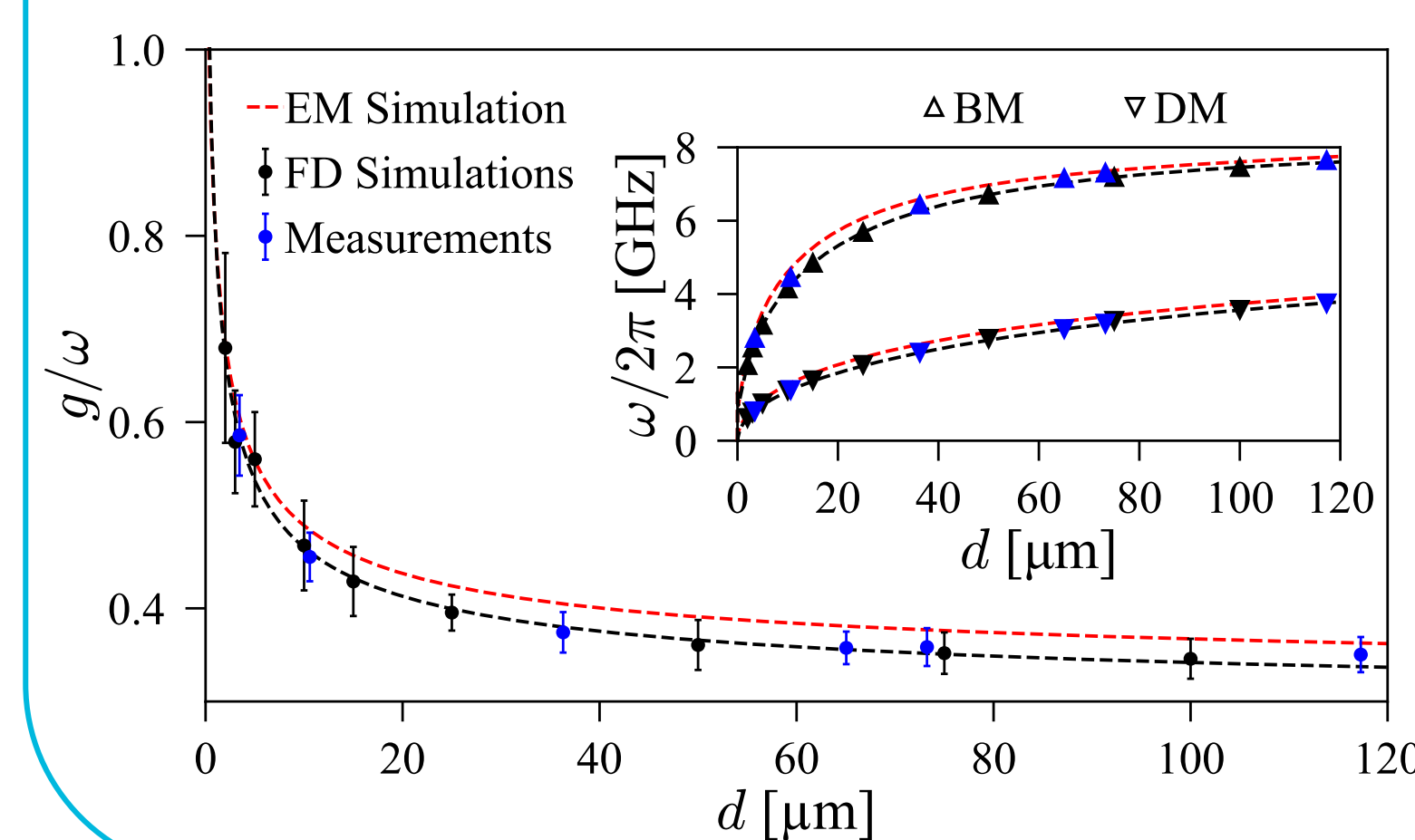

Gap dependence of the coupling strength

✓ COMSOL model confirmed

Study of the Transition SC/USC

Reduce slab dimensions in simulations up to 1/5 with same aspect ratio allows g/ω up to 2,7%.

Analysis:

- ▶ Δ_m function of g^2/ω , hence of η^2
- ▶ Δ_m negligible when $g/\omega < 0.1$

✓ SC converges to the standard Dicke model

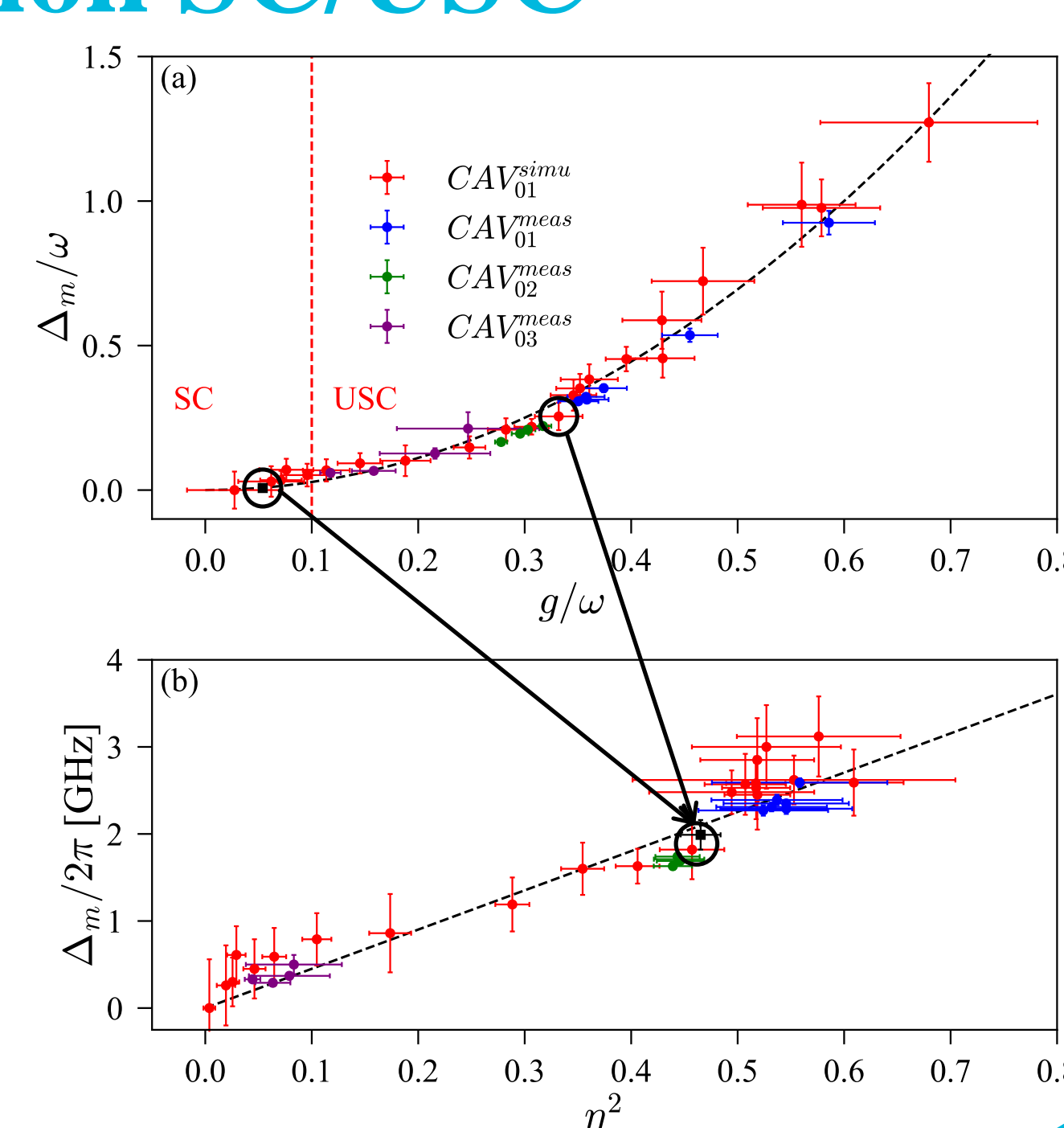

Conclusion

- ✓ USC reached in a double re-entrant cavity
- ✓ Cavity tunable in frequency
- ✓ Adding Δ_m in the Dicke Model: A new Hamiltonian is needed

Applications potentials:

- ▶ Information transfer
- ▶ Sensors (dark matter, magnetometry...)
- ▶ RF components (insulators, circulators...)

Design steps

SolidWorks

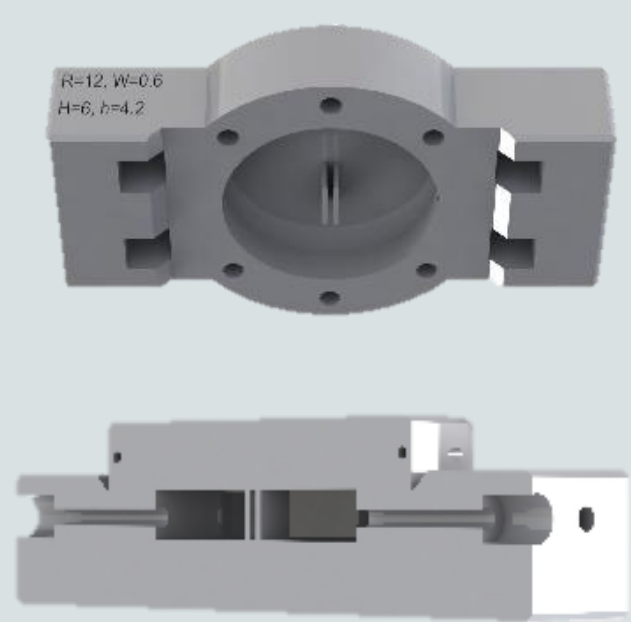

3D printing



Metallization



Machining



$g/\omega = [0.35; 0.58]$

CAV₀₃ [2]

$g/\omega = [0.13; 0.23]$

References

- [1] Phys. Rev. Applied **2**, 054002 (2014)
- [2] Journal of Applied Physics **128**, 073904 (2020)
- [3] Phys. Rev. B **101**, 075301 (2020)
- [4] Phys. Rev. Applied **16**, 034029 (2021)
- [5] Journal of Applied Physics **36**, 1579 (1965)