



HAL
open science

Spin Cavitronics System: From Strong to Ultra-Strong Coupling

Guillaume Bourcin, V. Vlaminc, Jeremy Bourhill, Vincent Castel

► **To cite this version:**

Guillaume Bourcin, V. Vlaminc, Jeremy Bourhill, Vincent Castel. Spin Cavitronics System: From Strong to Ultra-Strong Coupling. Spincavitronics IV, Dec 2022, Erlangen, Germany. . hal-04206288

HAL Id: hal-04206288

<https://hal.science/hal-04206288>

Submitted on 13 Sep 2023

HAL is a multi-disciplinary open access archive for the deposit and dissemination of scientific research documents, whether they are published or not. The documents may come from teaching and research institutions in France or abroad, or from public or private research centers.

L'archive ouverte pluridisciplinaire **HAL**, est destinée au dépôt et à la diffusion de documents scientifiques de niveau recherche, publiés ou non, émanant des établissements d'enseignement et de recherche français ou étrangers, des laboratoires publics ou privés.



IMT Atlantique
Bretagne-Pays de la Loire
École Mines-Télécom



Spin Cavitronics System: From Strong to Ultra-Strong Coupling

Guillaume Bourcin^{1,2}, Vincent Vlaminc^{1,2}, Jeremy Bourhill³, Vincent Castel^{1,2}

¹Lab-STICC (UMR 6285), CNRS, France

²IMT Atlantique, Technopole Brest Iroise, 29200 Brest, France

³University of Western Australia, 35 Stirling Highway, Crawley, Western Australia 6009, Australia

Introduction

Experimental study of ultra strong coupling (up to 60%) at room temperature with reconfigurable double re-entrant cavities and a millimetric YIG slab.

Currently used models no longer describe the observed hybridization between cavity photon and magnon above the strong coupling regime.

Advantages:

- ▶ Tunable (magnons and photons)
- ▶ Long coherence times (YIG)
- ▶ Ability to be coupled to other systems (e.g. qubits)

Cavity Design & Optimization

Double re-entrant cavity [1]:

- ▶ RF H -field in the YIG
- ▶ RF H and E -fields separated

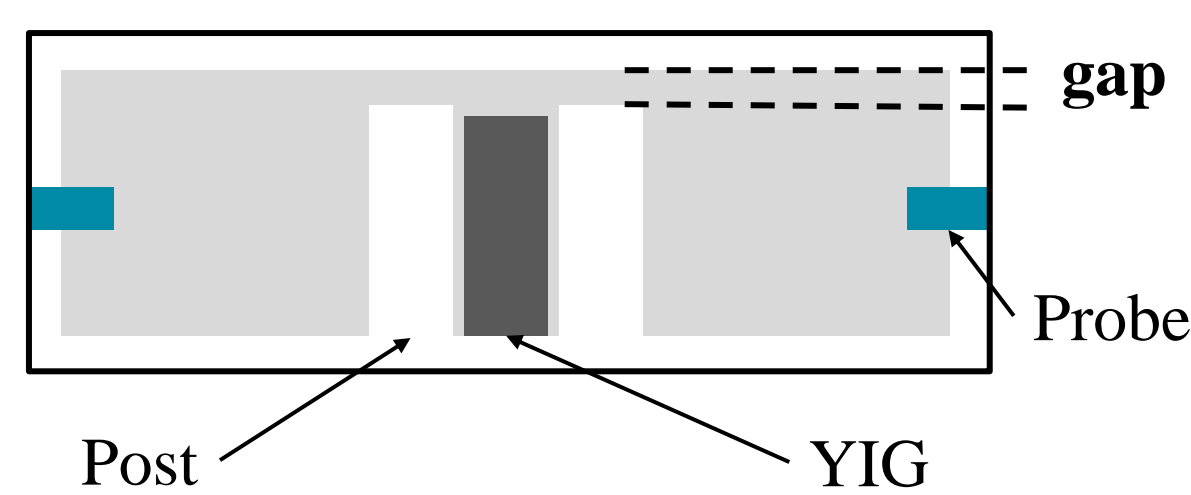

Slab dimensions:
3.82×6.09×0.61 mm³

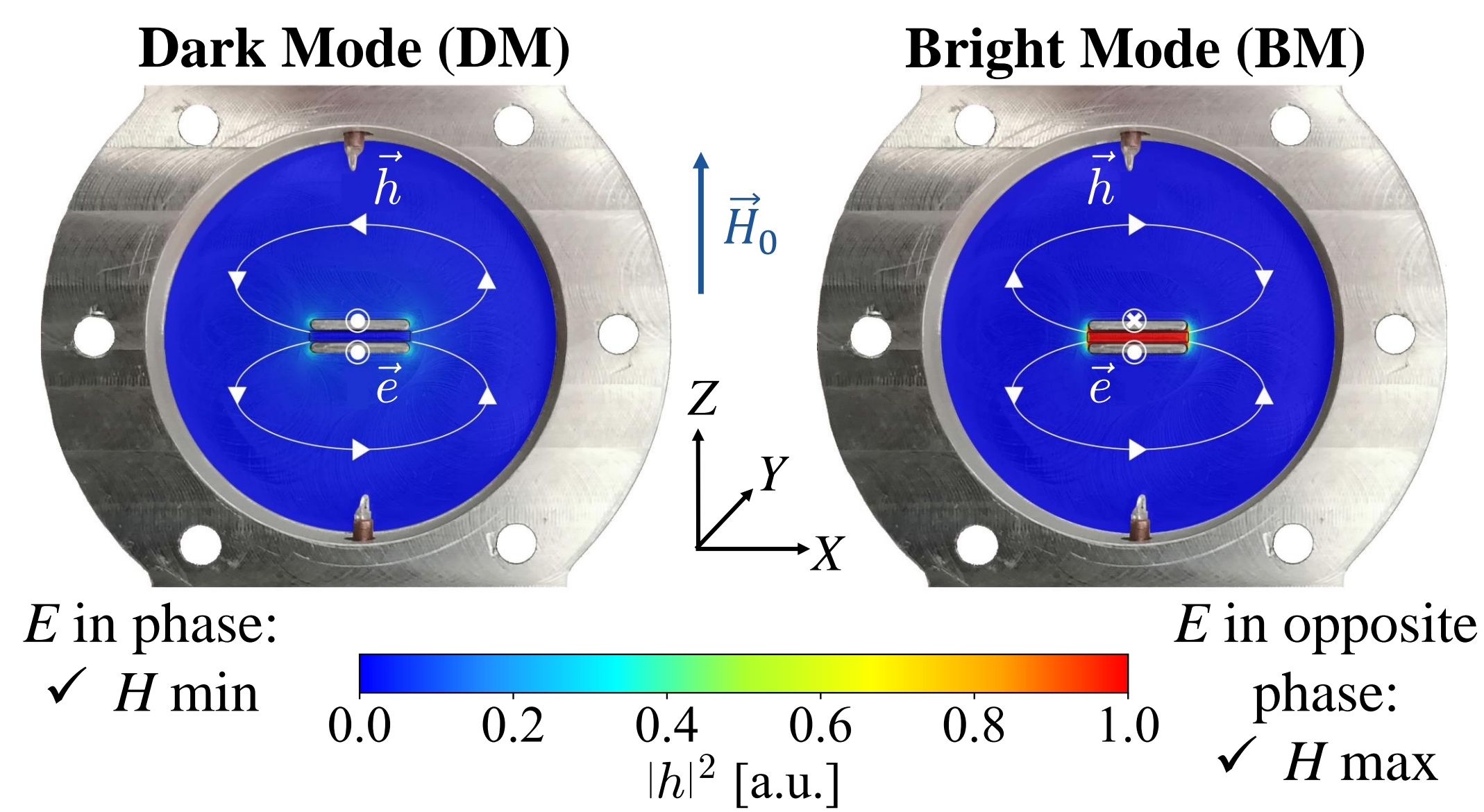
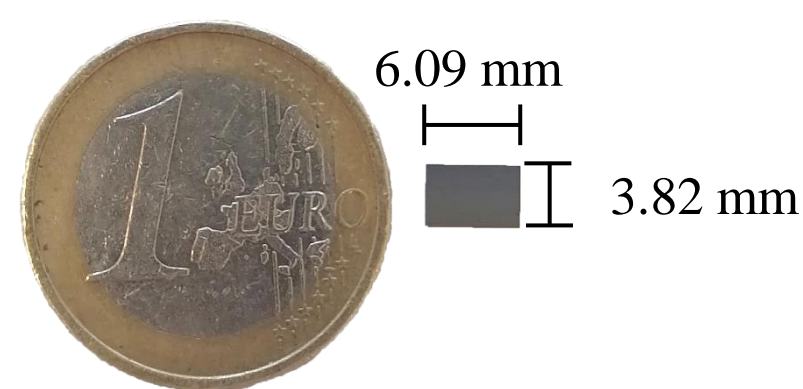

Coupling strength:

$$\frac{g}{2\pi} = \eta \sqrt{\omega} \frac{\gamma}{4\pi} \sqrt{\frac{\mu}{g_1 \mu_B}} \mu_0 \hbar n_s \quad \omega/2\pi: \text{Cavity frequency}$$

$$\eta: \text{Filling factor}$$



Optimisation:

COMSOL simulation with EigenMode Solver:

- ▶ Maximize η

$$\eta = \sqrt{\frac{(\int_{V_m} \vec{h} \cdot \vec{e}_x dV)^2 + (\int_{V_m} \vec{h} \cdot \vec{e}_y dV)^2}{\int_{V_m} |\vec{h}|^2 dV}} \quad [2]$$

Gap dependence of the coupling strength

Posts dimensions:
6×4.2×0.6 mm³
Cavity radius: 12 mm

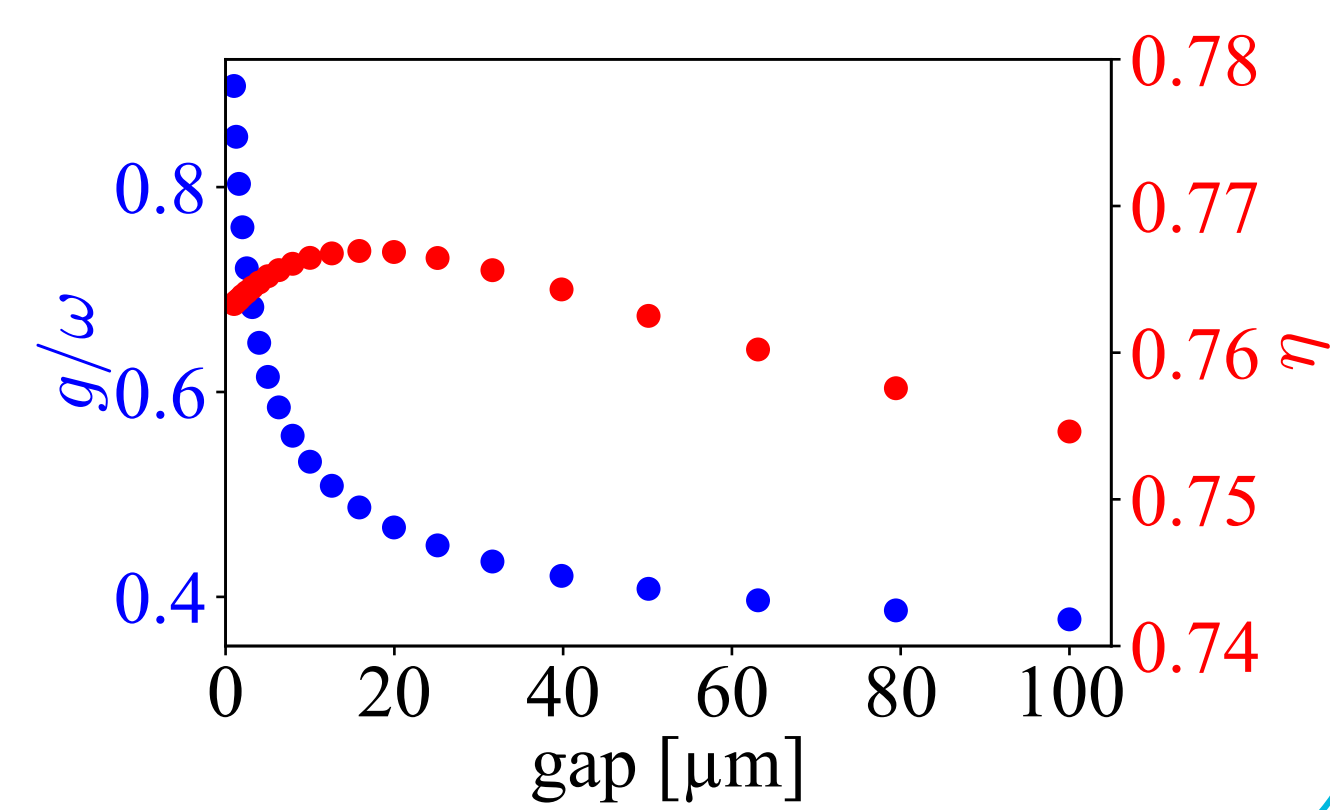

Study of the Transition SC/USC

Reduce slab dimensions in simulations up to 1/5 with same aspect ratio allows to g/ω up to 2,7%.

Analysis:

- ▶ ω_Δ is function to g^2/ω
- ▶ ω_Δ is negligible when $g/\omega < 0.1$

✓ SC: converges to the standard Dicke model

✓ It exists a forbidden gap in USC

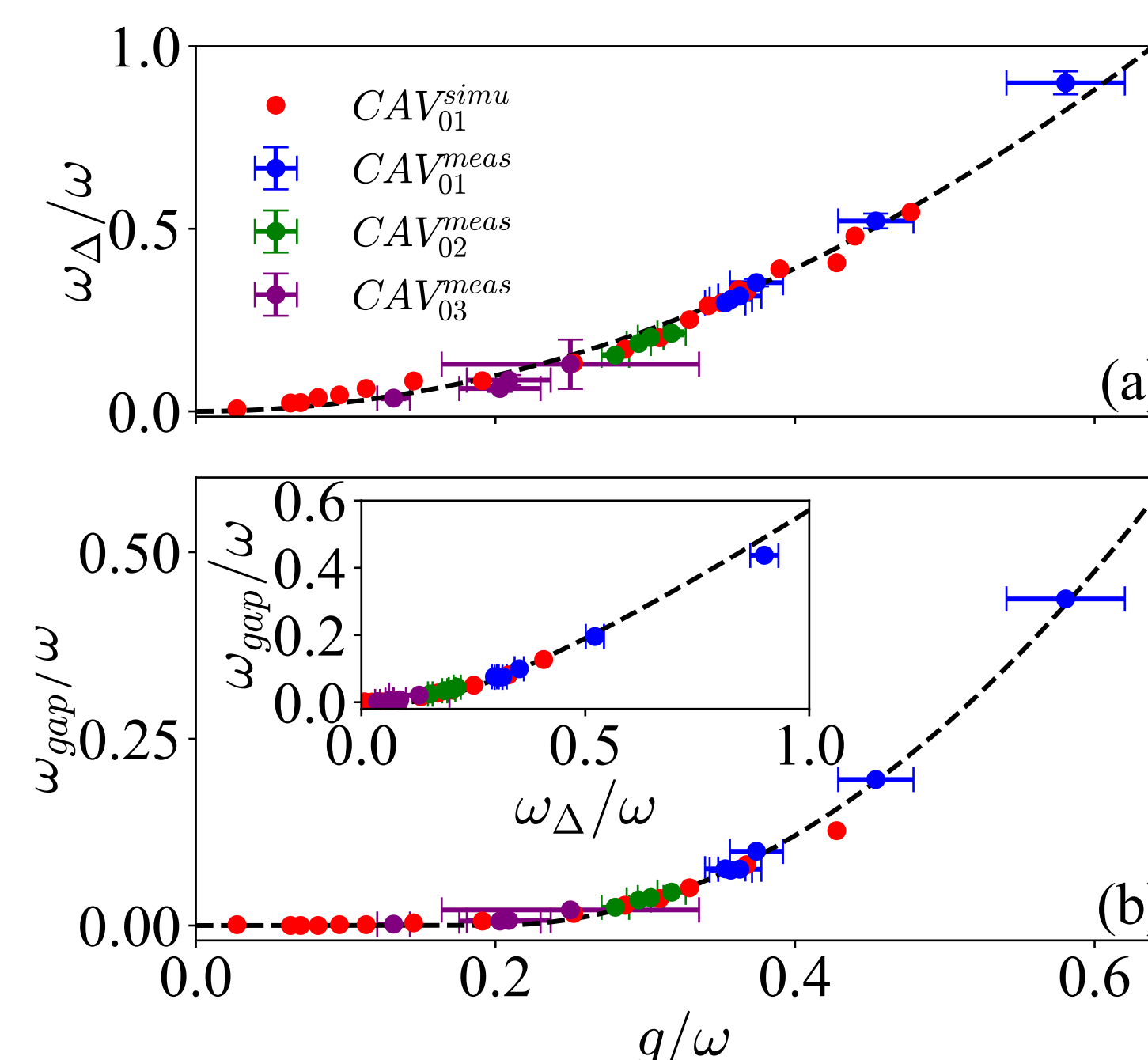

Measurements & Modelling

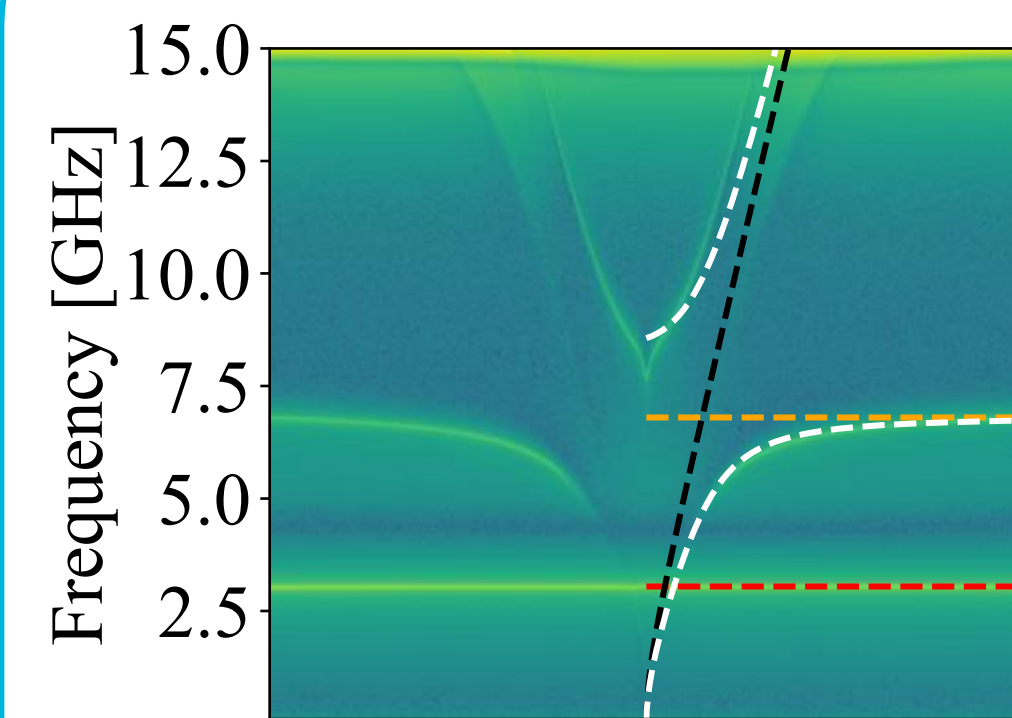

Hopfield model:

$$\hbar\omega_c \hat{a}^\dagger \hat{a} + \hbar\omega_m \hat{b}^\dagger \hat{b} + \hbar g (\hat{a}^\dagger + \hat{a})(\hat{b}^\dagger + \hat{b}) + \hbar D (\hat{a}^\dagger + \hat{a})^2$$

Eigenmodes:

$$2\omega_\pm^2 = \omega^2 + \omega_m^2 + 4g^2 \pm \sqrt{(\omega^2 - \omega_m^2 + 4g^2)^2 + 16g^2\omega\omega_m}$$

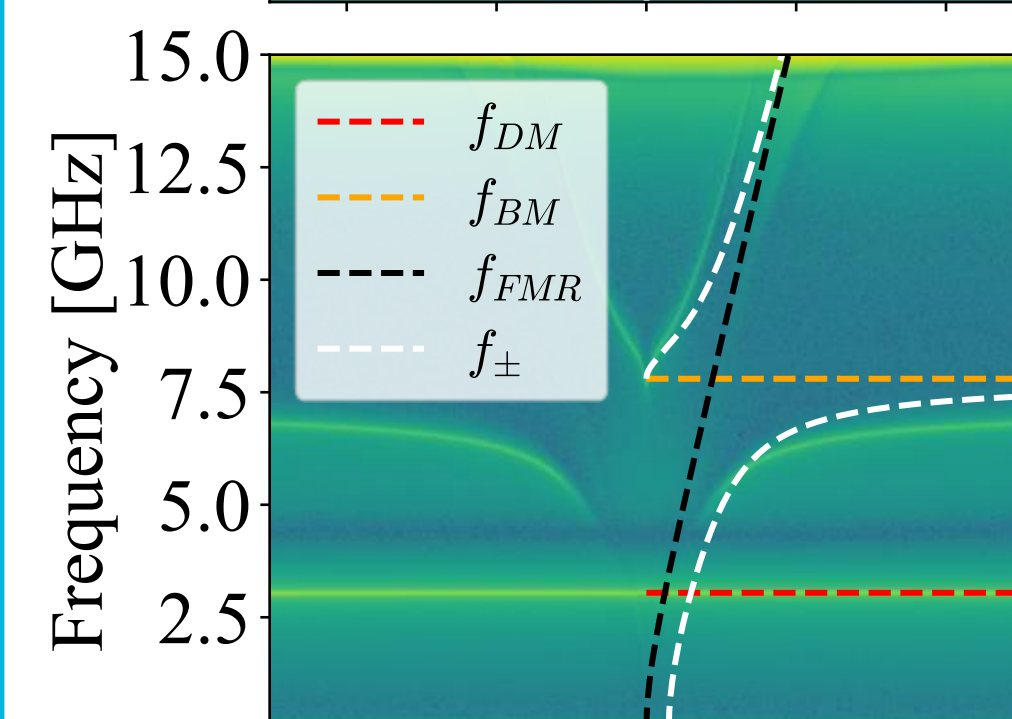

Dicke model:

$$\hbar\omega_c \hat{a}^\dagger \hat{a} + \hbar\omega_m \hat{b}^\dagger \hat{b} + \hbar g (\hat{a}^\dagger + \hat{a})(\hat{b}^\dagger + \hat{b})$$

Eigenmodes:

$$2\omega_{D\pm}^2 = \omega^2 + \omega_m^2 \pm \sqrt{(\omega^2 - \omega_m^2)^2 + 16g^2\omega\omega_m}$$

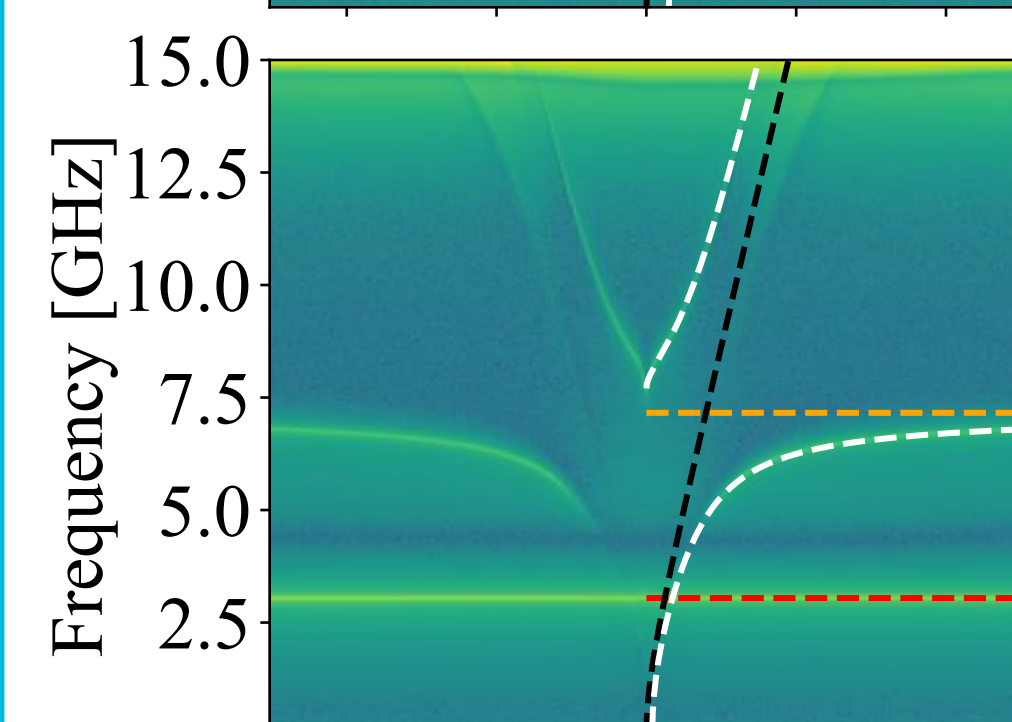

Modified Dicke model:

Following [3] and [4], it was also necessary to modify standard model:

$$\omega_{MD}^\pm = \omega_D^\pm(\omega_m \rightarrow \omega_m + \omega_\Delta)$$

- ✗ Standard model can not be used
- ✓ Adding a frequency shift to the Dicke model works

Measurements & Simulations

COMSOL simulation with Frequency Domain Solver:

- S -parameters extraction through static H -field sweep.
- Including Polder tensor permeability, excitation probes, cavity electric losses, and demagnetizing field [5].

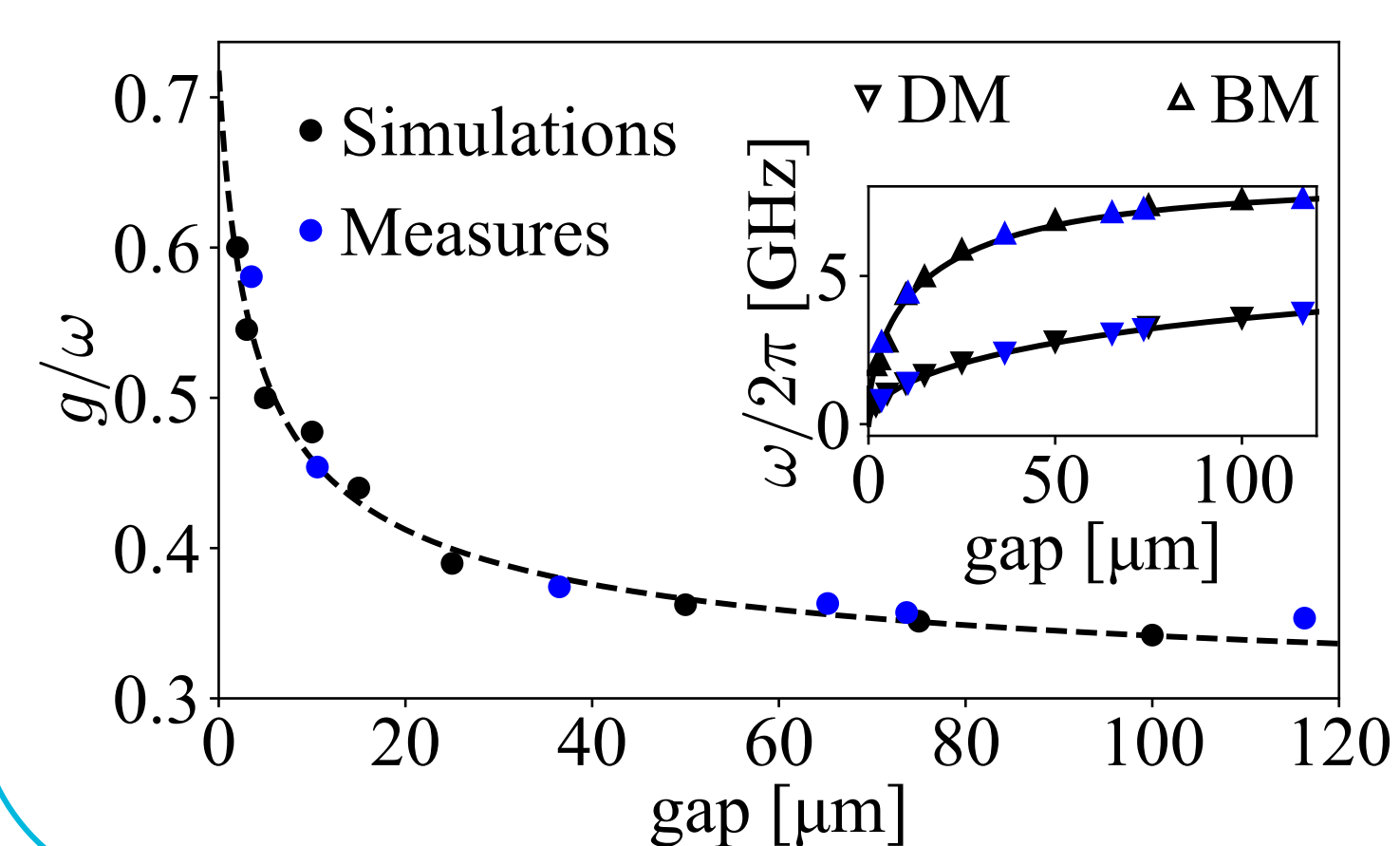

Gap dependence of the coupling strength

✓ COMSOL model confirmed

Conclusion

- ✓ USC reached in a double re-entrant cavity
- ✓ Cavity tunable in frequency
- ✓ Adding ω_Δ in the Dicke Model: It is needed a new Hamiltonian

Applications potentials:

- ▶ Information transfert
- ▶ Sensors (dark matter, magnetometry...)
- ▶ RF components (insulators, circulators...)

Designing steps

SolidWorks

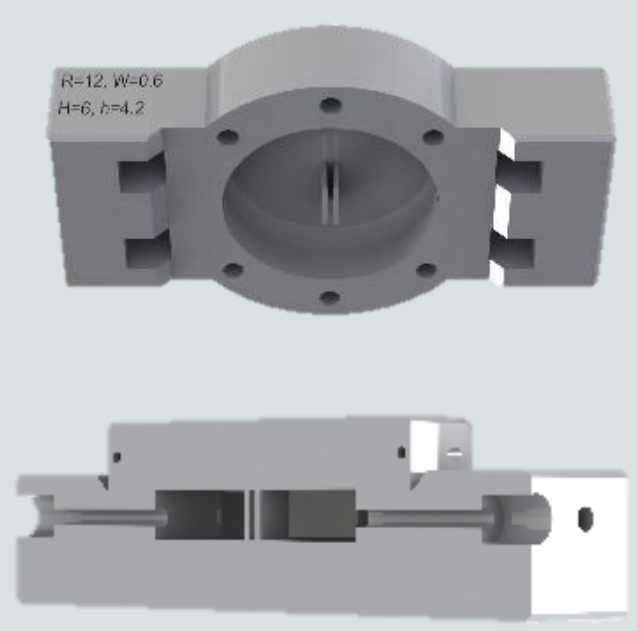

3D printing

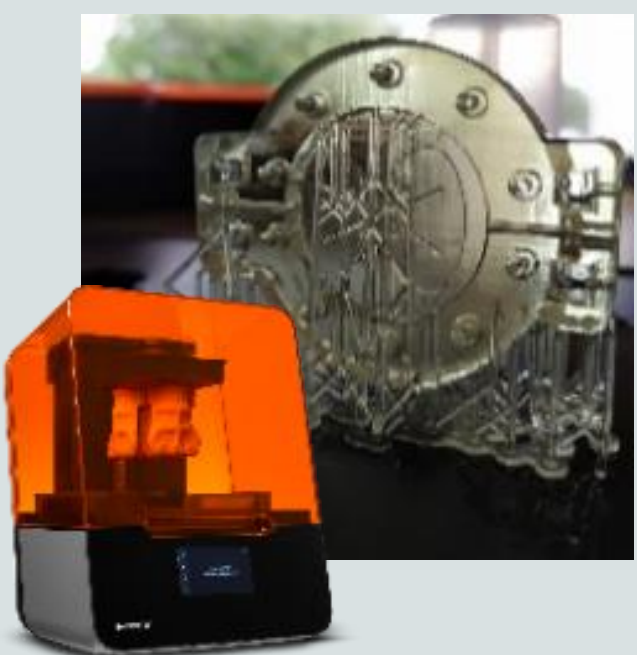

Metalization



Machining



References

- [1] Phys. Rev. Applied 2, 054002 (2014)
- [2] Journal of Applied Physics 128, 073904 (2020)
- [3] Phys. Rev. B 101, 075301 (2020)
- [4] Phys. Rev. Applied 16, 034029 (2021)
- [5] Journal of Applied Physics 36, 1579 (1965)

