



HAL
open science

Detailed shelter response profile Nepal

Julien Hosta, Manish Raj Timsina

► **To cite this version:**

Julien Hosta, Manish Raj Timsina. Detailed shelter response profile Nepal: local building cultures for sustainable and resilient habitats. *CRAterre*, pp.71, 2023. hal-04197540

HAL Id: hal-04197540

<https://hal.science/hal-04197540>

Submitted on 6 Sep 2023

HAL is a multi-disciplinary open access archive for the deposit and dissemination of scientific research documents, whether they are published or not. The documents may come from teaching and research institutions in France or abroad, or from public or private research centers.

L'archive ouverte pluridisciplinaire **HAL**, est destinée au dépôt et à la diffusion de documents scientifiques de niveau recherche, publiés ou non, émanant des établissements d'enseignement et de recherche français ou étrangers, des laboratoires publics ou privés.



Distributed under a Creative Commons Attribution - NonCommercial - ShareAlike 4.0 International License

DETAILED
SHELTER RESPONSE PROFILE

NEPAL

LOCAL BUILDING CULTURES FOR SUSTAINABLE AND RESILIENT HABITATS

1ST EDITION

AUGUST 2023

VERSION TO BE
VALIDATED BY NEPAL
SHELTER CLUSTER





Shelter Response Profiles (SRP) / Local Building Practices Profiles



BACKGROUND

The organisations backing this document (see back cover) have been working for several years on the elaboration and dissemination of methods for the assessment of local building cultures (LBC), especially regarding their potential to contribute to Disaster Risk Reduction (DRR), and also to shelter and housing responses in post-conflict and post disaster situations. The aim is to facilitate the identification of the strengths and weaknesses of LBC and the opportunities they offer – in an adapted version if necessary – in housing reconstruction, retrofitting or improvement projects.

In doing so, it is essential to consider that families and communities often live in changing environments due to factors such as conflict, climate change, urbanization, and globalization, potentially resulting in changing socio-cultural attitudes. Thus, even if local practices are meaningful, they are challenged, and it is still advisable to find locally manageable solutions and limit innovations so that they can be adopted toward sustainable development and increased local resilience capacity.

SRPs are part of a broader set of tools and documents developed and used to facilitate contextualization of responses. They are one of the proposed activities of the Protocol “[Informing choice for better shelter](#)” in its step 1 “Understanding the context”, developed by the “[Promoting Safer Building Working Group](#)” (now evolved towards [Recovery CoP](#)) of the Global Shelter Cluster.

knowledge, know-how and techniques at various scales (materials, building systems, house, compound, settlement organisation).

- To give a non-exhaustive overview of a country or territory: demographic, cultural, social and economic data; hazards, environment and climate change impacts; impacts of crises in the population; HLP issues; legal and institutional framework; construction sector, etc., and so to help orient practitioners in new contexts.
- To eventually become an advocacy tool for the shelter sector/cluster members, agencies, donors, or local authorities for more localized actions, facilitating self-recovery and communities’ resilience.



CONTENT AND SUGGESTIONS FOR USE

This document introduces reference data on local building cultures and sociocultural strategies that result in people’s resilience. It also provides evaluation criteria that can help in elaborating locally adapted project- strategies.

Context and details differ from place to place, and stakeholders benefit from the collected data to make comprehensive and accurate decisions. Thus, SRPs should not be considered exhaustive. They are a first level of information that needs to be deepened through field analysis of the specific intervention context. It remains essential to organize field surveys that will allow exchanges with local actors and inhabitants on the constraints and potentials of territories in terms of access to land, lifestyles, material and human resources, practices, knowledge, and construction capacities.



OBJECTIVES

SRPs have several complementary objectives:

- To help to recognise the importance of understanding a context before proposing any action or project.
- To favour the development of shelter and human settlements responses more focused on localization, reduction of climate change and environmental impacts, and promotion of self-recovery strategies.
- To help to better take into account the existing construction sector, natural and human resources, local knowledge, existing solutions and good practices, and local cultural and social practices such as existing DRR



TARGET AUDIENCE

Local, national, international, governmental, non-governmental and civil society actors that are involved in the prevention, preparedness and response to humanitarian crises (disasters or conflicts) in the shelter, housing and human settlements sector.



NEPAL PROFILE: INFORMATION, DATA COLLECTION AND PRODUCTION

This Profile was produced from September 2022 to March 2023. The process was codirected by CRAterre and the Nepal Shelter Cluster. A group of Nepal based organizations have contributed to the process. Apart from local contributions, a dedicated literature review was achieved (see Sources consulted to produce this document). The profile has been revised by several international and Nepalese experts and shelter and housing actors in Nepal. This document

summarizes and disseminates strengths of local building cultures, including a variety of hazard-resistant practices; considerations about disaster prevention, risk reduction and mitigation measures; environmental impacts; knowledge and experience developed by local communities; etc. These aspects have been identified, analysed and many of them validated over the years.

This document is intended to be a living one, and new contributions will be highly appreciated (please contact secretariat@craterre.org and the Nepal Shelter Cluster coordination).

↳ For more information

SHELTER RESPONSE PROFILES

<https://www.sheltercluster.org/promoting-safer-building-working-group/library/shelter-response-profiles>

PARTICIPATORY ASSESSMENT OF LOCAL BUILDING CULTURES

<https://sheltercluster.org/promoting-safer-building-working-group/library/understanding-context-forms-and-report-template>

SHELTER RESPONSE PROFILES

[Fiji](#)

[Ecuador \(coast\)](#)

[Haiti](#)

[Bangladesh](#)

[Ethiopia](#)

[Democratic Republic of Congo \(southeast\)](#)

[Malawi](#)

[Tonga](#)

[Burkina Faso](#)

[Yemen](#)

[Venezuela](#)

[Somalia](#)

ABOUT TO BE RELEASED:

Nepal

Syria (northwest)



Cover photos (from top to bottom):

Mountain settlement, Upper Mustang, ©Marie Schuitten

Mid Hills, Reconstruction of a house with local materials, including key messages, Gorkha, 2015, ©Eefje Hendricks

Terai settlement, ©Marie Schuitten

Foreword

► HUMANITARIAN CONTEXT

Since the resolution of Nepal's ten-year civil war in 2006, the state has attempted to implement a political transition and reshape political institutions. Yet, more than a decade later, many communities still need resources to support the post-conflict recovery and create accountability for the violence experienced during the war.

The results of the decade-long conflict were severe: 13,000 people were killed and Nepal experienced "large-scale disruptions to education, health and basic government services across the country," in addition to widespread fear and instability.

In 2015, Nepal experienced a devastating earthquake, leaving communities even more vulnerable and creating challenges for the ongoing political transition.

► HIGH VULNERABILITIES

Nepal has long been struggling to managing its diverse population, its powerful neighbours and its topographical extremes. Nepal has been affected across its history by both conflicts and disasters, and political upheaval has at times directly impacted the state's ability to respond to crises.² Conflicts and disasters affect women in similar and overlapping ways, and both exacerbate women's existing vulnerabilities. Those who face discrimination on multiple fronts, such as Dalit women, are especially affected. This directly impacts women's abilities to recover and rebuild in the aftermath of crises. Despite this, women in Nepal were powerful actors in securing

► LOCAL BUILDING CULTURE (LBC)

Local building practices are particularly diverse and specific throughout the country, hence constituting an invaluable "database" of adapted solutions including practices associated with traditional architectures so as more recently adopted practices.

Climate also strongly influences traditional architecture. Furthermore, Nepal's population is composed of a large number of different ethnic groups as a result of successive migration of Tibeto-Burman people from the northeast and Indo-Aryans from the southwest. Each ethnic group has its

The earthquake affected an area of approximately 30,000 square kilometres across fourteen districts. It killed around 9,000 people and injured another 23,000. The earthquake destroyed around half a million houses and damaged another quarter million houses. Around 7000 schools were either completely or significantly damaged¹.

In the single year of 2020, flood and landslide affected 40 districts across the country especially in Terai and hilly regions due to heavy and continuous rain during the monsoon season.

services for women, rebuilding their communities and leading the reconstruction of the country.²

Social norms for how single women should behave also limited their rights during the post disaster recovery period. After thousands died in the earthquake, mourning requirements for widows were a barrier to relief distribution.¹

Land issues were one of the main reasons why people were unable to access support and rebuild, even 7 years after the earthquakes. Many of those who lacked land documents were elder single women, Dalits, and tenant farmers. These groups were among those most likely to remain in temporary shelters five years after the earthquakes³.

own culture, religious beliefs and traditions, and, in most cases, also their own language. Geographical diversity has resulted in diverse socio-economic and cultural patterns and thus in a variety of different architectural expressions.⁴

Building on this diversity and local intelligence is a way to contribute to improving the housing conditions of people affected by crises, considering needs and beliefs, local economies and networks, demands and aspirations, so as the evolution of climate and risks, but also available capacities and limits.

¹ Bothara et al., 2016

² Mawby et Applebaum, 2018

³ Aid and Recovery in Post-Earthquake Nepal Independent Impacts and Recovery Monitoring Phase Qualitative Field Monitoring: November 2019

⁴ Bodach et al., 2014

Table of content

[1]	Introduction	6
[2]	Country profile	7
[2.1]	General description	7
[2.2]	Key demographic, cultural, social and economic data	8
[2.3]	Natural hazards	11
[2.4]	Environment and climate change impacts	15
[2.5]	Humanitarian crisis and shelter sector response	16
[3]	Description of local housing and settlements	18
[3.1]	Overview of access to land and housing	18
[3.2]	Households' description	20
[3.3]	Access to water, sanitation and other services	20
[3.4]	Local housing & settlements in Terai	22
[3.5]	Local housing & settlements in mid hills	24
[3.6]	Local housing & settlements in the Mid mountains	26
[3.7]	Urban areas & Kathmandu Valley	28
[3.8]	Summary of local affordable solutions: generalities	32
[3.9]	Summary of local affordable solutions	33
[3.10]	Construction materials and techniques	37
[3.11]	Organization of construction	44
[4]	Analysis of local building practices	46
[4.1]	Local building practices: country level	46
[4.2]	Local building practices in Terai and plains	53
[4.3]	Local building practices in Mid-hills	56
[4.4]	Local building practices in Mid mountains	58
[4.5]	Local building practices in Urban areas & Kathmandu valley	61
[4.6]	Improvable building practices and recommendations	62
[5]	Projects based on local building practices	65
[6]	Conclusions: and ways forward	65
[7]	Additional resources and bibliography	69

[1] Introduction

WHY REFLECTING ON LOCAL BUILDING CULTURES⁵?

All over the world, societies have managed to produce, adapt and develop their habitat according to their needs, interests, aspirations, preferences, availability, affordability and abilities, making the best use of locally available materials. The strategies developed take advantage of natural resources to protect against the destructive forces of nature and have always generated rich and varied knowledges at local levels.

(Re)discovering the intelligence of local architectures and analysing their associated practices is often very useful in the process of designing disaster-resistant architectures in line with build-back-safer principles, but also to adapt to contemporary lifestyles and their evolution, respect the local environment and culture and conform to the technical and economic capacities of local populations.

Relying on, or at least getting inspiration from local knowledge, know-how, construction processes, and traditional means of organisation has proven to be very effective, as it favours:

- The implementation of well adapted solutions to local ways of life and the suggestion of viable improvements;
- The possibility to shelter many people quickly and cost-effectively while taking into account seasonal effects as well as factors like religious festivals and livelihood activities;
- Large-scale reproducibility of the improvements designed in continuity with local building cultures and an easy access, both financially and technically, to the promoted solutions for non-beneficiaries.
- A positive impact on local economies as local skills and materials are fully promoted while taking into account environmental concerns linked to the construction industry;
- Extensive short and long-term ownership by the beneficiaries through their participation in decision-making and project implementation processes;
- Empowerment of local populations through the recognition of the value of their existing capacities for building and the improvement of their resilience.

To develop a disaster-resistant architecture adapted to the local lifestyle, it is crucial to involve the beneficiaries, the local professionals and decision-makers from the very beginning of the recovery phase. Also, rebuilding is often necessary and can be very demonstrative and convincing; therefore, promoting appropriate repairs, when possible, may help to achieve this goal. This way, the link between relief, recovery and development is enabled, so the long-term benefit of a shelter project is ensured. In addition to the supply of shelters, the project will have a higher level of resilience.

ARTICULATION WITH THE NEPAL SHELTER CLUSTER STRATEGY

This profile explored localized shelter solutions for transitional shelters and permanent housing, which contribute directly to the Shelter Cluster strategy. It also presents local building practices and materials in shelter construction. It highlights the knowledge of local communities on:

- the properties of the available materials in their local environment;
- what shelter design is most appropriate for the culture and climatic context;
- and how to maintain shelters built in these ways.

The Shelter Cluster strategy emphasizes the importance of using the highest quality and context-specific localized solutions. It also recommended community participation and ownership with a strong focus on shifting away from contractor-driven to owner-driven approaches.

⁵ The concept of Local Building Practices and other key terms related to the topics addressed in this document are defined in Section [Key concepts](#), p.19.

[2] Country profile

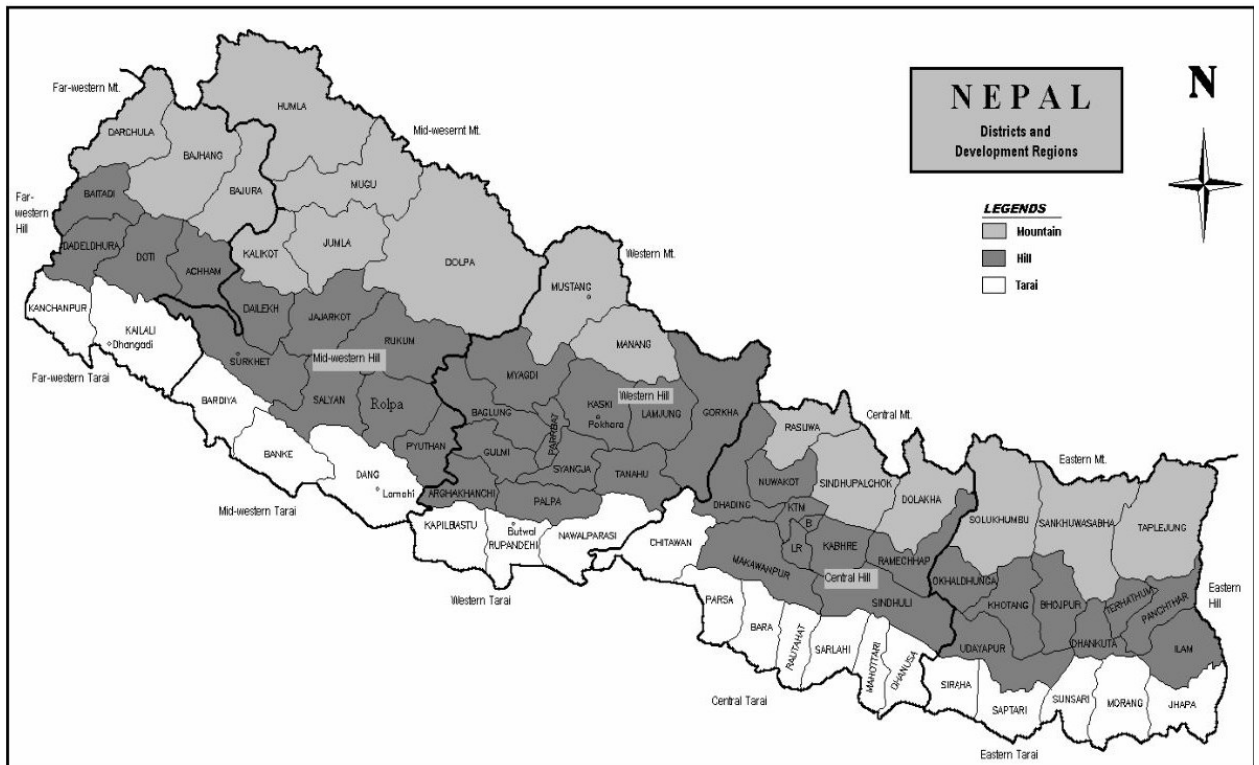

Geographic Regions—source Prof. Dr. K. Central Department of Population studies (CDPS), Tribhuvan University

[2.1] GENERAL DESCRIPTION

► LOCATION, PHYSICAL AND TOPOGRAPHICAL DATA

The Federal Democratic Republic of Nepal is a South Asian nation bordering India and China⁶. « Nepal's territory expands about 800 km east-west and 200 km north-south and displays a highly varying topography. Altitude reaches from 65 m.a.s.l. (meters above sea level) to 8848 m.a.s.l. at Mount Everest, the highest summit of the world. This is leading to a variety of climatic and vegetation zones⁷.

Nepal is divided into five distinct morpho-geotectonic zones from south to north: the Terai Tectonic Zone, the Churia Zone (also called: Siwalik), the Lesser Himalayan Zone, the Higher Himalayan Zone and the Tibetan Tethyan Zone.

In this document we will use a simplified division of the inhabited areas using :

- Terai (60-300m)
- Mid hills (300-2000m)
- Mid mountains (2000-2500m)

► CLIMATE

Nepal can be divided into five climatic regions, namely subtropical, warm temperate, cool temperate, alpine and tundra climate (Table 2). Nepal's climate has two main seasons: winter that lasts roughly from October to March and summer from April to September. Due to the fact that Nepal's climate is strongly influenced by the monsoon, the summer season can be subdivided into a hot and dry period (from April till mid-June) and a warm and rainy period (from mid-June till September)⁸.

Rainfall is ample in the eastern portion of the Terai (which receives from 70 to 75 inches [1,800 to 1,900 millimetres] a year at Biratnagar) and in the mountains, but the western portion of Nepal is drier⁹(With 30 to 35 inches a year at Mahendraganar)

► VEGETATION

Climatic conditions determine the typical vegetation in a region and thus the availability of organic building materials like wood. The Terai Region's geology is mainly characterized by coarse, gravel and finer sediments. Rich fertile alluvial soil is the basis for fertile agricultural land and dense Sal forest. Therefore, traditionally abundant reserves of wood, thatch, and further biogenic material as well as mud and sand are locally available for house construction. In the Hilly Region of

⁶ Mawby et Applebaum, 2018

⁷ Bodach et al., 2014

⁸ Shrestha, 2007

⁹ <https://www.britannica.com/place/Nepal>

Nepal, more stones are available and used as construction material (schist, phyllite, gneiss, granite, limestone and slate). In larger valleys like Kathmandu lacustrine soil deposits are used for brick making. Sand and gravel are available from the riverbeds. Dense vegetation in the form of Sal or hill forests leads to the wide availability of timber. Fertile land and favourable climate conditions allow the production of other vegetation-based building materials like thatch. The Himalayan Mountain Region provides abundant resources of

stones, rocks and mud. Due to the small availability of fertile land and the harsh climatic conditions, timber and other organic materials for building purposes are rather scarce.⁷

► PROTECTED AREAS AND WORLD HERITAGE SITES

Nepal is recognised for its Cultural Sites - Kathmandu Valley & Lumbini, the Birthplace of the Lord Buddha - and Natural Sites - Sagarmatha National Park & Chitwan National Park.¹⁰

[2.2] KEY DEMOGRAPHIC, CULTURAL, SOCIAL AND ECONOMIC DATA

► DEMOGRAPHIC DATA

Population and households: the population of Nepal, as of the census day (22 June 2011), is of 26,494,504, with a population growth rate of 1.35 per year. The number of individual households is 5,423,297 and there are 4,005 institutional households (barracks, hostels, monasteries, etc.).

Population size, growth and distribution: the increment of population during the last decade is recorded as 3,343,081 with an annual average growth rate of 1.35 percent. Terai constitutes 50% of the total population while Hills and Mountains constitute 43% and 7% respectively. Among the five development regions, the Central development region has the highest population (36%) and the Far western region records the lowest (10%).¹¹

► LANGUAGES

The 2001 census records 106 languages and dialects, of which the Indo-Aryan language family constituted 79.1% (48.6% Nepali, 12.3% Maithili, 7.5% Bhojpuri, and 5.9% Tharu), and Tibeto-Burman 18.4% (5.2% Tamang, 3.6% Newari, 3.0% Magar, 2.2% Rai-Kiranti, 1.5% Gurung, and 1.4% Limbu). Many languages or dialects are spoken by a small number of people,

for instance, 58 languages are spoken by less than 10,000 speakers, and 28 by less than 1,000¹².

NB: Learnings from the post-earthquake reconstruction: illiteracy and/or language barriers are major barriers for the training of skilled constructors, so as for information. This impacted households about the grant application, or adoption a BBS practices.

► ETHNIC GROUPS

One of the most common ways of classifying these groups is to cluster them in three major overlapping divisions:

- the hierarchical caste structured groups (Jats) and the egalitarian ethnic groups (Janjatis);
- the high castes or the ritually 'pure' castes and the low, ritually 'impure untouchable' castes (Dalits);
- Pahadis and Madhesis.

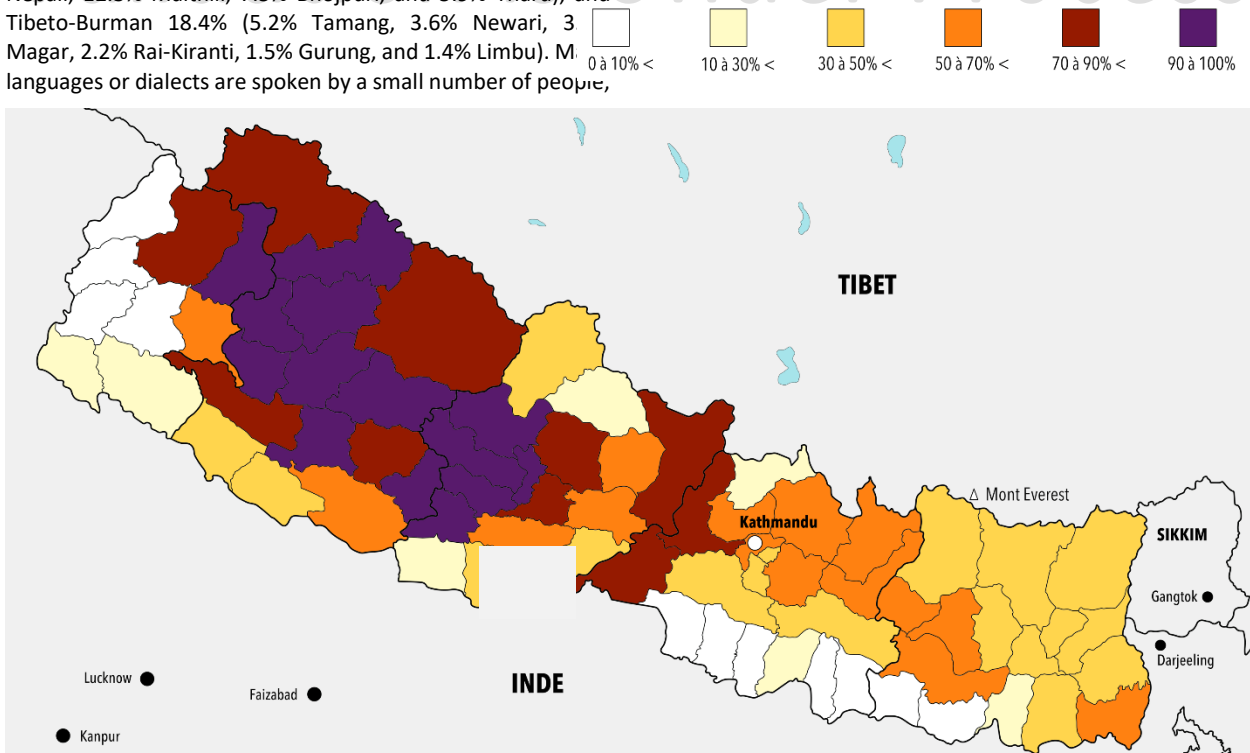

Proportion of Nepali speaking (mother tongue) population by district in 2011 – source CBS

¹⁰ <https://whc.unesco.org/en/list/?search=Nepal&order=country>

¹² Pradhan, Shrestha, 2005

¹¹ Bajracharya, 2011

There are significant cultural differences between castes and ethnic groups as there are between the Pahadis and the Madhesis.

There is a discernible pattern to the geographical spread of the various castes and ethnic groups.

- The hill areas are occupied by the Pahadis, whereas the plains are populated by the Madhesis (70%) as well as the recently migrated Pahadis (30%).
- The Western hills are populated mainly by the Parbatiyas (Brahmins, Chhetris and Dalits), whereas the Janjatis inhabit the central and eastern parts of the country.
- The Janjatis populate the far eastern and the western districts of the Tarai, whereas caste groups are settled in the rest of the plains.
- Many Parbatiyas (Brahmins, Chhetris as well as Dalits) have migrated to the traditional homelands of the Janjatis, 52% of whom live outside their native areas.
- In the country's 75 districts, the Chhetris form the largest single group in 22 districts, the hill Brahmins in nine, the Tamangs in seven, the Tharus, the Magars, and the Rais each in six, the Gurungs in four, and the Limbus and the Newars in three each.
- The Chhetris are concentrated in the far and mid-western districts as well as several central and eastern districts, whereas the Brahmins are concentrated in several western and eastern districts.
- The Gurungs and Magars are dominant in the western districts, while the Tamangs and the Newars are concentrated in the central districts and the Rais and Limbus in the eastern districts.
- In the plains, the Tharus are the major group in several western districts.
- Although the Dalits are found all over Nepal, including in areas settled in by ethnic groups, they are usually found in the periphery of settlements populated by caste groups.

Most districts, therefore, have a mixed population, though either a single caste or an ethnic group may solely populate some pockets. These pockets are easy to identify because, in general, caste and ethnic groups tend to congregate in separate settlements or hamlets. The number and variety of Dalit groups vary from area to area, with fewer number and types found in the high mountains than in the Tarai.¹²

¹³ Smith, K. R., Mehta, S., & Maeusezahl-Feuz, M. (2004).

¹⁴ Bloomfield, E.2015.

► RELIGION

The 2001 census recorded 80.6% of the population as Hindu, 10.7% Buddhist, 4.2% Muslim, 3.6% Kiranti and the rest as belonging to other religions (Christian, Jain, and Sikh). There has been a dramatic increase in the number of people claiming to be Buddhists or Kiranti; for example, in 1991 the percentage of the population claiming to be Kiranti was 1.7%; this increased to 3.6% in 2001¹².

► EDUCATION

Literacy Rate: overall literacy rate (for population aged 5 years and above) has increased from 54.1 percent in 2001 to 65.9 percent in 2011. Male literacy rate is 75.1% compared to female literacy rate of 57.4%. The highest literacy rate is reported in the Kathmandu district (86.3 %) and the lowest in Rautahat (41.7%).¹²

The education of girls and disadvantaged ethnic groups and castes is constrained by a lack of an enabling environment and in-school factors such as inappropriate curriculum, unbalanced gender composition of teachers, poor teacher training and motivation, inadequate physical facilities and teacher's insensitivity to issues of gender and cultural diversity.

► HEALTH

Geographically speaking, mountain households across Nepal depend almost entirely on firewood (95%) and Terai households depend largely on firewood (57%) and dry dung (22%). Close to two-thirds of Nepal's population uses solid fuels such as firewood (64%) – a major contributor to indoor air pollution¹³ – as a primary source of energy. As women play a significant role in the management and use of energy sources for household cooking, they are disproportionately affected by indoor air pollution¹⁴.

The WHO has recognized indoor air pollution as a gender issue since women and children accounted for more than 60% of all premature deaths worldwide from indoor air pollution in 2012. It is the single leading environmental health risk for women in low- and middle-income countries. Indoor air pollution is a major cause of non-communicable diseases like strokes and COPD¹⁵, including pulmonary and cardiac diseases.

In Nepal, around 8,700 people, mainly women and children, die prematurely each year due to illnesses related to indoor air pollution from solid biomass fuel burning.

Indoor air pollution is a threat that can be mitigated on several levels. The Government of Nepal has implemented policies and actions such as the National Indoor Air Quality Standard and Implementation Guidelines 2009, the promotion of non-grid/grid electrification (National Rural Electrification Programme), and the push for cleaner cooking fuels and clean cookstoves (led by the Alternative Energy Promotion Center).

¹⁵ *Chronic obstructive pulmonary disease*

A shift in individual consumer choice on fuel type in rural areas can also help to reduce indoor pollution. Women in the Koshi basin (mostly from rural areas and the Terai) spend more hours in the kitchen and are responsible for managing and extracting household fuel sources, but they have limited autonomy in household decision-making, which extends to fuel choices, and this disproportionately impacts women's health.¹⁶

The Nepalese can face extremes of heat and cold in everyday life, the results of which range from discomfort to illness and death. They also need to consume a great amount of energy. There are many problems to solve. For instance, the prevalence of infectious diseases in summer and the high mortality rate among aged people from cold in winter. In summer, large numbers of mosquitoes and flies invade the houses, and as a result infectious diseases are prevalent in several parts of country. The mortality rate of aged people is high in winter, and the aged hope that if they survive the winter, they can survive another year¹⁷.

▶ FOR MORE INFORMATION

THE GENDERED IMPACTS OF INDOOR AIR POLLUTION IN NEPAL'S KOSHI BASIN
<https://www.icimod.org/article/the-gendered-impacts-of-indoor-air-pollution-in-nepals-koshi-basin/>

▶ ECONOMY

Labour income: the World Bank (2016) reports that the average agricultural income decreased and the average non-agricultural income increased in their respective shares, while the share of labour income, a sum of the two shares, has remained stable. At the national level, the labour income share was approximately 70% of total income in the period 1995-2010. While the share of agricultural income declined from 48% (1995) to 36% in 2010, the non-agricultural income share increased from 23% to 34%. This shift from agricultural income to non-agricultural income mainly came from rural areas, as these shares were almost unchanged in urban areas. There were two distinct evolutions of income component shares in rural areas:

- In the Hills, the labour income share increased primarily because of an increase in non-agricultural income.
- In Terai regions, on the other hand, the labour income share decreased, because of a sharp decline in the agricultural income that more than offset a sizable increase in the non-agricultural income share.

Migration and remittances: Nepal has experienced a significant increase in received remittances from abroad since the 1990s. Until the late 1990s, personal remittances received were under 1% of GDP. The early 2000s saw an increase in this share, to 2% in 2000, 15% in 2005, 22% in 2010 and up to 29% in 2014. Foreign exchange earned from migration exceeds the sum of export receipts and official aid. In Nepal's case there is some social pressure for men to migrate, and thus migration has also become socially embedded. As a share of household

income, remittances went up from 6% to 16% during the same period. The vast majority of migrants are males (82%). People from upper-caste households migrated more than Dalits and Tharus and there is less migration by landless households (36%) than landowning households (56%).¹⁸

▶ GENDER

Gender is linked to the cross-cutting categories of ethnicity, caste, region of origin, level of poverty and religious beliefs. Broadly speaking gender relations in Tibeto-Burman speaking groups are more flexible compared to the Indo-Aryan speaking populations which mirror inequality and subordination. Nonetheless, across all ethnic groups and castes, the patrimonial nature of the social system, inheritance rules, and the traditional gender-based division of labour severely restrict women's access to education, skill development, employment opportunities outside the home and decision-making processes. The situation of women belonging to disadvantaged ethnic groups and castes is even worse, as their social indicators fall far below the country average for women in general. For example, the literacy rate of Dalit women is only 12.0%. Hill Dalit women have three times the literacy rate (14.7%) as compared to Terai Dalit women (4.0%). According to another study, the adult female literacy rates of upper caste Hindus (Tagadhari), ethnic groups (Matwalis), and Dalits were 45.4%, 41.7%, and 23.6% respectively.

Gender inequality is greater in rural areas as evidenced by a low gender development index (GDI) of 0.430 compared to urban areas (0.562). As for HDI, the GDI is highest in the central (0.476), followed by the eastern (0.465), western (0.463), midwestern (0.376), and far western (0.356) development regions respectively. A low gender empowerment index (0.191) highlights the invisibility of women in the economic, political and professional spheres, and women from the mountains and Terai, especially those of the western and midwestern regions, are less empowered than those in other regions. Reservation for women in local bodies has increased the women's profile, but the experience demonstrates that it is insufficient on its own to ensure the effective participation of women or to bring deep-rooted changes in society.¹⁹

Gender-based discrimination codified in Nepal's constitution and legislation has obstructed women from accessing state aid after the conflict and the earthquake. The longstanding and inequitable standard for men's and women's citizenship restricts possession of the citizenship cards necessary to access state-based aid. In emergency contexts, the lack of proper documentation for women and their children limits their ability to get state aid and hampers overall recovery.

The consequences of gender-based discrimination have been terrible for earthquake survivors as well. Government relief and registration of land for rebuilding purposes was restricted to those with proper documentation—which means, in most cases, men. This policy was amended in 2017 by the National Reconstruction Authority (NRA) to allow landless people to more easily access aid. At the time of the earthquake, however, women were unlikely to have land titles and, if their

¹⁶ ICIMOD, 2021

¹⁷ Rijal et al., 2010

¹⁸ Avis, 2018

¹⁹ Pradhan et Shrestha, 2005

husbands were gone, they often did not have citizenship cards for other forms of relief.

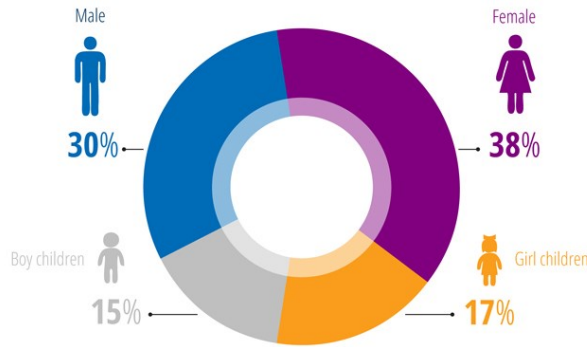

Gender segregated data of deaths due to the 2015 Gorkha's EQ – ©Nepal police

Many Nepali men work outside of the country, so much of the reconstruction work was left to women. This has been a common experience for many Nepali women; men being engaged in the civil war or killed in the conflict; women had to take on additional responsibilities. The same has been true in the years following the conflict and the earthquake due to a high level of emigration by men to find work.²⁰

[2.3] NATURAL HAZARDS

► HAZARDS

Though the earthquake risk is the most documented and has been the focus following the 2015 Gorkha's earthquake, Nepal

► INFORMATION AND COMMUNICATION

Communities are most likely to get and trust information from interpersonal communications. In 2016, BBC Media Action conducted a nationally representative study in 25 districts, with a total of 4,000 respondents. Respondents were asked about their sources of information on current affairs and political issues, as well as about which of these sources they most trusted. Results demonstrate that radio, television, and family/friends/neighbours are not only major sources of information, but are also considered as trusted sources. Social workers, posters and NGOs/INGOs are only a small portion of people's sources of information and do not even feature in the trusted sources category.

There are major differences between genders in terms of who people get information from and their preferences and limitations in accessing information, e.g. women often can't attend orientation sessions during the day due to housework, women generally have a lower level of literacy than men so written materials are less useful, etc.²¹

is prone to many different hazards, and most people are living in areas prone to multi-hazards.

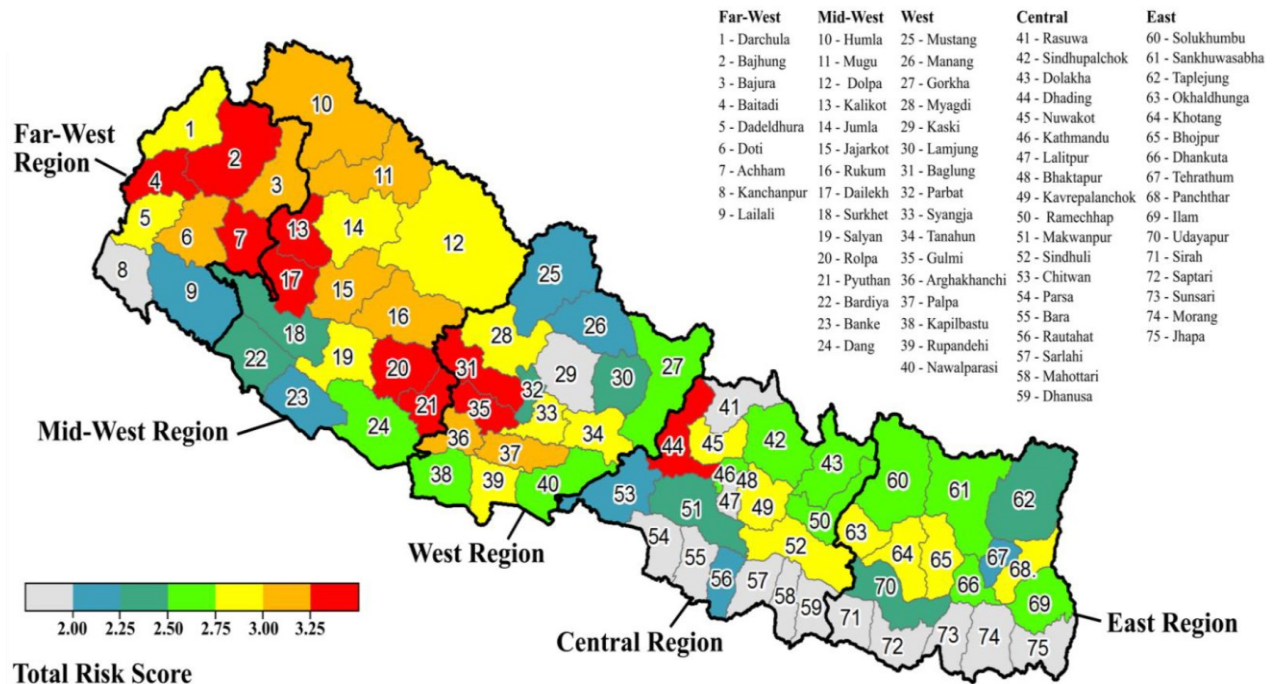

Total Risk score based on model impact modelling by Durham University – HCT Earthquake Contingency Plan, 2016

²⁰ Mawby et Applebaum, 2018

²¹ HRRP, 2017

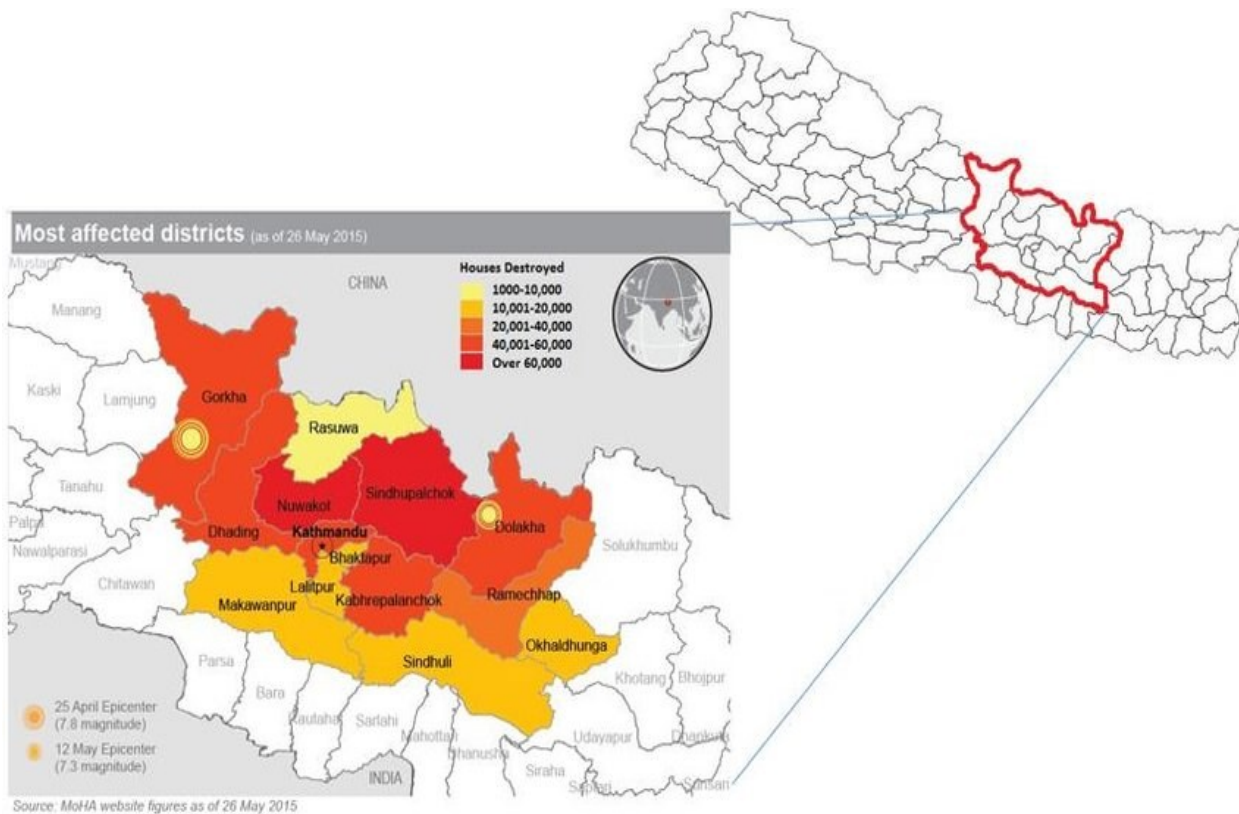

Most affected districts after the 2015 Gorkha earthquake—©HRRP

Earthquakes

Nepal lies along the Himalayan Mountain range that has been formed by the collision of the Indian Subcontinent with Eurasian/Tibetan plates. The high rate of convergence i.e., 40-50 mm/year (USGS, 2015) has ranked Nepal as the 11th most earthquake prone country in the world (UNDP, 2009). Nepal has several evidences of historical earthquake, among which a first one was recorded in 1255 A.D. of around Mw 7.7 and many more recent earthquakes are recorded.²²

On April 25th 2015, a major earthquake stroke Nepal with its epicentre localised in the small town of Gorkha in central Nepal. Almost 9000 people died, over 22,000 were injured, 1 million were homes either destroyed or damaged (Government of Nepal, Ministry of Home Affairs and Disaster Preparedness Network Nepal 2015), resulting in a further 2.8 million people homeless across 14 districts of Nepal. The earthquake, with a magnitude of 7.8 (USGS 2015) and the subsequent magnitude 7.3 aftershock in Sindhupalchwok district on May 12th, was the largest earthquake and worst

natural hazard that stroke the country in 81 years. Not since the devastating 1934 Nepal-Bihar earthquake, estimated to have had a magnitude of 8+, Nepal had suffered such a devastating event. Yet this was not the big one that many scientists, humanitarians, politicians and members of the public had feared and discussed in the years before 2015. This was not the feared mega-quake that would unzip several hundreds of kilometres of the main Himalayan Fault and strike the direct hit on Kathmandu²³.

The findings of the Department of Geography at Durham University²⁴ had claimed that the most vulnerable districts are in rural western Nepal where nearly 9.5 million Nepalis are living at a higher seismic risk than Kathmandu. The Shelter Cluster Nepal Contingency Plan for the coordination of shelter preparedness and response in Nepal has found that this disaster might result in 10,000 deaths, 25,000 injuries and the destruction of 800,000 dwellings²⁵.

²² Khadka et Jiang, 2019

²³ Bracken, 2018

²⁴ Robinson et al., 2018

²⁵ Habitat for Humanity Nepal, 2021

Floods

Flood is the most common natural disaster affecting Nepal. The principal and most destructive type of flooding is from rivers (fluvial) located within the Terai region. On average, floods and landslides are the causes of over 175 deaths each year, with average annual economic losses exceeding USD 140 million. Frequency and intensity of extreme flood events is said to be increasing with the impact of climate change.

Apart from fluvial floodings during the monsoon, other flood risks include flash floodings from heavy rainfall in mountainous areas, Glacial Lake Outburst Flooding (GLOF), landslide induced flooding and infrastructural flooding (such as embankment failure).

The monsoon rains account for 78% of the annual total rainfall and can cause widespread large floods once the river capacity is overwhelmed. These floods always coincide during the monsoon season from June to September²⁶.

Flash floodings. flash floodings in mountainous areas and the mid-hills can occur with intense rainfall falls in a short period of time leading to high surface water runoff into existing rivers and channels. These events can happen in any of the Himalayan or middle hills regions. Nepal, as with the rest of the Himalayan region, is particularly vulnerable to flash floodings as the steep sided catchments and intense monsoon rainfall can easily generate extreme surface water runoff into existing river channels. It should be noted at times flooding in the Terai is described as being from “flash flooding”. However, this is usually when the existing Terai rivers are already full and then there is intense rainfall leading to bank overtopping. In 1993 in Central Nepal, 540mm rainfall was recorded within a 24-hour period leading to immense floodings and approximately 1,336 people dying. Around 60,000ha of agricultural land was inundated and 67 irrigation schemes washed away.

Glacial Lake Outburst Flooding (GLOF). lakes that form from meltwater at the front of the glacier can sometimes fail leading to a rapid, sudden release of water down an existing meltwater river.

Landslide induced flooding: similar to GLOF, landslides (usually triggered by earthquakes or the loosening of soil through precipitation and/or weathering) can create a dam across a river leading to a lake building behind it. Although these events can create permanent features, they are prone to collapse with similar effects to GLOF.

Infrastructural flooding: embankment breach or bridge/culvert blockages can cause flooding. Increasing urbanization is increasing impervious area and leading to the overwhelming of the sewer network.

Although flooding in Nepal is often considered as a rural issue, urban flooding in Kathmandu and smaller towns has been increasing in recent years. The impervious area in Kathmandu has increased from 9.5km² in 1980 to 37.4km² in 2010, however this huge rate of urbanization has not been matched by similar levels of investments in drainage infrastructure. Accordingly, heavy rainfall in Kathmandu often overwhelms sewer capacity and causes flooding. The story is similar in other towns across Nepal

In some urban areas, natural drains called Kholas are at risk of building encroachment and lack of solid waste management can lead to garbage dumping and associated loss of conveyance and storage of runoff. Additionally, due to pressure on existing land for development, areas that previously acted as a natural floodplain storage are being encroached upon in urban areas.

FOR MORE INFORMATION

For significant flood events see: « Past significant flood events »

<https://www.adb.org/sites/default/files/project-documents/52014/52014-001-dpta-en.pdf>

A sub-group of the Shelter Cluster Nepal, Flood Resilient Housing Solutions Working Group, is promoting research and collaboration for a better consideration of the different flood risks.

https://drive.google.com/drive/folders/1Ufv7VXOxqpfEyEz_zt1wDI4WSe6kCfsj?usp=sharing

²⁶ Landell Mills Limited, 2019



Nationwide flood risk map – ©UNRECO country office, Nepal

Landslides

Topographic elevation changes from 60 m at the southern plains to 8,848 m at the Mt. Everest in the north within a horizontal distance of less than 200 km (Fig. 1). This kind of topography is prone to landslide and erosion in Nepal. The mountainous and hilly regions of the country occupy nearly 83% of the total area, whereas the remaining 17% is flat land. The seasonal monsoon rains and intense but improper land use practices make the Nepalese Himalayas the most unstable landscape in the world.²⁷

Fires

An unprecedented wildfire season spread from forests into human settlements in March and April 2021, destroying 55

homes in the Koshi and Lumbini provinces and leading to 250 movements.

The fires also intensified the impact of the monsoon by destroying vegetation in many flood-prone areas. The reduction in the ground’s ability to absorb rainfall increased the risk of floods and landslides.

Forest fire management is a major challenge for forest user committees at the local, municipal, district and national levels. The combined uses of the forest for timber, firewood and cattle breeding, is a major challenge in fire management and wildlife protection

²⁷ Hasegawa et al., 2008

[2.4] ENVIRONMENT AND CLIMATE CHANGE IMPACTS

Most of the Nepalese Government of Nepal studies show that with an analysis of historical data the maximum annual air temperature is rising between 0.04-0.06°C per year, although minimum air temperature is only rising negligibly. However, these trends are complex with warming larger at higher altitudes compared to the Terai, and in the Himalayas increasing temperature being greater in the winter, with increasing temperatures being the greater in the summer in the Terai. Nationwide, perhaps due to the complexity and variability of the precipitation patterns changes in precipitation are harder to discern. The latest Government report / scientific literature points out the following trends:

1. Increases in air temperature may result in:
 - More glacier melting leading subsequently to GLOF; and,
 - Increased snowmelt with increased summer floods along the rivers (in the hilly region).
2. Increases in monsoon rainfall are likely to increase the flood risk to the Terai region in particular.
3. Decrease in winter rainfall. Flooding due to winter rainfall is extremely rare, and therefore a projected decrease in winter rainfall is not expected to have any flood risk impact.
4. Increase in extreme precipitation events. Any increase in extreme precipitation events is likely to make flash flooding more frequent; increase soil erosion is potentially leading to more landslide induced flooding; and increasing the frequency of events where urban flooding occurs due to infrastructure being overwhelmed compared to its design.²⁸

There are gendered differences in the severity of climate change impacts and the ability to adapt. Women and girls are more vulnerable to climate change and its impacts, and their

adaptive capacities are limited. Climate change is further widening the gender gap and worsening existing social inequalities due to women's inadequate access to and control over productive resources, and their limited mobility and voice in decision making.²⁹

The topography of the Kathmandu Valley and the high levels of pollution have triggered climatic variation. The bowl-like shape of the Valley restricts wind movement and retains pollutants in the atmosphere. Conditions are especially bad during the winter when thermal inversion—when cold air flowing down from the mountains is trapped under a layer of warmer air—creates a sort of lid, sealing pollutants within. Growing climate variability is likely to exacerbate the existing pressures on urban services, especially the growing demand for energy to heat and cool, as temperatures increase and precipitation and water availability grow increasingly variable. Global circulation model (GCM) outputs suggest that extremely hot days (the hottest 5% of days in the period 1970-1999) may increase by up to 55% by the 2060s and 70% by the 2090s (NCVST 2009). The findings also suggest that extremely hot nights (the hottest 5% of nights in the period 1970-1999) may increase by up to 77% by the 2060s and 93% by the 2090s. Because the ability of conventionally constructed buildings to retain heat is poor, especially when temperatures are extreme, they are costly to heat and cool. Due to energy shortages, most people in Kathmandu currently suffer from extreme temperatures. Further economic development and increasing temperature extremes, resulting in an expected increase in demand for heating and cooling, unless building insulation is dramatically improved³⁰.

²⁸ Landell Mills Limited, 2019

²⁹ Chanda Gurung Goodrich, Abid Hussain, Binaya Pasakhala, Kosar Bano, Sanjeev Bhuchar, et Vishwas Sudhir Chitale, Suman Bisht, Aditya Bastola, and Simran Silpakar, 2022

³⁰ Shrestha, 2012

[2.5] HUMANITARIAN CRISIS AND SHELTER SECTOR RESPONSE

► IDPS, REFUGEES, RETURNEES

The armed conflict in Nepal officially ended in 2006, and all IDPs who fled the fighting were confirmed as having achieved durable solutions.³¹

Monsoon rains cause floods and landslides that displace people across Nepal every year.

Disasters triggered 32,000 displacements in 2021. Most occurred during the June to September monsoon season, but other hazards also forced people from their homes during the year. It is estimated that at least 8,400 people remain displaced as per 31 December 2021 due to monsoon impacts. While most disasters in Nepal are small in scale and the upheaval they trigger is temporary, the Gorkha earthquake led to protracted displacement. A reconstruction programme for affected families concluded in November 2021 after the

construction of 50,000 homes in the Gorkha and Nuwakot provinces. This was a significant step in securing durable solutions, but more homes are still in need of rebuilding.

In 2019, the Ministry of Home Affairs and the UNHCR listed 6396 Bhutanese refugees 3421 men/boys and 2975 women /girls).

Unbalanced access to safe housing has been highlighted by the 2015's earthquakes countdown of victims:

55% of victims (death) were women and girls.

1/3 were Tamang people. Tamang people who traditionally live in the 15 worst-affected districts were disproportionately hit. Probably due to the hazardous location of their houses, and/or to the quality of construction.

► HUMANITARIAN RESPONSE

Following the 2015 Gorkha Earthquake, the National Reconstruction Plan (NRP), with the support of humanitarian actors, has globally reached its objectives (Chandra, 2021), supporting a major part of the affected population to access to a newly built house. Nepal's post-earthquake housing reconstruction is world's largest owner driven reconstruction program under which nearly 700,000 houses have been (re-) constructed.³²

The reconstruction is a key moment in the evolution of local building practices. Its impact at longer term is still to be analysed but a major switch in the adopted housing solutions is observed (at least in the affected districts).

Due to misconceptions about what types of houses people could build with the NRA grant, most thought they had to build

a one- or two-room house resembling early NRA model houses. Those who wanted to build bigger, often built either outside the grant or a smaller NRA-approved house, but then expanded it without necessarily following the building guidelines for earthquake-resistant houses.

The continued use of old houses is also due to the fact that the new RCC houses are not always considered adapted to rural life. For example, a lack of insulation and hygrometric regulation through the concrete walls and the absence of an attic meant grain cannot be stored in a secure manner in these houses³³.

Every year the floods affect the housing situation and the livelihood of the inhabitants of Nepal, and even more severely the inhabitants of the Terai plains.

³¹ Internal Displacement Monitoring Center/DMC, 2021

³² Rawal et al., 2021

³³ Aid and Recovery in Post-Earthquake Nepal Independent Impacts and Recovery Monitoring Phase Qualitative Field Monitoring, 2019

TYPOLOGIES OF SHELTERS DEVELOPED BY THE SECTOR

After the 2015 earthquake, a series of validated building designs has been widely disseminated³⁴ and copied by house owners applying for reconstruction grants.

These designs are described in the catalogues for reconstruction of earthquake resistant houses and in a series of manuals published by the DUDBC and the NRA.

The design of existing housing mainly takes into account seismic risks, while a significant population is also exposed to other major risks such as flooding or multiple hazards.



➤ FOR MORE INFORMATION

DUDBC. (2015). Design catalogue for reconstruction of earthquake resistant houses. Nepal Housing Reconstruction Programme. Department of Urban Development and Building Construction (Ed.), (Vol. I).

<http://www.dudbc.gov.np/uploads/default/files/0ef9f3598df115407ae9ed4e7bfab24a.pdf>

DUDBC (2017). Design Catalogue for Earthquake Resistant. Houses. Catalogue for Alternative Construction Materials and Technologies. Department of Urban Development and Building Construction, Ministry of Urban Development and Building Construction (Ed), (Vol II).

[Http://www.dudbc.gov.np/uploads/default/files/a1efdb9058f9151775d9a2bae473ac0b.pdf](http://www.dudbc.gov.np/uploads/default/files/a1efdb9058f9151775d9a2bae473ac0b.pdf)

NRA. Correction/Exception Manual for Masonry Structure. National Reconstruction Authority, Government of Nepal, 2017.

https://www.preventionweb.net/files/63755_deqtcvtlicwafnbpqyj20180809.pdf

³⁴By the DUDBC, Department of Urban Development and Building Construction

[3] Description of local housing and settlements

[3.1] OVERVIEW OF ACCESS TO LAND AND HOUSING

► INTRODUCTION

Land registration is compulsory in Nepal, giving rise to the relevant land rights, and the land register must be updated upon transfer of land. But in practice, a considerable amount of land in Nepal remains unregistered, and it can be difficult to precisely discern boundaries between different parcels of land because of weaknesses in cadastral mapping.

Common types of tenure.

Ownership: Private land can be owned by Nepalese citizens. A substantial amount of privately owned land is leased to tenants under tenancy arrangements with varying degrees of formality and security.

State land: it is comprised of public land (land used by the general public) and government land (land used by the Government of Nepal).

Guthi land: Guthi land is the land belonging to religious bodies in Nepal. It includes temples, monasteries, religious schools and hospitals. Only a very small amount of land in Nepal is Guthi land.

Security of tenure of vulnerable groups. Members of minority groups who do not have Nepalese citizenship are unable to acquire formal property interests. Informal tenancy arrangements available to minority groups lack the security of formal registered land ownership. Informal settlements exist on riversides, roadsides and in open public spaces in Nepal's cities. Those living in informal settlements generally do not have land title documentation, and so do not have secure tenure. Two informal settlement federations have been recognised in Nepal: Nepal Basobas Basti Samrakchan Smaj and Nepal Mahila Ekta Smaj. The Constitution provides all citizens with a right to housing, and identifies the need to rehabilitate landless people and squatters by offering housing, housing lots, and cultivable land. Nepal law also recognises the possibility of land ownership based on adverse (or 'long past') possession. In practice, these laws and policies are not enforced, and land rights for landless people and squatters are not recognised.

Eviction, expropriation and relocation. The Constitution provides that *no citizen shall be evicted from their residence*. In practice though, people with informal tenure are not protected from eviction. The Government is constitutionally authorised to acquire land if it is in the public interest. Expropriation of this kind must follow a prescribed procedure, which can take several weeks to complete. The procedure allows the existing landowner(s) to make a complaint in relation to the proposed expropriation. The Government's right to expropriate land is subject to the requirement to compensate the landowner(s). There are no generally

applicable laws in relation to relocation but the Government has introduced legislation dealing with relocation requirements in the context of specific disasters. The regime governing compensation for landowners following expropriation also includes compensation for relocation costs.³⁵

About 25% of Nepal's population is landless or near landless. Landlessness amongst the Dalits and Janjatis is much higher compared to the other castes of social hierarchy. Nearly 50% of the Dalits in Nepal do not have land ownership certificates³⁶. Since the end of the conflict, women who register their names on land have lighter taxes compared to men³⁷.

Ownership of housing units: Altogether, 85.26 percent of the households reside in their own house whereas 12.81 percent in rented, 0.63 percent in institutional and 1.30 percent in other arrangements. In urban areas, 40.22 percent live in rented house. Kathmandu district has the highest percentage (58.65) of households living in rented house.³⁸ According to the Central Bureau of Statistics, 78.4% of houses are owned by men and 21.6% by women across the 14 districts most affected by the April 2015 earthquake. 26% of houses in Makwanpur are owned by women, the highest amongst the 14 districts, and just 16.9% of houses are owned by women in Rasuwa, the lowest amongst the 14 districts³⁹.

► FOR MORE INFORMATION

HOUSING, LAND AND PROPERTY MAPPING PROJECT. NEPAL
link <https://sheltercluster.org/hlp>

► GENERALITIES

Until recently, the construction of a house in Nepal was entirely under the responsibility of the individual or family. In such an owner-built informal housing development system, individuals first acquire a plot of land through their own finances and then build a house themselves (Adhikari, 1998). All of the infrastructure required for the land and house will be managed incrementally through cooperation with the neighbours. The dwelling units are built and expanded incrementally over a period of time as both the family size and income increase. More than 90% of the houses are built in this informal way.⁴⁰

The owner driven reconstruction process has highlighted the followings issues for a housing access.

There are no support mechanisms within the urban areas to deal with the large numbers of renters who were affected by the earthquakes. This large, and potentially highly vulnerable,

³⁵ Marshall, 2019

³⁶ Rawal et al., 2021

³⁷ Mawby et Applebaum, 2018

³⁸ Bajracharya, 2011

³⁹ HRRP, 2018

⁴⁰ Shrestha, 2010

category of stakeholders has been left to fend for themselves and has not been eligible for any aid for rebuilding. They have not received any support for relocating. Given the usually high numbers of renters in urban areas, a formal policy for supporting non-owners should have been developed. While this has been recognised by international actors, they are

► GENDER AND ACCESS TO LAND AND HOUSING

Female ownership of fixed assets: altogether, 19.71 percent of households reported the ownership of land or house or both in the name of a female member of the household. In urban areas, 26.77% of the households show female-ownership of fixed assets while the percentage stands at 18.02 in rural

► FINANCIAL CHALLENGES IN ACCESS TO HOUSING

According to the IRM-5⁴⁴ survey, people have spent an average of NPR 1,196,887 (USD 10,000) on their new houses. Costs differ by size of the house. A one-room house costs an average of NPR 450,013 (USD 3,700), a two-room house an average of 688,209 (USD 5,700), and a house with three rooms or more costs more than 951,514 (USD 7,900) on average⁴². Though the interest rate of informal money lenders is much higher than Microfinance institutions (MFIs), people still prefer (40% of the HHs and construction workers and 30% of the retailers) informal sources because of no-hassle financing and repayment flexibility that is not accessible in the legal sector. Many MFIs⁴⁵ do not provide housing finance, and the interest rates are very high. The impoverished population lacks access to finance and lending conditions make housing finance inaccessible to lower-income households without sufficient collateral. More than three-fifths of respondents are saving. Saving was used to cover the respondents fundamental

constrained by GoN policies and traditional practices with regard to formal land ownership.⁴¹ In urban areas, reconstruction costs are higher than in rural areas, despite better accessibility. This is due to the type of houses built, higher costs of building in heritage areas and high demolition costs.⁴²

areas.⁴³ Women and men have equal legal rights to access and own land. However, far fewer eligible women than men in Nepal have a citizenship certificate, which means women have a limited practical ability to formalise any property interests they might have.

requirements during the crisis (COVID-19) and has led to almost nil savings. This indicates that they do not have significant savings, and it is one of the primary housing/shelter markets' potential vulnerabilities in the case of a crisis.⁴⁶

Earthquake recovery is a financial burden for many households. Borrowing has increased noticeably since June 2015. At the time 14 percent said they had borrowed in the past year, while in October 2019 it was 39 percent. Hill Dalits (53%) are more likely than average, and at least ten percentage points more likely than any other group, to have borrowed in the past year. The average borrowed amount has tripled since June 2014 to NPR 391,864 in 2019. Monthly interest rates range between 1.2 and 3.8 percent. People mostly borrow from cooperatives (25%), savings groups (19%) and relatives and neighbours (18% each). Fewer borrow from banks, money lenders or other sources⁴⁷.

⁴¹ Daly et al., 2017

⁴² Aid and Recovery in Post-Earthquake Nepal Independent Impacts and Recovery Monitoring Phase Qualitative Field Monitoring, 2019

⁴³ Bajracharya, 2011

⁴⁴ Independent Impacts and Recovery Monitoring (IRM), round 5 (September -October 2019)

⁴⁵ Local microfinance institutions

⁴⁶ Habitat for Humanity Nepal, 2021

⁴⁷ Independent Impacts and Recovery Monitoring (IRM) Project Nepal - Early Findings from Round 5

[3.2] HOUSEHOLDS' DESCRIPTION

► COMPOSITION OF HOUSEHOLDS

The average household size has decreased from 5.44 in 2001 to 4.88 in 2011 at the national level. The household size is recorded highest (6.44) in Rautahat district and lowest (3.92) in Kaski.⁴³

The definition of a household in the censuses is a unit reflecting the arrangements made by persons, individually or in groups, related or not, for living in the same dwelling and sharing meals, housekeeping, budget and other essentials. So

► TYPES OF RESIDENTIAL UNITS

In rural contexts, the house is [generally] the home of the nuclear family in a patriarchy system. In the case of the house of a man whose sons have established separate houses for their own household groups, the father's house is called '*mul ghar*' indicating that it is both the principal house of the core agnatic descent group (*santān*) and the kinship root from which the sons' and their houses have branched -just as secondary roads or paths can branch from a main road. It is also the origin of and source from which the sons and their houses originated and to which they return for major rituals.⁴⁹

In urban contexts, the share of renter is much higher than in the rural context. Only 62.5% of the households in the Kathmandu Valley live in their own homes and about 33.1% of the homes are available for rental purposes. In the case of

members of a household are not necessarily related by blood or marriage. The common denominator is rather the fact that they share the same kitchen. It is important to note that it actually very common in the Nepalese context that several households live in the same house. This means that most houses contain several "dwelling units". In the context of Nepal, dwelling units are referred to as households.⁴⁸

Kathmandu alone, about 30 to 35% of the population is living in rental housing and 40% of these are relatively poor with lower levels of services compared to people living in owner-occupied housing.⁵⁰ A study⁵¹ of 24 cases of housing in Kathmandu revealed that up to 95% of the families live in homes with an average of 4.8 rooms and 120 square feet of space. Another study showed a case in which five daily-wage workers shared one rented room no larger than 10 feet by 11 feet for NPR 500 per month (\$1 = NPR 74.50 at present)⁵². Another study presented that in Kathmandu the number of households increases by 7,500 every year (Informal Sector Research and Study Centre, 2004)⁵³.

[3.3] ACCESS TO WATER, SANITATION AND OTHER SERVICES

► WATER

Source of drinking water.

- Tap/piped water is the main source of drinking water for 47.78 percent of the total households;
- Tube well/hand pump is the main source of drinking water for about 35 percent of the total households;
- Spout, uncovered well/*kuwa* and covered well/*kuwa* are the main source for 5.74 percent, 4.71 percent and 2.45 percent respectively.⁵⁴

Challenges to water security. Despite its large water potential, Nepal has very low water security, many people do not have a sufficient access to water for their domestic, agricultural and industrial needs.⁵⁵

The majority of the population in Nepal (76%) has access to basic drinking water (from an improved source which is

located on premises, available when needed and free of faecal and priority contamination) while only 19% use safely managed services⁵⁶.

Urbanization creates new water demands and takes water away from agriculture and rural domestic needs to meet urban, residential, industrial and recreational needs⁵⁷. Urban water insecurity is a major emerging issue and is further complicated by issues of water pollution and solid waste management. The main impediment to urban water security is haphazard urban growth, which leads to the degradation of natural areas that are used to recharge the groundwater. Most of the rural population in the middle hills depends on springs for water for drinking and livelihood-related activities. In recent years, many of these springs have slowed or dried up.⁵⁵

⁴⁸ ALNAP, 2010

⁴⁹ Gray, 2009

⁵⁰ Rabenau, 1990

⁵¹ Lumanti Support Group for Shelter and Nepal Water for Health, 2000

⁵² Prarthana, 2004

⁵³ Shrestha, 2010

⁵⁴ Bajracharya, 2011

⁵⁵ Nepal et al., 2021

⁵⁶ Central bureau of statistics, 2022

⁵⁷ Narain, Khan, Sada, Singh, & Prakash, 2013

Water sources changed after the 2015 earthquakes, often due to landslides and geological changes, which meant that many areas reported dried up springs and a lack of water⁵⁸.

► SANITATION

- 18 % of the households have access to basic sanitation (use of improved facilities that are not shared with the neighbours);
 - 61% of the households are using safely managed sanitation (use of improved facilities which are not shared with other households and where excreta are safely disposed in situ or transported and treated off-site);
 - 15% of the households use improved facilities which are shared by 2 or more households;
 - 5% have no access to sanitation facilities (open defecation). Improved sanitation facilities are those designed to hygienically separate excreta from human contact;
- 81 % of the households have access to basic hygiene services (availability of a handwashing facility on the premises with soap and water);
 - 18 % (28% in rural areas) only have access to limited services (lacking water and/or soap).

E. coli contamination of drinking water at sources and at the household level is high. In the poorest households, 96% of household water is contaminated (65% amongst the richest ones).⁵⁶

► SOURCE OF ENERGY FOR LIGHTING AND COOKING

Nepal's general household energy source profile across geographies is quite similar, with massive dependency on wood/firewood, followed by LPG (liquefied petroleum gas) and dry dung.

Urban areas buck this trend, with large dependence on LPG (68%), followed by wood/firewood (26%).

Geographically speaking, mountain households across Nepal depend almost entirely on firewood (95%) and Terai households depend largely on firewood (57%) and dry dung (22%).⁵⁹

In general, households in the Koshi basin rely heavily on wood/firewood (71%), followed by LPG (14%) and dry dung (12%). Within the Koshi basin, almost all rural mountain/hill districts⁶⁰ depend heavily on wood/firewood, while districts in urban centres such as Kathmandu, Lalitpur and Bhaktapur depend on LPG. Districts in rural areas and the Terai in general also depend on dry dung after wood/firewood⁶¹.



Kitchen with open fire, Tharu village, Terai – © Marie Schuiten

⁵⁸ Aid and Recovery in Post-Earthquake Nepal Independent Impacts and Recovery Monitoring Phase Qualitative Field Monitoring, 2019

⁵⁹ Paudel, D., Jeuland, M., & Lohani, S. P. (2021)

⁶⁰ Khotang, Bhojpur, Okhaldunga, Solukhumbu, Taplejung, Ramechhap, Dolakha, Terathum, Sindhupalchowk, Panchthar, Udayapur, Sindhuli, Dhankuta and Kavrepalanchok

⁶¹ <https://www.icimod.org/article/the-gendered-impacts-of-indoor-air-pollution-in-nepals-koshi-basin>

22 DESCRIPTION OF LOCAL HOUSING AND SETTLEMENTS

[3.4] LOCAL HOUSING & SETTLEMENTS IN TERAI

► RURAL SETTLEMENTS

Until the beginning of this century, the main part of the plain areas of Nepal (the Terai region) was under forest (Ghimire 1992). The region was sparsely populated by ethnic groups stemming from India, such as the Tharus and Maithalis which had acquired some resistance against the infectious malaria raging the region. During the Rana period, from the middle of the 19th century to 1951 (Rose and Scholz 1980), there had been several attempts to attract farmers from the Hill region in order to settle in the Terai region of Nepal. However, migration into the area was very limited, not least, due to the unstable health situation.

The process of considerable settlement in the Terai region started in the wake of democracy after the termination of Rana ruling in 1951, due to the systematic and planned efforts to settle Hill farmers in Terai. ⁶²

Deforestation in the Terai has been caused mainly by the clearing of the forest land for agricultural purposes.

Settlement patterns are strongly related to agricultural activities and water access or risks (floods), and local practices are probably strongly oriented by the cultural and technical background of different populations settled in the region (from Nepal hills or India)



Tharu village near Sauraha, Terai 2016–
©Marie Schuiten



Mithali village, Terai, 2016 – ©Marie Schuiten



Tharu village near Sauraha, Terai 2016–
©Marie Schuiten



Maithali village, around Janakpur, Terai 2016 ©Marie Schuiten

⁶² Jytte Agergaard, 1999

► TYPES OF HOUSING

Isolated family or extended family houses, including shed for cattle (sometimes directly adjacent to the housing part).

The courtyard is used for the agricultural uses, being drying of crops, cattle shed, etc. An outer cooking space is often built in the courtyard, in addition to an inner cooking space.



Timber house on stilts, Tharu village near Sauraha, Terai 2016 ©Marie Schuiten



Brick masonry house, Tharu village near Sauraha, Terai 2016 ©Marie Schuiten



Wattle & daub house, Tharu village near Sauraha, Terai 2016 ©Marie Schuiten

Validation is Under



Wattle & daub house, courtyard space, Mithali village, Terai 2016 ©Marie Schuiten

24 DESCRIPTION OF LOCAL HOUSING AND SETTLEMENTS

[3.5] LOCAL HOUSING & SETTLEMENTS IN MID HILLS

► RURAL SETTLEMENTS

In central Nepal, the houses are dispersed. What is often referred to as a village [...] consists of a series of hamlets loosely dispersed in the midst of terraces used for dry cultivation. Each hamlet has been founded by a lineage of land clearers who live alone or have brought with them other affine lineages or unrelated buyers.⁶³



Rural settlement, Bagmati, 2013 –
©Mathilde Chamodot



Road from Dhulikel to Panauti, 2013 –
©Mathilde Chamodot



Rural settlement, road from Mantali to Deurali, Ramechhap, 2015 – ©CRAterre

⁶³ Gaborieau, 1991

► TYPES OF HOUSING

In the mid-hills, housing is organised according to clearly defined uses and codified levels of privacy, and closely linked to agricultural activities. The Nepali word for house is “ghar” which means a residential complex where the master of the house and his family lives permanently. The residential complex includes not only the house but also a courtyard and possibly cattle shed and a garden. The main portion, which lends its name to the whole, is the dwelling building. [...] “Ghar” is opposed to a temporary residence, “dera”, which could be in the city or another village, or a shepherd’s cabin (in the high mountain pastures or in the forest which serves a grazing land), “goth” or cattle shed⁶⁴. The courtyard is limited by perimeter walls restricting access for animals, accommodating agricultural activities. The house is installed on the upper part of the terrace.

Other constructions: exterior fire place.

The house consists of exterior and interior spaces. Outside, the veranda -up to the “water dropping line”- is a social space for receiving visitors. Inside, the ground floor counts the kitchen space is reserved to family members, and special guests. Goods are kept on the first floor, the most private space.



Birds eye view on the layout of the house under reconstruction, ward 6, Bijulikot, Ramechhap –© Wendy van Amerongen



Load Bearing stone masonry in mud mortar; Location Sunkoshi Rural Municipality-06, Sindhuli, 2018 – ©HRRP



Cluster of houses, Dolakha, after 2015 Gorkha’s earthquake –©CRAterre

⁶⁴ Gaborieau, 1991

[3.6] LOCAL HOUSING & SETTLEMENTS IN THE MID MOUNTAINS

► RURAL SETTLEMENTS

In the mid-mountains, compact housing clusters are built: houses are traditionally gathered on non-agricultural land, due to the severe climate constraints and associated risks, so as to preserve the productive lands. For example, in the Tamang Heritage trail, such as Gatlang, Rasuwa, settlements commonly consist of row-houses. In recent evolution of these settlements, more and more isolated houses are being built, most probably due to the lack of solutions for repairing or retrofitting. As a consequence, more and more farming land is used for housing construction, and the dense coherent villages are tending to scattered housing patterns.

Sherpa villages are mostly built on the beds of old lakes in broader valleys or on sizeable ledges between the mountainside and river gorges. The settlements of the Tamang tribe are compactly built. Several houses are typically attached to each other reducing the exterior wall surface exposed to the coldness. The streets of Tamang villages are usually paved with stones.⁶⁵

In the Tibetan Plateau (Mustang), courtyard houses are settled on clustered terrasses. The settlements of Upper Mustang lie at an altitude between 3500 and 4000 meters, this is probably due to the extreme climatic conditions.

The solar radiation in summer is intense and temperatures can rise above 20° C. In winter, temperatures can drop below -20° C with relative humidity dropping below 50%. In January it often snows. Settlements depend on water, which is scarce and when sources dry up, settlements are moved to a more advantageous location⁶⁶.



Compact row-housing, Gatlang, Rasuwa, 2016 – ©CRATerre



Clustered houses, Gatlang, Rasuwa, 2016 – ©CRATerre



Clustered houses, Lupra Village, Lower Mustang, 2016 – ©Marie Schuiten



Clustered settlement: location given by saved agriculture land, river bed and steep slopes, Kagbeni, Lower Mustang, 2016 – ©Marie Schuiten



Forest, agriculture land and clustered settlement, Chongur, Annapurnas, 2013 – ©Mathilde Chamodot



Clustered settlement, Chongur, Annapurnas, 2013 – ©Basile Cloquet

⁶⁵ Bodach, 2014

⁶⁶ <https://spacesnepalblog.wordpress.com/2016/08/04/the-courtyard-houses-of-upper-mustang/>

► TYPES OF HOUSING

Example of Upper Mustang. Upper Mustang has a rich culture of courtyard dwellings. Adapted to the harsh climate, the courtyard houses give protection and security. Numerous variations of this building typology can be seen throughout Mustang. The ground floor is generally used for storage and stables. One enters the courtyard through the main gate, where the ponies are tethered and unloaded. The kitchen, the living room, the prayer room, the bedrooms and the toilet are on the first floor. The flat roof is used for household functions including the storage of fuel wood. The windows of the rooms open out onto the courtyard. There are only few openings on the external walls. The earthen courtyard houses are the very fabric of the settlement in upper Mustang.

Example of Langtang and Khumbu villages. It was observed that Sherpa as well as Tamang houses have two stories. In Sherpa houses, the ground floor is used for storage and livestock, the main living area is situated in the first floor. Tamangs use the upper story for storage of grain and other household possessions, while the elevated ground floor is used as a kitchen, dining place and bedroom. In Sherpa houses wooden stairs located inside the building lead to the upper floor; stairs in Tamang house are located outside on the main entry facade of the house. Sherpas use the roof partly as a terrace with a small shed for lavatory. Tamang houses have usually a balcony on the first floor and a veranda beneath it in front of the main entrance. In all houses the open hearth, normally located in the centre of the kitchen, plays an important role because it is not only used for cooking, but it is also the only comfortably warm place where the family members can sit during colder nights and in the winter season.⁶⁷

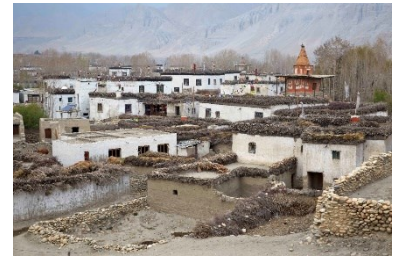

Cluster of courtyard houses, Tsarang village Upper Mustang, 2016 – © Marie Schuiten



Access to the courtyard houses, Tetang, Upper Mustang, 2016 – © Marie Schuiten



Flat roof used for wood storage, Kagbeni, Lower Mustang, 2016 – © Marie Schuiten



Courtyard house, used as a workshop, and other domestic uses, Tsarang Village, Upper Mustang, 2016 – © Marie Schuiten

⁶⁷ Bodach, 2014

28 DESCRIPTION OF LOCAL HOUSING AND SETTLEMENTS

[3.7] URBAN AREAS & KATHMANDU VALLEY

► SETTLEMENTS

Urban Municipalities

Urban settlements are much denser: contiguous habitat, commonly organized around a semi-private courtyard (at “tole” level), accessible via narrow pathways.

In earthquake affected districts, issues to rebuild or repair/retrofit their houses have forced many households to rebuild out of the urban settlements. Many damaged buildings are then left unoccupied (or with downgraded use such as storage) in the core city centres, mainly the rowhouses. And in the same time, the resettlement is widely impacting the rural landscape and agriculture activities, cropping land being used as building lands.

High-speed urbanisation has led to very dense urban settlements, where open space is scarce. This competes with public uses of open spaces and the need for escape areas in case of disaster. The availability of green space is also strongly impacted, which increases high temperatures.



Urban settlement, Simara Terai 2016 ©CRAterre



Bakhtapur, urban settlement, Kathmandu Valley, 2016 ©CRAterre

er Process

Kathmandu Valley heritage cities

Courtyards or *Chowks*:

In cities like Lalitpur and Bhaktapur, houses are commonly clustered around a chowk. A chowk is a type of courtyard that is common in the community of Newar in Nepal. The chowk is characterized by a square or rectangular space surrounded by buildings on all sides. The surrounding buildings are built on a raised platform, called *falcha*. Opposite the main entrance on the ground floor is an area dedicated to the Guthi—Social Unify and other Gods with idols of deities. The chowk structure is excellent with respect to earthquake resistance. However, these traditional buildings are gradually becoming less common as a result of rebuilding.

Successive modifications of these specific settlements, by vertical extensions of the houses or the replacement of traditional buildings by RC constructions, weaken the homogeneity of the whole, inducing differential behaviour of the buildings and increasing the damage to the buildings in case of an earthquake.

In urban core areas, houses are commonly built in a row, with different height, building structures which induce structural complexity

BC buildings⁶⁸, also constructed in the past 30 or 40 years, comprise about half the buildings in the valley. This type of buildings is still weak regarding horizontal rigidity, owing to poor workmanship and lack of structural consideration of the joints from wall to wall, wall to wooden floor and roof and non-integration of the masonry wall itself. Although buildings of this type with less than four stories are generally constructed with suitable workmanship and adequate wall balance, those higher than four stories tall show great fragility during a powerful earthquake.⁶⁹



Courtyard in Bhaktapur, 2013 – ©Mathilde Chamodot

⁶⁸ Brick with cement or lime mortar

⁶⁹ Ohsumi et al., 2016

► TYPES OF HOUSING

Typically, in Nepal housing in the cities is multi storey, it is uncommon in urban areas to find single storey properties. The maximum building height was traditionally determined by the heights of the temples; therefore, the urban landscape was largely dominated by two and three storey houses, yet in recent years due to increasing in-migration and soaring land prices, two trends can be observed:

- Home owners have added more floors to their houses. Obviously, in larger cities there are more multi-storey houses than in smaller cities and in the city core of Kathmandu it is now more and more common to find four and five storey buildings. According to the 2010 CIUD survey, only 22% of the houses is single storey, in cities in the Kathmandu Valley this number is even less than 5%, while the number of houses with three or more storeys is nearly 50%⁷⁰.
- Traditionally the ground floor was not used as it was considered too damp to use as living quarters particularly in Newar houses. However recently in urban areas, as a result of commercialisation and urbanisation it is more and more common to rent ground floors out to tenants for commercial use (shops). The previously 'useless places' have turned into an important source of revenue. The household survey indicated over 50% of mixed-use housing where the house is being used for both residential and commercial or other purposes. Only 41% of the houses are completely residential. These houses are typically more in the hinterland.

Tenants do not typically occupy a complete house; they rather rent a number of rooms or a floor with a family. The household survey suggests that nearly half of the urban households live in a house that they share with one or more households: either relatives (owner/occupied with multiple ownership) or with tenants (owner plus renting households). In the Kathmandu Valley over 30% of the respondents indicated that they had more than one renting household living on the family premises. Anecdotal evidence suggests that the number of households living in one house can be as many as 309. The household survey indeed suggests an increasing incidence of overcrowding. Excluding the kitchen and the toilet, there are 12% of dwellings just consist of one or two rooms⁷¹.

As a result of the heavy concentration of urban population in the Kathmandu Valley, naturally the urban housing problem in the valley is more serious compared to the other major towns of Nepal. The lack of institutional arrangement for housing the urban poor vis-à-vis the sky rocketing prices of and housing has compelled or has left no other option for the urban poor than to squat on public land.¹⁰ According to a study conducted by Lumanti the number of squatter settlements in Kathmandu increased from 17 in 1985 to 40 in 2010 with a total estimated population of nearly 12,000¹¹. While the number of settlements tripled in that period, their population rose by tenfold and now accounts for 7% of the urban population. The problem of squatters is also increasingly visible in other fast growing municipalities like Dharan and Biratnagar

⁷⁰ ALNAP, 2010

⁷¹ ALNAP, 2010

Kathmandu Valley heritage cities

In urban core areas, four-story buildings dominate, and more than a third of the buildings are five stories or higher. The construction of the Nepalese traditional four-story house is shown in the cross section. These are mainly brick masonry structures, but many of them have been extended vertically by adding additional stories to the original three- or three and a half-story building. In addition, many of them are divided vertically for the use of separate families because of the local custom of succession of property. This contributes to higher seismic risk, even if one does not consider the poor building technology actually adopted for the construction.

RC buildings⁷² have been constructed in the last 30 or 40 years in urban areas. Although most building owners and constructors believe that RC buildings are safer and sufficiently strong, most buildings were designed without a structural engineer and were built with supervision by unskilled craftsmen or masons who had no fundamental practice or structural knowledge of RC work.

26

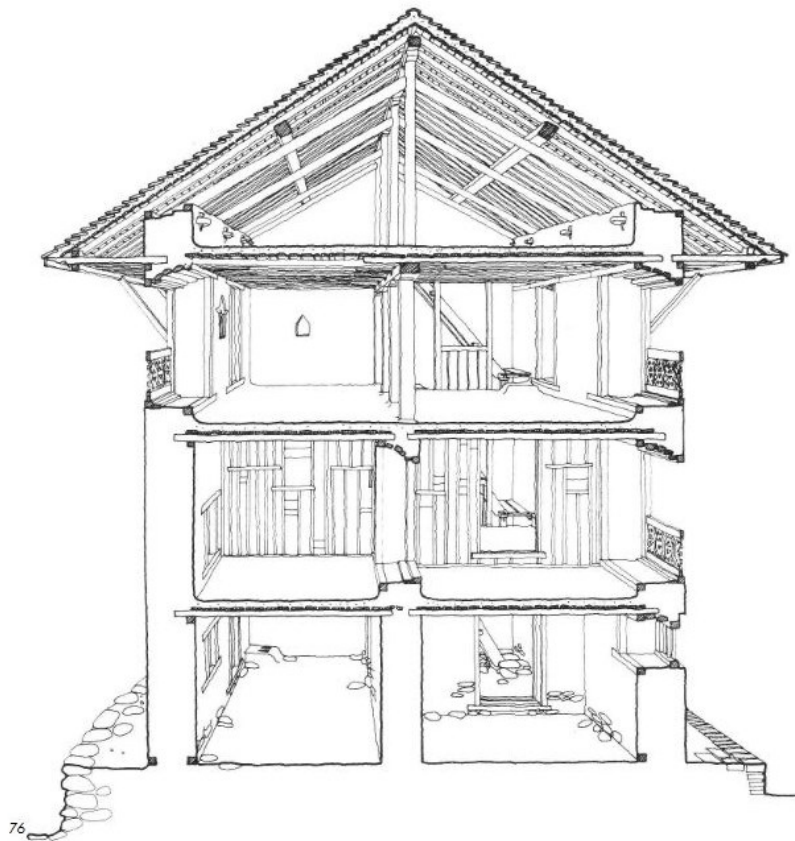

r Process

Section of a Newari house, Bungmati – © Jørgen Rahbek Thomsen, Jens Wærum and Hans Haagenen.

⁷² Reinforced concrete frame with masonry

[3.8] SUMMARY OF LOCAL AFFORDABLE SOLUTIONS: GENERALITIES

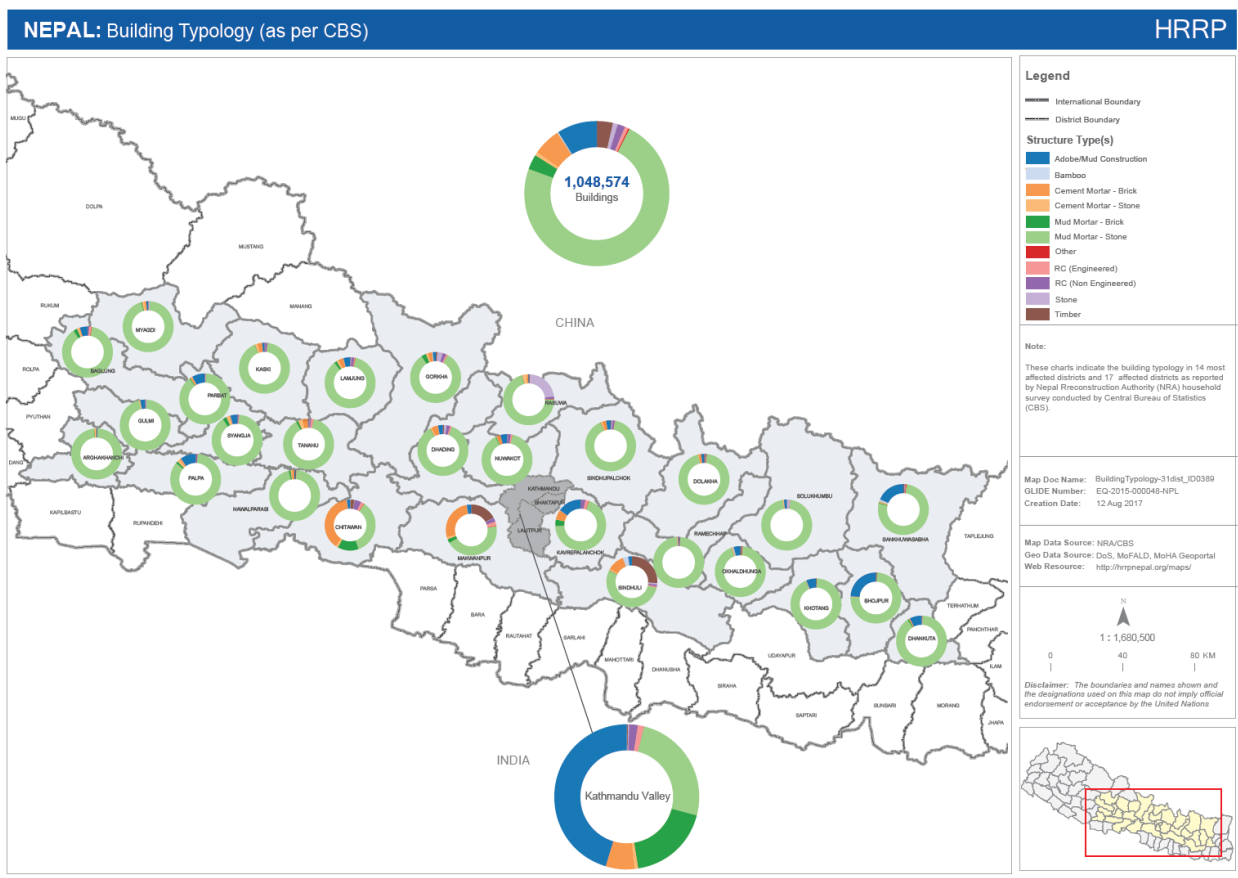

Building typologies in the affected district after the Gorkha earthquake, 2017– HRRP

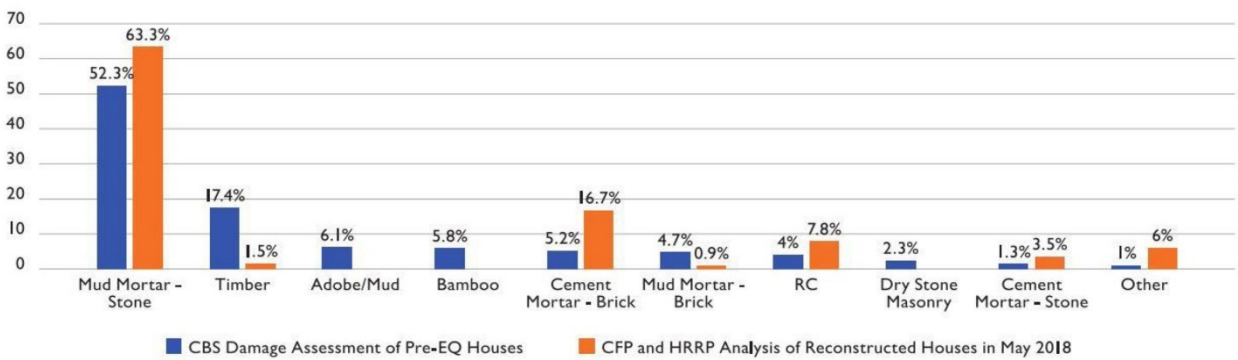

Building typologies in the affected district, before and after the Gorkha earthquake, 2018– HRRP

According to CBS assessment of housing typologies and HRRP analysis of reconstruction houses (2018), Stone and Mud Mortar masonry is the main building technology applied today, and constitute a large majority of the housestock .

Most of the houses built before 2015 in SMM had 2.5 or 3 floors, while the houses rebuilt after 2015 have 1 or 1.5 floors.

They consist in 1 or 2 rooms constructions

NB: the following summary tends to compile the main adopted solutions, but it is not possible to cover the complexity. Other options are combining these main options, by the addition of rooms for instance.

[3.9] SUMMARY OF LOCAL AFFORDABLE SOLUTIONS

► AFFORDABLE HOUSING SOLUTIONS BASED ON LOCAL BUILDING PRACTICES: VERNACULAR ARCHITECTURES

Region	Terai	Mid-hills	Mid-Mountain
Number of levels	1 or 2 floor + attic	1 or 2 floors + attic	1 or 2 floors + attic
foundations	<ul style="list-style-type: none"> Stilts (hard wood buried in ground) Raised platform (mud) stone protected plinth 	<ul style="list-style-type: none"> Stone in mud mortar linear foundation up to plinth level 	<ul style="list-style-type: none"> Stone in mud mortar linear foundation up to plinth level
walls	<ul style="list-style-type: none"> Wattle and daub (Bamboo /timber structure) Burnt bricks load bearing masonry Stone in mud mortar masonry 	<ul style="list-style-type: none"> SMM load bearing masonry Brick in mud mortar masonry 	<ul style="list-style-type: none"> Dry stone load bearing masonry walls + timber frame Rammed earth / sun dried bricks masonry walls + timber frame
Floor structure	<ul style="list-style-type: none"> For raised structures: wood or bamboo structure and mud layer 	<ul style="list-style-type: none"> Timber / bamboo 	<ul style="list-style-type: none"> Wooden structure
Floor finishes	<ul style="list-style-type: none"> Mud plaster Cement plaster 	<ul style="list-style-type: none"> Mud layer Concrete flooring 	<ul style="list-style-type: none"> planks
Roof structure	<ul style="list-style-type: none"> Bamboo/ timber 	<ul style="list-style-type: none"> timber 	<ul style="list-style-type: none"> Wooden structure
Roofing	<ul style="list-style-type: none"> Thatch Tiles CGI 	<ul style="list-style-type: none"> Slates Wooden shingles CGI sheets 	<ul style="list-style-type: none"> Wooden Shingles / slates Flat roof: Mud “slab”
Division walls	<ul style="list-style-type: none"> Bamboo fence / mud 	<ul style="list-style-type: none"> Wooden planks / adobe 	<ul style="list-style-type: none"> Wooden planks
Window frame	<ul style="list-style-type: none"> N.A 	<ul style="list-style-type: none"> Timber “box” 	<ul style="list-style-type: none"> Wooden façade Timber “box”
Wall protection (indoor)	<ul style="list-style-type: none"> Clay plasters 	<ul style="list-style-type: none"> Clay plasters inside + outside 	<ul style="list-style-type: none"> Mud plaster and/or planks
Wall protection (outside)	<ul style="list-style-type: none"> Clay plasters 	<ul style="list-style-type: none"> Clay plasters 	<ul style="list-style-type: none"> None / clay plaster
finishes	<ul style="list-style-type: none"> Clay paints and “bas-reliefs” 	<ul style="list-style-type: none"> Clay paint 	<ul style="list-style-type: none"> Coloured paints

► GLOSSARY

BMM	Brick in Mud Mortar
RCC	Reinforced Cement Concrete
SMM	Stone in Mud Mortar
BMC	Brick in Mud Mortar

34 DESCRIPTION OF LOCAL HOUSING AND SETTLEMENTS

► SUMMARY OF LOCAL AFFORDABLE SOLUTIONS : TYPOLOGIES RESULTING FROM TRANSFORMATIONS OF VERNACULAR MODELS

The 2015' EQ has resulted in fast changes in the building practices, with the adoption of new technologies and materials in urban areas so as in rural, even of difficult access areas, and the mixing of "vernacular" and "globalized" forms and techniques.

Hybrid Structures have been adopted spontaneously after the 2015 Gorkha earthquake, as a self-recovery strategy, for mid-term shelter or more durable solutions, in particular in the mid-hills. People unbuilt the damaged parts of their houses, keeping the ground-floor (less affected), most commonly built out of stone masonry walls, and reuses salvaged materials (timber, roofing material, doors and windows, etc.) for building up a light first floor. Though these constructions often do not comply with the norms and standards. Guidelines have been developed for the construction of earthquake resistant hybrid structures.

Due to misconceptions about what types of houses people could build with the NRA grant, most thought they had to build a one- or two-room house resembling early NRA model houses. Those who wanted to build bigger, often either built outside the grant or built a smaller NRA-approved house, but then expanded it without necessarily following the building guidelines for earthquake-resistant houses.

With limited space, beneficiaries continued to use old, damaged houses or temporary shelters alongside their new code-compliant 'earthquake houses, or added annexes to their new house, such as a kitchen accommodating a firewood stove.' This was the case as the new houses in rural areas tended to be smaller (most commonly two rooms) due to the comparatively higher cost of construction.⁷³

Due to this situation, hybrid structures (where globalized styles and vernacular techniques merge) can be observed at large scale following two main situations:

Efficient options:

The base is constructed out of massive masonry walls (for instance stone masonry), with wooden structure for the floor; on top and attic or 2nd floor is built with a light structure (timber or metal structure) and light infill material (CGI, planks or thin masonry walls). The two structures are properly connected and the general shape is regular and compact, loads are well distributed and balanced

Hazardous options:

On top of newly built one or two-room house-one-storey building, in most cases built in bricks in cement mortar or RCC frame building with concrete slab, vertical extensions (2nd or 3rd floor) are built with other building system (stone in mud masonry for instance) and /or without proper connection with the ground floor, nor considering the general shape... The ground floor is not designed for such loads, and the low quality of recently adopted techniques make these constructions very vulnerable. This is an ongoing process.



Sound hybrid structure: masonry ground floor & timber+ CGI sheets storey, Bhojpur. ©HRRP



Safe hybrid structure: masonry ground floor & timber storey, Sindhuli. ©HRRP



Hybrid structure, Timber and CGI fencing on masonry ground floor, Molung, Okhldunga. ©HRRP



Addition of an extra room, in direct contact with the « core » house. The risk is high of

► FOR MORE INFORMATION

HYBRID STRUCTURE MANUAL FOR HOUSES THAT HAVE BEEN BUILT UNDER THE HOUSING RECONSTRUCTION PROGRAMME
<https://www.preventionweb.net/publications/view/63582>

⁷³ Aid and Recovery in Post-Earthquake Nepal Independent Impacts and Recovery Monitoring Phase Qualitative Field Monitoring, 2019

► SUMMARY OF LOCAL AFFORDABLE SOLUTIONS: GLOBALIZED STYLES

After 2015's Gorkha earthquake, a large proportion of home owners adopted RC frame with masonry infill or cement mortar masonry (stone / fired brick /cement block in cement mortar). This rapid switch to new building techniques has widely impacted the typology of housing solutions, work organization, local economy.

BCM Brick and cement mortar Masonry:

Cement mortar is progressively replacing mud mortar in brick masonry walls (up to 17% of reconstructed houses after the 2015's earthquake). This solution has been promoted in the reconstruction trainings and technical assistance programs, for the possible higher bonding strength of the cement mortar. BCM houses are generally 2 or 3 storeys (more according to NBC).⁷⁴ The quality of the mortar may not be well controlled and can have a negative impact on the building strength.

HCB Hollow Concrete Block and Cement Mortar Masonry

Hollow Concrete Block (HCB) masonry was not a category of building type documented through the CBS damage assessment (falling under 'other'), but HCBs are being used for reconstruction throughout all 32 earthquake affected districts. HCBs are particularly prevalent in Kaski, where production of HCBs is high (but still rare).⁷⁴ The quality of the blocks is uneven, and poor in some areas.

Light Steel Frame Structures

In the reconstruction process, new typologies of houses have been developed using this building system. In March 2018, the NRA published the 'Light Timber / Steel Frame Structure Manual' to provide guidance on construction of these buildings in relation to the requirements under the reconstruction grant process. The main challenge is the transport of steel frame in remote settlements, and the requirement for high level of technology and trained workers.⁷⁴



Brick in cement mortar masonry, Halesi Tuwachung, Khotang, 2018 – ©HRRP



Brick in cement mortar masonry, Lisankhupakhar-rural-municipality, Sindhupalchowk, 2019 – ©HRRP



Hollow concrete blocks in cement mortar masonry, Naukunda-rural-municipality, Rasuwa-, 2018 – ©HRRP



Hollow concrete blocks in cement mortar masonry, Sindupalchowk, 2017 – ©CRAterre

⁷⁴ HRRP, 2018

36 DESCRIPTION OF LOCAL HOUSING AND SETTLEMENTS

CSEB Compressed stabilised Earth Block Masonry

Compressed stabilized earth block (CSEB) masonry was not a building type category documented by the SBC damage assessment. In general, the adoption of CSEB masonry has been limited and is primarily seen in areas where it has been promoted/provided by partner organizations (POs). The interest is in the use of locally available soils. The challenge is quality control and the need to train builders in this newly introduced technology.⁷⁴

RCC Reinforced Cement Concrete Framed Buildings

While RCC structures are most prevalent in urban and municipal settings, they are becoming more common in rural areas where access to engineering support and quality materials is limited. RCC structures not only perform best when engineered properly, but also require a higher level of craftsmanship than most brick or stone structures. The prevalence of non-engineered buildings is high in earthquake affected districts.⁷⁴

Emergence of pseudo-traditional styles

The spate of new concrete-frame construction concealed behind traditional material threatens to destroy the integrity of the architectural character of Bhaktapur, as it introduces a new architectural style. Several local heritage managers call it 'pseudo-Newār style' (Amatya 2007, 137). Although these structures look traditional, they lack the historic patina, formal character, and expressive quality of historic craftsmanship; thus, they do not evoke the sense of historicity of Bhaktapur. The wooden fenestration installed in the new construction represents more Western than traditional sensibility in design, despite some carving and ornamentation.⁸ Furthermore, to gain more usable floor space, mostly flat concrete roofs are constructed instead of the traditional tiled gable roofs. This changes the character of the roofscape of the town. The gradual alteration of Bhaktapur's historic character and the emerging pseudo-Newār architectural style have not yet drawn the attention of the community and heritage managers. A new understanding of cyclical renewal of historic structures is urgently needed⁷⁵.



Light steel frame structure for upper storey on BMC ground floor, Jiri, Dolakha, 2017 – ©HRRP



Compressed stabilized earth blocks masonry house, reconstruction program, Lumanti. Simara, Terai, 2022– ©CRAterre



Reinforced Cement Concrete Framed, reconstruction Umakunda rural municipality, Ramechhap, 2017– ©HRRP

FOR MORE INFORMATION

Housing Typologies: earthquake affected districts
https://www.hrrpnepal.org/uploads/media/HousingTypologies-EQAffectedDistricts-HRRP-FINAL-180927-compressed_20190204141617.pdf

⁷⁵ Pieris, 2018

[3.10] CONSTRUCTION MATERIALS AND TECHNIQUES

► CONSTRUCTION MATERIALS (MINERAL, VEGETAL, INDUSTRIAL...)

Almost three-quarters of Nepal's population live in homes that are made of locally available materials like stone, wood, bamboo and the multifaceted clay in the form of burnt brick, rammed earth, adobe cob, and wattle and daub. Nepal has a rich tradition of vernacular architecture, but in the last 30 years owing to government policies the vernacular has not been able to thrive in the modern context. The government's restriction on harvesting and usage of wood adversely affected the traditional practices of making earthquake resistant wooden bands over the years. In the April 2015 earthquake, many buildings of relatively recent vernacular construction, especially stone with mud mortar typology, collapsed. On the other hand, both traditional and contemporary buildings that incorporated earthquake-resistant features survived ⁷⁶.

It is common to classify the housing typologies using these 3 categories defined by the adopted materials for walls and roofing: Pakki (permanent, robust, durable), semi-Paki (semi-permanent), Kachchi (temporary, fragile, undurable⁷⁷), although it may not correspond to the uses and devalue architectures built with non-industrial materials.



Road from Mantali to Deurali, Ramechhap. on the same plot, with the same local building materials, a series of neighbouring houses suffered very different damage, most likely due to construction details and maintenance. 2015 ©CRAterre

⁷⁶ Adhikari, 2016

⁷⁷ Alnap, 2010

MINERAL MATERIAL (GEO-SOURCED MATERIALS)

Stone (*dhunga*)

Stone: It is the oldest and most abundant material used as a wall and foundation material in Nepal. The main varieties in Nepal are limestone, sandstone, dolomite, granite, quartzite, and marble. Most of the people in rural regions have limited material options due to poor economic conditions and lack of transportation. Therefore, they simply use locally available stones (boulders, rubble, or dressed or semi-dressed stone) around their periphery without being specific towards the good quality and standard size.

Stone slates were commonly used until recent times, mainly in the Mid hills. After reported injuries due to slates fall during earthquakes, it has been recommended to adopt lighter materials for roofing. NB: this change of roofing material should be accompanied with modifications in the globality of the construction, if not it can lead to unforeseen effect (modification on the load of the walls, inner comfort, etc...)

Earth (*Mato*)

Earth (or mud, soil, clay) is widely used for the production of sun-dried bricks, mortar for the stone masonry walls in the Mid Hills, massive earth walls (rammed earth) in the Himalayan plateau, infill of wooden / bamboo structures (wattle & daub) in Terai. But also, for earth floors, plasters, inside and outside of the houses.

Local knowledge includes many stabilizers used for the optimization of mud mixes: vegetal (fibres such as rice straw, rice husk, etc.), animal-transformed (cow-dung), or mineral (lime).

In the case Kathmandu Valley, some clays are dug from river beds, while others are dug directly from agricultural terraces on hill slopes where a temporary kiln is usually installed nearby. Most kilns remain in situ only for a short period of time after which they are dismantled, letting the newly worked soil return to its original state for use in agriculture.⁷⁸



Adobe (sundried mud bricks) production site near Drakmar, Upper Mustang



Stone masonry walls, stone slates, Ramechhap, 2017—©HRRP



Rammed earth masonry walls under construction, Kagbeni, Lower Mustang, 2016— ©Marie Schuiten



Mud plaster preparation, for wattle & daub house maintenance, Tharu village, Terai, 2016— ©Marie Schuiten

⁷⁸ Caterina Bonapace, Valerio Sestini, 2003

INDUSTRIAL MATERIALS

Burnt bricks, tiles

Brick production is a large-scale industrial activity in Kathmandu Valley and is a major source of air pollution as well as land-use problems. Since bricks are the Valley's main construction material, brick production and demand are increasing continuously with the growth in the population, and its dramatic urbanisation and modernisation. The environmental and health concerns associated with Kathmandu Valley's brick industry are a serious issue, especially because the industry uses poor-quality fuel and inefficient technology.⁷⁹

Brick kilns employ child and bonded labour⁷⁹. 25 brick kilns in the Valley, 90% are inefficient and polluting kilns that use older technology.⁷⁹

There is no standardised brick dimension used in Nepal, which often results in uneven wall thicknesses. Walls are traditionally built by constructing two brick leaves, one external visible leaf and one internal leaf built using common bricks. The space between the two leaves is filled with a mix of clay soil and pieces of broken brick. The same type of earth used to make the bricks is used to fill the gap between the two walls. Fair-faced external wall leaves are built using a regular bond with small displaced joints obtained using a special brick, the *daci appa*. The use of the *daci appa* brick is a typical feature of external walls found in the Valley. They have very thin joints for aesthetic and technological reasons. The technological reason arises from the necessity to ensure good resistance against water penetration during the abundant monsoon rains. The joints are carefully filled with a special mortar called *silay* in Nepali, made from oil, vegetal resin and red clay. Emphasis on the aesthetic value of these bricks is obtained by applying particular treatments to the visible part prior to firing.⁷⁸

Industrial brick production today is not concerned with tradition, but primarily with trade and is a seasonal activity. Different people participate, often without any specialised knowledge. Kiln owners are the only people who are really able to closely follow tradition, but their knowledge often focuses upon economic returns rather than quality, which is considered to be less profitable. As a general principle when buying bricks, one goes to bigger kilns to find cheaper products and to smaller kilns to find better quality. A difficult element to be made for example is the *daci appa* brick. Production of these types of brick will most commonly be found in small traditional kilns.

Cement

The use of cement is increasing drastically. It is mainly used for cement mortar in brick masonry walls, RCC elements (post, beams, slabs, seismic bands), and plasters.

Year 2014 estimates production capacity of cement being 2.46 million metric ton which is expected to reach 10.37 million MT in 2030, with a cumulative cement demand of 96.00 million MT, from 2015 to 2030 in normal (BAU or Business as usual) growth rate scenario. Similarly, the cement demand would rise to 14.88 million MT in 2030 with cumulative demand of 117.14 million MT, in Medium Growth (MG) rate scenario. In case of

high growth (HG) rate scenario, the cement demand rises from 2.46 million MT in 2014 to 25.41 million MT, with cumulative of 172.90 million MT⁸⁰.

Likewise, the CO₂ emission for the base year 2014 is 365 400 MT. The annual CO₂ emission would increase to 1 540 700 MT, 2 292 900 and 4 105 600 MT in 2030, under BAU (business as usual scenario), MG (medium growth scenario) and HG (high growth scenario) respectively⁸⁰.

Besides the need of cement, concrete construction induces a growing need for sand and gravel. In rural areas, gravel is "produced" manually by crushing stones. The calibration of the gravel produced is not optimized for quality cement concrete.

Metal

Light metal structures are promoted in reconstruction, for hybrid structures and/or for roof structures.

CGI sheet is widely used as a roofing material, and walling material for temporary or transitional shelters.

⁷⁹ Shrestha, 2012

⁸⁰ Singh, 2016

► VEGETAL MATERIALS (BIO-SOURCED MATERIALS):

Timber (*kāth*)

The Terai region, a 26 to 32 km wide broad belt of alluvial and fertile plain in the southern part of the country, is rich in Sal (*Shorea Robusta*) and Sisau forests. Sal is a high-quality wood that is very strong and durable. It is used for the construction of structural elements like pillars, struts and beams as well as for windows, doors, grates and mouldings. The trees are big and grow as high as 30 meters, with a broad cross section that allows for very sophisticated works to be produced.

Apart from the Sal tree which comes from the Terai region, the most common species used for construction [...] are Gwaisasi (*Schima Wallichii*), Salla (*Pinus Roxburghii*) and Utis (*Alnus Nepalensis*). All are found growing on the slopes and hills around the Valley.

Gwaisasi is of a lower quality than Sal. These woods do not normally require any special treatment for protection. Other types of wood that are softer and of a medium quality are used for furniture. They are much more vulnerable to xylophage insects and need to be treated so that they last longer.⁷⁸

The Terai region is very fertile and the forests growing there can supply all the country's requirements. The Forest Office of every district is responsible for managing the deforestation process. Most lands are managed together with the autonomous Community Forests that are managed by the local people and government. Once a year, before the ideal period for cutting, usually wintertime, until the end of February, they get together and decide which parts of forests can be cut. [...] Most forests north of the Terai plain region, the Shivalik zone, are managed by local Community Forests, woodcutting is organised in the fields. People cut trees of a predetermined size and keep them in piles until a customer comes to collect them⁷⁸

Pangles (wooden tiles):

In the middle mountains, for example on the Tamang Heritage Trail, wooden planks are used for the roof. These wooden tiles are protected from insects and fungi by domestic fumes, and regularly turned over. NB: The recent reconstruction accelerated the replacement of the pangles by CGI sheets.

► CONSTRUCTION MATERIALS MARKETS

Historical documented data shows that when the degree of housing/shelter destruction exceeds the average number of units constructed each year in the area, markets are frequently unable to respond to the exceptional demand for construction materials, skilled and unskilled labour, and financial flow⁸⁴.

It may also be stated that, while the market appears to be functioning normally during normal times, it is very volatile during times of crisis. The direct impact can be observed in the availability and cost of supplies, as well as the transportation of housing/shelter materials and the participation of

Bamboo (*bāns*):

Bamboo is a flexible and strong material that has been used in housing construction throughout Nepal and the world. Bamboo is low cost, available throughout Nepal. There are 81 species⁸¹ of bamboo which grow in Nepal. Bamboo is fast-growing, even in poor soils; The total bamboo coverage area in Nepal is estimated to be around 63,000 hectares, with approximately 60 percent estimated to be growing in natural forests⁸².

Despite the fact that bamboo offers many advantages in its own way, in Nepal it is mainly a material that is used by the "poorer sections" of the population⁸³.

Bamboo is locally used mainly for scaffoldings, light construction, partition walls and roofing structure. After the recent earthquakes, many temporary shelters quickly built out of bamboo stripes and bamboo poles.

Bamboo varieties identified during field assessments in Dolakha, Sindulhi and Ramechhap:

- Dungle bans : small sections are used for roofing, medium section for boundary / inside walls, and big culms for poles
- Taru bans (more resistant): approximative diameter 10 cm, masily used for poles.

NB: If properly treated, bamboo can be used for structural elements. Such as for wood, economical & low-toxicity solutions (like borates soaking and diffusion) bamboo treatment methods could be applied at sawmill level, or at householders' groups level.

Thatch:

Different fibres are still used for thatching roofs, in particular in Terai plains. Around 20% of roofs are covered with thatch⁸⁷. Fibres used for thatching roofs include grass, rice straw (rare).

Under GoN's programs, household can apply to financial support to replace the thatch roofs by CGI sheets.

construction workers in various projects. However, the market structure is disorganized, and the construction market's existing supply chain is in poor shape during the crisis. There is low construction material storage capacity, the lack of active national consumer associations, the Department of Commerce, Supplies & Consumer Protection's inadequate monitoring mechanism and regulation for the construction material market, poor road facilities, and cost inflection are some of the examples that have a cumulative impact on the construction market in different districts of Nepal.⁸⁴

According to a study carried out in 2021, in normal time, all construction materials such as sand, aggregates, stones,

⁸¹ For nepali bamboo species and their uses see : <https://robibradshaw.com/pdf/appendix.pdf>

⁸² Eaton & Josh, 2018

⁸³ Marijn Candel et Jesse van Hassel, 2021

⁸⁴ Habitat for Humanity Nepal, 2021

cement, sheets, iron rods, roofing materials, etc. are available, though in times of crisis):

- cement and CGI sheets are not available any more (for 50 % of retailers)
- transport costs, price hike up to 40%
- cement prices hike up of 50-60%, steel bars 80%, roofing material 50-60%, wood 40-45%

In general materials that are not widely available in local area are found to be expensive. « Price manipulation can take many forms. For example, suppliers may raise prices when there is a material shortage in the market owing to the off-season since storage costs are higher than during the regular season. Similarly, during the monsoon season, there is a barrier in the path for various reasons, resulting in a scarcity of supply from manufacturers and sellers, who raise prices. Likewise, during disasters and crises, the supply chain is automatically disrupted, resulting in a material shortage in the market.⁸⁴

In addition, in normal time retailers prefer cash (90%), but credit is the norm in times of crises. The loan amount and interest are calculated according to MFI rules and policies, and interest and principal payments are made on schedule. During Covid 19 pandemic, 36% of low-income households and 55% of retailers deferred the loan payment time.⁸⁴

► MAIN CONSTRUCTION TECHNIQUES

According to a study on reconstruction in Gorkha and Sindhupalchowk, two districts most affected by the earthquake, most of the households (45 %) built SMM houses followed by BMC (34%). RCC structure was built by 14 % of households and the BMM structure was the least preferred type.⁸⁵

As a result of the reconstruction strategy, in the most affected districts after Gorkha's earthquake, builders have integrated BBBS (Building Back Better & Safer) techniques, to comply with the norms.

Before 2015 earthquake, absence of vertical reinforcement and horizontal bands, inappropriate laying (no interlocking) of stone masonry with bulky mass of soil mortar were common as a result severe cracks and wall collapse were common failure during earthquake. Stone and brick are the major wall materials used, with thickness in range of 350mm to 450mm both before and after 2015 earthquake. In new houses, masonry units are laid interlocking with each other, horizontal bands i.e. RC (75mm to 100mm) or timber (65 mm to 75mm) installed at vertical interval of about 915mm, vertical reinforcement i.e. rebar (12mm) or timber post (85mm to 105mm) are installed in corners, junctions and edges of opening which has overall hold the masonry building into single unit (structural integrity) and provided ductility.⁸⁶



Stone in mud mortar EQ affected houses, Dolakha, 2015 – ©CRAterre

⁸⁵ Panthi et al., 2021

⁸⁶ Khadka et Jiang, 2019

Main earth construction techniques

- Stone in mud mortar masonry (SMM):

stones are bonded with a mortar prepared with earth (clay, silts, sand and gravels in specific proportions). To improve the mortar quality (ductility, cohesion, resistance to water erosion, etc.), additives are employed (mineral, vegetal, or animal sourced). The quality of the masonry depends on many factors: the quality of stones, stone bonding, shape of the walls, connection with structural elements, mortar quality, etc.

- Bricks in mud mortar masonry:

Adobe (sun-dried bricks) or burnt bricks are bonded with earth mortar. In adobe masonry walls, the hardness of the mortar should be close to that of the bricks. In Kathmandu valley, brick walls have frequently been built using sun-dried bricks for the inner face and burnt brick for the outer face of the walls. NB: This is logical in term of water resistance, economy of materials, inner comfort, etc. but the structural behaviour of this hybrid masonry is not adapted to the seismic risks.

In Kathmandu Valley, bricks are bought from the brick kilns: the size of sun-dried and burnt bricks is given by the kiln brick standards (green brick = 25cm x 12cm x 5cm). The wall thickness depends on the brick setting. In mid mountains, adobe bricks are produced specifically, with larger dimensions (brick of the width of the wall, for instance 40cmx40cm)

- Earth plasters:

Earth mortar is applied after completion of masonry walls on both sides of the walls (mostly manually, but can be applied with specific tools). The mix of clay, silt and sand is completed with fibres mainly, but also organic or mineral stabilizers. It is applied by layers, and regularly maintained. Earth plasters provide texture & colour of the wall surface, and participate to the inner comfort (air / humidity regulation).

- Rammed earth:

Monolithic rammed earth walls are raised by compaction earth (at humid state) in formworks with manual tools (pestle). After compaction, the form can be taken of and the wall will reach its optimal resistance after a few weeks of drying. The wall can be left "raw" or covered with mud plasters.

- Earth floors on wooden/bamboo structure:

Earth floors are composed of a timber or bamboo structure covered with a 10cm layer of mud mortar. After complete drying of the thick layer, a mud plaster is applied to provide a smooth, easy to maintain finishing. Regular maintenance consists of a mud-cow dung paint.



Mud plasters application on SMM house, Dolakha, 2016 – ©CRATERre



Wattle and daub partition wall, Dolakha, 2016 – ©CRATERre



Rammed earth masonry walls, Upper Mustang, 2016 – ©Marie Schuiten



Adobe masonry walls under construction, upper Mustang, 2018 – ©HRRP

Main bamboo building systems

Bamboo structure

Bamboo poles (or half-split bamboo) are commonly used for floor and roof structures in the Mid Hills; but also, for wall, floor and/or roof structure in Terai plains. Links are flexible joints using vegetal ties.

- Bamboo walling:

Split bamboos (bamboo strips) are used for secondary elements in the form of bamboo mats or bamboo fences, or secondary structure for wattle and daub walling (with mud infill).

For instance, in Jhapa (Terai) walls of majority of houses are constructed from bamboo *ikra* (net constructed from bamboo sticks tied together). Wall system and partitioning is provided with the *ikra* having relatively low weight and easy circulation of air as a countermeasure against relatively higher temperature than any other physiographic regions of Nepal.⁸⁷

- Bamboo weave with mud plaster

This is a variation of wattle and daub technique: the main structure consist in timber or bamboo poles, supporting a secondary structure (bamboo weave). On both sides of this fencing element, a mud mortar is applied (handily). The thickness of the mud and bamboo wall is between 5 and 15cm. A series of layers of earth plasters are applied. A drying period is observed between 2 coats. The final plaster is providing the texture and colour of the wall, and is regularly maintained. The result is a flexible and “light” element, adapted to seismic risk.

► ROOFING

Most of the masonry houses have sloped (around 15–30°) roof with timber or bamboo as structural members, and varying roof coverings like clay tiles in Kathmandu valley, wooden shingles in cold regions, stone tile in other hilly regions, concrete/clay tiles in terai regions and some part of hilly regions, thatch roof in hilly regions (except valley houses) and terai regions, Corrugated Galvanised Iron (C.G.I.) sheet commonly found in all regions. Masonry houses of Kathmandu valley have modified sloped roof into flat RC roof at the time of increasing floor numbers openings.⁸⁸



Bamboo weave with mud plaster, Terai, 2016 – ©Marie Schuiten



Bamboo walling, Terai, 2016 – ©Marie Schuiten



Bamboo walling and thatch roof, Terai, 2016 – ©Marie Schuiten

Techniques that are not validated in the building code should not be adopted in housing construction. But it is possible to document good practices, build guidelines based on evidence, and get the guidelines approved in short period of time from the authorities.

⁸⁷ Gautam et al., 2016

⁸⁸ Khadka et Shakya, 2021

[3.11] ORGANIZATION OF CONSTRUCTION

► AVAILABLE SKILLS

Formal construction training (with a focus on masonry training) has been part of the construction strategy in the districts affected by the 2015's earthquakes. About 54,000

people nationwide have been trained (up to 2018) as masons through government and non-government programs as part of Nepal's earthquake recovery efforts. However, only 10% are women

TASK SHARING IN CONSTRUCTION

The following description refers to the construction process in the rural areas in central Nepal.

The foundations can be done by anyone and this work is generally carried out by the owner, his family, neighbours or paid labourer.

The noble work, the construction of the walls, framework of the roof, is carried exclusively by the men who may be unspecialized, semi-specialised or in the case of the carpenter, completely specialized.

The women have no specific work until the house has been completed. Using their hands, they rough-cast the floors, the inside and outside walls with mud. With a rag, they supply a coat of clay, "rato mato", and cow dung on the rough-cast. This solid mixture is considered a purifier and gives an ochre tint.

[...] the women paint the openings black with a decoction made from tree barks, this same black tint and lime milk is used to draw geometric motifs on the façade and sides of the house. Tasks which have not been divided according to gender are non-specialized. These include the cutting and gathering of thatch, mixing of mud used as mortar and above all the transport of material: stone, wood, water which is required in abundant quantities and which come very often from distant fountains. This is a long and painful job as the villagers carry everything on their back with the help of head strap. The men lend a helping hand sometimes but for the most parts these chores are performed by women.⁸⁹

► SELF-CONSTRUCTION, MUTUAL AID, INFORMAL AND FORMAL MARKET

Traditional and indigenous method of labour exchange

In rural Nepal, the practice of labour exchange for agricultural purposes has been seen as ancient and widespread. There is a long tradition of helping each other in Nepalese society. *Aarma Parmah* involves people trading their work in the field, reciprocating an equal amount of labour force and time.⁹⁰ Different terms have been used by different ethnicity groups in Nepal to describe labour exchange. *Ngalok* by Sherpas in Khumbu region, *porima* or *orima porima* by Hiroshi Ishii at Parbat region, *Nogar* by Gurungs in western regions, *pareli* by ethnic Limbus, *bola* or *parma* by Newars of Kathmandu.⁹⁰

During the reconstruction, this culture of labour exchange and reciprocal aid has been adapted to construction works. The adaptation of the *Aarma Parmah* farming process of labour exchange was very successful in the earthquake reconstruction. *Aarma Parmah* was key in the disaster

reconstruction process and future research should consider exploring this form of labour further. This investigation found that *Aarma Parmah* saved families an average of 90,000 (900 USD), allowing most families to finish their reconstruction with the amount of NPR 3,00,000 (3000 USD) provided by the government. Similarly, *Aarma Parmah* was instrumental in ensuring that most vulnerable people (the elderly and those with disabilities) houses were also reconstructed. It also increased social cohesion within neighbours, was key in achieving community level activities such as road clearance, and allowed the communities to finish their house reconstruction on time and to a satisfactory quality which increased resiliency⁹¹.

⁸⁹ Gaborieau, 1991

⁹⁰ Gautam et Cortés, 2021

⁹¹ Gautam et Cortés, 2021

► CONSTRUCTION IN SEASONAL CALENDAR

Construction activities are closely linked to seasonal calendar. Regarding the diversity of situations at country level it is not feasible to sum-up the complexity of tasks / activities carried out during the year. Here is an example of the specific situation in Panauti.

Event		months (1= January)											
Area	Activity	1	2	3	4	5	6	7	8	9	10	11	12
Weather	Rainy season												
	Coldest/hottest months												
Social	Main holidays, school holidays												
	Main social events, festivals												
Construction	Main Construction time												
	Production of specific construction materials												
	Collection of specific construction material												
Agriculture	Soil preparation												
	Planting (Major) M=Maize / Pa = Paddy / Po= Potato												
	Weeding												
	Harvest												
Petty commodity production	Sweater, Socks												
Other income	Fruit collection												
Hazards	Flooding season/peak												
	Dry season/peak												
	Strong Wind												
	Hailstones												
Other	Firewood collection	15th and 30th Day of Each Nepali Month											

[4] Analysis of local building practices

[4.1] LOCAL BUILDING PRACTICES: COUNTRY LEVEL

► LIFESPAN, MAINTENANCE AND ADAPTATION

(+) Positive points

Earth & SMM houses

- (+) In these buildings, there is a strong culture of maintenance of mud plasters and mud floors. Common maintenance work is carried out mostly by women on a daily or weekly frequency. In mid-hills, cow dung is added to the mud mix, for its purification properties.
- (+) In the name of different occasions/festivals, people maintain their houses by plastering and painting using mud mortar which contributes a lot in protection of wall (long lasting) and the mud mortar joints from extreme action of rainwater, direct sunlight, frost action, etc..⁹² This frequent maintenance increases the lifespan of adjacent building elements, providing protection from rain erosion of masonry walls, mitigating the development of pests by providing plain and clean isidesurfaces.⁹²side

Wooden / bamboo construction

- (+) Timber durability is ensured by complementary strategies: selection of wood according to exposure of timber elements, adapted building details (proper footing, flexible joints, etc.), traditional practices to preserve wooden elements (for instance: "burnt" timber or bamboo) or chemical treatment (for instance DOT⁹³). Use of burnt oil for wood /bamboo protection is also observed more recently.
- (+) Mud plasters and mud masonry protect the embedded wooden / bamboo elements from humidity variations and fire.
- (+) Flexible joints and wooden pins allow for regular repairs and change of elements when necessary.

Salvage and reuse of materials

- (+) Building materials such as timber and woodwork – but also stone, burnt bricks or roofing material, or mud mortars)- are systematically salvaged after disasters. Properly piled and protected, they are reemployed in new constructions.

(-) Negative points

Earth buildings & SMM buildings

- (-) Absence of plaster work can cause extreme effects in mortar joints (further development of cracks) due to open action of rainwater, sunlight and other weathering effects⁹⁴.



The practices presented below are not exhaustive and represent only a sample of those existing. Some need to be better documented. They are constantly evolving and must be analysed on a localized scale.



Mud plasters for floor finishing, Dolakha, 2016 – ©CRAterre



Roof maintenance, adobe house with clay plasters /paints. Drakmar, Upper Mustang 2016 – ©Marie Schuiten



Timber and bamboo protected from fire with mud plasters, Mithali village, Terai, 2016– ©Marie Schuiten



Salvage of stones from damaged constructions, Dolakha, 2015– ©CRAterre

⁹² Khadka et Shakya, 2016

⁹³ DOT= Disodium Octaborate Tetrahydrate. This solution can be used for treatment by dip & diffusion. See for instance

⁹⁴ Khadka et Shakya, 2016

- (-) Lack of maintenance work leads to unexpected hazards in normal condition. For example, leakage of roof which causes weakening of the bonding of wall and finally collapses the wall⁹².

Timber construction

- (-) Hard wood, use in vernacular construction, is more expensive and less available in general. It is then replaced by soft woods, but with similar details or details taken from “temporary” construction. As a consequence, the life span of wooden elements is reduced (for instance for wooden posts without proper footing, timber bands up to plinth level, timber embedded in cement plaster, lack of termite’s protection...)

RCC frame

- (-) Rebars are left “nude” for future extensions. There is a high risk of corrosion of the rebars before they are covered with concrete, creating weaknesses in the structure.

► BIOCLIMATIC COMFORT

(+) Positive points

Clay plasters

- (+) The clay plaster blocks the air circulation, improving the insulation of the building. Nevertheless, clay plasters still allow exchanges that keep air sane on the internal. They regulate humidity in the inner spaces.

(-) Negative points

Thermal insulation in alpine climate

- (-) Findings indicate that construction of walls in semi-modern and modern houses built of commercial materials such as cement, polystyrene, and glass wool, which are gradually replacing traditional houses built of locally available materials, have 4 to 5 times greater impacts on global warming. Although the construction of modern buildings generates high GWP, their walls are more thermally efficient than those of semi-modern and traditional buildings. This helps reduce energy consumption for space heating and consequently reduces GWP. In fact, when taking heating into consideration, after only 5 years the total emissions of the traditional building equal those of the modern building. In 25 years, the total GWP of a traditional building will be 20% higher than that of a modern building; in 100 years, it will be 26% higher⁹⁵

Roofing material

- (-) The replacement of thatch (insulating) or slates (providing thermal inertia) for safety reasons reduces the inner thermal comfort, due to its very low insulation capacity/ thermal inertia. Condensation on the inner face of the CGI leads to

Cement plasters and floors

- (-) The addition of cement plaster / floors on existing earth buildings of SMM houses (lacking from DPC) creates humidity issues, inducing indoor uncomfortable, incompatible with crops conservation, and that can even produce structural issues (rotting of wooden elements, weakening of loadbearing elements).



Wooden seismic bands covered with cement plaster: risks of rapid rotting of the timber (due to humidity) with no way to control the state of the timber, Sindhupalchok, 2018 – ©CRAterre



Rebars left “nude” for future vertical extension: high risk of corrosion before they are embedded in concrete columns. Sindhupalchok, 2018. – ©CRAterre

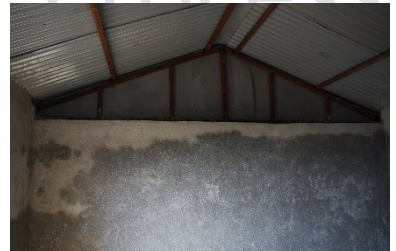

Finished house covered with CGI sheets on a metal structure, without ventilation, wall covered with cement plaster: indoor air condenses in the walls and roof. Cool materials radiate. Dhap, 2019—©CRAterre



CGI sheets roofing in place of wooden tiles, in cold areas reduces indoor temperatures, Gatlang, Rasuwa –©HRRP

⁹⁵ Bhochhibhoya et al., 2017

► ENVIRONMENTAL ISSUES

(+) Positive points

Use of locally available materials

- (+) Walls in traditional buildings produce the lowest emissions, almost equally distributed between the alkyd paint used on the wood surface and the chainsaw used to cut planks from the trees felled by hand in the park. Mud and dry stone contribute less or not at all to CO₂eq emissions, because they are manually processed and transported.⁹⁶

(-) Negative points

Use of open fire and fire wood

- (-) The main energy source pour heating and cooking in the rural context is fire wood. The pressure on the resource is intense, and the use of open fire resulting in severe dioxin emissions. need to improve the thermal efficiency of buildings? Combining massive materials (geo-sourced materials such as stone and mud) with light vegetal materials (straws, grasses, bamboos, etc.)?

Impact of massive use of industrial materials

- (-) The recent adoption of industrial materials induces environmental issues for their production, transportation, and future elimination.
- (-) According to Urban Air Quality Management Strategy in Asia (URBAIR) programme, the main contributors to the total suspended particles in the Valley are cement factories (36%), brick kilns (31%), domestic fuel combustion (14%), road re-suspension (9%) and vehicle exhaust (3.5%). Since the URBAIR study was conducted in 1997, Kathmandu's cement factory has been closed, and cleaner, more energy-efficient and more environment friendly technology for brick production has been introduced. However, there has not been a significant improvement in the Valley's air pollution. Of the 125 brick kilns in the Valley, 90% are inefficient and polluting kilns that use older technology⁹⁷.



The extraction and transport of local stone, sand and soil for the construction of stone walls has a very low energy demand, although it is labour intensive, Magapauwa, 2016 –©CRAterre



The extraction and transport of local stone, sand and soil for the construction of stone walls has a very low energy demand, although it is labour intensive, Magapauwa, 2016 –©CRAterre

► HAZARD-RESISTANT PRACTICES



(+) Positive points

- (+) To avoid the tearing of roofs under the forces of the wind, roof structure is soundly anchored to the heavy walls, through the use of metal wire, strong ties or timber elements
- (+) Roof and awning structures and roofing material are clearly disconnected to mitigate the damages or collapse of roof in case of high winds;
- (+) The general shape of the houses, compact, low roofs, and / or hipped roofs provide an aerodynamic shape thus limiting the stress on the structure in case of strong winds.



Clear dissociation of roof and veranda for better roof behaviour in case of strong winds, Dadhing 2018 –©HRRP



Plot boundary walls, made of stones and or mud bricks, limit erosion, Garphu village, Lo Manthang plateau, 2016 – ©Marie Schuiten

⁹⁶ Bhochhibhoya et al., 2017

⁹⁷ Shrestha, 2012



landslide, mudslide or Erosion

- (+) Vegetation around the constructions is reducing the erosion due to rain water.
- (+) Retaining walls built out of collected stones in the fields, delimitate the plots and limit the erosion
- (+) Rapid erosion of the mud walls, in particular at plinth level, is mitigated by the regular maintenance of the wall plasters, including using the same material regularly.



Fire

(+) Positive points

- (+) Timber elements are “pre-burnt”: this controlled burning of wooden elements provides protection against fire spread (burnt wood surface is burning slower) and natural protection against insects.



Earthquake

(+) Positive points

- (+) Seismic bands. Seismic bands provide critical earthquake-resistant provision in a stone masonry building by tying all walls together and acting like a ring or belt. Seismic bands can be constructed using reinforced concrete (RCC), timber or bamboo. They must be located at different levels of the wall: plinth, sill, lintel, floor and top of the wall (roof). Proper placement and continuity of bands and proper use of materials and workmanship are essential for their effectiveness. A seismic band does not act as a rigid diaphragm; therefore, the wall is still able to deform. Stability: The seismic bands maintain the corners together even in case of cracks or partial collapse. Friction: The friction between wood and stones is high, allowing a good dissipation of energy⁹⁸. At the present scenario, i.e., reconstruction phase after the 2015 earthquake, the trend of installing seismic bands at different sections of buildings has started in huge number (more than 85% of newly constructed masonry houses)⁹⁹. NBC 203 and 204 describe the effect of wooden strips as horizontal reinforcing members.
- (+) Wood/bamboo stitches. Especially when there is short availability of wood, it is possible to use “stitches” in the corners, in between seismic bands. Even if not as effective as seismic bands, this element will nevertheless still reinforce the corners of the walls, with the main advantage that the use of wood is less important. Stability: The stitches maintain the walls together even in case of cracks or partial collapse.
- (+) Light roof and roofing materials reduces is recommended in seismic prone areas (but this has to be contextualised, considering the complete behaviour of any building)
- (+) Lightweight floors, but also lightweight partition walls and perimeter walls of upper storeys, are considered a good option to reduce the overall mass of the

⁹⁸ Ferreira Mendes, Hosta, Le Gall, 2015

⁹⁹ Khadka et Shakya, 2021



The boundary walls of the plots, made of stones and/or mud bricks, and the maintained vegetation, increase the protection of the buildings. Tsarang village, Upper Mustang, 2016– ©Marie Schuiten



Burnt wood structure: this process protects the surface of the wood and slows the spread of fire, Dolakha, 2015 – ©CRAterre

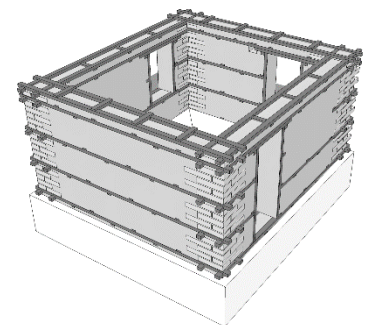

Wooden seismic bands included in SMM– ©CRAterre

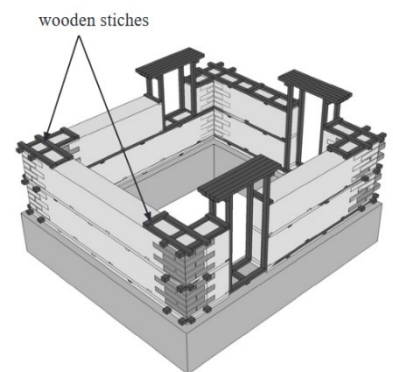

Wooden stitches included in SMM, and wooden frames (“boxes” for doors and windows– ©CRAterre

building, especially in the higher parts. This is the strategy of hybrid structures (heavy ground floor and light floors)

- (+) Lightweight gable walls: Normally, past gable wall system used thick mud masonry without gable bands and height more than 1.2m as a result gable failure was common in 2015 Gorkha earthquake. Compared to the past, recent mud masonry gable wall system is of low height with installation of bands. Similarly, considering easiness, safety and cheapness, majority of recent gable system has replaced masonry gable wall with light materials like timber and C.G.I. sheet¹⁰⁰
- (+) Independent extensions: additional volumes are built completely separated from the core house (a void is observed between the 2 structures). This avoids the “hammering effect” under seismic events (when 2 volumes with different behaviour under the seismic forces get to “punch” each other)
- (+) Wooden boxes for openings: un SMM or mud constructions, the window frame or door frame is built as a box, with such a stiffness that prevents the fall of masonry elements.

(-) Negative points

- (-) Vertical extensions are built with poor or no connections with the core house.
- (-) Vertical extensions mass is not aligned with their structure of the core house
- (-) Vertical extension is built with too heavy materials, overloading the existing structure
- (-) Vertical extension creates an unbalanced global structure (asymmetrical masses, unregular shape, etc.)

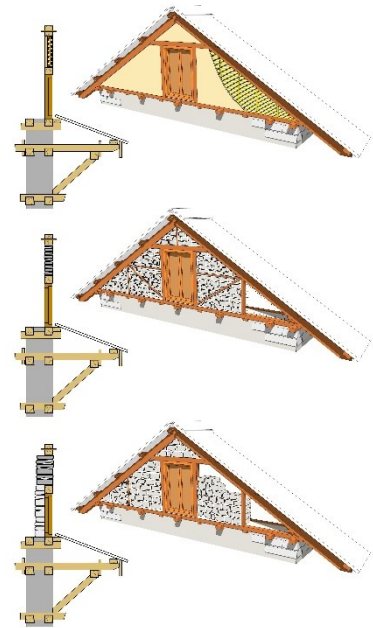

Options for lightweight gable walls: wattle and daub, or thin confined stone masonry
— ©CRAterre



Independent extension, Sindhupalchok, 2018— ©CRAterre



Hazardous vertical extension, asymmetrical load descent, exposed rebar on the roof (probably for future extension), Sindhupalchok, 2018 — ©CRAterre



Window frame built as a box, SMM house, Dolakha, 2015 — ©CRAterre

¹⁰⁰ Khadka et Jiang, 2019

► INCLUSION: GENDER AND DISABILITIES

(+) Positive points

Construction training for women and men

(+) The National Society for Earthquake Technology (NSET) trained women to be included in reconstruction efforts and helped them build skills that are traditionally reserved for men, such as masonry. NSET also organized community groups and disaster management committees that trained women on how to create “go bags” and recognize architectural issues. Both the mason training and the go-bag instruction provided women with new livelihoods.¹⁰¹

(-) Negative points

Work opportunities in construction are still uneven

(-) The main challenges that women reported facing in conducting mason training and working on the housing reconstruction are as follows: • Balancing household chores with construction work this was particularly highlighted in relation to absence of childcare options, family not supporting their choice to work on construction, and having to manage their time so that they can complete household chores before going to work in construction. • Discrimination from community / households – respondents reported that often community members / households did not trust women masons, and as a result they could not get employment. • Discrimination from male colleagues and contractors – as mentioned above, 23% of respondents reported that they are not paid equally to men doing the same work. Respondents also reported that male colleagues and contractors do not respect them or work collaboratively with them. • Absence of backup and further training – several respondents reported that they struggle as there was no follow up after the training course and they have nobody to contact with questions. Many also reported that the training was quite short and they would like to have further training so that they can get a refresher on key points, and expand their knowledge.¹⁰²

► HEALTH AND HYGIENE ISSUES RELATED TO HOUSING

(+) Positive points

Indoor humidity

(+) Humidity regulation thanks to cross ventilation, vapor-permeable materials such as stone and mud masonry walls, tiles of thatch, is allowing a humidity control of inner spaces.

(-) Negative points

Fuel & smoke

(-) Close to two-third of Nepal’s population uses solid fuels such as firewood (64%) – a major contributor to indoor air pollution¹⁰³ – as a primary source of energy. As women play a significant role in the management and use of energy sources for household cooking, they are disproportionately affected by indoor air pollution¹⁰⁴. In Nepal, around 8,700 people, mainly women and children, die



Owner driven retrofitting of damaged SMM houses. Women providing the preparatory work, the skilled / paid tasks being left to men, Dadaputalibazar, 2019– ©HRRP



Training for masons, under engineers supervision: in a large proportion, men benefit from these opportunities, 2017, Dolakha– ©CRATERre



Effects of smoke on the interior walls of a kitchen, where firewood is used on an open fire, with no chimney to vent the smoke– ©CRATERre



Open kitchen to patio, using LPG as fuel, Upper Mustang, Tsarang village, 2016– ©Marie Schuiten

¹⁰¹ Mawby et Applebaum, 2018

¹⁰² HRRP, 2018

¹⁰³ Smith, K. R., Mehta, S., & Maeusezahl-Feuz, M. (2004)

¹⁰⁴ Bloomfield, E. (2015). Gender and Livelihoods Impacts of Clean Cookstoves in South Asia-Full Report

prematurely each year due to illnesses related to indoor air pollution from solid biomass fuel burning¹⁰⁵.

▾ FOR MORE INFORMATION

The gendered impacts of indoor air pollution in Nepal's Koshi basin
<https://www.icimod.org/article/the-gendered-impacts-of-indoor-air-pollution-in-nepals-koshi-basin/>

► USE AND AESTHETICS

(+) Positive points

Decorative plasters / paints

(+) Decoration of façades / protection of façades: plasters are decorative but not decoration. Their regular maintenance and renewal are part of the necessary maintenance of the houses.

Ritual procedures linked to construction

(+) The key stages of the construction are also chosen according to the favourable moments and signs. In villages of the Tamang heritage trail for instance, a local priest is consulted to decide on the day of digging foundations, setting the first stone, adding the first beam (ridge beam) of a new house.

(-) Negative points

Loss of heritage understanding

(-) Example of loss of coherency in the “fake” traditional façade of old cities such as Kathmandu or Bhaktapur. The aesthetic of the traditional construction is adopted for the front façade, using similar materials (layer of burnt bricks) and similar “patterns” but on a completely different building system, commonly a RCC frame with brick infill, regardless to the richness and complexity of this heritage. There is a risk of progressive loss of the meaning of the building practices and expression.

► ECONOMIC ASPECTS

(+) Positive points

Local construction economy

(+) The use of local raw materials (such as wood, stone, fibres, earth) implies an intensive need for skilled artisans, the balance between materials costs and labour cost is favourable to local economies. It also allows for the unskilled labour to take part to the construction process in a series of necessary tasks such as material extraction and preparation.

(-) Negative points

Training increasing the leakage of competent persons

(-) Trained masons are more likely to leave outside of the country to seek for work opportunity



“Fake” traditional “Newari façade- the façade is “plugged on a Brick masonry and RCC frame building, Bhaktapur, 2016
 ©CRAterre



Façade paintings are part of the maintenance practices and cultural identity, Geling, Upper Mustang, 2016
 ©Marie Schuiten



Façade paintings & decoration are part of cultural expression of communities, Mithali village, Terai, 2016 ©Marie Schuiten



Artisan preparing mud mortar for regular maintenance of the plasters, Mithali village near Janakpur, 2016– ©Marie Schuiten

¹⁰⁵ WHO. 2009. Country profiles of Environmental Burden of Disease, Public Health and the Environment, World Health Organization

[4.2] LOCAL BUILDING PRACTICES IN TERAI AND PLAINS

► BIOCLIMATIC COMFORT

(+) Positive points

- (+) Cross ventilation is provided inside through the use of bamboo net walls and open space under the roof.
- (+) Elevated floor allows ventilation through the floor itself, and/or prevents the humidity from the ground.
- (+) Furniture is adapted to ease ventilation: suspended” beds or kids, etc.

(-) Negative points

- (-) The increasing use of CGI roofing material without any complementary material for insulation) induces high indoor temperatures and low thermal comfort (due to high temperature radiations of the material).

► HAZARD-RESISTANT PRACTICES



(+) Positive points

- (+) Roof and awning structures and roofing material are clearly disconnected to mitigate the damages or collapse of roof in case of high winds;
- (+) The general shape of the houses, compact, low roofs, and / or hipped roofs provide an aerodynamic shape thus limiting the stress on the structure in case of strong winds.
- (+) Tiles or straw are preferably used, which reduces the risk of the material being blown away.



(+) Positive points

- (+) Locally, high winds and hail affect the villages. To protect themselves and allow for necessary ventilation, the windows/shades are made of dense woven bamboo fencing.



(+) Positive points

- (+) In many towns and villages in the Terai, traditional ponds have also been used to retain flooding. However, these ponds are disappearing fast due to growing urbanization¹⁰⁶. These ponds are also traditionally used as earth quarries for construction.
- (+) Raised platform on hard wood stilts : In the Terai region, inundation is common due to plain terrain having low altitudes. Housing construction in this region is guided by creating a platform up to certain height (usually from 1m to 3m) which



Ventilation, humidity and temperature are regulated through the use of heavy, breathable materials (earth) and light woven materials (bamboo), Mithali village, Terai, 2016 –©Marie Schuiten



Cross ventilation, bottom ventilation and thick fiber roofing regulate the indoor humidity and temperature , Tharu village, Terai, 2016– ©Marie Schuiten



Clearly separated roofs, the use of "open" materials (thatch or tiles) reduce wind forces, and thus the risk of roof blow-off, Tharu village, Terai, 2016. –©Marie Schuiten



Village pond, part of the flood risk mitigation (to be confirmed), near Simara, Terai, 2016 –©CRAterre

¹⁰⁶ Landell Mills Limited, 2019

is unconstructed open and arrangement of the living environment is started from the first storey above the unconstructed platform.¹⁰⁷

- (+) **Mud platform:** The house is settled on a mud platform. This way the house is well protected from the risks of floods, running water and splashing from rain. If the base of the wall is not protected from water, the resistance of the mud walls is heavily reduced.
- (+) **Baseboard protection:** The base of the wall, most exposed to water erosion (surface water) and capillarity, is commonly protected by an additional layer of mud, eroded and repaired in a cyclic manner (sacrificial layer). The height of this layer (sometimes a series of layers) is given by the level of regular and/or exceptional floods. This solution is locally improved by adding stones or burnt bricks at the base of the walls, or the construction of a burnt brick plinth.
- (+) **Protection of goods :** a mezzanine or platform is available to store the most important belongings in case of rising . Elevated granaries protect the water Mezzanine for protection of goods /granaries. a ventilated tank on pads protects the reserves from humidity in general and from water in case of flooding
- (+) **Timber /RCC pillars:** Prefabricated RCC posts are used for the most exposed structural elements (replacing wood elements). Some include tie-downs to better anchor the roof structure in high winds.

(-) Negative points

- (-) Reconstruction designs are focusing on the earthquake risks, and do not take into account the flood risks.
- (-) Sun dried bricks houses built in flood prone areas are heavily impacted, of they lack from appropriate base protection. Damages can lead to complete collapse of the construction.



landslide, mudslide or Erosion

(+) Positive points

- (+) Vegetation around the constructions is reducing the erosion due to rain water
- (+) Rapid erosion of the mud walls, in particular at plinth level, is mitigated by the regular maintenance of the wall plasters, including using the same material regularly.



Fire

(+) Positive points

- (+) the flammable surfaces around the cooking space (walls and floor, and possibly ceiling/roof above the cooking element) are protected with a fire-resistant plaster, i.e., earth plaster. NB: The wooden elements are also coated, if the protection against fire is not the main objective, it participates in reducing the spread of fire.



Village pond, part of the flood risk mitigation (to be confirmed), near Janakpur, 2016 – ©Marie Schuiten



Flood protection. The basis of the walls is surrounded by a mud layer, which is cyclically eroded and repaired. Terai, 2016 – ©Marie Schuiten



Floods protection. Plinth protected with stones. Tharu village, Terai, 2016 – ©Marie Schuiten



Floods protection. RCC post, Terai 2022 – ©CRAterre

¹⁰⁷ Gautam et al., 2016



Earthquake

(+) Positive points

- (+) Flexible and light structures (timber or bamboo framed) are able to withstand seismic efforts without collapsing. The damages can be repaired in many cases
- (+) Flexible joints (e.g. wires or fibre ties) allow deformations without breaking structural elements (columns, beams).

(-) Negative points

- (-) Heavy roofing materials (clay tiles on light roof structure) may fall under major constraints and damage the roof structure, and cause injuries
- (-) Concrete slabs with large overhang on may constitute a risk in case of seismic efforts.

Validation is Under Process



Mithali village, Terai, 2016 —©Marie Schuiten

[4.3] LOCAL BUILDING PRACTICES IN MID-HILLS

► LIFESPAN, MAINTENANCE AND ADAPTATION

(+) Positive points

- (+) In the name of different occasions/festivals, people maintain their by plastering and painting using mud mortar contribute a lot in protection of wall (in particular the joints) from extreme action of rainwater, direct sunlight, frost action, etc..¹⁰⁸ This frequent maintenance increases the lifespan of adjacent building elements, providing protection from rain erosion of masonry walls, mitigating the development of pests by providing plain and clean surfaces.⁹²

► BIOCLIMATIC COMFORT

(+) Positive points**Clay plasters**

- (+) The clay plaster blocks the air circulation, improving the insulation of the building. Nevertheless, clay plasters still allow exchanges that keep air sane on the internal. They regulate humidity in the inner spaces.

► HAZARD-RESISTANT PRACTICES

**Heavy rains / storms**

- (+) Top part of the walls are carefully protected with surrounding eaves and awning
- (+) The veranda is a complementary protection for the main façade and its openings.

**Floods or flash flood**

- (+) **Masonry platform:** The house is supported by a massive base. The base and the house itself work like two independent volumes (adapted to earthquake risk too). This way the house is well protected from the risks of floods, running water and splashing from rain. If the base of the wall is not protected from water, the resistance of the stone masonry with mud mortar is heavily reduced. This large base can be used for outer activities, even in monsoon season.

**Earthquake****(+) Positive points**

- (+) **Connection of masonry walls and wooden structure:** Field assessment analysis suggest that one of the major causes of masonry disruption and, ultimately, wall collapse (specially for gable walls) is the “punch-effect” caused by the movements of the floor central beam. In order to minimize these effects, this beam is set on the masonry upon a wooden element that distributes the load of the floor evenly throughout the wall; allows the beam’s horizontal displacement, during an EQ, without “punching” the gable wall.
- (+) **Two complementary structures.** A local common practice is to use a double structure. Perimeter load-bearing masonry walls and wooden structure. In case of big damages, the second structure avoids the roof and floors from collapsing.



Stone in mud mortar house, with clay plasters, Kavrepalanchok, 2018.—©HRRP



Wind protection. Roof structure is anchored in the heavy masonry walls—
CRAterre©

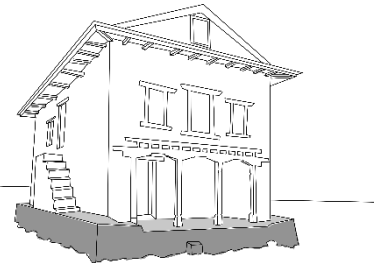

The house is settled on a massive platform, thus creating a sounder basis in case of seismic event – ©CRAterre



Heavy rains protection. Raised ground floor on a large platform, Sindhupalchok 2018
– ©CRAterre

¹⁰⁸ Khadka et Shakyia, 2016

This can give more time to people for going out from the house in case of a major seism, as the floors stand still even if part of the walls collapse. The wooden structure alone has some weakness against seismic loads because it is not braced. Therefore, it cannot stand lateral load which occurs during earthquakes.

- (+) Post / beam links. The beam is set on a piece of hard wood that allows it to come back in place in case of moves. Stability: It is more difficult for the beam to fall from the posts and loose its functions. Friction: The friction between the support and the beam dissipates energy. The deformation of the links absorbs some energy, through the friction between nails and wood and/or the deformation of iron hoops.¹⁰⁹
- (+) Flexible structures. Due to water logging problems, locally available and dampness resistant heartwood of Shorea robusta was found to be used as wooden pillar running up to the roof level. Construction in such buildings is limited to first storey only, however the gable part of houses is isolated by creating a wooden slab or slab constructed using bamboo. Such low height and weight houses constructed with timber elements have sound performance during earthquakes due to high ductility and low weight of overall construction

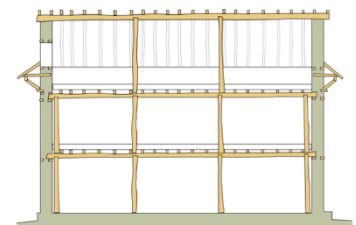
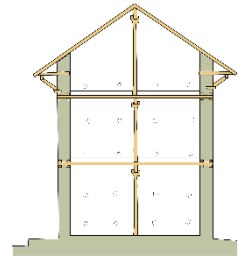

Double structure: masonry wall & inner timber structure.– ©CRAterre

► USE AND AESTHETICS

(+) Positive points

Design and Practices linked to the sacred dimension of the habitat

- (+) In each region, cultural specificities deeply orient the uses and aesthetic choices. An example is the influence of the Vastu Shastra in Hindu populations in Kathmandu Valley.
- (+) Vastu Shastra : architectural yantra. The use of mandala spatiality in the construction of houses so that they are functional as well as microcosmic _places to carry out worldly life as well as to know the fundamental reality it obscures _ is elaborately codified in the Hindu architectural texts, the Vastu Shastra, which sets out a comprehensive architectural design and construction system for all built forms including individual residences, temples, neighbourhoods, villages and entire cities. [...] They cover all aspects – architectural and functional as well as sacred and ritual- of the building process: selection of an architect and the team of craftsmen builders, selection of the site, calculation of the auspicious time for the various deities resides, design of the building or settlement and its surrounding area, choice of building material, stages of the construction process itself, and the rituals consecrating the site before construction and completing the building. [...] ...Kholagaun Chhetris ü... do not deliberately plan, consciously conceptualize, or verbally describe their houses as mandalas. Instead, they are “vastu architects” by conventional practices rather than by intentional design, buiding both their lifeworlds and the spaces for it through the everyday use of their houses. They produce their houses as mandalas in the way they orient them auspiciously in therms of the cardinal directions and organize them into a series of concentric zones of increasing purity and vulnerability to the dangers outside their compounds.¹¹⁰

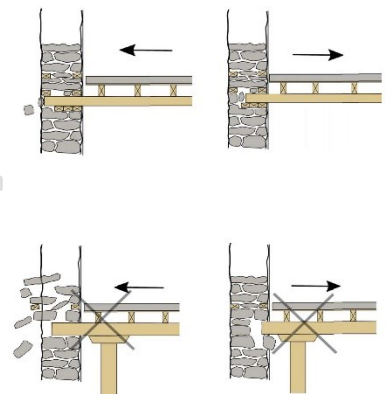

Connection of the wooden structure and the masonry walls , possible options– CRAterre©



Capital for the support of timber beams, allows lateral displacements without structural disorder, Dolakha, 2105– CRAterre©

¹⁰⁹ Ferreira, Hosta, Le Gall, 2015

¹¹⁰ Gray, 2006

[4.4] LOCAL BUILDING PRACTICES IN MID MOUNTAINS

► LIFESPAN, MAINTENANCE AND ADAPTATION

(+) Positive points

“Impermanence” concept in the Tibetan Buddhism

- (+) It has been observed after 2015 that despite of the framework developed to promote retrofitting of damaged structures, very few households adopted this strategy. The concept of impermanence brings Buddhist communities to cyclically completely replace monument (there are examples of centuries old monument thrown to the bottom of a river) instead of repairing them. A hypothesis is that this concept influences the choices of affected populations after an EQ to repair, retrofit or completely destroy and rebuild their house.

(-) Negative points

- (-) Low adoption of repair and retrofitting solutions.

► BIOCLIMATIC COMFORT

Cool temperate climate

(+) Positive points

- (+) Settlements in cool temperate climate are denser than those in warm temperate hills. The settlements of the Tamang tribe are compactly built. Several houses are typically attached to each other reducing the exterior wall surface exposed to the coldness.¹¹¹
- (+) Traditional houses in this climate zone have a more elongated form than those in colder alpine climate. Tamang houses in Langtang region have a compact rectangular shape¹¹². Being attached to each other they create a more elongated building volume. If possible, the longer façade is oriented towards the sun to enhance solar gains. The houses of the Sherpa tribe in Khumbu village (Everest region) stand in small groups together on the slopes of a natural amphitheatre. Their elongated building volume is generally standing parallel to the slope. Ground floors are partly built into the slope of the hill of mountain behind it.
- (+) The internal vertical space arrangement of these houses leads to thermal buffer zones which have an insulating effect to keep the main living room as warm as possible.
- (+) Semi-open spaces also play an important role in Nepal’s traditional architectures in cool temperate climate. In front of Sherpa houses an open space or yard is foreseen where newly harvested crops are spread out for drying, are sorted and graded prior to storage and firewood is piled up for winter month [17]. The porch located at the entry to a Tamang house also serves as a protected semi-open space. These semi-open spaces provide another comfortable place, e.g. in winter when the sun is shining.



Compact Row housing settlement, Gatlang, Rasuwa, 2023 —©CRAterre



Settlements are organised to optimize solar radiation (other façades are completely blind, built with thick dry stone masonry walls. Semi opened spaces are used for domestic and agricultural activities. Gatlang, Rasuwa —©solidarité Langtang



The houses are usually built on horizontal terraces where groups of three to five detached houses are located. The slope does not favor façades facing south, so the main openings in the houses face to the southeast, with ample space between one row and another, permitting solar gains —© ASF Nepal

¹¹¹ Data based on study on Langtang (Rasuwa) and Khumbu (Solukhumbu) villages

¹¹² So as in the Tamang heritage Trail

Alpine climate

(+) Positive points

- (+) Vernacular houses in Alpine climate have several more features to protect from the coldness than houses in the other climates of Nepal. Settlements and building volumes are compacter and denser than in temperate climates.
- (+) The houses have far smaller and less openings in order to reduce heat losses. The internal space arrangement is optimized to create thermal buffer zones. The use of window shutters has the effect to increase the tightness of the building. Roofs are flat as far less rain is falling than in cool temperate climate.
- (+) The buildings have a high thermal mass that help to balance large diurnal temperature range between the season and in summer. Semi-open spaces like the sunny flat roof top, wind protected veranda and courtyards play an important role to provide comfortable areas for all kind of household activities during the day. The main objective is to reduce heat losses during long and cold winter season¹¹³.
- (+) Building form and orientation. Compact building volumes with rectangular building shapes are dominant in Nepal's Alpine climate region. Many houses in Manang have an almost square ground floor plan. The compact building form reduces the surface-to-volume ratio and, thus, heat losses in this cold climate. Houses are situated on the southern slope of hills or flat valleys to enhance solar heat gains. In this way the high thermal mass of the building can be heated by the strong solar radiation during the day. In Manang closed courtyards are widely used to protect from the cold and strong winds. In Mustang narrow streets and high walls around the buildings marking the pathways have the same function. Other semi enclosed areas like terraces or rooftops are sometimes covered by overhangs or porches to give shade for the strong summer sun.¹¹³
- (+) Space arrangement. The space arrangement within these houses is mainly organized vertically. The ground and top floor are assigned to secondary use and have the effect of thermal buffer to keep the main living area in the first floor as warm as possible (Figure 15). Animals are housed in the ground floor leading to increased indoor temperature due to their body heat. The main living area in the second floor is horizontally also surrounded by rooms of secondary use like storage, family treasure, etc. that are creating horizontal thermal buffer zones. In some houses the upper floor contains also a prayer room or a sleeping room for summer.¹¹⁴

► HAZARD-RESISTANT PRACTICES



Strong winds or cyclone



cyclone

(+) Positive points

- (+) Clustered settlements of compact row-houses are located and oriented according to the main wind exposure to reduce the efforts on the houses.



House between Muktinath and Kagbeni. The shape of the house, embedded in the slope, limits the risks of landslides and avalanches, thus offering an optimal facade facing the sun and a minimum of other openings. 2013– ©Mathilde Chamodot



Settlement in the village of Manang. Minimum openings in massive stone walls, 2013– ©Mathilde Chamodot



House in the village of Manang. Minimum openings in massive stone walls, 2013– ©Mathilde Chamodot

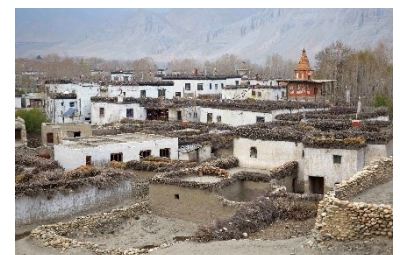

Settlement Lo Manthang. Courtyard houses are adopted, including for wind and cold protection, Upper Mustang, 2016– ©Marie Schuiten

¹¹³ Bodach et al., 2014

¹¹⁴ Bodach et al., 2014



landslide, mudslide or Erosion

(+) Positive points

- (+) Slopes are covered with rubble stone in upper Mustang, most probably to reduce the speed of running water, and its erosion effects. Retaining walls delimitate the settlement and field terraces



Earthquake

(+) Positive points

- (+) Friction: in drystone masonry walls, with wooden structure, the friction between wood and stones is high (so as the friction between the stones), allowing a good dissipation of energy.
- (+) The shape of the walls, with thicker base is increasing the stability of the overall structure.

(-) Negative points

- (-) The sharing of a common wall, in an incremental building strategy leads to poorly connected structures, or unbalanced shapes ("L" shaped walls)
- (-) Reconstruction of row-houses requires consensus among many owners. Without clear coordination, or if a different strategy is adopted by neighbours in the same cluster, a heterogeneous cluster is produced, with probably incompatible building systems (for instance RCC frame houses in between dry stone masonry/ wooden structures). As a result, the behaviour of the "altered" or "modified" cluster is dangerous.



Inner wooden structure, Tsarng village, Upper Mustang, 2016 – ©Marie Schuiten

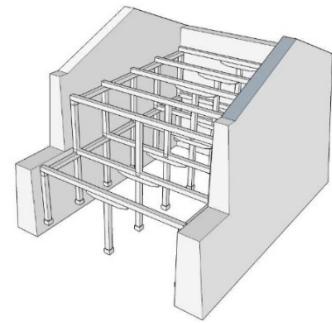

Double structure - drystone masonry walls and timber structure - collaborate in the Tamang heritage trail architectures – ©CRAterre

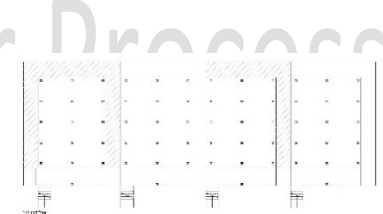

Row houses, built in an incremental way, resulting in barely connected "I" shaped walls, the Tamang heritage trail – ©CRAterre



Stone retaining walls consolidating the field and settlement terraces ©Marie Schuiten



Dry stone masonry walls, with thicker base for stability. Detail from house documentation, Gatlang, Rasuwa, 2018 – ©CRAterre

[4.5] LOCAL BUILDING PRACTICES IN URBAN AREAS & KATHMANDU VALLEY



Earthquake

(+) Positive points

- (+) A typical Newari House is set in a well-populated community called "Tol". These houses are stacked to create blocks around a central layer courtyard called Chowk. Each house inside Chowk holds an almost similar pattern and architectural style. The regular shape of such settlements provide seismic resistant whole (if not altered).
- (+) Flexible joints in Newari architecture. The traditional method of construction, which does not use metal with timber has prevented degradation for a long time. This type of construction should be repaired using traditional methods without resorting to modern methods. This traditional construction method resist motion throughout the structure during earthquakes.
- (+) Open spaces are used for refuge during earthquake disaster. Courtyards are also playing an important role for cultural /social / everyday life purposes.

(-) Negative points

- (-) The condition of mud masonry houses, especially in the old historical cities like Kathmandu, Bhaktapur and Lalitpur were miserable both before (see Figs. 13–16a) and after 2015 Gorkha earthquake (see Figs. 13–16b). The houses were old (aged materials) with several cracks and defects but including minimum or no periodic maintenance before the earthquake. In addition to this, the masonry houses were further modified into irregular forms like haphazard expansion in height, adopting mixed masonry units and mortar, etc.⁹²
- (-) The urban development is a risk for the public open spaces.
- (-) The extensions (vertical mainly) of existing houses can lead to hazardous situations at house level, so as at *tole* level



Vertical extensions and hybridation of the building typologies, Patan 2016 – © CRAterre

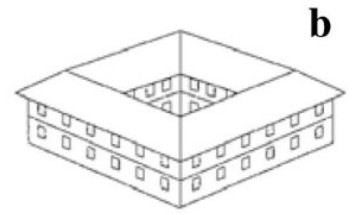

Housing pattern organised around a courtyard or *Chowk*. Its regular form and homogeneity is adapted to the seismic risks ©



Erosion of bais of burnt bricks due to capillarity/ lack of proper drainage, Bakhtapur, 2016 ©CRAterre

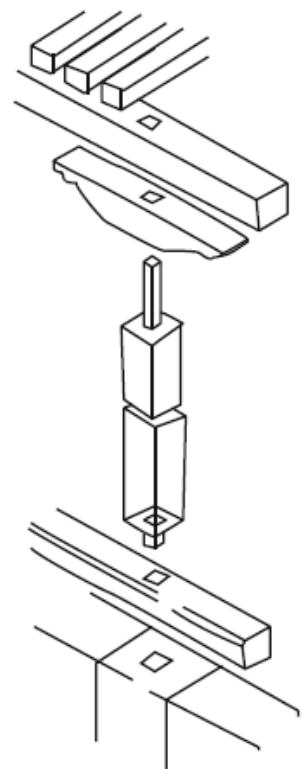

Flexible timber technology in Newari architecture – ©Toffin

[4.6] IMPROVABLE BUILDING PRACTICES AND RECOMMENDATIONS

Environment

Site selection

Mid-mountain settlements are at high risk of landslides. In many areas, past earthquakes have triggered destructive landslides or avalanches. While these risks are generally identified by the inhabitants of the most exposed areas and have largely influenced the location and shape of settlements, recent changes and climate change make it necessary to reassess the risks, update the maps and inform the population. Reconstruction after the Gorkha earthquake in 2015 forced many people to move from their former plots, for example from dense urban areas to suburban cultivated fields. There, houses are more exposed to flooding.

In Terai, flood risk mapping is part of the DRR priorities.

Knowledge and know-how

The introduction of technologies considered more appropriate in the recent reconstruction strategy, e.g. the change from wooden to light metal structures, risks losing the specific knowledge and know-how of craftsmen, but also of the inhabitants who maintain their houses. This is also the case for the transition from thatched roofs to CGI roofs, the transition from earthen plasters or binding mortars to cement mortars, stone works to brick or cement blocks masonry, etc.

These techniques could coexist for their specific and complementary uses. It is therefore necessary to recognise the value of this knowledge and know-how and to facilitate their transfer and sharing.

Foundation, basement and walls

Recent assessments have pointed an urgent need to improve existing constructions, including a wide range of building technologies, including mud-bonded masonry. Shallow foundation i.e. 1' to 2' using mud mortar and insufficient provision for drainage was one of the major causes for failure of foundation¹¹⁵.

The use of a damp proof course is not the norm (rarely observed), neither for stone in mud masonry walls, nor for earth masonry walls, nor for fired bricks walls. This increases the fragility of the base of the walls observed (rapid degradation of masonry bricks, including fired bricks).

↳ FOR MORE INFORMATION

CORRECTION / EXCEPTION MANUAL FOR MASONRY STRUCTURE

link https://www.nepalhousingreconstruction.org/sites/nuh/files/2017-06/correctionManual_.pdf

Masonry quality

Haphazard composite use of masonry units like bricks (burnt and unburnt) and stones. Such problems are mostly seen in Bhaktapur, Thankot and Dhulikhel. Haphazard uses of burnt and unburnt bricks are common in all these places. But in some portions of

¹¹⁵ Khadka et Shakya, 2016

Thankot and Kavrepalanchowk, haphazard composite use of stone and bricks were seen. Due to the differences in size and shape of units, the bonding between walls is inadequate. Such type of mixed structural units and systems results in variable wall strength and stiffness in different parts of a building. So, such practice should be avoided. Normally, it is acceptable to mix materials if only one type of material in one storey and in another storey another type of material can be used. For the strength of the building, the stronger materials should be used for the ground floor wall construction.¹¹⁵

In urban contexts such as Bhaktapur, Kathmandu or Lalitpur, a common practice is to use sundried bricks for the inner wall and burnt bricks for the outer face of the wall, with poor or no connection of the 2 elements.

Use of un-coursed random rubble stone masonry, un-coursed semi-dressed stone masonry and dressed stone masonry in different places of Nepal like Dolakha, Sindhupalchok, Thankot, Sindhuli, Langtang, Palpa, Chisapani, Nagarkot etc. Among which random rubble walls were common. These walls are generally made of uneven stone and are laid on either weak soil or mortar bedding. Under the heavy seismic shaking, the tensile strength of the mortar (and rubble) easily exceeds, and walls are bulged or totally collapsed. Mortar in dressed stone masonry walls is usually of poor quality, however the seismic resistance is superior compared to other types of stone masonry due to frictional forces between adjacent stones¹¹⁵

Single wall in row housing

Common sharing of single wall in row housing. This led overburden to facade and rear wall as a result buckling, cracks are seen due to extreme stress in the wall. In addition, the old attached house might collapse during construction of new house aside.¹¹⁵

Unsymmetrical position and sizes of openings in the same building is critical (torsion failure) and commonly observed. Large ground floor openings (ground floor being used for commercial uses) also induce instability of the overall structure of buildings.

Unequal elevation in the row housing was also seen in some case which is critical during lateral load i.e. houses collapse due to hammering or pounding effect.¹¹⁶

Floors

Special care should be given to the overall behaviour and coherency of buildings.

The majority (about more than 96%) of mud-bonded masonry buildings have flexible floor system. Generally, it is constructed using wooden joists spanning one or two directions, above which wooden or bamboo strips are placed in the direction perpendicular to the joists and a thick mud layer is used as floor finishing. But at present, the number of storey of buildings is increased and due to easy availability of modern materials, the rigid floor system, i.e., the concrete floor is adopted in the new upper storey due to which mixed floor system are found in most of the old brick. The adoption of mixed floor system i.e. flexible floor and rigid floor system creates unequal stiffness in different floor as a result building fail under lateral load.¹¹⁶

Roofing

¹¹⁶ Khadka et Shakya, 2016

Most of the masonry houses have sloped (around 15–30°) roof with timber or bamboo as structural members, and varying roof coverings like clay tiles in Kathmandu valley, wooden shingles in cold regions, stone tile in other hilly regions, concrete tiles in terai regions and some part of hilly regions, thatch roof in hilly regions (except valley houses) and terai regions, Corrugated Galvanised Iron (C.G.I.) sheet commonly found in all regions. Masonry houses of Kathmandu valley have modified sloped roof into flat RC roof at the time of increasing floor numbers openings.¹¹⁷

Wood treatment

No particular wood treatment methods were identified, since traditionally, construction works used locally available hard wood, that wouldn't require further specific treatment than seasoning (cutting at the good season and proper drying procedures). Recently, with the scarceness of hard wood, soft wood has been employed in construction, but the inherent treatment that this type of wood requires has not yet been integrated in current local practices, so the wooden elements of the buildings quite exposed to possible deterioration through moisture and/or insect attacks. Nevertheless, some traditional treatment methods could be enhanced, to achieve wood treatment levels adjusted to the quality of the available wood. Further studies are required to measure their effectiveness. Likewise, other treatment methods could be applied such as the ones using boron solutions - keeping the execution/resources/price at affordable levels and maintaining acceptable health/safety standards during the handling of the products, the execution of the treatment, and the effects of having the treated elements inside the house (vaporious toxicity, etc.)¹¹⁸

Retrofitting

The house stock in need of retrofitting is huge and a large-scale retrofitting program is considered a priority for the reduction of risks a country level.

Retrofitting techniques are documented and promoted on the low-strength masonry building, but the recent experience of the post-earthquake reconstruction has demonstrated very little interest/trust in these techniques. The main tested and documented retrofitting techniques are¹¹⁹:

- Wall jacketing
- RC splint-bandage with GI wire jacketing
- Insertion of seismic bands or shear bands
- Wooden splint-bandage
- Wall jacketing using PP mesh and mud plaster
- Addition of cross walls and buttress
- Vertical nylon straps

FOR MORE INFORMATION

REPAIR AND RETROFIT MANUAL FOR MASONRY STRUCTURES
link <http://nra.gov.np/uploads/docs/wNc1x7Sk62210221050749.pdf>

¹¹⁷ Khadka et Shakya, 2021

¹¹⁸ Ferreira Mendes, Miguel, Hosta, Julien, Le Gall, Olivier, 2015

¹¹⁹ Hosta et al., 2020



Local sawmill, Magapauwa, Dolakha2017– CRAterre©



Wood treatment, onsite training, Magapauwa, Dolakha2017– CRAterre©



Retrofit demo house, Annapurna rural municipality, 2019 – HRRP©



Retrofit demo house, Annapurna rural municipality, 2019 – HRRP©



Retrofit demo house, Annapurna rural municipality, 2019 – HRRP©

[5] Projects based on local building practices

► SUPPORT TO OWNER DRIVEN RECONSTRUCTION

Many examples of houses across the country illustrate the adoption of the key messages disseminated after the Gorkha EQ, for housing solutions based on local building practices.

► RESETTLEMENT PROJECT, MUSTANG

Resettlement project lead by village committee of Thangchung Tswalhe, Dhye, Mustang, with the support of Du Bessin Nepal and Fondation Abbé Pierre. 2022-

Building system adopted: adaptation of local building practice, adobe construction.

This housing project is associated to a water management program.

<https://www.fap-learning-lab.org/fr/un-village-nepalais-deplace-et-reconstruit/>

► SURAKSHIT MAULIK GHAR

Repair & Reconstruction of Houses in 3 Earthquake Affected Districts :Dolakha, Dhading and Rasuwa¹²⁰. With the support of Carits Luxembourg, partnership ASF Nepal , Pouraki, CRAterre. Sociotechnical support provided ot households during the reconstruction of their damaged houses. Technical training including the use of local skills and capacities, local materials.

<https://www.asfint.org/en/taxonomy/term/66>

► BHARATPUR HOUSING PROJECT

Resettlement project lead by Salyani community, with the support of Lumanti and Bharatpur Municipality, Chitwan District . The houses have been built entirely by the people, showing a variety of incremental building strategies and budgets, using a variety of materials and construction systems (purchased collectively in bulk by the community committeeln addition to this, they managed to negotiate to utilize the open space opposite of their settlement for urban agriculture.

<https://lumanti.org.np/program/details/bharatpur-housing.html>



SMM house with light gable wall, 2018–
©HRRP



Demo house construction in Dhye, Mustang, 2016 – ©FAP



Demo house construction in Magapauwa, Dolhaka, 2016 – ©CRAterre

[6] Conclusions: and ways forward

► CONCLUSIONS

→ CONSIDER LOCAL STRENGTHS FOR RESILIENT PROJECTS

Nepal is inhabited by a wide variety of populations in extremely diverse territories between the Terai plains and the Himalayan villages, who have developed particularly inspiring habitat solutions. There is much to learn from this wealth to face current and future challenges. The reconstruction effort following the 2015 earthquake has brought about rapid change, as has the ongoing urbanization of the territory.

Housing improvement, hazard preparedness, and reconstruction programs have a strong interest in understanding these local intelligences to meet the challenges ahead, including a need to face climate changes, a need to “greening” or localising the response”.

The strengths of local building cultures represent an enormous potential. At each scale, the analysis of the cycles of production, use, regular maintenance or partial repairs, abandonment, and eventual recycling can produce enriching knowledge for the reverse engineering of local building cultures. In terms of methodology, participatory approaches are suggested to distinguish:

- what is very valuable and should absolutely be kept,
- what is very useful but has become difficult to apply, which implies studying the reasons for it,
- what needs to be adapted to better meet today's requirements,
- conversely, what has been modified from traditional models with negative impacts,
- what is no longer relevant or has become negative in the current context and must absolutely be "replaced".

→ TAKE (MORE) THE ENVIRONMENT INTO ACCOUNT

Housing responses increase the resource extraction for construction materials. The shelter sector should consider reforestation as a contribution for shelter solutions which will use timber responsibly.

Several aspects can be considered to improve the bioclimatic comfort: thermal inertia, ventilation, sun protection, use of materials which don't heat up unbearably, height of constructions...

→ SUPPORT LOCAL ECONOMY AND CONTINUE TRAININGS

Technical solutions that promote the circular economy, and that allow injecting most of the project funds into local economies should be preferred. If the funds remain within the local community, there will be an improvement of housing of the households supported by the sector, but also of the whole population.

Upgrading the skills of local craftsmen including women often leads to better results and to create the basis for a better overall quality of the built environment in the long term.

Training in new technologies takes time (feasibility, production, construction, design, maintenance, repair). Training should continue to be facilitated both to local artisans and inhabitants also after the reconstruction phase, to ensure the extensions or additions are compatible with the house and settlements. The reduction of available inner space per inhabitant due to the recent earthquake and the reconstruction limitations will lead the inhabitants to modify the newly built houses, with limited means.

→ EVALUATE THE IMPACT OF CONSTRUCTION TECHNIQUES CHOICES

According to CBS assessment of housing typologies and HRRP analysis of reconstruction houses (2018), Stone and Mud Mortar masonry is the main building technology applied today, and constitute a large majority of the housestock. Earth and stone are materials that can be recycled for life and can be obtained in almost all areas of the country (one or the other or both) in sufficient quantity and quality to build durable housing.

Tree or bamboo planting and forest regeneration should be considered to facilitate long-term access to wood: wood in construction is widely used and can provide safe and sustainable solutions for today and for the future. For instance: wattle and daub technique are locally mastered, mostly in Terai. It is affordable and promotes comfortable conditions in houses. This technique has other advantages such as its cultural adaptation and facility of construction and maintenance for households.

The recent switch to industrialized materials increase the need for transportation, pressure on quarries (for the production of burnt bricks and cement concrete namely), and higher construction costs. Their use should be optimised and combined with local materials to reduce the impact on humans and their environment.

→ ANALYSE & INCLUDE SOCIAL AND CULTURAL ASPECTS RELATED TO HOUSING

Self-help systems have historically been practiced and still is, including in construction. People can help each other build through mutual aid systems

Security of tenure, access to finance or information are not even for the different categories of people, depending on their ethnicity, caste, region of origin poverty level, religious beliefs. Nonetheless, across all ethnic groups and castes, the patrimonial nature of the social system, inheritance rules, and the traditional gender-based division of labor severely restrict women's access to education, skill development, employment opportunities outside the home, and decision-making processes.

→ SITE SELECTION & ACCESS TO BASIC SERVICES

Choice of the construction site regarding risks should include local knowledge, can benefit from historical data, in a strong coordination with local authorities.

Consider the specific risks, including the different flood typologies associated risks, is a key to promote more resilient housing solutions. Multi-hazard consideration is essential.

Access to water remains a main challenge strongly linked with the shelter and settlement sector. Nepal has very low water security, many people do not have a sufficient access to water for their domestic, agricultural and industrial needs. Urban water insecurity is a major emerging issue and is further complicated by issues of water pollution and solid waste management.

Access so safer energy for cooking should be a priority to improve the safety of housing: around 8,700 people, mainly women and children, die prematurely each year due to illnesses related to indoor air pollution from solid biomass fuel burning.

Validation is Under Process

► WAYS FORWARD

The final draft of this document has been presented to the Nepal Shelter Cluster (SC) team and members in June 2023, in Kathmandu. Here is a series of remarks and recommendations expressed, and tracks for next steps.

- This document is an ongoing process, with its limitations. Shelter Cluster members, including government officials, practitioners and academics are warmly invited to suggest improvements in a revised or expanded edition. Gaps have been identified in the document. Face to face meetings, regular sharing of information and field surveys are preferred than secondary data collection and remote support for a more collaborative work.
- This document belongs to the Shelter Cluster of Nepal. Government approval is essential. There is still a need to share the objectives and possible uses of the Shelter Response Profile with Shelter Cluster members. Clarification is requested on how the data presented can support the shelter response.
- In order to highlight the content of the document, SC members suggest a change of title like: Shelter/housing profile, shelter reconstruction profile. This document is part of a series of documents (see p3), an option is to decide for a more consensual subtitle. NB: the use of shelter is not shared by the members.
- For next versions of the document, additions or complements of the content are suggested :
 - focus on temporary or transitional shelter design;
 - available building materials mapping;
 - local technology documentation;
 - hazard / vulnerability / capacity mapping;
 - more detailed building perspective, social and cultural aspects of settlements;
 - focus on the uses of open spaces and settlement level usages;
 - include -or better refer to- detail features and designs available;
 - include learnings from 2015.
- Scientific analysis and testing of negative or positive characteristics of the building practices presented is recommended for better understanding and possible adoption

▾ GLOSSARY

CBS	Central Bureau of Statistics
DUDBC	Department of Urban Development and Building Construction
GoN	Government of Nepal
HRRP	Housing recovery and reconstruction Platform
IDMC	Internal Displacement Monitoring Centre
MOUD	Ministry of Urban Development
NDRRMA	National Disaster Risk Reduction and Management Authority
NHSRP	National Housing & Settlements Resilience Platform
NRA	National Reconstruction Authority
NRA	National Reconstruction Authority

[7] Additional resources and bibliography

► KEY CONCEPTS



Adaptive Capacity: The ability of systems, institutions, humans and other organisms to adjust to potential damage, take advantage of opportunities, or respond to consequences¹²¹.

Disaster: Severe alterations in the normal functioning of a community or a society due to hazardous physical events interacting with vulnerable social conditions, leading to widespread adverse human, material, economic or environmental effects that require an emergency response(s) to satisfy critical human needs and possibly external support for recovery¹²¹.

Exposure: The presence of people, livelihoods, species or ecosystems, environmental functions, services, resources, infrastructure, or economic, social, or cultural assets in places and settings that could be adversely affected¹²¹.

Globalised habitat: Housing is influenced by “global trends” promoted in the media, but also by industrial companies and the formal education system. Cement, steel and CI Sheets are gradually replacing traditional materials, but such changes don’t always result in real improvements. Difficulties in affording respect for norms and standards lead to compromising space quality, thermal comfort and even structural safety.

Hazard: The potential occurrence of a natural or human-induced physical event or trend or physical impact that may cause loss of life, injury, or other health impacts, damage and loss to property, infrastructure, livelihoods, service provision, ecosystems and environmental resources¹²¹.

Local building cultures: A building culture is the intangible dimension of what is produced by humans to live, work, thrive, etc.. It includes assets related to each phase of the building life cycle: design, construction, use(s), maintenance, replacement, extension, adaptation, etc., that are linked to social, economic, environmental and cultural aspects. The genesis and evolution of building cultures are closely linked to their environment and the specific history of each territory. This is why they are so diverse worldwide and why several building cultures can co-exist within a single territory.

Precarious habitat: This covers different realities depending on the factors that generate it: economic difficulties, climate change, disasters or armed conflicts. It characterises houses or shelters built by low-income families or those who, without a land property title, prefer to limit their investment by choosing light structures that are easy to dismantle or repair.

Resilience: The capacity of social, economic and environmental systems to cope with a hazardous event or trend or disturbance, responding or reorganizing in ways that maintain their essential function, identity and structure while also maintaining the capacity for adaptation, learning and transformation¹²¹.

Risk: The potential for consequences where something of value is at stake and the outcome is uncertain. Risk is often used to refer to the potential for adverse consequences on lives, livelihoods, health, ecosystems and species, economic, social and cultural assets, services (including environmental services) and infrastructure.

Vernacular habitat: It is characterised by using local resources to respond to people's needs, way of life and local climate. It results from reproductions, improvements and ongoing adjustments or adaptations over time and often includes external inputs and imported solutions, though rather parsimoniously. Such constructions often rely on strong links between the inhabitants, their families and neighbours, and their persistence facilitates housing accessibility, pride and feelings of belonging within the community.

Vulnerability: The propensity or predisposition to be adversely affected. Vulnerability encompasses a variety of concepts and elements, including sensitivity or susceptibility to harm and lack of capacity to cope and adapt¹²¹.

¹²¹ (IPCC, 2014), AR5 Synthesis Report: Climate Change 2014

► **CONSULTED SOURCES TO PRODUCE THIS DOCUMENT (TO BE COMPLETED)**

- ADHIKARI, Nripal, 2016. « Vernacular architecture in post-earthquake Nepal ». In : International Journal of Environmental Studies. 15 juin 2016. Vol. 73, p. 1-8. DOI [10.1080/00207233.2016.1179011](https://doi.org/10.1080/00207233.2016.1179011).
- ADHIKARI, Rohit Kumar, D'AYALA, Dina, [s.d.]. « NUMERICAL SEISMIC PERFORMANCE ASSESSMENT OF PRE-EARTHQUAKE STONE MASONRY RESIDENTIAL BUILDING TYPOLOGY IN LIGHT OF 2015 NEPAL EARTHQUAKE ». In : . p. 11.
- AVIS, William, 2018. « Livelihood options for households in Nepal ». In : . 23 février 2018. p. 31.
- BAJRACHARYA, Gyanendra, 2011. « Major Highlights ». In : . 2011. p. 13.
- BHATTARAI, Sundar, 2006. « The Bola or Parma of the Newar in Manamaiju Village ». In : . 2006. p. 85.
- BHOCHHIBHOYA, Silu, ZANETTI, Michela, PIEROBON, Francesca, et al., 2017. « The Global Warming Potential of Building Materials: An Application of Life Cycle Analysis in Nepal ». In : Mountain Research and Development. février 2017. Vol. 37, n° 1, p. 47-55. DOI [10.1659/MRD-JOURNAL-D-15-00043.1](https://doi.org/10.1659/MRD-JOURNAL-D-15-00043.1).
- BONAPACE, Caterina, SESTINI, Valerio, 2003. Traditional materials and construction technologies used in the Kathmandu Valley [en ligne]. Paris : UNESCO. 165 p. Disponible sur : < <http://www.mbs-architecture.com/nepaltradbuildmat.pdf> > (consulté le 5 septembre 2022).
- BRACKEN, Louise, 2018. Evolving narratives of hazard and risk: the Gorkha earthquake, Nepal, 2015. New York, NY : Springer Berlin Heidelberg. 192 p. ISBN 978-3-319-65210-8.
- CENTRAL BUREAU OF STATISTIQUES, GoN, 2021. Nepal in Figures 2021 [en ligne]. [S.I.] : [s.n.]. Disponible sur : < <https://cbs.gov.np/wp-content/uploads/2021/07/Nepal-in-Figures-2021-Final.pdf> >
- CHANDA GURUNG GOODRICH, ABID HUSSAIN, BINAYA PASAKHALA, KOSAR BANO, SANJEEV BHUCHAR,, VISHWAS SUDHIR CHITALE, SUMAN BISHT, ADITYA BASTOLA, AND SIMRAN SILPAKAR, 2022. state of gender equality and climate change in south Asia and the Hindu Kush Himalaya [en ligne]. [S.I.] : [s.n.]. Disponible sur : < file:///C:/Users/DELL%20E7450/Downloads/HimalDoc2022_StateOfGenderEqualityInSAandHKH-r.pdf > (consulté le 18 octobre 2022).
- DALY, Patrick, BARENSTEIN, Jennifer Dwyne, HOLLENBACH, Pia, et al., 2017. « Post-disaster housing reconstruction in urban areas in Nepal ». In : . 2017. p. 32.
- DEKENS, J., 2007. « Local Knowledge for Disaster Preparedness: A literature Review ». In : [en ligne]. 2007. Disponible sur : < https://www.academia.edu/9672185/Local_Knowledge_for_Disaster_Preparedness_A_Literature_Review > (consulté le 18 octobre 2022).
- EATON, David J., JOSH, Niraj Prakash, 2018. Post-Earthquake Home Reconstruction in the Surrounding Hills of Kathmandu Valley, Nepal, PRP 200 [en ligne]. Austin : The University of Texas. 49 p. Disponible sur : < <https://core.ac.uk/outputs/211340507> > (consulté le 5 septembre 2022). ISBN 978-0-89940-828-6.
- EWAN BLOOMFIELD, 2014. Gender and Livelihoods Impacts of Clean Cookstoves in South Asia Study [en ligne]. [S.I.] : [s.n.]. Disponible sur : < <https://cleancooking.org/binary-data/RESOURCE/file/000/000/363-1.pdf> >
- FERREIRA MENDES, MIGUEL, HOSTA, JULIEN, LE GALL, OLIVIER, [s.d.]. « Technical guide for master trainers: earthquake resistant buildings using local materials in Dolakha, Ramechhap and Sindhuli – Nepal ». In : CRAterre [en ligne]. Disponible sur : < <https://craterre.hypotheses.org/1099> > (consulté le 26 septembre 2022).
- GAUTAM, Devraj, CORTÉS, Gustavo, 2021. « Reconstruction assistance in rural Nepal after the 2015 Gorkha Nepal earthquake through Aarma Parmah approach - A case study in Bijulikot, Ramechhap District ». In : Progress in Disaster Science. avril 2021. Vol. 10, p. 100148. DOI [10.1016/j.pdisas.2021.100148](https://doi.org/10.1016/j.pdisas.2021.100148).
- GAUTAM, Dipendra, PRAJAPATI, Jyoti, PATERNO, Kuh Valencia, et al., 2016. « Disaster resilient vernacular housing technology in Nepal ». In : . 2016. p. 14.
- GRAY, John, 2009. « Where Truth Happens: The Nepali House as Mandala ». In : Anthropologica. 2009. Vol. 51, n° 1, p. 195-208.
- HABITAT FOR HUMANITY NEPAL, 2021. Research Report on Shelter&housing pre-crisis market analysis (S-PCMA). [S.I.] : [s.n.].
- HASEGAWA, Shuichi, DAHAL, Ranjan Kumar, YAMANAKA, Minoru, et al., 2008. « Causes of large-scale landslides in the Lesser Himalaya of central Nepal ». In : Environmental Geology. 2008. Vol. 57, n° 6, p. 1423.
- HOSTA, Julien, GARNIER, Philippe, SIEFFERT, Yannick, et al., 2020. State of knowledge and identification of research priorities for the scientific validation of disaster resistant building cultures of the Himalayan regions of Nepal : Research report [en ligne]. Research Report. [S.I.] : CRAterre ; AE&CC ; CDP Risk. Disponible sur : < <https://hal.archives-ouvertes.fr/hal-03116968> > (consulté le 2 septembre 2022).
- HRRP, 2017. « clearing away the rubble. Moving Beyond Blockages to Reconstruction Progress. » In : [en ligne]. novembre 2017. Disponible sur : < https://www.preventionweb.net/files/63761_y02v1th5sw1mngcdvfuo20171124.pdf > (consulté le 2 septembre 2022).
- IRM, 2019. « Aid and Recovery in Post-Earthquake Nepal Independent Impacts and Recovery Monitoring Phase Qualitative Field Monitoring ». In : [en ligne]. novembre

2019. Disponible sur : < https://asiafoundation.org/wp-content/uploads/2021/03/IRM-Nepal_Aid-and-Recovery-in-Post-Earthquake-Nepal-Qualitative-Field-MonitoringNovember-2019_EN.pdf > (consulté le 26 septembre 2022).
- KHADKA, Binod, JIANG, Huanjun, 2019. « Mud Masonry Houses in Nepal: A Study Based on Reconstruction Work after 2015 Gorkha Earthquake ». In : . 2019. p. 10.
- KHADKA, Binod, SHAKYA, Manjip, 2021. « Seismic characteristics of unreinforced mud masonry houses in Nepal: A miserable scenario before and after 2015 Gorkha (Nepal) earthquake ». In : Engineering Failure Analysis. juin 2021. Vol. 124, p. 105308. DOI [10.1016/j.engfailanal.2021.105308](https://doi.org/10.1016/j.engfailanal.2021.105308).
- LANDELL MILLS LIMITED, 2019. Nepal: Flood Risk Sector Assessment TA 9634-REG: Strengthening Integrated Flood Risk Management [en ligne]. [S.l.] : [s.n.]. Disponible sur : < <https://www.adb.org/sites/default/files/project-documents/52014/52014-001-dpta-en.pdf> >
- LUMANTI SUPPORT GROUP FOR SHELTER, 2000. « The water supply and sanitation situation of the urban poor in the kthmandu valley. results of research study ». In : [en ligne]. 2000. Disponible sur : < <https://www.ircwash.org/sites/default/files/WSP-2000-WaterKathmandu2.pdf> > (consulté le 7 décembre 2022).
- MARIJN CANDEL & JESSE VAN HASSEL, 2020. Nepal under water. A flood resilient concept design for the inhabitants of Nepal. [S.l.] : [s.n.].
- MAWBY, Briana, APPLEBAUM, Anna, 2018. « Rebuilding Nepal: Women's Roles in Political Transition and Disaster Recovery ». In : . 2018. p. 62.
- NEPAL, Santosh, NEUPANE, Nilhari, BELBASE, Devesh, et al., 2021. « Achieving Water Security in Nepal Through Unravelling the Water-Energy-Agriculture Nexus ». In : International Journal of Water Resources Development. 2 janvier 2021. Vol. 37, n° 1, p. 67-93. DOI [10.1080/07900627.2019.1694867](https://doi.org/10.1080/07900627.2019.1694867).
- OHSUMI, Tsuneo, MUKAI, Yoichi, FUJITANI, Hideo, 2016. « Investigation of Damage in and Around Kathmandu Valley Related to the 2015 Gorkha, Nepal Earthquake and Beyond ». In : Geotechnical and Geological Engineering. août 2016. Vol. 34, n° 4, p. 1223-1245. DOI [10.1007/s10706-016-0023-9](https://doi.org/10.1007/s10706-016-0023-9).
- PANTHI, Gaurav Kumar, BAJRACHARYA, Animesh Raj, KHANAL, Rajib, et al., 2021. « Types and Sizes of Structures in Rural Housing Reconstruction in the Socio-Economic Context of Nepal ». In : . 2021. p. 16.
- PIERIS, Anoma, 2018. « Cultural Landscapes of South Asia: Studies in Heritage Conservation and Management ». In : Fabrications. 4 mai 2018. Vol. 28, n° 2, p. 282-285. DOI [10.1080/10331867.2018.1446257](https://doi.org/10.1080/10331867.2018.1446257).
- PRADHAN, Rajendra, SHRESTHA, Ava, 2005. « ETHNIC AND CASTE DIVERSITY ». In : . 2005. p. 32.
- RIJAL, H.B., YOSHIDA, H., UMEMIYA, N., 2010. « Seasonal and regional differences in neutral temperatures in Nepalese traditional vernacular houses ». In : Building and Environment. 1 décembre 2010. Vol. 45, n° 12, p. 2743-2753. DOI [10.1016/j.buildenv.2010.06.002](https://doi.org/10.1016/j.buildenv.2010.06.002).
- SHRESTHA, Bijaya K., 2010. « Housing provision in the Kathmandu Valley: Public agency and private sector initiation ». In : Urbani izziv. 2010. Vol. 21, n° 2, p. 85-95. DOI [10.5379/urbani-izziv-en-2010-21-02-002](https://doi.org/10.5379/urbani-izziv-en-2010-21-02-002).
- SHRESTHA, Santosh, 2012. « Understanding the costs and benefits of DRR under changing climate conditions ». In : ISET [en ligne]. 2012. Disponible sur : < https://www.academia.edu/3565848/Understanding_the_costs_and_benefits_of_DRR_under_changing_climate_conditions > (consulté le 30 septembre 2022).
- SINGH, Pradeep, 2016. « Policy Intervention to Reduce Energy Consumption and Mitigate Environmental Emission in Cement Industries of Nepal ». In : International Journal of Environmental Protection and Policy. 2016. Vol. 4, n° 2, p. 34. DOI [10.11648/j.ijepp.20160402.12](https://doi.org/10.11648/j.ijepp.20160402.12).
2010. « Nepal: Urban Housing Sector Profile | ALNAP ». In : [en ligne]. 2010. Disponible sur : < <https://www.alnap.org/help-library/nepal-urban-housing-sector-profile> > (consulté le 21 septembre 2022).
- [S.d.]. « Independent Impacts and Recovery Monitoring (IRM) Project Nepal - Early Findings from Round 5 ». In : The Asia Foundation [en ligne]. Disponible sur : < <https://asiafoundation.org/publication/independent-impacts-and-recovery-monitoring-irm-project-nepal-early-findings-from-round-5/> > (consulté le 26 septembre 2022).
- [S.d.]. « Nepal earthquake: a rapid review of the response and a few lessons learnt | SRP_CRATerre | Zotero ». In : [en ligne]. Disponible sur : < https://www.zotero.org/groups/4514738/srp_craterre/collections/CTFM7X8X/items/WQ5BZ9QE/collection > (consulté le 6 septembre 2022).
- [S.d.]. « NEPAL SRP update meeting_20221104.pptx ». In : Google Docs [en ligne]. Disponible sur : < https://docs.google.com/presentation/d/1Bns2N2dk1dHfR9VYwQrHAdDED12M0IFN/edit?usp=drive_web&oid=104477125197199491612&rtpof=true&usp=embed_facebook > (consulté le 4 novembre 2022).
- [S.d.]. « Seismic Building Codes in the Himalaya Region Questions & Answers Related to the 2015 Nepal Earthquake | SRP_CRATerre | Zotero ». In : [en ligne]. Disponible sur : < https://www.zotero.org/groups/4514738/srp_craterre/collections/CTFM7X8X/items/P22YTKGZ/collection > (consulté le 6 septembre 2022).

Acknowledgements

DOCUMENT PREPARED BY

Julien Hosta (CRATERre)

Manish Raj Timsina (Shelter cluster Nepal)

WITH DE CONTRIBUTION OF

Abhishek Shrestha (Habitat for Humanity)

Enrique Sevillano Gutierrez & Olivier Moles (CRATERre)

Madeleine Marara (UNHCR)

Minar Tangpa Magar (NHSRP)

Reshma Shrestha, Adeel Javaid & Rupesh Shrestha (CRS Nepal)

Salena Sangacche (ASF Nepal)

Thierry Joffroy (AE&CC_ENSAG_UGA)

LANGUAGE REVIEW

xxxxx

LAYOUT

Elsa Cauderay (CRATERre)

IMAGES (IF ASKED FOR COPYRIGHT)



Images are credited to their authors



Images credited with CC have a creative commons license



This work is licensed under a [Creative Commons Attribution-NonCommercial-ShareAlike 4.0 International License](https://creativecommons.org/licenses/by-nc-sa/4.0/)

INSTITUTIONS

GLOBAL SHELTER CLUSTER

<https://www.sheltercluster.org/>

SHELTER CLUSTER NEPAL

<https://sheltercluster.org/geographic-region/nepal>

NHSRP

<https://www.hrrpnepal.org/>

CRATERRE

<http://craterre.org> / contact: secretariat@craterre.org

LABEX AE&CC / ENSAG / UNIVERSITÉ GRENOBLE-ALPES

<http://aecc.grenoble.archi.fr/>

The production of this document was made possible by funding from the GSC [DG ECHO GRANT 2021-2023](#) and from UNHCR.



Funded by
European Union
Humanitarian Aid



UNHCR
The UN Refugee Agency

The production of this document was also made possible with support from the [USAID-BHA GRANT 2020-2022](#), managed by IFRC, a co-lead agency of the GSC.



USAID
FROM THE AMERICAN PEOPLE

+C IFRC

This work was also supported by a public grant overseen by the French National Research Agency (ANR) as part of the "Investissements d'Avenir" program (reference: [ANR-10-LABX-0078](#))

anr[®]

