



**HAL**  
open science

## Smart design for CBRN protection by coupling adsorption and photocatalysis: Regeneration adsorbent efficiency-CWAs' continuous purification

Youcef Serhane, Abdelkrim Bouzaza, Dominique Wolbert, Amina Meslem,  
Aymen Amin Assadi

### ► To cite this version:

Youcef Serhane, Abdelkrim Bouzaza, Dominique Wolbert, Amina Meslem, Aymen Amin Assadi. Smart design for CBRN protection by coupling adsorption and photocatalysis: Regeneration adsorbent efficiency-CWAs' continuous purification. Chemical Engineering Journal, 2023, 471, pp.144326. 10.1016/j.cej.2023.144326 . hal-04193513

**HAL Id: hal-04193513**

**<https://hal.science/hal-04193513v1>**

Submitted on 4 Sep 2024

**HAL** is a multi-disciplinary open access archive for the deposit and dissemination of scientific research documents, whether they are published or not. The documents may come from teaching and research institutions in France or abroad, or from public or private research centers.

L'archive ouverte pluridisciplinaire **HAL**, est destinée au dépôt et à la diffusion de documents scientifiques de niveau recherche, publiés ou non, émanant des établissements d'enseignement et de recherche français ou étrangers, des laboratoires publics ou privés.

1 **Smart Design for CBRN Protection by Coupling Adsorption and**  
2 **Photocatalysis: Regeneration Adsorbent Efficiency – CWAs'**  
3 **Continuous Purification**

4 Youcef Serhane<sup>a</sup>, Abdelkrim Bouzaza<sup>a</sup>, Dominique Wolbert<sup>a</sup>, Amina Meslem<sup>b</sup>, Aymen  
5 Amin Assadi<sup>a,\*</sup>

6  
7 <sup>a</sup> Univ Rennes, École Nationale Supérieure de Chimie de Rennes, CNRS, ISCR (Institut des Sciences  
8 Chimiques de Rennes) – UMR 6226, F-35000 Rennes, France

9 <sup>b</sup> Univ Rennes, LGCGM, 3 Rue du Clos Courtel, BP 90422, 35704, Rennes, CEDEX 7, France

10 \*Corresponding author. Tel: +33(0)223238152, Fax: +33(0)223238120,

11 E-mail: [Aymen.assadi@ensc-rennes.fr](mailto:Aymen.assadi@ensc-rennes.fr)

12  
13 **ABSTRACT**

14 This investigation and optimization of the adsorption and photocatalysis coupling  
15 process for treating chemical warfare agents (CWAs) were performed with a compact  
16 cartridge based on activated carbon felt (AF) and TiO<sub>2</sub> photocatalyst deposited on  
17 luminous textiles. The target pollutants were simulants of the chemical warfare agent  
18 (yperite), methyl salicylate, diethyl sulfur (a simulant of sulfur mustard gas), and  
19 cyclohexane, which is the benchmark for type A gas filtration tests. To take better  
20 advantage of this new configuration, an optimization of the photocatalytic process  
21 was highlighted with an improvement of the regeneration process by implementing  
22 the integrated compactness of desorption by the Joule effect (*in situ*). In the case of  
23 methyl salicylate treatment, the recovery of the adsorption capacity of the AF were  
24 about 95% and a working time of 85% compared to initial adsorbent performance.  
25 For the second cycle regeneration, the recovered adsorption capacity was about 88%

26 compared to initial capacity. We note also that the working time decrease by 15% for  
27 each regeneration step. The evaluation of the new coupling configuration aimed at  
28 highlighting the influence of a sulfur compound was encouraging, with a regeneration  
29 rate of the adsorbent of about 80%. Compared to MS, the regeneration seems to be  
30 more difficult. This is due to by-products ( $\text{SO}_2$ , MSH) formation which is highlighted  
31 by the degradation pathway proposed. The removal efficiency of the coupling system  
32 (UV-LED/AF) under continuous process, was equal to 36%. This leads an increase in  
33 filter working time of 50 min over that of a conventional adsorption process. Special  
34 attention was paid to validating the coupling system performance in real conditions.  
35 The system was placed on a humanlike seated thermal manikin used to simulate an  
36 occupant of a chamber of  $30 \text{ m}^3$  with the realistic condition of applying chemical,  
37 biological, radiological, and nuclear (CBRN) agent protection. The time protection  
38 was 60 and 30 min for respective concentrations of about 150 and  $300 \text{ mg.m}^{-3}$ .  
39 This global investigation addressed how to overcome the scientific barriers to  
40 designing a compact, self-contained filtration cartridge for personal protection in  
41 CBRN emergency response and management in accordance with the United Nations  
42 Sustainable Development Goals (SDGs).

### 43 **Keywords**

44 chemical weapon agent's treatment, optimized coupling photocatalytic/adsorption  
45 configuration; regeneration; CBRN emergency.

### 46 **1. Introduction**

47 To fight against chemical weapons, government authorities have conducted several  
48 actions, either at the international level through a commitment to the Organization for  
49 the Prohibition of Chemical Weapons (OPCW) and through the implementation of the

50 Convention on the Prohibition of the Development, Production, Stockpiling and Use  
51 of Chemical Weapons and on Their Destruction [1]. or at the national level through  
52 the elaboration of defense strategies (e.g., plans, laws, and treaties). These  
53 application have prepared personnel to improve their capacity to act and their  
54 research and development, in particular, for developing new processes for treating  
55 chemical warfare agents, which has become the main subject of study for  
56 researchers [2][3][4]. Chemical warfare agents, the current state-of-the-art technology  
57 of air filtration materials for protection against highly toxic chemicals, is mainly based  
58 on the proposal of new, innovative, efficient, environmentally friendly, and  
59 economically viable textiles that provide additional protection for people in direct  
60 contact with a chemical weapon. These are effectively intelligent textiles that possess  
61 reagents or active sites capable of degrading toxic compounds (passive-to-active  
62 protection) [5][6][7][8].

63 For gas masks, research is much more focused on improving the properties of the  
64 adsorbent, which is most often activated carbon (AC) for protection against chemical  
65 warfare agents [9][10][11]. A significant disadvantage of these protection systems is  
66 that the filter cartridges have limited autonomy, thus reducing the action time of the  
67 personnel involved [12]. Consequently, regularly changing them to maintain optimal  
68 protection is necessary. Thus, developing effective self-cleaning filters is crucial for  
69 guaranteeing the safety of personnel intervening in emergencies, particularly CBRN  
70 situations.

71 This work is part of this protection context. Indeed, treating (or simulating) toxic gases  
72 by coupling adsorption and photocatalysis is of interest. The association between the  
73 two processes is based on the adsorbent allowing for temporary storage during peak  
74 exposures and photocatalyst activation improving the adsorption of the pollutant and

75 restoring the active sites by degrading the stored contaminant into CO<sub>2</sub> and H<sub>2</sub>O [13–  
76 17]. This work aimed to remove scientific obstacles to designing a compact, self-  
77 contained filtration cartridge for individual protection for intervening in and managing  
78 CBRN emergencies.

79 Adsorptive removal and photocatalytic oxidation are two effective technologies for  
80 efficiently removing toxic compounds. The literature has shown that most of the work  
81 on coupling the two processes focuses on developing hybrid compounds based on  
82 nano-photocatalysts and an adsorbent [18][19]. The interest in this combination is to  
83 develop efficient process, usually based on TiO<sub>2</sub> with excellent recycling properties  
84 for practical application in the degradation of high-concentration pollutants.  
85 Adsorbents can be based on adsorbent fibers, carbon nanotubes, graphene, AC and  
86 biochar [19][20][21][22][23].

87 Another way to link the two processes is to place the photocatalytic reactor in a  
88 series with the adsorbent filter. Wan-Kuen and Chang-Hee (2009) [24] tested the  
89 suitability of putting an adsorbing filter before a photocatalytic reactor. In this case, it  
90 was instead of an outlet protection mechanism. Thus, from the breakthrough,  
91 residues pass through the adsorbent filter, which would be harmful if no  
92 photocatalytic reactor were downstream. This configuration allows the filter to be  
93 operated longer without worrying about pollutants passing through. This solution was  
94 also used in a multidisciplinary project CUBAIR (2019) [25]. However, putting the  
95 photocatalytic reactor upstream of the adsorbing filter is more sensible. Many  
96 researchers, including Jain et al. (2007) [26] and Lim et al. (2011) [27] have analyzed  
97 this configuration. This configuration aims to delay the filter's inevitable breakthrough  
98 and extend its life as much as possible. Furthermore, Mamaghani et al. (2021) [28]  
99 adopted a promising strategy to improve the efficiency of air treatment systems in

100 which the combination of TiO<sub>2</sub> and ACF showed better efficiency than TiO<sub>2</sub> coated on  
101 nickel foam filter (NFF) and uncoated activated carbon fiber. Due to ACF's high  
102 affinity and adsorption capacity, MEK molecules were concentrated around TiO<sub>2</sub>,  
103 which improved the reaction rate and led to higher removal efficiency. Nonetheless,  
104 the photocatalytic degradation of MEK could effectively increase the breakthrough  
105 time of the ACF. TiO<sub>2</sub> continuously oxidized the MEK adsorbed on the ACF's surface,  
106 leading to *in situ* regeneration.

107 Another advantage of coupling the two processes in a series is the possibility of  
108 regenerating the adsorbent and reusing the filter several times. Yet, after a few  
109 cycles, the amount of adsorbed pollutants decreased with each regeneration until the  
110 filter became inefficient. Considering the example of water treatment, the presence of  
111 H<sub>2</sub>O<sub>2</sub> during regeneration made the adsorbent more efficient, with a higher lifetime  
112 (the number of cycles) [29].

113 This study applies an optimized version of photocatalytic module (optical fibers) with  
114 a regeneration process by Joule effect (in situ heating) developed for the  
115 regeneration of an AF support saturated with chemical warfare agent simulants  
116 (mustard), methyl salicylate and Diethylsulphide.

117 The device combining the photocatalytic process with an adsorbent was also tested  
118 for continuous treatment under realistic conditions in a climatic chamber in the  
119 presence of a dummy (FeTHeMa), with the aim of proposing a new advanced  
120 technique for respiratory protection against highly toxic chemical compounds with an  
121 active aspect.

122 This detailed study aims to overcome the scientific barriers to the design of a  
123 compact, self-contained filter cartridge for personal protection in CBRN emergency  
124 management and response, in line with the Sustainable Development Goals (SDGs).

125 The literature review did not reveal any work presenting a compact configuration  
126 coupling the photocatalytic process on luminous tissue with an adsorption process  
127 with an integrated regeneration pathway, especially considering that the coupling  
128 configuration has been developed and tested for chemical warfare agent treatment  
129 applications.

## 130 **2. Material and methods**

### 131 *2.1. Pollutants studied*

132 In this study, target molecules were chosen for specific reasons, converging on the  
133 effectiveness of respiratory protection. Accordingly, the first compound is  
134 cyclohexane, a reference for the effectiveness tests of type A anti-gas filtration  
135 cartridges [12][30]. The second compound was a simulated mustard gas with sulfur  
136 ( $C_4H_8Cl_2S$ ), namely methyl salicylate ( $C_8H_8O_3$ ), a compound in which studies of  
137 adsorption and desorption showed that it effectively mimicked the behavior of  
138 mustard gas [31][32][33][34].

139 Since mustard gas is a sulfur compound, validating its degradation and the system's  
140 performance against a sulfur compound was necessary. Therefore, sulfur diethyl  
141 ( $C_2H_6S$ ) was chosen for these tests [35][36][37,38].

142 Sigma-Aldrich provided the studied compounds in a liquid form with purities of >98%,  
143 >99%, and >98% for cyclohexane, methyl salicylate, and sulfur diethyl, respectively,  
144 which volatilized obtaining the desired gas concentrations.

### 145 *2.2. Supports*

### 146 2.2.1. Photocatalytic support

147 The photocatalytic substrate tested during this study was a new double-sided optical  
148 fiber (OF) photocatalytic media manufactured by Brochier Technologies (UVtex®)  
149 (Fig. 1a), with TiO<sub>2</sub> (Degussa P25) deposited equal to 26 g.m<sup>-2</sup>. Previous publications  
150 have presented further information on these media [39][40][41]. Details on the  
151 manufacturing process of the media and the results of a characterization of the  
152 surface texture of the photocatalytic media by scanning electron microscopy (SEM-  
153 JEOL JSM 7100F) (Fig. S1 and S2) are provided in supporting information  
154 [42][43][44].

### 155 2.2.2. Adsorption supports

156 In this work, adsorption media provided by the DACARB was used (Fig. 1b). It was  
157 made of activated carbon felt (AF) under the reference FEU-CS-V-4 and  
158 manufactured based on viscose at high temperatures and in the presence of water  
159 vapor. This support had a specific area of 1,100 m<sup>2</sup>.g<sup>-1</sup> with a pore volume of 0.8  
160 cm<sup>3</sup>.g<sup>-1</sup>, 40% of which was mesoporous; a thickness of 4 mm; and a weight of 250  
161 g.m<sup>-2</sup>.

162 The supplier communicated the AF's surface functions. The main surface functions  
163 were carboxylic (0.01 mmol.g<sup>-1</sup>), phenolic (0.17 mmol.g<sup>-1</sup>), and basic (0.20 mmol.g<sup>-1</sup>).

## 164 2.3. Reactors and experimental devices:

### 165 2.3.1. Reactor configuration

166 The reactor represented the construction of a new front-flow reactor configuration  
167 (Fig. 1c), based on the same principle of chaining photocatalytic and adsorbent  
168 media. The cross-section was 10 × 10 cm. The reactor was made of Bakelite, which  
169 gave it high mechanical resistance (hard, rigid), electrical insulation, and good



170 temperature resistance (120 C°). The objective of this configuration was to optimize  
171 photocatalytic treatment by reducing the residence time while ensuring good  
172 degradation efficiency. This latter configuration was called PFR-LED optimized.

173 The PFR-LED reactor compartments were also adapted for installing adsorbent  
174 support, in which two copper rods were integrated. Thus, the regeneration step was  
175 conducted using the Joule effect. Therefore, installing copper electrodes in the  
176 reactor compartments ensured the necessity of electrical connections.

177 The main characteristics of the photocatalytic module configuration are presented in

178 Table

S1.

a)

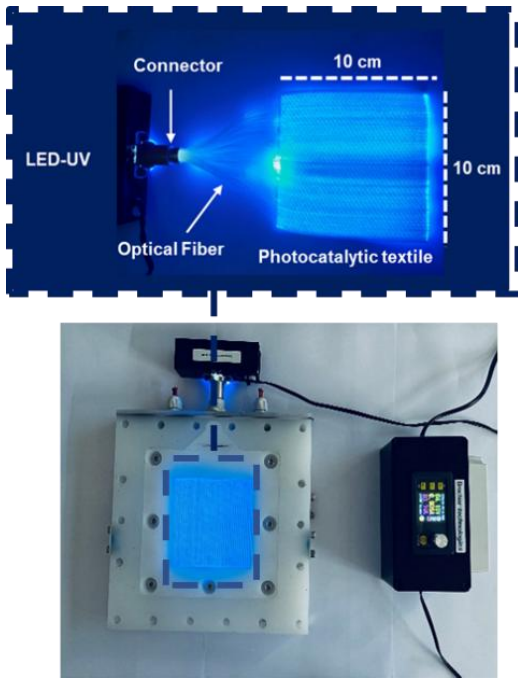

Photocatalytic support with TiO<sub>2</sub> coated on optical fiber

b)

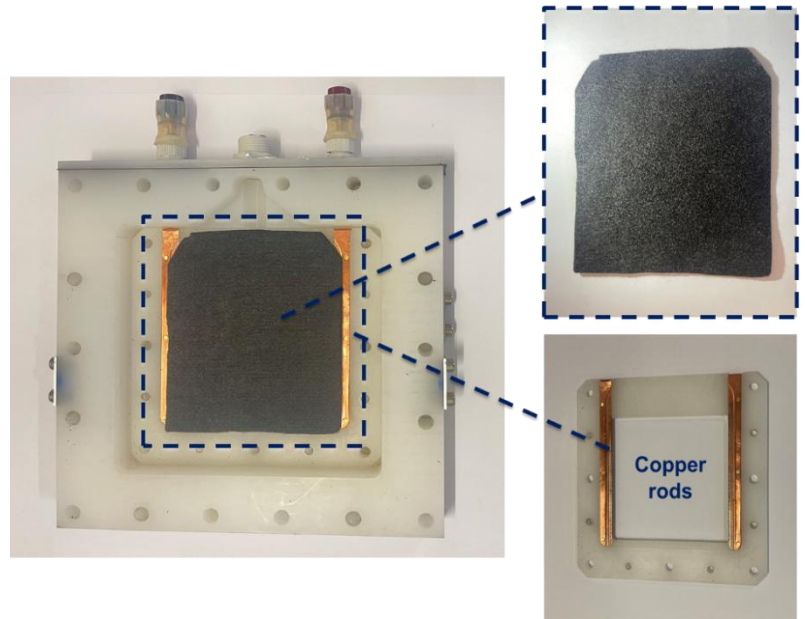

Activated carbon felt (FEU-CS-V-4) "AF" support

c)

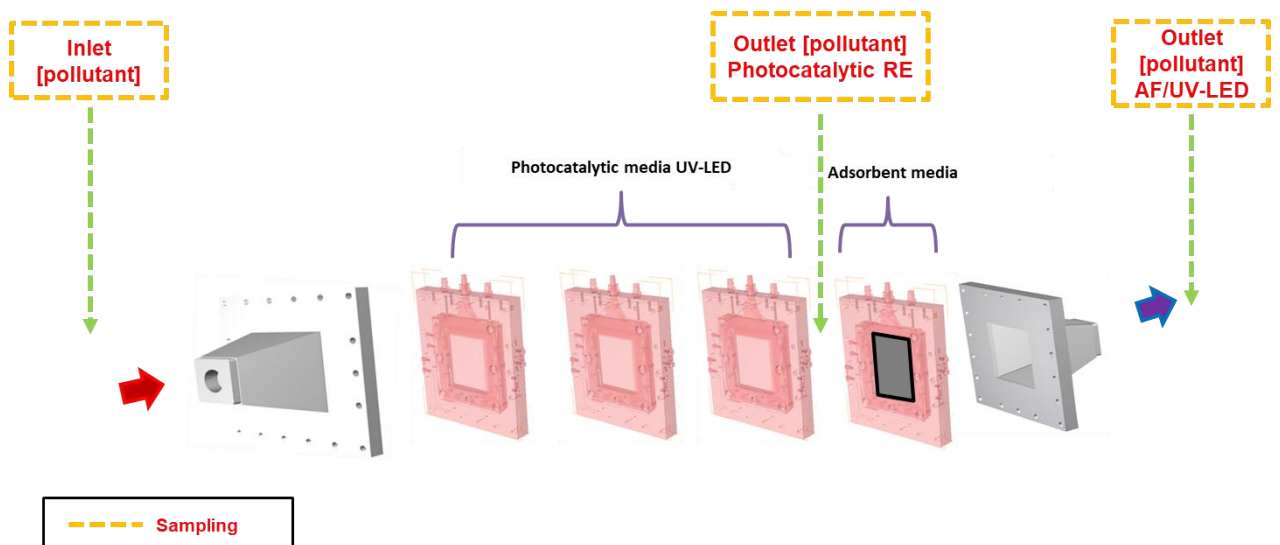

Photocatalytic front flow module based on Luminous tissue and AF filter

Figure 1: Front-flow module based on a) optical fibers photocatalytic media (PFR-LED) coupled to b) AF supports

180

### 181 2.3.2. *Experimental setup*

182 The system consisted of two configurations. One was for a continuous treatment in  
183 which dry air returning from the network was the carrier gas. A mass flow meter  
184 controlled its flow (Bronkhorst In-Flow). A bubbler containing water was installed in  
185 the circuit to humidify the air. The pollutant was continuously injected in liquid form by  
186 a syringe and pump assembly. A heating ribbon was placed in the injection zone to  
187 facilitate the pollutant's volatilization. A static mixer allowed for the upstream  
188 homogenization of the reactor's effluent. Two septa downstream and upstream of the  
189 photoreactor allowed for sampling outlet and inlet gas with a syringe. The second  
190 configuration was a closed-loop treatment in which a recirculation flow (about  $1 \text{ m}^3 \cdot \text{h}^{-1}$ )  
191 was dedicated to studying adsorbent regeneration.

192 The desorption device used a Joule effect heating system (*in situ* heating). A 600 W  
193 DC generator XG-60-14 (Amatek®) with voltage and working current ranges of 0–60  
194 V and 0–10 A, respectively, was used. This system provided an electrical circuit with  
195 a current of 5 A and a voltage of 35 V for thermal conduction heating of the  
196 adsorbent media. To maintain the desorption temperature at a temperature level of  
197  $70 \pm 2\text{C}^\circ$  throughout the experiment, a thermostat was set up and equipped with a  
198 chromium-nickel alloy probe, with a linear response over the range of 0–1,000 K  
199 installed on the support's surface. A temperature sensor was also installed at the  
200 reactor entrance connected to an Arduino system, allowing one to follow the  
201 temperature evolution by direct data acquisition on a PC. This system permitted the  
202 maintenance of the necessary temperature for desorption throughout the experiment.

203 Figure 2 shows the experimental procedure.

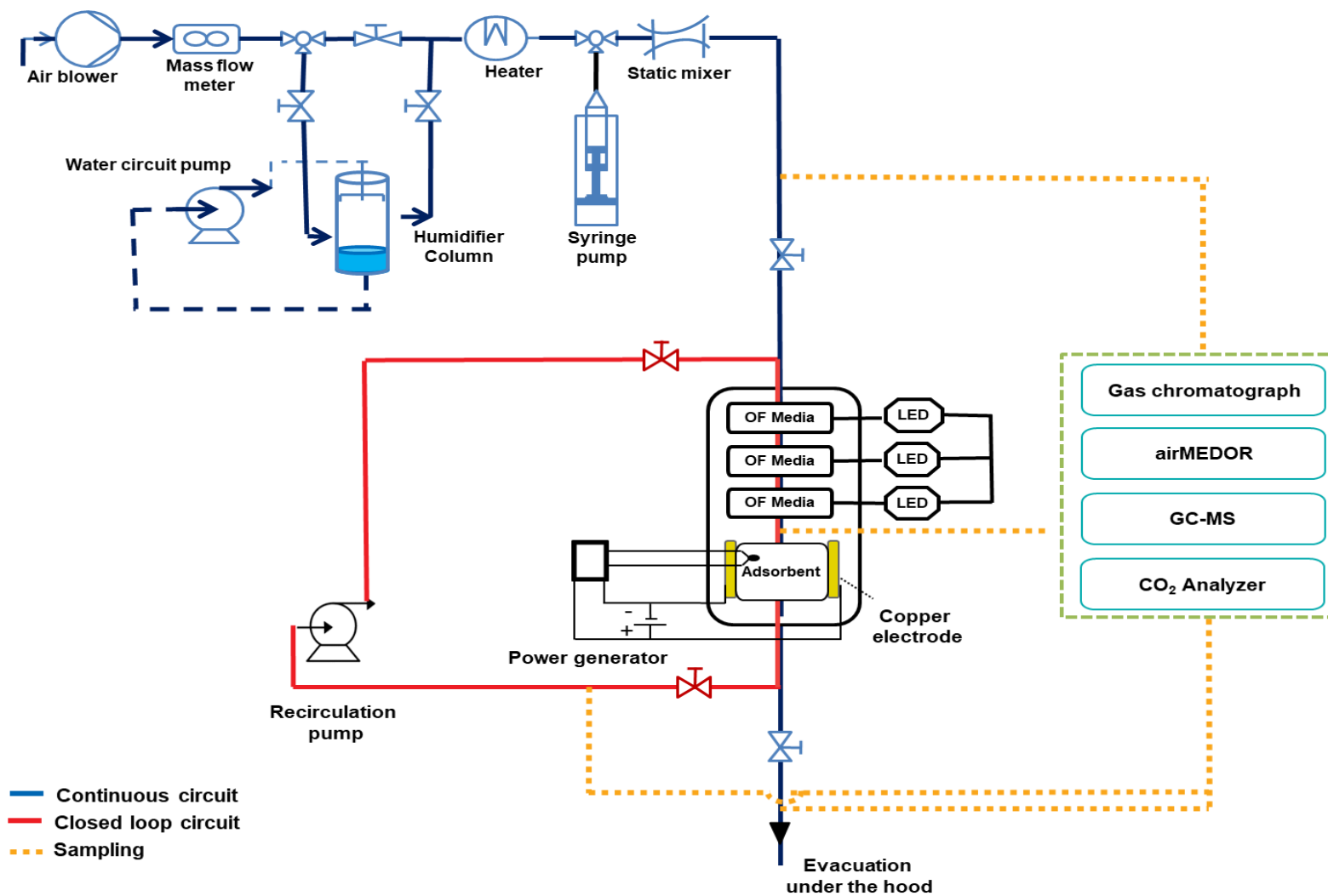

**Figure 2:** Diagram of the installation of the coupling configuration of the adsorbent with photocatalytic process with different desorption methods.

204 *2.4. Climatic chamber for full-scale tests*

205 The experiments were conducted in the climatic chamber QUALIDIF of the LGCGM  
206 Laboratory (Fig. 3a) with the following dimensions:  $L \times W \times H = 3.50\text{m} \times 3.50\text{ m} \times$   
207  $2.50\text{ m}$ . It was coupled to an air diffusion circuit, including an air handling unit (AHU).

208 The six inside faces were thermally controlled using a hydraulic circuit composed of  
209 PER pipes inserted into the walls and connected to a heat pump for simultaneous  
210 heating and cooling. The ambient temperature in the chamber was controlled with a  
211 hydraulic circuit. The AHU generated by a ceiling air jet was equipped with a fan, a  
212 heater, a chiller, and a CELLKRAFT stream generator E-6000 with an external  
213 humidity sensor for accuracy  $\pm(1.5 + 0.015 \times \text{reading})$ , followed by a plenum box. The  
214 air diffusion terminal unit was installed at the extremity of the plenum box. The inlet  
215 flow rate and air temperature were controlled with sensors placed between the  
216 handling unit and the plenum box and again measured at the jet exit using an ACIN  
217 balometer (Flowfinder mk2). The accuracy in the flow rate measurement was  $\pm 3\%$  of  
218 the reading. The air returned to the AHU via an outlet at the bottom of a wall. This  
219 return air was not mixed with fresh air from the outdoors; the AHU recirculated the air  
220 already present in the chamber via airtight pipes.

221 The chamber was equipped with air temperature sensors (PT1000\_1/3 DIN –  
222 accuracy of  $\pm 0.1^\circ\text{C}$ ) and omnidirectional anemometers (TSI 8475, accuracy of  $\pm 3\%$   
223 of the reading) to determine the RH percentage. Cameras were present in the  
224 chamber to view the interior from the outside of the chamber.

225 The climatic chamber was also equipped with a humanlike thermal manikin (named  
226 FeTHeMa, based on “female thermal manikin”; see Fig. 3b), mimicking the human  
227 body due to 79 thermoregulated zones. This manikin was developed according to the

228 standard ISO 14505–2:2006, noted in P. Danca’s [45] thesis on local thermal comfort  
229 measurement. A supplementary breathing system was integrated into the manikin to  
230 study pollutant concentrations in the inhaled air when an ambient exposition risk  
231 exists. In the present study, the twin tubes connecting the manikin’s nostrils to the  
232 outside were attached to a pump. In the first step, the air samples in this (respiratory)  
233 circuit were analyzed in the presence of cyclohexane C<sub>6</sub>H<sub>12</sub> [12] (a reference for  
234 testing the effectiveness of anti-gas filter cartridges) in the chamber, which  
235 represented the reference case of exposure. In the second step, the (respiratory)  
236 circuit was connected to the filtration module (PFR-LED Optimized coupled to AF  
237 support). The analysis of the filtered air at the outlet of the cartridge enabled the  
238 testing of the effectiveness of the cartridge to protect anyone exposed to the  
239 chemical agent. An air sampling system was installed in the chamber (Fig. 4) to  
240 determine the various sampling points inside the room. It also monitored the  
241 concentration of the pollutant at the inlet and outlet of the purification reactor from  
242 outside the climate chamber.

**(a)**



**(b)**

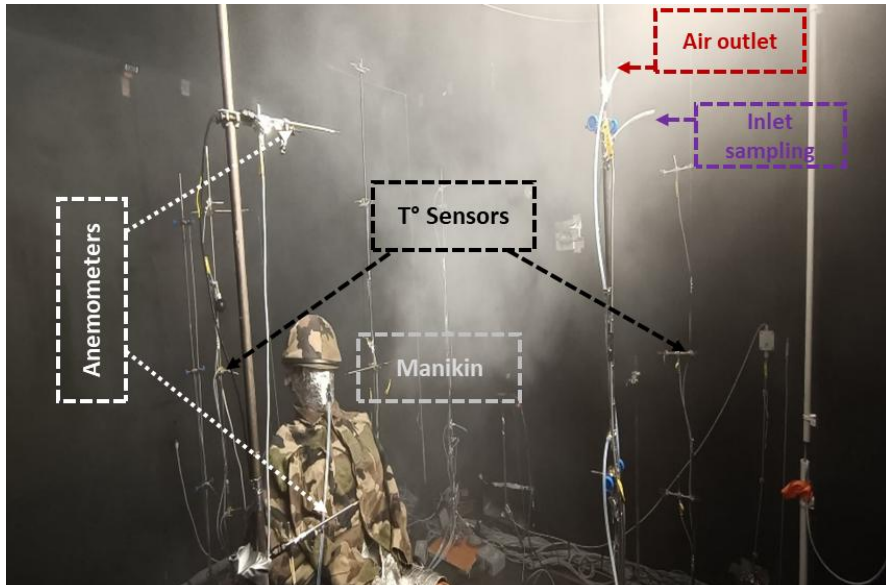

**Figure 3:** a) Climatic chamber QUALIDIF and FeTheMa thermal Manikin b) in a contaminated area.

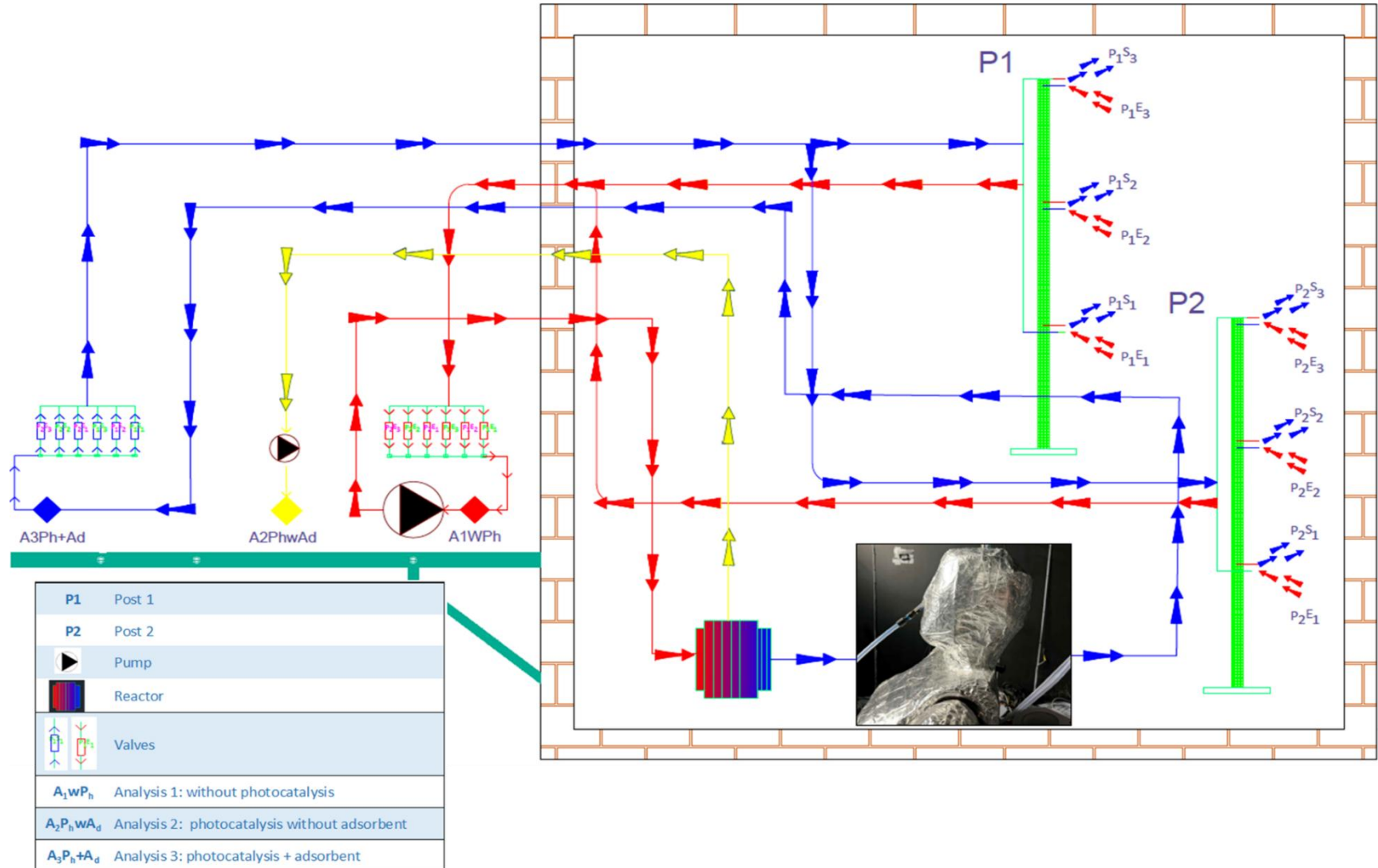

**Figure 4:** Experimental principle diagrams of purification tests in realistic situations.



243 2.5. Analytic tools

244 Different main factors were considered for evaluating the performance of the different  
245 photocatalytic configurations and coupling modules, such as the adsorption capacity  
246 of the adsorbent media in the dynamic tests. The adsorption capacity was calculated  
247 using Eq.1:

$$q_e = \frac{M_e}{M} \quad \text{where, } M_e = Q \int_0^\infty (C_e - C) dt \quad (1)$$

248

249  $q_e$  is the adsorption capacity ( $g_{\text{pollutant}} / g_{\text{adsorbent}}$ );  $C_o$  and  $C$  are the initial and  
250 instantaneous concentrations at a given time, respectively; and  $Q$  and  $t$  are the  
251 adsorbate flow rate ( $L \cdot \text{min}^{-1}$ ) and time (min), respectively.

252 The breakthrough adsorption behavior was predicted using Clark's dynamic  
253 adsorption model [46]. This model was based on the concepts of mass transfer,  
254 which consider the dynamic phenomenon and isothermal Freundlich equation  
255 representing equilibrium. They were also based on the assumption that fluid flow is of  
256 a piston type. The model's equation is expressed as follows:

$$\frac{C_s}{C_0} = \left[ \frac{1}{1 - A e^{-rt}} \right]^{1/(n-1)} \quad (2)$$

257 The breakthrough time is expressed using Eq. 3:

$$tp = \frac{\ln A - \ln \left( \frac{C_0^{n-1}}{C_p^{n-1}} - 1 \right)}{r} \quad (3)$$

258

259 The material balance and the energy balance of electrical power consumed during  
260 the regeneration process were the basis for a better evaluation of regeneration  
261 performance, the average specific elimination rate, and the desorption rate:

$$\text{Average elimination rate} = \text{Mass eliminated} / \text{Degradation time} / \text{Mass of TiO}_2 \quad (4)$$

$$\text{Desorption rate} = \text{desorbed mass of pollutant} / \text{Desorption time} \quad (5)$$

$$E_{\text{consumed}} = E_{\text{regeneration}} = E_{\text{desorption}} + E_{\text{Photocatalyse}} \quad (6)$$

262

## 263 2.6. Analytical Instruments

264 The different analytical methods used in this work are detailed in the information  
265 material. The studied gases were analyzed using two gas-phase chromatographs  
266 coupled to an FID detector. One had an FFAP column for analyzing cyclohexane,  
267 and the other had an HP5 column for analyzing methyl salicylate. Sulfur diethyl was  
268 analyzed using airMEDOR. Detailed information about the analysis setup was  
269 presented in previous work [47].

## 270 3. Results and discussions

### 271 3.1. Study of adsorbent regeneration by a photocatalytic module

272 The adsorption performance of the used support was developed in a batch study to  
273 highlight its effectiveness in retaining the selected pollutants [48][49]. Table S2  
274 summarized the results of the adsorption parameters. The order of magnitude of the  
275 obtained adsorption capacities was consistent with those in the literature [12],  
276 Freundlich and Langmuir models provided a good correlation of the experimental  
277 results.

#### 278 3.1.1 Adsorption and desorption cycle studies of AF media with the PFR-LED 279 Optimized module during in situ regeneration

280 This study aimed to evaluate the evolution of the adsorption capacities of AF media  
281 during adsorption–desorption cycles in the same sample. For this purpose, different

282 regeneration cycles were conducted on the adsorbent medium (AF) by *in situ*  
283 desorption with an optimized PFR-LED photocatalytic module (Fig. 5). The  
284 concentration of MS injected to obtain adsorption equilibrium, the operating  
285 conditions, and the electrical power applied for desorption were kept identical for  
286 each cycle. Monitoring of the absolute humidity during the regeneration process was  
287 also implemented to better evaluate the photocatalytic degradation of the pollutant  
288 during the regeneration process. Notably, the adopted saturation rate corresponded  
289 with the respiratory rate for light physical activities, and the saturation rate  
290 corresponded with the respiratory flow rate for light work in accordance with the ISO  
291 standard ISO/DIS 8996 [50].

292 The material balance (Fig. 6a) was based on an analysis of the amount adsorbed  
293 during different adsorption cycles. The results of the balance showed a decrease in  
294 the adsorption capacity of the AF media after each regeneration cycle (8.01 mmol in  
295 cycle 1 and 7.81 mmol in cycle 2) compared to the amount adsorbed at the beginning  
296 (8.44 mmol). The regeneration rate (Fig. 6b) confirmed this finding, in which a loss  
297 was observed after each regeneration cycle. A decrease in the working time of the  
298 filter was also recorded after each regeneration cycle (a decrease of 15.49% and  
299 31.59% after the first and second regeneration cycles, respectively) (Fig. 6c). This  
300 decrease in the performance of the AF media may have been due to the incomplete  
301 regeneration of the media. This incomplete regeneration could be because of the  
302 limitation of the photocatalytic reaction on the sites as a result of competition with  
303 water molecules, as many researchers have noted [51][52][53][54][55]. Figure 6  
304 shows an increase in absolute humidity during the regeneration of the AF generated  
305 by the photocatalytic process until reaching saturation level.

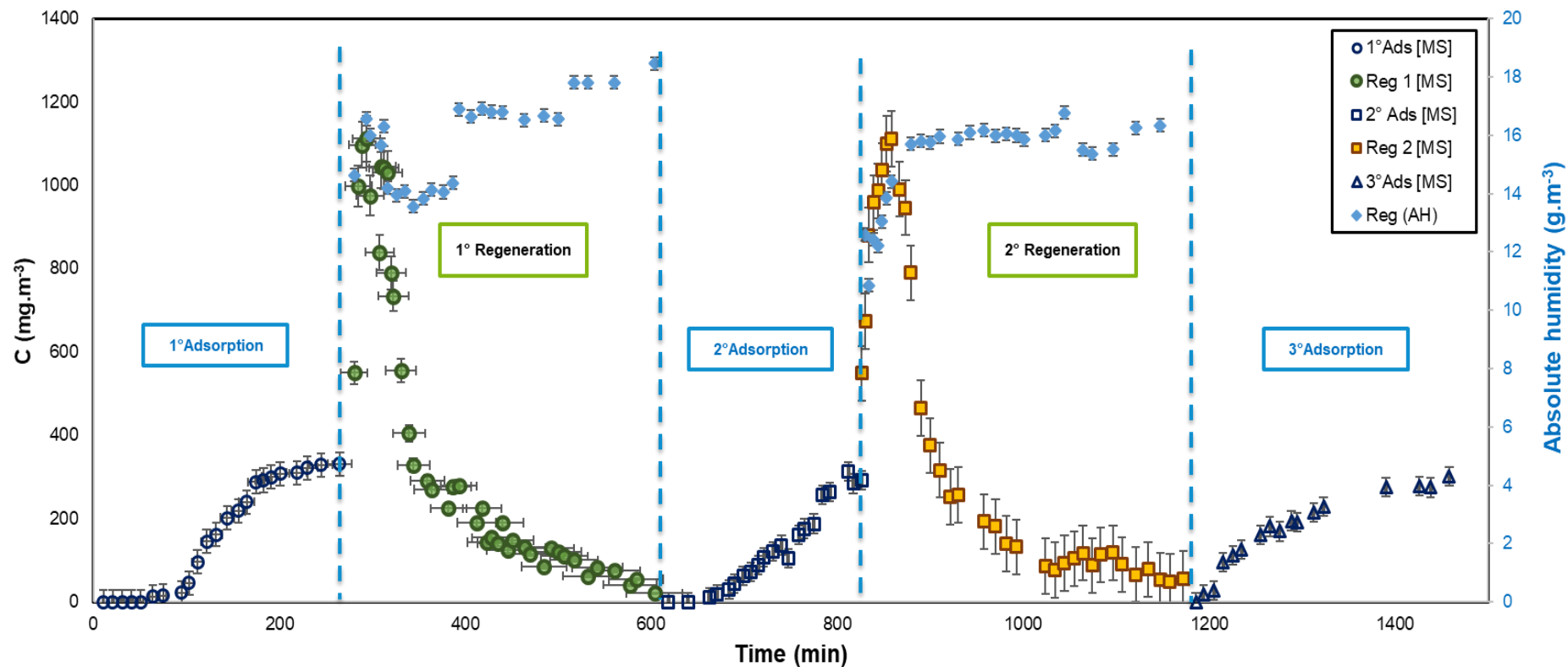

**Figure 5:** Adsorption and regeneration cycles of AF with optimized PFR-LED photocatalytic configuration, with absolute humidity monitoring: PFR-LED (Optimized) ( $m_{\text{TiO}_2} = 0,78 \text{ g}$ ,  $I = 7,8 \text{ W.m}^{-2}$ ,  $m_{\text{AF}} = 2,5 \text{ g}$ ). Methyl Salicylate :  $C = 300 \text{ mg.m}^{-3}$  /  $Q = 18 \text{ L.min}^{-1}$  /  $\text{HR} = 40 \pm 2 \%$ ,  $T = 20 \pm 2 \text{ C}^\circ$ ,  $T_{\text{in situ}} = 70 \text{ C}^\circ$  (35 V- 5 A),  $Q_{\text{recyrculation}} = 1 \text{ m}^3 \cdot \text{h}^{-1}$ .

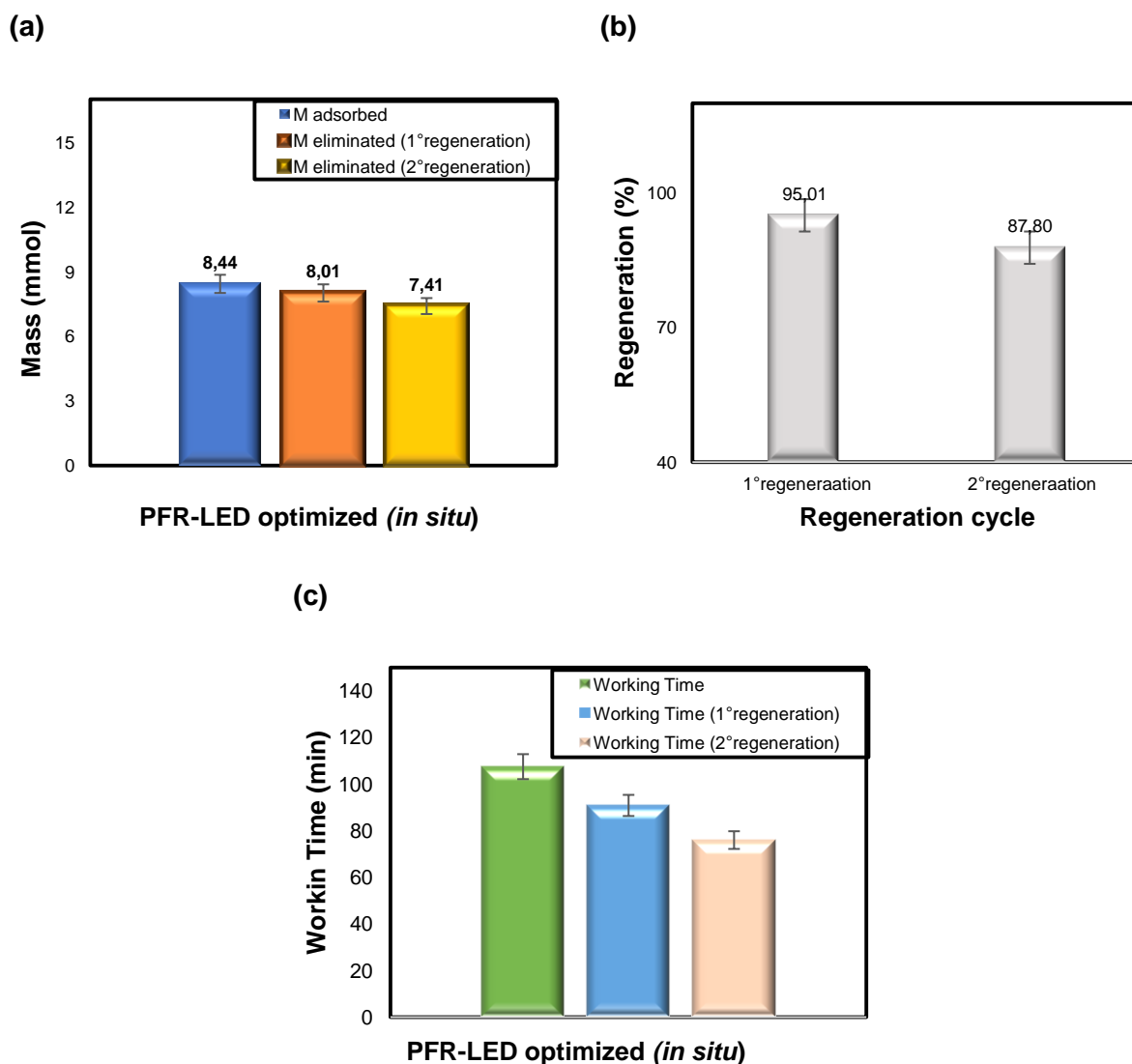

**Figure 6:** (a) Mass balance and (b) Regeneration rate and c) Working Time: PFR-LED (Optimized) ( $m_{\text{TiO}_2} = 0,78 \text{ g}$ ,  $I = 7,8 \text{ W.m}^{-2}$ ,  $m_{\text{AF}} = 2,5 \text{ g}$ ). Methyl Salicylate :  $C = 300 \text{ mg.m}^{-3}$  /  $Q = 18 \text{ L.min}^{-1}$  /  $\text{HR} = 40 \pm 2 \%$ ,  $T = 20 \pm 2 \text{ C}^\circ$ ,  $T_{\text{in situ}} = 70 \text{ C}^\circ$  (35 V- 5 A),  $Q_{\text{recyrculation}} = 1 \text{ m}^3.\text{h}^{-1}$ .

306

307 Furthermore, byproducts formed during the regeneration process by photocatalytic  
 308 degradation, such as benzoic acid, were not desorbed [55]. There was also the  
 309 phenomenon of the depletion of the adsorbent material, which the literature has  
 310 noted [56][57]. Figure 7 shows the byproducts of the photocatalytic degradation of  
 311 methyl salicylate analyzed by GC-MS, where the sample was collected by

312 concentration on Carbotrap™ (CA). From 0.1 to 1 L of gas was injected using a  
313 thermal desorber (Dynatherm Analytical Instruments, model 890) with a desorption  
314 temperature of 170 °C.

315 The average desorption rate, the average removal rate, and the energy consumed  
316 through the process are presented in Figure S3.

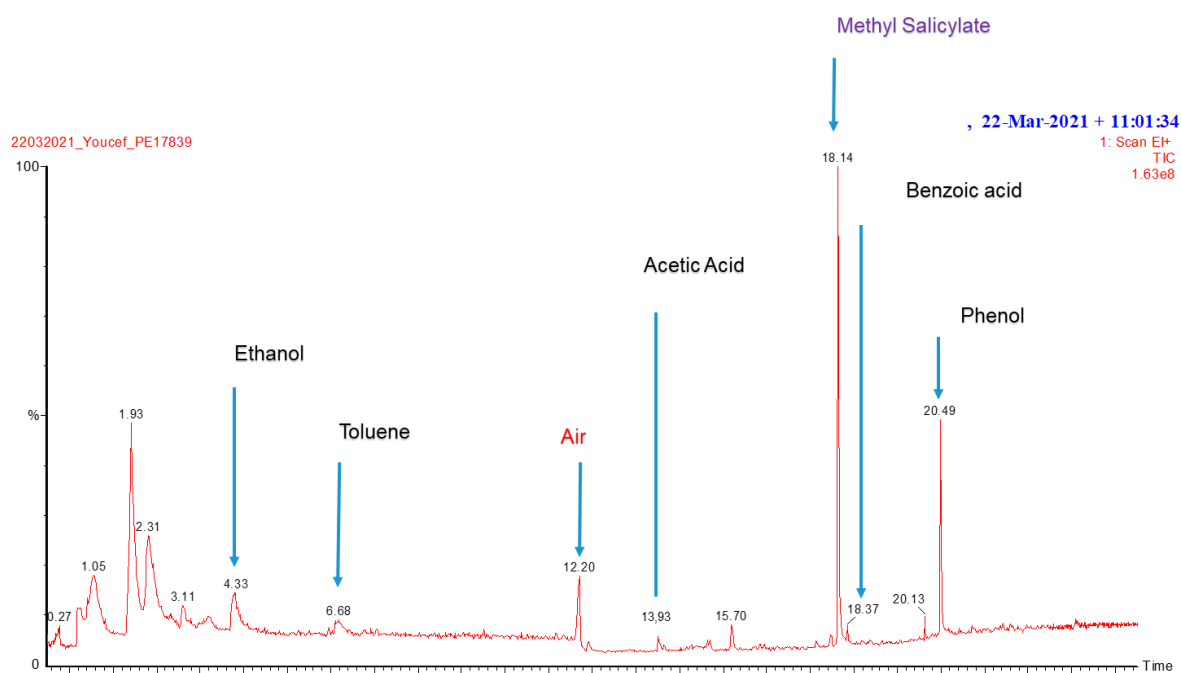

**Figure 7:** Photocatalytic degradation of the byproducts of methyl salicylate

317

318 *3.1.2 Performance study of the AF/PFR-LED Optimized process toward the sulfur*  
319 *compound (Yprite “sulfur mustard”)*

320 Since mustard is a sulfur compound, it was necessary to determine how the coupling  
321 system behaved toward it. A closed-loop treatment to regenerate the DES-saturated  
322 AF medium was studied. Of course, a final adsorption cycle must occur to reach  
323 equilibrium.

324 During this experiment, the formation of the degradation byproducts and the absolute  
325 humidity were monitored. The results are presented in Figure 8.

(a)

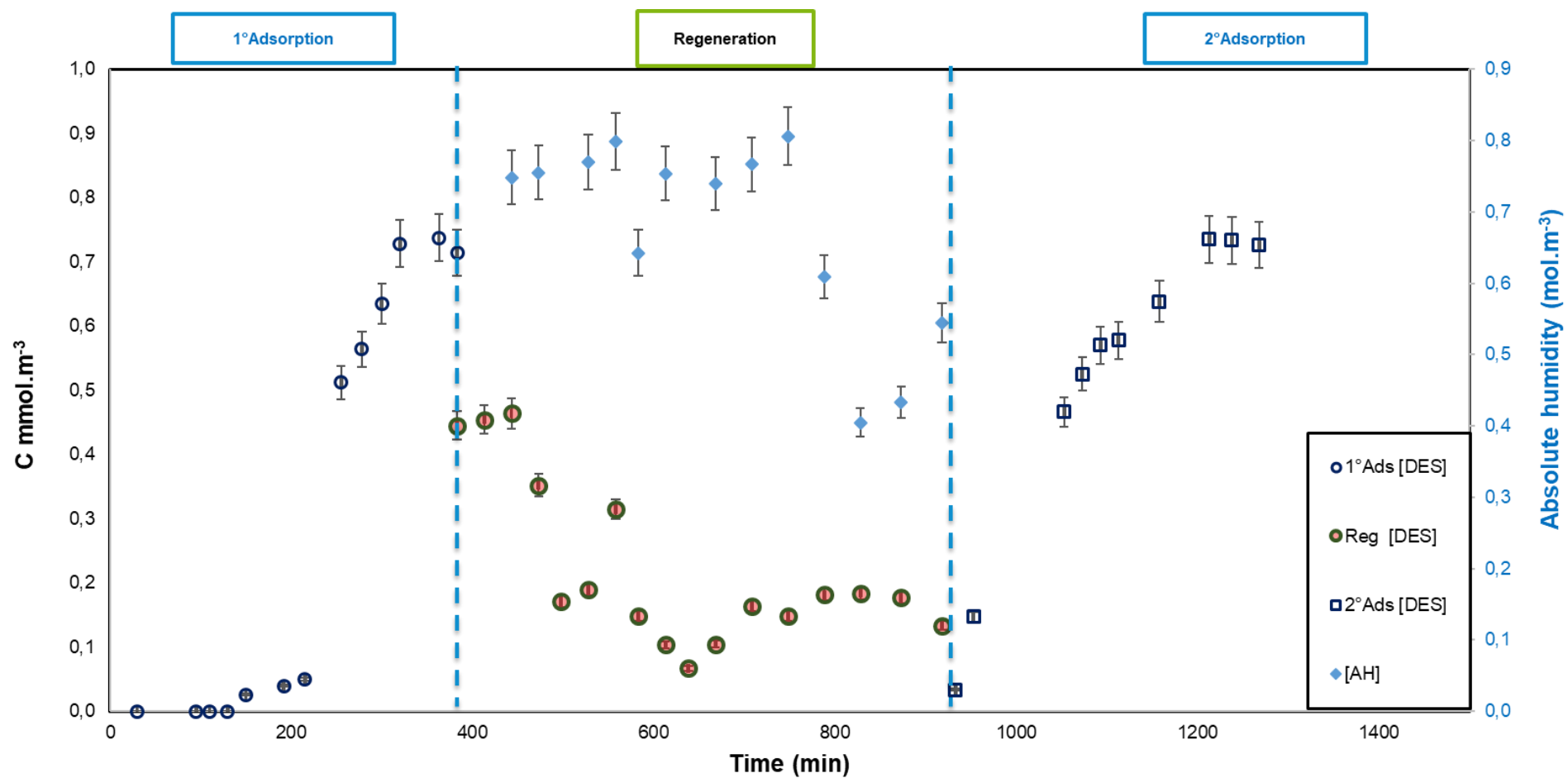



(b)

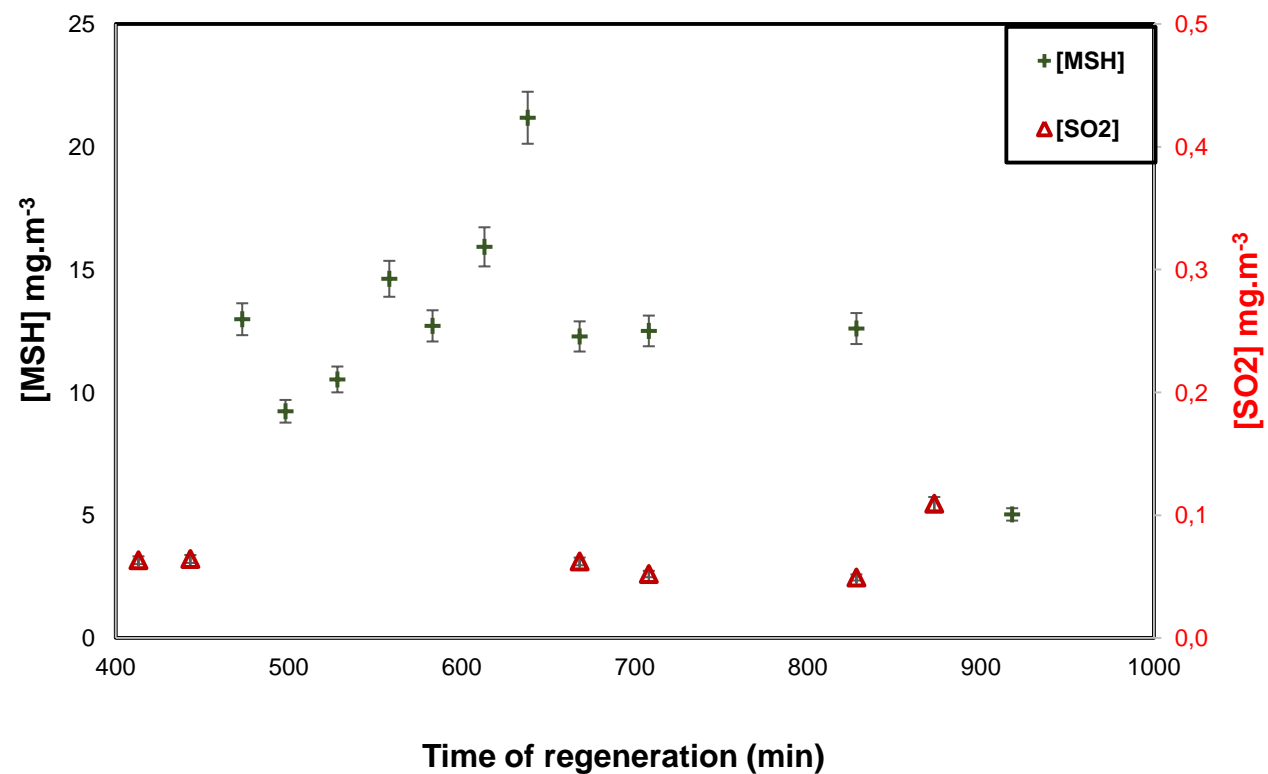

**Figure 8:** a) Adsorption under UV and the regeneration cycle of AF with optimized PFR-LED photocatalytic configuration with absolute humidity monitoring: PFR-LED (optimized) and b) the evolution of the byproducts during the regeneration cycle. ( $m_{\text{TiO}_2} = 0.78 \text{ g}$ ,  $I = 7, 8 \text{ W}\cdot\text{m}^{-2}$ ,  $m_{\text{AF}} = 2.5 \text{ g}$ ). Sulfur diethyl:  $C = 0.9 \text{ mmol}\cdot\text{m}^{-3}/Q = \text{L}\cdot\text{min}^{-1}/\text{HR} = 40 \pm 2\%$ ,  $T = 20 \pm 2^\circ\text{C}$ ,  $T_{\text{in situ}} = 70^\circ\text{C}$  (35 V- 5 A),  $Q_{\text{recirculation}} = 1 \text{ m}^3\cdot\text{h}^{-1}$ .

326 The analysis of the results also indicated a regeneration rate of AF support of  
327 76.92%. This incomplete regeneration could be due to poor desorption of DES [56]  
328 and the byproducts' degradation in which the phenomenon of competition occurred,  
329 as reported in the literature [40][57], namely the SO<sub>2</sub>, which is known for its tendency  
330 to poison the catalyst (TiO<sub>2</sub>) [58][59]. Moreover, an abundance of MSH was initially  
331 seen in the formation of intermediates due to the desorption of the target compound.  
332 The MSH formed was then degraded to ultimately form SO<sub>2</sub>. This mechanism aligned  
333 with the literature [5][60] for the degradation of DES, according to the mechanism  
334 shown in Figure S4.

### 335 *3.2. Continuous coupling study*

#### 336 *3.2.1 Continuous coupling for the Methyl salicylate treatment*

337 As previously mentioned, one configuration of adsorption and photocatalysis coupling  
338 was the installation of the photocatalytic module upstream of the fixed adsorption  
339 bed. The few authors who have studied continuous coupling to increase the running  
340 time of the adsorption filter favor this solution [26][27] .

341 In this study, a photocatalytic module was placed upstream of an AF adsorption filter  
342 to perform an air purification test with the mustard gas simulant MS. A comparative  
343 study between classical adsorption with an AF filter alone and another one based on  
344 the AF/UV-LED coupling was also presented. In this study, sampling was performed  
345 at the inlet of the system, after the photocatalytic module in order to estimate its  
346 performance and a last one at the outlet of the coupling system (after the module and  
347 the adsorbent filter). The sampling system is shown in an explanatory diagram in  
348 Figure 9a:

**(a)**

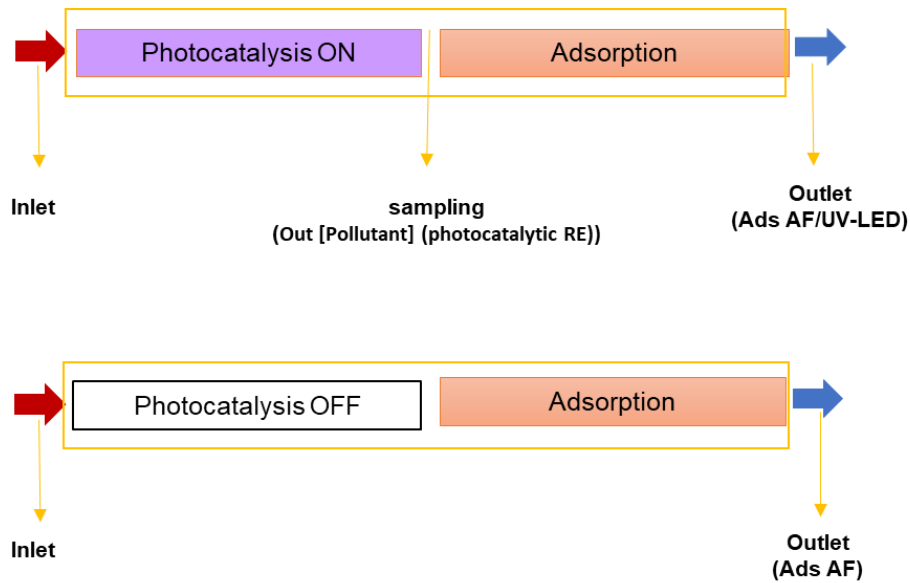

(b)

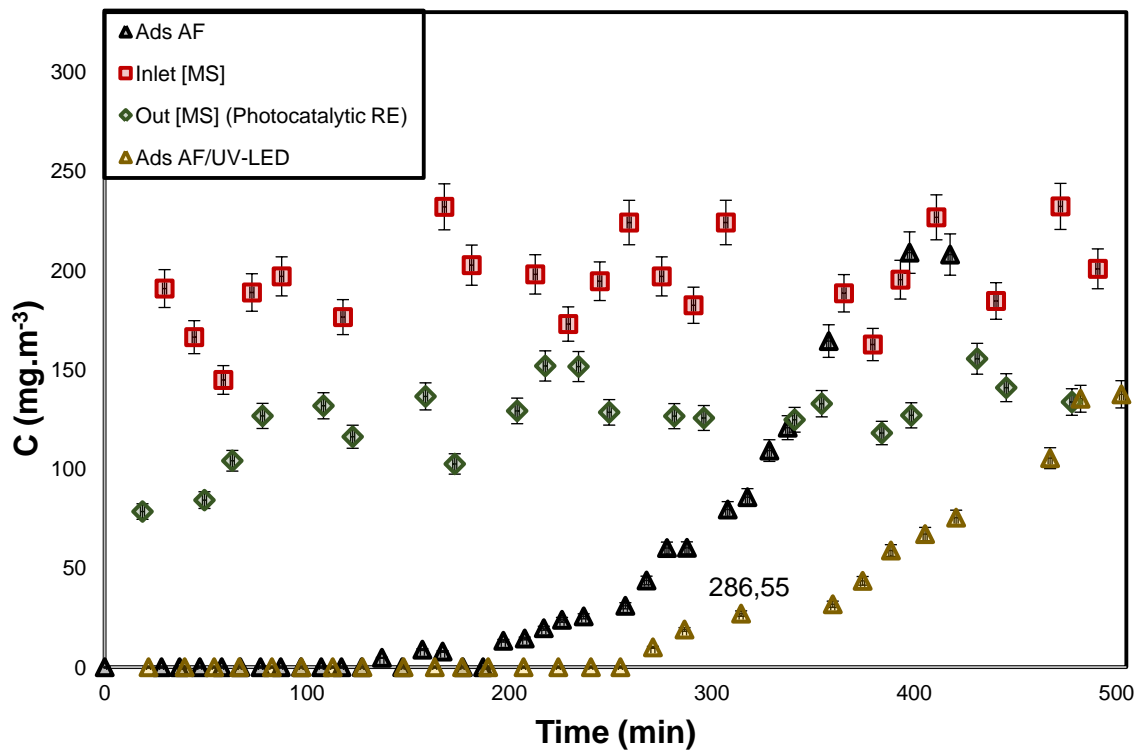

**Figure 9:** a) Sampling schematic and b) the result of continuous treatment of methyl salicylate with AF support alone and with front-flow photocatalytic optimized PFR-LED coupled with AF support: ( $m_{\text{TiO}_2} = 0.78 \text{ g}$ ,  $I = 7.8 \text{ W}\cdot\text{m}^{-2}$ ,  $m_{\text{AF}} = 2.5 \text{ g}$ ). Methyl salicylate:  $C = 200 \text{ mg}\cdot\text{m}^{-3}/Q = 18 \text{ L}\cdot\text{min}^{-1}/\text{HR} = 40 \pm 2\%$ ,  $T = 20 \pm 2^\circ\text{C}$ .

350 Figure 9b shows the concentration of methyl salicylate during adsorption with  
351 activated carbon felt alone and with a combination of the optimized PFR-LED  
352 photocatalytic module and the activated carbon felt. The MS concentration at the  
353 outlet of the photocatalytic section was also measured to evaluate the photocatalytic  
354 process's performance.

355 The results indicated that using a photocatalytic module upstream allowed for a  
356 significant degradation of the pollutant, estimated at 36% of removal efficiency over  
357 the entire treatment time ( $RE_{\text{moyen}}$ ) with a  $\text{CO}_2$  selectivity of 15%. This led to the  
358 adsorbent support receiving decreased concentration [27][28]. This increased the  
359 filter operating time by about 20%, resulting in a corresponding change in  
360 breakthrough time (5 h versus 4 h for AF alone).

361 The equilibrium adsorption capacity was estimated at  $0.61 \text{ g}_{\text{MS}}.\text{g}_{\text{AF}}^{-1}$  for adsorption  
362 alone and  $0.48 \text{ g}_{\text{MS}}.\text{g}_{\text{AF}}^{-1}$  for adsorption from the coupling. The equilibrium adsorption  
363 capacity decreased proportionally to the input concentration, and the breakthrough  
364 time increased when the latter decreased. This finding could be explained by the fact  
365 that the higher the input concentration of the target gas, the greater the number of  
366 molecules that can be adsorbed. Similarly, the breakthrough and saturation times  
367 were shortened [61][62][63].

### 368 *3.2.2 Simulating exposure to chemical toxins in a real environment*

369 This study focused on human respiratory safety in toxic environments. Accordingly,  
370 an optimized PFR-LED photocatalytic module and AF were tested to ensure the  
371 respiratory protection of a FeTheMa thermal manikin. The challenge was to validate  
372 a solution that would save time on filter life, namely continuous process coupling  
373 while maintaining a comfortable thermal and ventilation environment. The FeTheMa

374 thermal manikin is used as an inhaled air quality assessment tool and as a thermal  
375 comfort sensor.

376 Before proceeding with the filtration coupling tests, it was essential to determine the  
377 system's tightness and the contamination's homogeneity inside the chamber.  
378 Therefore, different tests were conducted, namely a smoke test (Fig. S5) to  
379 determine potential pollution and dead spots and a homogeneity test of the  
380 concentration inside the environmental chamber (blank test). The conditions of the  
381 environmental chamber and the thermal comfort of the manikin were also monitored  
382 during these tests. The details and results of this section are summarized in the  
383 supporting information. When the closed system allowed for a homogeneous  
384 concentration over the entire chamber volume (Fig. S6), the system did not  
385 significantly impact climatic conditions (Fig. S7). Moreover, the thermal comfort on  
386 the different parts of the manikin's body was homogeneous (Fig. S8).

387 The tests were performed with an approximate respiratory flow rate for intense work,  
388 according to the previously mentioned ISO/DIS 8996 standards.

**(a)**

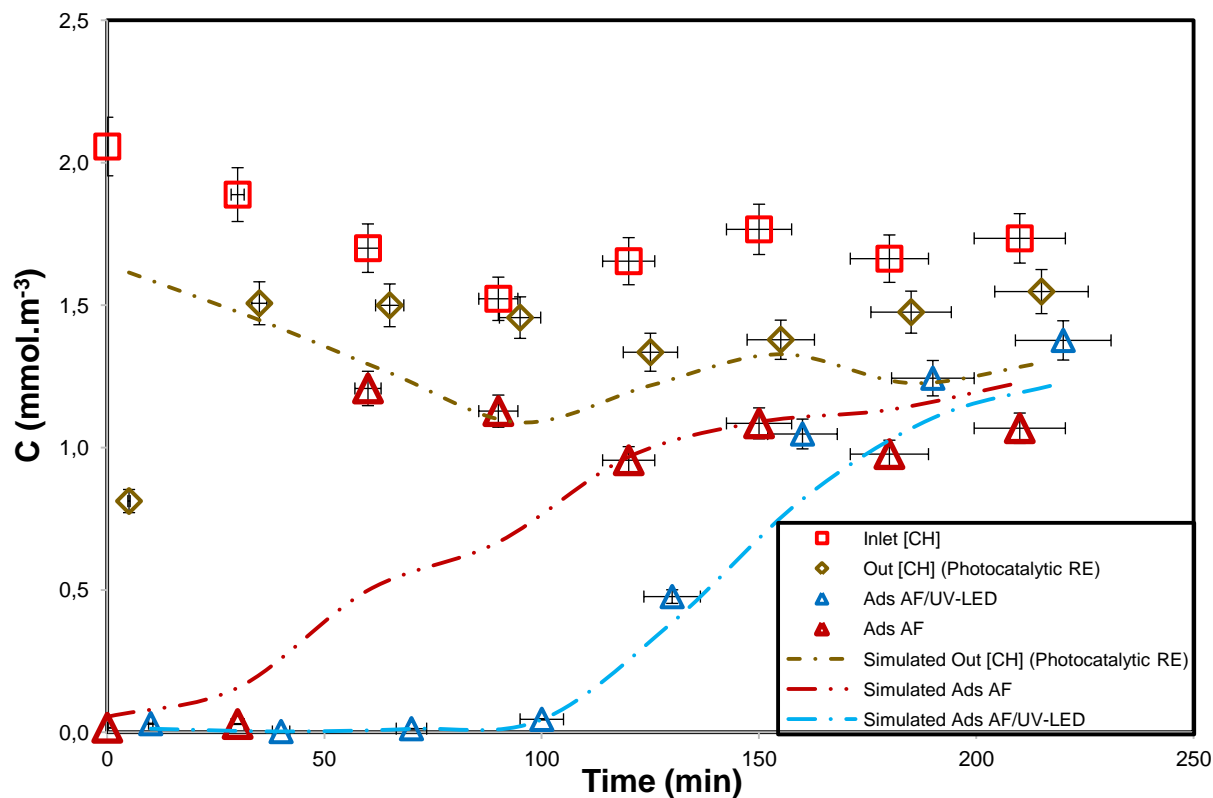

(b)

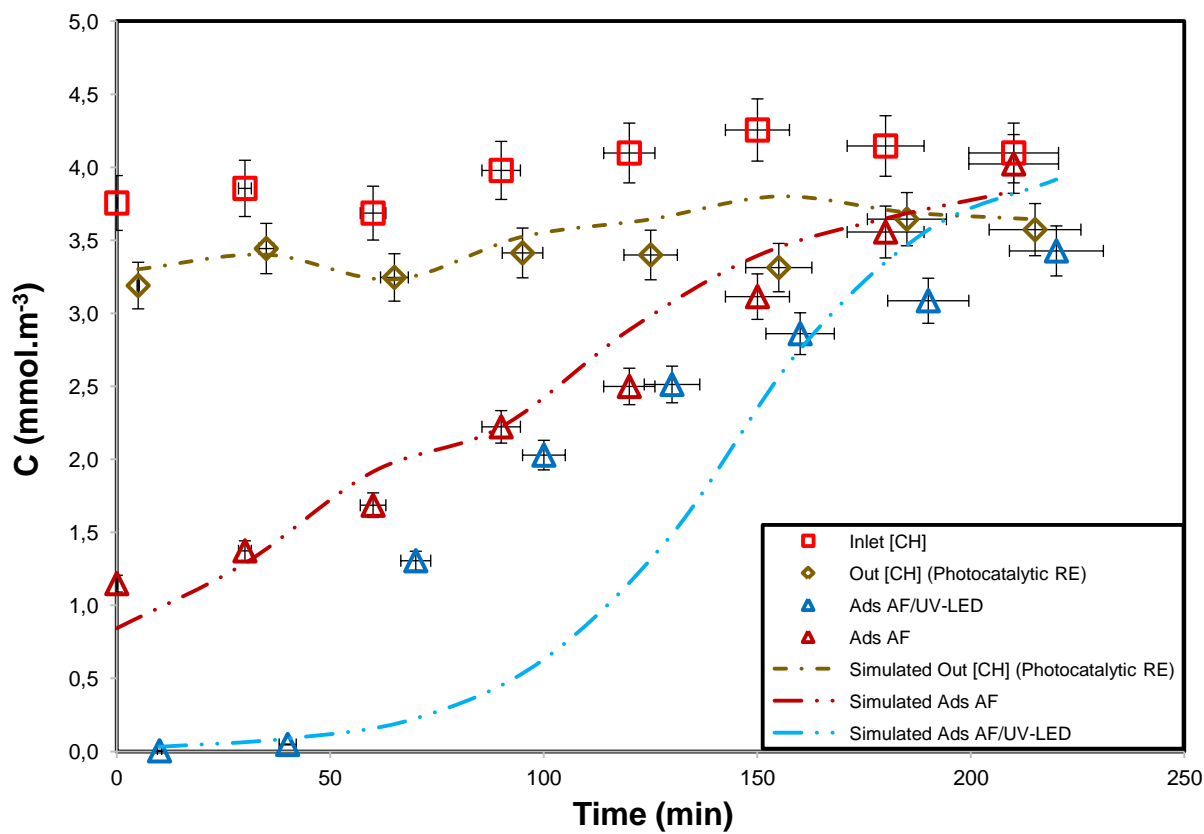

**Figure 10:** Continuous treatment of cyclohexane with AF support alone and with front-flow photocatalytic optimized PFR-LED coupled with AF support at different concentrations of the pollutant a)  $[CH] = 150$  and b)  $300 \text{ mg}\cdot\text{m}^{-3}$  ( $m_{\text{TiO}_2} = 0.78 \text{ g}$ ,  $I = 7.8 \text{ W}\cdot\text{m}^{-2}$ ,  $m_{\text{AF}} = 2.5 \text{ g}$ )/ $Q = 25 \text{ L}\cdot\text{min}^{-1}/\text{HR} = 44 \pm 2\%$ ,  $T = 22 \pm 2^\circ\text{C}$ .

389 Figures 10a and 10b show the air quality that FeTHeMa breathed. They compare the  
390 quality of the air filtered with adsorbent AF alone and the air filtered with adsorption  
391 coupled with the upstream optimized PFR-LED photocatalytic module. The room had  
392 different contamination rates, but the same climatic conditions were maintained for  
393 the different tests. The concentration of the pollutant in the air to be breathed was  
394 measured at different points of the system, namely, the concentration at the inlet,  
395 after the photocatalytic module, and the concentration at the outlet of the filtration  
396 system, the latter representing the actual concentration that the manikin received.

397 The results showed that the upstream implementation of photocatalysis allowed for  
398 relieving the AF adsorbent by lowering the concentration of the pollutant received by  
399 the latter, extending its duration of use by allowing the dummy to breathe clean air for  
400 60 and 30 min (Fig. 10a and 10b, respectively, referencing breakthrough time) more  
401 than during air filtration with AF alone.

402 The results also showed similar behavior to what has been reported in the literature  
403 on the effect of concentration. Such behavior was found in photocatalysis and its  
404 limitation at high concentrations due to the unavailability of active sites [64–66], It  
405 was also found in adsorption, in which the higher the input concentration of the target  
406 gas was, the greater the number of molecules that could be adsorbed, consequently  
407 decreasing the breakthrough time [67][68][69][63].

408 The results were simulated using a model proposed in the authors' previous work  
409 [70] to describe the experimentally observed degradation. Details of the model are

410 provided in the reference paper. This model considered the reaction on the  
411 photocatalytic surface and the mass transfer step Eq. S7 in the supporting  
412 information. The kinetic constants ( $k$  and  $K$ ) were obtained during laboratory tests at  
413 different concentrations for different flow rates for the photocatalytic degradation of  
414 cyclohexane with the optimized PFR-LED module, whose degradation efficiency  
415 results were presented in the authors' previous work [41], The results of the modeling  
416 are shown in Figure S9, in which a good fit of the experimental laboratory results with  
417 the simulated results was noted.

418 This model also allowed for a good description of the experimental results under real  
419 environmental conditions (Fig. 10a and 10b), in which the concentration resulting  
420 from the simulated photocatalytic module (Simulated Out [CH] (photocatalytic RE))  
421 was in agreement with the experimental concentration (Out [CH] (photocatalytic RE))  
422 [66][71][72]. The Clark model also simulated the breakthrough curves to evaluate  
423 adsorption with and without the photocatalytic module. The model correlates well with  
424 the experimental results.

425 Notably, the pressure drop in this purification system based on the coupling of the  
426 optimized PFR-LED photocatalytic module and the AF filter was estimated at 9 Pa.  
427 This finding suggests the possibility of adding photocatalytic or adsorbent  
428 compartments for better treatment efficiency, as indicated in previous work [41], while  
429 remaining within the range of the pressure drop tolerated for anti-gas filtration means  
430 (i.e., protective masks) [73].

431 The analysis of the thermic comfort of the different body parts of the manikin showed  
432 a normal state and stability throughout the experiment (Fig. S8).

#### 433 **4. Conclusions**



434 This study considered using photocatalysis and adsorption coupling to treat chemical  
435 warfare agents, in which mustard gas simulants Methyl Salicylate and Diethyl  
436 Sulphur were tested.

437 To regenerate an adsorbent filter, the photocatalytic module was improved by  
438 implementing Joule desorption (*in situ*), thus increasing the regeneration of the  
439 adsorbent. However, and as already expected, the results showed a decrease in the  
440 adsorption performance of the support after each regeneration cycle. The optimized  
441 coupling system was also tested to cope with the sulfur compound, and the results  
442 were encouraging, counting the competition phenomenon with the by-products.

443 This new optimized coupling configuration with an upstream photocatalytic module  
444 was proven effective for continuously treating chemicals in the laboratory and under  
445 realistic conditions, relieving the pressure on the adsorbent filter and increasing its  
446 working time, shifting the breakthrough time by 30 min in extreme conditions.

447 Finally, this exhaustive investigation overcame scientific obstacles to the design of a  
448 compact, self-contained filter cartridge for personal protection in emergency response  
449 and CBRN management. This new optimized version of the adsorption and  
450 photocatalysis coupling could also have significant potential for onboard gas filtration  
451 equipment's.

## 452 **References**

453 [1] C. Weapons, Chemical weapons convention, Chem. Eng. News. 79 (2001) 23.  
454 <https://doi.org/10.1515/ci.2003.25.4.9>.

455 [2] P. Brassler, M. Sobera, Modelling the comfort and protection qualities of  
456 chemical, biological, radiological and nuclear (CBRN) protective clothing,  
457 Woodhead Publishing Limited, 2012.  
458 <https://doi.org/10.1533/9780857095572.2.238>.

- 459 [3] R.B. Ormond, R.L. Barker, Chemical, biological, radiological and nuclear  
460 (CBRN) protective clothing, Woodhead Publishing Limited, 2014.  
461 <https://doi.org/10.1533/9781782420408.1.112>.
- 462 [4] U. Turaga, R.J. Kendall, V. Singh, M. Lalagiri, S.S. Ramkumar, Advances in  
463 materials for chemical, biological, radiological and nuclear (CBRN) protective  
464 clothing, Woodhead Publishing Limited, 2012.  
465 <https://doi.org/10.1533/9780857095572.2.260>.
- 466 [5] P. Barrois, Auto-Décontaminants Vis-À-Vis D'Agents Chimiques D ' Adsorption  
467 / Filtration D ' Adsorption / Filtration, (2018). HAL Id: tel-01943784  
468 <https://tel.archives-ouvertes.fr/tel-01943784>.
- 469 [6] L.péz-Maya, Textile Metal Organic-Framework Composites as Self-Detoxifying  
470 Filters for. Chem. Int. Ed. 2015, 54,6790 –6794 15213773.  
471 <https://doi.org/10.1002/anie.201502094>.
- 472 [7] A.X. Lu, M. McEntee, M.A. Browe, M.G. Hall, J.B. Decoste, G.W. Peterson,  
473 MOFabric: Electrospun Nanofiber Mats from PVDF/UiO-66-NH<sub>2</sub> for Chemical  
474 Protection and Decontamination, ACS Appl. Mater. Interfaces. 9 (2017) 13632–  
475 13636. <https://doi.org/10.1021/acsami.7b01621>.
- 476 [8] A.O. Mateescu, G. Mateescu, I. Burducea, P. Mereuta, L. Chirila, A. Popescu,  
477 M. Stroe, A. Nila, M. Baibarac, Textile Materials Treatment With Mixture of  
478 TiO<sub>2</sub>:N and SiO<sub>2</sub> Nanoparticles for Improvement of Their Self-Cleaning  
479 Properties, J. Nat. Fibers. 19 (2022) 2443–2456.  
480 <https://doi.org/10.1080/15440478.2020.1818349>.
- 481 [9] J. V. Romero, J.W.H. Smith, B.M. Sullivan, L. MacDonald, L.M. Croll, J.R.  
482 Dahn, Evaluation of the SO<sub>2</sub> and NH<sub>3</sub> gas adsorption properties of  
483 CuO/ZnO/Mn<sub>3</sub>O<sub>4</sub> and CuO/ZnO/NiO ternary impregnated activated carbon  
484 using combinatorial materials science methods, ACS Comb. Sci. 15 (2013)  
485 101–110. <https://doi.org/10.1021/co3001132>.
- 486 [10] E. Altintig, S. Kirkil, Preparation and properties of Ag-coated activated carbon  
487 nanocomposites produced from wild chestnut shell by ZnCl<sub>2</sub> activation, J.  
488 Taiwan Inst. Chem. Eng. 63 (2016) 180–188.  
489 <https://doi.org/10.1016/j.jtice.2016.02.032>.

- 490 [11] S.S. Kiani, A. Farooq, M. Ahmad, N. Irfan, M. Nawaz, M.A. Irshad,  
491 Impregnation on activated carbon for removal of chemical warfare agents  
492 (CWAs) and radioactive content, *Environ. Sci. Pollut. Res.* 28 (2021) 60477–  
493 60494. <https://doi.org/10.1007/s11356-021-15973-1>.
- 494 [12] F. Vuong, R. Chauveau, G. Grevillot, S. Marsteau, E. Silvente, C. Vallieres,  
495 Predicting the lifetime of organic vapor cartridges exposed to volatile organic  
496 compound mixtures using a partial differential equations model, *J. Occup.*  
497 *Environ. Hyg.* 13 (2016) 675–689.  
498 <https://doi.org/10.1080/15459624.2016.1166368>.
- 499 [13] B. Bakbolat, C. Daulbayev, F. Sultanov, R. Beissenov, A. Umirzakov, A.  
500 Mereke, A. Bekbaev, I. Chuprakov, Recent developments of TiO<sub>2</sub>-based  
501 photocatalysis in the hydrogen evolution and photodegradation: A review,  
502 *Nanomaterials.* 10 (2020) 1–16. <https://doi.org/10.3390/nano10091790>.
- 503 [14] V.K.H. Bui, T.N. Nguyen, V. Van Tran, J. Hur, I.T. Kim, D. Park, Y.C. Lee,  
504 Photocatalytic materials for indoor air purification systems: An updated mini-  
505 review, *Environ. Technol. Innov.* 22 (2021) 101471.  
506 <https://doi.org/10.1016/j.eti.2021.101471>.
- 507 [15] J. Oliveira De Brito Lira, H.G. Riella, N. Padoin, C. Soares, An Overview of  
508 Photoreactors and Computational Modeling for the Intensification of  
509 Photocatalytic Processes in the Gas-Phase: State-of-Art, *J. Environ. Chem.*  
510 *Eng.* 9 (2021). <https://doi.org/10.1016/j.jece.2021.105068>.
- 511 [16] F. He, W. Jeon, W. Choi, Photocatalytic air purification mimicking the self-  
512 cleaning process of the atmosphere, *Nat. Commun.* 12 (2021) 10–13.  
513 <https://doi.org/10.1038/s41467-021-22839-0>.
- 514 [17] A. Talaiekhosravi, S. Rezaei, K.H. Kim, R. Sanaye, A.M. Amani, Recent  
515 advances in photocatalytic removal of organic and inorganic pollutants in air, *J.*  
516 *Clean. Prod.* 278 (2021) 123895. <https://doi.org/10.1016/j.jclepro.2020.123895>.
- 517 [18] C. Yang, G. Miao, Y. Pi, Q. Xia, J. Wu, Z. Li, J. Xiao, Abatement of various  
518 types of VOCs by adsorption/catalytic oxidation: A review, *Chem. Eng. J.* 370  
519 (2019) 1128–1153. <https://doi.org/10.1016/j.cej.2019.03.232>.
- 520 [19] W. Zou, B. Gao, Y.S. Ok, L. Dong, Integrated adsorption and photocatalytic

- 521 degradation of volatile organic compounds (VOCs) using carbon-based  
522 nanocomposites: A critical review, *Chemosphere*. 218 (2019) 845–859.  
523 <https://doi.org/10.1016/j.chemosphere.2018.11.175>.
- 524 [20] C.T. Chekem, Y. Richardson, M. Drobek, G. Plantard, J. Blin, V. Goetz,  
525 Effective coupling of phenol adsorption and photodegradation at the surface of  
526 micro-and mesoporous TiO<sub>2</sub>-activated carbon materials, *React. Kinet. Mech.*  
527 *Catal.* 122 (2017) 1297–1321. <https://doi.org/10.1007/s11144-017-1265-0>.
- 528 [21] S. Ali, Z. Li, S. Chen, A. Zada, I. Khan, I. Khan, W. Ali, S. Shaheen, Y. Qu, L.  
529 Jing, Synthesis of activated carbon-supported TiO<sub>2</sub>-based nano-photocatalysts  
530 with well recycling for efficiently degrading high-concentration pollutants, *Catal.*  
531 *Today*. 335 (2019) 557–564. <https://doi.org/10.1016/j.cattod.2019.03.044>.
- 532 [22] V. Lekshmi Mohan, S.M. Shiva Nagendra, M.P. Maiya, Photocatalytic  
533 degradation of gaseous toluene using self-assembled air filter based on  
534 chitosan/activated carbon/TiO<sub>2</sub>, *J. Environ. Chem. Eng.* 7 (2019) 103455.  
535 <https://doi.org/10.1016/j.jece.2019.103455>.
- 536 [23] N.N. Bahrudin, Evaluation of degradation kinetic and photostability of  
537 immobilized TiO<sub>2</sub>/activated carbon bilayer photocatalyst for phenol removal,  
538 *Appl. Surf. Sci. Adv.* 7 (2022) 100208.  
539 <https://doi.org/10.1016/j.apsadv.2021.100208>.
- 540 [24] W.K. Jo, C.H. Yang, Granular-activated carbon adsorption followed by annular-  
541 type photocatalytic system for control of indoor aromatic compounds, *Sep.*  
542 *Purif. Technol.* 66 (2009) 438–442.  
543 <https://doi.org/10.1016/j.seppur.2009.02.014>.
- 544 [25] E. Hallemans, G. Coulbaux, M. Binet, C. Hort, L. Moynault, V. Hequet, Y.  
545 Andres, E. Hallemans, G. Coulbaux, M. Binet, C. Hort, V. Platel, CUBAIR ,  
546 Confort des Usagers des Bâtiments tertiaires par l ' usage de techniques de  
547 traitement de l ' AIR To cite this version : HAL Id : hal-02363808, (2019).
- 548 [26] R. Jain, M. Mathur, S. Sikarwar, A. Mittal, Removal of the hazardous dye  
549 rhodamine B through photocatalytic and adsorption treatments, *J. Environ.*  
550 *Manage.* 85 (2007) 956–964. <https://doi.org/10.1016/j.jenvman.2006.11.002>.
- 551 [27] T.T. Lim, P.S. Yap, M. Srinivasan, A.G. Fane, TiO<sub>2</sub>/AC composites for

- 552 synergistic adsorption-photocatalysis processes: Present challenges and  
553 further developments for water treatment and reclamation, *Crit. Rev. Environ.*  
554 *Sci. Technol.* 41 (2011) 1173–1230.  
555 <https://doi.org/10.1080/10643380903488664>.
- 556 [28] A.H. Mamaghani, F. Haghghat, C.S. Lee, Photocatalytic degradation of VOCs  
557 on various commercial titanium dioxides: Impact of operating parameters on  
558 removal efficiency and by-products generation, *Build. Environ.* 138 (2018) 275–  
559 282. <https://doi.org/10.1016/j.buildenv.2018.05.002>.
- 560 [29] C. Andriantsiferana, E.F. Mohamed, H. Delmas, Sequential adsorption -  
561 Photocatalytic oxidation process for wastewater treatment using a composite  
562 material TiO<sub>2</sub>/activated carbon, *Environ. Eng. Res.* 20 (2015) 181–189.  
563 <https://doi.org/10.4491/eer.2014.070>.
- 564 [30] R. Chauveau, Modélisation multiparamètre du phénomène d'adsorption :  
565 détermination du temps de percée des cartouches de masques à gaz To cite  
566 this version : HAL Id : tel-01751295 soutenance et mis à disposition de l'  
567 ensemble de la Contact : [ddoc-theses-contact@uni](mailto:ddoc-theses-contact@uni), (2018).
- 568 [31] B.C. Singer, A.T. Hodgson, H. Destailats, T. Hotchi, K.L. Revzan, R.G. Sextro,  
569 Indoor sorption of surrogates for sarin and related nerve agents, *Environ. Sci.*  
570 *Technol.* 39 (2005) 3203–3214. <https://doi.org/10.1021/es049144u>.
- 571 [32] M. Spiandore, A. Piram, A. Lacoste, D. Josse, P. Doumenq, Hair analysis as a  
572 useful procedure for detection of vapour exposure to chemical warfare agents:  
573 Simulation of sulphur mustard with methyl salicylate, *Drug Test. Anal.* 6 (2014)  
574 67–73. <https://doi.org/10.1002/dta.1659>.
- 575 [33] R.J. Feldman, Chemical agent simulant release from clothing following vapor  
576 exposure, *Acad. Emerg. Med.* 17 (2010) 221–224.  
577 <https://doi.org/10.1111/j.1553-2712.2009.00650.x>.
- 578 [34] G. Bikelytė, M.A.C. Härtel, T.M. Klapötke, B. Krumm, A. Sadaunykas,  
579 Experimental thermochemical data of CWA simulants: Triethyl phosphate,  
580 diethyl methylphosphonate, malathion and methyl salicylate, *J. Chem.*  
581 *Thermodyn.* 143 (2020). <https://doi.org/10.1016/j.jct.2019.106043>.
- 582 [35] S.L. Bartelt-Hunt, D.R.U. Knappe, M.A. Barlaz, A review of chemical warfare

- 583 agent simulants for the study of environmental behavior, *Crit. Rev. Environ.*  
584 *Sci. Technol.* 38 (2008) 112–136. <https://doi.org/10.1080/10643380701643650>.
- 585 [36] M. Grandcolas, T. Cottineau, A. Louvet, N. Keller, V. Keller, Solar light-  
586 activated photocatalytic degradation of gas phase diethylsulfide on WO<sub>3</sub>-  
587 modified TiO<sub>2</sub> nanotubes, *Appl. Catal. B Environ.* 138–139 (2013) 128–140.  
588 <https://doi.org/10.1016/j.apcatb.2013.02.041>.
- 589 [37] A. Sengele, D. Robert, N. Keller, V. Keller, Modified-tio<sub>2</sub> photocatalyst  
590 supported on β-sic foams for the elimination of gaseous diethyl sulfide as an  
591 analog for chemical warfare agent: Towards the development of a photoreactor  
592 prototype, *Catalysts*. 11 (2021). <https://doi.org/10.3390/catal11030403>.
- 593 [38] A. Sengele, D. Robert, N. Keller, V. Keller, A. Herissan, C. Colbeau-Justin, Ta-  
594 doped TiO<sub>2</sub> as photocatalyst for UV-A activated elimination of chemical warfare  
595 agent simulant, *J. Catal.* 334 (2016) 129–141.  
596 <https://doi.org/10.1016/j.jcat.2015.11.004>.
- 597 [39] W. Abou Saoud, A. Kane, P. Le Cann, A. Gerard, L. Lamaa, L. Peruchon, C.  
598 Brochier, A. Bouzaza, D. Wolbert, A.A. Assadi, Innovative photocatalytic  
599 reactor for the degradation of VOCs and microorganism under simulated indoor  
600 air conditions: Cu-Ag/TiO<sub>2</sub>-based optical fibers at a pilot scale, *Chem. Eng. J.*  
601 411 (2021) 128622. <https://doi.org/10.1016/j.cej.2021.128622>.
- 602 [40] M. Abidi, A. Hajjaji, A. Bouzaza, L. Lamaa, L. Peruchon, C. Brochier, S. Rtimi,  
603 D. Wolbert, B. Bessais, A. Amin Assadi, Modeling of indoor air treatment using  
604 an innovative photocatalytic luminous textile: reactor compactness and mass  
605 transfer enhancement, *Chem. Eng. J.* (2021) 132636.  
606 <https://doi.org/10.1016/j.cej.2021.132636>.
- 607 [41] Y. Serhane, A. Bouzaza, D. Wolbert, A.A. Assadi, New UV-LED frontal flow  
608 photocatalytic reactor for VOCs treatment: Compactness, intensification and  
609 optimization studies, *Chem. Eng. J.* 451 (2023) 138784.  
610 <https://doi.org/10.1016/j.cej.2022.138784>.
- 611 [42] P.A. Bourgeois, E. Puzenat, L. Peruchon, F. Simonet, D. Chevalier, E. Deflin,  
612 C. Brochier, C. Guillard, Characterization of a new photocatalytic textile for  
613 formaldehyde removal from indoor air, *Appl. Catal. B Environ.* 128 (2012) 171–  
614 178. <https://doi.org/10.1016/j.apcatb.2012.03.033>.

- 615 [43] C. Brochier, D. Malhomme, E. Deflin-Brevet « Nappe textile présentant des  
616 propriétés dépolluantes par photocatalyse » -no. de délivrance FR2910341,  
617 2008-06-27 (A1) et FR2910341, 2009-02-06 (B1), 2007..
- 618 [44] C. Indermühle, E. Puzenat, F. Simonet, L. Peruchon, C. Brochier, C. Guillard,  
619 Modelling of UV optical ageing of optical fibre fabric coated with TiO<sub>2</sub>, Appl.  
620 Catal. B Environ. 182 (2016) 229–235.  
621 <https://doi.org/10.1016/j.apcatb.2015.09.037>.
- 622 [45] P. Danca, F. Bode, A. Meslem, C. Croitoru, M. Sandu, I. Nastase, C. Lungu, L.  
623 Batali, A. Correspondant, Experimental investigation of thermal vehicular  
624 environment during the summer season, n.d.
- 625 [46] R.M. Clark, Evaluating the Cost and Performance of Field-Scale Granular  
626 Activated Carbon Systems, Environ. Sci. Technol. 21 (1987) 573–580.  
627 <https://doi.org/10.1021/es00160a008>.
- 628 [47] W. Abou Saoud, A.A. Assadi, M. Guiza, A. Bouzaza, W. Aboussaoud, A.  
629 Ouederni, I. Soutrel, D. Wolbert, S. Rtimi, Study of synergetic effect, catalytic  
630 poisoning and regeneration using dielectric barrier discharge and  
631 photocatalysis in a continuous reactor: Abatement of pollutants in air mixture  
632 system, Appl. Catal. B Environ. 213 (2017) 53–61.  
633 <https://doi.org/10.1016/j.apcatb.2017.05.012>.
- 634 [48] D. Lancmuir, J.S. Herman, 1-S2.0-0016703780902264-Main, 44 (2002) 1–14.  
635 [papers2://publication/uuid/5E9E5D34-242B-4117-8B39-BF4464A10B4B](https://doi.org/10.1016/j.apcatb.2017.05.012).
- 636 [49] R. Briner, D. Chevillat, S. Neff, M. Scheen, Complémentaire Dans Le  
637 Traitement De L ' Épilepsie ?, 33 (2013) 1–41.
- 638 [50] V.E. Malheureusement, ergonomie Débit ventilatoire de travail, (1998) 343–  
639 350.
- 640 [51] M. Malayeri, F. Haghghat, C.S. Lee, Kinetic modeling of the photocatalytic  
641 degradation of methyl ethyl ketone in air for a continuous-flow reactor, Chem.  
642 Eng. J. 404 (2021) 126602. <https://doi.org/10.1016/j.cej.2020.126602>.
- 643 [52] G. Zhang, Y. Liu, Z. Hashisho, Z. Sun, S. Zheng, L. Zhong, Adsorption and  
644 photocatalytic degradation performances of TiO<sub>2</sub>/diatomite composite for  
645 volatile organic compounds: Effects of key parameters, Appl. Surf. Sci. 525

- 646 (2020). <https://doi.org/10.1016/j.apsusc.2020.146633>.
- 647 [53] J. Chen, G. Li, Z. He, T. An, Adsorption and degradation of model volatile  
648 organic compounds by a combined titania-montmorillonite-silica photocatalyst,  
649 J. Hazard. Mater. 190 (2011) 416–423.  
650 <https://doi.org/10.1016/j.jhazmat.2011.03.064>.
- 651 [54] A.M. Vandenbroucke, R. Morent, N. De Geyter, C. Leys, Non-thermal plasmas  
652 for non-catalytic and catalytic VOC abatement, J. Hazard. Mater. 195 (2011)  
653 30–54. <https://doi.org/10.1016/j.jhazmat.2011.08.060>.
- 654 [55] T. Martinez, A. Bertron, G. Escadeillas, E. Ringot, V. Simon, BTEX abatement  
655 by photocatalytic TiO<sub>2</sub>-bearing coatings applied to cement mortars, Build.  
656 Environ. 71 (2014) 186–192. <https://doi.org/10.1016/j.buildenv.2013.10.004>.
- 657 [56] B. Boulinguez. Procédé d'adsorption et régénération électrothermique sur  
658 textile de carbone activé - Une solution pour la problématique des COV dans  
659 des gaz à fort potentiel énergétique. (2010). [https://theses.hal.science/tel-](https://theses.hal.science/tel-00540206)  
660 [00540206](https://theses.hal.science/tel-00540206).
- 661 [57] W. Abou Saoud, A.A. Assadi, A. Kane, A.V. Jung, P. Le Cann, A. Gerard, F.  
662 Bazantay, A. Bouzaza, D. Wolbert, Integrated process for the removal of indoor  
663 VOCs from food industry manufacturing: Elimination of Butane-2,3-dione and  
664 Heptan-2-one by cold plasma-photocatalysis combination, J. Photochem.  
665 Photobiol. A Chem. 386 (2020) 112071.  
666 <https://doi.org/10.1016/j.jphotochem.2019.112071>.
- 667 [58] S. Deepracha, A. Ayrat, M. Ogawa, Acceleration of the photocatalytic  
668 degradation of organics by in-situ removal of the products of degradation, Appl.  
669 Catal. B Environ. 284 (2021). <https://doi.org/10.1016/j.apcatb.2020.119705>.
- 670 [59] M. Dell'Edera, C. Lo Porto, I. De Pasquale, F. Petronella, M.L. Curri, A.  
671 Agostiano, R. Comparelli, Photocatalytic TiO<sub>2</sub>-based coatings for  
672 environmental applications, Catal. Today. 380 (2021) 62–83.  
673 <https://doi.org/10.1016/j.cattod.2021.04.023>.
- 674 [60] A. Sengele, Décontamination et dépollution par photocatalyse : réalisation d'  
675 un dispositif d'élimination d'agents chimiques toxiques et de polluants dans l'  
676 air et dans l'eau Armelle Sengele To cite this version : HAL Id : tel-01304774,



- 677 (2016).
- 678 [61] Z. Aslam, I.A. Hussein, R.A. Shawabkeh, M.A. Parvez, W. Ahmad, Ihsanullah,  
679 Adsorption kinetics and modeling of H<sub>2</sub>S by treated waste oil fly ash, *J. Air*  
680 *Waste Manag. Assoc.* 69 (2019) 246–257.  
681 <https://doi.org/10.1080/10962247.2018.1536004>.
- 682 [62] S. Kamravaei, P. Shariaty, M. Jahandar Lashaki, J.D. Atkinson, Z. Hashisho,  
683 J.H. Phillips, J.E. Anderson, M. Nichols, Effect of Beaded Activated Carbon  
684 Fluidization on Adsorption of Volatile Organic Compounds, *Ind. Eng. Chem.*  
685 *Res.* 56 (2017) 1297–1305. <https://doi.org/10.1021/acs.iecr.6b04165>.
- 686 [63] S.K. Kam, M.G. Lee, Adsorption characteristics of antibiotics amoxicillin in  
687 aqueous solution with activated carbon prepared from waste citrus peel, *Appl.*  
688 *Chem. Eng.* 29 (2018) 369–375. <https://doi.org/10.14478/ace.2018.1015>.
- 689 [64] W. Abou Saoud, A.A. Assadi, M. Guiza, A. Bouzaza, W. Aboussaoud, I.  
690 Soutrel, A. Ouederni, D. Wolbert, S. Rtimi, Abatement of ammonia and  
691 butyraldehyde under non-thermal plasma and photocatalysis: Oxidation  
692 processes for the removal of mixture pollutants at pilot scale, *Chem. Eng. J.*  
693 344 (2018) 165–172. <https://doi.org/10.1016/j.cej.2018.03.068>.
- 694 [65] T. Zadi, M. Azizi, N. Nasrallah, A. Bouzaza, R. Maachi, D. Wolbert, S. Rtimi,  
695 A.A. Assadi, Indoor air treatment of refrigerated food chambers with synergetic  
696 association between cold plasma and photocatalysis: Process performance  
697 and photocatalytic poisoning, *Chem. Eng. J.* 382 (2020) 122951.  
698 <https://doi.org/10.1016/j.cej.2019.122951>.
- 699 [66] A.A. Assadi, J. Palau, A. Bouzaza, D. Wolbert, Modeling of a continuous  
700 photocatalytic reactor for isovaleraldehyde oxidation: Effect of different  
701 operating parameters and chemical degradation pathway, *Chem. Eng. Res.*  
702 *Des.* 91 (2013) 1307–1316. <https://doi.org/10.1016/j.cherd.2013.02.020>.
- 703 [67] D.T. Tefera, Z. Hashisho, J.H. Phillips, J.E. Anderson, M. Nichols, Modeling  
704 competitive adsorption of mixtures of volatile organic compounds in a fixed-bed  
705 of beaded activated carbon, *Environ. Sci. Technol.* 48 (2014) 5108–5117.  
706 <https://doi.org/10.1021/es404667f>.
- 707 [68] W.K. Pui, R. Yusoff, M.K. Aroua, A review on activated carbon adsorption for

- 708 volatile organic compounds (VOCs), *Rev. Chem. Eng.* 35 (2019) 649–668.  
709 <https://doi.org/10.1515/revce-2017-0057>.
- 710 [69] Z. Aslam, I.A. Hussein, R.A. Shawabkeh, M.A. Parvez, W. Ahmad, Ihsanullah,  
711 Adsorption kinetics and modeling of H<sub>2</sub>S by treated waste oil fly ash, *J. Air*  
712 *Waste Manag. Assoc.* 69 (2019) 246–257.  
713 <https://doi.org/10.1080/10962247.2018.1536004>.
- 714 [70] Y. Serhane, N. Belkessa, A. Bouzaza, D. Wolbert, A.A. Assadi, Continuous air  
715 purification by front flow photocatalytic reactor: Modelling of the influence of  
716 mass transfer step under simulated real conditions, *Chemosphere.* 295 (2022)  
717 133809. <https://doi.org/10.1016/j.chemosphere.2022.133809>.
- 718 [71] A.A. Assadi, B. Abdelkrim, W. Dominique, Kinetic Modeling of VOC  
719 Photocatalytic Degradation Using a Process at Different Reactor  
720 Configurations and Scales, *Int. J. Chem. React. Eng.* 14 (2016) 395–405.  
721 <https://doi.org/10.1515/ijcre-2015-0003>.
- 722 [72] A.A. Assadi, A. Bouzaza, D. Wolbert, Photocatalytic oxidation of trimethylamine  
723 and isovaleraldehyde in an annular reactor: Influence of the mass transfer and  
724 the relative humidity, *J. Photochem. Photobiol. A Chem.* 236 (2012) 61–69.  
725 <https://doi.org/10.1016/j.jphotochem.2012.03.020>.
- 726 [73] S. Bourassa, Impact sur le travail respiratoire et les échanges gazeux pour l' '   
727 utilisateur d' un masque à gaz Impact sur le travail respiratoire et les échanges  
728 gazeux pour l' ' utilisateur d'un masque à gaz, (2017). [corpus.ulaval.ca](https://corpus.ulaval.ca)

729

730

731