



HAL
open science

NETWORK PROTOCOLS FOR SIMULTANEOUS UNDERWATER ACOUSTIC COMMUNICATION AND TARGET DETECTION

Nils Morozs, Benoît Parrein, Lu Shen, Benjamin T Henson, Paul D Mitchell

► **To cite this version:**

Nils Morozs, Benoît Parrein, Lu Shen, Benjamin T Henson, Paul D Mitchell. NETWORK PROTOCOLS FOR SIMULTANEOUS UNDERWATER ACOUSTIC COMMUNICATION AND TARGET DETECTION. UK Acoustics network (UACE), Jun 2023, Kalamata, Greece. hal-04192220

HAL Id: hal-04192220

<https://hal.science/hal-04192220>

Submitted on 31 Aug 2023

HAL is a multi-disciplinary open access archive for the deposit and dissemination of scientific research documents, whether they are published or not. The documents may come from teaching and research institutions in France or abroad, or from public or private research centers.

L'archive ouverte pluridisciplinaire **HAL**, est destinée au dépôt et à la diffusion de documents scientifiques de niveau recherche, publiés ou non, émanant des établissements d'enseignement et de recherche français ou étrangers, des laboratoires publics ou privés.

NETWORK PROTOCOLS FOR SIMULTANEOUS UNDERWATER ACOUSTIC COMMUNICATION AND TARGET DETECTION

Nils Morozs^{*,1}, Benoît Parrein², Lu Shen¹, Benjamin T. Henson¹, Paul D. Mitchell¹

¹ School of Physics, Engineering and Technology, University of York, York YO10 5DD, UK

² Nantes Université, Polytech Nantes, CNRS, LS2N, UMR 6004, F-44000 Nantes, France

* Corresponding author: Nils Morozs, nils.morozs@york.ac.uk, +44 1904 322395

Acknowledgements: This work was supported by the UK EPSRC through the COUSIN project grant (EP/V009591/1). The simulation study was carried out on the Viking Cluster – an HPC facility provided by the University of York.

Abstract: *Underwater monitoring and surveillance involves the detection, classification, localisation and tracking of targets underwater. Typical approaches involve the use of dedicated sensor systems for detection, e.g. monostatic/multistatic sonar, passive acoustic sensors or visual/infrared cameras, and a separate communication system for the nodes to deliver the data to shore. In this paper, we consider an alternative way of detecting underwater targets – simultaneous underwater acoustic communication (UAC) and target detection using a network of underwater nodes, where regular data transmissions are “reused” for the purpose of target detection. In particular, this study focuses on the development of network protocols that can enable such networks to: 1) detect potential targets moving through water; 2) deliver the detection information reliably and with adequate latency to a master station on shore. To this end, we develop a solution based on Spatial Time Division Multiple Access (STDMA), robust multipath routing, and data aggregation at the relays. The simulation studies show that the STDMA-based Link layer provides a high probability of detection for targets moving at typical AUV speeds (up to 2 m/s), while the Gradient routing protocol combined with data aggregation at the network nodes provides a good trade-off between the end-to-end packet delivery ratio and latency, compared with Flooding and shortest path routing.*

Keywords: *Network Protocols, Underwater Surveillance, Underwater Acoustic Network*

1. INTRODUCTION

Underwater monitoring and surveillance are crucial tasks for countries with a coastline [1, 2]. They involve the detection, classification, localisation and tracking of targets underwater, such as autonomous underwater or surface vehicles (AUV/ASV), marine mammals, sharks, divers, surface vessels and submarines [1]; and protection of critical offshore infrastructure [3].

Typical approaches to underwater target detection involve the use of dedicated sensor systems, e.g. monostatic/multistatic sonar [4], passive acoustic sensors [5] or visual/infrared cameras [1]. A disadvantage of these systems is that, after a possible target detection, an underwater node needs to communicate either processed or raw detection data to a station on shore, which requires a separate communication system, using: (a) subsea cables; (b) tether to the surface + radio link; or (c) most practically, underwater acoustic communications (UAC) [6].

In this paper, we consider an alternative way of detecting underwater targets – simultaneous UAC and target detection using a network of underwater nodes. It can be achieved via anomaly detection in the estimated channel impulse response (CIR) for every data transmission from a given source, e.g. detecting significant signal paths appearing or disappearing in a pattern that may be caused by a moving target in the water. It is similar to the idea of multistatic sonar [4], but instead of dedicated sonar transmissions, regular data transmissions from the network nodes are “reused” for the target detection purpose. In particular, we focus on developing the network protocol stack for such a *cooperative underwater surveillance network (COUSIN)* and evaluating the target detection performance of this network, as well as the end-to-end (E2E) latency and reliability of the network in delivering the detection information to a gateway with connection to shore.

In [7] we focused on the design of the MAC layer for such a target detection network. Our proposed solution is based on Spatial Time Division Multiple Access (STDMA), which fits well with the regular traffic pattern produced by this network and was shown to produce good target detection performance, assuming the requisite precise channel estimation capability at the PHY layer. The focus of this study is to add the Network layer to the protocol stack and to evaluate end-to-end latency and reliability of the COUSIN network in delivering the detection information to the shore.

The key function of the Network layer is *routing* [8] – providing end-to-end (E2E) connectivity in a *multi-hop* network, where packets have to be forwarded between the source and the destination by intermediate nodes or *relays*. The most widely used routing strategy is to minimise the *hop distance*, i.e. to choose the route with the fewest hops between the source and the destination. This requires the nodes to maintain estimates of hop distances to all potential destinations, which can be done: a) *proactively* – using regular control transmissions to count the number of hops to every destination; 2) *on-demand* – performing such route discovery only when it is needed (when a new packet needs to be sent). There are many well-established routing protocols in the literature [8], e.g. proactive: Optimised Link State Routing (OLSR), reactive: Ad-hoc On-demand Distance Vector (AODV) and Dynamic Source Routing (DSR). Sending a packet via the single shortest route makes it vulnerable to packet loss and the need for retransmissions which typically incur high latency in UAC. As a more robust alternative to shortest path routing, we investigate the use of multipath routing, in particular, Gradient routing [9], where the packets may be delivered to the destination via multiple routes. The aim of multipath routing is to increase the network robustness to random link fading and changes in the topology. Finally, we also investigate Network layer packet aggregation strategies to achieve a good trade-off between E2E latency and reliability.

The rest of the paper is organised as follows: Section 2 describes the proposed system setup for target detection using UAC; Section 3 describes our proposed protocols for the MAC and Network Layer; Section 4 presents the results of the simulation study; finally, Section 5 gives conclusions and directions for further work.

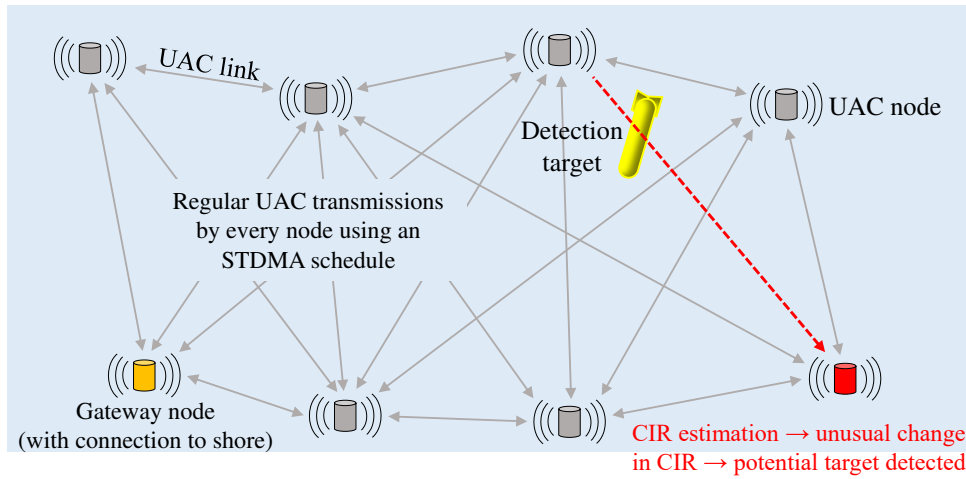

Figure 1: Target detection using a network of UAC nodes performing channel impulse response (CIR) estimation on every reception [7].

2. SYSTEM SETUP

The target detection network setup proposed in [7] is depicted in Fig. 1. A number of UAC nodes are deployed in the area of interest, e.g. along a sea coast, in a harbour, or close to critical offshore infrastructure, etc. Every node regularly broadcasts a data packet, which is received by a number of other nodes within its acoustic connection range. For every packet reception, all receiving nodes estimate the CIR and compare it with the CIRs measured during previous transmissions from the same source node. If they detect an anomaly in the CIR, e.g. additional reflections or an obstruction of a direct signal path, this could signify the presence of a target in the water. Due to the highly time-varying, rich multipath structure of UAC channels, it would be impossible to ascertain that a given CIR anomaly is indeed caused by a target in the water. Therefore, such a network would work as a “first alert” system in detecting and localising possible targets, which could then be followed up by the deployment of a sonar-equipped AUV to scan the identified area in more detail.

3. NETWORK PROTOCOLS

3.1. MAC Layer

In [7] we developed the MAC layer based on Spatial Time Division Multiple Access (STDMA) [10] for the target detection network studied in this paper. Figure 2 shows an illustrative example of how STDMA works. All nodes have a coarsely synchronised time reference and follow a

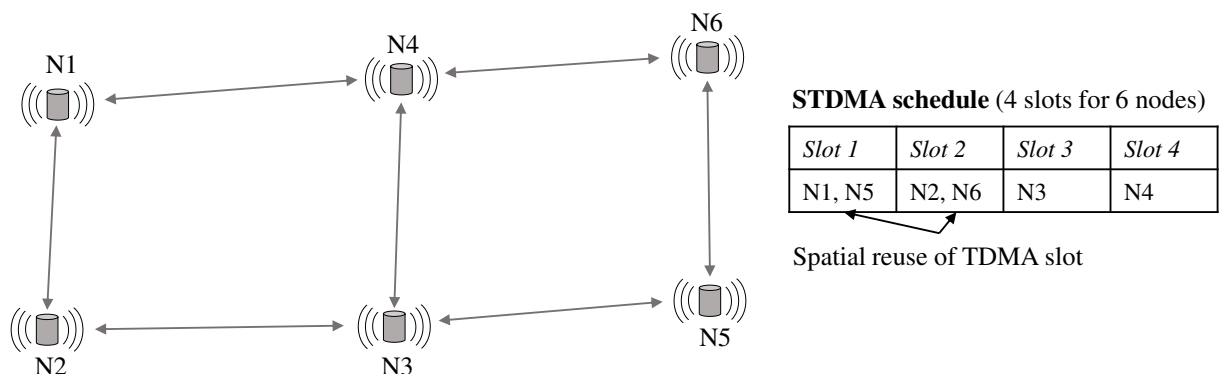

Figure 2: Spatial reuse of time slots in a sparsely connected network using STDMA.

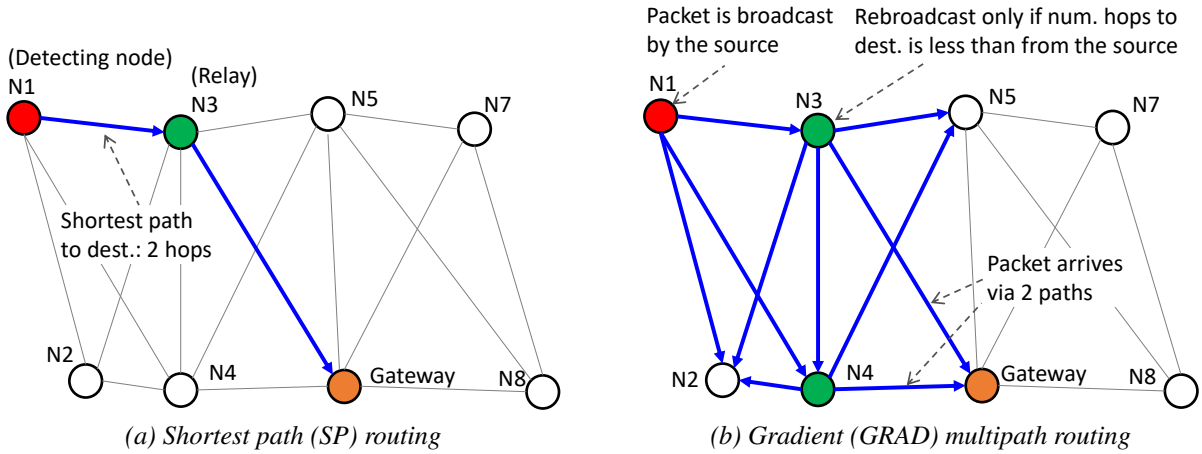

Figure 3: Examples of single path vs multipath routing protocols.

common transmission schedule, where each node has been allocated a particular time slot for its transmission. The slot duration is set to a large enough value to ensure that transmissions from any two interfering nodes are separated in time, such that they never collide at a common receiver. Some of the nodes can transmit simultaneously without collision (e.g. N1 & N5; N2 & N6) due to the sparse connectivity of the network. This frame pattern is then repeated in time, such that, in this example, every node gets an opportunity to transmit every four slots.

3.2. Network Layer

Figure 3 shows examples of shortest path (SP) and Gradient (GRAD) multipath routing [9]. In Figure 3a the source node (N1) looks up the shortest path to the destination (gateway) based on its locally stored hop distance estimates. In this case the shortest possible distance is 2 hops with two route options: N1-N3-gateway and N1-N4-gateway; both are equally short routes, therefore, N1 can select either N3 or N4 at random (in this case – N3). Proactive route discovery, such as that used in OLSR, is well-suited to the COUSIN network studied in this paper, since it already has an STDMA schedule of regular transmissions in place for the purpose of target detection; therefore periodic hop count updates can be “piggybacked” onto those transmissions with a minor increase in the packet header size. Figure 3b depicts a more robust alternative to SP routing: GRAD multipath routing [9], which aims to increase the network robustness to random link fading and topology changes. Here, the packet source (N1) does not specify the next hop destination, but instead broadcasts the packet to all its neighbours (similarly to Flooding [11]). It includes an *estimated number of hops to destination* field in the packet header (in this case: 2 hops), and any nodes whose estimated number of hops is smaller rebroadcast the packet, decrementing this control field by 1 hop. In this way the packet may arrive at the destination via multiple routes by *descending the gradient* of the hop distance.

3.3. Data Aggregation

Information about a single detection can be compressed into a relatively small data payload, e.g. 4 bytes, including: 1) a quantised time stamp (e.g. STDMA frame number), 2) link identifier (e.g. source of the transmission that triggered a detection), 3) detection type (e.g. new significant reflection, obstructed main path etc.), 4) a measure of confidence in this detection (e.g. a 4-bit integer). This means that multiple detection records can be aggregated into a single packet to: a) increase robustness by introducing redundancy; b) decrease latency by appending new detections to already scheduled packets.

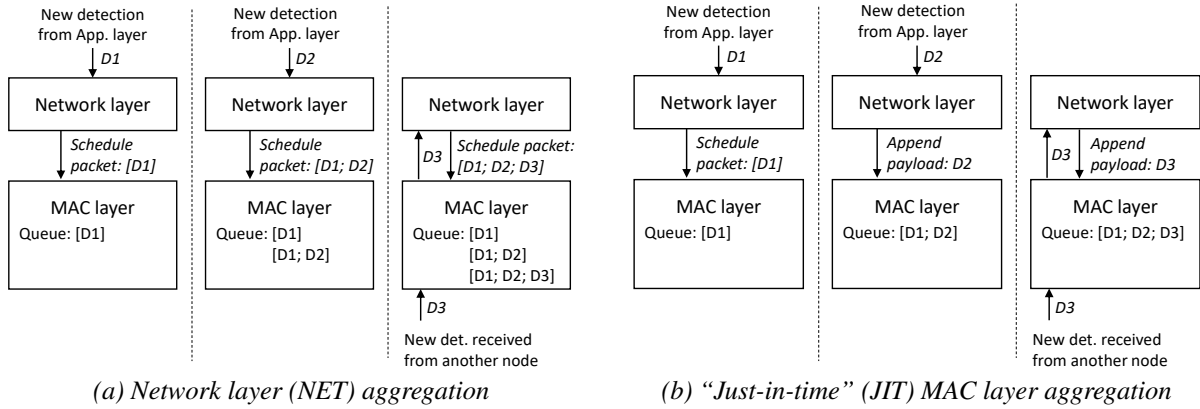

Figure 4: Packet aggregation strategies at the Network and MAC layers.

Figure 4 shows examples of two different aggregation strategies. The Network layer aggregation strategy (Figure 4a) aggregates N latest detections stored in a buffer and passes the aggregated packet down to the MAC layer, which is then placed in the queue for transmission. The advantage of this approach is the increase in network reliability due to redundancy – sending a detection record as part of several packets instead of one. However, this does not address the issue of potential MAC layer congestion due to bursty traffic; it produces the same number of packets as there are detections (in this example – 3). To this end, Figure 4b shows our proposed cross-layer packet aggregation strategy referred to as "just-in-time" (JIT) aggregation. Here, the node first attempts to append the new detection record to a packet that is already scheduled (waiting in the MAC queue), and only if there is no space for it in the scheduled packets, or if the queue is empty, it generates a new packet with this detection in the payload. Note that this approach requires a cross-layer interface between the Network and MAC layer.

4. SIMULATION STUDY

4.1. Simulation Setup

We ran MATLAB simulations of 500 randomly generated scenarios similar to the one shown in Fig. 5, with 40 UAC nodes arranged as a 20×2 grid in a 10×1 km segment of a coast line with a 50 m radius random perturbation in each node's position, and a 2 km communication range. In every scenario the trajectory of the detection target was simulated by randomly generating a start point above the top line of nodes and an end point below the bottom line of nodes; and setting the constant speed of 2 m/s (typical max speed of an AUV) of travel between these two points.

While the target is moving across the network, the UAC nodes broadcast packets using an

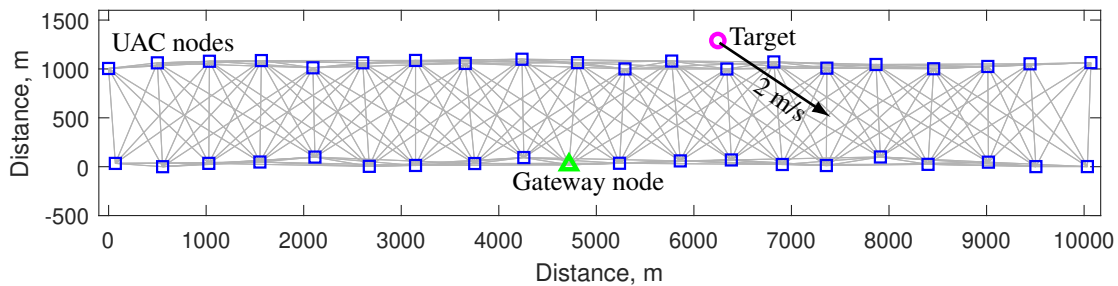

Figure 5: Example of a simulated scenario; the target is moving across the network at 2 m/s.

STDMA schedule, as described in Section 3.1. A detection of the target is registered if, during a transmission on an acoustic link, the target’s location is within the “target-to-path detection distance” d_{t-p} of the vertical plane between the transmitter and the receiver, i.e. d_{t-p} represents the target’s “detectability radius”. The reader is referred to [7] for an investigation of the detection performance under a range of d_{t-p} values and target speeds.

The gateway node (with a connection to shore) is located in the middle of the bottom row of nodes, as depicted in Figure 5. The aim of the routing protocol is to deliver the packets generated by any network node to this gateway node.

4.2. Detection Performance

Figure 6 shows the cumulative distribution functions (CDFs) of the number of target detections registered by the network in each of the 500 simulated scenarios. The results show that even when the network is only able to detect targets within $d_{t-p} = 2$ m of an active acoustic path, it typically achieves in the order of tens of target detections, whereas d_{t-p} of 10 m results in 20–200 detections. This demonstrates the general feasibility of this approach for target detection.

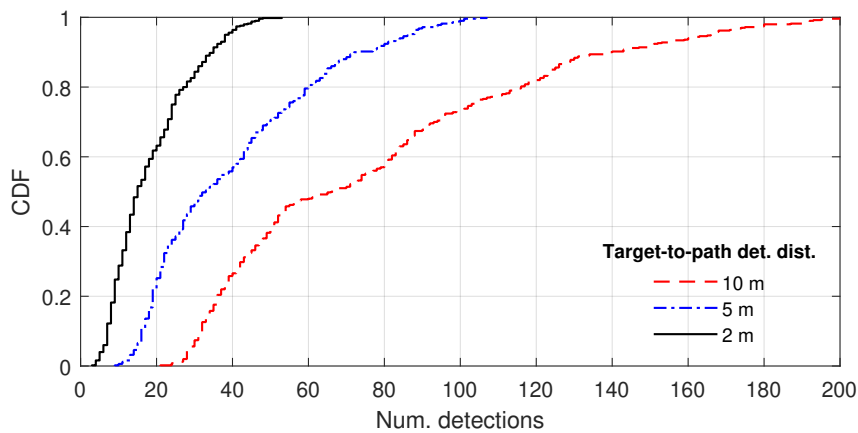

Figure 6: Number of target detections per simulated scenario using different “target-to-acoustic-path” detection distance thresholds.

4.3. End-to-end Latency and Reliability

The E2E latency in delivering the detection information to the gateway is the most crucial performance metric. When a detection takes place, the detecting node generates a packet and sends it to the gateway node using the SP or GRAD routing protocol, combined with the packet aggregation strategies discussed in Section 3.3. We also include a benchmark comparison with simple Flooding [11], where every node that receives a new packet rebroadcasts it once.

Figure 7a shows the mean E2E delays with the error bars indicating the 10th and 90th percentiles, with detection traffic generated using the $d_{t-p} = 10$ m target detection threshold. It shows that GRAD and SP routing exhibit considerably lower latency than Flooding, because of the large reduction in the MAC layer traffic load. A further dramatic improvement in latency is achieved by JIT aggregation with a maximum aggregated payload size of only 3 detections. Figure 7b plots the same latency data but in the form of cumulative distribution functions (CDFs). It highlights the “long tails” of E2E latency due to bursty detection traffic and MAC layer congestion, which is significantly alleviated using JIT aggregation combined with SP or GRAD routing. We also conclude from these results that Flooding is not a suitable protocol for this application, due to excessive latency.

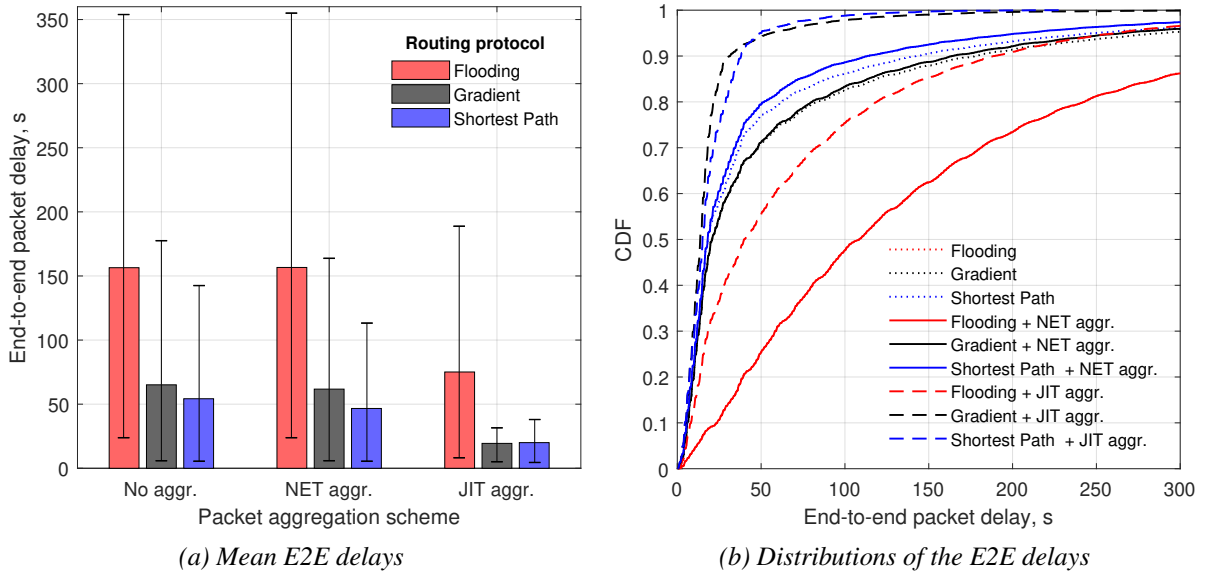

Figure 7: End-to-end (E2E) latency in delivering the detection information to the gateway. The maximum aggregated packet payload size: 3 detections.

In Figure 8 we evaluate the E2E packet delivery ratio (PDR) achieved in the presence of large-scale random link fading, modelled using a classical two-state Markov process [12] approximating UAC link fading often observed in practice. There, both the duration of random link outage and the duration of normal link operation are exponentially distributed, with the mean link outage duration set to 10 s. Figure 8 also shows that NET aggregation significantly improves the PDR, compared with JIT aggregation, by introducing redundancy in the transmitted packet payloads. For example, at the link outage probability of 0.2, the PDR of GRAD routing increased from 0.87 to 0.98 using NET aggregation.

The results in this section demonstrate JIT aggregation significantly improves the latency, whereas NET aggregation significantly improves the PDR. Further work includes on the development of a solution that combines the two strategies: uses part of the aggregated packet for new detections (JIT), but also leaves space for previous detections (NET). This will further improve the trade-off between latency and reliability of GRAD routing.

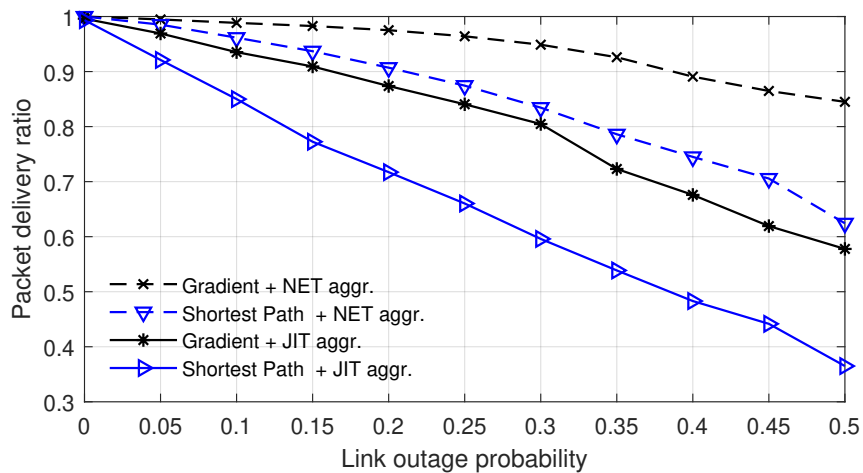

Figure 8: Packet delivery ratio at a range of link outage probabilities.

5. CONCLUSION

We developed a network protocol stack for simultaneous UAC and target detection, where a network of underwater nodes transmit regular data packets which are “reused” for the purpose of target detection via anomaly detection in the estimated CIRs. Our solution is based on the STDMA MAC layer, which was found to provide good detection performance using a simplified “target-to-acoustic-path distance” detection model. We evaluated the SP, GRAD and Flooding routing protocols at the Network layer, with GRAD providing a good trade-off between limiting the MAC layer traffic load and achieving a degree of robustness at the Network layer via multipath routing. We also designed two data aggregation strategies: 1) NET aggregation – which significantly increased the network reliability in unstable channel conditions; and 2) JIT aggregation – which dramatically reduced the E2E latency. Further work includes the development of a solution that combines NET and JIT aggregation to further improve the trade-off between the latency and reliability, and the development of efficient retransmission strategies.

References

- [1] D. S. Terracciano, L. Bazzarello, A. Caiti, R. Costanzi, and V. Manzari. Marine robots for underwater surveillance. *Curr. Robot. Rep.*, 1:159–167, 2020.
- [2] G. Ferri, A. Munafo, A. Tesei, P. Braca, F. Meyer, K. Pelekanakis, R. Petroccia, J. Alves, C. Strode, and K. LePage. Cooperative robotic networks for underwater surveillance: an overview. *IET Radar, Sonar & Nav.*, 11(12):1740–1761, 2017.
- [3] M. Y. Aalsalem, W. Z. Khan, W. Gharibi, M. K. Khan, and Q. Arshad. Wireless sensor networks in oil and gas industry: Recent advances, taxonomy, requirements, and open challenges. *J. Netw. Comput. Appl.*, 113:87–97, 2018.
- [4] Li Hu, Xiaodong Wang, and Shilian Wang. Decentralized underwater target detection and localization. *IEEE Sensors J.*, 21(2):2385–2399, 2021.
- [5] R. Otnes, J. E. Voldhaug, and S. Haavik. On communication requirements in underwater surveillance networks. In *Proceedings of IEEE OCEANS’08*, pages 1–7, 2008.
- [6] J. Heidemann, M. Stojanovic, and M. Zorzi. Underwater sensor networks: applications, advances and challenges. *Philos. Trans. R. Soc. A*, 370(1958):158–175, 2012.
- [7] N. Morozs, P. D. Mitchell, and Y. Zakharov. Target detection using underwater acoustic networking. In *accepted for presentation at OCEANS’23*, pages 1–5, Jun 2023.
- [8] A. Boukerche, B. Turgut, N. Aydin, M. Z. Ahmad, L. Bölöni, and D. Turgut. Routing protocols in ad hoc networks: A survey. *Computer Networks*, 55(13):3032–3080, 2011.
- [9] T. Watteyne, K. Pister, D. Barthel, M. Dohler, and I. Aue-Blum. Implementation of gradient routing in wireless sensor networks. In *Proceedings of IEEE GLOBECOM’09*, pages 1–6, 2009.
- [10] R. Diamant, G. N. Shirazi, and L. Lampe. Robust spatial reuse scheduling in underwater acoustic communication networks. *IEEE J. Ocean. Eng.*, 39(1):32–46, 2014.
- [11] R. Otnes, J. Locke, A. Komulainen, S. Blouin, D. Clark, H. Austad, and J. Eastwood. Dflood network protocol over commercial modems. In *Proceedings of UComms’18*, 2018.
- [12] M. Zorzi, R. R. Rao, and L. B. Milstein. On the accuracy of a first-order Markov model for data transmission on fading channels. In *Proceedings of IEEE ICUPC’95*, pages 211–215, 1995.