



HAL
open science

Coordinated Control Can Deliver Synergies Across Multiple Rainwater Storages

Wei D Xu, Matthew J Burns, Frédéric Cherqui, Kate Smith-miles, Tim D Fletcher

► **To cite this version:**

Wei D Xu, Matthew J Burns, Frédéric Cherqui, Kate Smith-miles, Tim D Fletcher. Coordinated Control Can Deliver Synergies Across Multiple Rainwater Storages. *Water Resources Research*, 2022, 58 (2), 10.1029/2021wr030266 . hal-04191969

HAL Id: hal-04191969

<https://hal.science/hal-04191969>

Submitted on 30 Aug 2023

HAL is a multi-disciplinary open access archive for the deposit and dissemination of scientific research documents, whether they are published or not. The documents may come from teaching and research institutions in France or abroad, or from public or private research centers.

L'archive ouverte pluridisciplinaire **HAL**, est destinée au dépôt et à la diffusion de documents scientifiques de niveau recherche, publiés ou non, émanant des établissements d'enseignement et de recherche français ou étrangers, des laboratoires publics ou privés.

Water Resources Research®







RESEARCH ARTICLE

10.1029/2021WR030266

Coordinated Control Can Deliver Synergies Across Multiple Rainwater Storages

Key Points:

- Multiple rainwater storages can be operated in a coordinated manner by Real–Time Control (RTC) technology for multiple objectives
- This coordinated RTC delivers synergy benefits in restoring baseflow
- Large storages compensate for small underperforming storages within the network

Wei D. Xu^{1,2} , Matthew J. Burns¹ , Frédéric Cherqui^{1,3} , Kate Smith-Miles⁴ , and Tim D. Fletcher¹ 

¹School of Ecosystem and Forest Sciences, The University of Melbourne, Burnley, VIC, Australia, ²Changjiang Institute of Survey, Planning, Design and Research, Wuhan, Hubei, China, ³University Lyon, INSA Lyon, DEEP, Villeurbanne, France, ⁴School of Mathematics and Statistics, The University of Melbourne, Parkville, VIC, Australia

Supporting Information:

Supporting Information may be found in the online version of this article.

Correspondence to:

W. D. Xu,
danielweixu@gmail.com

Citation:

Xu, W. D., Burns, M. J., Cherqui, F., Smith-Miles, K., & Fletcher, T. D. (2022). Coordinated control can deliver synergies across multiple rainwater storages. *Water Resources Research*, 58, e2021WR030266. <https://doi.org/10.1029/2021WR030266>

Received 20 APR 2021
Accepted 28 JAN 2022

Author Contributions:

Conceptualization: Wei D. Xu, Matthew J. Burns, Frédéric Cherqui, Kate Smith-Miles, Tim D. Fletcher
Data curation: Wei D. Xu
Formal analysis: Wei D. Xu
Funding acquisition: Tim D. Fletcher
Investigation: Wei D. Xu, Frédéric Cherqui, Tim D. Fletcher
Methodology: Wei D. Xu, Matthew J. Burns, Frédéric Cherqui, Kate Smith-Miles, Tim D. Fletcher
Project Administration: Matthew J. Burns, Frédéric Cherqui, Kate Smith-Miles, Tim D. Fletcher
Resources: Wei D. Xu, Matthew J. Burns, Frédéric Cherqui, Kate Smith-Miles

© 2022 The Authors.

This is an open access article under the terms of the [Creative Commons Attribution-NonCommercial License](https://creativecommons.org/licenses/by/4.0/), which permits use, distribution and reproduction in any medium, provided the original work is properly cited and is not used for commercial purposes.

Abstract Studies in Real–Time Control (RTC) Rainwater Harvesting Systems (RWH) have to date been limited to the control of single storages, leaving the potential benefits of operating multiple storages in a coordinated manner largely untested. In this study, we aimed to design an optimization-based RTC strategy that can operate multiple storages in a coordinated manner to achieve multiple objectives. We modeled the long-term performance of this coordinated approach (i.e., termed as *coordinated control*) across a range of storage sizes and compared it with a strategy that optimized the operation of each storage individually, ignoring the state of other stores within the system. Our results show that coordinated control delivered a synergy benefit in achieving better baseflow restoration, with almost no detriment to the water supply and flood protection (overflow reduction) performance. The efficiency achieved through coordinated control allows large storages to compensate for smaller, underperforming systems, to achieve higher overall performance. Such a finding suggests a general control principle in building coordination among multiple storages, which can potentially be adapted to mitigate flooding risks, and also applied to other stormwater control measures. This also opens up a new opportunity for practitioners to construct a future “smart rainwater grid” using a network of distributed storages, in combination with centralized large storages, to manage urban stormwater in a range of contexts and for a range of environmental objectives.

Plain Language Summary “Smart tanks” based on Real–Time Control (RTC) technology is increasingly applied in rainwater harvesting systems to address water shortages, urban flooding and streams depleted of flow. However, most uses of this technology have been applied to single tanks, without testing the potential of a network controlled in a coordinated manner to better address the environmental problems. To understand the effect of such coordination, we designed a control strategy accordingly and modeled its performance using a customized model. We found that a network of smart tanks can, in most cases, deliver a synergy benefit in restoring streamflow compared to systems that only work on their own. More importantly, this coordination allows large tanks to compensate for smaller, underperforming tanks, to achieve higher overall performance. It suggests a general control principle in building coordination among multiple storages, which can potentially be adapted to mitigate flooding risks, and also applied to other stormwater control measures. It opens up a smart future for managing urban water in a range of contexts and for a range of environmental objectives.

1. Introduction

Rapid urbanization since the mid–20th century has created critical challenges for water management. Population growth and dwindling freshwater resources imperil water security globally (Vörösmarty et al., 2010). Landscape change through increased impervious cover decrease infiltration and evapotranspiration in the urban environment (Barron et al., 2013; Haase, 2009), resulting in excessive surface runoff and increased peakflow, increasing flooding risks (Nirupama & Simonovic, 2006). Such a gross change to the natural water cycle also commonly reduces groundwater recharge and stream baseflow (Bhaskar, Beesley, et al., 2016; Ferguson & Suckling, 1990; Rose & Peters, 2001). The conventional hydraulically-efficient drainage network, which directly connects surface runoff to the receiving water, further perturbs the natural flow regimes through increased frequency and magnitude of stormwater flow (Leopold, 1968), along with reduced recession time (Burns et al., 2005). These hydrological changes drive substantial geomorphic modification (Hammer, 1972; Russell et al., 2020), habitat loss and

Software: Wei D. Xu, Matthew J. Burns
Supervision: Matthew J. Burns, Frédéric Cherqui, Kate Smith-Miles, Tim D. Fletcher
Validation: Wei D. Xu, Matthew J. Burns, Frédéric Cherqui, Kate Smith-Miles, Tim D. Fletcher
Visualization: Wei D. Xu, Tim D. Fletcher
Writing – original draft: Wei D. Xu
Writing – review & editing: Wei D. Xu, Matthew J. Burns, Frédéric Cherqui, Kate Smith-Miles, Tim D. Fletcher

ecological degradation in urban streams, leading to a reduction of ecosystem services and biodiversity (Bunn & Arthington, 2002; King et al., 2005; Poff et al., 1997; Walsh et al., 2012).

Rainwater Harvesting (RWH) Systems have been widely used to mitigate urban stormwater impacts (Campisano et al., 2017). Rainwater is a traditional source of water supply (Gardner & Vieritz, 2010; Mikkelsen et al., 1999; Ward et al., 2012). RWH systems are also a type of storage-based Stormwater Control Measure (SCM), which capture, store and divert the rainwater from direct runoff to end-use, thus reducing the amount of excess flow delivered to receiving waters and mitigating flooding risks (Fletcher et al., 2007; Jamali et al., 2019; Schubert et al., 2017). More importantly, while much attention is paid to the influence of SCMs on peak flows, increasing recognition has been paid to the importance of SCMs in simultaneously restoring often-depleted baseflows (Bhaskar, Hogan & Archfield, 2016; Hamel et al., 2013; Price, 2011; Walsh et al., 2016), inspired by the concept of natural flow paradigm (Poff et al., 1997). Rainwater harvesting systems can potentially deliver such a benefit by releasing some of the retained rainwater through a passive orifice in a temporal pattern close to that of the natural flow regime (Burns et al., 2012). One limitation of passive systems, however, is that they often lack the constant and high usage to consume the previously stored rainwater, thus unable to create sufficient headroom for upcoming storm runoff, thus leading to frequent uncontrolled system overflows (Jones & Hunt, 2010).

In recent times, Real-Time Control (RTC) technology has begun to be applied in RWH systems to enhance system performance in flood protection and baseflow restoration, while providing a decentralized source of water supply (Roman et al., 2017; Xu, Burns, et al., 2020). It provides conventional (i.e., passive) RWH systems with the ability to utilize digital information (e.g., rainfall forecast) and adapt system operation according to the real-time situation, enabling the operation to evolve from static to highly adaptive (Kerkez et al., 2016). RTC systems are generally equipped with a sensor-activated outlet to manipulate in-store volume and system outflow for various objectives (e.g., baseflow restoration). A range of modeling and empirical studies have designed RTC rules to release part of tank water prior to the event, thus minimizing the magnitude and frequency of uncontrolled overflow, with very little detriment to water supply (Behzadian et al., 2017; Gee & Hunt, 2016; Melville-Shreeve et al., 2016). One study has also attempted to restore more natural stream baseflow through persistent low-rate discharge (Xu et al., 2018).

Real-time control systems can be further optimized using a longer rainfall forecast window. Xu, Fletcher, et al. (2020) tested a RTC system using a 7-day lead precipitation forecast and concluded that increasing the forecast window is vital to better attenuate the peak flows, as it extends the prediction horizon of controlled release. Furthermore, it gives time to adjust for errors in the forecast that become evident each day with the occurrence of the actual rainfall. Such an operation also results in delivery of an outflow regime that more closely approaches the behavior of pre-urban (reference) streamflow, revealing a promising potential for more complete restoration of the natural flow regime.

Despite the increased use and benefits of RTC RWH systems, the focus to date has mainly been on the efficiency and improvement in a single system, ignoring the potential benefits from coordination of multiple elements across a system (Xu, Burns, et al., 2020). The benefits, but also the complexity, can potentially grow when multiple storages are integrated and operated in a coordinated manner to improve collective outcomes. Such an integration is likely to provide synergies in enhancing the overall system efficiency, beyond the simple cumulative effect of each system element.

Optimization-based RTC is widely applied in urban water systems. It typically involves a mathematical optimization problem which represents the desirable outcomes and which seeks the optimal control actions based on system variables (García et al., 2015; Shishegar et al., 2018). Such an approach can optimize the control of an individual system, such as a reservoir (Fontane et al., 1981; Piccardi & Soncini-Sessa, 1991), wastewater treatment plant (Ahmed & Rodríguez, 2020; Kim et al., 2004; Sweetapple et al., 2014) or a centralized SCM (e.g., detention basin; Shishegar et al., 2019). It can also optimize the control of multiple elements in an integrated system, such as urban drainage networks (Ocampo-Martinez et al., 2013) and water distribution networks (Cembrano et al., 2000; Creaco et al., 2019), where the control needs to understand and account for how the various elements interact.

Various algorithms are applied in the optimization-based control of urban water systems (see detailed review in García et al., 2015), especially for the coordinated control of multi-element systems. Marinaki and

Papageorgiou (2003) developed a multi-variable linear-quadratic regulator to prevent overflow from a combined sewer network by using all available storages space in an optimal way. Other simulation-optimization based techniques, such as genetic algorithms, are also applied to solve more complex control problems, which often involve non-linear system models to reflect detailed system dynamics (Lund et al., 2018; Shishegar et al., 2018). Fu et al. (2008) applied a genetic algorithm, specifically the Non-dominated Genetic Algorithm II (NSGA-II; Deb et al., 2002), to optimize the collective operation of a sewer network, wastewater treatment plant and its water quality impact on the receiving water. Meng et al. (2017) utilized the same approach to further optimize the control of this integrated system by reducing the cost while simultaneously maximizing the environmental outcomes. Such an application was then extended to investigate the various regulatory implications of the RTC technology (Meng et al., 2020). The genetic algorithm was recently applied in controlling multiple RWH systems. Di Matteo et al. (2019) and Liang et al. (2019) modeled two storages operated in a coordinated manner, enabled by the NSGA II algorithm, demonstrating an enhanced performance in mitigating flow peaks in large rainfall events. However, this study only optimized for a single objective and predicted system performance over a short period (i.e., ≤ 24 hr), without demonstrating the performance over the long-term.

Comprehensively understanding the potential for synergies when RTC is used to optimize multiple rainwater storages in a coordinated manner, is a prerequisite to moving beyond individual household rainwater harvesting to a future involving a hybrid of centralized and decentralized SCMs (Sapkota et al., 2018). In this study, we aim to design an optimization-based RTC strategy to operate multiple RWH storages in coordination with each other (termed here as *Coordinated Control*) and assess its long-term effects on water supply, flood mitigation and waterway flow regime restoration. We also developed and modeled a RTC strategy that shares the same triple objectives, but optimizes each storage in isolation (termed here as *Local Control*), to reveal the degree of synergy that can be obtained using a coordinated optimization. *Coordinated* and *Local Control* are termed here to describe the contrasted structure of the control problem, where one operates the system with coordination between each element in the system, while the other operates each element for its individually optimal performance (Chen et al., 2021; Han et al., 2018; Sandell et al., 1978). These strategies are also compared to a conventional rainwater harvesting system (i.e., a passive system without any release) during a 5.5-year simulation period, to consider the best water supply performance.

We hypothesize that *coordinated control* can deliver a synergy benefit in achieving better baseflow restoration, with almost no detriment to the supply and flood mitigation (overflow reduction) performance of the integrated system. Our results demonstrated that coordinated control allows large storages to compensate for smaller, under-performing systems, thus achieving higher overall system performance. Our work provides useful insights for application of coordinated control in smart hybrid stormwater management scenarios.

2. Methods

2.1. Optimal Control Strategy

We developed two optimization-based RTC strategies which operate multiple rainwater harvesting systems in different ways. *Coordinated Control* considers all elements as an integrated system. The controlled release is optimized for the collective outcome and therefore influenced by the status (i.e., tank level and outflow rate) of each and every tank within the overall system. In contrast, the *Local Control* optimizes the operation of each element in isolation, without considering the overall system status.

Both strategies optimize common control objectives, including overflow volume reduction, water supply and, baseflow restoration. The overflow volume reduction objective aims to minimize uncontrolled overflow during the control horizon, using a controlled release. Baseflow restoration attempts to provide a contribution to baseflow in downstream receiving waters, using a controlled release at a rate matched to streamflow in a reference condition (i.e., prior to urbanization). This is achieved by setting a baseflow target based on the relative size of roof catchment to the overall catchment size, which attempts to counteract reduced infiltration (and thus contribution to groundwater and stream baseflow) at each land parcel. Doing so is based on the rationale that aquatic ecosystems in urban areas not only need reduced frequency and magnitude of peak flows, but need maintenance of baseflows to ensure adequate area of wetted habitat (Olden & Poff, 2003). Similarly, water supply aims to satisfy the household demand for (non-potable) water requirements. This is achieved by minimizing

Table 1
Objective Functions for Coordinated Control and Local Control

Objectives	Coordinated control	Local control
Min overflow (L)	$\text{Min} \sum_{t=t_0}^{t_0+H_p} \sum_{i \in N_T} Q_{oi,t}$	$\text{Min} \sum_{t=t_0}^{t_0+H_p} Q_{oi,t}, \forall i \in N_T$
Max supply (L)	$\text{Min} \sum_{i \in N_T} \sum_{t=t_0}^{t_0+H_p} Y_{i,t} - D_{i,t} $	$\text{Min} \sum_{t=t_0}^{t_0+H_p} Y_{i,t} - D_{i,t} , \forall i \in N_T$
Mimic baseflow (L)	$\text{Min} \sum_{t=t_0}^{t_0+H_p} \left \sum_{i \in N_T} (Q_{bi,t} Q_{oi,t}) - Q_{\text{target},t} \right $	$\text{Min} \sum_{t=t_0}^{t_0+H_p} \left Q_{bi,t} + Q_{oi,t} - Q_{\text{target},t} \right , \forall i \in N_T$

Note. Where $Q_{oi,t}$ is the overflow (L/timestep) from tank i at time t , $Y_{i,t}$ is the rainwater supply (L/timestep) from tank i at time t , $D_{i,t}$ is the demand (L/timestep) from tank i at time t , $Q_{bi,t}$ is the controlled release (control variable) from system i at t (L/timestep), $Q_{\text{target},t}$ is the reference streamflow (L/timestep) from system at time t . N_T represents the set of tanks.

the deviation between yield and predicted end-use patterns (see Section 2.2.1 for more details). Therefore, the controlled outflow $Q_{bi,t}$ (i.e., control variable) from tank i ($i \in N_T$) at time t is determined by solving a multi-objective optimization problem in a finite rolling time horizon (i.e., prediction horizon H_p ; see more details in Section 2.2.4). The objective functions are presented in Table 1 (see example in Figure 1).

The control variable $Q_{bi,t}$ is also subject to a capacity constraint, which is derived from the tank water balance, to limit the sum of controlled release over the prediction horizon to no more than the available storage volume. Water balance at each time step is also constrained by the tank behavior model, to ensure that the water balance is respected at all times (see details in Section 2.2.3)

$$V_{i,t-1} + \sum_{t=t_0}^{t_0+H_p} Q_{ai,t} - \sum_{t=t_0}^{t_0+H_p} Y_{i,t} \geq \sum_{t=t_0}^{t_0+H_p} Q_{bi,t} \geq 0, i \in N_T \quad (1)$$

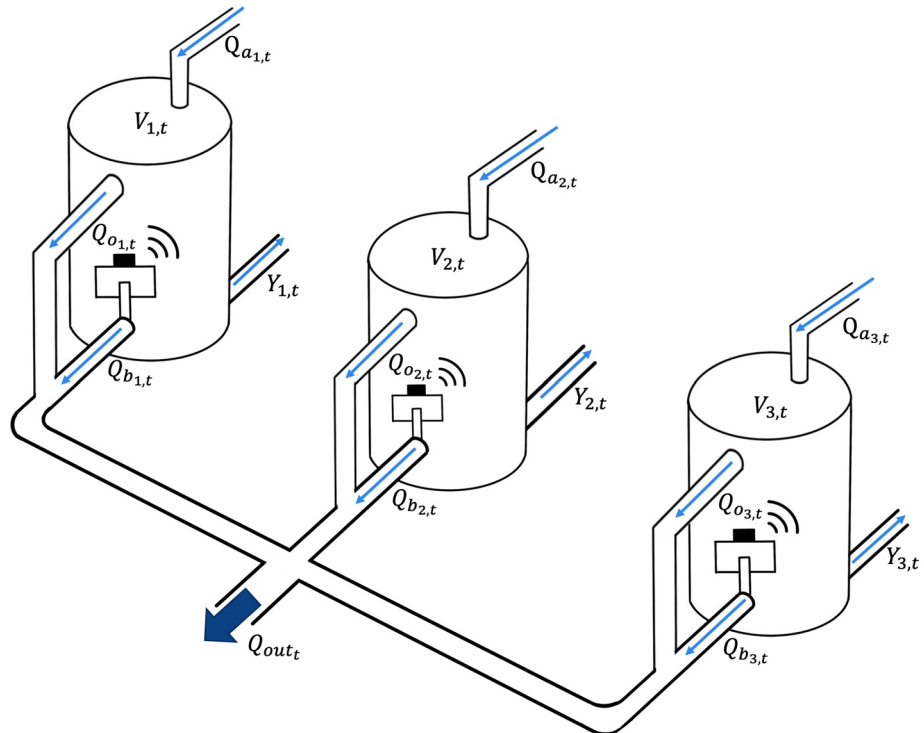

Figure 1. Conceptual representation of a multiple tank system operated by integrated real-time control.

where $V_{i,t-1}$ is the volume (L) in system i ($i \in N_T$) at the end of time step $t - 1$ (previous), $Q_{a,i,t}$ is the system i predicted inflow (L) derived from rainfall forecast at time t (see more details in Equation 2).

For illustration, *Coordinated Control* aims to minimize overflow by calculating the sum of overflow volume Q_o from all systems i ($i \in N_T$) at time t and summed over the length of the prediction horizon H_p . For the Mimic Baseflow objective value, total outflow from the network, which includes the controlled release $Q_{b,i,t}$ and overflow $Q_{o,i,t}$, is first summed from all system elements i ($i \in N_T$). At each time t , the absolute deviation from reference streamflow $Q_{\text{target},i,t}$ is then calculated and summed over the prediction horizon H_p . Similarly, the Max Supply computes the absolute deviation between yield $Y_{i,t}$ and demand $D_{i,t}$. By contrast, while the objective functions are similar, *Local Control* neglects the factor of systems i in the network, and so only optimizes the objective values within each system.

2.2. Modeling Framework

A triple tank system was designed to simulate and compare the outcomes of the two contrasting control strategies stated above (i.e., $N_T = \{1, 2, 3\}$) (Figure 1). A modeling framework was written using R software (version 4.0.0) (R Core Team, 2020), including four core modules: (M1) prediction, (M2) optimization, (M3) simulation, and (M4) evaluation (Figure 2). The prediction (M1) and optimization (M2) are both run at a daily timestep. Doing so matches the (daily) timestep of the 7-day rainfall forecasts (sub-daily forecasts are not available over this 7-day forecast window), meaning that decisions to change the valve status (i.e., releases) occur once a day, as the new forecast becomes available. Limiting operation to daily also has benefits of protecting the valve and actuator from excessive wear and premature failure (Shishegar et al., 2019). The simulation (M3) is run every 6 minutes, in order to appropriately capture the inflow dynamics (Mitchell et al., 2008) and to assess the performance of the control strategy. The assessment (M4) is performed at the end of simulation, integrating all the 6-min steps for the entire timeseries.

2.2.1. Input Data

Rainfall forecast data was sourced from the local meteorological authority (Bureau of Meteorology, 2020) to predict inflows, and, therefore, overflow (M1) which would occur in the absence of control actions. We extracted 7-day lead mean daily predicted rainfall during 2014-03-01 to 2019-08-31 in Eastern Melbourne (i.e., Lat: -37.92 , Long: 145.32). This data set was generated by the Australian Community Climate Earth-System Simulator (ACCESS) (Bureau of Meteorology, 2010) and has been applied in a previous study (Xu, Fletcher, et al., 2020).

Rainfall and streamflow observations were obtained at the same location during the same period. They were gauged every 6 min to compute system inflow (M3) and the baseflow release target (M1, M2, and M3) respectively. In total, 550 rainfall events were extracted in this location which has an average annual rainfall of 945 mm. An individual rainfall event was defined as having more than 0.2 mm of rainfall and 1.2 mm/hr rainfall intensity with an antecedent dry period of at least 2 hours (i.e., initial loss is only applied when there is a minimum 2-hr antecedent dry period), to represent initial loss. While more sophisticated approaches can be used, such as continuous tracking of the net flux of input and output (evaporation) from depression storages, we prefer to adopt this simple approach, given that it overcomes the need to integrate or model evaporation data.

Baseflow targets were derived using a nearby reference stream with a near-natural catchment. The streamflow record was used to provide four baseflow targets from median flow (i.e., Q50) covering the periods December-February (summer), March-May (autumn), June-August (winter), September-November (spring) to account for seasonal variation, with a mean of $0.26 (\pm 0.12)$ mm/day (i.e., standardized by catchment area). Only outflows that are within $>0 - <2 \times$ the baseflow target are considered as baseflow release to be evaluated (see detailed methods in Table 2). Flows that are higher than this are assumed to result in hydraulic impacts that will degrade the channel form and stream habitat, and are thus not assumed to satisfy the requirements of baseflow.

Ten scenarios were simulated to represent a range of realistic storage sizes in the network. Scenarios were constructed by selecting a combination of three tanks, where the size of each tank could be either 2, 7.5 or 15 kl. Repetition is allowed during the selection, such that combinations of tanks could include tanks of different sizes,

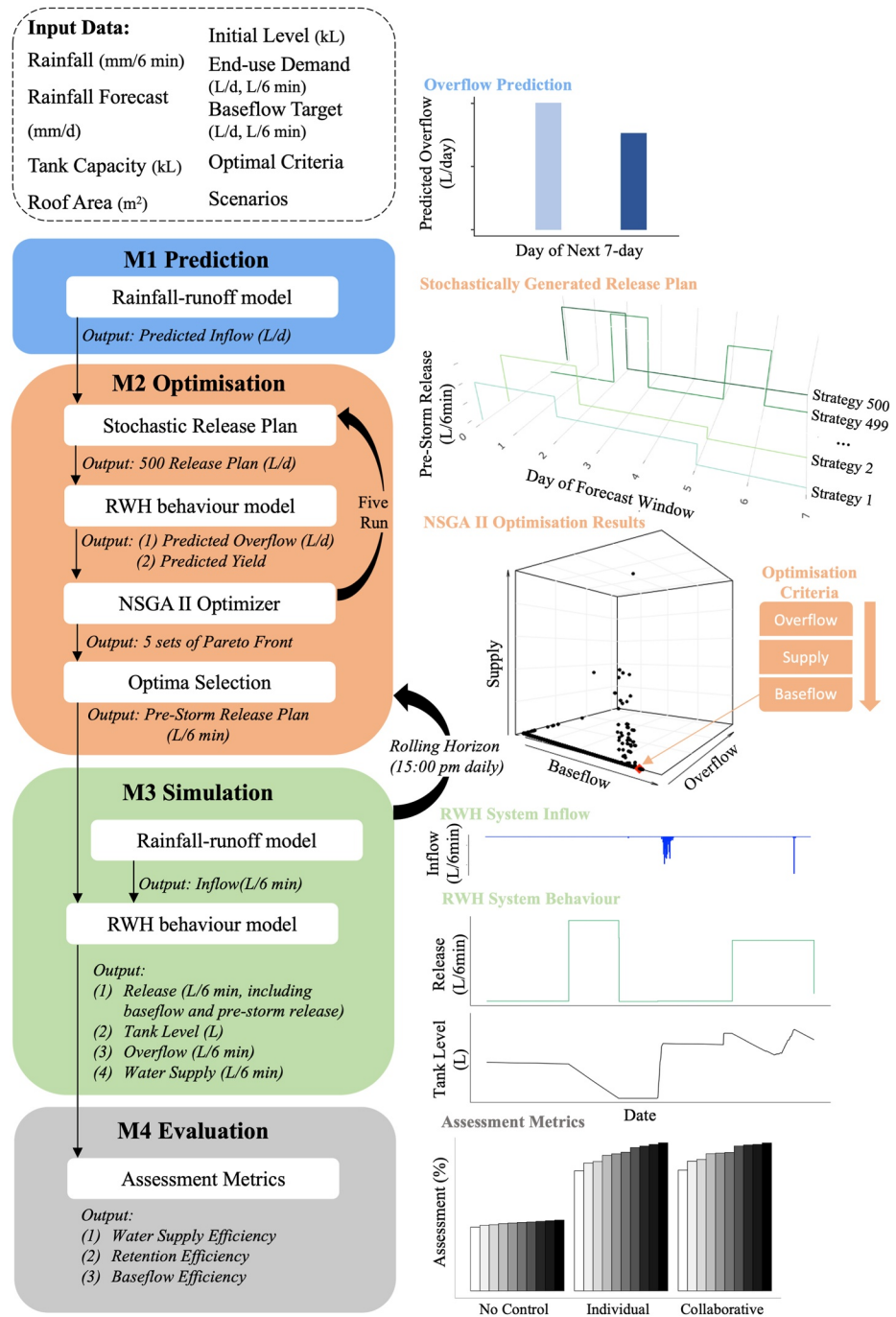

Figure 2. Conceptual representation of modeling framework.

or where two or three of the tanks were of the same size (refer to the table of scenarios in table S1 in Supporting Information S1). Each of the storages in the triple tank network drained a 150 m² roof catchment and supplied water for a range of domestic water uses, including toilet flushing, dishwasher, and clothes washing. The demand profile was adopted from Xu et al. (2018) and consistent with a typical indoor diurnal pattern. It has a total daily consumption of 132 L/d, with peak consumption of 10.3 L/hr at 7 p.m. and the lowest usage of 2.4 L/hr at 2 a.m.

Table 2
Assessment Metrics for Triple Objectives of Rainwater Harvesting

Assessment metrics	Equation	Description
Overflow reduction efficiency (%)	$E_R = \left[1 - \frac{\sum_{i \in N_T} \sum_{t=1}^T Q_{oi,t}}{\sum_{i \in N_T} \sum_{t=1}^T (Q_{ai,t})} \right]$	$Q_{oi,t}$ is tank overflow from system i at t (L/6 min), $Q_{ai,t}$ is the system i inflow (L/6 min) at time t .
Water supply efficiency (%)	$E_{ws} = \sum_{i \in N_T} \sum_{t=1}^T \frac{Y_{i,t}}{D_{i,t}} / (n \times n_T) \times 100\%$	$Y_{i,t}$ is the rainwater supply (L/6 min) from tank i at time t , $D_{i,t}$ is the household demand (L/6 min) from tank i at time t . T is the entire simulation period (i.e., 5.5-year). n is the total number of timesteps. n_T is the total number of systems (i.e., 3).
Baseflow efficiency (%)	$E_{bt} = \begin{cases} \sum_{t=1}^T \left(2 - \frac{Q_{out,t}}{Q_{target,t}} \right), & 1 \leq \frac{Q_{out,t}}{Q_{target,t}} < 2 \\ \sum_{t=1}^T \frac{Q_{out,t}}{Q_{target,t}}, & 0 < \frac{Q_{out,t}}{Q_{target,t}} < 1 \end{cases}$ $E_b = \frac{\sum E_{bt}}{n} \times 100\%$	E_b is the total baseflow efficiency (%), E_{bt} is the baseflow efficiency at timestep t . $Q_{out,t}$ is the sum of all tank outflow at time t , including overflow Q_o and controlled release Q_{bi} . $Q_{target,t}$ is the referenced streamflow (L/6 min) for all tank at time t .

2.2.2. M1 Prediction

The prediction component (M1) utilized the rainfall forecast data to predict the system inflow prior to the actual events (Equation 1, rainfall-runoff model):

$$Q_{ai,t} = (R_{i,t} - R_{loss}) \times A_i, \forall i \in N_T \quad (2)$$

where $Q_{ai,t}$ is the system i inflow (L) at time t , $R_{i,t}$ is the forecast rainfall depth (mm) at in system i time t , R_{loss} is the initial loss (i.e., depression storage on the roof surface) which is set as 0.2 mm/day. A_i is the roof size of system i .

2.2.3. M2 Optimization

The optimization component (M2) is the central algorithm to decide control actions under different strategies. First, 500 sets of candidate control plans (i.e., daily controlled release from three different systems in the next 7 days) are stochastically generated. Future system overflow and yield are then predicted using inflow forecast (M1) and initial tank level. This is computed by the Rainwater Harvesting Behavior Model using Yield–After-Spillage rules, which provides a more accurate estimation of yield (Fewkes & Butler, 2000, Equations 3–5). Overflows are also included and considered as unregulated — that is, they occurred whenever inflows exceeded storage capacity. This allows the detailed system dynamic to be captured, but also makes this model nonlinear. The presence of any first flush diversion system was excluded in the tank behavioral model, given that the use, type and volumetric behavior of filtration devices, if present, is highly variable.

$$Q_{oi,t} = \max \begin{cases} V_{i,t-1} + Q_{ai,t} - S_i \\ 0 \end{cases} \quad (3)$$

$$Y_{i,t} = \min \begin{cases} D_{i,t} \\ V_{i,t-1} - Q_{bi,t} \end{cases} \quad (4)$$

$$V_{i,t} = \min \begin{cases} V_{i,t-1} + Q_{ai,t} - Y_{i,t} - Q_{bi,t} \\ S_i - Y_{i,t} - Q_{bi,t} \end{cases} \quad (5)$$

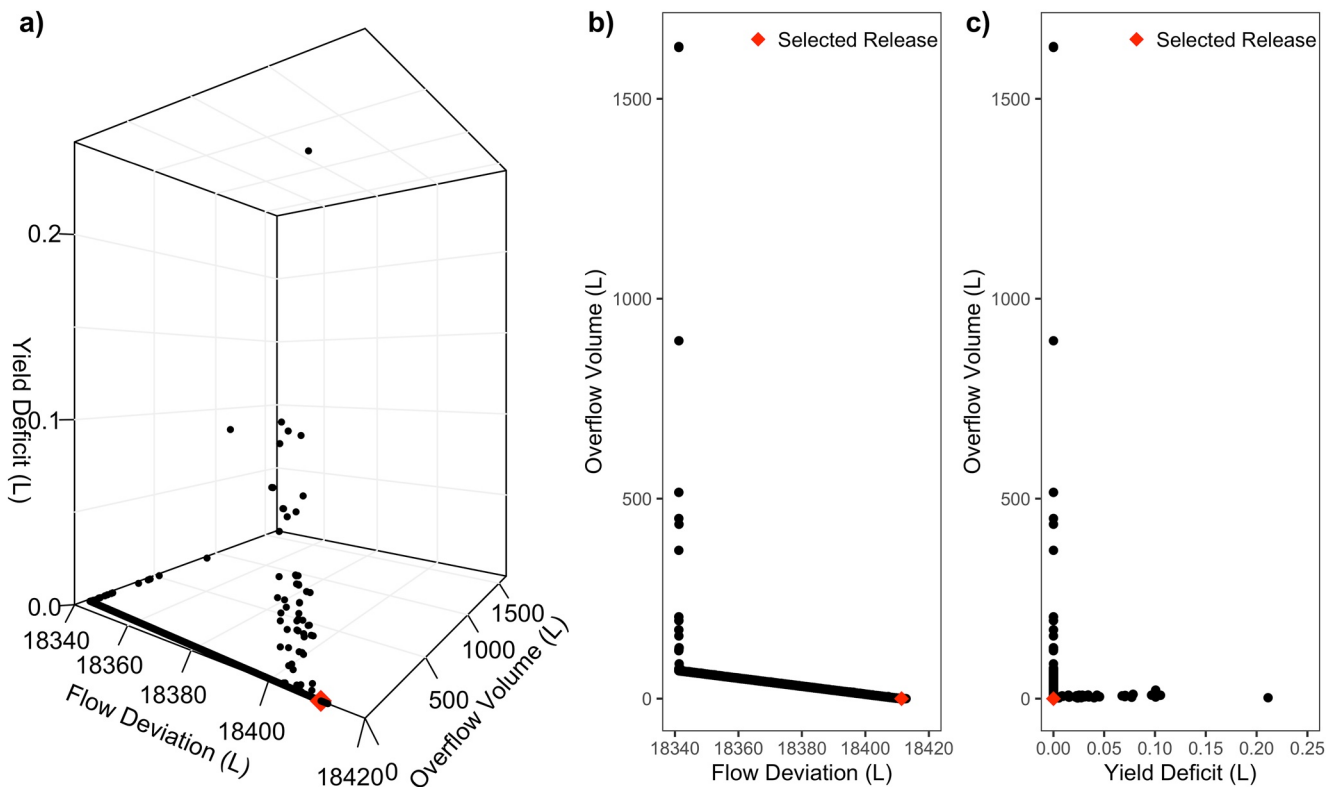

Figure 3. Illustration of the selection of optimal controlled release in scenario S7 (i.e., 7.5 + 7.5 + 7.5 kl) using *Coordinated Control* on Jan 26, 2016 for the next 7-day period, which represents a typical optimization when overflow is predicted.

Where $V_{i,t}$ and $V_{i,t-1}$ are the volume (L) in system i ($i \in N_T$) at the end of time step t (current) and $t - 1$ (previous) respectively, $Y_{i,t}$ is the rainwater yield in system i at t (L/timestep), $Q_{bi,t}$ is the controlled release (control variable) from system i at t (L/timestep), $Q_{oi,t}$ is tank overflow from system i at t (L/timestep), S_i is tank storage capacity (L) of system i , $D_{i,t}$ is the demand (L/timestep) from tank i at time t , $Q_{ai,t}$ is the system i inflow at time t (L/timestep).

NSGA-II (Deb et al., 2002), a popular evolutionary algorithm for multi-objective optimization, was employed to optimize the candidate RTC plans, given the non-linearity caused by the overflow component in the tank behavior model. By mimicking the natural selection and evolution process in NSGA II, RTC plans continuously evolve in each generation toward achieving better optimization objective values, which are calculated by functions previously explained in Table 1. Optimization in *Coordinated Control* was performed by a single optimization, considering the candidate control plans from three different tanks altogether, while this is performed separately in *Local Control*, given the operation of each tank is undertaken in isolation. Both optimizations utilized the same algorithm settings and convergence tests have been made (see details in Supporting Information S1 Text S3). Five repetitions of the optimization algorithm were conducted for each daily simulation, to reduce the risk of the search algorithm becoming trapped in a local optimum. Each run evolves a population of 500 candidate solutions that eventually provides a good approximation to the Pareto front, exploring the trade-offs between objectives, which lead to a total of 2,500 candidate RTC strategies. This is achieved via the R package “mco” (Mersmann et al., 2014). The performance of these strategies was then plotted against the three objectives (see example in Figure 3).

Finally, the optimal control is selected based on pre-defined criteria. The top hierarchy of the criteria is minimized overflow, meaning that overflow objective has a dominant impact on the selection of the optimum combination given the potentially catastrophic consequences of urban flooding, followed by maximized supply and then baseflow (Figure 2). Therefore, the first batch of candidate optimal solutions is selected based on the lowest overflow objective value. These solutions are then filtered by the lowest objective value for supply and baseflow respectively. While overflow was dominant in selection of the optimal solution sets, the simulations were found to

be robust to the precision in overflow, such that relaxing the constraints so that small overflows were allowed, did not have any meaningful impact on the values of water supply or baseflow in the optimal solution set. The RTC plan determined as the final optimal solution is implemented and fed into the (M3) simulation.

2.2.4. M3 Simulation

The simulation component (M3) models the consequent performance of optimized control using the rainwater harvesting behavior model (Equations 3–5). While the three tanks within the network are modeled separately, outflows (i.e., overflow and controlled release) from each system are summed to give the total network discharge, which is then assessed by the evaluation component (see Section 2.2.5). Actual system inflow in the simulation module is computed by observed (i.e., rather than forecast) rainfall (mm/6 min) using Equation 2, applying an initial loss of 0.2 mm (Laing et al., 1988), with an antecedent drying period of 2 hr. Actual water level at each timestep is the function (Equations 3–5) of inflow, yield, controlled release, and previous level, which is recorded at the end of the previous timestep.

The optimization and simulation components are operated on a receding horizon, which is commonly applied in Model Predictive Control of urban drainage systems (Lund et al., 2018). M2 optimizes the RTC plan for the next 7 days, given its ability to better inform controlled release long before the actual event and at a rate that is much closer to the natural hydrology (Xu, Fletecher, et al., 2020). However, only the actions in the next 24-hr period are implemented in the simulation component, due to the rolling correction of forecast information. Thus, optimization is conducted recursively at 15:00 daily (i.e., when weather forecast is updated).

2.2.5. M4 Evaluation

Three assessment metrics are adopted (Table 2) to evaluate the long-term performance for supply, overflow reduction and baseflow restoration (Quinn et al., 2021). The assessment of baseflow efficiency is based on the total outflow from all three tanks, viewed as an integrated system, to reveal the potential efficiency gained from collective optimization. RTC release that is within twice of the baseflow target is considered as baseflow release. The percentage composition of collective baseflow release from each tank is also quantified, to reflect the individual system behavior in different control strategies.

3. Results

3.1. Selection of Optimal RTC Strategy

The optimization of RTC strategies indicated trade-off between the three control objectives. For example, *Coordinated Control* showed most of the Pareto optima concentrated around the axis of flow deviation (i.e., volume difference between the released water and baseflow target), meaning the objective value of overflow and yield deficit were nearly zero (Figure 3a). Moreover, an increase in the rate of controlled release (as detailed in the equation in Table 1 Mimic Baseflow) results in a decrease in the volume of overflow, but also results in a greater deviation between the target baseflow and the delivered flow (Figure 3b). A similar relationship was also demonstrated between overflow and yield, although the difference in yield was minor (Figure 3c). The strategy selected as optimal (i.e., red dot in Figure 3) was shown to cause the least overflow, but led to nearly the largest deviation from the reference baseflow target (i.e., on the far right of Flow Deviation axis), although the range is small ($\approx 10 L/d$).

3.2. Baseflow Restoration: Benefits of Coordination

Controlling the network with coordination between storages was demonstrated to deliver better baseflow restoration. *Coordinated Control* demonstrated an average (i.e., across all scenarios) of 62.8% baseflow efficiency, which is 4.2% higher than achieved by local control (see Figure 4a). Such an advantage is comparatively larger when a small sized system (e.g., 2 kl) is integrated with larger systems (e.g., 7.5 kl and 15 kl). Replacing one 2 kl storage in scenario S1 with a 15 kl system (i.e., scenario S3) nearly doubled the baseflow efficiency using

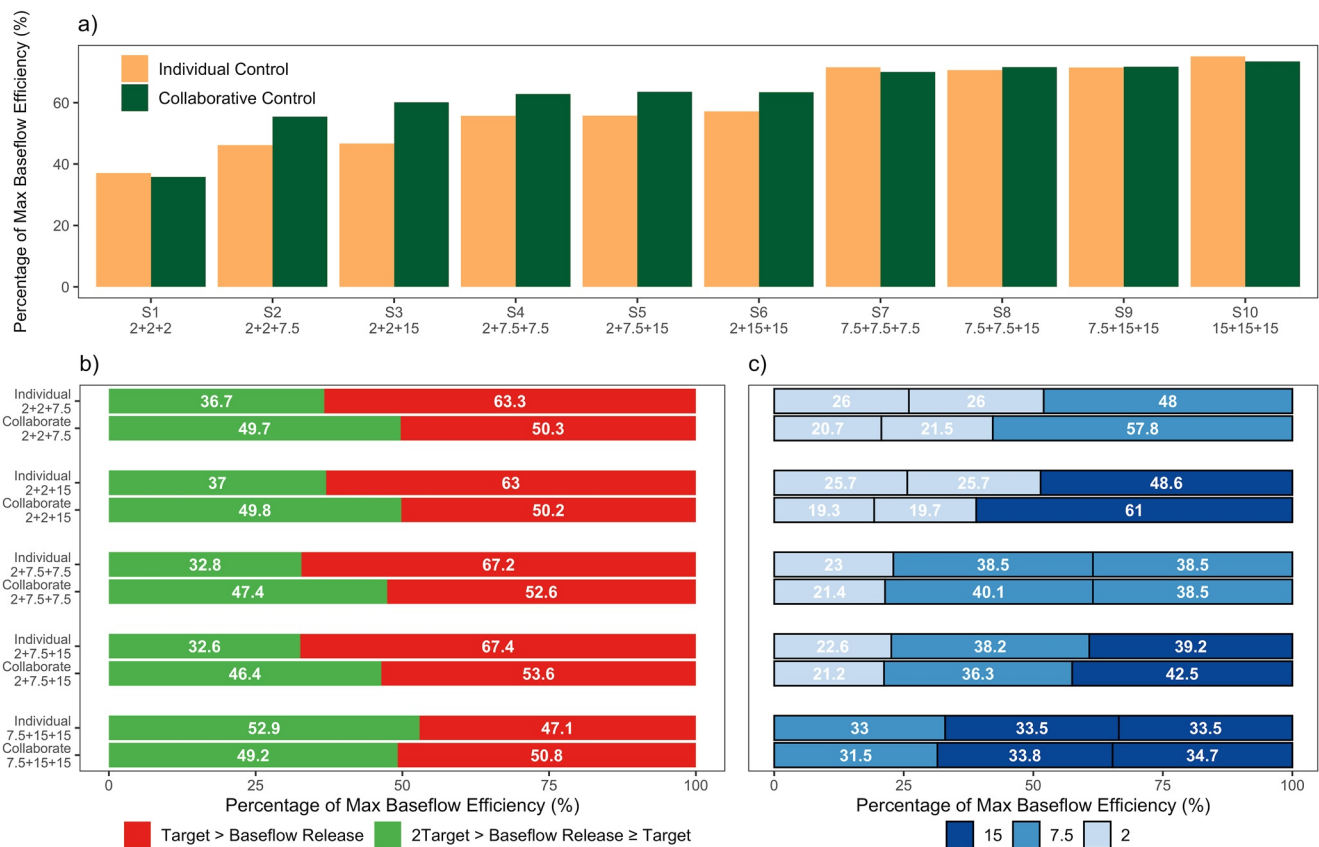

Figure 4. Collective baseflow efficiency of multiple rainwater harvesting systems operated by coordinated and local control in a range of scenarios, including: (a) collective baseflow efficiency; (b) the proportion of baseflow release that is smaller or bigger than the target; (c) baseflow contribution from each storage. Ten scenarios were derived from the combination of different sized storages. The maximum performance of baseflow efficiency (i.e., Table 2) is 100% where the baseflow target is fully satisfied during 5.5–year simulation period.

Coordinated Control, while the improvement was less using *Local Control*, revealing a clear potential synergy when integrating multiple storages within a coordinated network.

More importantly, *Coordinated Control* was shown to release more flow above the baseflow target, especially when small and large systems operated together in coordination, creating synergies. For a network simultaneously including a 2 and 7.5 or 15 kl storage (i.e., scenario S2, S3, S4, and S5), baseflow release within the target range (i.e. the controlled release rate is within 1x–2x the target baseflow rate) averaged only 34% of the time using *Local Control*, but this increased to 48% in the *Coordinated Control* (Figure 4b). However, this advantage diminishes when all the storages are of the same size (i.e., scenario S1 and S9), due to the absence of synergy benefits.

Moreover, individual storages perform the baseflow release differently among the two control strategies. For example, in scenario S2 (i.e., two 2 + one 7.5 kl storages), the 7.5 kl storage in *Local Control* contributes 47.9% of the total baseflow efficiency achieved by the three storages. However, *Coordinated Control* elevates this proportion by 10% (Figure 4c). Such an increase leads to higher total baseflow release volume (Figure 4a), while also resulting in less water discharged by the small storages (i.e., 2 kl). A similar composition of baseflow release is also shown in scenario S3–6, where a 2 kl system is integrated with larger storage(s) (e.g. 7.5 or 15 kl). This difference diminishes when storage sizes are increased (e.g., scenario S9).

The outflows of all RTC systems were characterized by a flow duration curve, with a comparison to the reference streamflow (Figure 5). All RTC systems were shown to provide a more constant overall flow regime and more natural low-flow regime than did the conventional tank system without RTC. Scenario S2 operated by *Coordinated Control* produced higher low flows across different seasons (i.e., four stages), especially during Q25–

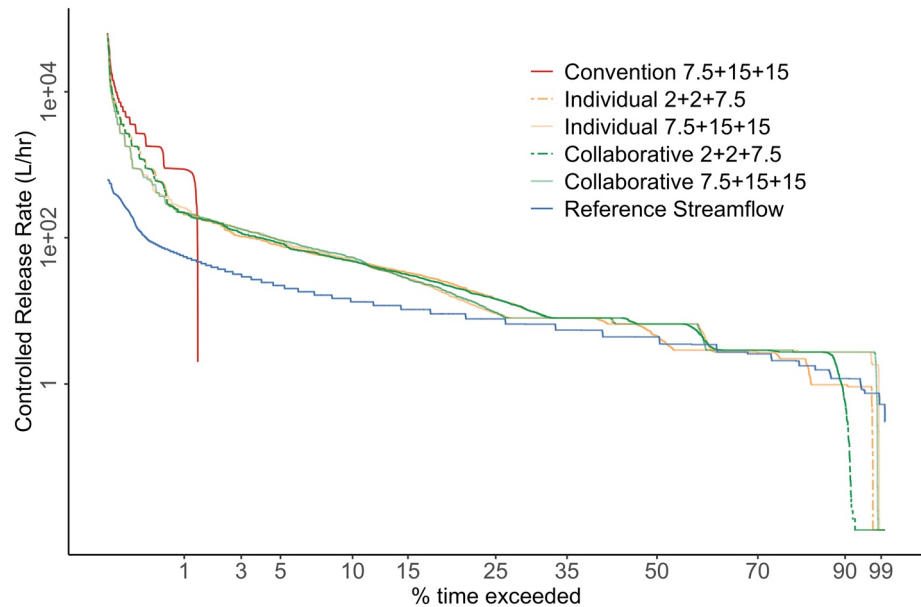

Figure 5. Outflow Duration Curve (i.e., showing percentage of the time of a given flow magnitude is exceeded) of scenario S2 (i.e., 2 + 2 + 7.5 kl) and 9 (i.e., 7.5 + 15 + 15) in conventional setting and two control strategies compared to the reference streamflow on a pro-rata base (i.e., considering catchment area of $3 \times 150 = 450 \text{ m}^2$). System outflow is the sum of overflow and any controlled release.

Q90 flows (Figure 5), which corresponds to higher baseflow efficiency as previously demonstrated (Figures 4a and 4b).

Nevertheless, abundant baseflow release can lead to longer subsequent no-flow periods, especially when a small tank is involved. The *Coordinated Control* in scenario S2 experienced cease-to-flow conditions from Q92, while it occurred less frequently using *Local Control* (i.e., Q97). Not surprisingly, almost no difference is demonstrated between the two control strategies in scenarios that have larger storage size (e.g., 7.5 + 15 + 15 kl), where sufficient volume of baseflow is maintained over long periods (i.e., until nearly Q99), due to the large volume of storage available.

3.3. Water Supply: Individual Benefits

Water supply performance was similar for both coordinated and local control. Both RTC systems demonstrated an average of 3.3% lower supply efficiency compared to the conventional settings across all scenarios (Figure 6). The decrease in efficiency is comparatively larger in small sized systems (e.g., scenario with 2 kl storage), diminishing in large systems, demonstrating a similar trend to the observations for baseflow efficiency.

3.4. Overflow Reduction: Local Benefits

RTC systems were able to achieve greater reductions in uncontrolled system overflows compared to conventional systems without RTC (Figure 6). Local and coordinated control were shown to perform similarly in reducing overflow volumes. The *Local Control*, optimizing only each element in the system, doubled the overflow reduction efficiency compared to conventional passive systems in all scenarios, ranging between 72% and 89% (Figure 6). Coordinated control of the integrated system delivers the same level of advantage in overflow reduction as *Local Control*, reducing the total overflow volume over the 5.5-year simulation period by 830 kl on average. In addition, the results show that operating the system by RTC provides a much better flood protection than simply increasing the tank capacity.

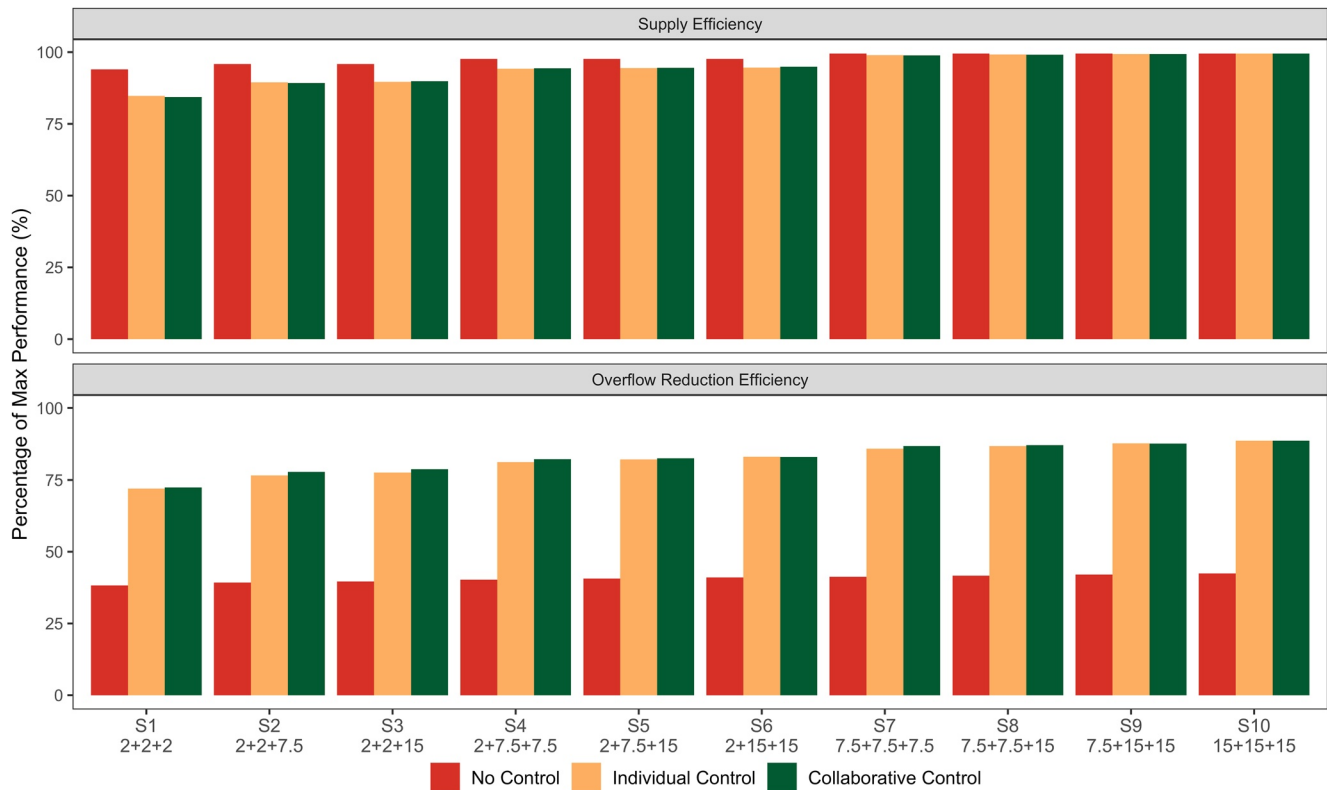

Figure 6. Evaluation of water supply (top) and overflow reduction (bottom) performance in a range of multiple rainwater harvesting storages operated by coordinated and individual optimization, comparing to conventional systems without RTC. The maximum performance of supply efficiency (i.e., Table 2) is 100% where the demand is fully satisfied. The maximum performance of overflow reduction efficiency (i.e., Table 2) is 100% where there is no overflow occurred during 5.5–year simulation period.

RTC systems were also shown to reduce the magnitude and flashiness of high flows. RTC systems demonstrated lower high flows compared to conventional systems, especially for $<Q_1$ flows, although systems with larger storage size achieved higher high flow reduction (Figure 5). Almost no difference was observed between local and coordinated control during Q_3 – Q_{10} flows, even when increasing the storage size from 2 to 15 kl (i.e., S2 compared to S9).

4. Discussion

4.1. The Impact of Coordination

Controlling multiple rainwater storages in a coordinated way using optimization leads to better outcomes compared to operating them in isolation. Indeed, *Coordinated Control* delivers better baseflow efficiency, without any meaningful detriment to the water supply and overflow reduction performance. This advantage is most notable when the system includes storages of different size (e.g., small integrated with large storages). In this case, the coordination tends to result in large storages delivering increased baseflow release relative to that which occurs in *Local Control*, to compensate the under-performing small systems and ensure the collective flow target is delivered.

For systems with uniform properties (e.g., identical tank capacity, roof size and flow target), the two RTC strategies — local and coordinated — present a similar behavior and performance. This is because the lack of variation limits the opportunity to explore any benefits in coordination. In the same manner, when systems are large enough (i.e., 7.5 and 15 kl), even with variation, to cope with the three objectives, they do not need to depend on each other, thus the *Coordinated Control* offers little advantage over *Local Control*.

The compensatory benefits, led by coordinated optimization, will likely be powerful in practical implementation, where rainwater tanks will vary greatly in size, catchment area and end-use demands. *Coordinated Control* will make the optimal use of each rainwater tank in the overall system, allowing the performance of undersized storages to be compensated by the behavior of others. Incorporating RTC with coordination into existing networks would allow overall system performance to be improved without expanding existing storage capacity. For new systems, it would theoretically allow individual elements to be smaller than would otherwise be ideal, given the compensation from other elements in the integrated system.

Doing this can help to reduce the overall cost of the system, particularly in high-density urban environments, where space is limited (i.e., insufficient space for large tanks). For example, this might lead to a new funding model where a private developer has an option to financially contribute to the construction of larger public assets, using the cost saving from smaller on-lot stormwater control measures. Such a finding highlights the great potential of *Coordinated Control* for future novel implementations of RTC systems in stormwater management.

However, the compensation contributed by larger systems does create the adverse effect of leaving insufficient water for future baseflow release. For example, the baseflow restoration of *Local Control* outperformed the *Coordinated Control* in scenario S9 (i.e., 7.5 + 15 + 15 kl), although the difference is minor. This results from the optimization. Large storages in the *Coordinated Control* situation tend to release more water ahead of a forecast rainfall event than in the *Local Control*, to compensate for inadequate baseflow from small storages. While this enhances the overall system performance within the limited prediction horizon of 7 days, it also depletes the large storages, thus leading to more cease-to-flow conditions, as large tanks have emptied earlier than they otherwise would have. Further work could be undertaken to balance this risk, for example by nominating a dead-storage (i.e., to limit the maximum drawdown) below which baseflow releases cannot be extracted.

An important question related to the future design of such systems is the extent to which hydrological metrics serve to deliver a desirable ecological integrity in the local context. This is underpinned by broader ecological management questions about whether cease-to-flow conditions should be preserved (thus potentially contributing to regional biodiversity; Poff et al., 2010), or whether baseflow should be provided to increase wetted habitat and thus local biodiversity (Chiu et al., 2017) and social amenity values of waterways (Shafer et al., 2013). Regardless, RTC can provide flexibility to adjust the operation tailored to the ecological (and social) needs, without major infrastructure modification. The optimal control we tested sought to mimic the reference streamflow by maximizing the baseflow volume during the 7-day horizon, but this could be easily adapted to mimic reference cease-to-flow conditions, if desired. Moreover, future RTC can consider more complex seasonal variations in the streamflow target. It might also correspond to real-time flow gauging and potentially serve habitat needs during the breeding season or other critical life cycle stages for local biota, even for a short period. Ultimate optimization for the broader environmental benefits of RTC requires more precise ecological specification in the local catchment context, such as the desirable baseflow rates and acceptable cease-to-flow duration.

By definition, there will be no synergy in the flood mitigation performance using the individual-storage based overflow reduction metrics described in this study. It focusses on the long-term volumetric performance of uncontrolled overflow of each individual tank, rather than considering the overall flow consequence across the network (Quinn et al., 2021). This also explained the lack of synergy benefits for water supply as the harvested rainwater in our scenarios was applied through a tank-specific supply system (i.e., not networked), which is typically the case for rainwater harvesting (Campisano et al., 2017). There is, however, the potential to further mitigate the overall catchment flood risk through the coordination of multiple RTC storages using *network-scale* optimization, taking into accounting the routing and travel time of flow peaks through the drainage network. A previous study has explored the possibility to reshape the collective flow through alternate release from multiple SCMs, thus reducing the catchment outlet peak flow (Mullapudi et al., 2018). This coordination requires optimization across two dimensions — timing and magnitude of the controlled release from each element within the network. This also requires the incorporation of a routing algorithm, ideally through a case-study catchment (because it is utterly case-specific), so that the travel time and rate of subsequent integrated outflow at downstream can be predicted and optimized. Doing so can potentially create a novel operation of decentralized SCMs (e.g., distributed storages) to minimize the hydraulic disturbance and subsequent geomorphic degradation of receiving stream channels (Russell et al., 2020) and reduce the risk of combined sewer overflow (Garofalo et al., 2017), where applicable.

4.2. Implementing Optimization in Practice

In our study, the use of the NSGA II algorithm had the major advantage of being able to handle the non-linear and multi-objective nature of the optimization problem, which are common characteristics of many water management optimization problems (see the review by Nicklow et al., 2010). It can also represent more computational challenges, especially when concerning the implementation of control in real-time (Zimmer et al., 2015). While the efficiency could probably be improved by parallel computing, the justification will depend on the number of system elements and the length of the control horizon required for a given application. In this study, we applied a 24-hr control interval, which is well accommodated by the computing time (i.e., approximately 5 min/day) of NSGA II in a single-core, 32 GB RAM computing environment provided by Spartan High Performance Computing (HPC) (Lev et al., 2016). However, this might not be sufficient for representing the mitigation of peak flows. Future investigation could test its impact at a fine-scale timestep (e.g. sub-hourly), at least for the parts of the time-series with rainfall (Staple, 1966).

The optimization used here favored overflow reduction over other objectives, resulting in releases of water at a higher rate prior to rain events (Figure 3), similar to the mechanism of *pre-storm release* of Gee and Hunt (2016). Future implementations may choose to apply different weightings between the objectives, or to apply constraints on outflow rates, depending on the catchment context.

Optimization allows us to gain more in-depth knowledge on the operation of RTC systems, which can help in forming the best-performing rules in a subsequent rules-based implementation of RTC (García et al., 2015). The decision-making process for rule-based and optimization-based control are fundamentally different, whereby rule-based RTC generally requires the design of specific control rules to guide system operation, while the optimization-based RTC only requires general control objectives which then lead to the operation by solving optimization problems. Improved efficiency, revealed by sufficient optimization studies, can potentially be translated into a set of RTC rules, which can be easily applied in operational deployment, without the computational cost of on-going mathematical optimization.

4.3. Potential for a Future Smart Integrated Water Network

While this study explored a first and arguably simplistic application of *Coordinated Control* to a network of rainwater storages, it opens up the possibility for complex and ambitious networks, across the urban water system. Rainwater harvesting networks could coordinate with other SCMs, such as detention basins (Shishegar et al., 2019). Distributed storages could retain the runoff at their maximum capacity and only release once the desired detention time (i.e., measure of resident time before discharge) is reached at the downstream basin, to ensure optimal water quality and flow outcomes (Carpenter et al., 2014; Gaborit et al., 2013). Several authors have identified the promising potential of integrating the management of combined sewer systems, wastewater treatment plants and receiving waters using RTC technology (Eggimann et al., 2017; Fu et al., 2008; Meng et al., 2017; Olsson, 2012). This also opens up the possibility of a future “smart rainwater grid” using a network of distributed small storages of rainwater, in combination with centralized large storages.

While the idea of a smart rainwater grid that brings together centralized and decentralized “water managers” is promising, such a vision has significant socio-economic considerations. One potential tension impacting the adoption of *Coordinated Control* in such networks is that private asset owners with larger storages may not wish for “their storage” to compensate for the underperformance of others. Their motivation for having installed such a storage may depend primarily on the private benefits obtained (e.g., water saving), even where the installation has been supported by a public-private hybrid funding model (Nemes et al., 2016). They may fear that compensating for underperforming systems might reduce their discretionary tank water, thus impacting on these private benefits (e.g., water supply), even though this trade-off has been shown in this study to be minor (Xu et al., 2018). This potential social impediment poses a fundamental question about the ownership and operational jurisdiction around this technology. There is likely a need for novel market-based instruments able to incentivize contributions to the overall network outcomes, using temporal dynamics in market supply and demand, potentially drawing inspiration from the feed-in-tariff in current hybrid energy market (Pyrgou et al., 2016) to motivate the participation of stakeholders.

4.4. Future Research

Future research is required to explicitly consider the spatial elements and catchment hydraulic characteristics of real-time controlled networks of tanks. This will provide an improved understanding of the spatial-temporal behavior of the RTC outflow from integrated storages, which can potentially lead to a future integration with other urban water system components. More complex flow targets, derived through local ecohydrological studies, are also essential to implement RTC technology for the benefit of receiving waters.

Another promising area of research is the performance of *Coordinated Control* in real-world implementation. The benefits of coordination revealed by this study can potentially be translated into a set of RTC rules that could be readily applied in stormwater management practice. While this technology has proven to be feasible in the field (Bartos & Kerkez, 2021; Oberascher et al., 2021), further exploration of its feasibility and efficiency will allow future optimization and improvement of this technology. To do so, however, requires new governance structures and associated business models that will facilitate adoption.

5. Conclusion

In this study, we aimed to design an optimization-based RTC model that enables coordination between multiple Rainwater Harvesting Systems to deliver a collective outcome across multiple objectives; water supply, base-flow restoration and overflow minimization. We modeled and assessed its performance in a range of scenarios, comparing it to an *Local Control* that only optimized the operation of each element in isolation. We concluded that *Coordinated Control* could deliver a synergy benefit in achieving better baseflow restoration without any real detriment to the supply and overflow reduction performance of the integrated system. *Coordinated Control* allows larger storages to compensate for smaller, underperforming storages, thus achieving higher overall performance. This work provides valuable insights to both the advantages and trade-offs of *Coordinated Control* of multiple RTC systems and highlights a promising component of future integrated smart water networks.

Acknowledgments

This research was made possible by the financial support from Melbourne Water, through the Melbourne Waterway Research–Practice Partnership (<http://mwrpp.org>) and from the European Union's Horizon 2020 research and innovation programme under Grant Agreement no. 786566 (<https://mind-4stormwater.org>). Wei D. Xu received a Melbourne Research Scholarship provided by The University of Melbourne and South East Water Corporation. South East Water Corporation also provided operating expenses for this research. The support is gratefully acknowledged. The authors also thank South East Water Corporation (especially David Bergmann and Jeddah Breman) and Melbourne Water Corporation (especially Andrew Grant, Rhys Coleman, and Sarah Watkins) for their intellectual input and guidance. The domestic water demand profile was adopted from Xu et al. (2018). The authors also would like to thank the three anonymous reviewers, the Associate Editor and Dr. Rhys Coleman for their helpful suggestions and comments. The majority of the model calculations were performed on the Spartan High Performance Computing (HPC) System hosted by Research Platform Services at the University of Melbourne (Lev et al., 2016). Open access publishing facilitated by The University of Melbourne, as part of the Wiley - The University of Melbourne agreement via the Council of Australian University Librarians.

Data Availability Statement

The rainfall and streamflow data were sourced from Melbourne Water (<https://www.melbournewater.com.au/water/rainfall-and-river-levels/#>) at Lysterfield station (228229B). The Rainfall forecast data were purchased from The Australian Digital Forecast Database, Australian Bureau of Meteorology (<http://www.bom.gov.au/weather-services/about/forecasts/australian-digital-forecast-database.shtml>).

References

- Ahmed, W., & Rodríguez, J. (2020). A model predictive optimal control system for the practical automatic start-up of anaerobic digesters. *Water Research*, 174, 115599. <https://doi.org/10.1016/j.watres.2020.115599>
- Barron, O. V., Barr, A. D., & Donn, M. J. (2013). Effect of urbanisation on the water balance of a catchment with shallow groundwater. *Journal of Hydrology*. *Journal of Hydrology*, 485, 162–176. <https://doi.org/10.1016/j.jhydrol.2012.04.027>
- Bartos, M., & Kerkez, B. (2021). Pipedream: An interactive digital twin model for natural and urban drainage systems. *Environmental Modelling & Software*, 144, 105120. <https://doi.org/10.1016/j.envsoft.2021.105120>
- Behzadian, K., Kapelan, Z., Mousavi, J., & Amir, M. A. (2017). Can smart rainwater harvesting schemes result in the improved performance of integrated urban water systems? *Environmental Science and Pollution Research*, 25, 19271–19282. <https://doi.org/10.1007/s11356-017-0546-5>
- Bhaskar, A. S., Beesley, L., Burns, M. J., Fletcher, T. D., Hamel, P., & Oldham, C. E. (2016). Will it rise or will it fall? Managing the complex effects of urbanization on base flow. *Freshwater Science*, 35(1), 293–310. <https://doi.org/10.1086/685084>
- Bhaskar, A. S., Hogan, D. M., & Archfield, S. A. (2016). Urban base flow with low impact development. *Hydrological Processes*, 30(18), 3156–3171. <https://doi.org/10.1002/hyp.10808>
- Bunn, S. E., & Arthington, A. H. (2002). Basic principles and ecological consequences of altered flow regimes for aquatic biodiversity. *Environmental Management*, 30(4), 492–507. <https://doi.org/10.1007/s00267-002-2737-0>
- Bureau of Meteorology (2010). *Operational implementation of the ACCESS numerical weather prediction systems*, NMOC, Operations Bulletin, No. 83. Retrieved from <http://www.bom.gov.au/australia/charts/bulletins/apob83.pdf>
- Bureau of Meteorology (2020). *The Australian digital forecast database*. Retrieved from <http://www.bom.gov.au/weather-services/about/forecasts/australian-digital-forecast-database.shtml>
- Burns, D., Vitvar, T., McDonnell, J., Hassett, J., Duncan, J., & Kendall, C. (2005). Effects of suburban development on runoff generation in the Croton River basin, New York, USA. *Journal of Hydrology*, 311(1), 266–281. <https://doi.org/10.1016/j.jhydrol.2005.01.022>
- Burns, M. J., Fletcher, T. D., Duncan, H. P., Hatt, B. E., Ladson, A. R., & Walsh, C. J. (2012). The stormwater retention performance of rainwater tanks at the landparcel scale. In *Paper presented at the proceedings of the 7th international conference on water sensitive urban design*. Melbourne, Australia.
- Campisano, A., Butler, D., Ward, S., Burns, M. J., Friedler, E., DeBusk, K., et al. (2017). Urban rainwater harvesting systems: Research, implementation and future perspectives. *Water Research*, 115, 195–209. <https://doi.org/10.1016/j.watres.2017.02.056>

- Carpenter, J. F., Vallet, B., Pelletier, G., Lessard, P., & Vanrolleghem, P. A. (2014). Pollutant removal efficiency of a retrofitted stormwater detention pond. *Water Quality Research Journal of Canada* (IWA Publishing), 49(2), 124–134. <https://doi.org/10.2166/wqrj.2013.020>
- Cembrano, G., Wells, G., Quevedo, J., Pérez, R., & Argelaguet, R. (2000). Optimal control of a water distribution network in a supervisory control system. *Control Engineering Practice*, 8(10), 1177–1188. [https://doi.org/10.1016/S0967-0661\(00\)00058-7](https://doi.org/10.1016/S0967-0661(00)00058-7)
- Chen, S., Wu, Z., & Christofides, P. D. (2021). Cyber-security of centralized, decentralized, and distributed control-detector architectures for nonlinear processes. *Chemical Engineering Research and Design*, 165, 25–39. <https://doi.org/10.1016/j.cherd.2020.10.014>
- Chiu, M.-C., Leigh, C., Mazor, R., Cid, N., & Resh, V. (2017). Anthropogenic threats to intermittent rivers and ephemeral streams. In T. Detry, N. Bonada, & A. Boulton (Eds.), *Intermittent rivers and ephemeral streams*. (pp. 433–454). Academic Press. <https://doi.org/10.1016/b978-0-12-803835-2.00017-6>
- Creaco, E., Campisano, A., Fontana, N., Marini, G., Page, P. R., & Walski, T. (2019). Real time control of water distribution networks: A state-of-the-art review. *Water Research*, 161, 517–530. <https://doi.org/10.1016/j.watres.2019.06.025>
- Deb, K., Pratap, A., Agarwal, S., & Meyarivan, T. (2002). A fast and elitist multiobjective genetic algorithm: NSGA-II. *IEEE Transactions on Evolutionary Computation*, 6(2), 182–197. <https://doi.org/10.1109/4235.996017>
- Di Matteo, M., Liang, R., Maier, H. R., Thyer, M. A., Simpson, A. R., Dandy, G. C., et al. (2019). Controlling rainwater storage as a system: An opportunity to reduce urban flood peaks for rare, long duration storms. *Environmental Modelling & Software*, 111, 34–41. <https://doi.org/10.1016/j.envsoft.2018.09.020>
- Eggimann, S., Mutzner, L., Wani, O., Schneider, Y. M., Spuhler, D., Vitry, M. M., et al. (2017). The potential of knowing more: A review of data-driven urban water management. *Environmental Science & Technology*, 51(5), 2538–2553. <https://doi.org/10.1021/acs.est.6b04267>
- Ferguson, B. K., & Suckling, P. W. (1990). Changing rainfall-runoff relationships in the urbanizing peachtree creek watershed, Atlanta, Georgia. *Jawra. Journal of the American Water Resources Association*, 26(2), 313–322. <https://doi.org/10.1111/j.1752-1688.1990.tb01374.x>
- Fewkes, A., & Butler, D. (2000). Simulating the performance of rainwater collection and reuse systems using behavioural models. *Building Services Engineering Research and Technology*, 21(2), 99–106. <https://doi.org/10.1177/014362440002100204>
- Fletcher, T. D., Mitchell, G. V., Ana, D., Tony, L., & Seven, A. (2007). Is stormwater harvesting beneficial to urban waterway environmental flows? *Water Science and Technology*, 55(4), 265–272. <https://doi.org/10.2166/wst.2007.117>
- Fontane, D. G., Labadie, J. W., & Loftis, B. (1981). Optimal control of reservoir discharge quality through selective withdrawal. *Water Resources Research*, 17(6), 1594–1602. <https://doi.org/10.1029/WR017i006p01594>
- Fu, G., Butler, D., & Khu, S.-T. (2008). Multiple objective optimal control of integrated urban wastewater systems. *Environmental Modelling & Software*, 23(2), 225–234. <https://doi.org/10.1016/j.envsoft.2007.06.003>
- Gaborit, E., Muschalla, D., Vallet, B., Vanrolleghem, P. A., & Anctil, F. (2013). Improving the performance of stormwater detention basins by real-time control using rainfall forecasts. *Urban Water Journal*, 10(4), 230–246. <https://doi.org/10.1080/1573062x.2012.726229>
- García, L., Barreiro-Gomez, J., Escobar, E., Téllez, D., Quijano, N., & Ocampo-Martínez, C. (2015). Modeling and real-time control of urban drainage systems: A review. *Advances in Water Resources*, 85, 120–132. <https://doi.org/10.1016/j.advwatres.2015.08.007>
- Gardner, T., & Vieritz, A. (2010). The role of rainwater tanks in Australia in the twenty first century. *Architectural Science Review*, 53(1), 107–125. <https://doi.org/10.3763/asre.2009.0074>
- Garofalo, G., Giordano, A., Piro, P., Spezzano, G., & Vinci, A. (2017). A distributed real-time approach for mitigating CSO and flooding in urban drainage systems. *Journal of Network and Computer Applications*, 78, 30–42. <https://doi.org/10.1016/j.jnca.2016.11.004>
- Gee, K. D., & Hunt, W. F. (2016). Enhancing stormwater management benefits of rainwater harvesting via innovative technologies. *Journal of Environmental Engineering*, 142(8), 04016039. [https://doi.org/10.1061/\(ASCE\)EE.1943-7870.0001108](https://doi.org/10.1061/(ASCE)EE.1943-7870.0001108)
- Haase, D. (2009). Effects of urbanisation on the water balance — A long-term trajectory. *Environmental Impact Assessment Review*, 29(4), 211–219. <https://doi.org/10.1016/j.eiar.2009.01.002>
- Hamel, P., Daly, E., & Fletcher, T. D. (2013). Source-control stormwater management for mitigating the impacts of urbanisation on baseflow: A review. *Journal of Hydrology*, 485, 201–211. <https://doi.org/10.1016/j.jhydrol.2013.01.001>
- Hammer, T. R. (1972). Stream channel enlargement due to urbanization. *Water Resources Research*, 8(6), 1530–1540. <https://doi.org/10.1029/WR008i006p01530>
- Han, X., Heussen, K., Gehrke, O., Bindner, H. W., & Kroposki, B. (2018). Taxonomy for evaluation of distributed control strategies for distributed energy resources. *IEEE Transactions on Smart Grid*, 9(5), 5185–5195. <https://doi.org/10.1109/TSG.2017.2682924>
- Jamali, B., Bach, P. M., & Deletic, A. (2019). Rainwater harvesting for urban flood management — An integrated modelling framework. *Water Research*, 171, 115372. <https://doi.org/10.1016/j.watres.2019.115372>
- Jones, M. P., & Hunt, W. F. (2010). Performance of rainwater harvesting systems in the southeastern United States. *Resources, Conservation and Recycling*, 54(10), 623–629. <https://doi.org/10.1016/j.resconrec.2009.11.002>
- Kerkez, B., Gruden, C., Lewis, M. J., Montestrucque, L., Quigley, M., Wong, B., et al. (2016). Smarter stormwater systems. *Environmental Science & Technology*, 50(14), 7267–7273. <https://doi.org/10.1021/acs.est.5b05870>
- Kim, J.-H., Chen, M., Kishida, N., & Sudo, R. (2004). Integrated real-time control strategy for nitrogen removal in swine wastewater treatment using sequencing batch reactors. *Water Research*, 38(14), 3340–3348. <https://doi.org/10.1016/j.watres.2004.05.006>
- King, R. S., Baker, M. E., Whigham, D. F., Weller, D. E., Jordan, T. E., Kazyak, P. F., et al. (2005). Spatial considerations for linking watershed land cover to ecological indicators in streams. *Ecological Applications*, 15(1), 137–153. <https://doi.org/10.1890/04-0481>
- Laing, I. A. F., Denby, C. G., & Prince, J. A. (1988). Design of roof runoff collection systems in Western Australia. *Paper presented at the Hydrology and Water Resources Symposium 1988*, ANU, Canberra.
- Leopold, L. B. (1968). *Hydrology for urban land planning — A guidebook on the hydrologic effects of urban land use (554)*. Washington, DC. Retrieved from <https://pubs.er.usgs.gov/publication/cir554>
- Lev, L., Greg, S., Linh, V., & Bernard, M. (2016). Spartan performance and flexibility: An HPC-cloud chimera. In *Paper presented at the open-stack summit*, Barcelona.
- Liang, R., Matteo, M. D., Maier, H. R., & Thyer, M. A. (2019). Real-time, smart rainwater storage systems: Potential solution to mitigate urban flooding. *Water*, 11(12), 2428. <https://doi.org/10.3390/w11122428>
- Lund, N., Falk, A. K. V., Borup, M., Madsen, H., & Peter, S. M. (2018). Model predictive control of urban drainage systems: A review and perspective towards smart real-time water management. *Critical Reviews in Environmental Science and Technology*, 48(3), 279–339. <https://doi.org/10.1080/10643389.2018.1455484>
- Marinaki, M., & Papageorgiou, M. (2003). Linear-quadratic regulators applied to sewer network flow control. In *Paper presented at the 2003 European Control Conference (ECC)*, <https://doi.org/10.23919/ecc.2003.7085327>
- Melville-Shreeve, P., Ward, S., & Butler, D. (2016). Rainwater harvesting typologies for UK houses: A multi criteria analysis of system configurations. *Water*, 8(4), 129. <https://doi.org/10.3390/w8040129>

- Meng, F., Fu, G., & Butler, D. (2017). Cost-effective river water quality management using integrated real-time control technology. *Environmental Science & Technology*, 51(17), 9876–9886. <https://doi.org/10.1021/acs.est.7b01727>
- Meng, F., Fu, G., & Butler, D. (2020). Regulatory implications of integrated real-time control technology under environmental uncertainty. *Environmental Science and Technology*, 54(3), 1314–1325. <https://doi.org/10.1021/acs.est.9b05106>
- Mersmann, O., Trautmann, H., Steuer, D., Bischl, B., & Deb, K. (2014). Multiple criteria optimization algorithms and related functions. Retrieved from <https://github.com/olafmersmann/mco>
- Mikkelsen, P., Adeler, O., Albrechtsen, H., & Henze, M. (1999). Collected rainfall as a water source in danish households — what is the potential and what are the costs? *Water Science and Technology*, 39(5), 49–56. <https://doi.org/10.2166/wst.1999.0221>
- Mitchell, V. G., Siriwardene, N., Duncan, H., & Rahilly, M. (2008). Investigating the impact of temporal and spatial lumping on rainwater tank system modelling. In *Paper presented at the proceedings of water down under 2008*. Adelaide, SA, Australia.
- Mullapudi, A., Bartos, M., Wong, B., & Kerkez, B. (2018). Shaping streamflow using a real-time stormwater control network. *Sensors*, 18(7), 2259. <https://doi.org/10.3390/s18072259>
- Nemes, V., Andrea, L. N., Walsh, C. J., Fletcher, T. D., Bos, D. G., RossRakesh, S., & Stoneham, G. (2016). Saving a creek one bid at a time: A uniform price auction for urban stormwater retention. *Urban Water Journal*, 13(3), 232–241. <https://doi.org/10.1080/1573062X.2014.988732>
- Nicklow, J., Reed, P., Savic, D., Dessalegne, T., Harrell, L., Chan-Hilton, A. B., et al. (2010). State of the art for genetic algorithms and beyond in water resources planning and management. *Journal of Water Resources Planning and Management*, 136(4), 412–432. [https://doi.org/10.1061/\(asce\)wr.1943-5452.0000053](https://doi.org/10.1061/(asce)wr.1943-5452.0000053)
- Nirupama, N., & Simonovic, S. P. (2006). Increase of flood risk due to urbanisation: A canadian example. *Natural Hazards*, 40(1), 25. <https://doi.org/10.1007/s11069-006-0003-0>
- Oberascher, M., Kinzel, C., Kastlunger, U., Kleidorfer, M., Zingerle, C., Rauch, W., et al. (2021). Integrated urban water management with micro storages developed as an IoT-based solution – The smart rain barrel. *Environmental Modelling & Software*, 139, 105028. <https://doi.org/10.1016/j.envsoft.2021.105028>
- Ocampo-Martinez, C., Puig, V., Cembrano, G., & Quevedo, J. (2013). Application of predictive control strategies to the management of complex networks in the urban water cycle. *IEEE Control Systems Magazine*, 33(1), 15–41. <https://doi.org/10.1109/MCS.2012.2225919>
- Olden, J. D., & Poff, N. L. (2003). Redundancy and the choice of hydrologic indices for characterizing streamflow regimes. *River Research and Applications*, 19(2), 101–121. <https://doi.org/10.1002/rra.700>
- Olsson, G. (2012). ICA and me — A subjective review. *Water Research*, 46(6), 1585–1624. <https://doi.org/10.1016/j.watres.2011.12.054>
- Piccardi, C., & Soncini-Sessa, R. (1991). Stochastic dynamic programming for reservoir optimal control: Dense discretization and inflow correlation assumption made possible by parallel computing. *Water Resources Research*, 27(5), 729–741. <https://doi.org/10.1029/90WR02766>
- Poff, N., Richter, B. D., Arthington, A. H., Bunn, S. E., Naiman, R. J., Kendy, E., et al. (2010). The ecological limits of hydrologic alteration (ELOHA): A new framework for developing regional environmental flow standards. *Freshwater Biology*, 55(1), 147–170. <https://doi.org/10.1111/j.1365-2427.2009.02204.x>
- Poff, N. L., Allan, D. J., Bain, M. B., Karr, J. R., Prestegard, K. L., Richter, B. D., et al. (1997). The natural flow regime. *BioScience*, 47(11), 769–784. <https://doi.org/10.2307/1313099>
- Price, K. (2011). Effects of watershed topography, soils, land use, and climate on baseflow hydrology in humid regions: A review. *Progress in Physical Geography: Earth and Environment*, 35(4), 465–492. <https://doi.org/10.1177/0309133311402714>
- Pyrgou, A., Kylii, A., & Fokaides, P. A. (2016). The future of the feed-in tariff (FiT) scheme in Europe: The case of photovoltaics. *Energy Policy*, 95, 94–102. <https://doi.org/10.1016/j.enpol.2016.04.048>
- Quinn, R., Rougé, C., & Stovin, V. (2021). Quantifying the performance of dual-use rainwater harvesting systems. *Water Research*, 10, 100081. <https://doi.org/10.1016/j.wroa.2020.100081>
- R Core Team (2020). *R: A language and environment for statistical computing. R: Foundation for statistical computing*. Vienna, Austria. Retrieved from <https://www.r-project.org/>
- Roman, D., Braga, A., Shetty, N., & Culligan, P. (2017). Design and modeling of an adaptively controlled rainwater harvesting system. *Water*, 9(12), 974. <https://doi.org/10.3390/w9120974>
- Rose, S., & Peters, N. E. (2001). Effects of urbanization on streamflow in the Atlanta area (Georgia, USA): A comparative hydrological approach. *Hydrological Processes*, 15(8), 1441–1457. <https://doi.org/10.1002/hyp.218>
- Russell, K. L., Vietz, G. J., & Fletcher, T. D. (2020). How urban stormwater regimes drive geomorphic degradation of receiving streams. *Progress in Physical Geography: Earth and Environment*, 1–33. <https://doi.org/10.1177/0309133319893927>
- Sandell, N., Varaiya, P., Athans, M., & Safonov, M. (1978). Survey of decentralized control methods for large scale systems. *IEEE Transactions on Automatic Control*, 23(2), 108–128. <https://doi.org/10.1109/TAC.1978.1101704>
- Sapkota, M., Arora, M., Malano, H., Moglia, M., Sharma, A., & Pamminger, F. (2018). Understanding the impact of hybrid water supply systems on wastewater and stormwater flows. *Resources, Conservation and Recycling*, 130, 82–94. <https://doi.org/10.1016/j.resconrec.2017.11.025>
- Schubert, J. E., Burns, M. J., Fletcher, T. D., & Sanders, B. F. (2017). A framework for the case-specific assessment of green infrastructure in mitigating urban flood hazards. *Advances in Water Resources*, 108, 55–68. <https://doi.org/10.1016/j.advwatres.2017.07.009>
- Shafer, S. C., Scott, D., Baker, J., & Winemiller, K. (2013). Recreation and amenity values of urban stream corridors: Implications for green infrastructure. *Journal of Urban Design*, 18(4), 478–493. <https://doi.org/10.1080/13574809.2013.800450>
- Shishegar, S., Duchesne, S., & Pelletier, G. (2018). Optimization methods applied to stormwater management problems: A review. *Urban Water Journal*, 15(3), 276–286. <https://doi.org/10.1080/1573062X.2018.1439976>
- Shishegar, S., Duchesne, S., & Pelletier, G. (2019). An integrated optimization and rule-based approach for predictive real time control of urban stormwater management systems. *Journal of Hydrology*, 124000. <https://doi.org/10.1016/j.jhydrol.2019.124000>
- Staple, W. J. (1966). Infiltration and redistribution of water in vertical columns of loam soil. *Soil Science Society of America Journal*, 30(5), 553–558. <https://doi.org/10.2136/sssaj1966.03615995003000050010x>
- Sweetapple, C., Fu, G., & Butler, D. (2014). Multi-objective optimisation of wastewater treatment plant control to reduce greenhouse gas emissions. *Water Research*, 55, 52–62. <https://doi.org/10.1016/j.watres.2014.02.018>
- Vörösmarty, C. J., McIntyre, P. B., Gessner, M. O., Dudgeon, D., Prusevich, A., Green, P., et al. (2010). Global threats to human water security and river biodiversity. *Nature*, 467(7315), 555–561. <https://doi.org/10.1038/nature09440>
- Walsh, C. J., Booth, D. B., Burns, M. J., Fletcher, T. D., Hale, R. L., Hoang, L. N., et al. (2016). Principles for urban stormwater management to protect stream ecosystems. *Freshwater Science*, 35(1), 398–411. <https://doi.org/10.1086/685284>
- Walsh, C. J., Fletcher, T. D., & Burns, M. J. (2012). Urban stormwater runoff: A new class of environmental flow problem. *PLoS ONE*, 7(9), 1–10. <https://doi.org/10.1371/journal.pone.0045814>
- Ward, S., Memon, F. A., & Butler, D. (2012). Performance of a large building rainwater harvesting system. *Water Research*, 46(16), 5127–5134. <https://doi.org/10.1016/j.watres.2012.06.043>

- Xu, W. D., Burns, M. J., Cherqui, F., & Fletcher, T. D. (2020). Enhancing stormwater control measures using real-time control technology: A review. *Urban Water Journal*, 1–14. <https://doi.org/10.1080/1573062X.2020.1857797>
- Xu, W. D., Fletcher, T. D., Burns, M. J., & Cherqui, F. (2020). Real time control of rainwater harvesting systems: The benefits of increasing rainfall forecast window. *Water Resources Research*, 56(9), e2020WR027856. <https://doi.org/10.1029/2020wr027856>
- Xu, W. D., Fletcher, T. D., Duncan, H. P., Bergmann, D., Breman, J., & Burns, M. J. (2018). Improving the multi-objective performance of rainwater harvesting systems using real-time control technology. *Water*, 10(2), 147. <https://doi.org/10.3390/w10020147>
- Zimmer, A., Schmidt, A., Ostfeld, A. & Minsker, B. (2015). Evolutionary algorithm enhancement for model predictive control and real-time decision support. *Environmental Modelling & Software*, 69, 330–341. <https://doi.org/10.1016/j.envsoft.2015.03.005>

Reference From the Supporting Information

- Wang, Q., Wang, L., Huang, W., Wang, Z., Liu, S., & Savić, D. A. (2019). Parameterization of NSGA-II for the optimal design of water distribution systems. *Water*, 11(5), 971. <https://doi.org/10.3390/w11050971>