



HAL
open science

Energetic Macroscopic Representation of a mechanical compression-assisted hybrid thermochemical cycle exploiting low grade heat for cold applications

Antoine Perrigot, Maxime Perier-Muzet, Pascal Ortega, Franco Ferrucci, Driss Stitou

► To cite this version:

Antoine Perrigot, Maxime Perier-Muzet, Pascal Ortega, Franco Ferrucci, Driss Stitou. Energetic Macroscopic Representation of a mechanical compression-assisted hybrid thermochemical cycle exploiting low grade heat for cold applications. *Energy Conversion and Management*, 2023, 294, pp.117521. 10.1016/j.enconman.2023.117521 . hal-04191758

HAL Id: hal-04191758

<https://hal.science/hal-04191758v1>

Submitted on 30 Aug 2023

HAL is a multi-disciplinary open access archive for the deposit and dissemination of scientific research documents, whether they are published or not. The documents may come from teaching and research institutions in France or abroad, or from public or private research centers.

L'archive ouverte pluridisciplinaire **HAL**, est destinée au dépôt et à la diffusion de documents scientifiques de niveau recherche, publiés ou non, émanant des établissements d'enseignement et de recherche français ou étrangers, des laboratoires publics ou privés.

Nomenclature:

Variables

$\Delta_r H$ ($J \cdot mol^{-1}$)	Enthalpy of reaction
$\Delta_r S$ ($J \cdot mol^{-1} \cdot K^{-1}$)	Entropy of reaction
C_v (–)	Flow coefficient of a valve
\dot{S} ($J \cdot mol^{-1} \cdot K^{-1} \cdot s^{-1}$)	Entropy flow
c_p ($J \cdot kg^{-1} \cdot K^{-1}$)	Mass heat capacity
\dot{m} ($kg \cdot s^{-1}$)	Mass flow rate
\dot{n} ($mol \cdot s^{-1}$)	Molar flow rate
v_m ($m^3 \cdot mol^{-1}$)	Molar volume
h ($J \cdot mol^{-1}$)	Molar specific enthalpy
Φ (W)	Rate of heat flow
Ω (rpm)	Compressor rotation speed
G (–)	Specific density
H (J)	Enthalpy
P (bar)	Pressure
Q (J)	Heat
R ($J \cdot K^{-1} \cdot mol^{-1}$)	Ideal gas constant
S ($J \cdot mol^{-1} \cdot K^{-1}$)	Entropy
T (K)	Temperature
t (s)	Time
U (J)	Internal energy
UA ($W \cdot K^{-1}$)	Overall heat transfer coefficient
V (m^3)	Volume
X (–)	Advancement of the reaction
m (kg)	Mass
n (mol)	Number of moles
w (J)	Mechanical work
α	Kinetic exponent
ε (–)	Ratio dead/swept volume
η (–)	Efficiency
ν (–)	Stoichiometric coefficient

Acronyms

EMR	Energetic Macroscopic Representation
ENG	Expanded Natural Graphite
RMSE	Root Mean Square Error

Subscripts and superscripts

$^\circ$	Standard conditions
htf	Heat transfer fluid
av	Average
kin	Kinetic
comp	Compressor
cond	Condenser
cc	Compression chamber
dec	Decomposition
dv	Dead volume
eq	Equilibrium
evap	Evaporator
exp	Experimental
ext	Exterior
g	Gas
in	Inlet/Input
int	Interior
is	Isentropic
l	Liquid
out	Outlet/Output
r	Reactor
s	Salt
sat	Saturation
sim	Simulation
synt	Synthesis
sys	System
w	Wall
cr	Cold room

29 **1. Introduction**

30 **1.1. Study framework**

31 Within the framework of the energy transition, thermochemical systems could prove to be an interesting
32 way for valorizing low temperature heat sources (less than 100°C), such as industry thermal waste or low
33 temperature solar heat provided by simple flat plate collectors. In 2016, according to [1], 72% of the primary
34 energy consumption is lost and transformed into heat and 63% of this heat is rejected at a temperature lower
35 than 100 °C. Thermochemical systems allow to obtain different useful effects such as heat upgrading or cold
36 production while also providing a long term storage function with no self-discharge. Basic thermochemical
37 heat transformers are based on the management of a reversible chemical reaction between a reactive salt
38 (the sorbent) and a gas (the sorbate). They are mainly heat driven systems (electricity is only needed to power
39 the circulation pumps for the various heat transfer fluids) and thus allow cold production with low electricity
40 consumption.

41 Despite this obvious advantage, the most recent research is focused on the hybridization of a such
42 thermochemical systems with a mechanical compressor powered by electricity. This is because the latter
43 allows a wider range of application for thermochemical systems by making it possible to use heat sources at
44 lower temperatures or to produce cold at lower temperatures than basic thermochemical heat transformers.
45 These new hybrid systems allow, for example, to produce heat at 150°C from a heat source available only at
46 90°C [2], to perform an inter-seasonal storage allowing to heat a house in a cold climate with outside
47 temperature ranging from -5°C to -30°C) [3], to produce heat and cold simultaneously [4], [5], to use and
48 valorize the heat of exhaust gases of a refrigerated truck in order to help maintain the temperature of its cold
49 chamber [6], [7] or to make possible a cold production by recovering the heat generated by a fuel cell or/and
50 an electrolyzer allowing to obtain increase the overall efficiency of the electricity storage/discharge in the
51 form of hydrogen [8].

52 The original modeling approach of a hybrid compression-assisted thermochemical systems that is
53 proposed here, allows on the one hand to facilitate the implementation and the coupling of this process to

54 other components that are modelled with the same Energetic Macroscopic Formalism (EMR) and on the other
55 hand makes it possible to obtain control structures for the system which enable the definition of the different
56 control laws to be applied to the system to achieve the desired effect. It is thus possible to set the different
57 control variables (flow rates of heat transfer fluids, compressor rotation speed...) to be applied to the system.
58 Both of these two new features are made possible by using the Energetic Macroscopic Representation (EMR)
59 approach, which is developed and applied for the first time to this kind of thermochemical process.

60 This paper is structured as follows: part 2 is about the description of the EMR and of a classical
61 thermochemical system. The development of the EMR model which represents the major part of the work is
62 presented in part 3. Part 4 concerns the validation of this model with experimental data. Part 5 presents an
63 example of the use of the EMR model, such as the temperature control strategy of a cold room, whose
64 structure is obtained by inversion of the EMR model. Finally, a conclusion is reached in part 6.

65

66 **2. EMR and system description**

67 **2.1. The Energetic Macroscopic Representation**

68 The Energetic Macroscopic Representation (EMR) is a graphical formalism that allows a synthetic
69 representation of multi-physical energetic systems described in [9]. A systematic deduction of control
70 structures can be achieved if different formalism rules are respected. The EMR design was inspired by other
71 types of system representations such as the Bond graph or the causal informational graph. Developed in 2000
72 to analyze and control electromechanical systems, the EMR formalism has been extended over the years to
73 cover other energetic domains. To describe physically each of these domains, a pair of kinetic and potential
74 variables is used to respect the action-reaction principle. This principle requires on the one hand, that any
75 subsystem imposing an action on another subsystem receives in return a reaction from the latter and on the
76 other hand, that the product of the action and reaction variables is homogenous to a power. However, for
77 some physical domains such as thermodynamics, it is necessary to have more than 2 variables to qualify the

78 energy exchange between two subsystems. A further extension has been proposed by Agbli *et al.* [10] to allow
 79 the modelling of thermodynamic systems with 3 variables. The different sets of variables that can be used
 80 depending on the physical domain considered are summarized in Table 1.

81 *Table 1 : Effort and flow variables that are available in EMR in function of the physical domain considered.*

Domain	Potential variable	Kinetic variable
Electric	Tension [V]	Current [A]
Translational mechanics	Force [N]	Velocity [m.s ⁻¹]
Rotational mechanics	Torque [N.m]	Angular velocity [rad.s ⁻¹]
Hydraulics	Pressure [Pa]	Volumetric flow rate [m ³ .s ⁻¹]
Thermal	Temperature [K]	Entropy flow [W.K ⁻¹]
Thermodynamic	Temperature [K]	Pressure [Pa] Molar flow rate [mol.s ⁻¹]

82
 83 In addition to the action-reaction principle, the EMR is based on the principle of integral causality. This can
 84 be summarized by the following observation: if any phenomenon, called the cause, generates at a given time
 85 another phenomenon, called the effect, then it is impossible for the effect to be preceding the cause. In other
 86 terms, the reaction of a subsystem can only occur with a certain delay regarding the action that generated it.
 87 The integral causality goes further in the description of physical systems as it imposes then from this integral
 88 causality, to describe the outputs of a subsystem has an integral function of the inputs. This is the natural way
 89 to describe physical systems because if a derivative causality were used, the system would respond with an
 90 infinite power to a step input, which is not the physical response of a real system.

91 The EMR is based on the description of the energy exchanges between the different components of a
 92 complex system. Each component is represented by a given block and different blocks can be used to describe
 93 the physics of the system. A source element is used at each bound point to represent a source or sink of power
 94 for the system. When a subsystem accumulates energy, an accumulation block is additionally used. A mono-
 95 physical coupling block enable the representation of a subsystem submitted to the same energetic domain on
 96 both sides. When the domain is different on each side of the subsystem a multi-physical conversion block is
 97 then used. The EMR also offers the possibility to represent subsystems submitted to more than 2 energy flows
 98 by using several coupling blocks. Finally, with the extension of the EMR towards thermodynamics, several
 99 blocs have been added in order to express the power contained in a fluid flow. In order to obtain a control

100 structure from an EMR model it is necessary to perform an inversion of each of the blocks involved in the
 101 control chain. These blocks are represented in blue. All these blocs are given in *Figure 1*.

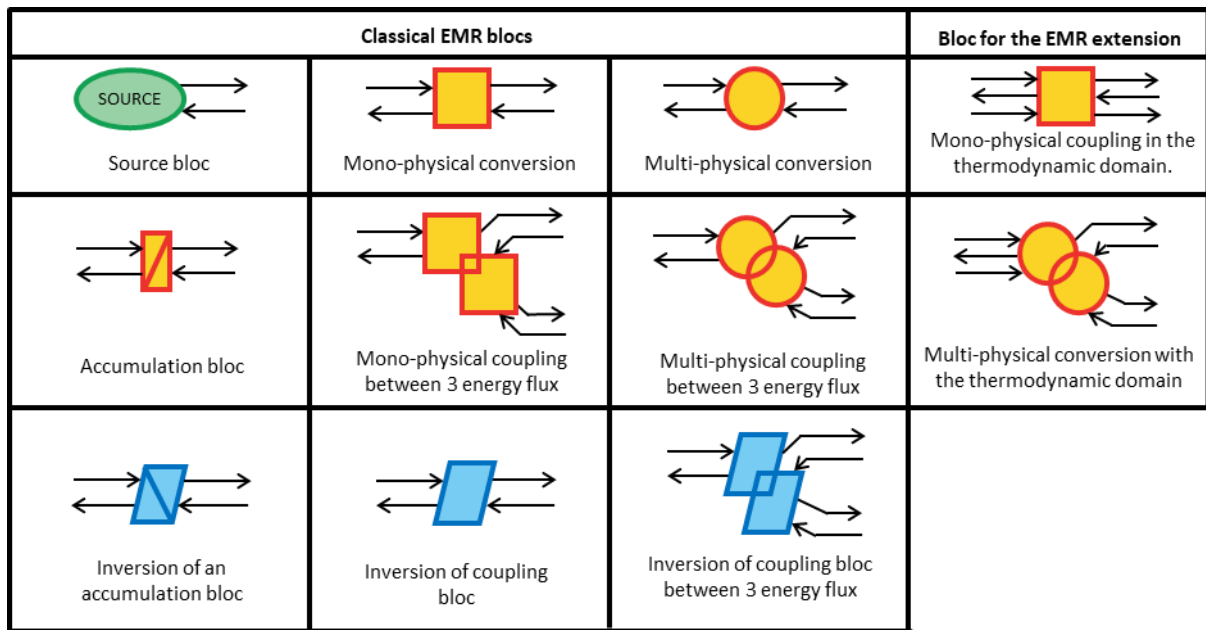

102

103 *Figure 1 : Blocs available in an EMR model.*

104 The EMR has two major advantages. On the one hand, it allows to easily couple different systems together
 105 if they are all modeled according to this formalism. In addition, the EMR enables to easily find a control
 106 structure by an inversion method of the model as well as the required number of sensors to be implemented
 107 to operate this control. This inversion is only feasible if all the EMR principles have been correctly observed.

108 Since its initial use for describing electromechanical systems in 2000, the EMR has been applied many
 109 times to model complex systems. These include for example a hybrid electric vehicle [11], a wind turbine [12],
 110 a subway traction system [13], a diesel internal combustion engine [14], a Stirling engine [15], an electrolyzer
 111 [16] or a fuel cell [17]. The EMR model developed in this paper is however the first one developed for a
 112 solid/gas thermochemical system.

113 **2.2. Thermochemical systems**

114 Thermochemical systems can be used to store and valorize low-grade waste heat for later production of
 115 higher temperature heat (heat upgrading) or cooling. The modeling presented in this paper is intended for a

116 cold production system, but only a few modifications would be necessary to model a thermochemical heat
 117 transformer process. A thermochemical sorption system is based on the thermal effect of the reversible solid-
 118 gas reaction shown by equation (1). For this modeling, the reaction between a salt and a reactive gas takes
 119 place in a single fixed-bed reactor that exchanges the reactive gas with an evaporator or a condenser according
 120 to the direction of the reaction:



121 The left to right direction in equation (1) corresponds to the synthesis phase where one mole of the
 122 desorbed salt (S_0) reacts with ν moles of gas (G) to form the synthesized salt (S_1). $\Delta_r H^\circ$ is the standard enthalpy
 123 of reaction and corresponds to the rejected heat when a mole of gas is absorbed by the salt during the
 124 synthesis reaction. The right to left direction corresponds to the decomposition phase, which is an
 125 endothermic reaction. This reaction is monovariant so if one intensive parameter is fixed, temperature or
 126 pressure for example, the other is set by the equilibrium state. The equilibrium can be described in a first
 127 approximation with the Clausius-Clapeyron equation as shown in (2) and described by [18].

$$P_{\text{eq}} = P_{\text{ref}} \cdot \exp\left(\frac{\Delta_r H^\circ}{R} - \frac{\Delta_r S^\circ}{R \cdot T_{\text{eq}}}\right) \quad (2)$$

128 In this equation, P_{eq} is the equilibrium pressure of the reaction taking place at the temperature T_{eq} . $\Delta_r H^\circ$
 129 and $\Delta_r S^\circ$ represent respectively the enthalpy and entropy of reaction in the standard conditions ($P_{\text{ref}} = 1$ bar
 130 and $T_{\text{ref}} = 25^\circ\text{C}$). Thermodynamic constraints in pressure and temperature different from those
 131 corresponding to equilibrium must be imposed on the reactor for the reaction to take place.

132 A conventional thermochemical system with fixed-bed reactor operates according two distinct phases and
 133 consists of 5 main components: a reactor, a condenser, a tank, an expansion valve and an evaporator. During
 134 the storage phase, also called decomposition phase, the thermal energy from the hot source (Q_{dec}) is
 135 transferred to the reactor to raise its temperature. The reactor being closed, the temperature increases up to
 136 the temperature of the hot source T_{hot} and leads to a pressure increase due to the monovariant equilibrium

137 of the reaction. This equilibrium is described by equation (2)(21). When the pressure in the reactor reaches
138 the condenser pressure, these two components are then connected. The pressure in the reactor is thus fixed
139 by the condenser and its temperature is conditioned by the heat exchange with the hot source. The reactant
140 is put out of equilibrium and the decomposition reaction takes place: the gas is desorbed and flows towards
141 the condenser. In the condenser, the gas is cooled down to the saturated vapor state (desuperheating of the
142 vapors) and then condenses. These two phenomena imply that a quantity of heat (Q_{cond}) must be evacuated
143 towards the environment sink. The resulting liquid is stored at ambient temperature in the liquid tank.

144 Before the cold production phase, also known as the synthesis phase, the valve connecting the reactor to
145 the rest of the system is closed to isolate it. The reactor is cooled by a heat transfer fluid to lower its pressure.
146 When the pressure drops below that of the evaporator, the reactor is connected to the evaporator. The gas is
147 then chemically absorbed by the reactive salt producing a heat of reaction (Q_{synt}) that is released to the
148 environment. This chemical reaction between the gas and the reactive salt causes a decrease in pressure at
149 the evaporator and, to compensate for this decrease in pressure, the liquid in the evaporator vaporizes,
150 inducing an endothermic effect at temperature T_{cold} . The liquid in the tank is then expanded to the
151 vaporization pressure to feed the evaporator. The endothermic nature of evaporation allows heat to be
152 absorbed from the cold source (Q_{evap}), which is the desired useful effect.

153 Scientific research has focused on hybrid thermochemical systems using a compressor for several years
154 now. This enables to recover heat at a lower temperature than conventional systems [19], [20] or to produce
155 cold at a lower temperature [21]. The compressor can be used independently in the two phases of operation
156 of the thermochemical system. The operating of such hybrid thermochemical systems is described in Figure 2.
157 In this figure, Q_{cond} , Q_{evap} , Q_{dec} and Q_{synt} represent the heat exchanged in the condenser, evaporator and
158 reactor respectively, depending on whether the phase is decomposition or synthesis. The compressor in the
159 decomposition phase allows the pressure of the reactor (P_{dec}) and the condenser (P_{cond}) to be decoupled
160 thanks to a mechanical work (W_{comp}^{dec}). The reactor can therefore desorb the gas at a lower temperature T'_{hot}
161 than would be required if the reactor were directly connected to the condenser (T_{hot}). This allows the reactor

162 to operate at a lower pressure that of the condenser and the compressor allows the gas to flow towards the
 163 condenser by overcoming the pressure difference. In the synthesis phase, the compressor allows the
 164 evaporation pressure (P_{evap}) to be decoupled from the reactor pressure (P_{synt}) thanks to the mechanical work
 165 (W_{comp}^{synt}) and thus the evaporation pressure to be reduced. The cold is thus produced at a lower temperature
 166 T'_{cold} .

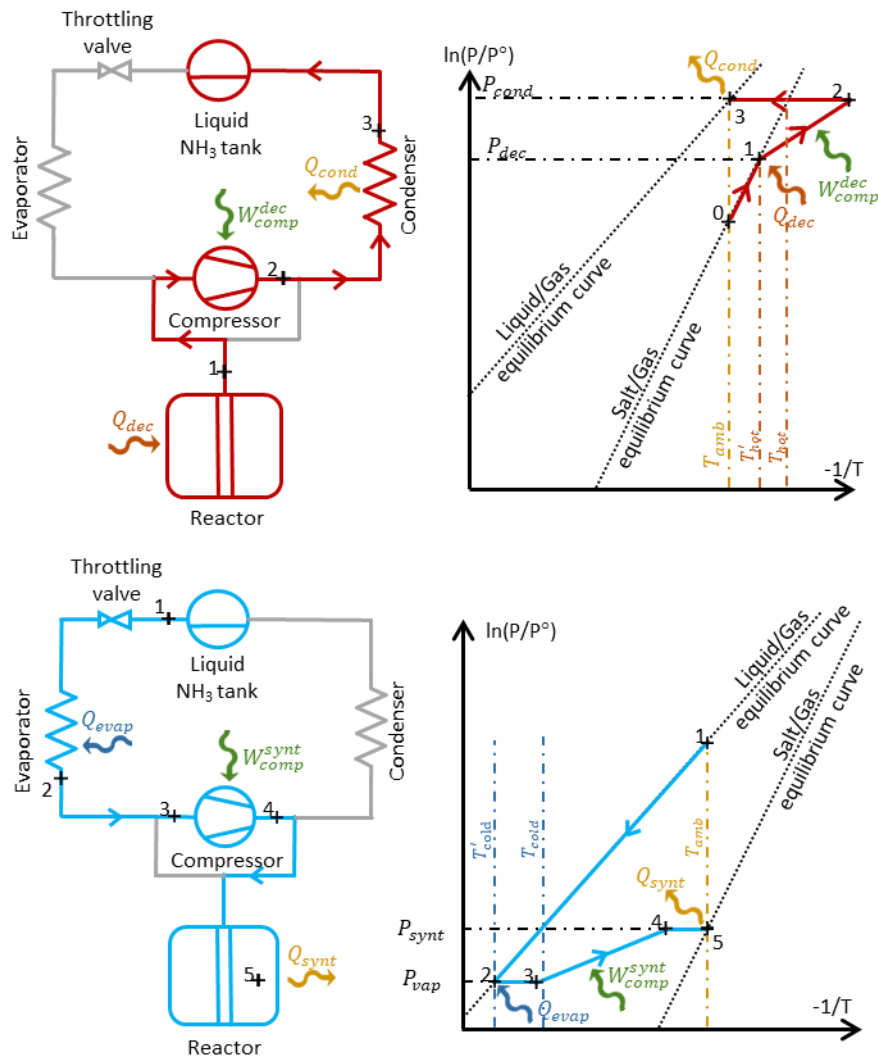

167

168 *Figure 2 : Description of the 2 proposed compressor configurations: the assisted decomposition on top and*
 169 *the assisted synthesis below.*

170 Several types of modeling for thermochemical fixed bed reactor have been developed in the scientific
 171 literature. The first one was developed from the description of a small volume of salt and described the heat

172 and mass transfers at this local scale [22]. At each point of the reactor the pressure, the temperature and the
173 advancement of the reaction is available thanks to the resolution of differential equations resulting from heat
174 and mass balance. These types of models enable to show the existence of two reaction fronts more or less
175 diffused. The first one is relative to the heat transfer inside the reactive bed and the second one to the mass
176 transfer. This type of model enables a detailed understanding of the phenomenon at a small scale but requires
177 the knowledge of many data related to the material and difficult to access. To make the computation of this
178 model easier, a simplification of this model has been proposed by considering sharp reactive fronts [23]. It has
179 also been shown in [24] that if pressure is high enough in the reactor (greater than 0.5 bar) to prevent kinetics
180 limitations or if the permeability of the reactive bed is high enough, then the mass transfer no longer limits
181 the reaction rate and the pressure can then be assumed to be uniform in the reactor. Finally, a last
182 simplification can be made by assuming that the temperature is also uniform in the reactor. This simplification
183 can be made if Expanded Natural Graphite (ENG) is used to find an optimization between heat and mass
184 transfers inside the reactor. This latter type of simplified model of fixed-bed solid/gas reactor is used here to
185 develop the EMR of the thermochemical system.

186 **3. EMR of a hybrid thermochemical system**

187 **3.1. EMR of the solid/gas thermochemical reactor**

188 The fixed-bed reactor, depicted on Figure 3 consists of a metallic envelop in which is contained a porous
189 reactive material composed of a compressed composite of salt and expanded natural graphite (GNE) allowing
190 to improve both the diffusion of the reactive gas and the heat transfer. The reactor tube wall is subjected to
191 heat exchange with a heat transfer fluid, which is usually either air or water flowing. Gas diffusers are located
192 in the reactive composite to distribute axially the reactive gas all along the reactor. The dead volume, which
193 represents the volume of the reactor that is not occupied by the reactive composite, is therefore composed
194 of the volume of the diffusers, the free volume of the reactor not occupied by the reactive bed as well as the
195 void volume constituting the porosity of the reactive composite material.

196 The EMR modeling being based on a macroscopic scale of the energy transfers between the different
197 subsystems, the reactor is considered as a set of 3 subsystems: the reactor wall, the reactive composite and
198 the dead volume. Several assumptions are made to simplify the thermochemical reactor modeling:

- 199 - The heat transfer between the dead volume and the reactor tube wall is neglected.
- 200 - The reactor shell is assumed to be thermally insulated and therefore does not exchange heat with
201 the environment but only with the heat transfer fluid.
- 202 - The temperature and pressure are assumed to be uniform in the reactor.
- 203 - Kinetic and potential energy variations are neglected.
- 204 - The thermal capacities of the different materials are taken constant whatever the operating
205 temperature.
- 206 - All solids (wall and reactive composite) are assumed to be inexpandible and indilatable.

207

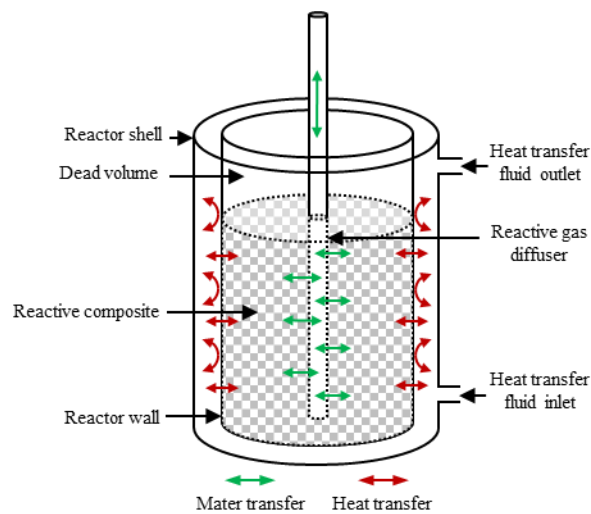

208

209 *Figure 3 : Scheme of the reactor composed of the 3 subsystems (reactor tube wall, reactive composite and*
210 *dead volume).*

211 The reactor environment is composed of two sources. On the one hand it is subjected to a thermal
212 exchange between the heat transfer fluid and the reactor tube wall and, on the other hand, to a gas exchange
213 through the top of the diffuser with the other components of the system (evaporator, condenser or

214 compressor). These exchanges with the sources require the knowledge of the temperature of the heat transfer
215 fluid and the molar flow of gas exchanged between the reactor and the rest of the system.

216 The wall of the reactor tube as well as the reactive composite itself can accumulate thermal energy, the
217 dead volume can accumulate a certain quantity of gas. There are thus 3 energy accumulators in this system,
218 which will ultimately correspond to 3 state variables for the reactor model and thus 3 accumulation blocs in
219 the EMR model. A schematic representation of these different blocks to be designed, with their thermal or
220 mass interactions is shown in Figure 4.

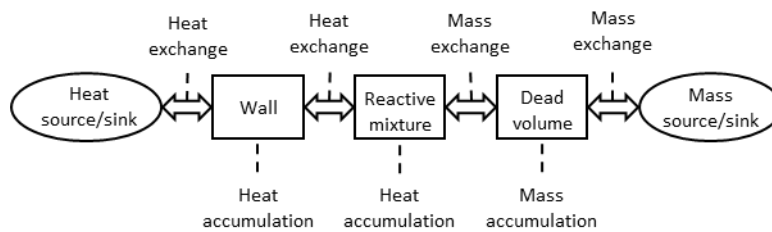

221

222 *Figure 4 : Scheme of the different subsystems representing the reactor and the different energy exchanges*
223 *between them.*

224 From these considerations it is possible to design the EMR diagram of the reactor with the different blocs
225 that compose it as well as the different variables representing the energy exchanges. The complete EMR
226 scheme of the reactor is described in Figure 5. The various variables shown in this figure are described below
227 as they appear in the equations describing the behavior of the various blocks. It is also possible to refer to the
228 nomenclature to find the meaning of each variable if required.

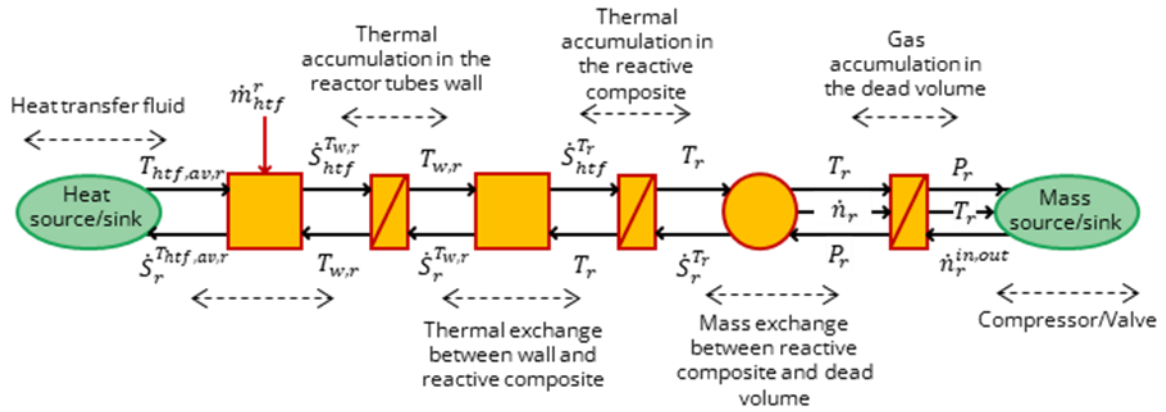

Variables		Subscripts and superscript	
T	Temperature	htf	Heat Transfer Fluid
P	Pressure	av	Average
\dot{n}	Molar flow rate	r	Reactor
\dot{S}	Entropy flow	w	Wall
\dot{m}	Mass flow rate		

229

230

Figure 5 : EMR representation of the reactor.

231

3.1.1. Heat exchange between the heat transfer fluid and the tube reactor wall

232

233

234

235

The block representing the heat exchange between the heat transfer fluid and the tube reactor wall is a monophysical conversion block as depicted on Figure 5. The inputs are the mean temperature of the heat transfer fluid $T_{htf,av,r}$ and the reactor wall T_w . The outputs are the entropy fluxes associated to the heat exchange $\dot{S}_r^{T_{htf,av}}$ and $\dot{S}_{htf}^{T_w}$.

236

237

238

The entropy fluxes are computed as the ratio between the thermal power exchanged between the heat transfer fluid and the tube reactor wall $\Phi_{w,htf}$ and the considered temperature as shown by equations (3) and (4).

$$\dot{S}_r^{T_{htf,av}} = \frac{\Phi_{w,htf}}{T_{htf,av,r}} \quad (3)$$

$$\dot{S}_{htf}^{T_w} = \frac{\Phi_{w,htf}}{T_w} \quad (4)$$

239 The thermal power can be expressed from the knowledge of a heat exchange coefficient $(UA)_{r,ext}$ and
 240 the average logarithmic temperature difference between the heat transfer fluid and the wall. It's assumed
 241 that the temperature difference between the inlet and outlet of the heat transfer fluid is small thus the
 242 average logarithmic temperature difference can be estimated as a first approximation by the difference
 243 between the average temperature of the heat transfer fluid and the wall temperature. The heat flux can thus
 244 be expressed using the equation described by equation (5).

$$\Phi_{w,htf} = (UA)_{r,ext} \cdot (T_{htf,av,r} - T_w) \quad (5)$$

245 The estimation of the overall heat exchange coefficient is not trivial because of the complex geometry of
 246 the heat exchanger. For this reason, it is calculated as a power function of the heat transfer fluid flow rate
 247 \dot{m}_{htf}^r using a multiplier constant A that is determined by identification from experimental observations. The
 248 exponent is determined from the Nusselt correlations found in the literature. The final expression is given by
 249 equation (6).

$$(UA)_{r,ext} = A \cdot (\dot{m}_{htf}^r)^{0.6} \quad (6)$$

250

251 3.1.2. Heat accumulation in the tube reactor wall

252 The block that represents the thermal accumulation in the reactor wall is an accumulation block that
 253 receives two entropy flows, one coming from the heat transfer fluid $\dot{S}_{htf}^{T_{w,r}}$ and the second from the reactive
 254 composite $\dot{S}_r^{T_{w,r}}$. This block output is the state variable $T_{w,r}$. This temperature is calculated from a heat balance
 255 on the reactor wall based on the thermal mass of the reactor wall $(m \cdot c_p)_{w,r}$ as shown by equation (7).

$$(m \cdot c_p)_{w,r} \cdot \frac{dT_{w,r}}{dt} = (\dot{S}_{htf}^{T_{w,r}} - \dot{S}_r^{T_{w,r}}) \cdot T_{w,r} \quad (7)$$

256 A first order differential equation is obtained. The block output $T_{w,r}$ is expressed as an integral function of
 257 the inputs (entropy flows). The integral causality imposed by the EMR formalism is thus respected.

258 3.1.3. Heat exchange between the reactor wall and the reactive composite

259 This heat exchange is slightly different from the exchange between the heat transfer fluid and the wall
 260 because here a heat exchange at the surface contact between two solids. By defining an overall heat exchange
 261 coefficient $(UA)_{r,int}$, characterizing a contact conductance between the wall and the reactive composite, it is
 262 possible to estimate the heat flux $\Phi_{w,r}$ from the input data of the block that are the reactor wall temperature
 263 $T_{w,r}$ and the reactive mixture temperature T_r as shown in equation (8). The overall heat transfer coefficient
 264 will be estimated using an identification from experimental observations because there is no correlation to
 265 compute it.

$$\Phi_{w,r} = (UA)_{r,int} \cdot (T_{w,r} - T_r) \quad (8)$$

266 The expression of the entropy flux is then obtained in a similar way to what has been presented in the
 267 equation (3)

268 **3.1.4. Heat accumulation in the reactive composite**

269 The block representing the thermal accumulation in the reactive composite is a block with two entropy
 270 flows as inputs. The first one comes from heat exchange with the tube reactor wall $\dot{S}_{htf}^{T_r}$ and the second one
 271 from the decomposition or synthesis reaction taking place within the reactive composite $\dot{S}_r^{T_r}$. These two
 272 entropy flows are obtained using a first principle balance on the reactive composite as shown in equation (9).
 273 In this balance, it is essential to note that the sensible heat of the gas arriving in the reactor during the synthesis
 274 is neglected. This approximation allows to simplify the EMR modeling while remaining an acceptable
 275 assumption since the sensible heat is weak in front of the reaction heat because the gas arrives in the reactor
 276 at a temperature relatively close to it.

$$\frac{dU_{s+ENG}}{dt} = (UA)_{r,int} \cdot (T_{w,r} - T_r) + \dot{n}_r \cdot h_g(T_r) \quad (9)$$

277 In this equation, U_{s+ENG} represents the internal energy of the salt and the ENG, $T_{w,r}$ and T_r refers
 278 respectively to the reactor wall temperature and the reactive mixture temperature, \dot{n}_r refers to the molar
 279 flow rate of gas consumed (synthesis) or produced (decomposition) the chemical reaction and h_g is the molar
 280 enthalpy of the gas. The flow rate is considered positive for the synthesis reaction. It is possible to express this

281 flow rate from the variation of the reaction advancement X and the total number of moles of salt in the
282 reactant n_s by equation (10).

$$\dot{n}_r = \nu \cdot n_s \cdot \frac{dX}{dt} \quad (10)$$

283 Where ν is the stoichiometric coefficient of the reaction, i.e. the number of moles of desorbed gas by
284 moles of reactive salt.

285 Since the internal energy of the reactive mixture U_{s+ENG} is an extensive state variable, it can be expressed
286 as the sum of the internal energy of the salt U_s and the expanded natural graphite U_{ENG} as presented by the
287 equation (11).

$$\frac{dU_{s+ENG}}{dt} = \frac{dU_s}{dt} + \frac{dU_{ENG}}{dt} \quad (11)$$

288 The case of expanded natural graphite is rather simple because it is possible to assume it as an
289 incompressible and inexpandible solid. With the knowledge of the thermal mass of the ENG $(m \cdot c_p)_{ENG}$ and
290 the reactive mixture temperature T_r , equation (12) enable the computation of the internal energy of the ENG
291 U_{ENG} .

$$\frac{dU_{ENG}}{dt} = (m \cdot c_p)_{ENG} \cdot \frac{dT_r}{dt} \quad (12)$$

292 For the salt, it is necessary to consider its composition (proportion of charged salt and discharged salt)
293 which varies in time according to the advancement of reaction X . To express the internal energy of salt U_s it
294 is preferable to go through the calculation of its enthalpy H_s because in the case where the salt is considered
295 as an incompressible and inexpandible solid it is possible to consider that $dH_s = dU_s$. The enthalpy of the salt
296 can then be decomposed as a function of the molar enthalpy of the charged salt h_1 and the discharged salt h_0
297 in gas considering as shown in equation (13) where n_s represents the total number of salt.

$$H_s = n_s \cdot [h_0 \cdot (1 - X) + h_1 \cdot X] \quad (13)$$

298 The enthalpy of reaction ΔH_r is defined as the thermal energy released by the absorption of one mole of
299 gas during the synthesis reaction. This can be expressed by looking at the reaction expression (1). Equation

300 (14) is thus obtained where h_0 and h_1 represent respectively the molar enthalpy of the discharged and charged
301 salt, ν is the stoichiometric coefficient of the reaction and h_g the molar enthalpy of the gas involved in the
302 reaction.

$$\Delta_r H = \frac{h_0 - h_1 + \nu \cdot h_g}{\nu} \quad (14)$$

303 The enthalpy of reaction $\Delta_r H$ depends on the pressure and the temperature at which the reaction is
304 carried out but it is usual, taking into account the relatively weak amplitudes of temperature and pressure
305 undergone by the thermochemical process, to make the assumption that the enthalpy of reaction is constant,
306 and equal to the enthalpy of reaction in the normal conditions of pressure and temperature ($P^\circ = 1 \text{ bar}$ and
307 $T^\circ = 25 \text{ }^\circ\text{C}$). This defines the standard enthalpy of reaction $\Delta_r H^\circ$.

308 Some assumptions allow to simplify the differentiation of the expression of the salt enthalpy H_s :

- 309 • The discharged salt S_0 can be assimilated to an indilatable and incompressible solid: $dh_0 = c_{p,0} \cdot dT_r$.
310 Where h_0 is the molar enthalpy of the discharged salt, $c_{p,0}$ the molar thermal capacity of the
311 discharged salt and T_r the temperature of the reactive mixture.
- 312 • The gas can be assimilated to an ideal gas: $dh_g = c_{p,g} \cdot dT_r$. In this equation, h_g is the molar enthalpy
313 of the gas, $c_{p,g}$ the molar thermal capacity of the gas and T_r the temperature of the reactive mixture.
- 314 • The enthalpy of reaction $\Delta_r H^\circ$ is assumed to be constant as a function of temperature and pressure:
315 $d\Delta_r H^\circ = 0$

316 With these assumptions and thanks to equation (14), the differentiation of equation (13) gives the
317 equation (15).

$$dU_s = n_s \cdot [(c_{p,0} + \nu \cdot X \cdot c_{p,g}) \cdot dT_r + \nu \cdot (h_g - \Delta_r H^\circ) \cdot dX] \quad (15)$$

318 In this equation, U_s is the internal energy of the salt, n_s the number of moles of salt, $c_{p,0}$ the molar thermal
319 capacity of the discharged gas, ν the stoichiometric coefficient, X the reaction advancement, $c_{p,g}$ the molar
320 thermal capacity of the gas, h_g the molar enthalpy of the gas and $\Delta_r H^\circ$ the standard enthalpy of the reaction.

321 An additional assumption is made on the thermal mass of the reactive salt which is taken equal to the
 322 average thermal mass of the salt $c_{p,s,av}$ as shown in equation (16).

$$n_s \cdot (c_{p,0} + v \cdot X \cdot c_{p,g}) = n_s \cdot c_{p,s,av} \quad (16)$$

323 By combining equations (12), (15) and (16) and after simplification the balance equation on the reactive
 324 composite is expressed by equation (17).

$$(n_s \cdot c_{p,s,av} + m_{ENG} \cdot c_{p,ENG}) \cdot \frac{dT_r}{dt} = (UA)_{r,int} \cdot (T_{w,r} - T_r) - \dot{n}_r \cdot \Delta_r H^\circ \quad (17)$$

325 This equation reflects the fact that the temperature increases of the reactive composite (term on the left
 326 hand side of the equal sign) is due on the one hand to the heat exchange with the wall (first term on the right
 327 hand side of the equal sign) and, on the other hand, to the quantity of heat absorbed or rejected by the
 328 chemical reaction (second term on the right hand side of the equal sign).

329 To respect the EMR formalism, it is necessary to express the temperature of the reactor as a function of
 330 the two entropy fluxes supplied by the adjacent blocs. Thanks to the previous equation, it is possible to identify
 331 these 2 entropy fluxes: one due to the heat exchange at the wall of the reactor $\dot{S}_{htf}^{T_r}$, the other due to the heat
 332 of by reaction $\dot{S}_r^{T_r}$. These entropy fluxes are expressed by the following equations (18) and (19).

333

$$\dot{S}_r^{T_r} = -\frac{\dot{n}_r \cdot \Delta_r H_r^\circ}{T_r} \quad (18)$$

$$\dot{S}_{htf}^{T_r} = \frac{(UA)_{r,int} \cdot (T_{w,r} - T_r)}{T_r} \quad (19)$$

334 By inserting the equations described by (18) into balance equation (17), the temperature of the reactive
 335 composite is expressed as an integral function of the entropy flows that are the inputs of this bloc.

336 **3.1.5. Mass exchange between the reactive composite and the dead volume**

337 The coupling between the thermal part and the fluidic part is done through a multiphysics coupling block
 338 in which the inputs of the block are used to express the entropy flow $\dot{S}_r^{T_r}$ using equation (18). To express the

339 flow of gas absorbed or released by the reactive composite it is necessary to know the variation of the rate of
340 advancement, and thus to introduce a kinetic law.

341 Several kinetic laws have been proposed in the scientific literature, which are determined either from
342 balances on the reactive composite as in the article by Neveu *et al.* [25] or empirically from experimental
343 observations. This second method has been chosen here because many phenomena influence the kinetic, and
344 it is difficult to account for them by putting them into equations. The chosen kinetic law results from the
345 following considerations: the kinetics of the reaction depends mainly on the deviation from the equilibrium
346 and the current progress of the reaction. Expression (20) from the article by Mazet *et al.* [26] is retained. In
347 this equation X is the reaction advancement, k_{kin} a kinetic coefficient and α an exponent which makes it
348 possible to account for the dependence of the kinetics on the advancement ($\alpha \in [0; 2]$), P_r and T_r the reactor
349 pressure and temperature and $P_{eq}(T_r)$ the equilibrium pressure at the reactor temperature.

$$\frac{dX}{dt} = k_{kin} \cdot X^\alpha \cdot \ln\left(\frac{P_r}{P_{eq}(T_r)}\right) \quad (20)$$

350 This expression is only valid in decomposition. For the synthesis, the term X will be replaced by $(1 - X)$.
351 The equilibrium pressure is calculated with the Clausius-Clapeyron equation (21).

$$P_{eq}(T) = P^\circ \cdot \exp\left(\frac{\Delta_r H^\circ}{R} - \frac{\Delta_r S^\circ}{R \cdot T}\right) \quad (21)$$

352 In this equation $P_{eq}(T)$ is the equilibrium pressure at the considered temperature T , P° is the reference
353 pressure ($P^\circ = 1 \text{ bar}$), $\Delta_r H^\circ$ and $\Delta_r S^\circ$ are respectively the standard enthalpy and entropy of the reaction and
354 R is the universal constant of perfect gases.

355 **3.1.6. Mass accumulation in the dead volume**

356 The amount of gas in the dead volume $\dot{n}_{g,dv}$ can be calculated from a mass balance on the dead volume
357 of the reactor. Indeed, this volume is subject to two flows of gas, on the one hand the one produced or
358 absorbed by the reactive salt \dot{n}_r and, on the other hand, the one which is exchanged with the outside $\dot{n}_r^{in,out}$.
359 The quantity of gas in the dead volume can thus be expressed according to (22).

$$\frac{dn_{g,dv}}{dt} = \dot{n}_r + \dot{n}_r^{in,out} \quad (22)$$

360 The reactor pressure is computed by assuming that the gas behaves like an ideal gas. This approximation
361 is valid here because the gas is far enough from the liquid/vapor equilibrium to avoid the effects of fluid
362 saturation.

363 The reactor model is thus complete and allows to account for its behavior during the decomposition phase
364 as well as the synthesis phase by considering different parameters of the kinetic law for these 2 phases.

365 **3.2. EMR of the other components of the thermochemical system**

366 **3.2.1. EMR of the condenser**

367 It is assumed that the liquid level in the condenser is low and constant which is the case when the
368 condenser is placed directly above the tank and the liquid flows naturally to the tank by gravity. Moreover,
369 the kinetics of the condensation is much higher than the kinetics of the chemical reaction. It is thus possible
370 to consider that the condensation is instantaneous. From these 2 considerations, it is assumed that there is no
371 mass accumulation in the condenser since as soon as gas arrives it is instantly condensed and evacuated
372 towards the liquid tank. Condenser wall has been neglected in this model because of its limited impact.
373 Finally, the only energy accumulation in the condenser model is a thermal accumulation that sets the
374 condensation temperature as a consequence of entropy flows from condensation and heat exchange with the
375 heat transfer fluid. The complete diagram of the condenser model is available in Figure 6.

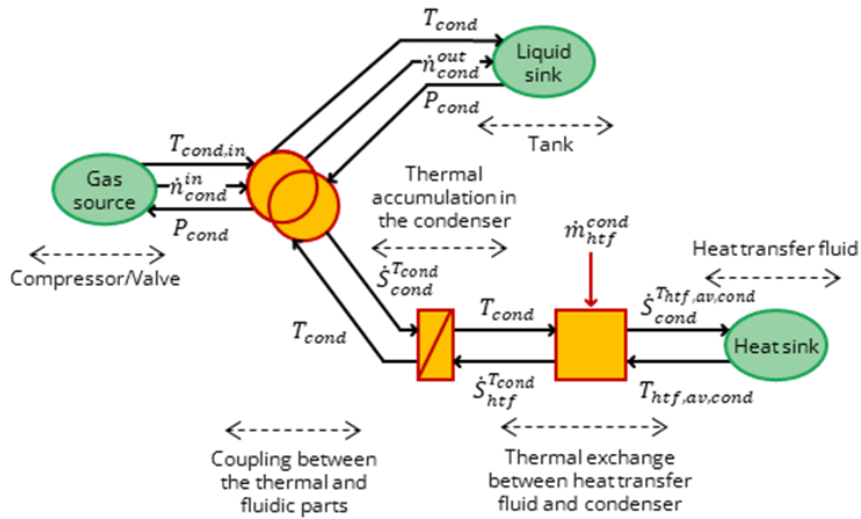

Variables		Subscripts and superscript	
T	Temperature	htf	Heat Transfer Fluid
P	Pressure	av	Average
\dot{n}	Molar flow rate	cond	Condenser
\dot{S}	Entropy flow	w	Wall
\dot{m}	Mass flow rate		

376

377 *Figure 6 : EMR representation of the condenser. The meaning of each variable can be found using the*
 378 *nomenclature.*

379 The coupling block between the thermal and fluidic part is simple because the gas and liquid molar flows
 380 are equal $\dot{n}_{cond}^{in} = \dot{n}_{cond}^{out}$ and the pressure is calculated from the saturation pressure at the condensation
 381 temperature $P_{cond} = P_{sat}(T_{cond})$. In order to calculate the entropy flow related to the production of heat
 382 due to condensation, an energy conservation balance can express the heat flow as shown in the equation (23).
 383 The entropy flux of condensation $\dot{S}_{cond}^{T_{cond}}$ is then deduced in a similar way to what was presented previously in
 384 equation (3).

$$\dot{S}_{cond}^{T_{cond}} = \frac{\Phi_{cond,htf}}{T_{cond}} = \frac{\dot{n}_{cond}^{in} \cdot (h_g(T_{cond,in}) - h_l(T_{cond}))}{T_{cond}} \quad (23)$$

385 In this equation h_g and h_l represents respectively the molar enthalpy of the gas and liquid phases and
 386 T_{cond} refers to the condensation temperature. The calculation of the condensation temperature, carried out
 387 in the accumulation bloc, is done by means of a heat balance on the condenser as shown in equation (24). In

388 this equation n_g is the number of moles of gas, n_l the number of moles of liquid, $c_{v,g}$ and $c_{v,l}$ are respectively
 389 the molar heat capacity at constant volume for the gas and the liquid phases, T_{cond} is the condensation
 390 temperature. $\dot{S}_{cond}^{T_{cond}}$ and $\dot{S}_{htf}^{T_{cond}}$ are respectively the two entropy fluxes due to the condensation of the gas
 391 and the heat exchange with the heat transfer fluid.

$$n_g \cdot c_{v,g}(T_{cond}) + n_l \cdot c_{v,l}(T_{cond}) \cdot \frac{dT_{cond}}{dt} = \left(\dot{S}_{cond}^{T_{cond}} - \dot{S}_{htf}^{T_{cond}} \right) \cdot T_{cond} \quad (24)$$

392

393 For the sake of simplicity, the heat accumulation in the condenser wall is neglected here. To take this into
 394 account, a heat exchange block between the condenser and the wall as well as an accumulation block should
 395 be added but the wall has little impact on the global dynamic of the system because the condenser is small
 396 (0.5 L) and thus its wall mass is low compared to the thermal mass of the reactor.

397 For the heat exchange between the heat transfer fluid and the condenser, the overall heat exchange
 398 coefficient $(UA)_{cond}$ is calculated from a law extracted from the literature allowing to express it as a power
 399 law of the heat transfer fluid flow rate \dot{m}_{htf}^{cond} as shown by equation (25). In the present case and considering
 400 the configuration of the exchanger, an exponent of 0.8 has been chosen. This coefficient must be adjusted
 401 according to the type of flow considered for the heat transfer fluid (laminar or turbulent) as well as according
 402 to the geometry of the exchanger. In this equation, the constant B will be identified from the different
 403 experimental data sets. The heat flux and the corresponding entropy flux are then calculated in the same way
 404 as presented in equations (5) and (3) respectively.

$$(UA)_{cond} = B \cdot (\dot{m}_{htf}^{cond})^{0.8} \quad (25)$$

405

3.2.2. EMR of the evaporator

406 The evaporator modeled here is a flooded type evaporator, i.e., constantly filled with liquid with only a
 407 slight gas overhead to ensure that a liquid/gas mixture remains present. To do this, the evaporator is placed
 408 under a small tank in which the liquid level is kept constant by means of a solenoid valve controlled by a level
 409 sensor. As for the condenser, the assumption of instantaneous evaporation remains valid because the kinetics

410 of evaporation is always much higher than the kinetics of the thermochemical reaction. As for the condenser,
 411 the wall is neglected here. These different considerations lead to consider that there is no mass accumulation
 412 block in the model but only a thermal accumulation block allowing to calculate the evaporation temperature.
 413 The EMR model of the evaporator is depicted in Figure 7.

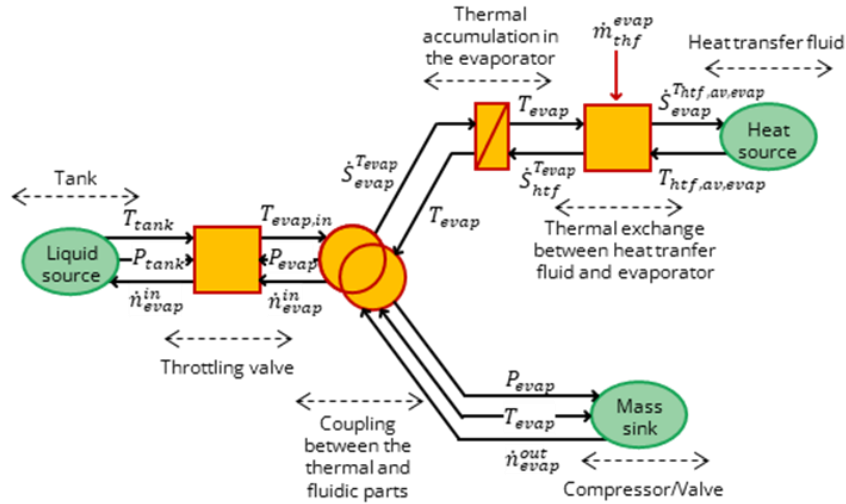

Variables		Subscripts and superscript	
T	Temperature	htf	Heat Transfer Fluid
P	Pressure	av	Average
\dot{n}	Molar flow rate	evap	Evaporator
\dot{S}	Entropy flow	w	Wall
\dot{m}	Mass flow rate		

414

415

Figure 7 : EMR of the evaporator.

416 The first block, on the left in Figure 7, represents the expansion of the liquid through the throttling valve.
 417 The temperature at the inlet of the valve T_{tank} is the temperature of the tank. The computation of the
 418 temperature at the outlet $T_{evap,in}$ is made with the knowledge of the pressure P_{evap} and the enthalpy
 419 $h(P_{tank}, T_{tank})$ because the expansion is supposed to be isenthalpic.

420 The coupling block between the thermal and fluidic part is quite similar to the condenser coupling bloc.
 421 The pressure is calculated by considering the pressure as the saturation pressure at the evaporation

422 temperature, both molar flow of gas and liquid are equal, and the entropy flow is computed thanks to an
 423 energy conservation balance in the evaporator.

424 The calculation of the evaporator temperature, carried out in the accumulation bloc, is done by means of
 425 a heat balance on the evaporator similarly to equation (24) for the condenser.

426 Finally, the thermal exchange between the heat transfer fluid and the evaporator $(UA)_{evap}$ is made with
 427 the identification of the constant parameter C which characterize the overall heat transfer coefficient as
 428 shown by equation (26). In this equation \dot{m}_{htf}^{evap} refers to the mass flow rate of the heat transfer fluid at the
 429 evaporator.

$$(UA)_{evap} = C. (\dot{m}_{htf}^{evap})^{0.8} \quad (26)$$

430 3.2.3. EMR of the mechanical compressor

431 The proposed EMR model is shown in Figure 8. The compressor is located between 3 sources or sinks, one
 432 gas sources at its inlet, one gas sink at its outlet and a mechanical energy source to drive it in rotation.

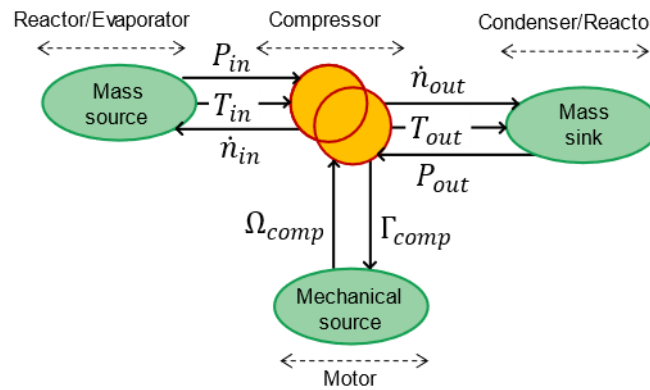

Variables		Subscripts and superscript	
T	Temperature	comp	Compressor
P	Pressure		
\dot{n}	Molar flow rate		
Ω	Rotation speed		
Γ	Torque		

433
 434 *Figure 8 : EMR of the compressor.*

435 The molar flow rate entering the compressor \dot{n}_{in} depends on the volumetric efficiency of the compressor
 436 η_v , the swept volume per second \dot{V}_b and the molar volume of the gas at the inlet of the compressor
 437 $v_m(T_{in}, P_{in})$ as shown in equation (27).

$$\dot{n}_{in} = \frac{\eta_v \cdot \dot{V}_b}{v_m(T_{in}, P_{in})} \quad (27)$$

438 The volumetric efficiency can be estimated from the knowledge of the adiabatic coefficient of the gas
 439 under consideration γ and the ratio of dead volume V_{dv} to swept volume V_b expressed as $\varepsilon_{comp} = V_{dv}/V_b$ as
 440 written by equation (28). In this equation P_{in} and P_{out} refers respectively to the inlet and outlet pressure of
 441 the compressor.

$$\eta_v = 1 - \varepsilon_{comp} \cdot \left(\left(\frac{P_{out}}{P_{in}} \right)^{\frac{1}{\gamma}} - 1 \right) \quad (28)$$

442 The volume swept each second can be expressed by equation (29). This is a function of the compressor
 443 speed Ω_{comp} , the volume of a cylinder V_{cyl} and the number of chambers of compression N_c .

$$\dot{V}_b = \frac{1}{2 \cdot \pi} \cdot V_{cyl} \cdot N_c \cdot \Omega_{comp} \quad (29)$$

444 Finally, the molar flow rate of gas drawn in by the compressor \dot{n}_{in} can be obtained by equation (30).

$$\dot{n}_{in} = \left[1 - \varepsilon_{comp} \cdot \left(\left(\frac{P_{out}}{P_{in}} \right)^{\frac{1}{\gamma}} - 1 \right) \right] \cdot \frac{1}{2 \cdot \pi} \cdot V_{cyl} \cdot N_{cyl} \cdot \Omega_{comp} \cdot \frac{1}{v_m(T_{in}, P_{in})} \quad (30)$$

445 The outlet temperature can be estimated using the isentropic efficiency η_{is} of the compressor as shown
 446 in equation (31). The isentropic efficiency will be considered constant as a first approximation. Knowing the
 447 enthalpy and the discharge pressure it is thus possible to estimate the discharge temperature using
 448 thermodynamic relations or tabulated values. In this equation h_{out}^{is} is the molar enthalpy of the gas at the
 449 outlet of the compressor considering an isentropic compression, h_{in} is the molar enthalpy of the gas at the
 450 inlet and h_{out} the real molar enthalpy of the gas at the outlet of the compressor.

$$\eta_{is} = \frac{h_{out}^{is} - h_{in}}{h_{out} - h_{in}} \quad (31)$$

451 In order to calculate the driving torque of the compressor Γ_{comp} , an energy conservation balance on the
 452 compressor shaft is performed as shown in equation (32) using the rotation speed of the compressor Ω_{comp} ,
 453 the molar flow rate of the gas \dot{n}_g and the molar enthalpy of the gas at the inlet h_{in} and outlet h_{out} .

$$\Gamma_{comp} \cdot \Omega_{comp} = \dot{n}_g \cdot (h_{out} - h_{in}) \quad (32)$$

454 3.2.4. Valve

455 The equations for calculating the flow through a valve depend on the flow regime. In the case of an
 456 expansion ratio greater than 2, we will consider that the flow is supersonic and that the flow rate is only a
 457 function of the upstream characteristics. Otherwise, the pressure difference ΔP between upstream P_{in} and
 458 downstream P_{out} must be considered in order to calculate the flow rate q_v . The two equations allowing to
 459 estimate the flow are given by equation (33) and (34). In this equation G_g is the specific density of the
 460 considered gas, C_v is the heat capacity at constant volume and N is a coefficient whose value depends on the
 461 units considered for the different quantities. With P in bar, q_v in std L/min and T in K, N is taken at 6950.

$$Subsonic \left(\frac{P_{in}}{P_{out}} < 2 \right): \quad q_v = N \cdot C_v \cdot P_{in} \cdot \left(1 - \frac{2 \cdot \Delta P}{3 \cdot P_{in}} \right) \cdot \sqrt{\frac{\Delta P}{P_{in} \cdot G_g \cdot T_{in}}} \quad (33)$$

$$Supersonic \left(\frac{P_{in}}{P_{out}} > 2 \right): \quad q_v = 0.471 \cdot N \cdot C_v \cdot P_{in} \cdot \sqrt{\frac{1}{G_g \cdot T_{in}}} \quad (34)$$

462 3.3. EMR model for the whole hybrid thermochemical system

463 All the components of a thermochemical system have been modeled and implemented into *Simulink*. For
 464 the complete model of the hybrid thermochemical system, several flow distribution blocs have been designed
 465 for this purpose. These blocks allow to redirect the flows according to the considered phase (decomposition
 466 or synthesis) or to the use or not of a compressor. It can be noticed in this model, depicted on Figure 9, that
 467 two compressors are used but, in the real system, the same compressor could drive both decomposition and
 468 synthesis phase. This artifice allows to clarify the modeling of the complete system. This global model has 4

469 energy sources or sinks: 3 heat sources/sinks for the different heat transfer fluids (related to the reactor,
470 condenser and evaporator) and one mechanical source to drive the compressor.

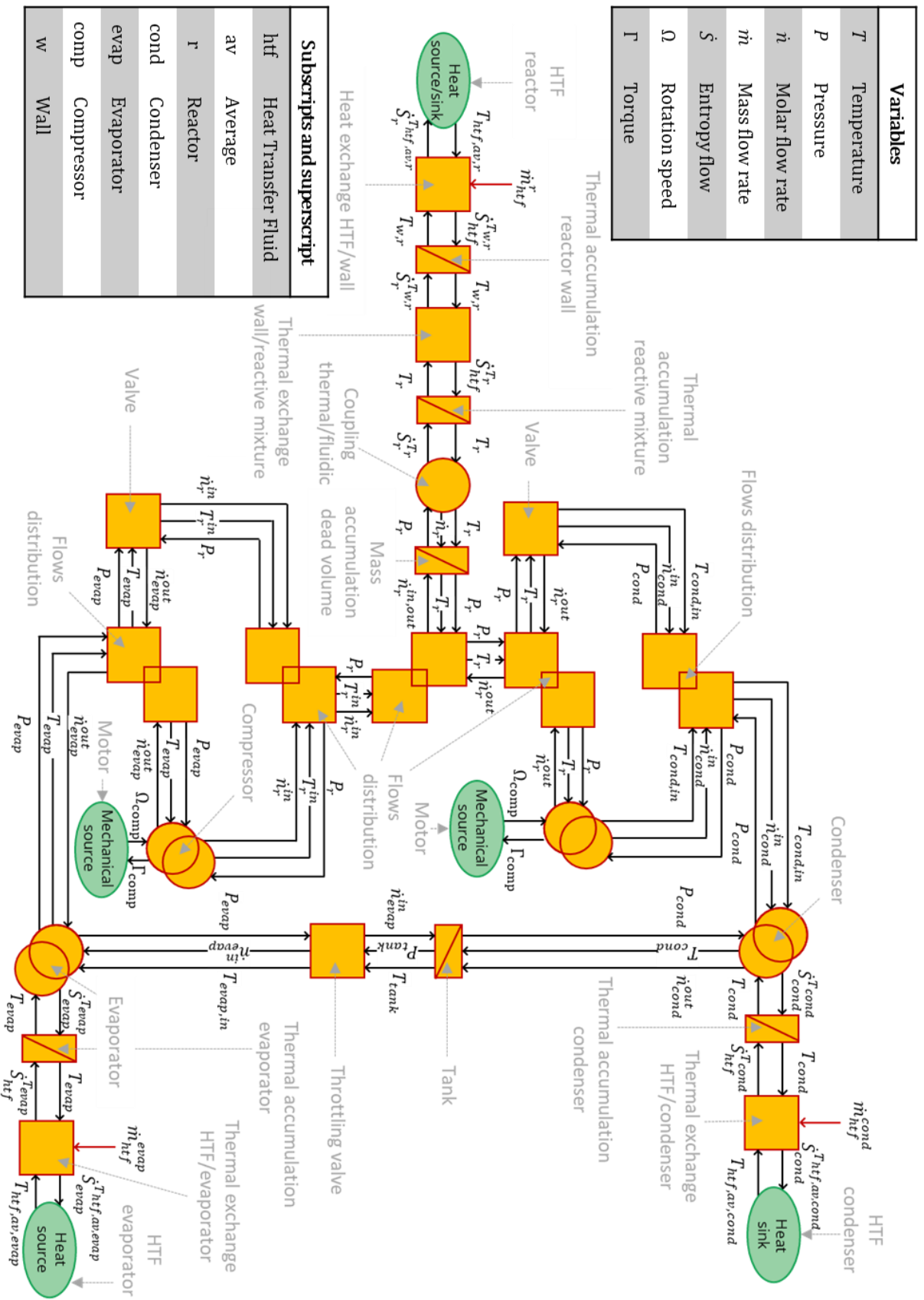

Figure 9 : EMR of the entire hybrid thermochemical system.

473 4. Experimentation and model validation

474 The prototype used to validate the model use the $\text{BaCl}_2(8/0)$ salt which react with ammonia. This system
475 is described in [19] and has been modified to be able to test the compressor-assisted synthesis phase, one
476 dataset for each of the 4 phases was used to identify the model calibration parameters.

477 A system identification is made through a whitebox testing with a Particle Swarm Optimization (PSO)
478 algorithm to tune the calibration parameters of the model to fit the experimental observations. The operation
479 of this algorithm is described by Eberhart and Kennedy [27]. This algorithm is based on the generation of a
480 particle swarm for which the position of each particle represents a possible solution to the optimization
481 problem. The particles are then iteratively moved in the solution space to ensure a convergence towards a
482 suitable solution to the optimization problem. This type of algorithm does not ensure to obtain the optimal
483 solution in the mathematical sense of the term but an approximate solution which remains largely acceptable
484 for this optimization problem. To estimate the degree of correlation between the model and the experimental
485 observations the root mean square error (RMSE), defined by equation (35) is used. This indicator expresses
486 the average distance between the experimental points and those obtained by simulation under the same
487 operating conditions. In this equation, Val represents the value of the considered parameter either for the
488 simulation Val^{sim} or for the experimentation Val^{exp} , n represents the different timesteps and N_f the total
489 number of timesteps.

$$RMSE = \sqrt{\frac{\sum_{n=0}^{N_f} (Val^{sim}(n) - Val^{exp}(n))^2}{N_f}} \quad (35)$$

490 Three representative variables of the thermochemical process operation are selected:

- 491 • the pressure in the reactor P_r
- 492 • the advancement of the reaction X
- 493 • the condensation pressure P_{cond} or the evaporation pressure P_{evap} depending on the
494 operating phase considered.

495 The score of a particle for a given experiment is thus calculated as the sum of the RMSE for each of these
 496 3 variables.

497 4.1. Model parameters

498 The input data for the modeling are the design parameters of the prototype (Table 2) and the operating
 499 conditions of the corresponding experiment:

- 500 • The temperatures of the heat transfer fluids at the reactor, condenser, and evaporator.
- 501 • The mass flow rates of the 3 heat transfer fluids.
- 502 • The rotation speed of the compressor when it is used.

503

504 *Table 2 : Design parameter of the prototype used as input data of the model.*

505 * *These data come from values collected and computed by Touzain [28] and from CNRS-PROMES knowledge.*

506 ** *Typical value of the average isentropic efficiency of a reciprocating compressor considering the operating
 507 condition of this study.*

	Parameter	Values
Reactor	Number of moles of salt n_s [8]	64.9 mol
	ENG mass m_{ENG} [29]	2.21 kg
	Wall of the tube reactor mass $m_{w,r}$ [29]	25.7 kg
	Thermal capacity of the salt $c_{p,s,av}$ *	76.8 J.mol ⁻¹ .K ⁻¹
	Thermal capacity of the ENG $c_{p,ENG}$	800 J.kg ⁻¹ .K ⁻¹
	Thermal capacity of the tube reactor wall $c_{p,w,r}$	502 J.kg ⁻¹ .K ⁻¹
	Standard enthalpy of reaction $\Delta_r H^\circ$ *	38 248 J.mol ⁻¹ .K ⁻¹
	Standard entropy of reaction $\Delta_r S^\circ$ *	232.4 J.mol ⁻¹
Compressor	Isentropic efficiency η_{is} **	0.7
	Volume of the compression chamber V_{cyl} [30]	0.345 L
	Number of cylinders N_{cyl} [30]	2

Condenser	Condenser volume V_{cond} [30]	0.5 L
	Volume fraction of liquid $\gamma_{liq,cond}$	1 %
	Exchange area S_{cond} [30]	0.35 m ²
Evaporator	Evaporator volume V_{evap} [30]	0.5 L
	Volume fraction of liquid $\gamma_{liq,evap}$	99 %
	Exchange area S_{evap} [30]	0.35 m ²

508 However, some parameters remain unknown or are simply difficult to estimate, such as kinetic
509 coefficients, heat exchange coefficients or characteristics impacting the compressor operation. This set of
510 unknown parameters constitute the calibration parameters of the model. A total of 9 parameters are used:

- 511 • 4 parameters for the kinetic relations. For each phase (decomposition and synthesis), 2 kinetic
512 coefficients are needed: k_{kin} and n as stated in equation (20).
- 513 • 4 parameters for the overall heat transfer coefficient, as used in equations (6), (8), (25) and (26).
- 514 • 1 parameter for the ratio between the dead volume and the swept volume of the compressor, as
515 characterized by equation (28).

516 By means of an optimization over the 4 operating phases, the values summarized in Table 3 are obtained
517 for each of the calibration variables.

518 *Table 3 : Identified values for the model calibration parameters.*

Calibration variables	Nomenclature	Value
Kinetic decomposition coefficient	$k_{cin,dec}$	$1.10^{-3} s^{-1}$
Kinetic decomposition exponent	α_{dec}	1.7 [–]
Kinetic synthesis coefficient	$k_{cin,synt}$	$1.10^{-3} s^{-1}$
Kinetic synthesis exponent	α_{synt}	0.3 [–]
Overall heat transfer coefficient salt/wall	$(UA)_{reac,int}$	$524 W \cdot K^{-1}$
Overall heat transfer constant htf/wall	A	$2500 [W \cdot K^{-1} \cdot kg^{-0.6} \cdot s^{0.6}]$
Overall heat transfer constant condenser	B	$2500 [W \cdot K^{-1} \cdot kg^{-0.8} \cdot s^{0.8}]$
Overall heat transfer constant evaporator	C	$2800 [W \cdot K^{-1} \cdot kg^{-0.8} \cdot s^{0.8}]$
Dead volume to swept volume ratio compressor	ε_{comp}	0.2 [–]

519

520 4.2. Comparison between numerical and experimental results

521 The results of the modeling of the prototype according to the 4 phases of operation are presented on
 522 Figure 10. The results concerning the validation of the model are presented as a distribution of the
 523 experimental and simulated data. The solid line represents a hypothetical model that should perfectly match
 524 the experimental observations. The pressure differences between the EMR model and the experiments are
 525 always lower than 1 bar, the advancement is accurately estimated because the error is never higher than 0.1
 526 and the reactor wall temperature is never estimated with an error greater than 2 °C.

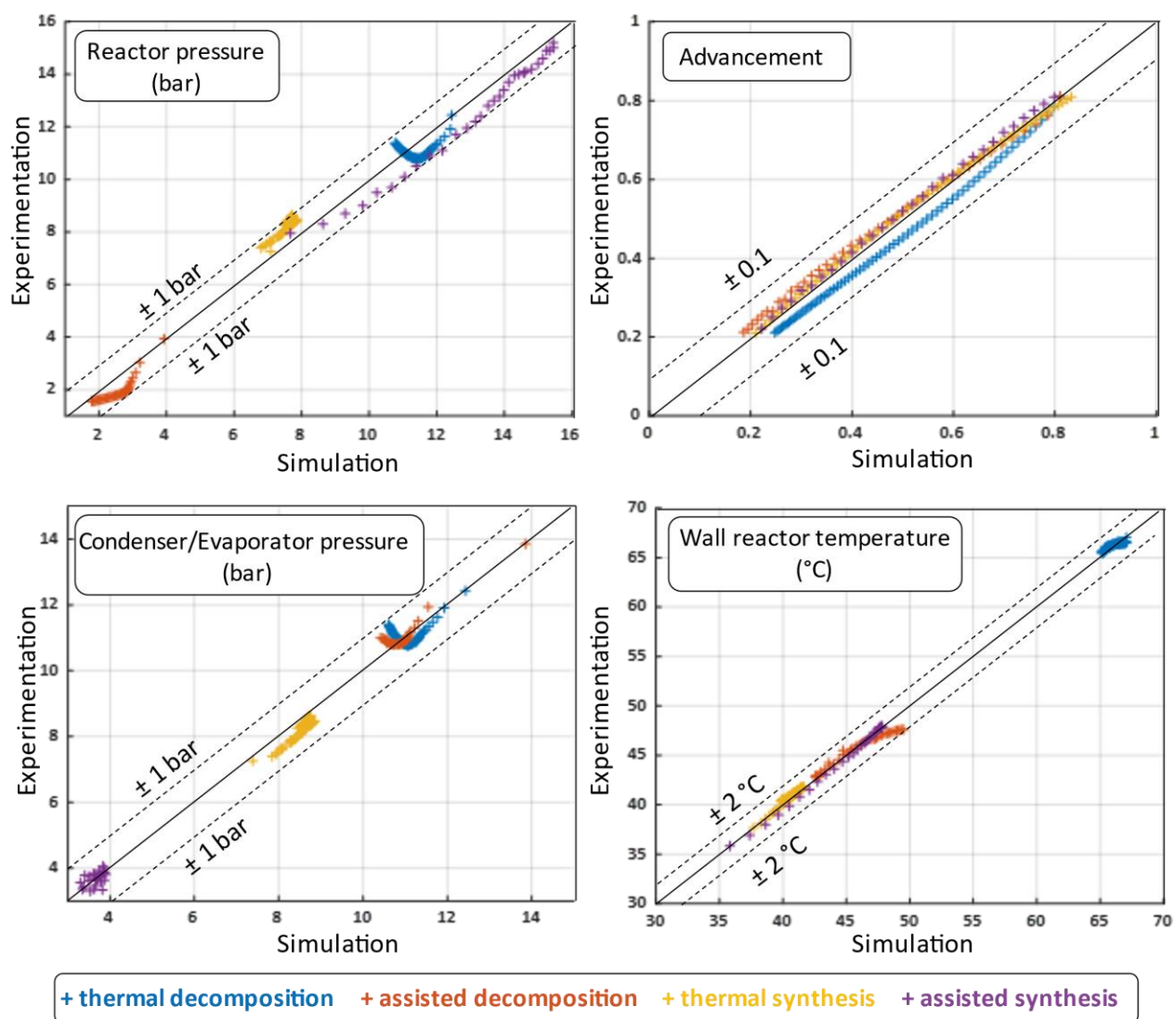

527

528 *Figure 10 : Distributions of experimental and simulated results for reactor, condenser and evaporator*

529 *pressure, feed rate and reactor wall temperature.*

545 door as well as the introduction of food in the cold room. The whole calculation is detailed in [8]. The curve
546 representing the heat loads of the cold room during a day is shown in Figure 12.

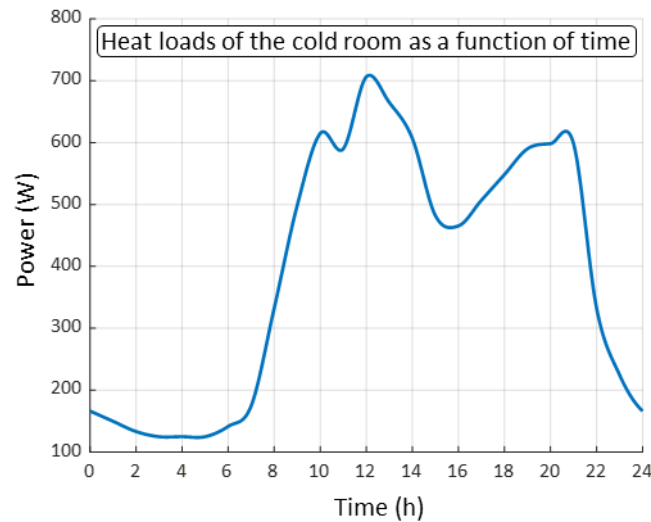

547

548

Figure 12 : Heat loads from the cold room on a typical day.

549 As stated before, a model inversion must be performed to obtain a control structure allowing to drive the
550 compressor to control and regulate the temperature of the cold room. This inversion can be seen as an
551 inversion of the physical functionality of the system. A causal relationship, also often called control chain for
552 this type of modeling, correspond to a series of parameters to be set to go from the control variable
553 (compressor speed) to the variable to be controlled (cold room temperature). This relation must be defined
554 from the model in function of the control the user wants to apply. This causal relationship is then inverted to
555 obtain a command chain to determine the control law of the compressor speed versus the cold room
556 temperature. This methodology allows us to identify the blocks that need to be inverted as well as the
557 variables to be controlled. These two chains, as well as the EMR model and its inversion are presented in Figure
558 13.

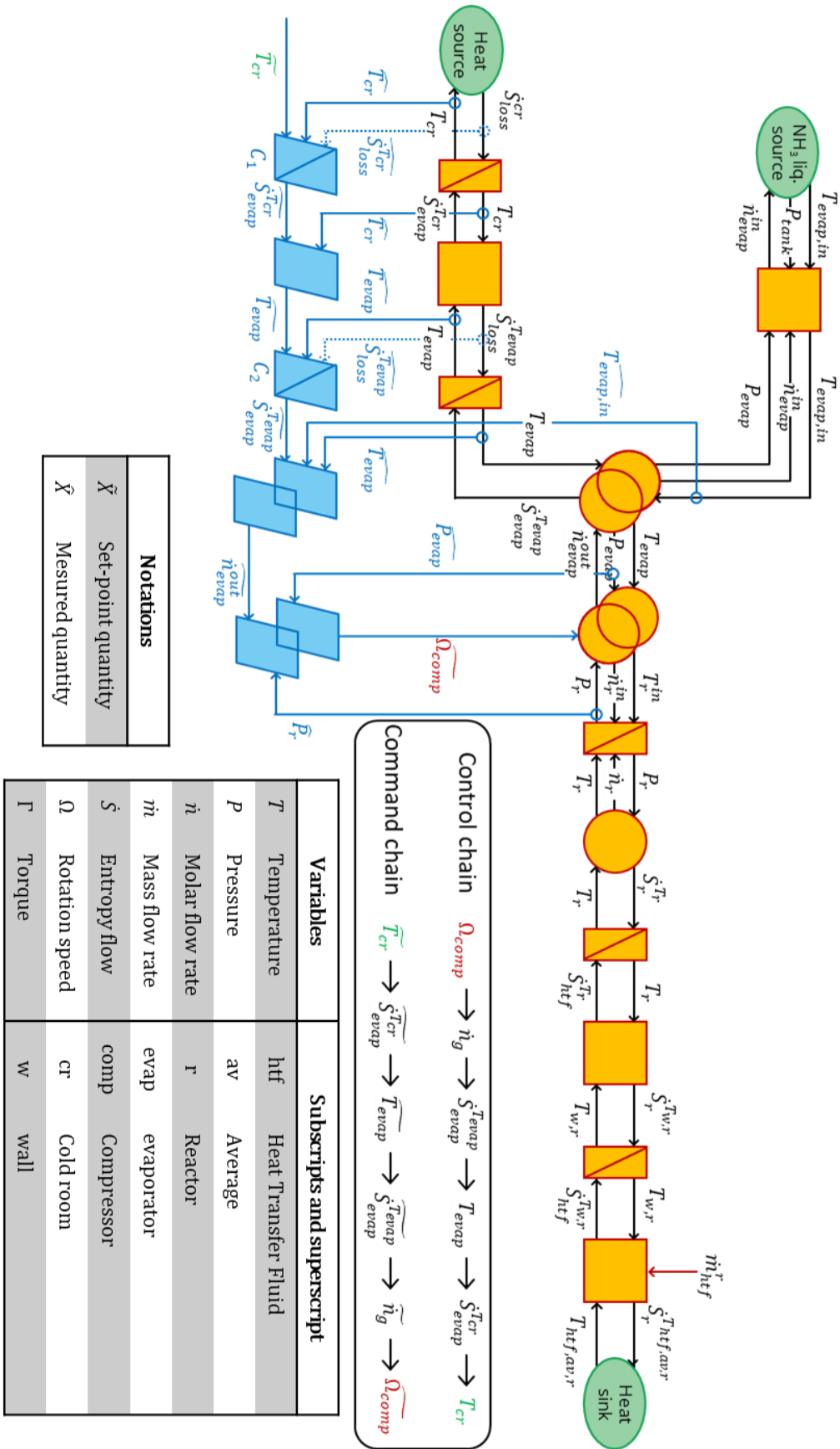

Figure 13 : EMR model of the control process and inversion of the causal relationship.

561 In Figure 13, the "tilde" notations refer to set-point quantities that are found in the chain of causal
562 relations, while the "circumflex" notations refer to measured quantities. The control structure obtained by
563 inversion of the EMR model is called the maximum control structure. This structure can then be simplified to
564 reduce the number of measurements to be performed on the system. This step is not detailed here because
565 the objective is not to actually implement the control strategy obtained. However, the dotted lines in Figure
566 13 refer to the quantities that should be removed because they are difficult to measure. To do this, a more
567 robust PI type corrector could be used to eliminate the need to measure these quantities.

568 The method used for the inversion of each block is described by Walter *et al.* [9]. Three types of blocks are
569 involved in the causal relationship: two accumulation blocks, a monophysical coupling block and two
570 multiphysical conversion blocks. The inversion reveals two correctors that need to be adjusted.

571 As the control loops are nested, it is essential that the time constants, chosen from the parameters of the
572 correctors, are consistent with each other so that the internal loop is faster than the external loop. To simplify
573 the adjustment, the correctors used proportional type. Their respective gains were manually adjusted to
574 obtain an internal control loop whose response time is about 10 times less than the external loop. For this
575 reason, the gain of the C1 corrector is equal to 1 and that of C2 to 10.

576 To facilitate the understanding of the control strategy of the system, Figure 14 represents the regulation
577 in a more conventional way by means of a block diagram.

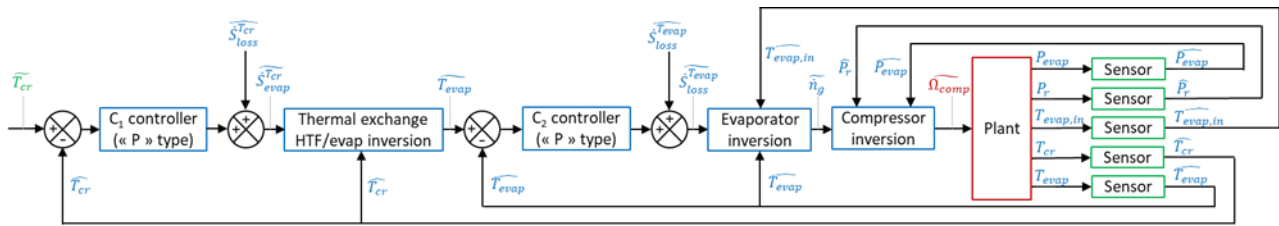

Variables		Subscripts and superscript		Notations	
T	Temperature	htf	Heat Transfer Fluid	\tilde{X}	Set-point quantity
P	Pressure	av	Average	\hat{X}	Mesured quantity
\dot{n}	Molar flow rate	r	Reactor		
\dot{m}	Mass flow rate	evap	evaporator		
\dot{S}	Entropy flow	comp	Compressor		
Ω	Rotation speed	cr	Cold room		
Γ	Torque	w	wall		

578

579

Figure 14 : Block diagram representation of the control structure.

580

581

582

583

The geometrical and thermodynamic parameters considered are those of the prototype described earlier except for the number of reactive tubes which has been increased to 21 instead of 7. The exchange surfaces, the mass of the walls, the reactive composite and the dead volume have been modified accordingly. The ambient temperature is considered constant and equal to 25 °C.

584

585

586

587

588

589

590

591

592

The results obtained are described in Figure 15. It can be seen that the objective is reached, the temperature of the cold room can be maintained at -18 °C for 24 hours by adapting the rotation speed of the compressor. We also see that the choice to use 21 reactive tubes instead of 7 is justified because the synthesis reaction is complete at the end of the day ($X \simeq 1$). Nevertheless, we notice that the compressor, although it is one of the smallest powers available on the market, is here oversized compared to the refrigeration load of the cold chamber: its rotation speed is too low to ensure a correct lubrication of it. It would therefore be necessary to make it rotate at a higher speed which is suitable for the compressor (about 35% of its nominal speed, as recommended by the manufacturer) and to use a by-pass to reinject part of the compressed vapors from the discharge to the suction. Note that this type of capacity modulation is not very energy efficient.

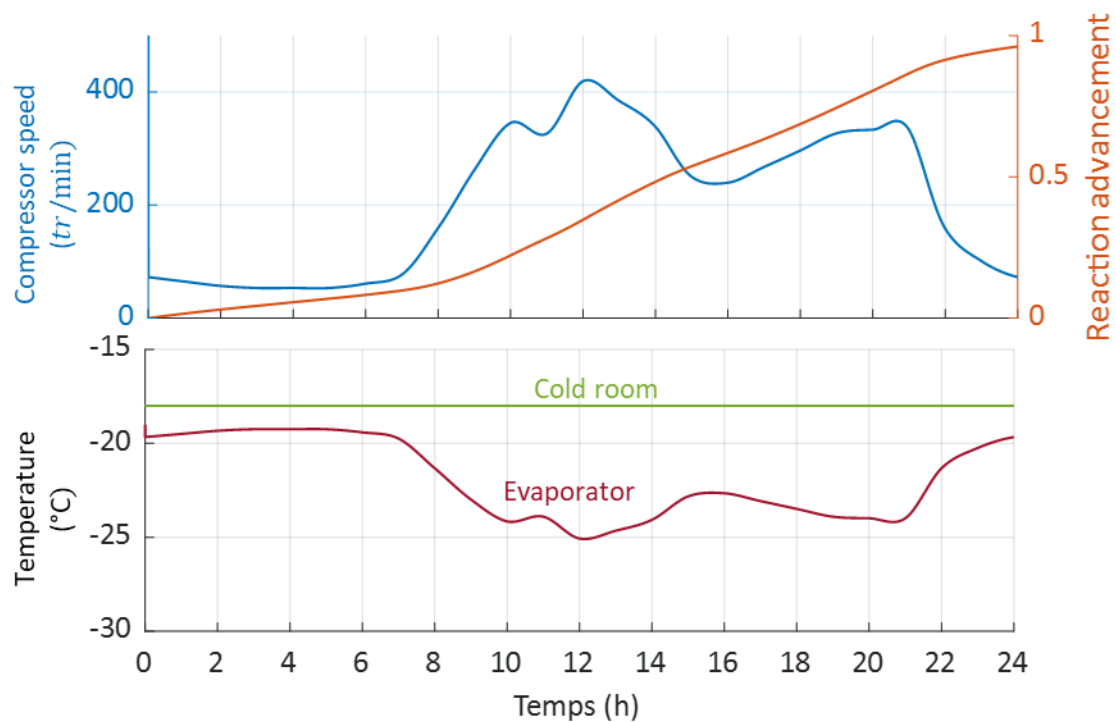

593

594 *Figure 15 : Results for cold room temperature regulation based on compressor speed control.*

595 **6. Conclusion**

596 The compression-assisted hybrid thermochemical cooler studied in this article make it possible to use heat
 597 sources at lower temperatures or to produce cold at lower temperatures than conventional thermochemical
 598 cooler. In addition, the presence of a variable-speed mechanical compressor in the process provides an extra
 599 degree of freedom for process control. The study described in this article proposes a methodology to defined
 600 control structures for these innovative thermochemical processes. This investigation allows to bring
 601 thermochemical systems closer to an industrial development which would allow this type of system to find its
 602 place in the energy transition.

603 The contributions and main conclusions of this study are as follows:

604 - development of models of thermodynamic machine components (thermochemical reactor, compressor,
605 evaporator, condenser, expansion valve) in the EMR formalism. These component models could be used in
606 the future to model other thermodynamic machines using the EMR formalism.

607 - development of a complete model of a mechanical compression-assisted thermochemical process with
608 the EMR formalism. The unknown parameters of this model have been identified thanks to a PSO algorithm
609 and the model has been validated by comparison with experimental data obtained from a highly instrumented
610 prototype. Deviation between numerical and experimental data are lower than 1 *bar* for the reactor,
611 condenser and evaporator pressure, lower than 0.1 for the reaction advancement and lower than 2 °C for the
612 reactor wall temperature. This validated model can easily be used to study couplings between thermochemical
613 refrigerators and processes previously modeled with the EMR formalism (e.g. electrolyzer, fuel cell...).

614 - the inversion of the process model has enabled to establish a process control law. An application is
615 described to show how the compressor speed can be set to maintain a cold room at –18 °C despite significant
616 load variations (from 120 *W* to 700 *W*). Simulations showed that compressor speed control enabled the cold
617 room temperature to be maintained with a maximum difference of 1 °C from the set temperature.

618 - the inversion method of the EMR model could be used to implement control chain of the coupling
619 between thermochemical refrigerators and processes previously modeled with the EMR formalism (e.g.
620 electrolyzer, fuel cell...).

621

622 **Acknowledgments**

623 This work was supported by the French National Research Agency (ANR) in the framework of the RECIF
624 project under contract ANR-18-CE05-0043 (<https://anr.fr/Projet-ANR-18-CE05-0043>). These studies have
625 been conducted within the PROMES laboratory which the authors would like to thank too. The prototype used
626 for the validation of the model has been developed at the University of French Polynesia.

627 **7. Bibliography**

- 628 [1] C. Forman, I. K. Muritala, R. Pardemann, and B. Meyer, "Estimating the global waste heat potential,"
629 *Renew. Sustain. Energy Rev.*, vol. 57, pp. 1568–1579, 2016, doi: 10.1016/j.rser.2015.12.192.
- 630 [2] L. Jiang, R. Q. Wang, X. Tao, and A. P. Roskilly, "A hybrid resorption-compression heat transformer for
631 energy storage and upgrade with a large temperature lift," *Appl. Energy*, vol. 280, p. 115910, 2020, doi:
632 10.1016/j.apenergy.2020.115910.
- 633 [3] L. Jiang, S. Li, R. Q. Wang, Y. B. Fan, X. J. Zhang, and A. P. Roskilly, "Performance analysis on a hybrid
634 compression-assisted sorption thermal battery for seasonal heat storage in severe cold region," *Renew.*
635 *Energy*, vol. 180, pp. 398–409, 2021, doi: 10.1016/j.renene.2021.08.101.
- 636 [4] K. S. Babu and E. A. Kumar, "Thermodynamic analysis of compressor operated resorption
637 thermochemical energy storage system for heat storage , combined cooling and heat upgradation," *J.*
638 *Energy Storage*, vol. 50, p. 104659, 2022, doi: 10.1016/j.est.2022.104659.
- 639 [5] G. Zisopoulos, A. Nesiadis, K. Atsonios, N. Nikolopoulos, D. Stitou, and A. Coca-Ortegón, "Conceptual
640 design and dynamic simulation of an integrated solar driven thermal system with thermochemical
641 energy storage for heating and cooling," *J. Energy Storage*, vol. 41, 2021, doi:
642 10.1016/j.est.2021.102870.
- 643 [6] P. Gao, L. W. Wang, and F. Q. Zhu, "Vapor-compression refrigeration system coupled with a
644 thermochemical resorption energy storage unit for a refrigerated truck," *Appl. Energy*, vol. 290, p.
645 116756, 2021, doi: 10.1016/j.apenergy.2021.116756.
- 646 [7] P. Gao, X. Wei, L. Wang, and F. Zhu, "Compression-assisted decomposition thermochemical sorption
647 energy storage system for deep engine exhaust waste heat recovery," *Energy*, vol. 244, p. 123215,
648 2022, doi: 10.1016/j.energy.2022.123215.
- 649 [8] A. Perrigot, "Cycles hybrides thermochimiques à compression. Application aux micro-réseaux

- 650 autonomes de cogénération électricité/froid.," Université de Perpignan Via Domitia, 2022.
- 651 [9] L. Walter, D. Philippe, B. Alain, and B. Philippe, "La REM, formalisme multiphysique de commande de
652 systèmes énergétiques," *Tech. l'ingénieur Outil. d'analyse en électronique puissance métrologie*, vol.
653 base docum, no. ref. article : d3066, 2014, [Online]. Available: [https://www.techniques-
654 ingenieur.fr/base-documentaire/energies-th4/outils-d-analyse-en-electronique-de-puissance-et-
655 metrologie-42278210/la-rem-formalisme-multiphysique-de-commande-de-systemes-energetiques-
656 d3066/](https://www.techniques-ingenieur.fr/base-documentaire/energies-th4/outils-d-analyse-en-electronique-de-puissance-et-metrologie-42278210/la-rem-formalisme-multiphysique-de-commande-de-systemes-energetiques-d3066/)
- 657 [10] K. S. Agbli, D. Hissel, M. C. Péra, and I. Doumbia, "Energetic Macroscopic Representation (EMR): New
658 approach for multiphysics energetic flows modelling," *IFAC Proc. Vol.*, vol. 8, pp. 723–728, 2012, doi:
659 10.3182/20120902-4-fr-2032.00126.
- 660 [11] W. Lhomme, A. Bouscayrol, and P. Barrade, "Simulation of a series hybrid electric vehicle based on
661 energetic macroscopic representation," *IEEE Int. Symp. Ind. Electron.*, vol. 2, pp. 1525–1530, 2004, doi:
662 10.1109/ISIE.2004.1572040.
- 663 [12] P. Delarue, A. Bouscayrol, A. Tounzi, and X. Guillaud, "Modelling , control and simulation of an overall
664 wind energy conversion system," *Renew. Energy*, vol. 28, pp. 1169–1185, 2003, doi: 10.1016/S0960-
665 1481(02)00221-5.
- 666 [13] J. C. Mercieca, J. N. Verhille, and A. Bouscayrol, "Energetic Macroscopic Representation of a Subway
667 Traction System for a Simulation Model," *IEEE Int. Symp. Ind. Electron.*, vol. 2, pp. 1519–1524, 2004.
- 668 [14] L. Horrein, A. Bouscayrol, Y. Cheng, and M. El Fassi, "Dynamical and quasi-static multi-physical models
669 of a diesel internal combustion engine using Energetic Macroscopic Representation," *Energy Convers.
670 Manag.*, vol. 91, pp. 280–291, 2015, doi: 10.1016/j.enconman.2014.12.022.
- 671 [15] C. Gay, F. Lanzetta, D. Hissel, and M. Feidt, "Représentation Énergétique Macroscopique (REM) d'un
672 moteur Stirling en vue d'une hybridation thermique," *Société Française Therm.*, no. November 2014,
673 pp. 1–6.

- 674 [16] K. S. Agbli, M. Pera, D. Hissel, O. Rallières, C. Turpin, and I. Doumbia, "Multiphysics simulation of a PEM
675 electrolyser : Energetic Macroscopic Representation approach," *Int. J. Hydrogen Energy*, vol. 6, pp.
676 1382–1398, 2011, doi: 10.1016/j.ijhydene.2010.10.069.
- 677 [17] D. Chrenko and P. Marie-Cécile, "Energetic Macroscopic Representation Modeling and Control of a Low
678 Temperature Fuel Cell System Fed by Hydrocarbons," 2008, [Online]. Available: [https://tel.archives-
679 ouvertes.fr/tel-00358312](https://tel.archives-ouvertes.fr/tel-00358312)
- 680 [18] P. Neveu, "Diagrammes thermodynamiques relatif aux équilibres solide/gaz." 1996.
- 681 [19] F. Ferrucci, D. Stitou, P. Ortega, and F. Lucas, "Mechanical compressor-driven thermochemical storage
682 for cooling applications in tropical insular regions. Concept and efficiency analysis," *Appl. Energy*, vol.
683 219, pp. 240–255, 2018, doi: 10.1016/j.apenergy.2018.03.049.
- 684 [20] J. Fitó, A. Coronas, S. Mauran, N. Mazet, M. Perier-Muzet, and D. Stitou, "Hybrid system combining
685 mechanical compression and thermochemical storage of ammonia vapor for cold production," *Energy
686 Convers. Manag.*, vol. 180, pp. 709–723, 2019, doi: 10.1016/j.enconman.2018.11.019.
- 687 [21] A. Perrigot, M. Perier-muzet, P. Ortega, and D. Stitou, "Thermodynamic performance ' s analysis of a
688 cold production by hybrid compressor-based thermochemical sorption processes using ammoniated
689 salts," *Energy Convers. Manag.*, vol. 267, 2022.
- 690 [22] H. B. Lu, N. Mazet, and B. Spinner, "Modelling of gas-solid reaction - Coupling of heat and mass transfer
691 with chemical reaction," *Chem. Eng. Sci.*, vol. 51, no. 15, pp. 3829–3845, 1996, doi: 10.1016/0009-
692 2509(96)00010-3.
- 693 [23] L. Hui-Bo, N. Mazet, O. Coudeville, and S. Mauran, "Comparison of a general model with a simplified
694 approach for the transformation of solid-gas media used in chemical heat transformers," *Chem. Eng.
695 Sci.*, vol. 52, no. 2, pp. 311–327, 1997, doi: 10.1016/S0009-2509(96)00407-1.
- 696 [24] D. Stitou, V. Goetz, and B. Spinner, "A new analytical model for solid-gas thermochemical reactors
697 based on thermophysical properties of the reactive medium," *Chem. Eng. Process. Process Intensif.*,

- 698 vol. 36, no. 1, pp. 29–43, 1997, doi: 10.1016/S0255-2701(96)04173-6.
- 699 [25] P. Neveu and J. Castaing-Lasvignottes, “Development of a numerical sizing tool for a solid-gas
700 thermochemical process,” *Appl. Therm. Eng.*, vol. 17, no. 6, pp. 501–518, 1997.
- 701 [26] N. Mazet, M. Amouroux, and B. Spinner, “Analysis and experimental study of the transformation of a
702 non-isothermal solid/gas reacting medium,” *Chem. Eng. Commun.*, vol. 99, no. 1, pp. 155–174, 1991,
703 doi: 10.1080/00986449108911585.
- 704 [27] J. Kennedy and R. Eberhart, “Particle swarm optimization,” in *Proceedings of ICNN’95 - International
705 Conference on Neural Networks*, IEEE, 1995, pp. 1942–1948. doi: 10.1109/ICNN.1995.488968.
- 706 [28] P. Touzain, “Thermodynamic values of ammonia-salts reactions for chemical sorption heat pumps.,” in
707 *Proceedings of the international sorption heat pump conference, Munich, Germany. 1999*, 1999.
- 708 [29] N. Le Pierres, “Procédé solaire de production de froid basse température (-28 ° C) par sorption solide-
709 gaz Nolwenn Le Pierrès To cite this version : HAL Id : tel-00011253,” 2005.
- 710 [30] F. Ferrucci, “PV-driven vapor compression cycle integrating a solid-gas thermochemical storage for
711 cooling applications,” 2020.

712