



HAL
open science

Roadmap on ferroelectric hafnia- and zirconia-based materials and devices

José Silva, Ruben Alcalá, Uygur Avci, Nick Barrett, Laura Bégon-Lours, Mattias Borg, Seungyong Byun, Sou-Chi Chang, Sang-Wook Cheong, Duk-Hyun Choe, et al.

► **To cite this version:**

José Silva, Ruben Alcalá, Uygur Avci, Nick Barrett, Laura Bégon-Lours, et al.. Roadmap on ferroelectric hafnia- and zirconia-based materials and devices. *APL Materials*, 2023, 11 (8), pp.089201. 10.1063/5.0148068 . hal-04191448

HAL Id: hal-04191448

<https://hal.science/hal-04191448>

Submitted on 31 Aug 2023

HAL is a multi-disciplinary open access archive for the deposit and dissemination of scientific research documents, whether they are published or not. The documents may come from teaching and research institutions in France or abroad, or from public or private research centers.

L'archive ouverte pluridisciplinaire **HAL**, est destinée au dépôt et à la diffusion de documents scientifiques de niveau recherche, publiés ou non, émanant des établissements d'enseignement et de recherche français ou étrangers, des laboratoires publics ou privés.

Roadmap on Ferroelectric Hafnia and Zirconia-based materials and devices

José P. B. Silva^{1,2}, Ruben Alcalá³, Uygur E. Avci⁴, Nick Barrett⁵, Laura Bégon-Lours⁶, Mattias Borg^{7,8}, Seungyong Byun⁹, Sou-Chi Chang⁴, Sang-Wook Cheong¹⁰, Duk-Hyun Choe¹¹, Jean Coignus¹², Veeresh Deshpande¹³, Athanasios Dimoulas¹⁴, Catherine Dubourdieu^{13,15}, Ignasi Fina¹⁶, Hiroshi Funakubo¹⁷, Laurent Grenouillet¹², Alexei Gruverman¹⁸, Jinseong Heo¹¹, Michael Hoffmann¹⁹, H. Alex Hsain²⁰, Fei-Ting Huang¹⁰, Cheol Seong Hwang⁹, Jorge Íñiguez^{21,22}, Jacob L. Jones²⁰, Ilya V. Karpov⁴, Alfred Kersch²³, Taegyu Kwon⁹, Suzanne Lancaster³, Maximilian Lederer²⁴, Younghwan Lee^{20,25}, Patrick D. Lomenzo³, Lane W. Martin^{26,27}, Simon Martin¹², Shinji Migita²⁸, Thomas Mikolajick^{3,29}, Beatriz Noheda³⁰, Min Hyuk Park^{9,31}, Karin M. Rabe³², Sayeef Salahuddin^{27,33}, Florencio Sánchez¹⁶, Konrad Seidel²⁴, Takao Shimizu³⁴, Takahisa Shiraishi³⁵, Stefan Slesazek³, Akira Toriumi³⁶, Hiroshi Uchida³⁷, Bertrand Vilquin³⁸, Xianghan Xu³⁹, Kun Hee Ye^{9,40}, and Uwe Schroeder^{*3}

¹Physics Center of Minho and Porto Universities (CF-UM-UP), University of Minho, Campus de Gualtar, 4710-057 Braga, Portugal

²Laboratory of Physics for Materials and Emergent Technologies, LapMET, University of Minho, 4710-057 Braga, Portugal

³NaMLab gGmbH, Noethnitzer Str. 64a, 01187 Dresden, Germany

⁴Components Research, Intel Corporation, Hillsboro, OR, 97124 USA

⁵SPEC, CEA, CNRS, Université Paris-Saclay, CEA Saclay, 91191 Gif-sur-Yvette, France

⁶IBM Research Zurich, Säumerstrasse 4, 8803 Rüschlikon Switzerland

⁷Electrical and Information Technology, Lund University, Box 118, Lund, 22 100 Sweden

⁸NanoLund, Lund University, Box 118, Lund, 22 100 Sweden

⁹Department of Materials Science and Engineering and Inter-University Semiconductor Research Center, College of Engineering, Seoul National University, Seoul, 08826 Republic of Korea

¹⁰Rutgers Center for Emergent Materials and Department of Physics and Astronomy, Piscataway, NJ 08854, USA

¹¹Device Research Center, Samsung Advanced Institute of Technology (SAIT), Suwon, 16678 Republic of Korea

¹²University Grenoble Alpes, CEA, LETI, F-38000 Grenoble, France

¹³Helmholtz-Zentrum Berlin für Materialien und Energie, Hahn-Meitner-Platz 1, Berlin 14109, Germany

¹⁴National Center for Scientific Research DEMOKRITOS, 15341, Athens, Greece

- ¹⁵Freie Universität Berlin, Physical Chemistry, Arnimallee 22, Berlin 14195, Germany
- ¹⁶Institut de Ciència de Materials de Barcelona (ICMAB-CSIC), Campus UAB, Bellaterra, Barcelona 08193, Spain
- ¹⁷Department of Materials Science and Engineering, Tokyo Institute of Technology, 226-8502, Yokohama, Japan
- ¹⁸Department of Physics and Astronomy, University of Nebraska-Lincoln, NE 68588, USA
- ¹⁹Department of Electrical Engineering and Computer Sciences, University of California, Berkeley, CA, 94720, USA
- ²⁰Department of Materials Science and Engineering, North Carolina State University, Raleigh, North Carolina 27695, USA
- ²¹Department of Physics and Materials Science, University of Luxembourg, 41 Rue du Brill, Belvaux L-4422, Luxembourg
- ²²Materials Research and Technology Department, Luxembourg Institute of Science and Technology, 5 Avenue des Hauts-Fourneaux, L-4362 Esch/Alzette, Luxembourg
- ²³Department of Applied Sciences and Mechatronics, Munich University of Applied Sciences, Lothstr. 34, D-80335 Munich, Germany
- ²⁴Fraunhofer Institute for Photonic Microsystems IPMS, Center Nanoelectronic Technologies (CNT), 01109 Dresden, Germany
- ²⁵Research Institute of Advanced Materials, Seoul National University, Seoul 08826, Republic of Korea
- ²⁶Department of Materials Science and Engineering, University of California, Materials Sciences Division, Lawrence Berkeley National Laboratory, Berkeley, CA, USA
- ²⁷Materials Sciences Division, Lawrence Berkeley National Laboratory, Berkeley, CA, USA
- ²⁸National Institute of Advanced Industrial Science and Technology, Japan
- ²⁹IHM, TU Dresden, Dresden, Germany
- ³⁰CogniGron center, University of Groningen, Groningen, 9747 AG, The Netherlands
- ³¹Research Institute of Advanced Materials, Seoul National University, Seoul, 08826 Republic of Korea
- ³²Department of Physics and Astronomy, Rutgers University, Piscataway, NJ, 08854, USA
- ³³Department of Electrical Engineering and Computer Sciences, University of California, Berkeley, CA, USA
- ³⁴Materials Research Center for Element Strategy, Tokyo Institute of Technology, Yokohama 226-8503, Japan
- ³⁵Department of Materials Science and Engineering, Tokyo Institute of Technology, Yokohama 226-8502, Japan
- ³⁶The University of Tokyo, Japan
- ³⁷Department of Materials and Life Sciences, Sophia University, Chiyoda, Tokyo 102-8554, Japan
- ³⁸Université de Lyon, Ecole Centrale de Lyon, INSA Lyon, UCBL, CPE Lyon, CNRS, INL UMR5270, 69130 Ecully, France
- ³⁹Department of Chemistry, Princeton University, Princeton, New Jersey 08544, United States
- ⁴⁰Electronic Materials Research Center, Korea Institute of Science and Technology, Seoul 02792, Republic of Korea

* corresponding author e-mail: Uwe.Schroeder@namlab.com

Abstract

Ferroelectric hafnium and zirconium oxides have undergone rapid scientific development over the last decade, pushing them to the forefront of ultralow-power electronic systems. Maximizing the potential application in memory devices or supercapacitors of these materials requires a combined effort by the scientific community to address technical limitations which still hinder their application. Besides their favorable intrinsic material properties, HfO₂-ZrO₂ materials face challenges regarding their endurance, retention, wake-up effect, and high switching voltages. In this Roadmap, we intend to combine the expertise of chemistry, physics, material, and device engineers from leading experts in the ferroelectrics research community to set the direction of travel for these binary ferroelectric oxides. Here, we present a comprehensive overview of the current state-of-the-art and offer readers an informed perspective of where this field is heading, what challenges need to be addressed, and possible applications and prospects for further development.

1. Introduction (Uwe Schroeder, José P. B. Silva)

In the last decade, ferroelectric (FE) hafnium (HfO₂) and zirconium (ZrO₂) oxides have been intensively investigated, and tremendous progress has been made. Non-FE HfO₂ has been typically used in the mass production of complementary metal-oxide semiconductors (CMOS), as a high-permittivity (k) gate insulator in high-performance field-effect transistors (FETs). The discovery of ferroelectricity in 2006, five years before the first publication about the FE properties of Si-doped HfO₂ thin films, has revolutionized the research in the field, both from the fundamental and from the application point of view. These surprising results were originally unexpected because fluorite crystal structures have well-established phase diagrams, and they do not show any polar phase that is thermodynamically stable under normal fabrication conditions. Yet, the FE phase in HfO₂ and ZrO₂-based materials is accepted as the metastable orthorhombic (o -) oIII phases (space group: $Pca2_1$), and the polar rhombohedral (r -) phase (space group: R3m). Devices based on FE HfO₂ and ZrO₂-based materials could greatly benefit from the CMOS compatibility and potentially disentangle the energy efficiency problem of scaled semiconductor technology.

For these reasons, researchers have significantly increased their understanding of the material class, concerning, for example, the requirements to stabilize those FE phases or by exploring a large number of causes such as doping, oxygen vacancies, surface energy, and stress to enhance the FE properties. Interestingly, the success of this original high-performance materials rejuvenated the search by theoreticians and experimentalists to look beyond and explore further promising applications. Over the past ten years, their applications have grown from FE capacitors, transistors, and tunnel junctions for non-volatile memory applications to negative capacitance, logic-in-memory, neuromorphic computing, supercapacitors, and pyroelectric or piezoelectric-based applications.

In this Roadmap, we overview important research aspects concerning FE HfO₂ and ZrO₂-based materials. In Sec. II, we discuss the emergent field of FEs, while in Sec. III we address some fundamental properties and the specific features of this material class. In Sec. IV and V, we cover aspects of bulk and thin film fabrication. The growth of single crystals has been demonstrated, while the fabrication of these materials films has been improved considerably over the last years. Nevertheless, further improvement of the growth conditions is still an important research field, and the processing of FE HfO₂ and ZrO₂-based thin films from chemical methods up to physical ones needs further investigation. The characterization and properties (see Sec. VI) have been significantly improved since the first report in 2011. Different strategies, such as doping, defect engineering, interface engineering, electrode optimization, and the formation of laminated structures, have been intensively investigated. However, several details of the underlying physical mechanisms are still not completely understood. In Sec. VII, we outline the current status and future challenges of different devices that are currently being investigated with the use of FE HfO₂ and ZrO₂-based thin films. The major challenges and aspects that need to be considered and improved for broader applicability of these materials are addressed in Sec. VIII. Currently, the correct and precise measurement of FE HfO₂ and ZrO₂-based devices is still an issue. In addition, the need to fade the wake-up effect in order to improve reproducibility is still highly demanded. Another major challenge that remains to be solved is the possibility to decrease the switching voltages of these devices. Even though there has been significant progress, the device retention and endurance still need to be improved. Finally,

we include a perspective on commercial market opportunities in non-volatile memories (Sec. IX) and an industry perspective (Sec. X) where these materials can play a crucial role.

Regardless of these challenges concerning understanding materials properties and device physics, there has been tremendous progress on these materials, and there is no FE material in recent years that attracted such high interest for ultralow-power electronic systems (Sec. VII – table 1).

In this Roadmap, we overview the current status of FE HfO₂ and ZrO₂-based materials research and indicate promising directions for future research efforts.

2. The field of emergent ferroelectrics (Lane W. Martin)

Status

While the 100th anniversary of the discovery of ferroelectricity has come and gone, the field of stands poised to enter a new era driven, in part, by the discovery of new classes of FE materials and a renewed interest in their application¹. As it was in the middle of last century, challenges of the day are bringing about fundamental and applied advances to meet these challenges.

The term “emergent ferroelectrics” captures the surprise that has accompanied the discovery of ferroelectricity and exotic phenomena in novel materials and heterostructures and points to a challenge. While properties like piezoelectricity and pyroelectricity are directly related to material symmetry², ferroelectricity has an empirical definition – polar materials which exhibit two or more orientational states in the absence of an electric field which can be switched from one to another with an electric field. As such, identifying FEs relies on our (in)ability to both synthesize and characterize materials in a way the supports this function. The advances in synthesis and characterization that will be reviewed later have unleashed new worlds of phenomena. Even in traditional perovskite (ABO₃) FEs, our ability to heterostructure materials with atomic-scale control has begotten unexpected polar structures, including vortices, skyrmions, merons, and more (Fig. 1a)^{3,4,5}. Simultaneously, researches have been predicting (and in some cases) experimentally demonstrating ferroelectricity in novel materials such as 2D van der Waals layered materials (*e.g.*,

transition metal dichalcogenides, group IV monochalcogenides, metal triphosphates, layered perovskites, layered nitrides, indium selenide (In_2Se_3), etc.) (Fig. 1b)^{6,7,8} and wurtzite-structured materials (e.g., $\text{Al}_{1-x}\text{Sc}_x\text{N}$, $\text{Al}_{1-x}\text{B}_x\text{N}$, $\text{Zn}_{1-x}\text{Mg}_x\text{O}$, etc.)^{9,10}.

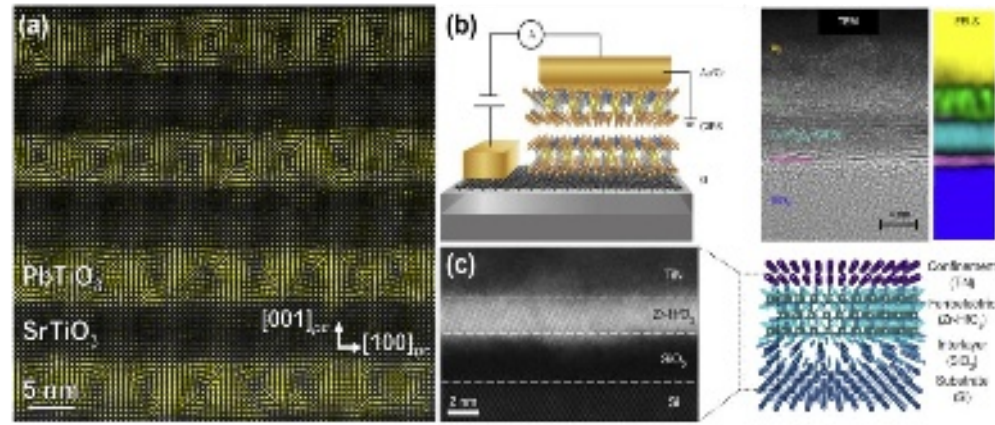

Fig. 1 (a) Cross-section, atomic-resolution scanning transmission electron microscopy (scanning-TEM) polarization-map of polar vortices in $(\text{PbTiO}_3)_n/(\text{SrTiO}_3)_n$ superlattices. Adapted from Ref. ⁵. (b) Schematic (left) and cross-section TEM image (right) of a CuInP_2S_6 (CIPS) device structure. Adapted from Ref. ⁸. (c) Cross-section scanning-TEM image of ultrathin $\text{Hf}_{0.8}\text{Zr}_{0.2}\text{O}_2$ heterostructures (left) and a schematic illustration of the same (right). Adapted from Ref. ¹¹.

While these observations have been highly touted, perhaps no other single area in the field has caught the attention of scientists and engineers alike in the last decade than the study of HfO_2 - and ZrO_2 -based compounds (Fig. 1c)^{12,13}. The observation of FE response in such materials has opened a more straightforward door for direct integration of FE properties into CMOS processes (something more challenging with traditional perovskite FEs). The report of ferroelectricity in these materials was not, however, immediately embraced across the community. This skepticism likely arose from the same challenges hinted at before concerning the definition of ferroelectricity. The community was fresh off of an explosion of work on multiferroics in which the combination of new materials, characterization techniques, and the expansion of researchers to fields outside of FEs led to numerous questionable reports of ferroelectricity (culminating in the (in)famous report of FE bananas)¹⁴. Just a few years later, reports of ferroelectricity, seemingly non-polar materials

like HfO₂-based systems quickly drew questions from a (perhaps, rightly) conservative community. While it took a few years to convince the world that these observations were not just artifacts from defects or charge trapping, this careful approach has laid a robust foundation for what has been done in the last half-decade.

Current and future challenges

First, while advances in computational/theoretical predictions, synthesis, and characterization have been critical in advancing this field, they also open new challenges. For example, the rapid expansion of predicted candidate FEs means that experimentalists struggle to realize the “diamonds in the rough”. This is exacerbated by challenges in producing these chemically diverse systems, in addressing their stability for study, and in rationalizing their (sometimes) exotic behavior (thus raising the question if these are truly novel phenomena or simple artifacts of the measurement process on new materials?). At the same time, there is a trend to push the limits of materials in terms of size (thickness and lateral scaling), time (how fast can a material switch?), energy (what is the minimum voltage/energy for actuation?), and susceptibilities (how responsive can the material be?). These are important questions for materials that are increasingly transitioning from “next-generation” to “this-generation”. The challenge is balancing fundamental science studies and engineering applications – there is probably little argument that real progress in both will require the support of the other.

In HfO₂- and ZrO₂-based materials, this competition between fundamental and engineering efforts has been at play for much of the last decade. Melding these approaches has enabled rapid progress in some areas while other topics remain open. First and foremost, a full understanding of the mechanism for stabilizing the metastable FE phase remains a matter of discussion. While there is more widespread agreement on the different structures that can and have been observed, the reasons why are more varied (from surface/volume-energy, to doping, to strain, to defects, to kinetic arguments, and more). Especially to those new to the community, the fast-moving and wide-ranging discussion can seem incongruent and contradictory. This is further complicated by disparate approaches to studying these materials (*e.g.*, polycrystalline vs. single-crystalline films, thick vs. thin films, different synthesis methods, different electrodes, etc.), which can make the narrative overwhelming.

Even in the face of this lack of clarity, some are (rightly) pushing forward to try to improve overall performance (effectively saying “I don’t care how it works, as long as it does.”). Such efforts have clarified some points (*e.g.*, the role of defects in the wake-up process) while others remain to be fully addressed (*e.g.*, routes to reduce the coercive voltage, improve reliability, assure retention, reduce fatigue and imprint, etc.). These materials also present exotic new effects – including robust polarization in ultrathin (<10 nm) films and inverse size effects¹¹ (which are potentially explained by exotic lattice dynamics)¹⁵ – which are important observations but remain to be fully fleshed out. Finally, looking at the utilization of these materials, while considerable effort has been put into the exploration of these materials for application in logic and memory, the question arises as to the suitability of these materials for the wider range of FE applications and devices.

Advances required to meet these challenges

A number of themes begin to arise that could show the community how to address these challenges. First is to embrace the unique perspectives and approaches of the fundamental and engineering sciences. Continued collaboration between academia and industry and coordinated efforts to share the most important questions with one another will accelerate real solutions. Second, as the introduction of new materials welcomes a wider swath of science and engineering to the interesting (and often complex) world of FEs, the community should be sure to embrace (and remind themselves of) the lessons from work on thin-film FE devices at the end of last century as well as lessons from thin-film epitaxy in more traditional FEs. While the materials might be different, the challenges might be the same. Much has been learned about how to address interfaces, alleviate imprint and fatigue, study defects, and how to subtly manipulate polarization processes. Third, welcoming input from other (perhaps less obvious) communities. For example, as there is growing consensus that oxygen vacancies play an important role in mediating the stabilization of the desired phases in the HfO₂-based systems, exploring the work of those in the solid-oxide electrochemistry world could provide new ways of assessing and confirming understanding. Simultaneously (and this is happening already), the community needs to tap into a wider array of measurement approaches (*e.g.*, state-of-the-art microscopes, synchrotron-based structural and spectroscopic approaches, *in-operando* studies, etc.).

Among such areas, there is an urgent need in the realm of the science of material growth. Introducing new metrologies to study the growth of these materials (*in situ* during the process) and working towards real-time feedback could be critical for them really becoming viable in industry. Finally, focused attention on addressing deficiencies in the materials. For example, in the HfO₂- and ZrO₂-based systems, despite the ability to make ultra-thin films, the coercive voltage remains a challenge. If, for example, the coercive field (E_c) is 2000 kV/cm for even a film that is just 5 nm thick, we would require a voltage of at least 1 V to switch the material. Current goals are to drive switching voltages down to just 0.1 V – an improvement of 10x from where we are today. Addressing these challenges is a key part of the future of these materials.

Concluding remarks

All in all, it is an exciting time to be working on FEs. The urgency with which these materials are being discovered and considered for an array of applications provides a renewed energy. At the same time, we must maintain a keen awareness that no single material or class of materials is likely to address the diversity of applications that call for FEs. In other words, there is no “cure-all” solution to what ails us. There are, as there always has been, every growing and changing need for functional materials in information technology, communications, healthcare, national security, energy efficiency, and beyond. “Emergent ferroelectrics” are poised to play a critical role in addressing some of these challenges. The diversification of materials begets a diversification of opportunities to really change how things are done in many areas. Our role as scientists and engineers is to make those connections and find the right approaches to address these societal challenges.

3. Fundamental Materials Properties

a. Simulation (Karin M. Rabe/ Alfred Kersch/Jorge Iñiguez)

Status

Simulations play an increasingly important role in understanding and guiding experimental work on complex functional materials, particularly FEs and related compounds. Computations of total energy can be used to explore the structural energy landscape and

identify candidate metastable phases. Quantitative predictions of the crystal structure parameters, phonons, elastic constants, polarization, and related properties such as piezoelectricity and pyroelectricity can be used to identify the phases in experimental bulk and thin films. Computations of minimum barrier paths connecting different structures, domain wall energetics and motion, defect energetics, and diffusion can assist in understanding electric field switching.

Initial simulation studies of HfO_2 and ZrO_2 ^{16,17} covered the structural properties and free energy of the polar o - $Pca2_1$ phase (standard FE phase) and the possible occurrence of competing polar o - $Pmn2_1$, r - $R3$ ^{16,18,19}, and other phases. The metastable, tetragonal (t -) $P4_2/nmc$ state plays a special role, as its comparatively large entropy enables first-order temperature-induced phase transitions from the polar phase²⁰. The t -phase has more favorable energy in ZrO_2 than in HfO_2 ²¹, which is a major reason for the relatively easy formation of $\text{Hf}_x\text{Zr}_{1-x}\text{O}_2$ (HZO). A second polar phase has been experimentally detected, which could be r - $R3$ or $R3m$ ¹⁹ or even o - $Pmn2_1$ ¹⁸, the signature XRD peak of these phases being similar. An overview of the lowest energy structures can be found in Fig. 2.

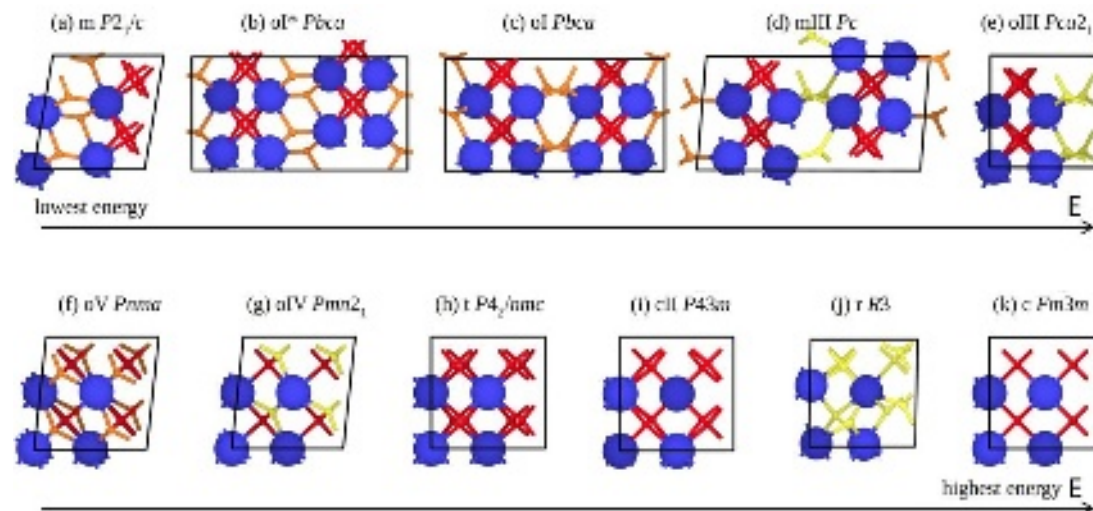

Fig. 2 Crystal phases with increasing total energy. Nonpolar oxygen (red), polar oxygen (yellow), and polar oxygen compensated within the crystal (orange). Adapted from Ref. ²¹. (f) and (g) show the 24- and 12-atomic pseudocubic cells, and the 12- and 6-atom orthorhombic unit cells are contained in a 45° rotated cuboid with half the area in the plane.

In single crystalline HfO₂ and ZrO₂, the calculated free energy of the polar *Pca2*₁ phase is above the monoclinic (*m*-) *P2*₁/*c* ground state. Favorable conditions for the thermodynamic stability of poly- or monocrystalline polar *Pca2*₁ investigated in simulation include: (i) the film is very thin or polycrystalline with grains smaller than a few nanometers²², (ii) there are favorable elastic boundary conditions²³, (iii) the crystallization is far from thermal equilibrium²⁴, (iv) there is intrinsic doping by oxygen defects²⁵, (v) there is extrinsic doping with a suitable dopant on the level of a few percent,^{26,27,28} possibly inhomogeneously distributed²⁹. Si, La, Y, Al have been identified as the most favorable dopants. HZO is an important example where doping alone does not seem sufficient to stabilize a polar ground state. Nevertheless, under the described circumstances, the polar *Pca2*₁ is energetically sufficiently stable, and its formation is favored, but the dynamic phase stabilization mechanism remains to be elucidated.

The piezoelectric constants of HfO₂ and ZrO₂ were calculated to be relatively small³⁰ and unusually negative, which is explained by the chemical bonds of the polar oxygens³¹. Interestingly, large and positive electro-strain effects were also found, and it is under discussion whether they indicate an alternative switching pathway^{32,33,34} or a competing field-induced phase transformation from a remaining *t*- phase fraction³⁵. The pyroelectric constants are also unusual because the primary and secondary pyroelectric coefficients add up and become attractively large, the effect is enhanced close to the polymorphic phase boundary^{30,36}

Current and future challenges

Phonon calculations for the cubic fluorite structure¹⁶ show there is no unstable polar mode, suggesting that this system should be considered as an improper ferroelectric. Moreover, the formation of the polar phase from the *t*- *P4*₂/*nmc* polymorph and the polarization reversal require multiple phonons^{17,37,38} resulting from anharmonic couplings, which complicate the understanding of ferroelectricity in fluorites compared to perovskites. In addition, Lee et al.³⁹ suggested that the marginal dispersion of phonon bands in the tetragonal state should have a strong influence on the switching dynamics, which may be dominated by nucleation with very slow growth.

The phonons are an initial indicator of minimum energy paths connecting the metastable phases. In addition to the standard pathway for polarization reversal¹⁶, alternative pathways have been systematically searched⁴⁰ as they may play a role in FE switching. Several approaches to the reversal have been explored in simulations, but no unambiguous model has been found yet. (i) The Kolmogorov-Avrami-Ishibashi (KAI) model⁴¹ successfully describes the kinetics of FE switching in single-crystal perovskites. The model is characterized by lateral growth or shrinkage of pre-existing domains of opposite polarity. The critical interfacial energy and barrier parameters for domain motion were calculated, and either low interfacial energy with a very high barrier^{39,42} or a low barrier but very high interfacial energy⁴³ were determined. Not all possible configurations have been investigated yet. (ii) In the Nucleation-Limited Switching (NLS) model,⁴¹ a nucleus with opposite polarization is randomly generated in the polarized domain by thermal activation and grows inexorably when critical size is exceeded. The critical parameter to be studied in the simulation is the interfacial energy, most simply of 180° domain walls, rather than mobility, since nucleation is limiting. The experimental results from⁴⁴ are in favor of the NLS model. (iii) According to the Landau-Khalatnikov (LK) model,⁴¹ there are independent crystal-like domains (grains or crystallites within a grain) in which the switching is homogeneous so that only the minimum energy barrier between initial and final homogeneous polarization states is the relevant parameter. Here, it is immediately observed that the predicted E_c is almost an order of magnitude too large as compared to experiments^{17,45}. In addition to the FE domain wall (DW), the interfaces and their energies between the t - phase and the polar phase were also calculated⁴⁶, since they are important for the formation of the polar phase from the tetragonal state and for the antiferroelectric field-induced phase transformation.

Advances required to meet the challenges

The simulation of basic material properties is well developed, but the functionals used in the first-principles calculations have not yet been systematically validated for HfO₂ and ZrO₂. For example, the calculated kinetic barriers depend significantly on the chosen functional, and experiments are needed to validate the predictions. Hybrid functionals provide accurate results for electronic defect levels⁴⁷ but have yet to be systematically

applied with realistic, sufficiently large supercells. First-principles theory suggests that the polar phase can be viewed as generated from the cubic fluorite structure through the coupling of multiple phonon modes^{17,37,38} and that FE polarization has an improper character. However, experimentally, a sharp permittivity peak has been observed during the temperature-controlled transition from the polar to the tetragonal phase²⁰, which is typical for the proper behavior. This suggests that the known theoretical multimode expansion corresponding to the $T = 0$ K limit is not suitable to describe the experiments; therefore, molecular dynamics studies based either on first principles or using machine-learned potentials are needed. These approaches may also elucidate the field-induced transition from the tetragonal to the polar state, which may allow us to obtain giant piezoelectric and pyroelectric effects.

The systematic development and application of machine-learned potentials also offer hope in other important areas. Some potentials of this kind have already been developed for HfO_2 ⁴⁸ and ZrO_2 ^{49,36}, but not yet for doped or defective materials. They are critical for studying polarization reversal, domain nucleation, and growth. More realistic potentials (capable of accounting for chemical bond breaking and formation) will be crucial to study the thickness dependence of the polar phase in thin films or the mechanisms for polar phase stabilization in grains. Combined with kinetic Monte Carlo techniques, these potentials - and potentially other simplified models, such as cluster expansion approaches⁵⁰ - will eventually enable us to study the behavior of extrinsic defects as well as fatigue and wake-up mechanisms. Finally, simple phase field models have been developed to address HfO_2 and ZrO_2 -related materials and discuss their electrical behavior in devices (e.g., in the context of negative capacitance studies^{51,52}). However, given the polymorphic nature of these materials and the non-standard nature of their ferroelectricity, the applicability of simple Ginzburg-Landau potentials is questionable and further work is needed to derive appropriate and reliable continuum models.

Concluding remarks

The discovery of ferroelectricity in HfO_2 and related compounds has brought new challenges to the theory and simulation of FEs, as well as a sense of urgency for methodological innovation. HfO_2 offers unquestionable and (among FEs) unparalleled

technological promise. However, it is still controversial whether and how HfO₂ deviates from the standard model of FEs in the soft mode property, which is best represented by perovskite oxides. Thus, HfO₂ forces us to rethink our theories and simulation approaches to ferroelectricity, to revisit assumptions that would otherwise seem obvious, and to keep an open mind for new possibilities. Many distinctive properties of HfO₂ FEs, including structural, electromechanical, and dopant-related behaviors, have already been captured by first-principles simulations, while others, including phase formation, dynamics of polarization reversal, and extrinsic contributions, have so far eluded a good understanding. As discussed in this piece, new first-principles-based approaches, such as machine-learned potentials and kinetic simulations, are needed to tackle these challenges. The experience so far suggests many exciting discoveries ahead. The journey has just begun.

Acknowledgments

J. Í. thanks for the support of the Luxembourg National Research Fund through Grant INTER/NWO/20/15079143/TRICOLOR.

b. Ferroelectricity (Cheol Seong Hwang/ Seungyong Byun/ Kun Hee Ye)

Status

When Börscke et al. first reported the FE properties from the Si-doped HfO₂ film having the TiN electrodes in 2011⁵³, the FE community encountered difficulties in accepting the finding due to several reasons. First, the doped-HfO₂ film has already been in mass-production as the high-*k* gate dielectric layer in high-performance CMOS devices, where the FE-hysteresis is detrimental. Second, the HfO₂ (isostructural ZrO₂, too) is a well-studied material with an established phase diagram where no polar phase is reported¹³. Third, the FE phase evolution is critically dependent on not only the material parameters and process variables but also film thickness, which significantly complicates the identification of the critical parameters, such as remanent polarization (P_r) and E_c ¹³. However, the intense and collaborative research worldwide during the past decade convinced the community of the robustness of the FE performance of the doped HfO₂ films, including the (Hf,Zr)O₂, which offers from a dielectric (Hf-rich) to FE (~5:5) to antiferroelectric (AFE) (Zr-rich) performances. Also, the well-established contamination

control protocols in the mass production line, due to the already matured production of the high- k CMOS devices, facilitate the acceptance of the material in the semiconductor industry at an unprecedented pace.

It is now well accepted that the FE properties of fluorite-structured HfO₂-based materials are ascribed to the o - $Pca2_1$ structure. However, it differs from conventional perovskite-structured FE materials, such as Pb(Zr,Ti)O₃ (PZT), in that the former has a non-centrosymmetric distribution of oxygen ions, whereas the latter has a non-centrosymmetric distribution of cations (Ti, Zr). The origins of the specific atomic configuration of unit cell structure in these materials are recently understood from the density functional theory (DFT) for phonon calculation. It shows that the high symmetry cubic phase (space group: $Fm-3m$) has an imaginary frequency phonon mode at the Brillouin zone boundary. This phonon mode induces antiparallel displacement of oxygen ions to cause a transition into a t - phase (space group: $P4_2/nmc$)⁵⁴. The FE o - phase can be formed via the splitting of the phonon modes of the t - phase into the zone center mode (parallel movement of all oxygen ions along the $+z$ direction) and the zone boundary antipolar mode (antiparallel movement of the half of the oxygen ions along $\pm z$ directions, respectively). Due to the coupling of the two phonon modes, the FE o -HfO₂ has a structure in which a non-polar spacer layer and a FE layer are repeated. Because of the presence of the spacer layer, it shows different domain properties from the perovskite FEs, which is induced from the only zone center soft phonon mode. Such a two-layer structure, parallel to the spontaneous polarization (P_s) direction (c -axis), reduces the elastic and electrostatic interaction between the neighboring unit cells, decreasing the 180° domain wall (DW) energy to even a negative value. This feature may decrease the DW thickness to the sub-monolayer level. However, it should not be overlooked that many other types of DWs with much higher DW energy have been experimentally observed⁵⁵. More detailed discussions on the DW configuration are given in another section (Choe and Heo).

Current and future challenges

Actually, the FE domain structure with a unit-cell thickness corresponds to the AFE $Pbca$ structure, so it cannot represent the macroscopically observed FE property of the HfO₂. Interestingly, the recent DFT calculations show that the AFE $Pbca$ structure has a lower

free energy than the FE $Pca2_1$ structure¹⁵. As discussed in detail in another section, the formation of the FE-HfO₂ phase is dominantly controlled by kinetic factors rather than the thermodynamic driving force, such as the energy barrier between the tetragonal phase and orthorhombic phases¹³. Therefore, an energetically favorable AFE $Pbca$ structure, in addition to the thickness-dependent phase stability of different phases (AFE $Pbca$ or field-induced FE $P4_2/nmc$ $< \sim 5$ nm; dielectric $P2_1/c$ $> \sim 20$ nm), complicates the practical fabrication of the high-performance metal-ferroelectric-metal (MFM) capacitor structure. The most feasible FE performance is generally achieved at a thickness of ~ 10 nm, in which the FE $Pca2_1$ remained intact even under the absence of the field due to the high barrier for the transition from FE $Pca2_1$ to AFE $Pbca$. Also, the stability of AFE $Pbca$ over the FE $Pca2_1$ phase renders the fatigue behavior¹³ (reduction of P_r with the increasing switching cycle number) different from the conventional perovskite FE materials, where the production of oxygen vacancies and accompanying domain pinning constitutes the primary mechanism. The electrical cycling provides the FE $Pca2_1$ phase with the energy to overcome the barrier to recover the AFE $Pbca$ without generating additional oxygen vacancies. In this case, the fatigued film could be rejuvenated to the FE phase by applying a slightly higher poling voltage without increasing the leakage current⁵⁶. Besides, the most commonly adopted TiN electrode almost always involves non-FE interfacial layers. All these factors render practically achieving the theoretical P_r value ($\sim 51 \mu\text{C}/\text{cm}^2$)³³ challenging. Nonetheless, optimizing the process variables, such as annealing temperature, time, cooling rate, changing electrode from conventional TiN to W⁵⁷, and adopting interfacial layers, such as HfON, have significantly improved the achievable P_r of technically viable polycrystalline film from ca. $\sim 15 \mu\text{C}/\text{cm}^2$ to $> 35 \mu\text{C}/\text{cm}^2$ ⁵⁸.

In this regard, the growth of FE-phase-pure epitaxial film must be a crucial task to prove the intrinsic FE performance of the films. This task has been challenging because aligning the [001] P_s direction to the out-of-plane direction has been hampered even on the lattice-matched Y-stabilized ZrO₂ single crystal substrate, which might be ascribed to the intricate kinetic process of the FE phase formation during cooling⁵⁹. However, recent work demonstrates that the careful control of the growth condition and cooling step can deposit phase-pure epitaxial 5% Y-doped HfO₂ film on LaSrMnO/SrTiO₃ substrate, alleviating the rhombohedral distortion⁶⁰. Interestingly, the (111) -oriented Y-doped HfO₂ film grown on

(011)-oriented substrate had a maximum P_r value of $\sim 50 \mu\text{C}/\text{cm}^2$, demonstrating that the P_s value along the (001) direction was close to the theoretical value.

Advances in science and engineering to meet these challenges

These findings indicate that the robust ferroelectricity of doped-HfO₂ films is now well-proven in both polycrystalline and epitaxial films. Nevertheless, the interwound influences of the process/material variables and film thickness effects, especially for thinner ($\ll 10$ nm) films, pose significant challenges in fabricating nanoscale electronic devices. For example, to manufacture the ferroelectric random-access memory (FeRAM) or ferroelectric field-effect transistors (FeFETs) with dimensions comparable to the state-of-the-art dynamic random-access memory (DRAM) and NAND flash memory, the film thickness must be < 5 nm. Therefore, the recent report on the FeRAM cell fabrication with ~ 17 nm-design rule DRAM capacitor structure with the standard TiN electrode⁶¹ is notable. Even though the 4-6 nm-thick (Hf,Zr)O₂ films showed distorted polarization-voltage curves, the thinner film had an even better charge response to the given short voltage pulses. Furthermore, adopting the production-worthy atomic layer deposition (ALD) process demonstrated the already well-established fabrication process of these relatively new materials in the CMOS line.

In academia, researchers attempted to explore the lower limit of the film thickness retaining the FE performances^{62,63}. Although several reports argued even sub-nm thickness (only one unit cell thickness) film showed robust FE properties, the direct structural and electrical evidence is still being debated.

Besides, the progress in the scanning TEM with the spherical aberration correction (Cs-STEM) provided the community with more direct imaging of the oxygen ion positions within the unit cell, which has been challenging in conventional HRTEM⁵⁶. Still, the data availability is limited due to the highly limited imaging conditions and grain orientation issues in the polycrystalline film⁵⁶.

Concluding Remarks

In summary, the recent advances in the experimental and theoretical works for the doped FE HfO₂ materials (bulk, epitaxial and polycrystalline films) proved the robustness of

ferroelectricity in these materials. The CMOS fabrication line-friendly material properties accelerate their active adoption in the semiconductor field at an unseen pace. It is exciting to expect the commercialization of mainstream semiconductor devices, not niche markets, using ferroelectric material after its finding ~100 years ago.

c. Piezoelectricity (Alexei Gruverman/Jorge Íñiguez)

Status

HfO₂-based FEs are one of the most actively studied groups of materials due to their vast range of fundamentally captivating and technologically alluring properties, making them extremely appealing for development of electronic devices based on switchable spontaneous polarization¹³. Most of the studies of HfO₂-based FEs have been so far focused on the mechanism of the stabilization of their polar phase, their unusual scaling properties, which seemingly defies detrimental depolarizing effects, and the interplay between the intrinsic and extrinsic factors determining the static and dynamic polarization behavior. In comparison, relatively little attention has been given to hafnia's piezoelectric properties. Although these materials exhibit weaker piezoelectricity in comparison with perovskite FEs – typical values for the measured piezo coefficients are in the range of several pm/V – their response is comparable to that of AlN-based films, which makes them a viable alternative for application in electromechanical devices such as sensors, resonators, and transducers. However, probably the most intriguing aspect of the piezoelectric behavior of HfO₂ is its high sensitivity to a variety of parameters, including film thickness, fabrication methods, doping, and electric field cycling, which opens a possibility of tuning the electromechanical functionality of these materials^{64,65}.

First-principles calculations converge on the negative longitudinal piezoelectricity response of the *o*- phase of HfO₂^{66,31}, whereby a compression along the polar axis results in an enhanced polarization. At the atomic level, this feature is attributed to the chemical coordination of the active oxygen atoms³¹ (Fig. 3): upon mechanical strain, the length of the Hf-O bond aligned with the polar direction is preserved via the shift of the oxygen ion. This shift results in polarization increase/decrease upon compressive/tensile strain, yielding a negative longitudinal piezoresponse. In contrast, there are considerable disparities in the

experimental reports on the magnitude and sign of piezoelectric coefficients of HfO_2 , which still has not received an adequate explanation. For example, piezoelectric strain measurements carried out in 20-nm-thick Si:HfO_2 films reveal a relatively strong (17.8 pm/V) positive d_{33} coefficient, which decreases dramatically to negligible values upon ac cycling⁶⁷. On the other hand, piezoresponse force microscopy studies yield negative longitudinal d_{33} piezocoefficients in relatively thin La:HfO_2 films (<30 nm), while in much thicker La:HfO_2 films (>50 nm) piezoelectricity is found to be positive⁶⁸. Notably, thin and thick La:HfO_2 films had different electrodes (TiN and Pt, respectively) and were fabricated by different methods (ALD and chemical solution deposition (CSD), respectively)⁶⁴. Moreover, the coexistence of regions with positive and negative d_{33} in the same La:HfO_2 capacitors has been reported⁶⁴, which hints at the tuning of the d_{33} sign upon electrical cycling.

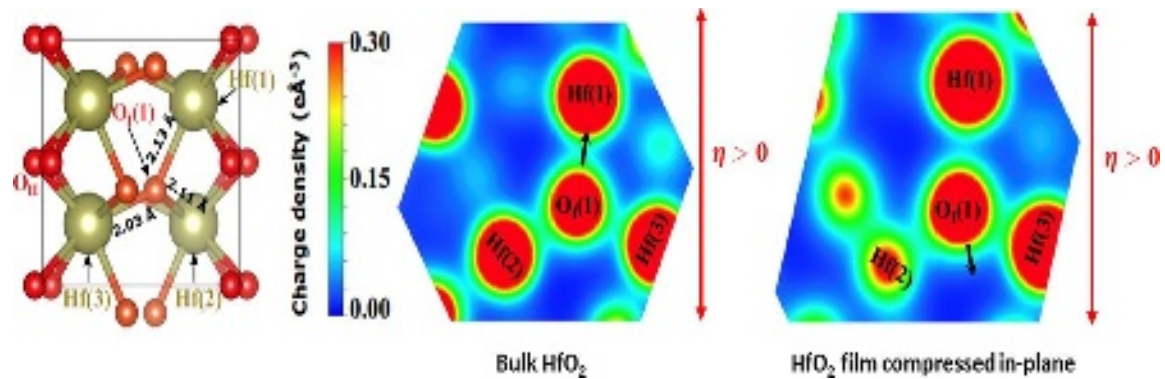

Fig. 3 Left panel: Structure of the ferroelectric phase of bulk hafnia. The Hf–O bond distances involving the polar-active oxygen “OI(1)” are indicated. Center and right panels: Electronic charge density around oxygen OI(1), which controls the piezoresponse in both bulk HfO_2 (center) and an epitaxially compressed film (right). If we stretch the material along the polarization direction ($\eta > 0$ along the vertical), the active oxygen moves (black arrow) to preserve the length of the chemical bonds most affected by the strain. Thus, the vertical Hf(1)–O bond dominates the response in the bulk compound; in the compressed film, this link is broken, and the bonds with Hf(2) and Hf(3) prevail. (Adapted from Ref. ³¹).

Current and future challenges

Experiment. Experimental studies of piezoelectricity in HfO_2 are based on the use of macroscopic testing techniques (double beam laser interferometer (DBLI), synchrotron XRD) and local probe methods (PFM). While the macroscopic methods are more straightforward in that they directly measure the field-induced strain, they are not informative enough when it comes to understanding the tunability of the piezoelectric properties. In this regard, the PFM-based approach has an advantage as it allows differentiation between the polar and non-polar phases by evaluating the local piezoresponse at the level of a single grain (several nanometers), as well as monitoring its evolution upon electrical cycling or annealing. On the other hand, interpretation of the PFM signal is not easy since it can be beset by various artifacts, such as electrostatic effects, electrochemical reactions, thermal effects, and complex cantilever dynamics^{69,70}. Even more challenging are the measurements in the resonance-enhanced mode developed to circumvent the issue of a low signal-to-noise ratio in materials with a weak piezoelectric response, where the cantilever is driven near its contact resonance. In this case, the PFM signal, which contains information about the d_{33} sign, strongly depends on the driving frequency relative to the resonance. Verification of a true sign of d_{33} requires reliable, artifact-free measurements of the PFM phase signal and careful selection of the measurement conditions⁶⁴, and should be further corroborated by the local probe quasi-static strain measurements. To date, there are very few systematic studies of the effect of confinement, chemical doping or electrical cycling on the sign of the piezoresponse in the hafnia ferroelectric family. As a result, there is still a lack of understanding of the mechanism for what seems to be a unique opportunity to tune piezoelectricity in these materials.

Theory. As regards theory and simulation, HfO_2 -based FEs pose singular challenges. These compounds present many polymorphs that constitute robust (meta)stable phases separated by relatively high energy barriers. In such conditions, even the identification of a reference paraelectric structure becomes non-trivial, and so does the elucidation of polarization switching paths. The t - polymorph is usually taken as the centrosymmetric phase associated

to the usual *o*- FE state and based on this choice, ferroelectricity is interpreted as having an improper nature³⁷. However, if the *t*- polymorph were indeed the experimentally relevant high-symmetry phase, one would expect to find four different polarization domains in the samples, something that has not been observed. On a related note, it has been recently emphasized that in HfO₂-like FEs, calculation of the spontaneous polarization itself is not trivial as it relies on an underlying assumption about the switching path between the positive and negative polarization states⁷¹: the usual choice of path – through the *t*-centrosymmetric phase – ultimately leads to a negative longitudinal piezoresponse. However, there exists at least one competing switching path^{71,33} that involves a different polarization assignment (i.e. the state usually interpreted as having a positive polarization would now have a negative one) and leads to a positive longitudinal piezoresponse. In other words, although the atomistic mechanisms controlling the piezoresponse³¹ stay the same regardless of the switching path, the sign of d_{33} may vary. It remains to be seen which switching path is experimentally relevant or whether it may even be possible to deterministically control the path for intrinsic polarization switching. Other exotic theoretical predictions, such as the dependence of the d_{33} sign on mechanical constraints³¹, seem to be more directly related to the experimental conditions and could be tested in the near future.

Advances in science and engineering to meet these challenges

Recent years witnessed significant progress in the enhancement of the piezoelectric properties of FEs via domain engineering, controlling structural instability and redistribution of mobile ionic species^{72,73}. In HfO₂-based FEs, structural transformations induced by electrical field cycling are strongly coupled to their electromechanical behavior. Sophisticated processing methods, structural phase engineering, stoichiometry control, and advanced techniques for macro/nanoscale electromechanical testing provide a foundation for designing HfO₂-based materials with tunable piezoelectric properties opening a possibility for their utilization in a variety of nanoelectromechanical devices. Fabrication of thick (hundreds of nanometers) HfO₂ films by CSD⁷⁴ is particularly beneficial for

electromechanical applications as they provide a larger mechanical strain. Recent reports on the giant enhancement of piezoelectricity by field-induced rearrangement of oxygen vacancies in centrosymmetric materials⁷² and the favorable effect of oxygen deficiency on the ferroelectricity in HfO₂ are indicative of the viability of this approach for better understanding and control of the tunable piezoelectric activity of HfO₂. Availability of the macroscopic (DLBI) and nanoscopic techniques (PFM) sensitive to the electromechanical strain provides a set of necessary tools for testing piezoelectricity over a broad scale range and establishing a correlation between the global (device-level) and local piezoelectric behavior.

From a theoretical perspective, understanding piezoelectricity in HfO₂ FEs requires first-principles modeling of all relevant polar and non-polar polymorphs - and the paths connecting them - as a function of composition. This kind of knowledge is particularly relevant for addressing the piezoelectric properties of HfO₂ because of the basic problem of how to interpret the measured spontaneous polarization, which, in turn, is related to the uncertainty about the switching path. The effective-Hamiltonian and second-principles approaches that have been so successful to study FE perovskite oxides^{75,76} do not seem suitable here. (Among many difficulties, let us mention the question of whether a suitable reference state can be defined or not,³⁴ and the challenge of treating multiple switching paths - involving the formation and breaking of bonds - within such perturbative formalisms. Instead, other force fields^{77,78,79} and machine-learned models appear to be the methods of choice. Recent publication of machine-learned potentials for HfO₂ is excellent news⁴⁸.

Concluding remarks

Addressing the full complexity of the HfO₂-based FE compounds associated with different phases, domain configurations, vacancies, grains, and interfaces will be a major test for the approaches mentioned above, both experimental and theoretical. In particular, oxygen vacancies are known to play an important role in the measured electric properties of these compounds, and the piezoresponse cannot be expected to be an exception. The predicted multiplicity of polarization switching paths, which implies an easy migration of oxygens from cell to cell, suggests a critical role of these *extrinsic* contributions and should become

a major focus of attention. A combination of local probe and electron microscopy studies with structural characterization along with electrical and electromechanical testing is required to achieve a deeper understanding of the physical mechanism behind the observed high variability of the piezoresponse and to provide a physical foundation for tailoring the piezoelectric properties of the HfO₂-based FEs. Bridging the gap between theory and experiment, particularly by addressing the extrinsic factors in the calculations, is very challenging, but its successful implementation will facilitate much faster progress. Ultimately, the difficulties that HfO₂ FEs pose are also one of their main appeals: never had we seen a FE compound with so many possibilities for experimental control of the piezoelectric properties, from a mechanical reversal of the sign of the piezoresponse without even having to switch the polarization³¹ to tuning of the piezoelectric behavior by selecting the polarization switching path⁷¹. This is a challenge worth taking!

Acknowledgments

J. Í. thanks for the support of the Luxembourg National Research Fund through Grant INTER/NWO/20/15079143/TRICOLOR.

d. Pyroelectricity (Patrick D. Lomenzo)

Status

Pyroelectric films are extensively used in infrared (IR) detectors for a wide range of applications, such as gas detection (CO, CO₂, CH₄, and C₃H₈), flame detectors, motion and gesture detection, and thermal imagers. Pyroelectrics also receive increasing interest for energy harvesting and electrocaloric cooling applications. Perovskite single-crystal LiTaO₃ or PZT materials are frequently employed in infrared detectors due to their large pyroelectric coefficients (p). The pyroelectric coefficient is comparatively smaller in HfO₂ and ZrO₂-based pyroelectric films, yet the CMOS compatibility, environmentally sustainable chemistry, and the relative ease of fabrication are attractive for fluorite-based hafnia and zirconia IR detector development.

HfO₂ and ZrO₂-based FEs are pyroelectric active materials due to the existence of the polar *Pca2₁* *o*- crystal structure⁸⁰. Since the FE dipole in this crystal phase is temperature dependent, a temperature change in FE HfO₂ or ZrO₂ can lead to the modulation of surface charge and voltage potential at the device terminals (primary pyroelectric effect). The generation of a pyroelectric voltage or current will only occur in these FEs after being polarized by the application of an electric field of sufficient strength or if the films are grown with a preferred out-of-plane dipole orientation^{81,82}.

FE doped HfO₂ and Hf_{1-x}Zr_xO₂ most frequently exhibit a polycrystalline structure, which leads to a pyroelectric coefficient that is proportional to the P_r and, therefore, highly dependent on the electrical history of the device, such as wake-up cycling or poling field strength^{83,82}. Wake-up causes a simultaneous increase in P_r and p in doped-HfO₂ and HZO FEs^{83,81}. A wide variety of dopants that induce ferroelectricity in HfO₂, including La, Gd, Al, Si, and Sr have exhibited comparable pyroelectric performance that generally depends on the product of ϵ_r and P_r ^{84,85}. Pyroelectric coefficients with a magnitude between 20 – 90 $\mu\text{C m}^{-2} \text{K}^{-1}$ in FE doped-HfO₂ and HZO films are most commonly reported in planar devices^{81,83,84,85,80,82}. Larger pyroelectric coefficients exceeding -100 $\mu\text{C m}^{-2} \text{K}^{-1}$ have been reported for Si-doped films near a morphotropic phase boundary^{86,87}. A plot of p vs. P_r is shown in Fig. 4(a). The giant pyroelectric effect, which involves a much larger temperature range and irreversible phase transitions, has been indirectly calculated with a magnitude up to -1300 $\mu\text{C m}^{-2} \text{K}^{-1}$ in Si-doped HfO₂⁸⁸. Voltage responsivity (F_v) and current responsivity (F_I) are common material figures of merit for pyroelectric detectors that are used to assess the maximum output voltage and output current, respectively. Figure 4(b) shows HfO₂-based pyroelectric figures of merit for voltage and current sensitivity. These figures of merit are smaller compared to other pyroelectric materials such as polyvinylidene difluoride (PVDF), LiTaO₃, and lead zirconate titanate (PZT)^{89,90}.

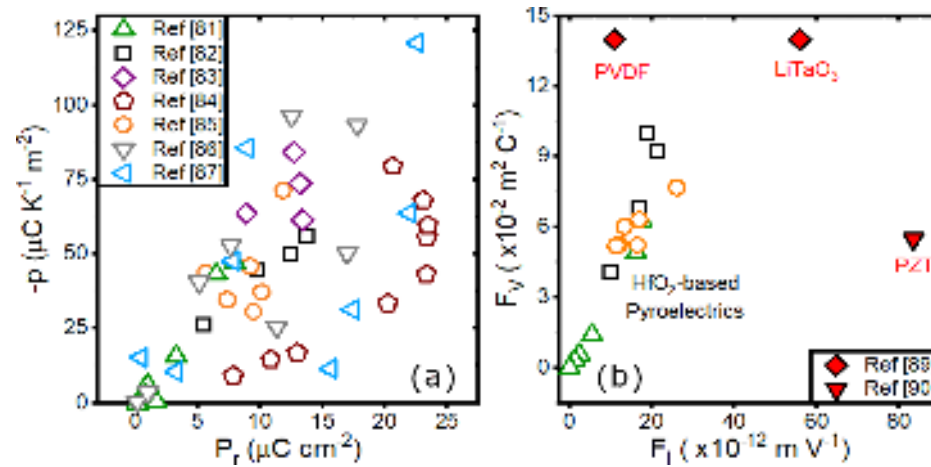

Fig. 4 (a) Pyroelectric coefficients (p) vs. remanent polarization (P_r) for various types of FE HfO₂-based thin films. (b) Voltage sensitivity vs. current sensitivity figures of merit of HfO₂-based pyroelectrics compared with other materials. The pyroelectric coefficient in HfO₂ is typically proportional to the product of $\epsilon_r P_r$, though proximity to a phase transition may enhance p further.

Current and future Challenges

Polycrystalline FE HfO₂ and ZrO₂-based films are frequently formed with coexisting crystal phases that can be influenced by the film deposition conditions, film thickness, annealing temperature, type of incorporated dopant, and dopant concentration^{81,83,84,85,80,82,88,91,86,87}. Nonpolar phases such as the t - $P4_2/nmc$ phase ($k \sim 40$) and the $P2_1/c$ m -phase ($k \sim 18$) can coexist with the polar $Pca2_1$ o -phase ($k \sim 30$) in polycrystalline FE films. The presence of m - and/or t -phases is generally undesirable for pyroelectric films because of the resulting lower P_r of the FE fluorite structured films, which can decrease the pyroelectric coefficient. However, the morphotropic phase boundary between the o - and t -phase enhances the pyroelectric coefficient, and the slight co-presence of the t -phase can, in this case, be beneficial, especially if wake-up cycling is performed to facilitate an irreversible tetragonal-to-orthorhombic phase transition.

The m -phase is particularly harmful for pyroelectric devices since its low relative permittivity can establish large depolarization fields and lower the effective permittivity of the FE film, adversely affecting the pyroelectric coefficient. The annealing temperature and doping concentration can impact the formation of the m -phase^{81,84},

problematically exhibits a strong film thickness dependence. The monoclinic phase has been widely observed to grow as the film thickness is increased beyond 15 nm in the atomic layer deposited FE doped HfO₂ and Hf_{0.5}Zr_{0.5}O₂⁸². Thicker pyroelectric films can improve the output voltage of pyroelectric sensors, which simplifies the sensing circuits. The growth of the monoclinic phase with increasing film thickness is problematic from this point of view. The increase in grain size and decrease in in-plane tensile stress with growing film thickness make the *m*-phase more energetically favorable than the *o*- and *t*-phases, thus creating challenging conditions to manufacture thicker FE HfO₂-based films with best-in-class pyroelectric performance.

One method to inhibit the formation of the *m*-phase is to interrupt the crystalline structure of the FE films by incorporating a 0.5 – 1 nm amorphous oxide layer in films thicker than 10 nm. This technique was successfully demonstrated for Si-doped HfO₂ with Al₂O₃ interlayers where a total film thickness of 50 nm was grown without the formation of the monoclinic phase, and a pyroelectric coefficient of 62 $\mu\text{C m}^{-2} \text{K}^{-1}$ was reported⁸³. The interlayer approach to fabricate thicker pyroelectric films is not necessarily flawless, however, since the pyroelectric coefficient decreased from 84 to 62 $\mu\text{C m}^{-2} \text{K}^{-1}$ when increasing the Al₂O₃ interlayer Si-doped HfO₂ film thickness from 20 to 50 nm. New methods to further increase the pyroelectric coefficient, film thickness, and loss tangent would benefit pyroelectric applications such as infrared sensors.

Advances in science and engineering to meet these challenges

Key advantages FE HfO₂-based pyroelectrics have over other pyroelectric materials are its CMOS compatibility and the mature deposition capabilities available for thin films. Three-dimensional trench capacitors have been demonstrated with FE HfO₂-based pyroelectric materials^{92,93}. These trench capacitors greatly increase the effective pyroelectric coefficient when compared to planar capacitors. Moreover, a CMOS-compatible integrated infrared sensor with doped HfO₂ has been demonstrated comparing planar and trench capacitor pyroelectric performances⁹³. In that work, trench capacitors magnified the effective area and the responsivity by a factor of 15 compared to the planar pyroelectric HfO₂-based infrared detectors. However, the authors observed that the trench capacitors increased the electrical capacitance and noise, preventing the sought-after improvement in signal-to-noise

ratio compared to the planar devices⁹³. Moreover, the geometry of trench capacitors might preclude some pyroelectric applications, such as thermal array imagers, since incident radiation may not be uniformly sensed from the environment compared to planar thermal pixels. Reducing the loss tangent and increasing the FE HfO₂ film thickness without degrading the pyroelectric coefficient are required to improve infrared sensors developed from fluorite pyroelectrics.

Laminate structures, superlattices, refinements in processing, and doping strategies should facilitate incremental improvements in the pyroelectric performance of FE HfO₂ thin films. In particular, optimization of the FE films for pyroelectric applications will require (i) minimization of the *m*-phase, (ii) a high P_r , (iii) improvements in film deposition processing, and (iv) a suitable poling technique to achieve optimal pyroelectric performance. CSD is a good candidate to realize much thicker FE HfO₂ and ZrO₂-based films for improved infrared sensor characteristics. Pyroelectric measurements on epitaxial films could also give further material insight since polycrystalline effects can be excluded. Pre-poling or self-poled FE capacitors through the fabrication process would be preferable for production processes of infrared sensors.

Pyroelectric energy harvesting devices that take advantage of the giant pyroelectric effect on FE HfO₂ and ZrO₂ films have been predicted to be very promising based on indirect calculations⁸⁸, but direct measurements are needed to better assess the material performance for energy harvesters. Furthermore, pyroelectric-based energy harvesters with trench capacitor geometries could aid in improving the active pyroelectric volume that can scavenge thermal energy. Future investigations into HfO₂ and ZrO₂-based films that employ direct measurements of the giant pyroelectric effect near the orthorhombic-to-tetragonal phase transition at or above room temperature would help to shed light on how the proximity of the phase transition might advance energy harvester. The development of nanostructures and evaluating the role of substrate clamping effects would also aid in better assessing primary and secondary pyroelectric coefficients, the latter of which arises from the piezoelectric effect and thermal expansion⁹⁴.

Concluding Remarks

FE HfO₂ and ZrO₂-based films show very promising pyroelectric properties for infrared sensing, energy harvesting, and electrocaloric cooling applications. Although this fluorite structured material system lags behind in some infrared sensor performance metrics with best-in-class materials like LiTaO₃ and PZT, research on HfO₂ and ZrO₂-based FE materials has only exceeded the one-decade mark at the time of writing. With further advances in processing and film development, it remains to be seen if FE HfO₂ and ZrO₂ materials can close the performance gap in infrared sensing devices compared to leading commercial materials.

Phase transitions or films near the morphological phase boundary could be further exploited in a wide variety of doped HfO₂ and ZrO₂ films to achieve enhanced pyroelectric and giant pyroelectric effects. Direct measurements of the giant pyroelectric effect through phase transitions will help to reveal this material system's full potential for pyroelectric energy harvesting devices. In conclusion, there remain many opportunities to both discover and optimize more pyroelectric properties in these fluorite-structured ferroelectrics.

Acknowledgments

PL was funded by the German Research Foundation (DFG)—Project No. 430054035 and 433647091.

e. Negative Capacitance (Michael Hoffmann)

Status

Negative capacitance (NC) occurs when the charge on a capacitor changes oppositely to the voltage across it, which can be caused by various physical phenomena in different materials and structures⁹⁵. In 1976, Landauer first proposed that FEs should exhibit NC due to their polarization instability⁹⁶, but experimental evidence only started to appear some thirty years later⁹⁷. Importantly, there are two different types of NC, which must be distinguished: Transient and stabilized NC. While transient NC can occur during hysteretic polarization switching in FEs, NC can be stabilized by an external positive capacitance to achieve

hysteresis-free behavior. In 2008, Salahuddin and Datta proposed that stabilized NC could be used to amplify the voltage in nanoscale transistors, thus overcoming the fundamental limit of the subthreshold swing (SS) of 60 mV/decade at room temperature⁹⁸. However, the first experimental NC results were obtained in epitaxial perovskite FEs, which are not compatible with standard semiconductor manufacturing^{99,100}.

From the integration point of view, fluorite-structure FEs based on HfO₂ and ZrO₂ are ideal for NC applications since they are scalable and can be easily integrated into advanced semiconductor devices^{101,102}. The first direct measurement of transient NC in fluorite-structure MFM capacitors was reported in 2016¹⁰³. Since then, stabilized NC has been demonstrated in pulsed electrical measurements of FE/dielectric and AFE/dielectric capacitors using relatively thick films (~10 nm) and large voltages (>5 V)^{51,104,105}. It has been proposed that NC in such heterostructure capacitors could enable higher energy storage density and efficiency in electrostatic supercapacitors¹⁰⁶. However, the origin of these experimental NC effects observed in fluorite-structure ferroelectric capacitors has been debated. For example, it has been argued that parasitic circuit components could result in similar transient NC behavior as observed in MFM capacitors¹⁰⁷. It was also suggested that the charge boost in FE/dielectric capacitors might be explained by ferroelectric imprint and reverse switching from a vortex-like domain structure¹⁰⁸.

Furthermore, there have been many reports of transistors with fluorite-structure gate oxides, which exhibit below 60 mV/decade SS under certain measurement conditions¹⁰⁹. However, the vast majority of these claimed “NC transistors” seem to exhibit a transient NC effect with substantial hysteresis, which limits their potential for applications^{101,110,111,112}. Unambiguous reports of NC transistors with hysteresis-free sub-60 mV/decade SS are still elusive so far. Nevertheless, it has been shown that ultrathin (<3 nm) fluorite-structure gate oxides can lead to improved performance of scaled transistors compared to regular amorphous HfO₂, even when the SS is still larger than 60 mV/decade at room temperature¹⁰². Recently, it has been shown that 2 nm thick HfO₂/ZrO₂/HfO₂ (HZH) superlattices with mixed FE/AFE order can reduce the equivalent oxide thickness (EOT) of advanced transistors down to 6.5 Å, lower than the physical thickness of the SiO₂ interfacial layer⁶³. These promising results suggest that the HZH layer can be stabilized in

an NC state, thus achieving lower overall EOT without degrading the transistor performance and reliability.

Current and Future Challenges

To enable NC transistors based on fluorite-structure (anti)ferroelectric oxides with even lower EOT and SS values, several critical challenges must be overcome. While some of these challenges are related to our limited understanding of NC and the basic material properties of fluorite-structure oxides, others stem from the need for a practical NC device design and FE material integration^{101,113}. While the microscopic origin of NC is relatively well understood in model systems such as epitaxial perovskite FEs^{99,100,114}, it is less clear in fluorite-structure (anti)ferroelectrics so far.

For example, fluorite-structure (anti)ferroelectric thin films are typically polycrystalline with complex domain topologies as well as mixed FE and non-FE grains of various sizes and orientations¹¹⁵, which makes the microscopic imaging of the domain and grain structure challenging. Charge trapping effects can play an important role due to the presence of defects at interfaces and grain boundaries¹⁰¹. This complicates the development of more accurate NC models for fluorite-structure oxides, which need to take at least the domain and grain structure into account^{116,117}. From a theoretical point of view, the basic anisotropy and domain coupling constants, as well as the domain wall mobilities, are still not well established. So far, these critical values for NC device simulation are typically fitted to experimental data. Without realistic estimates for these values, it is challenging to understand the microscopic origin of NC in fluorite-structure oxides^{117,118} and to assess the theoretical limits of NC devices based on these materials.

For the development of nanoscale NC transistors, the gate oxide should ideally be as thin as 2 nm. While fluorite-structure (anti)ferroelectrics in this thickness range tend to become more textured when grown on silicon by ALD, they still show substantial spatial inhomogeneity in part due to their *t-o*- phase mixture^{63,119,11}. This presents a challenge for ultimately scaled NC transistors, which might exhibit larger device-to-device variability due to the polycrystalline nature of the gate oxide, which in conventional devices is amorphous. While there is currently no experimental data to support this, variability might also be exacerbated for scaled 3D NC transistors like FinFETs or nanosheet FETs. One

major challenge in achieving hysteresis-free sub-60 mV/decade SS in NC transistors seems to be the large change in the quantum capacitance of the semiconductor channel with gate voltage¹²⁰. Furthermore, the need for a thin SiO₂ interfacial layer in silicon-based devices might ‘absorb’ most of the NC benefit, leading to an overall positive capacitance of the gate stack and, thus SS larger than 60 mV/decade⁶³.

Advances in science and engineering to meet these challenges

In recent years, substantial progress has been made on both the demonstration and understanding of NC effects in fluorite-structure (anti)ferroelectrics¹²¹. On the theory side, multi-domain and even multi-grain numerical models have been developed, which are able to reproduce experimental NC data^{116,118,117}. Furthermore, first-principles calculations have revealed some of the unique domain wall properties of fluorite-structure ferroelectrics^{42,43,122}, which are crucial to better understand the microscopic origin of NC. Especially the importance of topological domain walls⁴³ might explain the qualitative differences of NC behavior observed in thicker (anti)ferroelectric/dielectric capacitor structures^{51,104,105} compared to ultrathin mixed-phase films⁶³. Uncovering the relationship between topological domain wall dynamics and NC in fluorite-structure oxides is a promising topic for future research. High-resolution transmission electron microscopy (HRTEM) techniques could help to directly image such domain wall structures¹²³ in devices with macroscopic NC behavior. In principle, HRTEM combined with *in situ* voltage biasing could directly reveal such domain wall movement¹²⁴.

A significant recent advance in experimental NC devices was the demonstration of stable NC in ultrathin HZH gate oxides resulting in a low EOT without interfacial layer scavenging⁶³. After demonstrations on 90 nm gate length n-type transistors, further experiments with even shorter channels and p-type devices will be important for CMOS applications. Variability and reliability of ultimately scaled NC transistors should be investigated. As mentioned before, more theoretical insight into how to tune NC in these mixed-phase ultrathin films will be helpful to reduce the EOT further by optimizing the FE and interfacial SiO₂ layers¹²⁵. Furthermore, it seems promising to investigate other channel materials besides silicon, where SiO₂ interfacial layers might not be necessary or which can be operated in the quantum capacitance limit¹²⁰. Future research should also investigate 2D

and 3D electrostatic effects due to the multi-domain nature of the FE layer and how these influence the quantum confinement in the semiconductor channel.

Beyond nanoscale transistors, other promising applications for NC include energy storage¹⁰⁶ as well as actuators and sensors¹²⁶. From a more basic research point of view, experiments on NC could also give new insight into the fundamental switching mechanism of (anti)ferroelectric fluorite-structure oxides^{105,118}, which is still not fully understood^{127,44,43}. Additionally, combining NC with other solid-state physics phenomena, such as high-temperature superconductivity¹²⁸, could enable entirely new applications for fluorite-structure FEs.

Concluding Remarks

NC in fluorite-structure (anti)ferroelectric oxides is a promising phenomenon, especially for applications in nanoscale transistors as well as fundamental physical material investigations. NC experiments could give new insights into the FE-switching behavior of fluorite-structure FEs. Recent progress in the experimental demonstration of stabilized NC in ultrathin fluorite-structure oxides is encouraging for future transistor applications. However, more microscopic insight, both from theory and experiment, is needed to fully understand the physical origin of NC in fluorite-structure oxides and to optimize NC device design. In particular, the role of topological domain walls and the mixed-phase microstructure needs further investigation. For nanoscale transistor applications, further reduction of the EOT and SS is needed through material and device optimization with the help of multi-domain modeling. Beyond transistors, NC seems promising e.g., for energy storage applications. Lastly, investigating NC in combination with other solid-state phenomena, such as quantum confinement or superconductivity, could enable entirely new applications.

f. Domain walls (Duk-Hyun Choe/Jinseong Heo)

Status

Although infinitely-large FE crystals prefer a single-domain state in principle, real FE crystals are usually divided into multiple domains of different polarities. Such domains can

occur spontaneously (for example, owing to defects and/or finite-size effects), and they can also be formed and engineered by the application of external fields. The boundaries separating these domains are called FE DWs. FE DWs not only play a central role in polarization switching, but they can lead to many emergent phenomena, including charged DW, DW conduction, and exotic topological textures (vortices, skyrmions, and merons)^{129,3}. Therefore, understanding their structure, topology, and motion is of both fundamental and technological importance. In HfO₂-based FEs, work on intrinsic properties of DWs and the mechanism of their dynamics is still in its infancy. This section briefly reviews the field of DW physics in HfO₂-based FEs and provides an outlook based on the current and future challenges.

Current and Future Challenges

A number of interesting DWs can exist in HfO₂-based FEs. Several types of DW structures in the common *o*- (*Pca2*₁) phase of FE HfO₂ were identified using scanning transmission electron microscopy (STEM) analysis. Grimley *et al.* reported the first reliable observation of 90° DWs in ALD-grown Gd:HfO₂¹¹⁵. Kiguchi *et al.* introduced and identified several types of atomically sharp 180° and 90° DWs as well as tilted DWs in epitaxial Y:HfO₂⁵⁵. Both studies, however, could not identify the exact sign of the domain polarizations. Using atomic-resolution STEM, Cheng *et al.* were able to distinguish the direction of the polarization in a mixture of *Pca2*₁ and *Pbca* phases of Zr:HfO₂⁵⁶, in which their phase boundary bears structural resemblance to the 180° DWs. Interestingly, a recent study by Zhou *et al.* identified a charged 90° DW having a tail-to-tail domain structure in Zr:HfO₂¹³⁰, which could affect the wake-up behavior in the polarization hysteresis depending on the orientation of the DW. The first systematical categorization of DWs in HfO₂ was done by Ding *et al.* based on first principles calculations⁴². They established 10 basic types of 180° and 90° DWs by considering the orientation and lattice vectors of the unit cell of the *Pca2*₁ phase of HfO₂. It should be noted that the DW energy of the most stable 180° DW is calculated to be negative^{42,39}, suggesting a possible preference of anti-polar domains even in an infinitely-large, pristine HfO₂ crystal. Moreover, the domains separated by such DWs have shown to persist its polarization at the ultimate scale, i.e., a half-unit cell width ($\sim 2.5\text{\AA}$)^{42,15}. Lee *et al.* attributed these striking differences from

traditional perovskite FEs to the intrinsic flat phonon bands in HfO_2 ³⁹. On the other hand, Choe *et al.* revealed a class of topological DWs in HfO_2 that is characterized by the relative quasi-chirality and the parity of the number of half-unit cells between the neighboring domains⁴³. The term topological is used due to the requirement of *global* structural changes for transitions between different topological classes of DWs, while transitions within the same class only require *local* structural changes near the DW. This has opened up new possibilities in the search of DWs not only in the $Pca2_1$ phase, but also in inter-phase boundaries between t - ($P4_2/nmc$), o - ($Pca2_1$), and m - ($P2_1/c$) phases which are often present in experiments^{115,55}. Zhao *et al.* further expanded the family of the topological DWs into 93 irreducible configurations based on the lattice mode analysis¹²².

Domain wall dynamics

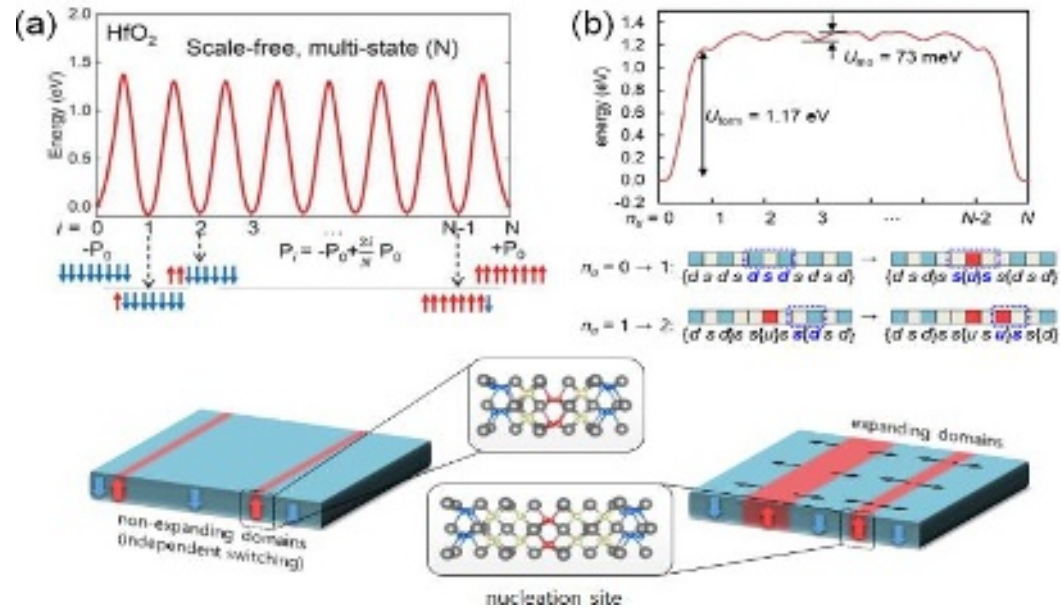

Fig. 5 Relative energies of the two different ferroelectric switching scenarios: (a) non-expanding domains (independent switching) and (b) expanding domains. Schematics of the two switching scenarios are shown below. Figures adapted from³⁹ and⁴³.

Theoretical studies suggest that DW dynamics and the polarization switching mechanism in HfO_2 -based FEs can be markedly different from those in perovskite FEs. In particular, the energy barrier for the DW motion in HfO_2 via the most stable 180° DW is calculated to be more than an order of magnitude higher than its perovskite counterparts^{42,39}. Lee *et al.*

pointed out that the polar domains in HfO₂ can be independently switchable (or nucleated) down to the ultimate limit³⁹, with a high energy barrier that is similar to that of the DW motion (Fig. 5a). While this suggests a potential use of HfO₂ for a novel ultra-dense memory³⁹ this also implies that the intrinsic polarization switching of HfO₂ films as a whole can be extremely inefficient. PFM measurements support this model, which showed about 100 times lower DW velocity compared to PZT¹³¹. According to this model, however, DW motion becomes practically impossible in HfO₂ FEs. The absence of DW motion within a grain would translate to an ultra-slow switching speed even for NLS mechanism, which would impose limitations on the applicability of HfO₂ in the emerging FE devices, including FeFETs and negative capacitance field-effect transistors (NCFETs). Meanwhile, Choe *et al.* pointed out that the high switching barrier in the proposed model is attributed to the structural change that reverses the quasi-chirality of the domains⁴³. To find a low-barrier switching mechanism, they devised a tetragonal phase-like DW composed of 2-half-unit cells (two consecutive ivory-colored boxes in Fig. 5b), which leads to the same quasi-chiral symmetry within the neighboring domains. Such DW could significantly reduce the switching barrier, allowing for a rapid DW propagation in HfO₂. Moreover, as illustrated in Fig. 5b, it can be created by a new type of domain nucleation model involving 3-half-unit cells⁴³, which is calculated to be energetically preferred over the seemingly plausible half-unit cell nucleation. Together, these findings demonstrate that the fast nucleation and growth within a grain can be feasible through topological DWs in HfO₂, as has been hinted by indirect evidence in experiments^{132,133,134,135,136,533}. Lattice mode analysis by Qi and Zhao has revealed several more chirality-preserving switching mechanisms via the topological DWs^{38,122}.

It is worth mentioning that an alternative FE switching mechanism, based on the intermediate *o*-(*Pbcm*) phase, also exists^{137,43}. In addition to a 35% increase in remanent polarization, an intriguing feature of this mechanism is its counterintuitive labeling of the polarization orientation⁴³, precisely opposite to the scenarios in Fig. 5, arising from the opposite O atom movement during FE switching. Much room remains for further studies regarding its role in the different signs of the piezoelectric coefficient^{138,64}, O migration^{139,43,140}, and DW growth^{141,142}.

Advances in science and engineering to meet these challenges

The key challenges in DW physics of HfO₂ can be divided into theoretical and experimental challenges. Up until now, theoretical investigations are limited to neutral DWs having 180° and 90° DW angles. Considering the existence of complicated DWs in FE HfO₂, including tilted DWs⁵⁵ and charged DWs¹³⁰ in experiments, the family of topological DWs in HfO₂ is expected to be much richer than what is currently known. In addition, due to the high computational cost, previous first-principles calculations are mostly relying on small systems no larger than 8 unit cells (~ 1 nm³). While such calculations can provide fundamental insights into DW physics, they cannot capture the realistic DW dynamics that involve collective and complex processes. A critical shortcoming, for example, is that the currently estimated E_c from first principles is generally an order of magnitude higher than the experimental values^{137,45}. There is no reliable first-principles estimate for the DW velocity in HfO₂ as well. The E_c and DW velocity of HfO₂ should be quantitatively understood using large enough supercells (> 64 nm³), as they are among the most important features affecting the performance of FE devices. In addition, understanding the effect of surfaces¹⁴³, interfaces¹⁴⁴, and defects¹⁴⁵ on the DW stability and dynamics is required. Utilization of large-scale density functional theory (DFT)^{146,147}, machine-learned force field (MLFF)^{48,148}, and effective lattice Hamiltonian approach⁷⁵ in FE HfO₂ is desired to gain deeper first-principles insights into the DW dynamics and E_c . This will also help set up macroscopic models for device-scale simulations, such as phase-field simulations^{149,116} and TCAD, which require many fitting parameters that are generally not accessible to experiments.

Experimental access to the DW structure and their dynamics at the atomic level is difficult. In HfO₂-based FEs, their highly polycrystalline nature¹⁵⁰ with the <20 nm crystallite size and the mixed competing phases^{16,151} add additional layers of complexity¹¹⁹. One of the most important requirements for accurate identification of DWs is the reliable imaging of oxygen atoms in doped HfO₂ along specific crystallographic orientations^{43,130,56}. Given a range of theoretically discovered DWs^{42,43,122}, and with only a handful of observations^{115,55,130,56}, further experimental study with advanced microscopy is needed. Unfortunately, direct observation of DW dynamics in FE HfO₂ poses even greater

challenges. For example, piezoelectric force microscopy (PFM), the most widely used scanning probe microscopy (SPM) for dynamical studies, cannot provide real-time information on the DW motion at the atomic resolution¹⁵². Alternatively, *in situ* TEM typically requires special processing techniques, and it often does not represent the actual operating environment. Advances in the atomic-scale *in situ*/operando electron microscopy^{153,139}, together with *in situ* SPM¹⁵⁴, could enable the experimental confirmation of the unique functional properties of DWs in HfO₂ and further inspire the exploration of new DW physics.

Concluding remarks

The discovery of ferroelectricity in HfO₂ has not only triggered a resurgence of interest in FE devices, but it is stimulating the quest for a deeper fundamental understanding of their unconventional FE behavior. We are beginning to recognize the diversity and functionality of DWs in the *Pca2₁* phase of HfO₂. We anticipate that new types of functional DWs and/or intriguing topological morphologies will be experimentally revealed in the near future. Other competing FE phases, including recently suggested *o*- (*Pnm2₁*)¹⁵¹ and rhombohedral (*R3* or *R3m*)¹⁹ phases may also possess distinct types of DWs with various DW angles, where their DW structures remain largely unexplored. The fundamental insights obtained into the nature of DWs and their dynamics will offer a more rational design and engineering of emerging FE devices, further accelerating their development.

4. Bulk Growth (Xianghan Xu, Fei-Ting Huang, Sang-Wook Cheong)

Status

The challenge of quantum materials innovation comes with fabricating stable micro-devices with physics dominated by quantum mechanism, which has led to world-wide research efforts on functional properties of quantum materials. Likely, film forms will be used for those quantum material devices, but it is necessary to have bulk crystals to study intrinsic physical properties. In addition, there can also be applications using bulk crystals; for example, FE bulk crystals of BaTiO₃, LiNbO₃, and PMN-PT have been used for rectifiers, oscillators, and piezoelectric actuators. For the new generation of quantum materials,

investigating a workable bulk crystal growth technique is a fundamental step to push them from laboratories into the realm of massive industrial production and applications, and HfO₂ growth is one good example.

Being studied as a high- κ material that shows good compatibility with the Si-based micro-devices, the investigation of HfO₂ bulk single-crystal growth has never stopped. In 1966, A. B. Chase and Judith A. Osmer reported the growth of monoclinic HfO₂ single crystals with typical size 2 mm * 2 mm * 1 mm from a PbF₂ flux¹⁵⁵. In 1970, R. Robert and C. Peter reported monoclinic HfO₂ crystals grown from a Li₂O-MoO₃ molten flux and hydrothermally from an NH₄F solution, and needle-like or plate-like crystals were obtained¹⁵⁶. In 2016, Victor et al. reported the growth of monoclinic HfO₂ single crystals using a reactive chemical vapor deposition with CF₄ as a transport agent¹⁵⁷. The crystal plates show a typical size of around 2 centimeters. Besides, people also made attempts to get HfO₂ crystals in different room temperature phases by introducing dopants. F. Kadlec and P. Simon reported the growth of Yttrium-stabilized-hafnia (YSH) single crystals in cubic phase from melting with 20 mm dimension in diameter¹⁵⁸. M. Matthew and K. Joseph reported a hydrothermal growth method of Yttrium, Neodymium, Holmium, and Erbium stabilized cubic hafnia single crystals having a maximum size of 0.25 mm¹⁵⁹. Shunsuke et al. reported the skull melting growth of 20 mm size 17% Tb-doped cubic HfO₂ crystals¹⁶⁰. Haihang et al. reported the growth of cubic Hf_{0.86}Y_{0.13}Eu_{0.01}O_{1.93} single crystal with an optical floating zone equipped with high-power Xenon lamps¹⁶¹. Jin et al. reported the growth of Lutetium stabilized cubic HfO₂ single crystals with a typical dimension of 5 mm by a metal-assisted indirect arc heating method¹⁶².

Current and Future Challenges

The polymorphic nature is the major difficulty in the growth of bulk HfO₂ in a certain desired phase. Typically, all the bulk single-crystal growth techniques involve an equilibrium crystallization of the thermodynamically most stable phase at the growth temperature and chemical environment, which doesn't encourage the growth of kinetically stabilized *o*-HfO₂ bulk crystals. However, in HfO₂ films, the relative energy of polymorphs and transformation kinetics between them have been found strongly depending on factors like doping^{163,53,164,165,166}, oxygen vacancies^{28,167,168}, stress/strain¹⁶⁹, cooling rate^{170,171}, and

surface energy²². Therefore, the synergetic interplay of some of those factors seems the right approach to search for kinetically stabilized phases in HfO₂ bulk materials.

For undoped HfO₂, the structure undergoes the monoclinic (*m*, *P2₁/c*), tetragonal (*t*, *P4₂-/nmc*), and cubic (*c-Fm-3m*) phases with elevated temperature. Attempting to quench undoped HfO₂ bulk crystals from the high temperature cubic phase results in the monoclinic phase at room temperature, which means the energy of kinetically stabilized phases remains high in undoped HfO₂. Inspired by the fact that introducing dopants such as Zr⁴⁺, Si⁴⁺, Al³⁺, La³⁺, Gd³⁺, Y³⁺ can facilitate the formation of kinetically stabilized phases in HfO₂ thin films, Y³⁺ seems the most desirable dopant into bulk HfO₂ to achieve the kinetically stabilized phases for the following reasons. First, Y³⁺ has relatively closer ionic radius to Hf⁴⁺ than La³⁺ and Gd³⁺, which guarantees good solubility. Second, Y³⁺ incorporation brings great structure tunability into bulk HfO₂. According to the equilibrium phase diagram of Y₂O₃-HfO₂ solid solution, introducing 20% Y atom can fully turn the room temperature phase into a fluorite-type cubic phase. In the contrary, though Zr⁴⁺ also has good solubility in HfO₂, the room temperature phase of bulk (Hf,Zr)O₂ is always monoclinic, independent from concentrations. Moreover, the heterovalence doping of Y³⁺ spontaneously introduces oxygen vacancies, which may favor the kinetically stabilized *o*-phase over the *m*-phase which has more oxygen coordination of Hf atoms.

Since the cubic phase has the most Yttrium solubility and appears at an extreme high temperature just below the melting point, to ensure the uniform Yttrium distribution, a crystallization directly from HfO₂:Y molten liquid would be ideal. The refractory nature of bulk HfO₂ makes its melting point extremely high (almost 3000 °C). Even an Iridium crucible that is commonly used in Czochralski method cannot survive at such a high temperature. Nevertheless, a floating zone technique has the merit of being crucible-free that can overcome this limitation. The maximum output temperature of a floating zone furnace strongly depends on the heating elements and optics. The conventional floating zone furnace typically adopts a “halogen lamps + concave mirrors” setup, and the maximum temperature of around 2200 °C is insufficient to melt bulk HfO₂. Remarkably, the laser floating zone model commercialized in 2011 adopts focused high-power diode-based laser beams as heating elements, which enhances the maximum heating

temperature¹⁷². Moreover, the well-focused laser beams create a large temperature gradient of around 150°C/mm at the solidification interface, which is ~5 times larger than that of a conventional floating zone furnace. For the growth of bulk HfO₂ in kinetically stabilized phases, this sharp temperature gradient facilitates rapid cooling after crystallization, which prevents undesirable Yttrium diffusion and phase separation.

Advances in science and engineering to meet these challenges

In 2021, Xianghan et al. reported the growth of HfO₂:Y bulk crystals with various Y dopant concentrations by a laser floating zone method²⁴. XRD pattern of ground crystals indicates the existence of kinetically stabilized *o*-phases, which are not found in the equilibrium Y₂O₃-HfO₂ phase diagram. Clear hysteresis P-E loop obtained on polished 12% HfO₂:Y crystals confirms the bulk ferroelectricity and electron diffraction study unveils the non-centrosymmetric *Pbc*2₁ (*o*-FE) space group as the origin of FE polarization in 12% HfO₂:Y single crystals. The existence of a *Pbca* (*o*-AP) *o*-phase with an antipolar structure is also evidenced in 8% to 11% HfO₂:Y crystals. Interestingly, FE and antipolar *o*-phases only exist in as-grown crystals, which endure a relatively rapid cooling from the laser floating zone growth. Both *o*-structures remain stable at room temperature and can be transformed into a mixture of thermodynamically stabilized cubic and monoclinic phases after being annealed at 1600°C for days, as displayed in Fig. 6(a-b). The DFT calculation result implies that, instead of the lowest thermodynamic energy, the smallest energy barrier of the transition from cubic into *o*-FE structure plays a critical role in the stabilization of the ferroelectric *o*-phase, which explains why the formation of *o*-phases is preferred by rapid cooling.

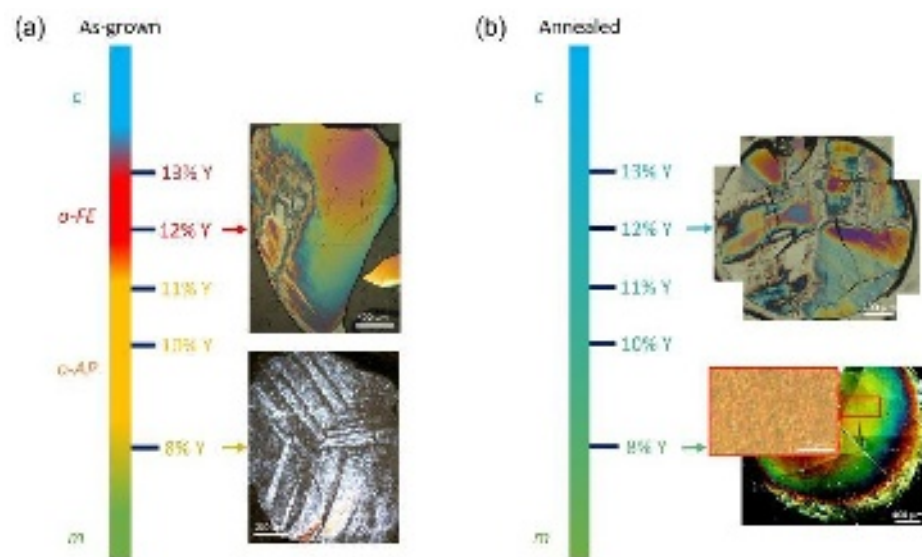

Fig. 6 The phase diagram of HfO₂:Y bulk single crystals with different Y concentrations and thermal histories identifies four main phases, including the room temperature monoclinic (m) P2₁/c phase, the high-temperature cubic (c) Fm-3m phases, the antipolar orthorhombic Pbc_a (o-AP) and the ferroelectric orthorhombic Pbc₂₁ (o-FE) phases. The insets show corresponding transmission polarized-light microscope images taken on polished cross-section disks of the crystal rods. (a) represents the as-grown (rapidly cooled) single crystals, and (b) shows the 1600°C annealed single crystals. As grown 12% HfO₂:Y belongs to the pure o-FE phase. The color contrasts, and fine features correspond to distinct crisscrosses of tweed domains at the outer part and single orthorhombic domain at the center of the crystal boule. As-grown 8% HfO₂:Y consists of the majority o-AP phase showing large 120°-type twin features due to the presence of different choices of cell-doubling. The mixed phases contribute to the complex color contrasts and local features in crystals after annealing.

Since the bulk single crystal gets rid of the influence of substrate materials, it provides great opportunities for investigating the intrinsic optical properties. In 2022, Shiyu et al. performed the Raman and infrared spectra on the HfO₂:Y bulk single crystals in cubic, polar *o*-, antipolar *o*-, and *m*-phases⁵⁴. The experimental data are highly consistent with the theoretical calculations, which introduces the phonon mode analysis into HfO₂ based system. Moreover, some of HfO₂ polymorphs show significant structure similarity, adding difficulty in distinguishing them by conventional diffraction methods, but this work proves that the phonon spectra could work as a supplementary method in characterizing the polymorphs in HfO₂-based materials by establishing a spectroscopic fingerprint for several different phases of HfO₂.

Concluding remarks

The successful growth of HfO₂:Y single crystals in kinetically stabilized *o*-phases also opens up various new experimental directions in the understanding of exotic ferroelectricity

in this material. In 2020, Hyun-Jae et al. proposed a localized polarization model in ferroelectric HfO₂ based on their calculations¹⁵. Therefore, experimental investigation of the possible flat phonon band is highly desired. The ferroelectric HfO₂:Y single crystals with a typical mass around several grams make the inelastic neutron scattering study of the phonon dispersion achievable. Considering the reported ferroelectric Y:HfO₂ bulk crystal and thickness-independent ferroelectricity in Y:HfO₂ films²¹⁷, a natural question would be: why Yttrium? Compared to other popular dopants in ferroelectric HfO₂ films, such as Si⁴⁺ and Al³⁺, the radius of Y³⁺ is much closer to Hf⁴⁺, which ensures good solubility in the bulk limit. That could be the reason why Y-doped ferroelectric HfO₂ samples tend to show minimized size dependence. On the other hand, this radius similarity may also bring a side effect, which is a relatively smaller orthorhombic distortion magnitude in Y:HfO₂. Consequentially, the reported ferroelectric polarization of bulk Y:HfO₂ and 1- μ m-thick Y:HfO₂ films are 6 μ C/cm² and 15 μ C/cm², respectively, which is smaller than the reported value in ferroelectric HfO₂ films with rare earth dopants having a larger radius, for example, 40 μ C/cm² in La:HfO₂.⁵³² In the future investigation of size-independent ferroelectricity in HfO₂-based materials, refinements of growth and annealing techniques and parameters to achieve a higher polarization in Y:HfO₂ is desired. Moreover, based on the discussion above, rare earth ions with a similar radius with Hf⁴⁺, such as Ho³⁺-Lu³⁺, are also promising dopants in the stabilization of size-independence ferroelectricity in HfO₂-based materials.

Last but not least, Yttrium-stabilized Zirconia (YSZ) is known to be a famous ionic conductor material due to the excellent Yttrium mobility at high temperature, and it has been widely used as thermal barrier coating layer material for gas turbine engines and the lining materials for high-temperature furnaces¹⁷³. A similar study of the ionic conducting performance of bulk Yttrium-stabilized Hafnia (YSH) in the high-temperature regime may extend the industrial application of HfO₂-based materials into new realms.

Acknowledgment

This work was supported by the center for Quantum Materials Synthesis (cQMS), funded by the Gordon and Betty Moore Foundation's EPiQS initiative through grant GBMF10104, and by Rutgers University.

5. Thin Film Growth

a. Metal-organic chemical vapor deposition (Takahisa Shiraishi)

Status

The crystalline phase-controlled HfO₂- and ZrO₂-based films are known to exhibit excellent ferroelectricity/antiferroelectricity even at a nanometer scale thickness and have been actively studied as potential candidates for applications to next-generation FE/AFE devices, such as FeRAMs, FeFETs, ferroelectric tunnel junctions (FTJs), supercapacitors, etc. Many research studies revealed that the origin of FE and AFE behaviors is several metastable phases with *o*-, *t*-, or *r*- symmetries. In addition, it was demonstrated that the stability of this crystalline phase strongly depends on the chemical compositions (doping concentration, ionic radius, valence state, and oxygen vacancy) and the structural characterizations (thickness, grain size, thermal and epitaxial strains, film/substrate interface, crystallographic orientation, and layered structure) of the films. Research has also been done to address several challenges in electrical properties, such as high E_c , low fatigue cycles, and weak P_r . Most efforts have been pursued on the materials side. On the other hand, given the continued miniaturization of FE/AFE devices and the current trend towards nanoscale electronics, it is necessary to develop deposition techniques that can adequately control the above factors affecting phase stability in the nanoscale film thickness range.

Metal-organic chemical vapor deposition (MOCVD) is still used today to produce high- k dielectric ultrathin films based on HfO₂ and ZrO₂. This is due to the good controllability of film composition and film thickness. In addition, MOCVD is suitable for uniform deposition not only on large-area Si wafer but also on substrates with three-dimensional shapes such as deep trench. This feature is very advantageous from the viewpoint of manufacturing next-generation FE/AFE devices. MOCVD is one of the effective approaches for designing HfO₂- and ZrO₂-based FEs/AFEs in the ultrathin region^{174,175}, but the understanding of the crystal growth science for realizing these films in MOCVD is still an open question. In addition, it must be thoroughly studied the deposition process to exploit the advantage of MOCVD. This section focuses on techniques for controlling the

structural properties of HfO₂- and ZrO₂-based FEs/AFEs via MOCVD, and some related research challenges are discussed below.

Current and future challenges

Epitaxial growth

Since the polarization axis differs for each metastable phase, it is critically important to control the crystallographic orientation of the HfO₂- and ZrO₂-based films in order to fully exhibit ferroelectricity and antiferroelectricity. In particular, an epitaxial growth technique, so-called metal-organic vapor phase epitaxy (MOVPE), is preferred for developing a fundamental understanding of growth mechanism, phase stability, doping and strain effects, domain structure and its switching behavior, electrical properties, etc. However, a comprehensive understanding of the growth phase diagram and the process window for each metastable phase is lacking. In addition, the effects of organometallic precursors and deposition conditions on the crystal growth of HfO₂- and ZrO₂-based FEs/AFEs remain to be studied in detail. Moreover, lowering the thermal budget required for film formation is also an important challenge, enabling the reduction of thermal damage during device manufacturing. Therefore, an understanding of the epitaxial growth process is required at the fundamental level throughout detailed studies of precursor adsorption, diffusion on the underlying electrode layer, nucleation, and growth rate as a function of deposition conditions via theoretical and experimental approaches focusing on the metastable phase. Another key to achieving orientation control is the selection of an underlying electrode layer, which promotes the oriented growth of the metastable phase. For example, indium tin oxide and lanthanum strontium manganite have been paid attention as epitaxial electrode layers to support the formation of orthorhombic and rhombohedral phases, respectively. The deposition of these epilayers by MOVPE is an interesting topic for the simplification of manufacturing processes of FE/AFE capacitors.

Pulsed-MOCVD

Layered structures (e.g., bilayer, multilayer, and superlattice) composed of HfO₂- and ZrO₂-based nanolayers are one of the unique approaches to improve dielectric, FE, and AFE properties, which can significantly enhance various device performances such as

endurance, fatigue recovery ability, storage capacity, etc. It is also possible to design the functions by combining multiple electrical characteristics. In the case of MOCVD, the layered structures can be achieved by introducing a pulsed deposition system. This system allows alternate delivery of each precursor onto the substrate, and the cycle is repeated to form layered structures. At that time, it is necessary to precisely control the composition of each layer. Until now, $\text{HfO}_2/\text{ZrO}_2$, HfO_2 -based/ ZrO_2 -based, and $\text{FE}-(\text{Hf,Zr})\text{O}_2/\text{AFE}-(\text{Hf,Zr})\text{O}_2$ have been studied. The next challenge of pulsed-MOCVD is multi-componentization, such as $\text{HfO}_2/\text{ZrO}_2/\text{CeO}_2$. The interesting topic is the control of constituent phases and electrical properties by utilizing the strain induced at the interface between layers. It is known that the piezoelectric response of superlattice structure is larger than that of film form. Since there has not been much research aimed at piezoelectric applications of HfO_2 - and ZrO_2 -based ferroelectrics, the development of layered structures opens up new possibilities for these materials. However, an understanding of the synergistic effect of each layer on phase stability and electrical properties is not fully available. In addition, this effect is highly dependent on the layer thickness, which is controlled by the supply time of each precursor. Tuning of the layered structure as a function of pulsed deposition system parameters is, therefore, essential for elucidating synergistic effects through microstructural analyses focused on interface conditions, polarization states, and defects.

High step coverage

Three-dimensional capacitors based on deep trench structures are widely used in ferroelectric memory devices. Adaptation of HfO_2 -based FE ultrathin films to this capacitor could make a breakthrough in the miniaturization of trench patterns and high aspect ratio. Polakowski et al. reported a P_r value per projected area of $152 \mu\text{C}/\text{cm}^2$ in $\text{TiN}/\text{Al}:\text{HfO}_2/\text{TiN}$ trench-type capacitor¹⁷⁶. Recently, FinFET with HfO_2 -based FEs has also been paid attention to as a three-dimensional capacitor. In the case of the fin field-effect transistor (FinFET), it is required to uniformly cover the elongated fin patterns with an ultrathin film. So far, the three-dimensional capacitors with HfO_2 -based FEs have been achieved only by ALD. Although MOCVD has great potential as a manufacturing technique for such capacitors, several challenges remain to be addressed. One is the formation of metastable

phases on the substrate with three-dimensional shape. This challenge requires an exploration of chemical composition to intrinsically improve the stability of the metastable phases. Another is the realization of high step coverage of the HfO₂-based ultrathin films and top/bottom electrodes. Precise control of the deposition conditions (e.g., the supply rate of sources, deposition temperature, and pulse sequence) is required to uniformly cover the trenches and fins. Understanding the convection of source gas within the chamber via fluid analysis helps establish the process window. The future challenge is the deposition on the metal substrate with various shapes. Since metal substrates are excellent in workability, they are easy to apply to FE devices with a three-dimensional structure. It is also expected to develop into devices that take advantage of the flexibility of metal substrate.

Concluding remarks

MOCVD is an important deposition technique impacting the ever-developing HfO₂- and ZrO₂-based FEs/AFEs field. This is because it yields unique results, such as excellent controllability of film thickness and chemical composition, design of the layered structure and electrical properties, and high step coverage. In particular, MOVPE helps to better understand the effects of doping, film thickness, strain, and crystallographic orientation on phase stability, enabling full exploitation of ferroelectric/antiferroelectric properties. However, the current situation is that the use in this material field has not progressed yet. With a detailed understanding of the fundamental factors such as deposition mechanism, growth phase diagram, process window, and pulsed system effect, MOCVD will give new avenues for next-generation FE/AFE devices equipped with HfO₂- and ZrO₂-based ultrathin films.

b. Chemical Solution Deposition (Hiroshi Uchida)

Status

Solution-based techniques have been used for several years for manufacturing FE thin films because of their technical advantages in designing simple and versatile film-deposition processes. The term “chemical solution process (CSD)” include some different type of solution-based processes for thin film deposition, such as sol-gel utilizing hydrolysis and polycondensation of metal alkoxides, metal-organic decomposition (MOD) using resources

of organic-acid salts, and other solution-based processes using various chemicals (β -diketonates, carbonylates, inorganic salts, etc.) as starting materials. These processes generally involve several simple steps, i.e., coating the precursor solution on a substrate, drying or pyrolyzing the solution to form a precursor gel film (amorphous), and annealing the gel film for crystallization. We argue that the process flow of CSD is compatible with chemical engineering, thus, favorable for industrial mass production such as a large-area film deposition on flat panel substrates.

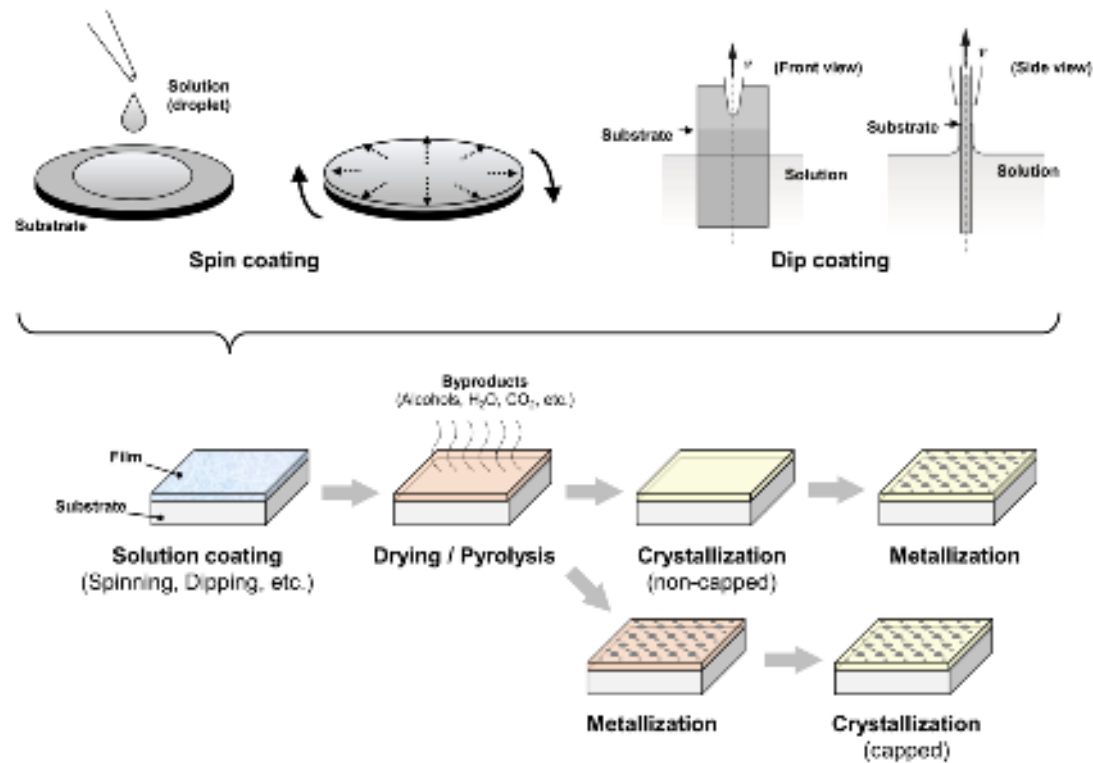

Fig. 7 Schematic image of chemical solution deposition. Process flows with non-capped (i.e., metallization after crystallization) and capped (i.e., metallization before crystallization) manners were shown, respectively.

The CSD process for FE thin films has been used for almost forty years, mainly for perovskite-type ferroelectric materials such as $\text{Pb}(\text{Zr},\text{Ti})\text{O}_3$ ^{177,178}, BiFeO_3 ^{179,180}, and layered-perovskites.^{181,182} The research and development (R&D) of CSD-derived ferroelectric films has been diverse, i.e., for processing routes and material properties of

film as well as for the circuit integration in miniaturized components (such as FE capacitors and FeFETs) and their circuit performances. The main targets of such research are non-volatile memory devices, piezoelectric sensors/actuators, and their advanced combinations, i.e., piezoMEMS, for commercial use. Due to this R&D, several FE devices have been commercialized and are available in our daily life. The research has also yielded commercial-grade equipment and precursor solutions for the CSD of perovskite-type FE materials.

Research on CSD-derived FE films recently has shifted to non-perovskite fluorite-type films since the finding of ferroelectricity in HfO₂-based solid solution systems.^{53,164} The first report by Starschich et al.¹⁸³ on Y-doped HfO₂ films prepared by the hybrid-type CSD route presented the film's ferroelectricity (with remanent polarization of >13 μC/cm²) together with their “wake-up” behavior and piezoelectric response. This research was extended to doped HfO₂ with various dopant elements (e.g., lanthanides, transition metals, and alkaline metals), as well as solid solution systems such as HZO^{74,184,185} and HfO₂-CeO₂ (HCO).¹⁸⁶ The CSD process supports the research on HfO₂-based FE films significantly because it is compatible with multi-component materials, enabling systematic survey on solid solution systems in the manner of combinatorial chemistry. The process mechanism of CSD has also been extensively investigated because solution-derived precursor films (amorphous) exhibit unique crystallization behavior to form the FE *o*-phase, which is somewhat different from the precursor films obtained from vapor deposition processes such as ALD, pulsed laser deposition (PLD) and sputtering.^{74,184} CSD processes has been used to fabricate FE circuits such as FeFETs or ferroelectric gate transistors (FGTs) in which FE HfO₂-based films are used as gate insulators.^{187,188}

Current and future challenges

Combinatorial research on doped HfO₂ has involved a variety of dopant elements (Y³⁺, La³⁺, Nd³⁺, Sm³⁺, Er³⁺, Yb³⁺, Al³⁺, Ga³⁺, In³⁺, Mg²⁺, Sr²⁺, Ba²⁺, Co²⁺, Ni²⁺ and Ca²⁺^{189,190,191,192,193}) to systematically organize the effect of dopant species on phase-formation behavior and FE properties. CSD be a good candidate as a combinatorial process based on chemical solution for material research on doped HfO₂ to survey the optimized composition of multi-component films in which the chemical composition of the resulting

films can be easily controlled by regulating the species and concentrations of solutes in the precursor solution. Research on doped HfO₂ will be extended to “co-doped” systems that include two or more dopant species, such as Y-doped HZO,¹⁹⁴ for addressing future challenges, i.e., stabilizing the FE HfO₂ phase, enhancing the P_r or P_s , and controlling their wake-up (or fatigue) behavior.

The crystallization mechanism of CSD-derived HfO₂ films has been extensively investigated because they can be subjected to the effects of any process factor (e.g., residual stress caused by byproduct removal and organic or carbon impurities included in the precursor gel films) compared with vapor deposition processes. For example, reports indicated that CSD-derived HfO₂-ZrO₂ films tend to exhibit optimum composition with the ZrO₂-rich region^{74,184}, which is somewhat different from HfO₂:ZrO₂ = 0.5:0.5 for ALD-derived films¹⁶⁴; it can occur due to in-plane tensile stress generated by the pyrolysis or crystallization process. The mechanism of phase formation in CSD-derived HfO₂-ZrO₂ films is also controlled due to the conditions of pyrolysis and crystallization (i.e., temperature, atmosphere, and pressure^{185,184,194}), which can be more significant than vapor deposition processes because of the presence of hydrocarbon impurities. Also, systematic data for the crystallization mechanism of doped HfO₂ films are reported in recent works^{189,193,192}, which discussed the thermal decomposition behavior of the precursor solutions to form final products based on thermal analysis. Comprehensive approaches will be considered for solving the problems related to process factors, i.e., designing starting chemicals (alkoxides, β -diketonates, organic acid salts, etc.) and solvents that enable complete removal or byproducts from the precursor films without residual stress.

The microfabrication process of FeFETs would be one issue of great importance for R&D of ferroelectric thin films. In the most recent studies, CSD is related to process flows of FeFETs in which the CSD-derived films of FEs (Y-doped HZO¹⁹⁴ and HCO¹⁸⁸ and ITO were used as the ferroelectric gate and oxide channel layers, respectively. They exhibited on/off current ratios of 10⁶~10⁷ and memory windows with hysteresis loops of I_D - V_{GS} curves. The HfO₂-based FeFETs were also integrated with paraelectric capacitors to form ferroelectric-gate controlled variable capacitors (Fe-V cap). For advancement to FeFETs with high-density or large-scale integration, the degree of integration and reliability of gate

operation will be critical issues for these applications, which can be achieved using the process mechanism of CSD as mentioned above.

Advances in science and engineering to meet these challenges

CSD will be used continuously for material research on HfO₂-based FE films in the future, especially for combinatorial surveys on multicomponent systems such as a “co-doped HfO₂“, owing to its flexible tunability during chemical composition. Almost all metals of alkaline, alkaline-earth, transition, and lanthanoid will be commercially available for such research as starting chemicals of these elements have been delivered for commercial use. One critical issue with the survey research is the concept of material models, i.e., how to choose the species of dopant elements for the research targets (e.g., phase stability and polarization). Combination with any sophisticated approaches through theoretical calculation (such as a DFT calculation) or statistical analysis (such as a mechanical learning algorithm)^{27,28,48} will assist greatly in preparing material models.

Also, to establish the position of CSD processes for commercial use, their essential problems related to byproducts or impurities must be overcome to maintain the reliability of circuit operation on fully integrated ferroelectric capacitors or FeFETs. The process design for the complete removal of organic species from precursor films (preferably before the crystallization step) without residual stress will be necessary furthermore for developing commercial-grade CSD processes. Although optimizing the process parameters for pyrolysis or crystallization is rightly an important approach for them, as clarified in previous research, other innovative actions, e.g., using designed chemicals (alkoxides or coordinate compounds with dissociable functional groups or ligands, etc.) and solvents (liquid media suitable for byproduct extraction including supercritical alcohol or CO₂ fluids,¹⁹⁵ etc.) for preparing the precursor solution of CSD, are also expected strongly.

Concluding Remarks

CSD has high compatibility with various situations of material synthesis, e.g., from lab-scale sample preparation for combinatorial surveys to the manufacturing process of FE components or devices for commercial use. It will be used differently compared with its technological counterparts, i.e., vapor deposition techniques such as ALD, PLD, and

sputtering because it has unique advantages (tunability of chemical composition, large-area deposition, process simplicity, cost, etc.) and problems (impurity, residual stress, step coverage, etc.), which are obviously different from those of the vapor deposition. Especially, R&D for multi-component HfO₂ systems such as co-doped HfO₂ ferroelectric films is one important role of the CSD process because it extends to other fluorite systems like multicomponent ZrO₂ or CeO₂ systems, which will contribute greatly to clarifying essential mechanism of ferroelectricity in fluorite systems.

c. Pulsed laser deposition (Florencio Sánchez/Ignasi Fina)

Status

Research of FE HfO₂ pivots around CMOS-compatible polycrystalline films. Pulsed laser deposition (PLD) is scarcely used to grow doped HfO₂ polycrystalline films^{196,197} even though the FE phase can be obtained with a low thermal budget¹⁹⁸. Commercial PLD set-ups allow large-area deposition on several inches wafers, but PLD is not suitable for 3D integration and thus does not compete with ALD. Instead, PLD is well suited for growing epitaxial films, which can be model systems for a better understanding of properties and prototyping devices.

Epitaxial growth of FE HfO₂ by PLD is generally performed at a substrate temperature around 700-800 °C and oxygen pressure around 0.01-0.1 mbar, without an annealing process^{12,199,200,19,201,202}. PLD is characterized by a very high instantaneous supersaturation and extremely fast crystallization after each laser pulse. This reduces the probability of chemical segregation and formation of secondary phases compared to other techniques.

Yttria-stabilized zirconia (YSZ) fluorite single crystals were first used as a substrate for epitaxial stabilization of the *o*-phase, usually on indium-tin oxide (ITO) electrodes. The doped HfO₂ films replicate the orientation of the YSZ substrate, (001), (110) or (111)^{199,203,204}. Perovskite substrates, in particular SrTiO₃(001) buffered with La_{0.67}Sr_{0.33}MnO₃ (LSMO) electrodes, are also used to grow doped HfO₂(111) epitaxial films^{12,200,19,205,206,207}. The FE phase stabilized epitaxially on LSMO is claimed to be rhombohedral¹⁹ or orthorhombic^{200,12}. In-plane and out-of-plane orientation can be

modified by using other substrate orientations^{208,209,210,60}. Stress engineering allows control of the phase formed, and films on LSMO buffered scandate substrates are almost pure orthorhombic and have a high P_r of around $25 \mu\text{C}/\text{cm}^{2211}$. Furthermore, HfO_2 films can be epitaxially integrated on Si(001) using buffer layers^{212,213,214,215}. The E_c of epitaxial films, unlike polycrystalline films, generally scales with thickness (t) according to the $E_c \propto t^{-2/3}$ dependence^{12,201}. PLD-grown epitaxial films rarely exhibit a wake-up effect, and some films present endurance of up to 10^{11} cycles^{12,216}. Retention is generally very high, and the retention - endurance dilemma that polycrystalline films show is not present²¹⁶.

Polycrystalline or epitaxial doped HfO_2 films have also been grown at room temperature by PLD or sputtering, and the FE phase is formed by annealing²¹⁷. Remarkably, polarization is high in films up to $1 \mu\text{m}$ thick, while polarization generally vanishes in other polycrystalline or epitaxial films thicker than a few tens of nanometers²¹⁷. In this case, E_c does not show thickness dependence.

The PLD plasma under low pressure is extremely energetic and can degrade crystal growth. Deposition in a mixed atmosphere of Ar and O_2 has made it possible to decouple plasma energy and oxidation conditions, and a great improvement of the polarization is obtained in low oxidation conditions (Fig. 8)²¹⁸. On the other hand, lattice strain seems to be less relevant than in conventional FEs. Free-standing epitaxial membranes have been obtained by chemical etching of the LSMO electrode²¹⁹. After etching, strain relaxes, and the (111) out-of-plane spacing of the initial rhombohedral unit cell reduces, resulting in an o - unit cell. Membrane bending does not affect the polarization, consistent with measurements of polycrystalline HfO_2 -based membranes.

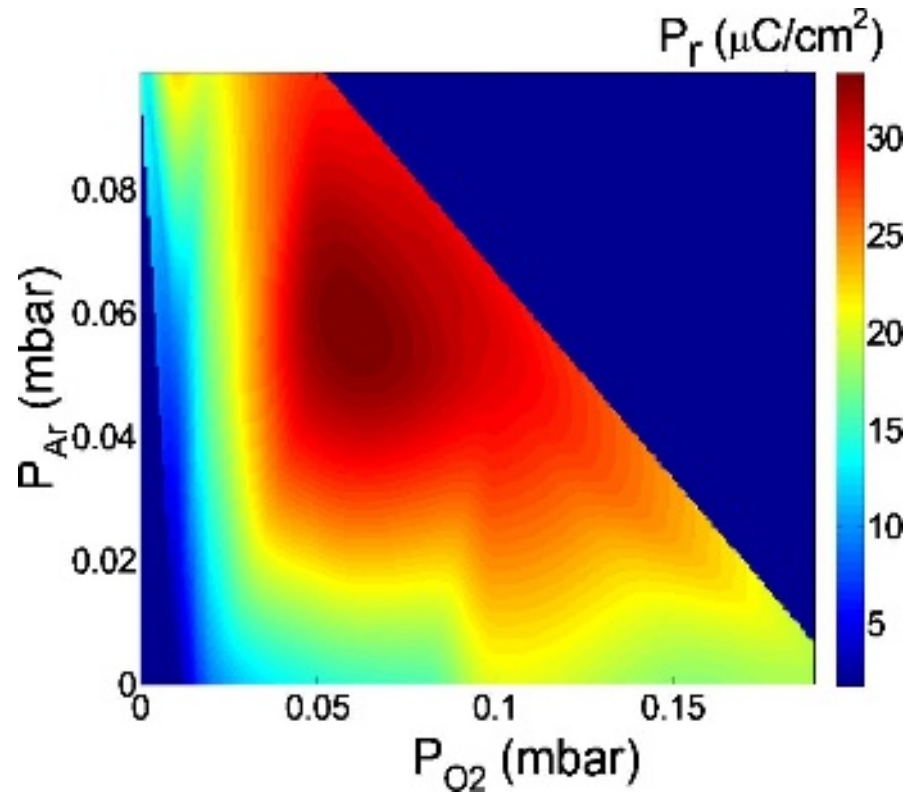

Fig. 8 Color map of P_r as a function of argon (P_{Ar}) and oxygen (P_{O_2}) pressure for $Hf_{0.5}Zr_{0.5}O_2(111)$ films deposited under a mixed Ar/ O_2 atmosphere. Adapted from ref. ²¹⁸.

Current and future challenges

As mentioned, the polarization is improved in films grown by PLD under low oxidation conditions. However, the impact of the expected oxygen vacancies on the microstructure and important properties such as reliability and switching mechanisms remains to be determined. On the other hand, the balance between thermodynamics and kinetics, critical in the synthesis of polycrystalline films²²⁰, is almost unexplored in PLD films, and only the variation of the deposition temperature has been explored²⁰¹. Very high polarization of about $50 \mu\text{C}/\text{cm}^2$ has been measured in epitaxial $Y:\text{HfO}_2(111)$ films on LSMO/STO(110)⁶⁰, which is much higher than the $30\text{-}32 \mu\text{C}/\text{cm}^2$ expected for pure orthorhombic films (111) oriented. It has been argued²²¹ that the measured polarization could contain extrinsic contributions related to oxygen migration as visualized by STEM characterization¹³⁹. On the other hand, epitaxial HZO(111) films on STO(110)²⁰⁹ or scandate²¹¹ substrates or on STO(001) using low oxidation deposition conditions²¹⁸ are almost free of parasitic phases, and its polarization is around $30 \mu\text{C}/\text{cm}^2$.

Lattice strain greatly affects the polarization of perovskite ferroelectrics, but its impact on the ferroelectric properties of HfO₂ is unclear. It is difficult to separate the effects of lattice strain from other factors, particularly the *o*-phase fraction. The P_r of epitaxial films increases with the presence of the *o*-phase, which is controlled by varying the oxygen pressure during the growth, the thickness, or the substrate. In addition, the P_r of epitaxial films on LSMO tends to increase with decreasing out-of-plane lattice parameters, which might indicate the presence of strain effects¹². However, P_r does not change with bending in flexible epitaxial HfO₂ membranes²¹⁹, although this latter result is not conclusive due to the limited explored strain range.

It is unknown why the *o*-phase is stable in films hundreds of nanometer thick, prepared at room temperature by PLD or sputtering, and crystallized by annealing²¹⁷. The contribution of surface energy is greater in films with small grains and non-columnar growth. Indeed, E_c of films prepared by solid-phase epitaxy or polycrystalline films prepared by other methods shows little thickness dependence²¹⁷, while it decreases with thickness in epitaxial films prepared by conventional PLD^{12,201}. It is also suggested²¹⁷ that the use of Y or another rare earth as a dopant is essential, but the exact mechanism remains to be understood.

Wake-up in polycrystalline HfO₂ films is believed to be caused by redistribution of oxygen vacancies and/or *t*- to *o*-phase transformation. It is dependent on doping (atom and concentration), but there is a scattering of results for a particular composition. Wake-up in HfO₂ is not yet well understood, and epitaxial films could be a convenient model system to investigate it. However, epitaxial films prepared by PLD show little or no wake-up effect. It would be of interest to introduce oxygen vacancies or use alternative electrodes with the aim of generating wake-up to obtain information through the correlation with a well-controlled microstructure.

Fatigue is recurrently observed in epitaxial HfO₂ films, and minimizing it is a primary objective. In ferroelectric perovskites, the replacement of metallic electrodes by conducting oxides allowed a large reduction of fatigue²²². HfO₂-based full epitaxial oxide capacitors have not yet been investigated. On the other hand, (111) oriented Hf_{0.5}Zr_{0.5}O₂ epitaxial films show less fatigue²²³ and faster switching²²⁴ with the presence of a *m*-phase than almost pure *o*- films. It would be of interest to evaluate fatigue and other functional

properties of epitaxial films that have other orientations, as well as monocrystalline films (without crystal variants).

Ultra-thin layers are used in tunnel junctions and nanolaminates. The thickness must be ideally homogeneous and controlled with atomic precision. These requirements cannot be met with polycrystalline samples. Epitaxial films may be flatter, but control of thickness at the sub-unit cell scale and over large areas is not yet achieved. In addition, the sharper interfaces produced by epitaxial films can be advantageous to understand device response in ferroelectric capacitors or transistors.

Advances in science and engineering to meet these challenges

PLD chambers in clusters that include an X-ray photoelectron spectroscopy chamber for characterization without air exposure are available. These can be useful to analyze the formation and distribution of oxygen vacancies and redox processes occurring when a top electrode is deposited. On the other hand, the control of oxygen vacancies in film prepared by PLD under mixed Ar/O₂ atmosphere²¹⁸ can help to determine the impact of vacancies on wake-up and fatigue. Epitaxial growth of LSMO or other conductive oxides, including ITO or other oxides with diverse functionality (ferroelectricity, ferromagnetism, etc.) on HfO₂ can also be of great interest to determine the possibility of improving endurance or investigating multifunctional properties in full epitaxial capacitors.

Growth rate directly affects the ratio between thermodynamics and kinetics, but its influence on *o*-phase stabilization in PLD-grown films has not been investigated. Furthermore, PLD growth is pulsed, and both instantaneous (thickness/laser pulse) and average (thickness/second) growth rate can introduce kinetic limitations.

Strain effects on polarization are not observed in epitaxial HZO(111) membranes upon bending. Another membrane orientation, particularly (001), could perhaps be more sensitive to bending. On the other hand, stabilization of the *o*-phase in epitaxial HfO₂/LSMO bilayers on Pb(Mg,Nb)O₃-PbTiO₃ (PMN-PT) or other piezo substrates would allow active control of strain. PMN-PT, with a lattice parameter similar to that of some scandate substrates, is expected to be a suitable substrate. The impact of crystalline orientation determined by substrate orientation on functional properties beyond

ferroelectric polarization should also help to the better understanding of properties. On the other hand, comprehensive electrical measurements could get insight into the possible coexistence of intrinsic polarization and extrinsic polarization related to oxygen migration^{60,139}.

Whether the robust ferroelectricity in films around 1 μm thick is caused by the dopant atom or by the particular microstructure of the films needs to be determined. Determining the thickness effects in HfO_2 films grown by conventional epitaxy and doped with Y and other rare earth elements would be relevant to discern whether the orthorhombic phase is indeed much more stable with a rare earth dopant. On the other hand, detailed microstructural characterization of a series of films with varied dependence of polarization with thickness could provide clues on the causes and suggest new growth strategies to achieve ferroelectricity in thick films prepared by other deposition techniques.

One virtue of FE HfO_2 is its robustness at the ultrathin limit, but precise control at such low thicknesses is difficult. PLD can be combined with reflection high-energy electron diffraction (RHEED) to monitor crystallinity, roughness, and formed phases, and even control of thickness with sub-unit cell accuracy in the case that epitaxial growth mode is layer-by-layer. Some HZO epitaxial films exhibit streaky RHEED pattern²²⁵. RHEED intensity oscillations, not yet reported, would allow unprecedented thickness control for ultrathin HfO_2 layers.

Concluding remarks

PLD has been demonstrated to be a highly effective technique for the epitaxial growth of ferroelectric HfO_2 with high homogeneity, flat surfaces and interfaces, and excellent functional properties (Fig. 9). Almost FE phase pure films can be obtained by epitaxial stress engineering or by deposition under a mixture of inert Ar and O_2 to induce oxygen vacancies. Wake-up is very low or null, and endurance up to 10^{11} cycles is limited by fatigue. Fatigue in full-oxide epitaxial capacitors remains to be investigated. Films hundreds of nanometers thick, grown at room temperature and crystallized by annealing, show high polarization.

The causes of this robustness are not determined. Strain effects on the polarization of HfO_2 are neither obvious nor discriminated from other factors. Advances in the fabrication of epitaxial membranes and stabilization of the ferroelectric phase on piezoelectric substrates could provide relevant information. RHEED-assisted PLD growth, rarely used to date for ferroelectric HfO_2 , could be used to grow highly homogeneous epitaxial orthorhombic films with the precise control of thickness needed in tunnel junctions and nanolaminates.

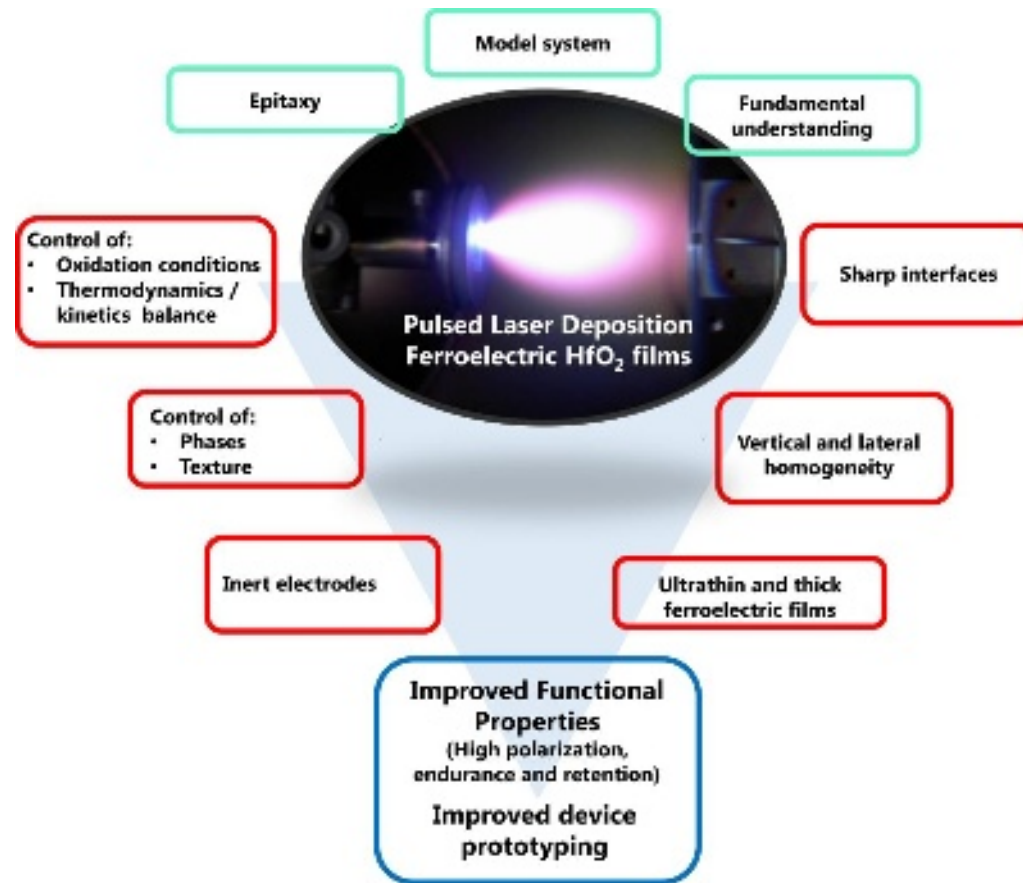

Fig. 9 Summary of current research and future challenges on the investigation of ferroelectric HfO_2 films grown by pulsed laser deposition.

Acknowledgments

Financial support from the Spanish Ministry of Science and Innovation (10.13039/501100011033), through the Severo Ochoa FUNFUTURE (project CEX2019-000917-S funded by MCIN/AEI), project TED2021-130453B-C21 funded by MCIN/AEI and European Union NextGenerationEU/PRTR, and projects PID2020-112548RB-I00 and

PID2019-107727RB-I00 funded by MCIN/AEI, and from Generalitat de Catalunya (2021 SGR 00804), is acknowledged.

d. Atomic Layer Deposition (Min Hyuk Park/Taegyu Kwon/Younghwan Lee)

Status

The discovery of ferroelectricity in Si:HfO₂ has attracted massive interest from researchers and industries to solve the longstanding challenges in FE-based memory applications, such as the 130 nm size limit in technology nodes and poor complementary metal-oxide-semiconductor (CMOS) compatibility.¹³ With this discovery, 28 nm technology node FeFET,²²⁶ 22 nm technology node ferroelectric fully depleted silicon-on-insulator (FDSOI),²²⁷ and 64 kbit FeRAM were demonstrated.²²⁸ Such rapid advances in FE HfO₂ are based on ALD. Notably, more than 85% (up to 2019) of the total publications focused on ferroelectric HfO₂ are made by ALD.²²⁹ ALD is a deposition technique that is based on sequential, surface chemisorption reactions between substrates, metal precursors, and reactants, as shown in Fig. 10a.²³⁰ Owing to its self-limiting nature and surface-saturated reaction, ALD provides numerous advantages, such as precise control of the thickness of film within the atomic level, excellent film uniformity, conformality, step coverage, and process compatibility, which makes it useful in the semiconductor industry.²³¹ Due to these advantages, ALD has been successfully implemented into the semiconductor industry mainly to deposit high-*k* materials (e.g., HfO₂) as a gate dielectric.²³² Further, to scale down the technology node to a few nanometers, depositing materials on a complex 3D structure such as FinFET²³³ and gate-all-around (GAA) FET²³⁴ homogeneously, uniformly, and conformally becomes even more important. Under such circumstances, appropriately employing the ALD in semiconductor processing is a viable option to meet the aforementioned requirements.

Current and future challenges

To be practically applicable, it is important for FE HfO₂-based devices to have reliable and uniform properties. Hence, for good reliability of FE HfO₂, properties such as less wake-up effect, high endurance, long retention, low leakage current, and high switching speed become important. It is known that the reliability of FE HfO₂ depends on the chemical,

crystallographic-structural, and microstructural properties of HfO₂ (e.g., crystallographic phase, grain size, defect, orientation), which are significantly affected by the ALD conditions. The uniformity in microstructural properties is even more important when the technology node reaches down to an atomic scale. It should be noted that in a 5 nm-thick HfO₂ film, only 10 unit cells of the HfO₂ crystal are stacked vertically. Thus, inhomogeneous film properties (e.g., high surface roughness, broad orientation distribution) throughout the surface would be a critical problem and lead to poor reliability.

The first challenge in ALD-deposited ferroelectric HfO₂ is to accurately control the chemical composition of the FE HfO₂. In ALD, the doping concentration is controlled by the relative ratio between the injection cycles of Hf and dopant precursors. The frequently reported number of dopant injection cycles for 10 nm-thick doped HfO₂ (except in the case of Zr-doping) is less than 5, suggesting that the FE properties are strongly affected by minute changes in growth per cycle (GPC). Moreover, based on the physical scaling trends, sub-5-nm films will be required in the near future, which implies that accurate composition control will become more challenging. The unintended doping effect arising from residual impurities or oxygen vacancies is another critical issue.^{235,236} It should be noted that the majority of the ALD-deposited FE HfO₂ employs organometallic precursors in which the metallic Hf is bonded with an organic ligand. The incomplete reaction during ALD is known to increase residual impurities (such as C, N, and H concentration). The residual impurities can act as trap sites in the electrical bandgap or pinning sites for DWs, which could deteriorate device performance.

The second challenge is to deposit a uniform film with a homogeneous orientation distribution to minimize the device-to-device variation in integrated circuits with FE memories and to improve compatibility with back-end-of-line (BEOL) processes. For the case of 1T-1C FeRAM, one solution is a strategic choice of bottom electrode considering lattice mismatch. For the case of FeFETs where the FE HfO₂ is directly grown on a Si substrate, there seems to be no clear solution. Although the report on ferroelectric HfO₂ with a preferred orientation thinner than 2 nm can be important progress,⁶³ there is no clear solution for physically scaling up its preferred orientation to the practical thickness range (~10 nm) with a suppressed leakage current. Achieving uniformity and homogeneous

orientation distribution will become more difficult when FE HfO₂ films are adopted for more complicated 3D nanostructures such as gate insulators of FinFETs or GAA FETs, 3D capacitors in FeRAMs, and 3D vertical FeFET arrays for post-NAND. Furthermore, it is not certain whether the preliminary results of the Si substrate can be applicable to poly-Si channels. Additionally, to be compatible with the BEOL processes, the entire process, including thermal treatment, should be conducted at a temperature lower than 400 °C. Although there have been reports on FE HfO₂-ZrO₂ films crystallized at <400 °C,^{237,238,239} given that the crystallization temperature generally increases with a decrease in film thickness, inducing ferroelectricity in the as-deposited film without subsequent annealing at sub-5-nm thickness regime is a promising strategy for the BEOL processes compatibility.

The third challenge is to achieve high-quality interfaces at electrodes or semiconductors because the performances of the nanoscale electronic devices are critically affected by the quality of the interfaces. In particular, in the ALD-deposited FE HfO₂, an oxygen source is required to oxidize the metal precursors by removing organic ligands. The oxygen sources such as O₃, O₂ plasma, H₂O, and H₂O₂ have been utilized for the ALD of FE HfO₂.²⁴⁰ These can cause chemical changes in FE HfO₂ as well as the bottom materials. For FeFETs, the interfacial or bulk traps formed at the gate stack interface have been a critical factor that limits the endurance of the device.²⁴¹ Although inserting a high-*k* interfacial layer such as SiO₂,²⁴² SiO_xN_y,^{243,244} Al₂O₃,²⁴⁵ and TiO₂²⁴⁶ has been suggested as a promising solution to improve the endurance of the device, adding another interfacial layer would increase the operating voltage of the devices, which is undesirable from the viewpoint of power consumption.

Advances in science and engineering to meet these challenges

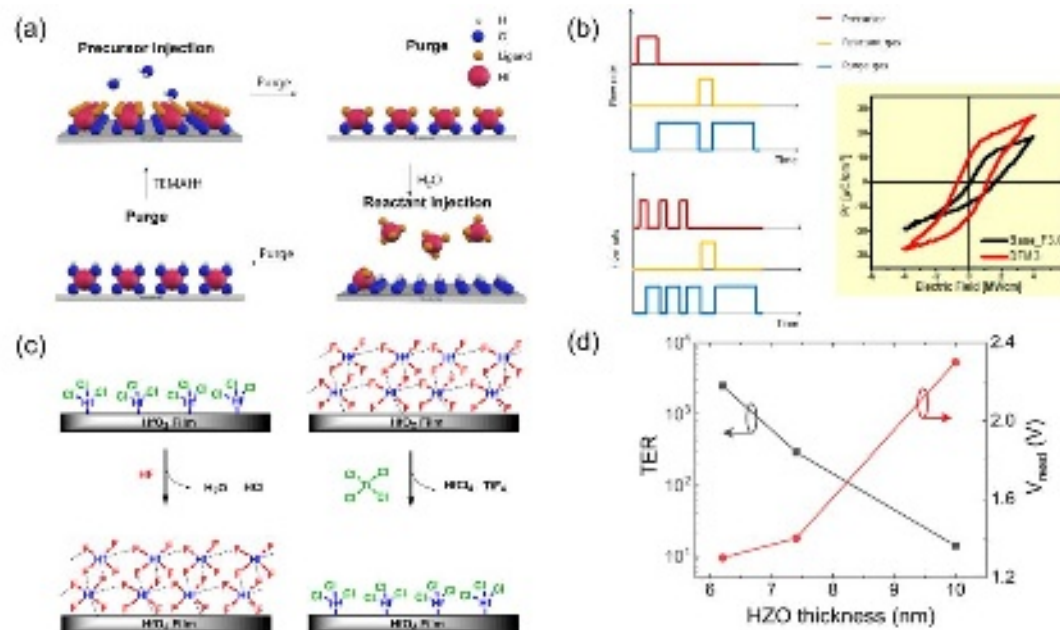

Fig. 10 (a) A general scheme of Atomic layer deposition (ALD) process for HfO₂ using Hf(N(CH₃)C₂H₅)₄ (TEMAHf) as the Hf precursor and H₂O as the reactant. Ligand refers to N(CH₃)C₂H₅. (b) Comparison of conventional ALD process and discrete feeding (DF)-ALD process scheme (left) and the polarization-electric field hysteresis (right) of 6 nm thick Hf_{0.5}Zr_{0.5}O₂ film sandwiched by TiN top and bottom electrodes, where the Hf_{0.5}Zr_{0.5}O₂ films were deposited using conventional ALD (black curve) and DF-ALD (red curve). The hysteresis curve is reproduced from ²⁴⁷ under a CC by 2.0 license. (c) A process scheme of atomic layer etching consisting of fluorination (left) and ligand exchange (right) steps. Reproduced from ²⁴⁸ with permission. Copyright 2022, American Vacuum Society. (d) Giant tunneling electroresistance and lowered read voltage are observed for atomic layer etched Hf_{0.5}Zr_{0.5}O₂ film with 6.2nm thickness. Reproduced from ²⁴⁹ with permission. Copyright 2022, American Institute of Physics.

Reducing the device size is a significant goal for the nanoelectronics industry; therefore, the production of metal oxide films with dimensions below the sub-nanometer scale is important. Recent research on sub-nanometer HfO₂-based FEs by Cheema et al. in 2022 supports the importance of reducing the device size.⁶² This reduction can be achieved by the newly-designed ALD processes explained below. It has been reported that discrete

feeding ALD (DF-ALD), which is the repetition of the precursor half-cycle procedure before the reactant half-cycle, could increase the surface coverage and lower the surface roughness by promoting monolayer-by-monolayer growth.²⁵⁰ The schemes of the conventional ALD (left top panel) and DF-ALD (left bottom panel) are compared in Fig. 10b. Similar to replacing the second precursor half-cycle, the DF-ALD cycle from a Hf/Zr precursor to the dopant precursor enables a homogeneous distribution of a dopant across the film.^{251,252} Kim reported that adopting DF-ALD could effectively increase the P_r , especially for the cases of ultra-thin films under a low thermal budget and the polarization-electric field curves of TiN/Hf_{0.5}Zr_{0.5}O₂/TiN capacitors, where the Hf_{0.5}Zr_{0.5}O₂ films were grown using conventional ALD (black curve) and DF-ALD (red curve), are shown in the right panel of Fig. 10b.²⁴⁷

Atomic layer etching (ALE) would be a potential solution to resolve the issue with the crystallization of ultra-thin HfO₂-based ferroelectric films. A scheme of ALE of HfO₂ film can be shown in figure 10c. Firstly, a HfO₂-based thin film can be deposited to a depth suitable for low-temperature crystallization (thickness of ~5-10 nm). Subsequently, the film can undergo atomic layer etching with accurate and uniform thickness control, which may lead to the formation of ultra-thin crystallized films with smoother surfaces. Hoffmann et al. reported that the device performance of FJT with Hf_{0.5}Zr_{0.5}O₂ ultra-thin film could be enhanced by adopting ALE.²⁴⁹ Figure 10d shows the changes in tunneling electro-resistance ratio (TER) of the FTJ and read voltage (V_{read}) of their FTJ with varying thickness of Hf_{0.5}Zr_{0.5}O₂ thin film. Area-selective ALD (AS-ALD) is another emerging technology that enables nanoscale patterning with reduced chemical or physical damage compared to that from a conventional dry etching process. This procedure was demonstrated for a dielectric HfO₂ film by Tao et al. in 2010. With regards to the improvements in 3D memory technology, such as 3D NAND, adopting the ALE and AS-ALD approaches for ferroelectric memory technology would be vital for progress in this field.

Finally, engineering the ALD process can also provide viable methods to control the interfacial properties of thin films. The recently suggested HfO₂/ZrO₂ nanolaminate would be an effective way to improve the electrode/ferroelectric or semiconductor/ferroelectric

interfaces.^{253,254} Plasma pre-treatment of the bottom electrode or the substrate is a promising method to engineer the lower interface because the initial growth stage after ALD is strongly affected by the concentration of reactive surface functional groups such as $-\text{OH}$.²⁵⁵ Furthermore, the fabrication of the entire MFM stack without breaking the vacuum in a single ALD chamber, known as sequential, no-atmosphere processing (SNAP), would provide a chemically sharp interface.^{256,257} These advances can be effective solutions to achieve reliability in thin film production without inserting additional high-k interlayers.

Concluding remarks

The well-established ALD of HfO_2 has enabled rapid advances in HfO_2 -based ferroelectrics, and it is known that the chemical and structural properties of FE HfO_2 films are critically affected by the ALD conditions. There are several technical challenges, such as (1) accurate control of chemical composition, (2) deposition of uniform and adequately-textured films with BEOL-compatible processes, and (3) high-quality interfaces at electrodes or semiconductors. Although these challenges persist even in the ~ 10 nm thickness regime, they will be more difficult due to the current trend of physical scaling-down and applications in 3D nanostructures. Thus, extensive research and development to resolve these issues are required to develop practical semiconductor devices based on ferroelectric HfO_2 . Development of new metal precursors, emerging ALD techniques such as discrete feeding DF-ALD, SNAP ALD, and AS-ALD, and various wet/dry surface treatment techniques²⁵⁸ could be exemplary approaches.

Acknowledgment

This work was supported by the National Research Foundation (NRF) funded by the Korean Ministry of Science and ICT (Grant no. 2022M3F3A2A01073562, 2020R1C1C1008193, and 2021M3F3A2A02037889). We would like to thank Editage (www.editage.co.kr) for editing and reviewing this manuscript for English language.

e. Sputtering (Bertrand Vilquin)

Status

A sputtering deposition is a physical vapor deposition generally carried out in a low-pressure atmosphere (pressure lower than 0.1 mbar). A cathode sputtering setup is at least a secondary vacuum chamber with a target (material to be deposited) and a substrate holder. Gas flow detectors and DC or RF generators are needed to create and control the electrical discharge of a plasma. The deposit may relate to metals or ceramics. The principle of cathode sputtering consists in generating a plasma formed mainly of high-energy ions (often ionic argon), which will sputter the target and eject atoms from it. The atoms and ions created will then be deposited on the substrate, which can be heated or not. The sputtering process will allow controlling of the film quality by playing on the target nature (metallic, ceramic), plasma pressure and composition (reactive sputtering), DC/RF power applied to the target.

In comparison to ALD grown FE HfO₂, few reports on the sputtering-grown samples have been undertaken so far. Various elements can be used as dopants by sputtering to lead to ferroelectricity in HfO₂ films: Sc, Y, Nb, Al, Si, Ge, and Zr dopants²⁵⁹. We can note that the thicker FE HfO₂ film (up to 1 μm thick) was obtained by sputtering Y doped HfO₂ target²⁶⁰. Moreover, sputtering of pure HfO₂ at different target powers leads to FE *o*-phase after appropriate annealing²⁶¹. Identically, using ion beam sputter deposition, ferroelectricity can be obtained in pure ZrO₂ with *r*-phase^{262,263} or *o*-phase²⁶⁴.

In this present review article, we focus on the zirconium doping of HfO₂. The sputter process shows several contributions compared to ALD, such as room temperature deposition, very low carbon contamination, non-equilibrium deposition, cost, possibility of growing the entire MFM stack inside the same system in one run, avoiding surface and interface air contamination. In comparison to ALD, it seems that it is possible to easily get the FE *o*-phase at lower dopant concentrations¹⁶⁸. The authors claimed that the species intermixing is improved by sputtering. For all the publications, deposition by sputtering is performed at room temperature on TiN-buffered silicon and followed by a post-deposition annealing. Room temperature deposition enabled growth on different substrates, such as 2D semiconductor MoS₂²⁶⁵. For the majority of articles on sputtering deposition, the post-

deposition annealing temperature in order to obtain the *o*-phase is often higher than with ALD, in the range 600°C-900°C¹⁶⁸. Several explanations can be proposed: less presence of adjuvants such as carbon in order to decrease the crystallization temperature, room temperature deposition leading to a more amorphous state when the ALD process is performed around 250-300°C. Bouaziz et al., however, were able to decrease the thermal budget to 450°C with P_r rising 20 $\mu\text{C}/\text{cm}^2$ after wake-up cycles³²⁶⁶. Hachemi et al. also found an *o*-phase crystallization temperature of about 370°C, but the annealing was not performed in a rapid thermal annealing system but *in situ* with very low heating and cooling rates²⁶⁷.

Current and future challenges

Different sputter chamber configurations are used: metallic Hf/Zr single target for reactive sputtering²⁶⁸, ceramic HZO single target^{266,267}, and co-sputtering from HfO₂ and ZrO₂ single targets, which is the most used set-up²⁶⁹. Indeed, co-sputtering enables to control of more parameters, especially the zirconium dopant concentration, by tuning the ZrO₂ target power^{270,271,272,261}. Ferroelectricity is then found for Zr doping concentration from 0% to 50%. Single target sputtering does not allow film composition modulation: one target for one film composition. The Zr and Hf deposition rate is target aging dependent, with possible evolution of the Zr/Hf ratio deposition after deposition, leading to a sputtering repeatability problem. Besides, the use of the metallic Hf/Zr single target only leads to FE films with low P_r : 6 $\mu\text{C}/\text{cm}^2$ after wake-up cycling⁶²⁶⁸. This low value can be explained by the difficulty of very well controlling the film stoichiometry by reactive sputtering. On the contrary, in the case of ceramic HZO single target sputtering, sputtered and nanostructured films can reach, at a low thermal budget of 450°C, a remanent polarisation of 20 $\mu\text{C}/\text{cm}^2$, an endurance to 1.10^7 cycles, a reducing wake-up effect, and a long-term retention^{266,273}.

Sputtering enables to perfect control as well as engineering the interface between the ferroelectric HZO film and its electrodes by introducing a very thin metallic layer^{274,275}, leading to an increase of the P_r at the lowest thickness of 6 nm by tuning the oxygen vacancies in the film.

The first important parameter to control the growth of FE HZO films is the deposition plasma pressure. Bouaziz et al. demonstrated the strong impact of the working pressure on the film's structural and physical properties²⁷⁶. Indeed, the deposition pressure will modify the mean free path and scattering of sputtered species. Low-pressure deposition (5×10^{-3} mbar) led to the formation of an as-deposited *m*-phase. After post-deposition annealing, the *m*-phase proportion increased without the formation of *o*-phase whatever the annealing temperature between 400°C and 600°C (Fig. 11). For as-deposited film grown at high pressure (5×10^{-2} mbar), the film is then amorphous. After annealing, the film transformed into *m*- and *o*-phases with polarisation loops (Fig. 12). The microstructure, such as grains size and crystallinity and the chemical composition in the sputtered films may be modified by the deposition pressure. Small grains induced more likely the formation of the *o*-phase.

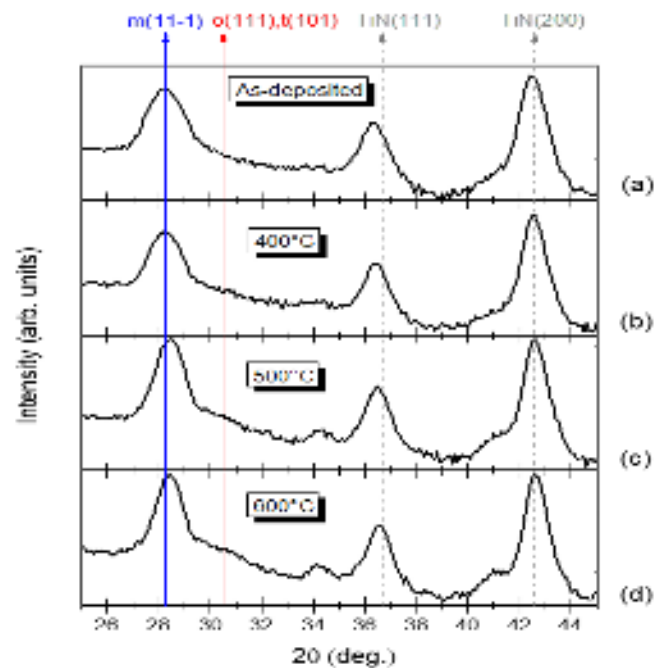

Fig. 11 GIXRD of low-pressure samples grown at 5×10^{-3} mbar: as-deposited and annealed at different temperatures. Adapted from ²⁷⁶.

This is the author's peer reviewed, accepted manuscript. However, the online version of record will be different from this version once it has been copyedited and typeset.

PLEASE CITE THIS ARTICLE AS DOI: 10.1063/5.0148068

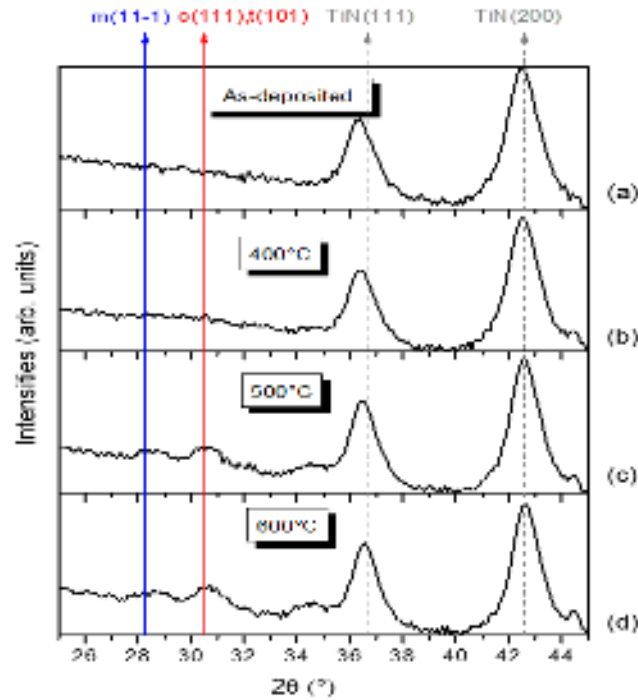

Fig. 12 GIXRD of high-pressure samples grown at 5×10^{-2} mbar: as-deposited and annealed at different temperatures. Adapted from ²⁷⁶.

Lee et al. also observed that tuning the deposition pressure can enhance the sputtered film properties²⁶⁹.

The second parameter which can modify the properties of the sputtered FE HZO films is the partial oxygen pressure during the deposition. Oxygen pressure can also have a huge effect on the grains size, the deposition rate, and the film density because of the re-sputtering effect, which is more common during reactive sputtering²⁶⁹. Lee et al. then observed a variation of the monoclinic/orthorhombic intensity ratio on their GIXRD patterns correlated with the ferroelectric properties: increasing the oxygen partial pressure led to forming more *m*-phase and to decrease the P_r of the HZO film. In fact, the most favorable condition in order to optimize ferroelectricity is to sputter under pure argon, allowing the presence of oxygen vacancies in the film²⁷².

Finally, the third parameter to tune is the single HZO target applied power, which has an influence on the deposition rate but not the Hf/Zr ratio inside the film²⁶⁷. Since the power may modify the film microstructure (strain, grain size, etc.), it will change the *o*-/*m*-phases

volume ratio²⁶¹: low power favored the *m*-phase when higher pressure leads to an increase in the fraction of the *o*-phase.

The current goal is also for the ALD polycrystalline ferroelectric HfO₂ films to fix the problems of wake-up and switching endurance. One available solution will be to dope HfO₂-ZrO₂ with La, as already shown with ALD²⁷⁷. Nevertheless, growing multi-cationic films by sputtering will need hard and complex deposition control. Another main current challenge is to produce epitaxial FEs as it is already performed by PLD as shown in a previous section. This will require heating the monocrystalline substrate during the deposition in order to promote the epitaxial growth.

One major future challenge is that, to date, no realization by sputtering of 1T-1C and 1T FeFET prototypes was presented in the literature, but one can notice the first articles of sputtered ferroelectric HZO films were published several years after ALD ones, and very few groups use up to now this deposition process in comparison of ALD.

Concluding remarks

Sputtering allows to fabricating of state-of-the-art polycrystalline FE HZO films on a silicon substrate (large scale, high polarization values, composition homogeneity, low roughness surfaces, and abrupt interfaces with electrodes, interface engineering) similar to those elaborated by ALD. Besides, this room temperature growth process is CMOS compatible with a low thermal budget and allows to control the film composition, including oxygen vacancies and device microstructuration. However, as it is impossible to realize 3D conformal depositions, advanced industrial applications, like FinFET, will be limited.

f. Molecular Beam Epitaxy (Athanasios Dimoulas)

Status

Molecular Beam Epitaxy (MBE) in ultra-high vacuum (UHV) relies on molecular flow, so it offers the possibility for thin film growth far from equilibrium, thus enabling the crystalline growth of metastable phases, which are difficult to obtain by equilibrium crystal growth (bulk or other) methodologies. As a UHV method, MBE offers excellent contamination control and in-situ surface preparation of crystalline substrates, which

enables epitaxial growth of chemically pure thin films. Due to UHV conditions, several surface characterization techniques such as RHEED/LEED, STM, XPS can be used to in-situ monitor, in real-time, the interface and thin film surface ordering, the possible reaction at the interfaces, the stoichiometry and the thickness with atomic precision. Being essentially a PVD methodology, MBE does not require cumbersome and time-consuming precursor development, so it stands out as a flexible technique for fast screening and exploration of new materials, including FE HfO₂.

A typical oxide MBE system consists of a UHV chamber suitable for FE HfO₂ growth which is equipped with e-gun evaporators necessary for the co-evaporation of refractory Hf and Zr metals (Fig. 13). An important component of the growth system is a remote RF plasma source which takes O₂ gas as input and by creating a plasma, produces neutral atomic oxygen beam. The latter is reactive enough to oxidize Hf and Zr on the substrate at low temperature and under conditions of low partial pressure PO₂ ~ 10⁻⁵ Torr, compatible with UHV. The RF source can also produce an atomic N beam; therefore, it is possible to grow the oxides HZO and nitrides (TiN) in sequence without breaking the vacuum. This is particularly important since TiN is considered to be the optimal top gate electrode, so the full device layer structure can be produced in one growth step.

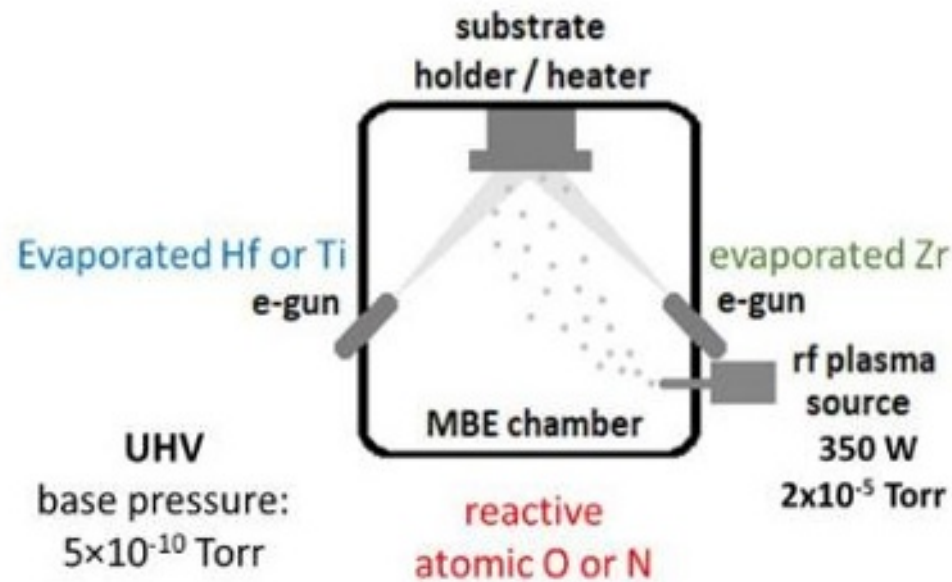

Fig. 13 Typical Oxide MBE chamber used for the growth of HZO and HZO/TiN stacks.

MBE can be used in principle with any substrate or template. However, MBE is particularly suitable for the growth on technologically important single crystalline semiconductor substrates (Si, Ge, GaAs) to take advantage of established in-situ cleaning methodologies by thermal desorption of native or chemical oxides, assisted, when necessary, by ion Ar+ sputtering. Other crystalline metallic or semiconducting oxides (e.g. LSMO, NSTO) can be used as substrates for MBE growth. Oxide MBE is particularly suitable for the epitaxial growth of epitaxial n-STO on Si(001), which can be subsequently used for the HZO overgrowth.

While oxide molecular beam epitaxy has been extensively used for the growth of perovskite oxides, it has been rarely employed for the growth of FE HfO₂-based oxides. The main reason is that the thermodynamic/kinetic path of FE HfO₂ formation requires deposition at low temperatures in the amorphous state first, followed by annealing for the crystallization of the material in the desired orthorhombic polar phase. Therefore, most of the works are limited so far to the growth of amorphous HZO at relatively low temperature (~ 120 C) by plasma-assisted molecular beam deposition (PA-MBD), rather than epitaxy.

Current and future challenges

PA-MBD has been employed for the growth of HZO on Ge substrates^{278,279,280}, which produces oxide-free interfaces. Germanates formed at the interface during deposition of HZO on Ge are unstable, and they dissociate, yielding sharp, clean interfaces as evidenced by HRTEM²⁷⁸. PA-MBD HZO leads to thin films down to 3 nm, with exceptional thickness uniformity over the entire cm-scale wafer. HZO Ge MFS devices made by PA-MBD^{279,280} exhibit robust hysteresis loops with high remanent polarization P_r up to 30 $\mu\text{C}/\text{cm}^{2278}$ in the pristine state with no need for wake-up when HZO is thicker than 10 nm²⁸⁰. However, as HZO thickness scales down, the pristine P - V loops appear to be constricted (or pinched), showing an AFE-like behavior with much reduced P_r ²⁸¹.

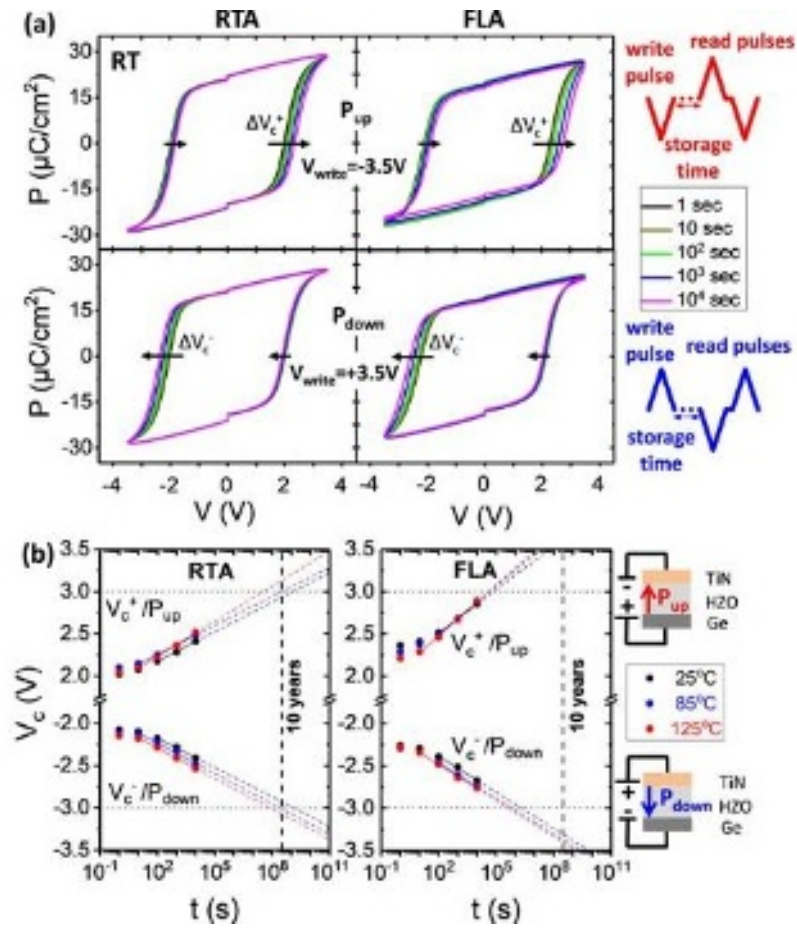

Fig. 14 TiN/HZO/Ge MFS devices fabricated by PA-MBD, showing very small imprint and good reliability.

This behavior is interpreted as the effect of an enhanced depolarization field which results in metastable ferroelectricity co-existing with a stable paraelectric phase²⁸¹. The ferroelectricity recovers with full hysteresis loops by field cycling (wake-up) attributed to the filling of pre-existing interface defect traps via charge injection from the metal electrodes²⁸¹. The woken-up metal-ferroelectric-semiconductor (MFS) devices maintain a high P_r ($>20 \mu\text{C}/\text{cm}^2$) down to 5 nm HZO which makes PA-MBD HZO useful for low voltage/low power applications²⁸¹. PA-MBD HZO presents a pure *o*- FE phase with no evidence of a monoclinic phase based on XRD and HRTEM observations. This could explain the high values of P_r obtained in MBD HZO. Also, the use of reactive atomic oxygen and nitrogen in MBD results in efficient oxidation and nitridation, thus minimizing the oxygen vacancies at the interface, which could explain the very small imprint (Fig. 14) and very good reliability observed in TiN/HZO/Ge MFS capacitors²⁸⁰. While MBD has

been successfully applied for the realization of HZO Ge FMS capacitors with robust FE hysteresis, the performance of Ge FTJ and FeFET memory devices is not as expected. The root cause of underperformance in Ge FeFETs²⁸² is thought to be a large density of dangling bond acceptor states at the interface, which are present despite the fact that HZO/Ge is a sharp, crystalline interface. These defects strongly pin the Fermi level near the valence band, and when filled by electrons, they exert excess scattering on mobile charges in the channel. As a result, Ge p-channel FeFETs fabricated by MBD show a degradation of the transfer characteristics (I_d - V_g) upon programming of the ferroelectric gate, suffering from an increased subthreshold slope and reduced ON-current which also limits the memory window to about 0.3 V²⁸². Proper passivation of the electrically active interfacial defects is necessary to improve the transistor characteristics. Since hydrogen passivation is ineffective in Ge, other methodologies, such as S passivation by immersion in sulfur-based solution, should be considered. The best passivating layer could be an ultrathin GeO₂ (< 1 nm), which can be formed after thin HZO deposition by oxygen plasma post-oxidation of Ge, a methodology that is fully compatible with PA-MBD. A similar method has already been successfully applied for the passivation of Al₂O₃ high-k gate stacks on Ge for advanced CMOS²⁸³.

Advances in science and engineering to meet these challenges

While PA-MBD has already proved its strengths for the growth of FE HZO on Ge substrates, using this technique only as a deposition method of amorphous HZO does not exploit its full capacity as plasma-assisted molecular beam epitaxy (PA-MBE). The real value of the latter method is for the epitaxial growth of HZO on any substrate and in particular, on semiconductor substrates. There are several reports of epitaxial growth by other PVD-based techniques or by PLD, which are discussed in recent review articles^{284,152,285} as well as in other sections of the present roadmap. To the best of our knowledge, there is no report on the epitaxy of FE HfO₂ by PA-MBE. Following successful epitaxial growth by PLD¹⁹ of *r*-FE HZO on LSMO and the recent epitaxial growth of Y:HfO₂ on LSMO/STO substrate⁶⁰, a future task is to use PA-MBE to grow high crystal quality FE HZO on oxide conductive substrates which serve as the bottom electrodes. It is particularly interesting to grow directly on n-STO semiconductor substrate

This is the author's peer reviewed, accepted manuscript. However, the online version of record will be different from this version once it has been copyedited and typeset.

PLEASE CITE THIS ARTICLE AS DOI: 10.1063/5.0148068

since STO has been used successfully in combination with conventional epitaxial BTO and BFO perovskite FE in high-performance FTJs with giant TER²⁸⁶. The hope is that good epitaxial quality HZO directly grown on STO substrates by PA-MBE will improve the performance HZO-based FTJ NVM beyond the current state of the art. The hope is that good epitaxial quality HZO directly grown on STO substrates by PA-MBE will produce high-performance HZO-based FTJ NVM, which are lacking today. Using PA-MBE it would be possible to control the crystal phase, crystal orientation with respect to the growth direction, and the thickness of FE HfO₂ down to 1-2 nm, the latter being very important for the performance of FTJs. This is particularly important in light of the recent discovery of emergent ferroelectricity in ultrathin (<2 nm) Zr:HfO₂¹¹ and ZrO₂⁶² as a result of reduced dimensionality⁶². The most attractive feature of using STO as a substrate is that this material can be grown epitaxially on Si(001) by PA-MBE with a 45 deg in-plane rotation and with very good crystalline quality²⁸⁷. Moreover, by combining O₂ partial pressure and post-growth annealing, a controlled concentration of oxygen vacancies can be created, which acts as an effective n-type doping. Therefore, it is possible to obtain in-situ, an n-type STO semiconductor bottom electrode directly on silicon and subsequently overgrow HZO and the top electrode in one growth run in the same UHV chamber by PA-MBE without breaking vacuum. However, the “holy grail” of epitaxial ferroelectrics is to achieve epitaxy directly on Silicon substrates which facilitates the fabrication of important devices such as FeFETs or FTJs and their integration with Si CMOS at the FEOL. While attempts have been made by PLD²⁸⁸ for the direct epitaxy of HZO on Si, this material may not be the best choice due to lattice mismatch with Si, the reaction at the interface, and the complex thermodynamic phase diagram that renders it difficult to access the correct ferroelectric phase under the constrictions of epitaxy.

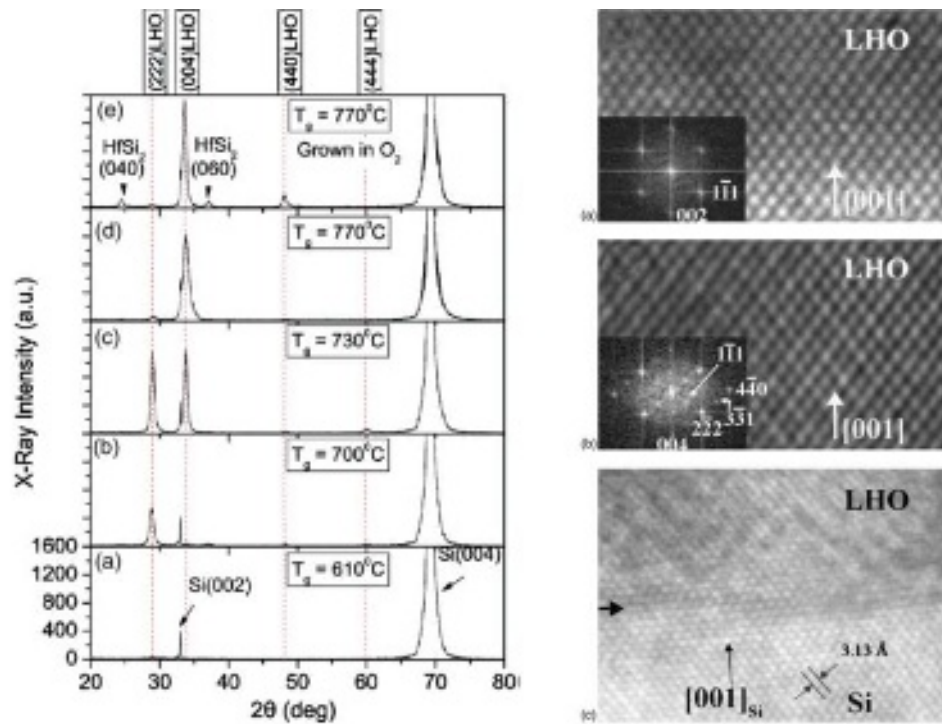

Fig. 15 Pyrochlore $\text{La}_2\text{Hf}_2\text{O}_7$ on $\text{Si}(001)$ grown by PA-MBE, showing cube-on-cube epitaxy and sharp, clean interfaces.

A good choice is the stoichiometric $\text{La}_2\text{Hf}_2\text{O}_7$ which can be obtained either in the ordered fluorite phase known as pyrochlore or in the random fluorite phase, which is lattice-matched with Si. In our team, we have demonstrated²⁸⁹ that this material can be grown by PA-MBE at 770 °C on Si (001) substrates showing cube-on-cube epitaxy and clean/sharp interfaces (Fig. 15). Although the pyrochlore phase is centrosymmetric (cubic, space group symmetry $Fd3m$), therefore non-polar, the possibility that a metastable FE phase can be accessed via strain, doping, thickness and annealing, as in the case of FE HfO_2 , cannot be excluded. Doping $\text{La}_2\text{Hf}_2\text{O}_7$ by Zr, in analogy with doping HfO_2 with Zr, could be one way to go in the search for a possible metastable ferroelectric state. The isostructural $\text{La}_2\text{Zr}_2\text{O}_7$ is an alternative material to be investigated. In fact, ferroelectricity in frustrated $\text{La}_2\text{Zr}_2\text{O}_7$ pyrochlore grown by sol-gel on (110)-oriented STO has already been reported²⁹⁰. It would be a future target to grow epitaxial $\text{La}_2\text{Zr}_2\text{O}_7$ on Si or other substrates by PA-MBE with the aim to obtain the ferroelectric state. It should be noted that amorphous LaHfO_x (or La-doped HfO_2) has been adopted by key chip manufacturers to adjust the threshold voltage of

nMOS in advanced CMOS. Moreover, La-doped (~9%) HZO has been developed to improve the endurance of ferroelectric capacitors and the remanent polarization²⁹¹. Therefore, La incorporation in HZO is compatible with ferroelectric HZO and Si technologies which facilitates its entry into the epitaxial ferroelectric oxides research in the future.

Concluding Remarks

Most of the work so far has been performed using plasma-assisted molecular beam deposition at low temperatures to produce amorphous HZO, followed by crystallization annealing to obtain the FE *o*-phase. Very good FE material has been produced on Ge substrates with clean interfaces and pure *o*-FE phase showing high P_r , with the minimum required wake-up in thick (10 nm) films. Ferroelectricity is maintained down to 5 nm with very good P_r , which however, is obtained after extensive field cycling. Functional p-channel FeFETs on Ge substrates have been realized. The biggest challenge at present is to use PA-MBE to produce epitaxial ferroelectrics mainly on Si substrates with expected enhanced ferroelectricity to enable integration with Si circuits. Possible metastable phases of La-containing Hafnium- and Zirconium-based oxides with the pyrochlore or fluorite structure are good candidates since their epitaxial growth has already been demonstrated and evidence of ferroelectricity in the Zr-based compound has been published.

6. Characterization and Properties

a. Dopants (Hiroshi Funakubo/Takao Shimizu)

Status

Constantly obtaining the FE phase is crucial in harnessing ferroelectricity for stable device performance. The FE phase is reported to be obtained even from pure HfO₂ and ZrO₂ composition without intentionally doping. However, element doping is widely recognized to be very useful for the reproducible generation of FE phases. In fact, a huge volume of studies in terms of the ZrO₂ ceramics, used as high-toughness ceramics and oxygen ion conductors, and high-*k* dielectric materials suggest that the doping element is quite effective for tuning the symmetry of fluorite oxides. A wide variety of dopant elements has

been employed for the stable appearance of ferroelectricity, which is mainly induced in HfO₂, including not only cation dopants (Mg, Sr, Ca, Ba, Al, Lu, Er, Nd, Ga, Sm, Fe, Sc, Gd, La, Y, Ce, Ge, Si, and Zr), but also anion dopant, such as N²⁵⁹. As listed, divalent, trivalent, and tetravalent cations appear effective for forming the FE phase. In contrast, doping of higher valence dopants has hardly been reported.

HfO₂-ZrO₂ system have been most widely investigated due to the stable ferroelectricity around Zr/(Hf+Zr)=0.5, whose composition range is wider than other dopants in case of around 10 nm in thickness. The wide available composition range is an advantage for the ALD process because stable ferroelectricity is obtained against composition fluctuation. However, the obtained phases are sensitive to the process conditions. In addition, the available composition range decreases with increasing film thickness, and ferroelectricity cannot be observed above 60 nm in general because of the stable *m*-phase formation²⁹².

Doping of SiO₂ or AlO_{1.5} to HfO₂ is also widely investigated due to the good compatibility with the CMOS process because well-mature sources for CVD and ALD processes are available. In fact, the first demonstration of ferroelectricity was performed with Si. The composition range for ferroelectricity, which is typically several percent, is smaller than that of ZrO₂ case.

The alkaline earth elements and rare earth elements have been extensively used for tuning the crystal symmetry of ZrO₂ ceramics. By imitating this, various elements are adapted for also FE applications. In most cases, several percent of elements are effective for ferroelectricity, similar to Si and Al. However, doping a relatively large amount of LaO_{1.5} and CeO₂ (< 20%) is reported to show ferroelectricity, but the available composition range is still smaller than Zr case, which is generally over 20%.

Current and future challenges

There are many trials for the overall understanding of the dopant effect on the generation of FE phase from both experimental and theoretical approaches.

Due to recent progress in computational DFT studies, many researchers conducted theoretical calculations for the effect of doping. For example, Batra et al. calculated a doping effect of a wide variety of elements to stabilize the FE phase for HfO₂. The

formation energy of the ferroelectric *o*-phase is reduced by introducing the alkaline earth elements and rare earth elements that have been ascertained experimentally to obtain the FE phase. One of the fundamental issues of such a theoretical calculation approach is that the FE phase is generally not the most stable phase, namely, not the ground state. Other research groups have also reported similar results.

Interestingly, Yang et al. reported a significant reduction in energy difference between the most stable *m*-phase and the FE *o*-phase by Si and La doping, which have the smallest and largest ionic radii within their study²⁹³. Wu *et al.* also reported the reduction of formation energy for the FE phase, together with the non-polar *o*-phase and the *t*-phase, by inducing Si²⁹⁴. They emphasize the importance of a kinetic mechanism for forming the ferroelectric phase from the *t*-phase by taking into account entropy. Thus, the dopants do not stabilize the FE phase alone, and other factors might aid it. Further development in a theoretical study is needed to understand doping effects fully.

The kinetic mechanism is also confirmed by Park et al.^{295,220} and Tashiro et al.¹⁷⁰ The common understanding is that the FE phase is formed from the high-temperature *t*-phase on cooling. The dopants prevent the formation of the most stable *m*-phase by reducing the formation energy of metastable *o*- and *t*-phases. This kinetic mechanism mimics the formation of *t*- polycrystalline ZrO₂, which is well-studied by doping Y or Ce²⁹⁶. According to the kinetic formation mechanism, thicker films (~1 μm) and even bulk single crystals have been grown by Y doping. This is in contrast to the HfO₂-ZrO₂ system and doping cations with small ionic radii, by which ferroelectricity can be obtained only in thin films.

Experimentally, the local environment of the dopants is also an important challenge in elucidating the doping effect. In particular, trivalent or divalent dopants favor oxygen vacancies to maintain charge neutrality. The interaction between the dopant and induced defects is quite interesting regarding the ferroelectric properties and reliability. A recent computational study proposes reducing the energy barrier for polarization switching by doping the cations with small ionic radii, such as Si and Ge²⁹⁷. Their calculation shows that the local distortion due to reduced coordination number would decrease the energy barrier for polarization switching. This study is quite interesting because most studies on the doping effect have aimed at stabilization of the *o*- phase, i.e., an increase in polarization.

Experimental studies concerning practical issues, enhancement in reliability, or reduction of E_c is desired.

Advances in science and engineering to meet these challenges

One of the challenges of doping into HfO₂ FEs is tuning and improving FE properties, particularly enhancing endurance properties and decreasing E_c . Recently, Kozodaev *et al.* reported that La doping into Hf_{0.5}Zr_{0.5}O₂ improves endurance properties up to 10¹¹ cycles without the involvement of fatigue and hard breakdown²⁹⁸. Similarly, co-doping of rare earth elements (La and Y or La and Gd) into Hf_{0.5}Zr_{0.5}O₂ enhances the endurance property. The latter study speculates that the local structural distortion of the lattice contributes to improved endurance²⁹⁹.

It is also an important challenge to clarify the local environment of dopants and also the host Hf and Zr elements in the FE phase in scientific and engineering views. However, most films with small thicknesses include tiny amounts of dopants because the volume and concentration of dopants are small. Recent advances in the thicker films ($\sim 1\mu\text{m}$)²¹⁷ and bulk single crystals²⁴ would provide a better signal ratio to noise. In addition, the progress in the measurements and analysis would provide informative studies.

Most studies, particularly computation-based theoretical studies, assume that dopants are incorporated into the HfO₂-ZrO₂ solid solution. However, rapid phase segregation has been known for doping the elements with small ionic radius, such as Si and Al, into the bulk HfO₂ or ZrO₂. In fact, it is reported that the Al tends to agglomerate during the thermal treatment process, and this agglomeration results in enhanced ferroelectricity. Such a nanoscale diffusion process would also be important for understanding the doping effect³⁰⁰.

It has been revealed that the simple understanding that the dopants lead the HfO₂ materials to the *o*- FE phase is difficult. Thus, modeling with kinetic dynamics is required to clarify the formation of the FE phase with dopants, including the diffusion of the elements at the nanoscale. The molecular dynamics simulation with DFT-based potential would be one of the approaches to predict the formation phase in practical conditions³⁰¹. In addition, recent progress in machine-learned potential would provide fast computing.

Concluding remarks

Various dopants in HfO₂ are effective in producing ferroelectricity. However, a total understanding of the doping effect has not been established yet. The kinetics during the process of forming the *o*- FE phase is crucial to clarify the doping effect. Advanced in experimental and theoretical studies, and their combination is needed. In particular, thick films and single crystals provide powerful tools to investigate the local structure of dopants. Recent studies regarding reduction in E_c and enhancement in endurance are interesting next steps beyond the studies aiming at preparing the FE phase. Data scientific methods such as machine learning and high-throughput experiments should be adapted for optimization of the dopants elements and concentration, including co-doped systems.

Acknowledgments

This work was supported by the MEXT Initiative to Establish Next-generation Novel Integrated Circuits Centers (X-NICS) Grant Number JPJ011438, MEXT Program: Data Creation and Utilization Type Material Research and Development Project Grant Number JPMXP1122683430, and MEXT KAKENHI Grant Numbers 19H00758, 21H01617, and 22K18307. This study was supported by the MEXT Leading Initiative for Excellent Young Researchers and a research grant from the Murata Science Foundation.

b. Defect engineering (Nick Barrett)

Status

The successful integration of FE HfO₂ into high-performance, ultra-low power CMOS compatible memory and logic depends not only on suitable material properties but also on engineering these properties in order to optimize device performance. Key performance indicators are imprint, wake-up, fatigue, and leakage, all of which are intimately linked to the material and device responses to field cycling and, more generally, to environmental and processing conditions.

Atomic scale defects play a central role in determining not only the basic material properties but also their response to and evolution under electrical or thermal stress and field cycling. Defects can be generated during growth and by the formation of chemically

and electrically distinct interface layers. Their distribution may change during cycling, presenting new challenges in terms of real device performance.

The effective processing window for reliable device operation must therefore take into account not only the magnitude of P_r but also the evolution of imprint, wake-up and endurance kinetics and leakage.

Defect control is potentially a fruitful path towards device reliability of industrial standards. Here we will focus on engineering oxygen vacancy defects since they play a key role in both material properties and device performance³⁰² although other point defects, including carbon, nitrogen or hydrogen, as well as complex defects may also contribute³⁰³ and should be the subject of more complete studies.

Oxygen vacancies influence both resistive and FE switching in HfO₂-based materials and are therefore of importance for two emerging non-volatile memory technologies (resistive random access memories (RRAMs) and FeRAMs)³⁰⁴. However, there is potentially a fundamental contradiction between FE memories which depend on the insulating nature of the HfO₂ whereas resistive memories require a low conductance state usually provided by oxygen vacancy filaments. It is therefore necessary to locate a sweet spot in the oxygen vacancy concentration for FE applications.

Initial oxygen vacancy distribution in as-processed hafnia layers can vary sharply over typical film thicknesses (~ 10 nm), providing a strong imprint field. This skews the polarization-field hysteresis loop and narrows the operational memory window by altering asymmetrically the threshold voltages. Uniformization of the defect distribution and defect recombination can significantly reduce the imprint during the wake-up process, as suggested by the model presented by Pesic et al.¹⁶⁷ (panel (a)). Initial oxygen vacancy redistribution can give rise to a strong wake-up effect, opening the memory window. Field cycling into the fatigue regime results in a jump in oxygen vacancy density and a concomitant increase in leakage current determined by trap-assisted tunneling and closure of the memory window³⁰⁵.

Thermally stimulated depolarization current measurements have quantified activation energies for oxygen vacancy migration. The high values suggest that imprint may be due to

charge trapping at defect sites rather than the charged defects themselves³⁰⁶. The trap levels then become the important parameter. Indeed, *ab-initio* simulations of defect structures and modeling of transport and FE properties have provided useful insight into the role of different defect species as charge traps and go some way to explaining the experimental fatigue and leakage current data³⁰⁷. Thermally activated migration of oxygen vacancies at room temperature is unlikely, but mobility under strong electric field has been reported¹³⁹. Although the kinetics are slow, the field-induced mobility may be important in determining wake-up and fatigue regimes.

First attempts at engineering the oxygen vacancy levels have been achieved by the insertion of an ultra-thin Ti layer to favor oxygen scavenging²⁷⁴. Modest oxygen scavenging gives a higher remanent polarization by favoring *o*-phase nucleation, but too high an oxygen vacancy concentration leads to higher leakage and earlier breakdown, i.e. lower endurance.

Oxygen vacancy ordering into more complex defect structures may also contribute to the enhancement of FE properties. It has been suggested that modest vacancy concentration could be used to favor up to 80% of the *o*-phase, which could then be stabilized by subsequent re-oxidation.

Current and future challenges

A major challenge is the direct measurement of the oxygen vacancy concentration. This should be as model independent as possible, although the model calculations of vacancy mobility¹⁶⁷, charge transport³⁰⁸ and imprint, wake-up, and fatigue³⁰⁶ have provided valuable insights. Charge-based interpretations of data on oxygen vacancy concentrations are challenging since neutral defects are more difficult to identify, potentially underestimating the true defect concentration.

A second challenge is that direct measurement of the oxygen vacancy distribution in a HfO₂ based capacitor or FeFET requires both lateral and depth resolution on the scale of the devices as well as time-dependent analysis of relaxation, field cycling, and switching.

X-ray Photoelectron spectroscopy (XPS) is gaining in popularity based on the assumption that oxygen scavenging and the creation of oxygen vacancies give rise to reduction of Hf cations^{309,310,311}. Reduced Hf carries a clear spectroscopic signal which can be quantified in

terms of vacancy concentration, as shown in panel (b). The tunable depth sensitivity of photoelectron spectroscopy, on length scales similar to the typical hafnia film thickness, provides a handle to measure the concentration profile rather than just an average measurement over the film thickness. This is crucial information to be correlated with, for example, the evolution of imprint with field cycling. Depth sensitivity can be tuned by varying the photoemission take-off angle or the photoelectron kinetic energy. Photoelectron spectroscopy in the presence of a top electrode allows quantifying the polarization and field cycling dependence of the Schottky barrier height and hence the probability of leakage and charge injection (panel (c)). The latter can be a further factor in determining defect concentration³¹².

The disadvantage of classical XPS using standard laboratory sources is that the depth sensitivity is limited to ~ 5 nm. This precludes the use of a realistic top electrode whose thickness would extinguish the signal coming from the underlying hafnia and excludes the possibility of operando experiments to follow in-situ the oxygen vacancy evolution as a function of field cycling.

There are two ways of circumventing the top electrode obstacle. One is mechanical or chemical thinning or removal of the top electrode³¹⁰, allowing to plot of the oxygen vacancy concentration profile generated by oxygen scavenging. However, this must be done carefully to avoid damaging the underlying HfO_2 by low energy ion beam³¹³.

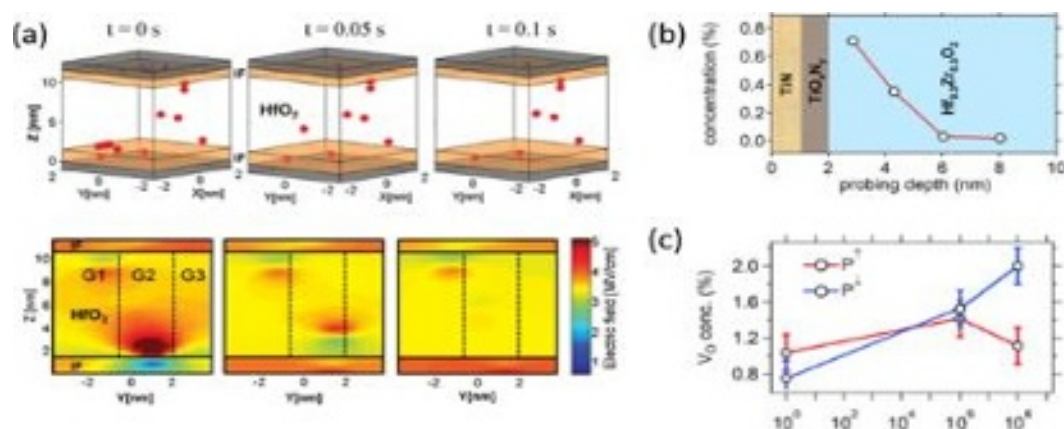

Fig. 16 (a) Simulated device wake-up and corresponding field evolution on field cycling at 4 MVcm⁻¹ with permission ¹⁶⁷ (b) oxygen vacancy profile as measured by XPS. With 82

*permission*³¹¹ (c) Oxygen vacancy concentration near the top interface as a function of field cycling and polarization state. With permission³¹⁰.

Hard X-ray photoemission (HAXPES) offers a non-destructive solution to probe through realistic electrode thicknesses thanks to the improvement in depth sensitivity by one to two orders of magnitude^{309,310,314}. HAXPES has been used to directly measure the oxygen vacancy concentration profile in the vicinity of the top TiN/HZO interface due to oxygen scavenging³¹¹. It has also provided invaluable information on the vacancy concentration near the bottom electrode as a function of oxygen-rich or oxygen-poor processing conditions, allowing insight into the process engineering of defects³¹⁵.

Advances in science and engineering to meet these challenges

The increased availability of HAXPES beamlines makes such analyses more accessible; however, they remain the exception due to the six-month lead-time for experimental proposals. Typical beamtime allocations are usually not more than one week. For industrialists requiring characterization of imprint retention and endurance, this is a major obstacle.

One possibility would be a proprietary HAXPES beamline, possibly in conjunction with a Glancing angle X-ray diffraction (GIXRD) set-up in order to carry out on-demand operando chemical and structural characterization of realistic memory devices. Physical modeling to inform decisions for industrial development requires reliable and statistically significant data. Typical field cycling at 100 kHz requires one day for 10^{10} cycles without taking into account relaxation or measurement times. Several weeks are therefore necessary for a full operando characterization of the oxygen vacancy behavior as a function of polarization, switching speed, and field cycling of a single device. A comparative study integrating different processing conditions³¹⁶, rapid thermal annealing temperatures, solder reflow conditions in order to address packaging criteria, therefore requires several months access. A broad consortium from academia and industry could afford such an option.

A complementary alternative would be the acquisition of recently commercialized laboratory HAXPES set-ups using high-energy X-ray sources, either Cr or Ga. The Ga

source (delivering X-rays at 9.25 keV) appears best adapted since the Ti spectra do not show interference in the core level region. The major advantage of these set-ups is the absence of lead-time, and their stability allows longer acquisition times made necessary by the lower flux compared to a synchrotron beamline³¹⁷.

The second major challenge concerns the spatial resolution on the scale of real devices and, ultimately, typical domain sizes. The latter is extremely challenging but state-of-the-art transmission electron microscopy (TEM) have demonstrated the role of electrode chemistry on the vacancy generation and kinetics¹³⁹. However, TEM cannot provide reliable information on length scales $\sim 0.1 - 1.0$ nm. Complementary techniques operating on different length scales must be developed. Photoemission electron microscopy (PEEM), providing decananometric spatial resolution in microscopic fields of view, allows, for example, characterization of \sim nm scale devices and has demonstrated the capacity to quantify oxygen vacancy concentration as a function of polarization state and cycling history³¹⁸.

However, these analysis techniques are still in their infancy and require optimization in sample structuring as well as the use of higher energy photons sources to secure electrode quality.

The third challenge is the implementation of time resolution over a wide range of time-scales in order to characterize how point defect engineering can optimize switching and retention. Typical switching times targeted for HfO₂-based devices are 10-50 ns. This is well suited to pump-probe photoemission experiments synchronizing voltage generator with synchrotron radiation pulses³¹⁹. Although not new, it has yet to be implemented for ferroelectric hafnia because reliable switching data also requires small device to avoid prohibitive leakage currents. Slower kinetic processes have also been reported, including defect migration, relaxation, as well as defect and dopant dependency^{320,321}. The defect concentration and profile determines the trap-assisted tunneling current, correlated with the onset of the fatigue regime and therefore device endurance³⁰⁵. Determining the energy levels of the trapped electrons with respect to the conduction band will allow refining the quantitative physical modeling.

The field is wide open and calls for considerable effort.

Concluding remarks

In the decade following Böschke's first paper in 2011, the understanding of the material properties of ferroelectric hafnia has made significant progress. The increasing need for low-power digital autonomy has proposed the integration of FE HfO₂ into current electronics to the forefront of emerging technology candidates. Nevertheless, the performance metrics required to be considered as a serious technological alternative must still be met. To do so requires a demonstration of the capacity to reliably engineer and optimize the same material properties. There is no short cut and advanced characterization platforms, including the techniques outlined here, with rapid access and throughput, are necessary.

c. Interface engineering (Jacob L. Jones/Younghwan Lee/H. Alex Hsain)

Status

Interfaces discussed in this section are limited to those created when two dissimilar materials are grown or placed adjacent to one another, e.g. through sequential deposition of two films. Unlike ferromagnetics, where no additional contact is needed for measuring their magnetic properties, FEs such as HfO₂ require contacts, or electrodes (at minimum), for measuring important properties such as polarization. Thus, interfaces are inevitable in FE HfO₂ devices, and their careful design and synthesis is necessary to maximize device performance.

Interfaces of interest in HfO₂-based devices are those created between: 1) the FE film and the top electrode, 2) the FE film and the substrate, and 3) additional interfaces formed within the HfO₂ film, e.g. through superlattices or layering.

FE HfO₂ is often created as a MFM structure in which metallic electrodes are in contact with FE HfO₂ at both top and bottom sides. Because most metals are strong reductants, an additional metal oxide layer at the interface of the MFM device is inevitably made, where the interfacial layer acts as an additional capacitance in series. Although this interfacial layer (or dead layer) can be detrimental to certain device properties, there can also be benefits to adding an intentional interfacial layer on the properties of the FE HfO₂-based film, i.e. creating a Metal-Ferroelectric-Insulator-Metal/Semiconductor (MFIM/S)

structure. For example, adding an oxide layer such as ZrO_2 ³²², Al_2O_3 ³²³, TiO_2 ³²⁴ and $\text{La}_{0.67}\text{Sr}_{0.33}\text{MnO}_3$ (LSMO)²¹¹ below the FE HfO_2 introduces the ability to alter the crystallization behavior, stabilization specific phases of HfO_2 , or promote texturing or epitaxial growth.

In the MFM structure, HfO_2 has been combined with many types of electrodes, including TiN ^{325,326,327,310}, TaN ^{328,171}, W ^{329,330}, Pt ^{330,150,331}, RuO_2 ^{332,333,334} and IrO_2 ^{335,336}. Despite a wide array of electrode options, the most commonly employed electrode in combination of HfO_2 hafnia is TiN due to its oxygen-gettering nature, which yields oxygen vacancies in HfO_2 . Oxygen vacancies are linked to both the stabilization of the *o*-phase of HfO_2 as well as the wake-up effect in which a redistribution of defects during cycling produces a variable P_r value^{337,167}. TiN also possesses a larger thermal expansion coefficient than HfO_2 , a mismatch that may produce a tensile strain during annealing, which could facilitate stabilization of the FE HfO_2 phase. A recent study provides even more correlation between the thermal expansion coefficients, stresses, and FE properties in MFM capacitors, demonstrating that lower electrode thermal expansion coefficients lead to higher tensile stress and enhanced ferroelectricity³²⁹.

Current and future challenges

The propensity of TiN to act as an oxygen sink when in contact with an oxide is a primary challenge in engineering of TiN/HfO_2 interfaces. Many researchers have employed strategies such as the use of interlayers to better stabilize the HfO_2 -electrode interface, i.e. creating MFIM/S structures. Recently, Zhao *et al.* modeled FE HfO_2 interfaced with Al_2O_3 , La_2O_3 , SiO_2 , GeO_2 , and other oxides to better understand the electronic structure and the resulting asymmetric oxygen distribution-induced polarity³³⁸. Yadav *et al.* investigated the use of oxygen-deficient IrO_x interlayers to reduce the interlayer formation and oxygen vacancies at the interface, which led to enhanced $2P_r$ and wake-up free behavior³³⁹. Mizutani *et al.* used a cerium oxide capping layer on Y-doped HfO_2 to increase the endurance limit from 10^7 to 10^{10} cycles³⁴⁰. Mizutani *et al.* attributed the increased cycling endurance due to CeO_x , which acts as a buffer layer that can absorb or supply O atoms during heat treatment and/or electric field cycling. Despite the potential benefits of interlayers, such as improved endurance and reduced leakage^{341,342}, a major challenge of

incorporating a dielectric layer in series with a FE is the resultant loss of retention in the device. Alcalá *et al.* showed that a La_2O_3 interlayer in an HZO capacitor accelerated the retention degradation process due to the depolarization fields that arise from the dielectric interlayer³⁴³. Future interfacial engineering strategies are aimed at considering device properties such as endurance, leakage, and reliability concurrently in concert with one another³⁴².

Controlling the microstructure of HfO_2 -based films poses a challenge for device scaling and integration, given that the grain size and crystal structure are strongly coupled in HfO_2 -based films³⁴⁴. For example, Kim *et al.* inserted an additional 1-nm thick dielectric Al_2O_3 layer in the middle of a 40 nm thick HZO to control the grain size and obtained a P_r of $10 \mu\text{C}/\text{cm}^2$, which was 11 times larger than that of single HfO_2 layer of equivalent thickness³⁴⁵. Kim *et al.* suggested that by insertion of Al_2O_3 into the middle of HZO, it was possible to interrupt the grain growth and prevent the formation of the deleterious m -phase, which is favored at larger grain sizes.

Process design will also inevitably influence the HZO/TiN interface characteristics where parameters such as the selection of oxygen source and dose times or the layering sequence in HZO films have been found to alter the local chemistry and structure of films. For example, Hsain *et al.* showed that a stronger oxidizer O_2 plasma, compared to H_2O , promoted a more pronounced TiO_x interlayer between HfO_2 and the electrode, which had a beneficial impact on improving the endurance of HZO capacitors³⁴⁶. Walters *et al.* employed the use of a sequential O_2 - H_2 plasma oxidation method which was shown to produce asymmetrical shifts in the coercive fields during retention measurements, likely due to the growth of additional interfaces of TiO_xN_y ³⁴⁷. Hsain and Lee *et al.* also showed how pre-deposition vacuum breaking can increase the carbon concentration within HZO films and stabilize the t -phase²⁵⁶.

For films containing multiple cations such as HZO, superlattice layering within the film is another strategy to control the interfacial structure and properties. For example, Park *et al.* explored the impact of superlattices of HfO_2 and ZrO_2 on resulting FE properties. Importantly, they report that the starting layer could strongly influence the crystallization kinetics and subsequent phase stabilization in the FE layer³⁴⁸. Zhao *et al.* further showed

that layering superlattices of ZrO₂ and HfO₂ using 10 s dose time of O₂ plasma generated a high P_r of 25.5 $\mu\text{C}/\text{cm}^{2349}$.

Advances in science and engineering to meet these challenges

One way to mitigate deleterious interfacial effects is to maintain vacuum during the deposition of the electrode and HfO₂ films. As stated earlier, the breaking of the vacuum when transferring samples between different tools causes increased carbon contamination and metal oxidation, neither of which can be well controlled. Instead, maintaining a vacuum can minimize these otherwise uncontrollable processes. In 2018, Wei et al.¹⁹ reported the sequential deposition of LSMO and HfO₂ via PLD without breaking the vacuum. Electron microscopy and spectroscopy confirmed an excellent quality of the interface. As a more scalable process, Lee et al.²⁵⁶ reported the processing of electrodes and HZO in MFM capacitor geometries via ALD within the same tool without breaking the vacuum. Their process, called sequential, no-atmosphere processing (SNAP) was demonstrated on TiN/HZO/TiN stacks and resulted in devices with wake-up-free FE performance and unexpectedly high P_r (27 $\mu\text{C}/\text{cm}^2$). The improved performance was attributed to limited oxidation and carbon contamination of HZO/TiN interfaces.

Moving forward, advances in controlling atmosphere exposure between the deposition of distinct layers may prove effective at providing new ways to control interfacial characteristics. This may include, e.g., the use of SNAP in other deposition processes (e.g., physical vapor deposition) or the use of controlled gas and time exposures between the deposition of certain layers.

As the influence of defects can exacerbate the properties of interfaces, it is also critical to understand and control the source and purity of starting materials. While often overlooked in early-stage research, source purity is important in both the research environment, where variables across research labs are often unknown or not reported, and the manufacturing environment, where reproducibility is critical. Reproducibility will be a function of source purity, the specific impurities that are present, and consistency across targets, batches, and vendors. Targets for physical vapor deposition processes, e.g., could be synthesized from ~99% purity starting materials, although this may result in ~1% of unknown and

inconsistent impurities that could incorporate into films and have a pronounced effect on interfacial properties. In the parallel development of ferroelectric $\text{Sc}_x\text{Al}_{1-x}\text{N}$, it was recently shown that films prepared with Sc sources of nominally 99.9% vs. 99.99% purity starting materials resulted in over 5 orders of magnitude difference in electrical leakage³⁵⁰. As FE HfO_2 matures, it will become important to either control these effects or engineer the device against their variability.

Concluding remarks

Though interfaces are inevitable in FE HfO_2 devices, interfacial engineering can be used to control their thickness, chemistry, structure, and properties. The major goals of interfacial engineering can be summarized as: 1) mitigating deleterious interfacial effects through controlling thickness, chemistry, etc., or 2) leveraging/engineering the interface for the specific structure and properties, e.g. through interfacial chemistry, epitaxial growth, or the growth of additional interfacial layers to influence the properties of FE films. Limitations of controlling interfacial thickness, chemistry, structure, and properties is fundamentally a function of the selected deposition technique, processing conditions, and source materials.

Acknowledgements

JLJ, YL, and HAH were supported by the U.S. National Science Foundation (NSF) under IIP-1841453 and IIP-1841466 and HAH further acknowledges support from the NSF Graduate Research Fellowship Program (DGE-1746939). JLJ acknowledges support from the Laboratory Directed Research and Development program at Sandia National Laboratories, a multimission laboratory managed and operated by National Technology and Engineering Solutions of Sandia LLC, a wholly owned subsidiary of Honeywell International Inc. for the U.S. Department of Energy's National Nuclear Security Administration under contract DE-NA0003525.

d. Electrodes optimization (Mattias Borg)

Status

To electrically interact with HfO_2 - and/or ZrO_2 -based FEs, one requires some type of electrodes. From the most basic point of view, the electrodes provide the necessary

screening of the ferroelectrically induced polarization charge to stabilize the P_r in the film and in addition, create an electrical interface between the FE and the outside world. In many cases, the choice of electrodes also has a direct impact on the formation and switching properties FE itself, influencing the crystal phase properties, and may induce or remove defect states. For devices such as the FTJs, the electrodes' properties will also decide the device's performance, making them integral parts of the device. It is therefore essential to understand and control the properties of the electrodes in electronic devices based on HfO₂- and ZrO₂-FEs. To limit the scope of the discussion, we will focus on metallic and semiconducting electrode materials that are currently compatible with Si CMOS processing, thus excluding some electrode materials like Au and perovskites. For brevity, we will denote the FE as HfO₂, even though it may consist of an alloy with ZrO₂, or doped with other dopants such as Si, Y, Gd, La etc.

It is well known that the choice of metal electrodes can promote the formation of the FE $Pca2_1$ phase by providing a beneficial in-plane tensile strain in the HfO₂⁵³. The electrodes should also be stable enough to survive the HZO crystallization process which usually requires annealing to 400-600 C. The electrode material needs thus be chosen carefully, and common materials include TiN, TaN, Pt, Ni, W, IrO₂ and RuO₂^{351,328,335,352,353,354}. TiN appears as the most common choice, being both thermally stable and CMOS-compatible⁵³. A low electrode thermal expansion coefficient is beneficial for inducing strong tensile strain, and W was found to be particularly promising in this regard³²⁹. In addition, the electrode deposition conditions can also matter: It was recently discovered that deposition pressure-induced microtexture of a TiN top electrode can decide the resulting crystalline phase in HfO₂ and thus its FE properties³⁵⁵. Electrode deposition by different available methods, for example, evaporation, sputtering or ALD therefore, cannot be expected to yield the same results, and the electrode process thus needs to be carefully controlled.

Secondly, a reactive electrode material can interact with the HfO₂ film, both during the crystallization process at high temperatures, as well as during electric field cycling. Reactions can lead to oxygen scavenging, creating interfacial layers and additional oxygen vacancies in the hafnia³⁵¹, which can negatively affect the cycling endurance of the film. In

addition, unstable electrode materials could lead to metal diffusion through the hafnia during field cycling³⁵⁶.

Current and future challenges

A major challenge for HfO₂-based FEs is that its large E_c (> 1 MV/cm) requires the applied electric field during polarization switching to be a significant portion of the breakdown field. This promotes the creation and movement of interstitials and oxide defects, such as oxygen vacancies, in the FE film. Vacancies can accumulate at the interface to the electrodes or even move across between electrodes and the FE film, affecting the interfacial chemistry, electrode effective work function, or even leading to the formation of an interfacial layer over time.

A second challenge for HfO₂-based FE devices is the formation of interfacial layers between the electrodes and the FE film during device fabrication. Normally, a high-temperature annealing procedure (400 °C – 600 °C) is required to form the FE phase, during which also the electrodes are exposed to the high temperature. It is often observed that the common nitride electrodes TiN and TaN scavenge oxygen from the hafnia films during this process, forming interfacial metal-oxides or oxynitrides³⁵¹. These interfacial layers are believed to give rise to wake-up effects as well as degrade reliability during electric field cycling.

Thirdly, the use of semiconducting electrodes comes with additional challenges. Semiconductor electrodes are attractive for FeFETs and FTJ devices as their conductance can be strongly modulated by the polarization charge, leading to large threshold voltage shifts in FeFETs and strong tunnel barrier modulation in FTJs, resulting in large resistance state contrast. However, there is a great mismatch between the typical magnitude of polarization charge 10-30 $\mu\text{C}/\text{cm}^2$ in HfO₂ and the density of states of typical semiconductors. This leads to very large surface potentials that unequivocally activate deep trap states in the semiconductor, causing unwanted Fermi-level pinning or even irreversible damage. As an example, for Si ($N_D = 10^{15} \text{ cm}^{-3}$), the needed band bending in inversion is more than 1 V to match 20 $\mu\text{C}/\text{cm}^2$ in sheet charge. Possibly due to this effect, reports of FeFETs and FTJs with a semiconductor contact are often of gradual shifts of threshold

voltage or rapidly decaying memory windows^{353,357}. Methods to overcome this mismatch will be crucial for future reliable device implementations.

Advances in science and engineering to meet these challenges

To meet the challenges presented above, some promising advances to be pursued will be outlined in the following. First of all, “electrode replacement” procedures have been reported in which a top electrode is first used to achieve best possible FE properties, after which the electrode is removed, including a potential interfacial layer, and replaced by another metal suitable for the application³⁵⁸. This method was successfully used to reliably design FTJs using a TiN/HZO/W structure during crystallization and various replacement top electrodes (W, Cr, Ni, Cr/Ni)³⁵⁹. A major benefit of this approach is to separate out the considerations of the FE synthesis from the device design considerations. So far, this method has been used only for the top electrode, which is easily accessible. If the same procedure could be used for the bottom electrode as well, it would open for even greater freedom in the device design as well as improved reliability via the complete removal of interfacial layers created during the crystallization process. Possibly, this could be realized in a 3D device process similar to that of 3D NAND Flash.

To counteract the generation of oxygen vacancy-type defects during electric field cycling, it could be beneficial to make use of electrode materials that are prone to reduction rather than oxidation. For example, metallic RuO₂ and IrO₂ have negative oxidation potentials and can therefore supply oxygen to the HfO₂. These electrode materials were recently reported to greatly improve endurance over TaN and TiN electrodes^{335,352}, and further research in this direction appears promising to achieve reliable ferroelectric devices beyond 10¹⁰ cycles of operation.

Another option is to target inert electrodes, which are also efficient diffusion barriers. The usage of a dielectric diffusion barrier such as Al₂O₃ has been reported to help avoid defect migration across the electrode/HfO₂ interface^{360,351}, but the inclusion of an additional dielectric leads to voltage division and added depolarization field. Instead, a similar effect could be acquired through a diffusion-resistant metal. The elemental metals Pt and Pd are excellent diffusion barriers and are chemically inert. Pt top electrodes were successfully

used to achieve endurance beyond 10^{11} cycles in capacitors with epitaxial HfO_2 ²¹⁶, but whether a similar performance is possible with polycrystalline films is not clear given the moderate improvements so far reported³⁵⁴. Further research adding these elements after crystallization using a replacement electrode process could be of interest. Other options are transition metal nitrides other than TiN and TaN, which are also chemically stable and have good diffusion barriers. Examples of these are MoN and WN³⁶¹. HfN and ZrN are also attractive options, given that they are considered the most refractive of the nitrides and share the same metal anion species as hafnium zirconate FEs.

Concluding remarks

In conclusion, it is important to once more point out the central role of the electrodes both in the formation of the ferroelectric phase as well as their impact on device reliability and performance. For the future, it will thus be essential to find electrodes that are stable and provide reliable interfaces to the HfO_2 -based FEs. Electrode replacement methods to separate crystallization from device design, as well as electrodes with negative oxidation potential, appear as good candidates for future work, while the mismatch between the polarization charge and the low charge density in semiconductor electrodes remains an outstanding challenge.

e. Laminated structures (Konrad Seidel/Maximilian Lederer)

Status

The stability of the FE phase of HfO_2 and ZrO_2 is strongly influenced by mechanical stress, layer thickness, chemical composition, and other parameters. Depending on the application, certain thickness requirements are present. For example, FeFETs have HfO_2 layers with a thickness in the range of 10 nm. On the other hand, piezo- and pyroelectric sensors and actuators require much thicker layers in the range of 50 nm to 1 μm . Since the window for stabilizing the FE phase in regards to thickness is very narrow, means to transfer the properties of e.g. a 10 nm film to thicker layers are required.

On the other hand, the layer thickness has also a major impact on the microstructure and on reliability aspects, like e.g. endurance. The grain size of polycrystalline HfO_2 or ZrO_2 films

will moreover directly affect device variability. Consequently, it is of utmost importance to control and optimize the microstructure and reliability aspects for the device application.

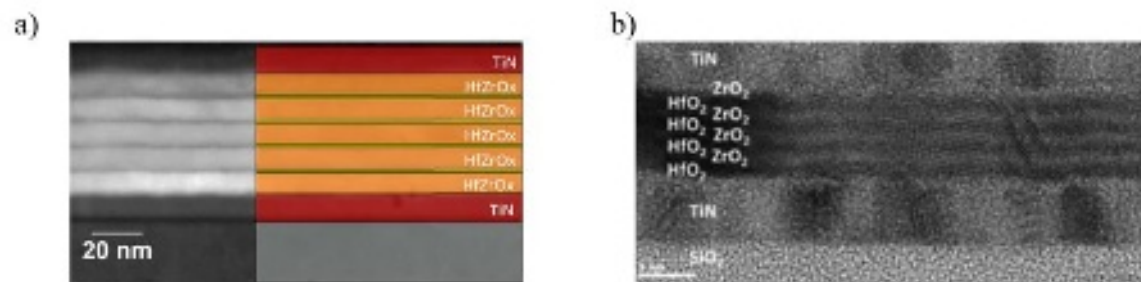

Fig. 17 Transmission electron microscopy images of laminated structures. (a) shows a dielectric/ferroelectric heterostructure consisting of $Hf_xZr_{1-x}O_2$ and Al_2O_3 . In (b), a superlattice of hafnia and zirconia can be observed. Figures reproduced with permission from: (a) ³⁶², (b) ³⁶³.

In order to address the aforementioned constraints, multiple groups proposed laminated structures as a solution^{345,362}. These can be grouped into two different approaches: i) dielectric/FE heterostructures and ii) HfO_2/ZrO_2 superlattices (see Fig. 17). The former heterostructures are usually formed by depositing ultra-thin dielectrics, like Al_2O_3 , with a thickness of less than 1 nm between layers of (doped) HfO_2 or ZrO_2 of desired thickness and layer count. In such a manner, thick FE layers are achievable, which show no increase in m -phase³⁶². By introducing them in devices, desired properties, like e.g. a large memory window, can be achieved without suffering the penalties coming from non-ideal layer thickness³⁶⁴. Alternatively, these dielectric/FE laminates can be used to influence the grain size and endurance of devices. By introducing additional dielectric interlayers into a FE thin film of a total thickness of e.g. 10 nm, the crystal growth is interrupted, and smaller crystallites form. In addition, the interlayer act as barriers for leakage paths, thus improving device endurance³⁶⁵.

The superlattice approach, on the other hand, stacks ultra-thin layers of alternating HfO_2 and ZrO_2 . Recent works have shown that by controlling the thickness of these sublayers, the grain size and endurance can be influenced^{363,366,257}. While the exact origin of this behavior is not understood in depth at the moment, a difference in nucleation and

crystal growth originating from the different physical properties of HfO₂ and ZrO₂ has been suggested as an explanation.

Current and future challenges

While laminated structures offer very powerful methods to overcome thickness, grain size or reliability limitations, they also face unique challenges. For the dielectric/FE laminates, one major challenge is the interfaces introduced by the dielectric layer. Like the electrodes, these interfaces will affect the phase stabilization slightly. Especially for laminates containing more than one interlayer, it has to be ensured that the layers stabilize in the FE phase. Small changes in the doping level might therefore be required. Moreover, these interfaces can act as pinning sites or introduce defects and introduce parasitic capacitances, resulting in a reduced polarization response of the FE layer.³⁶⁵ Another challenge is the selection of the dielectric. As both materials, dielectric and FE, are oxides, interdiffusion has to be suppressed. Else, the interlayer might not be present after annealing or shifting the doping concentration of the HfO₂/ZrO₂ layer.

For the superlattices, on the other hand, the design freedom is constrained. While the sublayer thickness can be optimized, the total thickness is expected to be limited as the crystal growth is not stopped at the interfaces.³⁶⁶ Consequently, too thick layers are expected to transform to *m*-phase. In addition, another challenge is the thermal budget. While HfO₂/ZrO₂ layers are excellently suitable for back-end-of-line applications, their application in front-end-of-line devices is strongly limited as degradation due to the high thermal budget is expected. Here, e.g. Si-doped hafnia excels due to its much higher crystallization temperature.

Advances in science and engineering to meet these challenges

Recent works, however, have showcased possible routes to address these challenges. In case of the dielectric/FE heterostructures, the doping level of the individual layers can be optimized in order to adapt to the changes brought forth by the interlayer interface. Similarly, combinations of differently doped HfO₂ layers have been reported and their interaction with each other via stress and mechanical stress has been discussed⁹¹. The models proposed herein, therefore, help to understand how modifications of individual

layers may affect the total response and allow therefore optimizing and altering of the ferroelectric response of dielectric/FE heterostructures.

In addition, the dielectric layer can be optimized in order to reduce defects/pinning sites at the interface while preventing interdiffusion. Therefore, recent works have explored alternative materials besides Al_2O_3 as dielectric interlayer, indicating that TiO_2 might be a suitable candidate³⁶⁷. Nevertheless, other materials might be suitable as well, and further research will be required here.

On the other hand, the challenges for the superlattice approach can be addressed by using different compositions. Recently, it has been shown that the effects observed in the superlattice $\text{HfO}_2/\text{ZrO}_2$ structures are also present in Si-doped hafnia layers when altering the thickness of the SiO_2 -layers deposited during the atomic layer deposition⁸⁷. Therefore, similar approaches might be suitable for enabling superlattice-optimized doped HfO_2 layers in front-end-of-line integrated devices.

Finally, the thickness limitation of superlattice structures might be overcome by combining this approach with the dielectric/FE approach, thus getting the advantages of both approaches while keeping the number of interlayers as low as possible.

Concluding remarks

In summary, both types of laminated structures, dielectric/FE heterostructures and superlattices, offer easy means to control the FE and reliability properties as well as the microstructure of HfO_2 and ZrO_2 layers. Moreover, heterostructures allow to circumvent thickness limitations of the phase stabilization of the FE phase. For the future, however, further optimization of the two approaches will be required to meet current challenges. Here, optimization of doping levels in the HfO_2 and ZrO_2 layers is of importance as well as different materials should be screened for improving defect densities at interfaces or temperature stability. Nevertheless, recent results point towards promising solutions to these challenges.

f. Thickness scaling (Akira Toriumi/ Shinji Migita)

Status

The thickness scaling of FE HfO₂ will be discussed from two points of view for advanced electronic device applications. One is how the FE properties of HfO₂ are physically altered, and the other is how they are electrically affected by reducing the thickness of FE HfO₂. FE HfO₂ was already 10 nm thick when it was discovered⁵³. It is suggested that the FE origin of HfO₂ is physically different from that of other conventional FE materials and that several inherent properties of HfO₂ are involved in the appearance of the ferroelectricity. Considering the surface/volume ratio of each crystalline unit in polymorphic HfO₂, the thickness reduction thermodynamically favors the more symmetric orthorhombic and tetragonal over the monoclinic phase³⁶⁸. The FE phase in HfO₂ is also theoretically expected to be more stabilized under appropriate boundary conditions, such as combined effects of strain and electric field²³. Furthermore, the impact of electrode interfaces on thin FE HfO₂ can be very critical, as it has been extensively studied for other FE oxides³⁶⁹. Currently, FE properties are obtainable in MFM capacitors with 5 to 10 nm thick doped HfO₂. The correlation between remanent polarization ($2P_r = P_r^+ + P_r^-$) and FE-HfO₂ thickness ($d_{\text{Fe,HfO}_2}$) are shown in Fig. 18^{370,361,371}. Further research was carried out for 1 nm thick HfO₂ on an oxidized Si substrate using PFM¹¹.

The thickness scaling raises several issues depending on the application-specific requirements. The first issue to be addressed is the reduction of the operating voltage in FE devices since lower power consumption is a key requirement for the latest semiconductor devices. Under the assumption that the E_c remains almost unchanged with the decrease in $d_{\text{Fe,HfO}_2}$ ²⁷⁰, the MFM capacitor can respond normally to the scaled voltage, and the polarization switching speed does not deteriorate in principle. However, the tunnel leakage current significantly lowers the effective bias voltage applied to the FE layer as $d_{\text{Fe,HfO}_2}$ continues to decrease. To make matters worse, the E_c in FE HfO₂ is relatively high compared to other FE materials, which limits the thickness scaling in MFM capacitor-type devices, although a wide energy band gap of HfO₂ (~5.5 eV) is beneficial for suppressing the leakage current.

FeFETs and FTJs are attractive devices for advanced memory applications in addition to conventional FeRAMs. From the device designing viewpoint, a non-polar interface layer is often inserted between the FE layer and the semiconductor to avoid the degradation of FeFETs, while it is usable for achieving the higher tunnel current ratio in FTJs. Therefore, application-specific scaling scenarios that differ from the simple MFM capacitor have to be developed.

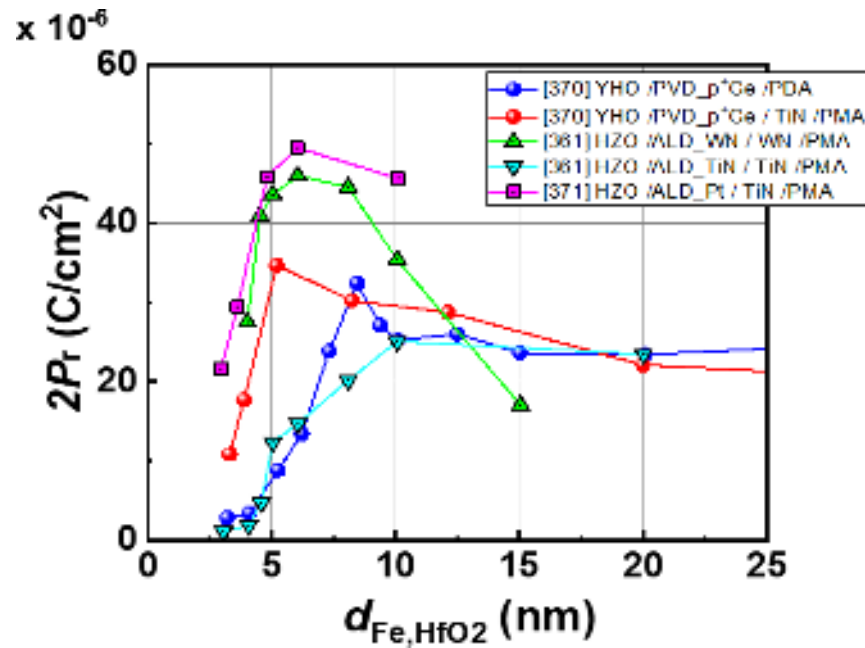

Fig. 18 $2P_r - d_{\text{Fe,HfO}_2}$ correlations for Y-doped HfO_2 (YHO) and $\text{Hf}_{0.5}\text{Zr}_{0.5}\text{O}_2$ (HZO) with different electrodes and thermal recipes. [x] denotes the reference number. In all cases, P_r exhibits a peak at $d_{\text{Fe,HfO}_2} = 5 \sim 10$ nm, and sharply decreases with the decrease in $d_{\text{Fe,HfO}_2}$. The polarization disappears at $d_{\text{Fe,HfO}_2} = 2 \sim 3$ nm.

Current and future challenges

The maximum of $2P_r$ in Fig. 18 is in the range of 5 - 10 nm for all samples independent of different dopants, electrodes, or thermal treatments. Post-metallization-annealing (PMA) is better than post-deposition annealing (PDA) for obtaining improved FE properties, especially in the sub-10 nm region. P_r decreases sharply with the decrease in $d_{\text{Fe,HfO}_2}$ below 5 nm in all cases. In contrast, it decreases gradually or remains flat with the increase in

$d_{\text{Fe,HfO}_2}$ above 10 nm. A significant influence here is the interaction of the FE layer with the electrodes, in addition to the intrinsic effects involved in the FE layer thickness reduction. The electrode controls oxygen in and out-diffusion of the HfO₂ layer and forms non-polar and polar layers or leads to a diffusion of electrode material into the FE layer.

At present, it is difficult to experimentally observe a sufficient polarization switching signal in MFM capacitors with 2 nm thick doped HfO₂. Structurally, non-FE crystalline phases or non-crystalline portions are more likely to be detected in XRD patterns and TEM images in the sub-5 nm thickness region. Therefore, a thorough and detailed optimization of the thermal treatments of HfO₂ with different dopant species and concentrations is required to explore the possibility of a sufficient P_r down to 2 nm. Otherwise, the application of ultra-thin FE HfO₂ films with scattered polarized regions will be limited in the microelectronics industry.

Interactions at the FE/electrode interfaces have been studied from various aspects, including a depolarization field and/or a non-switchable dipole formation at the interface³⁷². Since these effects generally destabilize the ferroelectricity at the interface, except in special cases^{23,11}, it is crucial to elucidate what happens physically at the FE HfO₂ interfaces.

From the viewpoint of ultra-thin FE film applications, the reduction of the effective bias voltage applied to the FE film due to the tunnel leakage current is related to the external impedance outside the MFM capacitor, which degrades the polarization switching speed as well as affects the dynamics of the polarization charge screening.

Currently, ALD is the most promising method for uniformly growing ultra-thin films. However, it is challenging to deposit doped HfO₂ films in an atomically uniform manner even after the thermal annealing because HfO₂ and dopant layers are deposited alternately or by using a cocktail of precursors. This can be a fundamental concern to the device-to-device variations in scaled FE integrated circuits because the ferroelectricity in doped HfO₂ originates from the metastable *o*-phase formation, which is likely to be affected by the variability in dopant position, particularly in ultra-thin FE HfO₂ films.

Advances in science and engineering to meet these challenges

A recent theoretical analysis predicts that ferroelectric switching is possible in one unit cell, because a non-FE spacer separates the polarization within the unit cell, and the inter-cell interaction is expected to be very weak laterally³⁹. If each unit cell can respond to the electric field independently, then the thinning limit could be one unit cell of the FE HfO₂. However, if the FE phase metastability of the polycrystalline doped HfO₂ layer is considered, two or three unit cells without direct contact with electrodes are a reasonable estimate for the minimum $d_{\text{Fe,HfO}_2}$ (1 - 1.5 nm). Furthermore, the interface layers contacting the top and bottom electrodes tend to be non-FE, because the metastable state must be sensitive to small structural and/or electronic perturbations. Therefore, two unit cells at the interfaces or one unit cell in the case of a harnessing-strain interface^{23,11} may be added, resulting in a total thickness of 1.5-2.5 nm. The oxide electrode may be advantageous for a more intimate interface. Nevertheless, a charge redistribution at the interface may form a new interfacial dipole, destabilizing or weakening the ferroelectricity.

A small P_r (around 1 $\mu\text{C}/\text{cm}^2$) can currently be detected even in sub-2 nm thick HfO₂³⁷³, because only a small fraction of the *o*-phase is viable in the ultra-thin HfO₂ films. Meanwhile, it has been reported that ferroelectricity has been detected in 1 nm thick ZrO₂ on SiO₂³⁷⁴, and that ultra-thin ZrO₂ on SiO₂ exhibits the thickness-dependent in-plane AFE-FE transition⁶². Although this is not included in the present discussion in terms of the practical applications, it is thermodynamically conceivable that the structural transformation between multiple non-monoclinic phases may occur more readily in ZrO₂ than in HfO₂³⁶⁸.

Based on the theoretical inference and the current state of experimental achievements, the key to the successful thickness scaling of FE-doped HfO₂ will be to elucidate the interface-driven kinetics of FE phase stabilization. Even if further scaling of $d_{\text{Fe,HfO}_2}$ is possible, it becomes difficult to reverse the polarization due to the effective bias reduction. The insertion of paraelectric layers to suppress the leakage current and to effectively lower the E_c by exploring the depolarization field may be a technical challenge for the use of ultra-thin FE HfO₂.

Concluding remarks

The minimum thickness capable of exhibiting FE properties in doped HfO₂ is ideally expected to be 1-1.5 nm. Considering possible interactions with electrodes, it will inherently be above 2 nm to exhibit sufficient polarization in the MFM capacitor. Of course, electrode materials and thermal annealing recipes will need to be rigorously scrutinized. In addition, the tunnel leakage current in ultra-thin doped HfO₂ hinders the application of a sufficiently high electric field on FE layers, which electrically limits the scaling of $d_{\text{Fe,HfO}_2}$ in FE doped HfO₂. These challenges need to be addressed together with the area scaling and operating frequency. Finally, it is worth mentioning that statistical variations in the performance of each FE device may inevitably accompany semiconductor chips equipped with high-density FE devices using ultra-thin FE-doped HfO₂.

7. Devices

a. Ferroelectric Random Access Memories (Ruben Alcala/Uwe Schroeder)

Status

The concept of a FeRAM is not new among emerging memory devices. In fact, the first iterations of this technology reached the market around the 1990s and employed perovskite structured PZT or layered perovskite SrBi₂Ta₂O₉ (SBT) FE materials³⁷⁵. Unfortunately, the high thermal budget, hydrogen sensitivity and the unavailability of advanced deposition techniques for the complex perovskite materials resulted in this technology reaching a dead-end at the 130 nm process generation^{375,376}. Ultimately, this drove the technology toward limited niche applications. That said, the discovery and development of ferroelectric doped HfO₂ and HZO has brought a new wave of FeRAM developments that surpass the previous limits encountered with PZT and SBT and, therefore, has re-attracted attention among emerging memory devices³⁷⁵.

The basic implementation of FeRAM technology consists in replacing the dielectric layer of the capacitor in a modified one transistor-one capacitor dynamic random-access memory (1T-1C DRAM) structure with a FE material and introducing a pulsed plate line, as shown in Fig. 21. The main goal is to have a similar performance and cell size to traditional

DRAMs yet also be non-volatile and therefore finally realize a competitive nonvolatile RAM (NVRAM) technology. Regarding HZO in particular, most major memory companies are currently assumed to have some sort of HZO-based FeRAM development program. As shown in Table I, development has not yet reached DRAM levels with respect to certain operation parameters, but significant progress has been achieved in the last few years. Even more so, FeRAM memory cells have been integrated into Mbit and Gbit arrays using standard BEOL integration flows³⁷⁷. Due to an ultra-low power read/write operation ($< 5\text{ nJ/pulse}$),³⁷⁸ the power consumption of FeRAM is similar to that of DRAM and SRAM and several orders of magnitude lower than that of flash memory.³⁷⁹ Furthermore, a non-volatile FeRAM does not need to be refreshed after 16 - 64 ms as a DRAM.

Table I. Comparison of different operation parameters for various volatile and non-volatile memory device examples^{380,381,382,383,384,377,61}.

Structure	Volatile		Non-volatile (FeRAM)		
	6T (SRAM) ³⁸⁰	1T1C (DRAM) ³⁸¹	1T1C ^{382, 383}	1T1C ^{384, 385}	1T1C ⁶¹
Minimum Write Voltage [V]	~1.1	~1.1	2.0	2.5	0.6
Write Latency [ns]	< 1	< 20	16	4	20
Retention	-	32-64 ms	$> 10^2$ min @ 85°C	$> 10^3$ min @ 85°C	Not reported
Endurance [cycles]	$> 10^{15}$	$> 10^{15}$	$> 10^{15}$	$> 10^7$	Not reported
Array size	4 MB (L1)	16 Gbit	64 kbit	16 kbit	8 Gbit

For HZO-based FeRAM to contend in a broader range of applications, certain technological challenges still need to be addressed. Although not independent, these challenges or limitations can be divided into component-level and structure-level issues.

Current and future challenges

At the component level, the HZO-based ferroelectric capacitor of the 1T-1C structure is the most critical component since it is responsible for data storage, and the rest of the structure is a derivative of the already mature 1T-1C DRAM technology. Extensive literature regarding the optimization of said component indicates that the state-of-the-art of such a device is a capacitor with a roughly 8-10 nm thick HZO FE layer that has a E_c of about

± 1.5 MV/cm, can obtain a $2P_r$ of around $40 \mu\text{C}/\text{cm}^2$, has a switching latency in the ns range (comparable to DRAM cells) and has a reduced wake-up effect.³⁸⁵ Notwithstanding, it is important to consider what voltages can be supplied to the CMOS circuitry outside the memory array. An E_c of ± 1.5 MV/cm requires even higher fields to switch all domains. Here, companies are interested in reducing the switching voltage to 1 V with narrow switching characteristics to keep voltages in the CMOS circuitry as low as possible.

When discussing the reliability of a FE capacitor, there are two main metrics: field cycling endurance and polarization retention. Ideally, a breakdown-free device with no retention degradation in a 10-year time-frame is desired. Unfortunately, from an operational point of view, opposing paths improve each metric, that is, a lower applied voltage to switch the FE capacitor allows for an improved endurance but leads to worse retention and vice-versa^{385,386}. A lower applied voltage could be compensated by increasing the pulse length up to a certain point, but this would slow down the operation speed³⁸⁷. Hence, a time-voltage trade-off exists, and a compromise is required. From a material perspective, improvement of the capacitor stack, such as reducing the defect density at the electrode-FE interface, can minimize charge injection or charge movement in the FE layer leading to a retention and endurance enhancement. This would be of particular interest for solving the prevailing imprint problem these FE capacitors exhibit regarding retention^{384,385}. Improving P_r is no longer an objective since most values reported in literature can be sufficient. In fact, a second compromise is needed here, regarding a sufficiently high P_r for memory performance and not too high of a P_r for improved reliability, since larger P_r values enhance both aforementioned charge degradation effects.

When looking at the complete memory array and the read-out circuit, additional factors must be considered for an optimized operation. A proper read-out will depend on the potential difference between a “1” programmed state and a “0” programmed state in relation to a reference voltage (provided either as a fixed voltage or from a reference cell) at the sense amplifier. Therefore, it is not necessary to have the largest possible $2*P_r$ but rather only one large enough for a desired capacitor area to maintain a stable memory window. On the other hand, the bit-line (BL) capacitance, unfortunately, adds a lower threshold to the acceptable $2*P_r$ values³⁸⁴. Furthermore, larger arrays will have a larger BL

capacitance, therefore, alternative design layouts may be required for optimal sensing. Additionally, in order to assure high yields, high uniformity during semiconductor processing and packaging, as well as stability during thermal processing steps and later soldering during package mounting, must be assured³⁷⁷.

In order for FeRAM to increase its market relevance, not only does a large memory capacity need to be possible, but also memory density, in other words, the cell size, has to be improved since this is the main contributor to the cost of the memory device. Most current literature focuses on 2D structures not stepping beyond the 130 nm technology node. For more advanced technology nodes, a more aggressive capacitor scaling in the 3D direction must be implemented, as has been done for other memory technologies such as DRAM. In this regard, first results for Gbit-sized arrays have already been published⁶¹.

Advances in science and engineering to meet these challenges

On the capacitor side, it is still necessary to improve reliability. As discussed, charge injection and movement need to be reduced to enhance endurance and retention. Here, a lower switching voltage, a stable P_r which is not too large, and a low defect density at the electrode interface and within the bulk of the FE layer are required³⁸⁵.

Regardless of what is yet to come in the development of the 1T-1C FeRAM structure, significant advancements have already been reported, mostly in the 16 to 64 kbit range^{382,383,384,377} but also reaching capacities of up to 8 GB⁶¹. Considering this and the fact that not as large aspect ratios are necessary for similar architectures to DRAM³⁸⁵, it may be the case that the cost-effectiveness of this technology could eventually reach or surpass DRAM values and even have a simpler path toward further down-scaling.

Alternatively, additional structures to the 1T-1C FeRAM have been proposed as emerging technologies. Some seek to improve the 1T-1C FeRAM structure, and others aim to provide an alternative operation but maintain the familiar structure. Regarding the former case, one can mention, first, the 2T-1C FeRAM structure, which implements an additional transistor for pre-charging the BL node and allows for an easier read-out of smaller structures but has the disadvantage of higher variability³⁸⁸ and, second, the use of an AFE behaved material instead of a traditional FE for an improved endurance of the capacitor and apparent

reduction of the coercive field³⁸⁹. In the latter case, a more complex 2T-2C FeRAM structure has been proposed for local logic operations at the memory cell level³⁹⁰. Regardless of the optimization path, the development of HZO-based FeRAM technology shows promising results for the coming years.

Concluding remarks

From the current standpoint of this technology, it would be unsurprising if a new generation of HZO-based FeRAMs start popping-up on the market in the next couple of years. The remaining optimization may come as a second or third-generation iteration of this new wave of memories. Similar to other already commercialized memory technologies, in the end, the market success of this technology will be dictated by its cost-performance relation compared to alternative technologies and solutions. For instance, perhaps the first products may use a 2T-2C configuration to overcome reliability issues at the expense of a higher real-estate, and therefore cost, but subsequent generations could finally achieve using the 1T-1C variant for a high-density nonvolatile RAM technology; a memory technology which is still heavily sought after today.

Acknowledgements

R. A. was funded by the German Research Foundation (DFG)—Project No. 430054035 and 433647091.

b. Ferroelectric Field-effect Transistors (Sayeef Salahuddin/ Michael Hoffmann)

Status

In its simplest form, a FeFET is essentially an ordinary field effect transistor where the gate oxide is replaced by a FE material, as shown in Fig. 21. When the polarization inside the ferroelectric gate oxide is switched with a voltage, it shifts the threshold voltage of the transistor. In an appropriately designed transistor, this shift in the threshold voltage could lead to orders of magnitude change in the drain current. In this way, two different states of the polarization translate to two different current levels for the transistor. The potential benefits of such a device are game-changing³⁹¹. Unlike the other prominent memory devices like resistive random access memory (RRAM), phase change random access

memory (PCRAM) or Magnetic Random Access Memory (MRAM), the memory element is not connected to the drain of the transistor – a combination that impedes the drain current due to added resistance. This means that READ speed is only determined by the performance of the transistor action and potentially the same READ speed as an SRAM could be possible. The ferroelectric switching speed of HfO₂ and ZrO₂-based materials is determined by reverse domain nucleation and growth dynamics, which have been shown to be faster than 300 ps, suggesting that even single digit picosecond switching speed is possible³⁹². The footprint of the device is also just that of a single transistor, which is substantially smaller than a standard SRAM cell that needs six transistors. Further, the device needs minimal changes to the transistor fabrication flow – just a single additional mask is sufficient – indicating any additional cost of manufacturing would be minimal³⁹³. In addition, the FeFET enables memory cell constructs that offer new ways of doing in-memory-computing both in the digital and analog domain^{394,395}. However, critical challenges remain in terms of material optimization and device design that need to be overcome to materialize the potential benefits of FeFET technology³⁹³. In the following, we provide a brief discussion of these challenges and present a roadmap of advances that are necessary to address them.

Current and future challenges

A key consideration for FeFETs is the fact that they are much more than the ferroelectric material itself – in fact, the ferroelectric film, together with an appropriate design for the transistor device, dictates the ultimate performance of the device. If one considers a simple MFM capacitor, one would like to optimize the material for the smallest E_c and smallest thickness (t_{FE}) to scale down the switching voltage as much as possible. However, in the FeFET device, this cannot be done. The semiconductor channel and any interfacial layer beneath the FE act as a dielectric material in series. This introduces a depolarization field (E_d)³⁹⁶, which, if larger than E_c , could completely diminish the memory behavior. The E_d is inversely proportional to the t_{FE} , meaning that t_{FE} cannot be scaled down arbitrarily. This means that the operating voltage (V) will be limited by these considerations. Another important parameter is the polarization (P). The shift in the threshold voltage of the transistor is proportional to P – indicating a large P is desirable. On the other hand, large P

generates a large electric field in the interfacial layer, breaking it down, leading the transistor to stop working³⁹⁷. In this case, even if the FE film is working fine, the endurance of the FeFET is limited substantially. Finally, the speed of the ferroelectric switching, in its simplest form, is dictated by an activation process – meaning that the larger the applied field compared to E_c , the exponentially faster the speed of switching³⁹². But applying a large electric field comes at the expense of a large operating voltage and faster oxide breakdown, which impacts endurance. These competing considerations show that a very carefully designed device and material is necessary to obtain the desired memory behavior.

Continuing along the same lines, non-ideality in the devices, unfortunately, plays a dominant role in the device behavior. Most debilitating among them is charge trapping³⁹⁸. Band offsets between the FE and the semiconductor or interfacial layer are conducive to charge trapping. In addition, if the chemical compatibility between these dissimilar materials is weak, the dangling bonds act as a charge-trapping center. Moreover, if the electric field in the interfacial layer is too strong, as mentioned above, new bonds break every time the FE polarization is switched, increasing the number of trapped charges. The trapping and de-trapping leads to its own hysteresis, in direct analogy to today's FLASH memory devices, whose handedness is opposite to the FE hysteresis. This diminishes the FE memory action. In addition, trapped charges can screen out the polarization, further reducing memory performance.

Advances in science and engineering to meet these challenges

It is known from high-metal-gate studies that an oxide thickness <4 nm can effectively eliminate charge trapping in the oxide by substantially speeding up trapping/detrapping processes. This advocates for thinning down the FE oxide as much as possible. Scaling down the thickness is also necessary to scale down the channel length of FeFET devices. For FeFET with $L_G < 20$ nm, an effective oxide thickness (including the FE oxide and interfacial oxide) needs to be ~ 1 nm, so that a good I_{ON} , I_{OFF} characteristics can be obtained. Hafnium Oxide (HfO_2) based FE films are, therefore, most appropriately suited for scaled FeFET applications as they retain a high enough E_c to overcome increased depolarization field even when thinned down to very small thickness³⁹⁹. Indeed, ferroelectricity has been demonstrated in HfO_2 films as thin as 1 nm^{11} . On the other hand,

thickness scaling increases the capacitance of the FE layer, thus shifting the share of the applied voltage from the FE layer to the underlying MOSFET. Therefore, scaling of the thickness has to be balanced by increasing the effective capacitance of the MOSFET (without the FE) itself. In this regard, it has been shown that increasing the permittivity of the interfacial layer helps lower the operating voltage⁴⁰⁰. As an added benefit, it reduces the total electric field in the dielectric layer³⁹⁷, which reduces oxide breakdown, in turn exponentially increasing the endurance. Endurance of $\sim 10^{12}$ cycles has been demonstrated⁴⁰⁰. However, changing the interfacial layer brings the question of chemical compatibility of the interface. The overall effect would be negative if a higher permittivity interfacial layer introduces significantly more dangling bonds.

In recent days, several reports have demonstrated FeFET structures without using any interfacial layer, especially on oxide semiconductor channels in the context of monolithic 3D integration of FeFET technology^{401,402,403}. If these efforts are successful, the operating voltage could substantially reduce as any voltage drop associated with the interfacial layer is now eliminated. However, chemical compatibility of the FE layer with various oxide semiconductor channel needs further investigation. Interface defects could cause substantial polarization screening as mentioned before. This structure could also be more prone to READ disturb as hot electrons could easily get injected into the FE layer since no interfacial dielectric impedes their momentum. Overall, Si/SiO₂ and SiO₂/HfO₂ interfaces are the most well-studied and most optimized interfaces for transistors. Therefore, controlled modification of these interfaces could lead to the most optimized FeFET performance. FeFETs based on other interfaces will need similar optimization efforts that have gone into Si/SiO₂/HfO₂. There is always a place for new FE materials. However, as discussed above, any new FE material needs to be scalable to very small thicknesses, requiring a high E_c . In addition, if the background permittivity can be made small, it will help the FE layer to get the lion's share of the applied voltage in the capacitance divider. Another desired property will be the abruptness of switching. A very abrupt switching will reduce the amount of field needed beyond E_c for fast switching⁴⁰⁴. Finally, a large band-offset with the semiconductor channel is necessary to reduce the injection of carriers into the oxide.

Concluding remarks

While challenges remain in obtaining the most desirable characteristics from a FeFET device, we note here that the FeFET uniquely combines high speed, low power, and small footprint, which makes it attractive for applications at various levels of the memory hierarchy. Additionally, in recent years, many demonstrations have shown their use for various unconventional compute paradigms such as content addressable memory (CAM), non-volatile logic, analog in-memory computing, etc. Even in their current state, FeFETs provide a very efficient on-chip memory for edge AI applications where frequent READs and non-volatile storage of the weights are primary requirements. FeFETs with FE HfO₂ layers are already available in highly scaled, 22FDX technology⁴⁰⁴. If the remaining challenges of endurance and operating voltage can be overcome, FeFETs will usher in a completely new era in computing.

c. Ferroelectric Tunnel Junctions (Beatriz Noheda)

Status

Arguably, ferroelectric tunnel junctions (FTJs) are the devices that can benefit the most from the advantages that HfO₂-based ferroelectrics present with respect to other ferroelectrics. FTJs rely on ultra-thin layers, with thicknesses below 5 nm (in fact, well below this value for large band-gap materials like HfO₂), such as to allow sufficient electron tunneling between the two electrodes, as shown in Fig. 21. At the same time, a robust polarization, and its imperfect screening at the asymmetric electrodes, is required to modify the average barrier height upon switching, modulating the transmission of electrons and achieving the *so-called* Tunneling Electroresistance (TER) effect.^{405,406,407} The appearance of polarization at the nanoscale in HfO₂ FEs, resisting depolarization, makes these materials the best candidates for FTJs. First demonstrations of Hf-based FTJs report TER values of 20 for a 2.8 nm tunnel barrier, using the standard method of probing the conductance with the tip of an atomic force microscope⁴⁰⁸. However, the large band gap energies (~ 6 eV) of these materials have allowed fabricating stand-alone FTJ devices detached from the atomic probe microscope^{409,410}. These devices, made out of 1.5 nm-2 nm tunnel barriers of Hf_{0.5}Zr_{0.5}O₂ operate even with electrodes as large as 30um x 30um

without suffering from significant leakage, which is unprecedented, and show on/off ratios as large as 50. Thus, the advent of HfO₂-based FEs represents a milestone towards the utilization of FTJs in integrated devices. The implications of this development are vast because FTJs are not only able to map the equilibrium polarization states into two-level resistance states of the device (TER effect), but they can also display non-volatile multi-level resistance arising from the partial switching of FE domains, giving rise to a ferroelectric memristor⁴¹¹.

Current and future challenges

The thickness of the ferroelectric layer can be decreased further down to 1 nm, even on Si substrates, using ALD deposition, and these devices have shown TER values above 200 and tunneling currents above 1 A cm⁻²⁴¹². In general, HfO₂-based devices present very good device-to-device reproducibility, even for those that use growth techniques for which fine control is more challenging, such as PLD. However, the devices display cyclability issues. This has to do with the relatively large switching fields that approach the breakdown fields in these materials, moving oxygen vacancies across the layer, similar to resistive switching memory devices. Therefore, a robust effect is often found only at low driving voltages, for which ion migration is unimportant^{413,304,410,221,414,139,415}. However, under these conditions, reported TER values are reduced to about 5⁴⁰⁹.

Therefore, the great challenge is to design HfO₂-based nanoscale FEs with smaller switching fields. For that, our understanding of the nature of the switching needs to be improved. The scarcity of observations of domain growth during the application of an electric field¹³⁵, as well as the dependence of the switched polarization with the magnitude and duration of the electric pulses, point to a switching mechanism whose dynamics is determined by the nucleation of domains^{416,417}, which could be a manifestation of intrinsic (non-cooperative) dipole switching. This would be consistent with the accessibility of the double-well energy landscape in these materials⁵¹ and with the very particular features of the polar *o*-phase in HfO₂: the structure is composed by polar and non-polar atomic layers parallel to the polarization direction, reducing dipole-dipole interactions and increasing the energy barrier for switching at the domain wall¹⁵, therefore promoting independent switching events.

Interestingly, some of the works mentioned above reporting epitaxial layers on LaSrMnO₃-buffered perovskite substrates have shown that the ferroelectric layer is oriented along the (111) direction and has *r*- symmetry, both in Hf_{0.5}Zr_{0.5}O₂,¹⁹ ZrO₂^{262,418} and Y-doped HfO₂⁶⁰. These materials present large polarization values and no wake-up effect. Even though interpretations on the nature of this rhombohedrally-distorted phase differ^{19,18}, they point to the absence of non-polar sublayers, which are expected to increase dipole-dipole interactions and lower the coercive field with respect to the o-phase. However, the experimental switching fields are still large (actually larger, probably due to the clamping of the layer due to the epitaxy). Therefore, understanding the structural relationship between the differently observed polar phases is still a challenge in the field.

Advances in science and engineering to meet these challenges

It is interesting to notice that amorphous HfO₂ was reported long ago as a promising tunnel barrier for magnetic tunnel junctions, using Co and Fe as magnetic electrodes, with changes of tunneling magnetoresistance (TMR) up to 30%⁴¹⁹. The addition of ferroelectricity in crystalline HfO₂, thus opens an interesting avenue for multiferroic tunnel junctions (MFTJs)^{420,421}. Moreover, the large spin-orbit coupling in HfO₂ can lead to measurable values of the tunneling anomalous Hall conductivity (TAHC)⁴²², which may lead to new functionalities.

We mentioned above the prospect of using FTJs as memristive devices. Synaptic behavior, such as potentiation/depression of the conductance upon increasing the number of electric pulses and spike-timing dependent plasticity (STDP), have also been demonstrated in epitaxial tunnel junctions^{417,423,424}. Great progress has recently been achieved toward device integration, and memristive FTJs with a back-end-of-line compatible process have been fabricated using 3.5 nm Hf_{0.5}Zr_{0.5}O₂ thin films, obtaining current densities of 10 mA/cm² for driving voltages around 0.5 V (orders of magnitude larger than previous reports), on/off ratios of 7 (excellent for pure ferroelectric switching) at reading voltages of 10 mV and superb retention and endurance⁴²⁵. A simulated neural network with the synaptic characteristics of these devices has shown recognition accuracy of 92% (in 36 epochs) for the MNIST database.

Due to the large bandgap of these materials, layers of 3 nms or thicker are not suitable for direct tunneling in FTJs. However, interesting synaptic behavior can be obtained with somewhat thicker layers, based on Fowler-Nordheim tunneling or thermionic emission, depending on the electric field range^{426,426}. Another example is the use of a heterostructure formed by a 12 nm thick Hf_{0.5}Zr_{0.5}O₂ layer and a 2nm Al₂O₃ layer placed between two electrodes. In this case, the Hf_{0.5}Zr_{0.5}O₂ layer is not the tunnel barrier. In addition, in this configuration, AlO_x could also play the role of blocking ion transport across grain boundaries and/or provide an oxygen source/drain, increasing the endurance of the FTJs junctions⁴²⁷.

It is also possible to use a layer of HfO₂ thick enough that it cannot support direct tunneling, but it can become conducting thanks to doping. This is the case of the recently reported epitaxial Y-doped HfO₂ with a thickness of 4.5nm⁴²⁸. In this case, a polarization-modulated transition from Schottky-barrier-controlled charge transport to Ohmic conduction is observed with on/off ratio of up to 540. Extending the concept of tunnel junction to these other more complex structures (even if direct tunneling is not the mechanism in place), opens a large number of possibilities for device design and optimization in the near future.

Finally, recent technological improvements allow engineering the top electrode independently from the rest of the device, leading to a much better understanding of the bottlenecks in device performance³⁵⁹. A very interesting line of research may come from combining 2D semiconductors with HfO₂-based FEs films. TER up to 10³ for biases below 1 V, in Hf_{0.5}Zr_{0.5}O₂ FTJs have been reported with MoS₂ as electrode^{429,430}. The future looks bright for FTJs.

Concluding remarks

Despite existing challenges concerning reliability, thanks to the advent of Hafnia-based ferroelectrics and their unprecedented polarization retention behavior upon extreme miniaturization, FTJs that use 1-2 nm thick layers as the tunnel barrier are, finally, a realistic option in the memory roadmap, both for the development of digital RAM, as well as for memristive devices for brain-inspired information processing.

Acknowledgments

This publication is part of the project TRICOLOR (with project number OCENW.M20.005), which is financed by the Dutch Research Council (NWO).

d. Energy storage capacitors (José P. B. Silva)

Status

The demand for reducing both CO₂ emission and the consumption of fossil fuels requires the long-term pursuit of renewable and sustainable energy sources such as solar, wind, hydroelectric, and tide energy. However, these energy sources are intermittent, and thus, there is a pressing need to develop high-power-density, efficient, low-cost, and environmentally friendly energy storage (ES) devices. The major advantages of the ES in dielectric capacitors are high ES efficiency, temperature, and cycling stability, as well as high power densities. On the other hand, regular dielectric capacitors cannot compete with the orders of magnitude higher ES of batteries or fuel cells. However, so-called supercapacitors, which combine the high power density of capacitors with much higher energy storage density (ESD), are ideal for applications where a large amount of energy has to be stored and released in a relatively short time. Currently, high ESD electrochemical supercapacitors, which are mostly based on the double-layer capacitance and pseudocapacitance effects, are used, e.g., to stabilize the power grid, recover braking energy in electric vehicles or provide a backup power supply for critical electrical systems. Recently, there has been increasing interest in purely electrostatic solid-state supercapacitors based on highly polarizable materials that can be used for powering electronics.¹⁰⁶

In this context, FE HfO₂ and ZrO₂-based capacitors are promising candidates in spite of being scarcely investigated yet⁴³¹. Figure 19 presents the best-performing ES parameters for different FE HfO₂ and ZrO₂-based thin film capacitors.

This is the author's peer reviewed, accepted manuscript. However, the online version of record will be different from this version once it has been copyedited and typeset.

PLEASE CITE THIS ARTICLE AS DOI: 10.1063/5.0148068

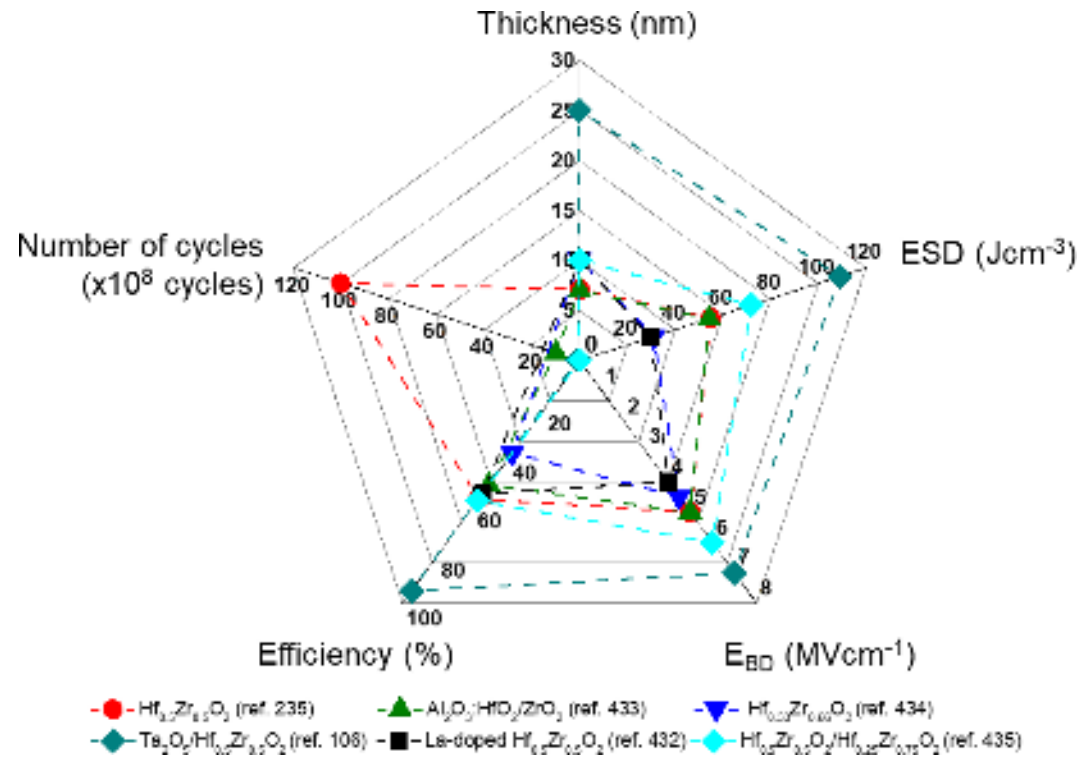

Fig. 19 Comparison of the energy storage performance obtained in FE HfO₂ and ZrO₂-based thin film capacitors. ESD =energy storage density; E_{BD} = dielectric breakdown field.

For instance, 1.0 mol. %-doped La-doped Hf_{0.5}Zr_{0.5}O₂-based capacitor shows ESD values of 30 J cm⁻³, with an efficiency of 55%⁴³². Hf_{0.5}Zr_{0.5}O₂ exhibits a stable FE behavior up to 175 °C with an ESD of 55 Jcm⁻³ and an efficiency of 57%²³⁵. Silva et al. also demonstrated that coupling of FE ZrO₂ thin films with a dielectric HfO₂:Al₂O₃ layer could enhance the ESD up to 54.3 Jcm⁻³ with an efficiency of 51.3%⁴³³. Das et al. showed that TiN/Hf_{0.33}Zr_{0.66}O₂/TiN capacitors exhibit an ESD and efficiency of ~31 J cm⁻³ and ~38%, respectively⁴³⁴. Recently, FE-Hf_{0.5}Zr_{0.5}O₂ (1 nm)/AFE-Hf_{0.25}Zr_{0.75}O₂ (9 nm) bilayered capacitor showed an ESD as high as 71.95 Jcm⁻³, with an efficiency of 57.8%. The capacitors also showed stable operation up to 150 °C and 10⁶ cycles⁴³⁵. Also, a giant ESD of 109 Jcm⁻³ with an efficiency > 95% was obtained with a new concept of negative-capacitance, in which a Hf_{0.5}Zr_{0.5}O₂ and a Ta₂O₅ layer are combined¹⁰⁶. Moreover, stable operation up to 150 °C and 10⁸ charging/discharging cycles was demonstrated.

Current and future challenges

Biaxially oriented polypropylene (BOPP) is one of the most commonly used commercial capacitor films^{436,437}. It is bulky, has an ESD of $<7 \text{ Jcm}^{-3}$, a charge/discharge time in the μs range,^{438,439} and has a low maximum operating temperature of 105°C ⁴³¹. In order to achieve desirable ESD, a large capacitor bank with many rolls of the polymer film is usually employed. Besides that, ESD is obtained at high voltages, unfortunately bringing new challenges to the miniaturization and reliability of advanced electronics and electrical power systems⁴⁴⁰. Therefore, improving the ESD and working temperature of these capacitors is of utmost importance. Moreover, there is a need to reduce the size, weight, and cost of the capacitor structures for cutting-edge pulse power technologies.

Other polymeric materials than BOPP, glass dielectrics, and perovskite materials are being investigated for ES capacitors, which show superior ESD than BOPP^{441,439,442}. Polymers and glasses can exhibit a very high E_{BD} (typically in the range of 1–10 MV/cm), but their low ϵ_r (typically <10) limits the ESD ($< 30 \text{ J/cm}^3$)⁴⁴³. On the contrary, relaxor ferroelectrics (RFEs) and antiferroelectrics (AFE), can display large ϵ_r values on the order of 100–1000, but they often suffer from relatively low E_{BD} , typically $<500 \text{ kV/cm}$ ⁴⁴³. Nevertheless, this results in a high ESD ($>110 \text{ J/cm}^3$), which is higher than the one observed in HfO_2 and ZrO_2 -based capacitors.⁴³¹ However, HfO_2 and ZrO_2 -based capacitors show promising physical properties that make them relevant for ES applications. Due to the large bandgaps of $>5 \text{ eV}$ and large conduction band offset when contacting nitride-based electrodes, FE HfO_2 - and ZrO_2 -based thin films exhibit low leakage current³⁵⁷. This results in a very high dielectric breakdown field (E_{BD}) up to $\sim 5 \text{ MV cm}^{-1}$, which is desirable for ES applications. In addition, these materials can exhibit a high maximum polarization (P_m) of $\sim 50 \mu\text{C cm}^{-2}$, while the P_r can be adjusted from ~ 5 up to $\sim 30 \mu\text{C cm}^{-2}$ ²¹⁶. Another positive characteristic of HfO_2 and ZrO_2 films is their fast switching times, in the nanosecond range,⁴⁴⁴ and their robust FE polarization even at thicknesses as low as $\sim 1 \text{ nm}$ ¹¹. This allows the design of nanocapacitors for applications in miniaturized energy-autonomous systems. However, the ESD and efficiency are compromised by the large hysteresis loss and also by the higher E_c typical in the range of $1\text{--}5 \text{ MV cm}^{-1}$ in these materials^{444,445}. To compete with other promising materials, such as RFEs, it will be

necessary to increase the ESD by $\sim 50\%$, to $\sim 150\text{-}200\text{ J cm}^{-3}$, while keeping an efficiency of $\sim 95\%$. To enhance ES performance, different strategies must be investigated. Moreover, to explore the full potential of the HfO₂ and ZrO₂-based capacitors for ES, the statistical breakdown strengths E_{BD} via Weibull distribution fitting must be studied, which was not done yet.

Besides, it is important to optimize the ES properties of the FE HfO₂ and ZrO₂-based thin films, it is also important to mention that for the final application, the thickness of the substrate needs to be taken into consideration, which can significantly decrease the ES performance. Moreover, to meet the ES requirements of the automotive, power transmission, aerospace, oil, and gas industries, the temperature stability of the ES performance needs to be increased up to $250\text{ }^{\circ}\text{C}$ ⁴⁴⁶, as shown for RFE ceramics and films.⁴³⁹ In addition, the performance of the capacitors should be investigated with continuous cycling and at high frequencies since most of the applications (e.g., high-frequency inverters) work at this regime.

Advances in science and engineering to meet these challenges

The FE properties in HfO₂ and ZrO₂-based thin films are widely being investigated. Different strategies are employed to enhance the FE polarization and reduce the E_c in these films. For instance, defect engineering through ion bombardment proved to be an efficient way to improve ferroelectricity in HfO₂-based films⁴⁴⁷. However, there is still no practical evidence on how much P_m can be enhanced and how this would enhance the ES performance of the devices. On the other hand, low E_c could be obtained via topological domain walls and phase boundaries, which leads to a significantly low intrinsic energy barrier for domain reversal and so allows rapid nucleation and growth of FE domains^{141,43}. This theoretical result still needs experimental validation, which should affect the ES performance of the capacitors.

Other strategies such as strain, multilayer, and dead-layer engineering through deposition control are proposed to also improve the ES performance of the capacitors and still need to be investigated in more detail.

The design of 3D nanostructures capacitors instead of the 2D ones should be investigated since they allow much higher polarization and ESD. For example, in AFE ZrO₂-based capacitor, an enhancement of the ESD from 37 up to 937 J cm⁻³ has been obtained³⁸⁹. Moreover, by integrating the FE-Hf_{0.5}Zr_{0.5}O₂ (1 nm)/AFE-Hf_{0.25}Zr_{0.75}O₂ (9 nm) bilayered capacitor into deep silicon trenches, an enhancement of the ESD from 71.95 up to 364.1 J cm⁻³ was achieved⁴³⁵. In addition, from the Weibull distributions of the extracted maximum ESD and efficiency, it is possible to conclude that while the planar capacitors display excellent electrical uniformity, the 3-D capacitors have a narrow distribution of maximum ESD. On the other hand, both the planar and 3-D capacitors exhibit very close efficiencies, corresponding to 57.8% and 56.5%, respectively. Recently, negative-capacitance AFE-HZO superlattice films integrated into 3D Si capacitors established record-high ESD (80 mJ cm⁻²) and power density (300 kWcm⁻²)⁴⁴⁸. However, there are no studies about 3D ES capacitors based on FE HfO₂ and ZrO₂-based thin films.

HfO₂ and ZrO₂-based thin films have also demonstrated in-plane polarization^{449,62} and in the case of ZrO₂ films,⁶² it would allow the application of a high voltage (~60 V), which could be beneficial for some applications where high voltages are needed. However, the active capacitor area is reduced, and the material under the electrodes has nearly zero electric field, which can be detrimental for ES applications. Therefore, in-plane devices can also be investigated for ES applications.

Shaping the size of ferroelectric nanodomains is also envisaged to impact the ES performance of the devices, as observed in the case of RFEs where a superparaelectric state is achieved⁴⁵⁰. In this state, the nanodomains are scaled down to polar clusters of several unit cells so that polarization switching hysteresis is nearly eliminated while relatively high polarization is maintained. In this case, Pan et al. showed an ESD of 152 J cm⁻³ with improved efficiency (>90% at an electric field of 3.5 MV cm⁻¹) in samarium-doped bismuth ferrite–barium titanate films.⁴⁵⁰ Moreover, a high Weibull modulus β of 14.9 is achieved, indicating narrowed distributions of E_{BD} data and improved film uniformity. The strong relaxor features in the superparaelectric films lead to temperature-insensitive dielectric properties. Therefore, the ES performance is stable over a wide temperature range (173 to 423 K), with an energy density variation of <6% and an efficiency variation of

<13%. A similar strategy was already used in $\text{Hf}_{0.2}\text{Zr}_{0.8}\text{O}_2/\text{Al}_2\text{O}_3/\text{Hf}_{0.2}\text{Zr}_{0.8}\text{O}_2$ capacitors⁴⁵¹. A high ESD of 87.66 J cm^{-3} and efficiency of 68.6%, together with large breakdown strength of 5.5 MV cm^{-1} were achieved in the $\text{Hf}_{0.2}\text{Zr}_{0.8}\text{O}_2/\text{Al}_2\text{O}_3/\text{Hf}_{0.2}\text{Zr}_{0.8}\text{O}_2$ capacitors⁴⁵¹. However, using this strategy, the ESD and efficiency are still far from those observed in samarium-doped bismuth ferrite–barium titanate films. More investigations need to be done to further enhance the ES performance of HfO_2 and ZrO_2 -based capacitors.

Concluding remarks

In summary, while much progress has been made over the past ten years with regard to an understanding of the FE properties in HfO_2 and ZrO_2 -based thin films, significant work remains to be done, in spite of these materials exhibiting fascinating properties, regarding the possibility of application of these materials in ES.

HfO_2 and ZrO_2 -based capacitors enable next-generation pulsed power systems due to their superior material properties, allowing improved ES performance compared to commercial dielectric BOPP capacitors. Multiple strategies such as composition, doping, dead-layer engineering, and the use of negative-capacitance effects, among others, have successfully improved the ES performance of the devices. It is anticipated that a combination of these strategies will lead to further improvement in performance. To compete with other materials, such as RFE thin films, the ESD and efficiency need to be improved in terms of ES performance. Moreover, a better understanding of the ES performance at high frequencies and temperatures as well as the statistical breakdown strengths E_{BD} via Weibull distribution fitting, is needed to evaluate the potential impact of the HfO_2 and ZrO_2 -based capacitors in the ES sector. Finally, novel strategies are proposed to enhance the ES performance of the devices.

Acknowledgments

This work was supported by: (i) the Portuguese Foundation for Science and Technology (FCT) in the framework of the Strategic Funding Contract UIDB/04650/2020; (ii) the exploratory project 2022.01740.PDTC, (iii) the Scientific and Technological Cooperation

Program between Portugal (FCT) and France (CNRS) - 2022/2023, and (iv) the European Union's Horizon 2020 research and innovation programme under grant agreement No 958174 (M-ERA-NET3/0003/2021 - NanOx4EStor). J. P. B. S. also thanks FCT for the contract under the Institutional Call to Scientific Employment Stimulus – 2021 Call (CEECINST/00018/2021).

e. Beyond memory application and Neuromorphic (Stefan Slesazek)

Status

Recently it became apparent that the conventional von-Neumann architecture has reached its limits in terms of performance and energy consumption due to the need for increasing data movement. Relief is found by combining computing and storage functionality locally within one structure. In this context, the three basic FE memory device concepts that utilize one of the most energy-efficient storage mechanisms – FE polarization switching - exhibit superior properties in terms of area and energy efficiency. The three-terminal FeFET with separate write and read terminals exhibit a tunable threshold voltage. It is programmed via its gate terminal, and the polarization state is read as drain-source current. Integrated together with conventional CMOS⁴⁵² FeFETs are the most versatile FE devices that add memory functionality in analog and digital circuits. The two-terminal ferroelectric tunneling junction (FTJ) features a polarization-dependent resistance. However, in these devices, both programming and read paths are combined. Thus FTJs are less flexible for circuit implementation. FTJs are very interesting for massive parallel operation due to their typical high impedance⁴⁵³. In both device concepts, a read operation is ideally performed without affecting the polarization state. This is not the case for the third device: the FE capacitor (FeCAP). Read and write operations are combined by applying a switching pulse and measuring the resulting switching current. This makes them good candidates in regular array-like structures but restricts their application scenarios in neuromorphic circuits. In all three device concepts, the write operation is performed by applying an electric field to the ferroelectric layer that exceeds the coercive field. In a first-order approximation, the required switching energy depends linearly on switched polarization charge P_s (and thus linearly on device area) and the applied switching voltage V_s : $E \sim P_s V_s$. Thus, the switching energy of small-scaled FeFETs in the 10nm regime is smallest with typical

values in the ~ 10 pJ range on the device level, while device area scaling of FeCAP and FTJ is limited by the required reading charge or current, respectively, thus leading to typical switching energies in the range of ~ 1 -100 fJ. The energy consumption of read operation for FeFET and FTJ depends strongly on the sensing concept, but for FeCAP equals the corresponding write energy.

Obviously, the strong differences in the read operation have a major impact on the usability in various architectural concepts. Artificial neural networks (ANN) link input and output nodes via digital computing layers that perform matrix-vector multiplication (MVM) or multiply and accumulate (MAC) operation. Many hidden layers form deep neural networks (DNN). The digital “synaptic weight” storage and multiplication can be realized locally in near-memory-computing (NMC) or in-memory-computing (IMC) approaches to realize the combined logic and memory functionality in FeCAP or FeFET-based arrays⁴⁵⁴. Devices characteristics are similar to NVMs, such as high cycling endurance, long data retention, and low switching voltages are targeted at. For analog weight storage and MAC operation, however, FeFET and FTJ-based circuit designs take advantage of Ohm’s and Kirchhoff’s Law. Thus, additional device requirements such as linearity in weight update and IV-characteristics, high impedance, large dynamic range, and low variability are key. Finally, spiking neural networks (SNN) benefit from the accumulative switching properties of the ferroelectric devices⁴⁵⁵. Common to all these architectures is their data-centric approach to overcome the von-Neumann bottleneck. Thus, the research on ferroelectric device applications beyond pure memory has recently gained a lot of traction.

Current and future challenges

For the specific application, both readout and programming dynamics are key and strongly linked to the circuit design for the implemented learning algorithms. For the FE HfO₂ there is a trade-off between switching field and switching time⁴⁵⁶. It is possible to obtain both, digital weight update by strong programming pulses, or more gradual weight update by varying programming pulse times or amplitudes or a mixture of both like in spike-time-dependent-plasticity (STDP)⁴⁵⁷. In this context, the largest challenge is seen in overcoming the typical non-linear weight update of FE devices. Moreover, caused by the polycrystalline nature of the FE layer, there is a direct trade-off between multi-level switching

and device scalability. Thus, the scalability of HfO₂-based FE devices for digital storage is limited to about 0.2 μm² cell size⁴⁵⁸, and for analog weight storage, it gets even more challenging to deal with the device-to-device variability. Target programming schemes can help at the cost of increased complexity of the programming circuit, which is detrimental for non-array like designs.

On the other hand, small-scaled FeFETs with just a small number of single FE domains exhibit versatile interesting switching dynamics. Besides digital, gradual, and cumulative switching, accumulative switching⁴⁵⁵ and stochastic switching⁴⁵⁹ allow a huge variety of application cases beyond synaptic weight storage. Spike accumulation in neurons⁴⁶⁰, the realization of physical unclonable functions (PUF) and random number generators are some examples. However, the controllability of the single-domain switching kinetics and the distribution of coercive fields among different domains within one device is limited. Thus, a proper programming circuit design and limitation of the dynamic range are key.

For analog MAC operation, typically, a linear I-V characteristic is required. However, in FTJs, the conduction mechanisms are generally non-linear, thus limiting their suitability in this respect. A different input data representation for example by using pulse-width coding at constant read voltage instead of pulse amplitude coding, might be one way to mitigate this issue. The non-linearity is easily circumvented in three-terminal synaptic elements or FeFETs, where the current during the reading doesn't flow through the ferroelectric layer but through a channel material. Excellent I_{DS} – V_{DS} linearity was obtained using conducting oxides, for example, WO_x⁴⁶¹ as channel materials.

For FeCAPs up to 10¹⁸ switching cycles have been predicted⁴⁶¹. In contrast, Si-based FeFET endurance is typically limited to ~10⁵ cycles, mainly due to degradation of the channel interface. FTJs suffer from similar effects, making these devices more suitable for inference applications and un-frequent weight updates. In this case, longer retention times are required, which has been demonstrated for digital storage in FeCAP³⁸² and FeFET devices. However, high internal electric fields cause imprint resulting in a low opposite state retention⁴⁶² that still needs to be resolved especially for analog weight storage in FeCAPs. Same-state retention becomes more critical in FeFET and FTJ double-layer devices featuring larger depolarization fields. The situation might be relaxed for online

training of neural networks, because the weights are continuously updated. Hence, from application point of view there is a trade-off between the endurance and data retention requirements.

Advances in science and engineering to meet the challenges

The specific weight update characteristics of the ferroelectric devices depend on the ferroelectric film, its microstructure and the formation of domain walls, and the resulting energy barriers between the different polarization states. Thus, material optimization towards small grain sizes targeting at gradual switching of many small domains featuring a certain distribution of the E_c will be key to success of FE devices as analog synapses. In contrast, a sharp E_c distribution is mandatory for digital switches.

Besides the FE layer properties itself the switching dynamics and device reliability are further influenced by the whole material stack, including electrodes and their work function, interlayers or interfaces, the device structure and size. Moreover, other physical and chemical effects such as ion migration, oxidation of electrodes or reduction of the metal oxide films as well as charge trapping effects⁴⁶³ can have a strong impact on the device's electrical characteristics. Thus, the optimization of a desired weight update characteristic has to consider not only the FE material itself but the whole layer stack and, consequently the device design, and is subject of intense research.

For front-end-of-line (FEOL) Si-based FeFET optimization the main focus will be on the improvement of the devices reliability in terms of cycling endurance and device-to-device variability, since the FeFET size directly influences the silicon cost. FeMFETs featuring an internal electrode can benefit from the freedom to optimize the ratio between FE capacitor and gate capacitor in the trade-off between memory window and depolarization field and from the better reliability of the FeCAPs⁴⁶⁴. However, for this concept, any leakage current towards the floating internal node has to be prevented to avoid compensation of the polarization charge. Thus, material stack optimization towards ultra-low leakage and reliability in terms of stress-induced-leakage-current (SILC) will be of utmost importance.

The focus of FTJ development will further be driven by the need for increasing the on-current density and the optimization of the device reliability. The adoption of multiple

functional layers, electrode and interface optimization and band engineering will be a key for success.

Incorporated in circuits, the operation voltages of the FE devices ideally should not exceed 3V to 5V. A reduction of the FE layer thickness might be targeted, which however causes increased annealing temperatures, thus affecting the BEOL compatibility. Another approach is stack engineering e.g. combining FE HZO and AFE ZrO₂⁹¹.

Besides the device optimization measures, also the electrical operation conditions must be adapted to the specific device design^{465,457}. Thus, a thorough design-technology-co-optimization (DTCO) will be mandatory key to success.

Concluding remarks

The growing interest in AI-hardware development and the need for non-volatile storage devices that are to be co-integrated with conventional CMOS devices reflects itself in a significant growth in the research on ferroelectric devices for application in beyond von-Neumann architectures during the past 5 years. Compared to other storage concepts the FE devices benefit mainly from a low-power program operation, a defined and well understood physical process and a great flexibility in device design. This gives rise to a large variety of potential application cases as digital or analog synaptic weighting elements, as spike accumulators or as routing memory in SNNs using address-event representation (AER) of spikes. However, there are still several technological issues to be solved, and at the present, there are no clear winning usage scenarios. When looking at the current research activities in the field of neuromorphic computation, there is still a large potential for the scientific and engineering communities in terms of algorithm development and DTCO, that will finally lead to a commercial application of the “ferro-neuromorphic” devices.

8. Overarching Challenges

a. Measurement Protocol (Veeresh Deshpande/ Catherine Dubourdieu/Suzanne Lancaster)

Status

A standard measurement protocol is critical in order to accurately compare between HfO₂-based films. Typically, in order to obtain polarization-voltage (*P-V*) curves, the current through the capacitor during switching is integrated. Measurement techniques include the Sawyer-Tower⁴⁶⁶ or virtual ground method⁴⁶⁷, with most commercial FE testers using the latter. When a voltage pulse is applied to a FE, the current response will consist of the switching current, leakage through the FE, and dielectric displacement current. Leakage contributions can be removed using dynamic leakage current compensation via measurement at different adjacent frequencies⁴⁶⁸. If non-switching contributions are large, the positive-up negative-down (PUND) method⁴⁶⁹ can be applied to avoid remanent polarization overestimation. Here, two consecutive voltage pulses are applied in each polarity. The current (or charge) in the second pulse is subtracted from the first in order to remove the leakage and dielectric components, which in the ideal case yields only the remanent polarization. From this basic measurement, different pulse trains can be established, which characterize various aspects of FE device operation⁴⁵⁷.

Complementary to *P-V* or *I-V* measurements, small-signal capacitance-voltage (*C-V*) measurements can be used to observe the FE response, yielding a characteristic ‘butterfly-shape’ with peaks corresponding to increased capacitances during switching⁴⁷⁰. Finally, as FE hafnia films are dielectrics, which suffer from defect generation due to electric field stress, capacitor leakage is an important figure of merit that gives information on film and interface quality¹⁶⁷.

Measurement protocols vary based on the intended device type. The three major device types for HfO₂-based FEs are: FeCAP, FTJ, and FeFET. Measurement of these devices depends on the device performance parameters to be estimated and their intended applications. The general protocols for each type, as summarized in Fig. 20, are as follows:

a) FeCAP: The remanent charge, its dependence over multiple switching cycles (endurance), and its ability to retain the charge (retention) at different temperatures are the main characteristics to be determined. The remanent charge is measured via PUND sequence. The leakage current can be determined by quasi-static (voltage sweeping) or DC *I-V* (voltage sampling) measurements. The remanent charge is measured with cycling to

assess the endurance. Retention is ideally measured by first switching the polarization to one state, then estimating the switched charge into the new same state or opposite state after various delay times, both at room temperature and elevated temperatures⁴⁷¹. Besides measuring the loss in stored polarization charge, retention can also be investigated via imprint, which plays a strong role in reading of the state in FeCAP⁴⁷².

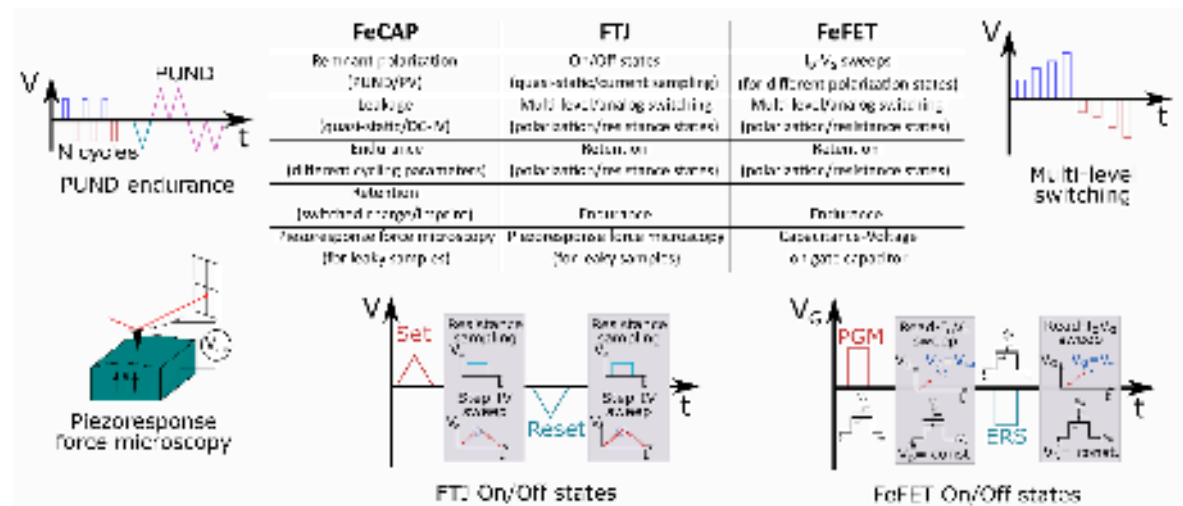

Fig. 20 Overview of standard electrical measurements for the three main ferroelectric device types (FeCAP, FTJ, FeFET).

b) FTJ: As a non-volatile memory device, the important parameters to be measured in a FTJ are the ON and OFF currents, retention of these states, and endurance. The FTJ device architecture can be a single ultra-thin layer, a bilayer, or a multilayer stack sandwiched between two electrodes. PV or piezoresponse force microscopy (PFM) measurements are performed to assess the FE switching. ON and OFF currents can be determined in different ways, discussed later. For neuromorphic applications, multiple resistance states are characterized by reading the current levels after partial switching operations performed by progressively increasing (or decreasing) the switching voltage, varying the switching pulse width, or applying several pulses of fixed amplitude and width⁴⁷³.

c) FeFET: Polarization switching measurements are performed by grounding the source and drain, while applying the switching voltage to the gate. Drain current (I_D) vs. gate voltage (V_G) sweeps (up to read voltage on the gate) under applied drain voltage determine the change in threshold voltage after switching. The ON and OFF currents are estimated at fixed V_G . Retention and endurance can be measured for each state. While performing a

switching *IV* or *PV* measurement is neither typical nor straightforward, ferroelectric switching can be ascertained by performing *CV* measurements of the gate capacitor. Multiple current states are estimated through partial switching as for FTJs. A useful technique is plotting V_G against the time it takes to close half the memory window for each state, from which the retention of each state, minimum switching time and optimal operating parameters can be estimated³²⁰.

Current and future challenges

Certain challenges arise when the film is leaky, which is usually the case when reducing the thickness of FEs below 5 nm. Since FE materials are also piezoelectric, an alternative method to measure the FE response is by determining the sample deformation under an AC bias through piezoresponse force microscopy (PFM). In ultrathin films, the high leakage during switching necessitates the use of PFM for observing hysteresis⁴⁷⁴. At the same time, PFM must be carefully performed since other electromechanical responses, in particular charge injection, can mimic ferroelectricity⁴⁷⁵ and complementary methods should be applied in order to confirm the observed ferroelectricity.

Recent work has again highlighted the limitations in current FE characterization techniques for evaluating devices in the presence of a large depolarization field⁴⁷⁶, such as in ultrathin FEs or in FEs integrated with a dielectric layer. It was shown that PUND analysis underestimates both the irreversible and remanent polarizations in the presence of depolarization fields. In the case of FeFET, parasitic charge trapping effects can obscure the memory window on short time scales while improving retention and degrading endurance³⁹⁸. This means that reported figures of merit may sensitively depend on the exact measurement routine applied. Charge injection has been shown to play a significant role in the switching of any film integrated with a dielectric layer, for example, FTJs or negative capacitance devices⁴⁷⁷.

In FeFETs, the read and write paths are fully decoupled so that ON & OFF states can be measured independently from the switching current. Conversely, for FTJs, it is important to distinguish current components in order to properly characterize the device resistance levels. Quasi-static *IV* curves are reported, which either cover the whole switching range

⁴⁷⁸, or only up to a defined read voltage chosen to exclude switching contributions ⁴⁷⁹. In the former case, there is a risk if trying to extract the resistance states that the tunneling current is conflated with the switching current even at low sweeping rates. Another method would be measuring the resistance state directly at the read voltage, where applying a long bias time enables the separation of the read current from background components ⁴⁸⁰. When moving to on-chip operation and characterization, a pulsed read scheme is required where the desired device behavior can no longer be decoupled from the background currents, necessitating new measurement schemes.

The wake-up effect seen in HfO₂-based FEs raises challenges for devices. While the FeCAPs may have nominally similar electrodes on either side of the FE, FTJs and FeFETs typically have different electrodes or interfaces, leading to an asymmetric field distribution. As such, the wake-up will depend both on the built-in imprint field and particularly on the electrical cycling parameters (waveform type, frequency, amplitude etc.)⁴⁸¹. Thus the wake-up behavior needs to be characterized, well-reported and optimized for individual device stacks.

Advances in science and engineering to meet these challenges

As HfO₂-based FE technologies mature, a shift from macroscopic characterization to on-chip measurements is necessary. Characterization of on-chip FeCAP devices has already allowed the observation of switching speeds down to the nanoseconds ³⁸⁴. A 120 dB pulse generator has been demonstrated that meets the requirements for on-chip testing of FE devices, where pulse widths can be precisely controlled across 6 orders of magnitude ⁴⁸². This allows read, write, switching kinetics and multilevel programming operations to be performed on-chip with the same circuitry.

For lab-based characterization, the device layout also needs to be optimized to allow the application of short pulses to avoid pad and connection parasitics from influencing the read and switching currents. For example, the use of active voltage probes for connecting devices was recently demonstrated in order to measure FE HfO₂ without parasitic cable capacitances, enabling direct measurement of devices with areas below 1 μm^2 ⁴⁸³.

Due to the typically small thicknesses of HfO₂/ZrO₂ FEs, interfaces play a dominant role in their behavior. Recently, a pulsed measurement scheme was proposed to quantify interface charge traps⁴⁸⁴. Additionally, small-signal CV measurements to quantify interface traps can be better understood by new models in combination with experiments⁴⁸⁵. This demonstrates how both new measurement schemes and device modeling can contribute to a better understanding of FE device behavior.

Concluding Remarks

Accurate measurements of the properties of HfO₂-based FEs are pivotal in ensuring that these materials reach their potential in the field of memory devices and other applications. Proper measurements and detailed reporting of measurement schemes allow benchmarking between different technologies and processes. However, HfO₂ FEs still suffer from reliability issues and large depolarization fields, which can obscure measurement results. Therefore, the question of how to properly characterize HfO₂ films can be broken down into two parts: the first is how to determine the fundamental properties of the FE, and the second is how to correctly compare between devices and technologies.

Acknowledgment

The authors acknowledge funding by European Union's Horizon 2020 research and innovation program under grant agreement no 871737 (BeFerroSynaptic)

b. Switching Voltages/Retention (Simon Martin/Laurent Grenouillet/Jean Coignus)

Status

Since the discovery of ferroelectricity in HfO₂/ZrO₂ materials, FE memories paradigm has changed, in particular for FeRAM, thanks to CMOS compatibility and scalability compared to perovskite-based FeRAM. Switching voltage/time and data retention are key parameters since they dictate the performance and reliability of the memory.

The switching speed governs the latency of the memory, whereas low switching voltages allow better scalability and lower programming energy. Endurance performances are then a mixed consequence of the optimized voltage/time programming scheme. FEs are intrinsically fast in terms of switching, with a trade-off observed between switching speed

and voltage. Tagantsev et al. physically described this trade-off in the NLS model,⁴⁸⁶ which overcame the KAI model⁴⁸⁷ in polycrystalline ferroelectrics. Fast switching is at the expense of higher voltages: e.g. Lyu et al. demonstrated ultra-fast sub-ns switching on 15 nm HZO but with 9 V pulses⁴⁸⁸. This trade-off has recently been measured in 10 nm HZO- and HSO-based single-scaled capacitors⁴⁸⁹ in the form of switching efficiency maps demonstrating 2.5 V-operation capability at the ns scale.

An important reliability feature for marketing a product is data retention. The reliability targets for 10-years data retention are 85 °C, 125 °C and 165 °C for general purpose, industrial and automotive applications, respectively. The physical understanding of retention loss is key for practical applications and future technology developments to improve those metrics. Both memory polarization states P_{down} and P_{up} (encoding 0's and 1's) retention need to be clearly understood as different phenomena can occur and degrade the state stored in the FE capacitor. The same-state (*SS*) represents the non-switching state in FeRAM during read operation and the switching state, called opposite-state (*OS*), is the preferred metrics for evaluating data retention in FeRAM⁴⁹⁰. Thermal depolarization (*TD*) and imprint are the two main mechanisms identified for the retention degradation. The *TD* is an intrinsic property of the ferroelectric material: the P_r drops as the temperature rises up to the Curie temperature. This transition temperature, where ferroelectric material becomes non-polar (paraelectric phase), is high for HfO₂-based films and bulk, typically > 350°C^{491,203,426}, favoring stable operation for memory applications. However, this temperature can be reduced with film thickness, dopants and strain^{88,203} and thus strengthen the *TD* phenomenon. The thermal depolarization can also be due to the depolarization field induced by an incomplete polarization compensation at the electrode interfaces⁴⁹². The imprint provokes a decrease in the *OS* polarization and increases the E_c required to switch in *OS*. Excellent retention has been observed on single FE capacitors 10nm HSO at 125 °C during 1000 h⁴⁹³ and at 85 °C during 10 years (extrapolated)⁴⁷². At the array level, Lin et al. exhibit an extrapolation at 10 years at 85°C (10 nm HZO 1 kbit FeRAM) with a P_r at 76 % of the initial value (*OS* retention)⁴⁹⁴. Recently, 16kbit FeRAM HSO-based arrays have demonstrated their immunity to solder reflow process with no bit failures after 3 repeated sequences up to 260 °C (30 s)³⁷⁷. In terms of switching time/voltage, a compelling result was demonstrated in 2020²²⁸ with the first demonstration of 64 kbit 1T-1C FeRAM arrays

with 100% bit functionality, 10ns write speed, and 2.5 V operating voltage using 130 nm node.

Current and future challenges

Despite these recent advances in the field, major challenges remain to improve performance and reliability, especially at the material/stack level.

Indeed, dopants, oxygen vacancies, and charge trapping play essential roles in device functioning³⁰⁶, affecting phase formation, FE properties, and electric conductivity. In particular, HfO₂/ZrO₂ films require oxygen vacancies to stabilize the *o*- FE phase, while a reduction in oxygen vacancies content leads directly to an unwanted increase in the non-polar monoclinic phase formation. Oxygen vacancies concentration is difficult to control and can evolve within the films during electric field cycling. Moreover, low thermodynamic barriers between the polar *o*- and the non-polar *t*- and *m*-phases reflect the high degree of polymorphism in hafnia⁴⁹⁵, highlighting the need for careful phase engineering in thin ferroelectric films.

The electric fields experienced by FeRAM can attract charges from the electrodes, and induce drift of free charges and charged defects within the layer⁴⁹². It contributes to imprint and accordingly limits data retention. The electrostatic drift associated with imprint may eventually cause sub-cycling behavior because of an incomplete switching: as a result, spontaneous back-switching of the polarization is expected to occur, resulting in retention loss. Finally, local depolarization of FE domains can also limit data retention if non-polar phases are present in the FE layer.

Assessing the aforementioned challenges is mandatory to push further the introduction of HfO₂/ZrO₂-based ferroelectrics into advanced technological nodes, which requires to lower the operating voltage below 2.5 V. Due to the switching voltage/time tradeoff, this would imply longer switching times in order to avoid partial switching of the layer, the latter having a detrimental impact on the memory window (MW). To overcome this, FE films thinner than 10 nm are required to decrease to coercive voltages while keeping a complete bitcell switching. Using 8 nm HZO, Okuno et al. successfully demonstrated functional FeRAM memory operation down to 2 V at 16 ns³⁸². However, reducing film thickness

requires higher crystallization temperatures, which can hamper BEOL integration⁴⁹⁶. Also, reducing FE film thickness increases depolarization field⁴⁹⁷, which in turn has a detrimental on data retention. This illustrates the need to engineer the FE stack to overcome those current and future challenges. This engineering work necessitates significant theoretical simulations, coupled with advanced experimental growth and characterization works, in order to provide a robust understanding of HfO₂/ZrO₂ films.

Advances in science and engineering to meet these challenges

Tahara et al. reported 4 nm-thick FE HZO in MFM structures with excellent FE properties⁴⁹⁶: a low voltage operation of 1.0 V is reported with coercive voltages below 0.5 V while keeping a satisfactory $2P_r$ value superior to 20 $\mu\text{C}/\text{cm}^2$. Excellent OS data retention requirement of 10 years at 85 °C is also demonstrated. For 10nm-thick HZO, crystallization is achievable at 400 °C anneal, while 4 nm HZO requires around 500 °C to crystallize in the o-phase. The increase in crystallization temperature with decreasing film thickness could be overcome in BEOL integration thanks to the nanosecond laser anneal (NLA), which is a promising way to locally rise the anneal temperature to reach o-phase crystallization while preserving BEOL integrity⁴⁹⁸. As previously discussed, the oxygen content in Hf/Zr-based films is crucial to get better reliability and performance. Mittmann et al. have recently performed oxygen content engineering in HZO films, highlighting that not enough oxygen favors t-phase while too much oxygen content advantages the m-phase formation during the film deposition. The optimization of this parameter is key to maximize the o-phase formation and to improve the reliability⁴⁹⁹.

Increasing the MW would also help to minimize the OS retention loss in FeRAM. 3D FE capacitor integration seems highly suitable for advanced nodes as it favors the storage density thanks to the increase of FE capacitor electrical surface. Lin et al. reported the technological potential of a BEOL 3D FeRAM, which can be integrated in 3X-nm technology node⁵⁰⁰. 3D FE capacitors exhibit good performances with an endurance of 10^9 cycles, $2P_r$ around 18-20 $\mu\text{C}/\text{cm}^2$ and field operation at 2.2 MV/cm. P_r reaches in 1C-3D is 78 % of equivalent P_r measured on a planar capacitor. Good reliability is also achieved with 10-years retention at 85 °C with 60 % of the initial P_r . At the circuit level, the bitline capacitance (C_{BL}) reduction is another lever for improving MW since it affects the

capacitive divider within bitcell³⁷⁷. This reduction is achievable in advanced technology nodes and/or with proper design optimization³⁷⁶.

Concluding remarks

In conclusion, improvements in switching voltages/times and data retention are in constant progress. These key parameters are important milestones for the future integration of HfO₂ and/or ZrO₂ -based FE materials in advanced technology nodes. The enhancements in terms of integration have been recently made with the fabrication of 3D FE capacitor instead of a planar capacitor to maximize the MW and the storage density. Another integration improvement is the thickness slimming of the FE films to reduce coercive voltages keeping ferroelectric properties with crystallization temperature compatible with BEOL. Moreover, the control of the oxygen content during the deposition of hafnia/zirconia films to limit the oxygen vacancies formation and stabilize the orthorhombic polar phase is a key parameter to improve the performances and the reliability in hafnia/zirconia-based FeRAM. All these technological progresses pave the way toward an integration of hafnia/zirconia-based FeRAM in advanced technology nodes.

c. Endurance (Laura Bégon-Lours)

Status

Remarkable efforts have been recently achieved for outperforming the endurance of HfO₂ -based FE devices. On the one hand, the exploration of various materials and stacks led to the demonstration of devices pushing the maximal endurance limit, from 10⁴ back in 2012 to 10¹¹ nowadays. Area scaling to small production-type capacitor structures could even enhance the endurance limit beyond 10¹⁴ cycles⁵⁰¹. Such metrics were demonstrated both in two- and three- terminals configurations. They show that FE devices are serious candidates for non-volatile memory application: in comparison, flash memories have an endurance of ~10⁶ cycles, phase change materials memories 10¹⁰, valence change resistive memories can reach 10¹² cycles, and spin-transfer-torque magnetic memories up to 10¹⁵ write/erase cycles.

On the other hand, studies combining materials sciences and electrical characterizations brought valuable knowledge on the control of endurance properties. Number of devices contain (on purpose or not) a dielectric layer at an interface with the FE, for example, SiO₂ at the interface between an HfO₂ gate and a Si channel. In the last decade, a number of experimental and theoretical works detailed the role of such layers in the functionality and reliability of such devices⁵⁰². Earlier, the breakdown of the dielectric gate was identified as the main cause of the device failure. This led to the emergence of interlayer free stacks, for example, using Germanium²⁸⁰ or metal oxide semi-conductors as the channel⁵⁰³ or electrode material. Later, the presence of defects within the HZO layer upon cycling was also studied⁵⁰⁴. Temperature-dependent transport experiments showed that upon cycling, the energy barrier seen by electrons in the bulk of an HZO film was lowered⁵⁰⁵, indicating a redistribution of defects in the later.

Several studies confront X-Ray Spectroscopy analysis to electrical characterization, shedding light on the key role of contaminants in hafnia. Varying the chemistries (gas, precursors) during the ALD or during the annealing showed that dopants such as Carbon or Hydrogen are detrimental to endurance⁵⁰⁶. It was experimentally observed that MFM stacks deposited in situ show improved endurance compared to stacks exposed to air⁵⁰⁷. The number of works combining X-Ray analysis, eventually Scanning Transmission Electron Microscopy and electrical characterization correlate the increase of the endurance to a decrease in the fraction of *m*-phase. In general, for comparable thicknesses, a larger endurance is also observed, together with a reduced leakage current.

Current and future challenges

Today, the most significant trade-off in terms of endurance is the dynamic range of the device. The number of cycles a given device can endure increases as the applied electric field decreases, and the endurance figure is generally reported for “full” switching operation, i.e. reaching the maximal P_r . The corresponding electric field for HfO₂- based FE is around 2 to 2.5 MV/cm. Operating the device in sub-polarization loops has proven an efficient way of increasing the endurance and eventually working with polarization states that are more stable regarding temporal drift. However, for applications such as synaptic weights for artificial neural networks, an ideal On/Off ratio of 100 is required. Today, many

This is the author's peer reviewed, accepted manuscript. However, the online version of record will be different from this version once it has been copyedited and typeset.

PLEASE CITE THIS ARTICLE AS DOI: 10.1063/1.50148068

technologies of ferroelectric synapses do not yet meet these requirements, and making compromises on the dynamic range to guarantee a large endurance is not always possible.

The most mature HfO₂ devices (FeFET and FTJ) are based on a dielectric interlayer. The parasitic charge trapping during writing was identified as the most detrimental phenomena to the endurance. The injection of electrons or holes in the gate, promoted by large fields, leads to the creation of defects both in the interlayer and in the hafnia. Moreover, these charges screen the ferroelectric polarization charges, reducing the ferroelectric field-effect and, thus, the device performance.

Understanding the role of oxygen vacancies is a critical aspect of solving reliability issues in FE devices. On the one hand, improvements in reliability were obtained by interfacing HZO with a metal oxide electrode such as WO_x, VO_x, TaO_x, RuO_x or CeO_x. Some evidence points to a supply of oxygen atoms from the electrode to HZO during the crystallization, resulting in a FE film with less interfacial oxygen vacancies and improved reliability³⁵². On the other hand, doping hafnia with three-valent atoms such as *La* increases the oxygen vacancy content⁵⁰⁸ but also the energy barrier for the creation of additional oxygen vacancies during cycling. Similarly, controlling the optimal fraction of FE, *o*-phase is not trivial. A slight increase in the tetragonal phase can be beneficial to endurance, as it tends to reduce the coercive field of the thin film⁵⁰⁹. It is the approach explored by the fabrication of superlattices or nanolaminates^{510,349}. It is also the mechanism behind the use of *La*-doping, which limits the crystallization in the *m*-phase but favors the non-polar *t*-phase. But, *La*-doping of HZO also leads to an enhancement of the wake-up behavior. A diminution of the coercive field was also obtained by quenching an epitaxial thin film in a tetragonal phase without any degradation of the remanent polarisation⁵¹¹.

Wake-up is the increase in P_r during field cycling, which can change hysteresis shape. In most cases, a pinched hysteresis loop in the pristine case opens to an unpinched loop during field cycling. Several reasons are given in the literature: There could be charges in the layer that pin the domains and inhibit their switching¹³¹. These charges can be redistributed by the applied external field, unpinning the domains. Furthermore, there may be a field-driven phase transition from a non-polar *t*- to a polar *o*-phase^{330,512}. During field cycling, strain, and stress relaxation can be caused by electronic or ionic charge redistribution or injection.

In addition, ferroelastic switching has been described to cause a 90° domain reorientation from an in-plane polar axis to an out-of-plane polar axis of the polar o-phase^{513,514}. Furthermore, a reversible transition between the polar and antipolar phases has been reported⁵⁶. Wake-up effects can be drastically reduced by optimizing dopant and oxygen vacancy content²⁵, stabilizing the tetragonal phase in the film. From this discussion, it is clear that each materials system possesses an optimal composition, their control will require increasing support from first-principle simulations^{145,515} and experimental work.

Advances in science and engineering to meet these challenges

Regarding the dynamic-range *vs.* endurance trade-off, combining the doping of HZO with ~1-2% mol of group III atoms, with a full stack growth in one batch is a promising route. For example, *La*-HZO thin films show a record endurance of 10¹¹ cycles²⁹⁸ at 2.5 MV/cm, while maintaining a remanent polarization as high as 28 $\mu\text{C}/\text{cm}^2$, 75% of the maximal remanent polarisation obtained at 3.5 MV/cm. Skopin *et al.* Gd-doped hafnia 8.8 nm films⁵¹⁶ reached 10¹⁰ cycles at 4 V, for a remanent polarisation reaching 33 $\mu\text{C}/\text{cm}^2$.

The question of parasitic charge trapping is addressed in various ways. Both on stacks with or without oxide interlayers, the reliability of films grown or crystallized with different annealing techniques are studied, see for example a comparison for HZO/Ge films prepared with Rapid Thermal Annealing *versus* millisecond Flash Lamp Annealing²⁸⁰. Dutta *et al.* recently demonstrated a low voltage, high-speed memory operation with high write endurance using an interlayer-free back-end-of-line (BEOL) compatible FeFET⁴⁰². By gating an amorphous Indium Tungsten Oxide semiconductor channel with a 5 nm HZO film, they report a write voltage of only ± 1.6 V with 20 ns pulses, read-after-write latency of only 300 ns (the absence of interlayer allows a faster de-trapping of charges) and a record high write endurance exceeding 10¹¹ cycles. In TiN/HZO/TiN capacitors, the bottom TiN interface is strongly oxidized during the growth of the hafnia layer. By combining it with a metal oxide bottom interlayer, robust synaptic weights with even thinner (<4 nm) HZO films can also be fabricated in BEOL-compatible conditions, further reducing the electric field required to switch the polarization and reaching durances above 10¹⁰ cycles⁴²⁵.

Tan *et al.* also reported an endurance exceeding 10^{10} cycles in HZO films⁴⁰⁰ by incorporating a high- k SiN_x layer between the Si substrate and the FE. Thanks to the higher permittivity of SiN_x compared to an SiO_2 interface, a reduced electric field is required to switch the FE polarization. As discussed above, introducing a small fraction of t -phase in the film can efficiently reduce the electric field required to switch the polarization without degrading the P_r . In this direction, an approach for obtaining mixed-phase thin films is to minimize the phase transition from tetragonal to orthorhombic during the wake-up. Such a route will favor materials with a high remanent polarization in the pristine state, for example, by optimizing simultaneously the Zr and the oxygen content²⁵. Apart from the group III doping, recent work proposes introducing t -phase spacers (ZrO_2) within the HZO in nanolaminate films⁵¹⁰, creating topological domain walls. Finally, the parasitic charges can be eliminated after writing by an electrical pulse: the waveform is then tailored to de-trap the charges.

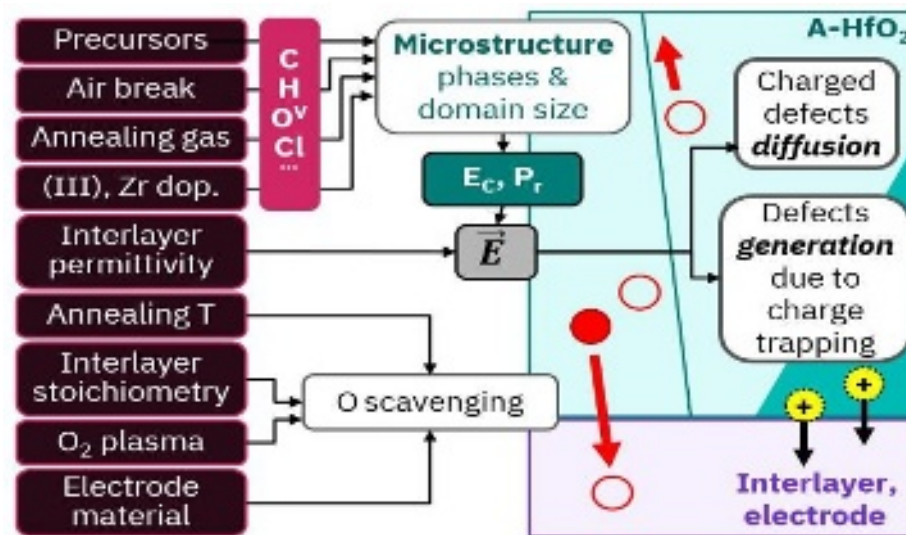

Fig. 21 Endurance: materials and process control hafnia microstructure. As the device is cycled, the existing and newly generated defects redistribute in the layer, eventually leading to the breakdown.

Concluding Remarks

In the last decade, the systematic benchmarking of novel stacks, geometries, and fabrications processes allowed to correlate the endurance properties to materials and electrical properties. These correlations drove the understanding of the device's physics

and, consequently the understanding of the device's reliability. In a feedback loop, this knowledge guided the optimization of existing concepts and the creation of novel ones. As summarized in Fig. 21, the knobs for improving reliability today rely on materials engineering, the growth and crystallization conditions, and the electrical mode of operation. Similarly to ferromagnetic tunnel junctions, FE devices could, in principle, rely on purely electronic effects without any ion motion, oxidoreductions or phase transitions. This exciting absence of intrinsic limitation should continue driving the quest for ever more enduring FE devices in the future.

Acknowledgments

This work has received funding from the c; and from the Swiss National Science Foundation (SNSF) through the projects ALMOND (n°198612) and UNICO (ANR-19-CHR3-0006).

9. Commercial Market opportunities in non-volatile memories

(T. Mikolajick, Uwe Schroeder, and Stefan Slesazeck)

Status

A non-volatile memory is defined by data retention of 10 years at elevated temperatures. For commercial applications, a reference temperature of about 55°C is typically assumed to mimic a typical temperature use profile for a temperature specification of 85°C. For automotive and industrial applications, even higher temperatures up to 165°C can be required. At the same time, a fast re-write speed is required. For random access memory applications, the re-write speed needs to be in the sub-nanoseconds to 10 nanosecond range, while for storage applications, the re-write speed can be in the microsecond to millisecond range. Therefore, there is a difference in dynamics of 11 to 17 orders of magnitude between writing and storing. Today's charge-based non-volatile memories are far from delivering random access functionality and have re-write times at the higher end of the mentioned range, limited endurance, and require high write voltages in the range of 10-20 V. FEs have a voltage-driven switching mechanism and the energy barrier separating the two polarization states is reduced during switching. Therefore, they enable fast switching and non-volatile retention at low write voltages. ~~A37~~ As a consequence, already in the 1950s, the use

of FeRAMs was proposed. Another unique aspect of FEs in non-volatile memories is the fact that three different readout schemes can be used that lead to three fundamental different memory cell concepts, namely a capacitor-based FeRAM, a FeFET, or a FTJ based FeRAM¹³. The three concepts can serve different application requirements. The FeRAM concept is inspired by DRAM, the FeFET has strong similarities with charge-based transistor memories using floating gates or charge trapping layers as used in Flash memories, and finally, the FTJ is a type of resistive switching memory.

The first and only concept that made it to market is FeRAM which was first commercialized in 1993 based on a PZT FE integrated into a CMOS base process⁵¹⁷. Although big hopes were associated with this breakthrough that a non-volatile version of a DRAM would soon become available, the technology made a very slow scaling process, mainly due to the compatibility issues of PZT (and also later SBT) with CMOS processes. The FeFET development struggled from the inherent depolarization field and the low coercive as long as PZT, SBT, and related materials were used⁵¹⁸. First FTJs were only realized mid of the first decade of the 2000s⁴⁰⁷, and even today, they are still in a stage of basic research.

Current and future challenges

The scaling of FeRAM using PZT as a FE has stopped at the 130nm node and is hindered by the fact that up till now, the integration of PZT in scaled 3-dimensional capacitors has not been mastered⁵¹⁹. In contrast, FE HfO₂ can easily be integrated into 3-dimensional capacitors using ALD. However, the high coercive field is the biggest issue for this material system. On the one side, it requires relatively high switching voltages, and switching by sub 1 V V_{DD} available in scaled technologies is very hard to achieve. On the other side, the high field during switching limits endurance. Both issues are currently tackled by engineering the FE and the electrode materials, and slow but continuous progress is visible.

For FeFET devices, the first fully integrated FeFETs based on FE HfO₂ with small dimensions were demonstrated in 2011, and continuous progress has been shown in the last years^{391,520}. Both embedded NVM³⁹¹ and 3D integrated storage type devices⁵²⁰ are currently the main targets, but FeFETs are also hot candidates as primitives in in-memory and neuromorphic computing⁵²¹ (see bottom part of Fig. 22). Here, device-to-device variability

is still a major issue. While realizing more homogenous layers with respect to domain size and orientation is the main topic that is in the focus of the material development, also smart algorithms during writing, as known from floating gate and charge trapping memories, can be used to optimize the behavior of the cells in large arrays⁵²². However, more sophisticated solutions tailored to the specifics of the FE switching will be required in the future.

One of the main challenges in FTJs is the very low read current. Therefore, these devices are not so much in the focus to realize pure memory applications but are mainly considered as artificial synapses in neuromorphic computing systems⁵²¹. Scaling the thickness of the FE is the natural way to increase the read current.

Advances in science and engineering to meet the challenges

Significant progress has been made in optimizing the material properties of FE HfO₂ in the last ten years¹³. For the applications in FeRAM, the technology has gone closer towards fulfilling the specification (see section on FeRAM). However, the final goals with respect to low voltage operation and reliability have not been achieved also, impressive demonstrations, including reliability extrapolation, have been accomplished¹³⁵⁰¹. The topics are mainly addressed by working on the capacitor stack. Thinner FE layers as well as different dopants, can be used to reduce the voltage. At the same time, the reliability needs are tackled by optimizing both the FE material and the electrodes as well as the interface between them¹³.

For FeFET devices, the variability has been continuously reduced in large arrays³⁹¹. However, further improvement is required to scale the cell size to the desired region. Moreover, cell variants like the ferroelectric-metal-field effect transistor (FeMFET) can allow to tailor the cell requirements by decoupling the FE layer optimization from optimizing the underlying field effect transistor at the price of a larger cell size and an additional floating gate³⁵⁷. Moreover, very good progress in retention and endurance was reported^{357,400}. Since using hafnium oxide enables to realize FeFET devices scaled to nm dimensions for the first time, new effects like abrupt and accumulative switching have been discovered that could be explored to realize new functionalities, especially as artificial neurons in neuromorphic computing devices⁵²¹.

For FTJ, many different demonstrations have been done in the last years⁵²². Two paths are taken. One tries to reduce the thickness of the FE into the range of direct tunneling, while the other adds an additional dielectric tunneling layer to at least partially decouple the optimization of the FE from the requirements of achieving a high tunneling current⁴⁷⁹. Two interesting paths have been recently shown for scaling the FE thickness. If the FE is deposited directly on silicon, also very thin films seem to show good FE properties⁴¹². An alternative approach is to bring the film's optimum thickness into the FE phase and thin down the layer using atomic layer etching²⁴⁹. In any case, as mentioned above, FTJs are still in a basic research state, and significant work is still required before such devices can be commercialized.

Concluding remarks

FE materials are ideally suited to realize non-volatile memory cells with very low write power. After some initial success, the field got stuck by the difficulty of integrating perovskites into a CMOS process. The discovery of ferroelectricity in CMOS-compatible HfO₂ and mixed HfO₂/ZrO₂ has revised this field in the last ten years. Impressive demonstrations of both FeRAM and FeFET devices have shown that they can tackle different non-volatile memory use cases like non-volatile RAM, storage class memory, or low-cost embedded non-volatile memories, but for both technologies' reliability issues and for FeFETs variability issues still need to be solved to commercialize the technology. Besides the applications in different memory devices, the mentioned FE devices also show great promise for in-memory and neuromorphic computing. In the last field, also FTJs are an option to realize compact synaptic functions. Figure 22 gives an overview of the possible application fields where FE devices based on HfO₂ could be seen in the future.

This is the author's peer reviewed, accepted manuscript. However, the online version of record will be different from this version once it has been copyedited and typeset.

PLEASE CITE THIS ARTICLE AS DOI: 10.1063/1.50148068

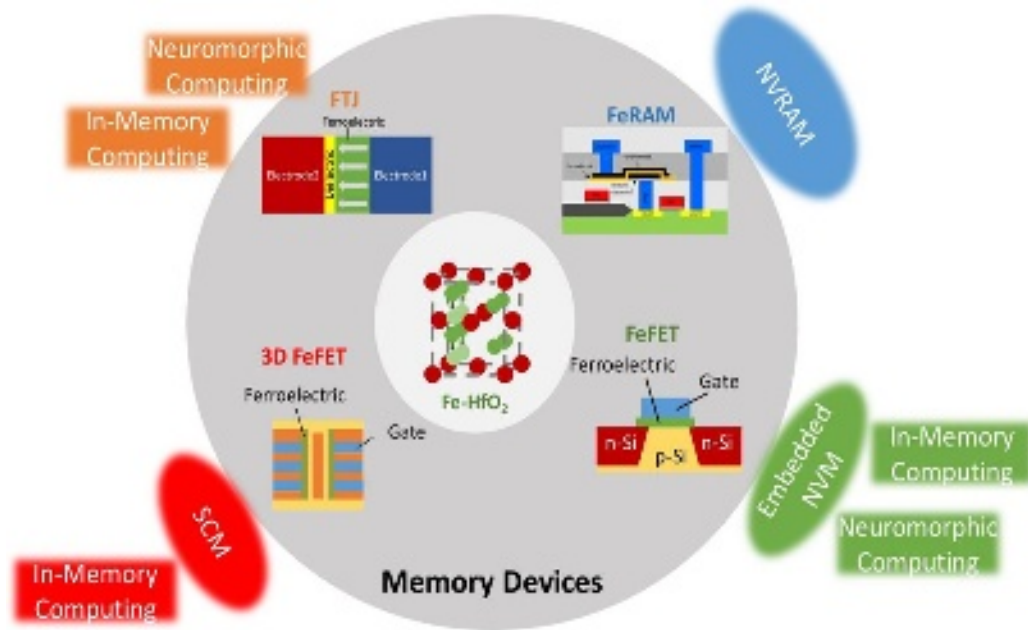

Fig. 22 Devices and possible application fields of ferroelectric devices based on hafnium oxide.

10. Industry prospective (Sou-Chi Chang/Ilya Karpov/Uygar Avci)

One of the approaches to significantly improving computing efficiency is by directly integrating high-speed and high-density memory elements closer to the high-performance computing units (cores), which are typically built by advanced logic transistors; for example, embedded DRAM (eDRAM)⁵²³. However, the scaling of conventional eDRAM has become more and more challenging due to higher transistor leakage, larger aspect ratio of capacitors, and more significant refresh power. On the other hand, FE memory, such as FeRAM, holds a great promise toward highly scalable fast embedded memory solutions because of (i) the similarity of conventional eDRAM in terms of cell structures except for replacing dielectric capacitors with FE capacitors, (ii) better access transistor scaling due to memory bits stored in the bound charge of materials, rather than the free charge at the floating node like conventional DRAM, and (iii) low refresh power thanks to longer retention time from a large energy barrier between two polarization states.

It is well-known that FeRAM based on perovskite FE materials such as $\text{PbZr}_x\text{Ti}_{1-x}\text{O}_3$ (PZT) has been successfully commercialized since early 2000, and the thickness scaling issue due to low coercive field in PZT fundamentally prevents FeRAM from being integrated at any advanced logic technology nodes⁵¹⁹. Since then, not much progress is made in terms of scaling, and FeRAM is positioned only for small niche applications. However, recently, the research field of FeRAM has been re-vitalized due to the unexpected discovery on fluorite-structured HfO_2 -based FEs originated from meta-stable polar *o*-phase in 2011⁵³. HfO_2 -based FE materials overcome the fundamental thickness scaling issues in perovskite FE materials while having low leakage due to a large bandgap. More importantly, HfO_2 is CMOS-compatible as it has been used in the gate stack of state-of-art advanced logic transistors for more than 20 years. Among FE hafnia with different dopants, $\text{Hf}_{1-x}\text{Zr}_x\text{O}_2$ is particularly of interest mainly due to that (i) the thermal budget to crystallize the materials is BEOL compatible, and (ii) the dominant phase can be tuned from monoclinic, tetragonal, to orthorhombic phase through different Hf and Zr ratio¹⁶⁴, making this capacitor-based FE memory as an active research topic among other emerging memory options.

For memory options that are potentially qualified for eDRAM or last-level cache, the read and write operation times need to be less than 10 ns, the maximum operation voltage needs not to exceed 2 V with either positive or negative polarity depending on the cell designs, retention time needs to be longer than 1 ms, and read and write endurance cycles to be higher than 10^{12} ^{524,525}. Note that these device metrics need to be satisfied at elevated temperature as the cache-level memory is close to the core computing units that are typically hot during operations. Also, to achieve a competitive capacity, a tight distribution of variations in device metrics is required at the relevant small device dimension. To satisfy these specifications, functional FeRAM cells with scaled deep-trench AFE HZO capacitors ($0.008 \mu\text{m}^2$) have been developed and demonstrated at elevated temperature to deliver (i) operation voltage range from -1.8V to 1V, (ii) read and write operation speed down to 2ns, (iii) healthy retention up to 10sec, (iv) robust read and write endurance cycles up to 10^{12} , and (v) acceptable variations at 4σ across a 300mm-scaled wafer^{524,525}. Note that -1.8V is the voltage across the FE capacitor, which is defined from

the inner node between FE capacitor and access transistor in a FeRAM cell and is typically implemented through voltage schemes such as high plate line (PL) and low bit line (BL).

Even though HfO₂-based AFE capacitors close to higher-level cache memory specs have been achieved, it is of great importance to further improve read and write speed as well as reduce the operation voltage while maintaining robust retention, endurance, and variation to make HfO₂-based FeRAM a scalable memory option. More importantly, in addition to cell size scaling by making both access transistor and capacitor smaller, cost/density per bit in HfO₂-based FeRAM can be significantly improved by vertically stacking capacitors, thanks to multiple bits defined through one single lithography step⁵²⁴. Note that in this stacked-capacitors architecture, all the capacitors share the same bit line (BL) with individual plate lines (PL) controls, and therefore capacitors with strong read disturb immunity are the key elements to achieve such a high density with the right functionality⁵²⁴.

In addition to FE or AFE capacitor-based memory cells, FeFETs, where the conventional high-k dielectric is replaced by FE oxide⁵²⁶, are also attractive as a high-density embedded memory solution, since the memory cell is composed of only one transistor, potentially achieving very high-density in its 3-dimensional (3-D) configurations. The bits stored in FE materials are converted to high and low source-to-drain currents for fast read operations. However, to be a viable device option for high-speed and high-density embedded memory applications, there are still several challenges that need to be addressed in FeFETs such as high operation voltage, slow write speed, limited write endurance, required long delay between initial read operation after the write operation⁵²⁷, and significant degradation in variations in scaled dimension⁵²⁸.

Moving toward high capacity with fast FE memory, a configuration based on a crossbar array is of great interest, as it can be easily stacked with low cost to further increase the density⁵²⁹. To fit into such an architecture, FTJs or diodes with a built-in selector function can be potentially served as a compact two-terminal cell structure due to (i) a large enough electric field across the junction enabling fast polarization switching with low operation voltage, (ii) robust write endurance based on polarization-dependent on and off currents, and (iii) high array scalability thanks to low write currents. Nevertheless, low read currents with a poor on/off ratio are observed for these devices and need to be further improved to

make either FTJs or diodes enable this option in the fast embedded memory space⁵³⁰. Table II summarizes the pros and remaining challenges for different FE devices for high-speed and high-density embedded memory applications.

Except for near-memory computing, where computing occurs close to fast and high-density embedded memory elements, direct computing in memory also provides another path for breakthroughs in computing efficiency⁵³¹. FE capacitors, transistors, tunnel junctions, and diodes all can be utilized as critical multi-states non-volatile memory elements for functions such as dot product due to partial polarization or domain switching in HfO₂-based FE materials. In general, multi-state FE memory devices with a tight distribution of each state with capability for linear potentiation and depression are desired for in-memory computing. Such functionality relies on precise controls in domain structures that remain challenging in scaled polycrystalline hafnia-based FE films prepared by industry-friendly processes such as ALD and ALE.

The discovery of hafnia-based FE materials such as HZO opens plenty of opportunities to significantly improve future computing through integrating different types of FE memory devices into state-of-art advanced CMOS technologies. Consequently, having a comprehensive understanding of this class of materials as well as their interaction with either metals used as electrodes or the dielectrics used as at interfaces, becomes vitally important to address the current challenges and to overcome the current computing bottleneck and enable the breakthroughs in computing efficiency in the future. PLD and MBE thin film fabrication technology have been instrumental for the in-depth thin film research and characterization, while MOCVD, ALD, Sputter PVD and CSD technologies are favorable for high-volume manufacturing. Device architectures as well as device size, often put constrains on the choice for the film deposition technology. ALD hardware and technology advancements hold the most promise for 3D device stacking in a bit cost scalable architectures at this time.

Table II. Summary of pros and remaining challenges for different type of FE devices for high-speed and high-density embedded memory applications.

Device Type	FeCAP	FeFET	FTJ
Pros	High speed, Low voltage, Healthy retention, Robust endurance, Low variations, Low cost for high-density vertical stack	Promising density in the form of 3-D vertical stack	Promising density in the form of cross-bar array
Challenges	Continue voltage scaling, Disturb immunity	High voltage, Slow speed, Limited write endurance, Long delay between read and write, Large variations in scaled dimension	Slow read, Small on and off ratio

11. Conclusions and Outlook (Uwe Schroeder/José P. B. Silva)

Ferroelectric HfO₂ and ZrO₂ are expected to be the dominant materials in memory technologies in the short to medium term, with further promising applications in other areas such as the energy storage. To achieve this, materials' properties improvement is needed. There are many challenges left in all aspects of bulk growth, thin-film growth, and device processing.

With respect to bulk growth, laser floating zone method seems to be the most convenient method to obtain o-phase HfO₂:Y, but it would be relevant to investigate other dopants and also yttrium-stabilized zirconia, since it is a famous ionic conductor material. It was important to be able to find FE properties in bulk material and not just in small grains. Here, a solid solution with uniform Y doping in HfO₂ resulted in a centimeter-sized rod after rapid cooling of a molten liquid.

In the case of thin-film growth, there is a very large range of techniques that are being used to grow FE HfO₂ and ZrO₂ that have specific advantages and disadvantages inherent to the deposition process itself. However, fundamental research on the physical properties of these materials is important and should be conducted with the support of the academic community. In particular, a more complete understanding of the physical properties of point defects and interfacial role is highly required to fully understand the materials devices

behavior. Furthermore, we should highlight the growing interest in epitaxial films, which are now being intensively investigated, due to the reduction/elimination of some of the current issues of polycrystalline thin films, such as the wake-up effect. In this case, the PLD growth method seems to be the most used method due to the high homogeneity, flat surfaces and interfaces, and excellent functional properties.

To overcome the challenges of the wake-up effect, large switching voltages, moderate retention and endurance, imposed by FE HfO₂ and ZrO₂-based materials, different strategies, such as doping, defect engineering, interface engineering, electrodes optimization and laminated structures are currently being investigated. Limitations of controlling structure, interfacial thickness, chemistry, and physical properties is primarily a function of the selected deposition technique, processing conditions, and source materials.

As for device improvement, it is still necessary to improve reliability of FE HfO₂ and ZrO₂-based capacitors. As discussed, charge injection and movement need to be reduced to enhance endurance and retention. Here, a lower switching voltage, a stable P_r which is not too large and a low defect density at the electrode interface and within the bulk of the ferroelectric layer are required. In the case of FTJs, it is critical to reduce the switching fields, and thus an understanding of the dynamics of polarization switching between the different phases is still needed. Interestingly, it is also possible to use a thick HfO₂ layer that does not support direct tunneling but can become conductive through doping. This should allow the development of new devices and their optimization in the near future. On the other hand, in the case of supercapacitors, it will be necessary to increase the ESD by ~50%, to ~150 J cm⁻³, while keeping an efficiency of ~95% and therefore different strategies are anticipated to achieve this.

In 2021, the tenth anniversary of the revolutionary discovery of the ferroelectricity in Si-doped HfO₂, which stimulated intensive international research on these materials, was completed. In this decade, FE HfO₂ and ZrO₂-based materials have attracted the interest of the scientific community, and many fundamental material and device technologies have been created. In addition, manufacturing companies started to develop their way in marketing some of these devices. However, for both FeRAM and FeFET devices, the problems of reliability and, for FeFETs, the additional problem of variability for scaled

devices must be solved in order to commercialize the technology. Besides that, these materials also show potential for supercapacitors, in-memory and neuromorphic computing.

We expect that FE HfO₂ and ZrO₂-based thin films reach the stage of the device's practical realization and industrialization in the following decade, providing valuable contributions to the global societal challenges.

References

- 1 A. Fernandez, M. Acharya, H.-G. Lee, J. Schimpf, Y. Jiang, D. Lou, Z. Tian, and L.W. Martin, *Advanced Materials* **34**, 2108841 (2022).
- 2 M.E. Lines and A.M. Glass, *Principles and Applications of Ferroelectrics and Related Materials* (Oxford University Press, 2001).
- 3 S. Das, Z. Hong, M. McCarter, P. Shafer, Y.-T. Shao, D.A. Muller, L.W. Martin, and R. Ramesh, *APL Materials* **8**, 120902 (2020).
- 4 S. Chen, S. Yuan, Z. Hou, Y. Tang, J. Zhang, T. Wang, K. Li, W. Zhao, X. Liu, L. Chen, L.W. Martin, and Z. Chen, *Advanced Materials* **33**, 2000857 (2020).
- 5 A.K. Yadav, C.T. Nelson, S.L. Hsu, Z. Hong, J.D. Clarkson, C.M. Schlepütz, A.R. Damodaran, P. Shafer, E. Arenholz, L.R. Dedon, D. Chen, A. Vishwanath, A.M. Minor, L.Q. Chen, J.F. Scott, L.W. Martin, and R. Ramesh, *Nature* **530**, 198 (2016).
- 6 L. Qi, S. Ruan, and Y.-J. Zeng, *Advanced Materials* **33**, 2005098 (2021).
- 7 M. Wu, *ACS Nano* **15**, 9229 (2021).
- 8 J. Wu, H.-Y. Chen, N. Yang, J. Cao, X. Yan, F. Liu, Q. Sun, X. Ling, J. Guo, and H. Wang, *Nature Electronics* **3**, 466 (2020).
- 9 D. Jena, R. Page, J. Casamento, P. Dang, J. Singhal, Z. Zhang, J. Wright, G. Khalsa, Y. Cho, and H.G. Xing, *Japanese Journal of Applied Physics* **58**, 0801 (2019).
- 10 T. Mikolajick, U. Schroeder, and M.H. Park, *Applied Physics Letters* **118**, 180402 (2021).

- 11 S.S. Cheema, D. Kwon, N. Shanker, R. dos Reis, S.-L. Hsu, J. Xiao, H. Zhang, R. Wagner, A. Datar, M.R. McCarter, C.R. Serrao, A.K. Yadav, G. Karbasian, C.-H. Hsu, A.J. Tan, L.-C. Wang, V. Thakare, X. Zhang, A. Mehta, E. Karapetrova, R.V. Chopdekar, P. Shafer, E. Arenholz, C. Hu, R. Proksch, R. Ramesh, J. Ciston, and S. Salahuddin, *Nature* **580**, 478 (2020).
- 12 I. Fina and F. Sánchez, *ACS Applied Electronic Materials* **3**, 1530 (2021).
- 13 U. Schroeder, M.H. Park, T. Mikolajick, and C.S. Hwang, *Nature Reviews Materials* **7**, 653 (2022).
- 14 J.F. Scott, *Journal of Physics: Condensed Matter* **20**, 021001 (2007).
- 15 H.-J. Lee, M. Lee, K. Lee, J. Jo, H. Yang, Y. Kim, S.C. Chae, U. Waghmare, and J.H. Lee, *Science* **369**, 1343 (2020).
- 16 T.D. Huan, V. Sharma, G.A. Rossetti, and R. Ramprasad, *Physical Review B* **90**, 064111 (2014).
- 17 S.E. Reyes-Lillo, K.F. Garrity, and K.M. Rabe, *Physical Review B* **90**, 140103 (2014).
- 18 Y. Qi, S. Singh, C. Lau, F.-T. Huang, X. Xu, F.J. Walker, C.H. Ahn, S.-W. Cheong, and K.M. Rabe, *Physical Review Letters* **125**, 257603 (2020).
- 19 Y. Wei, P. Nukala, M. Salverda, S. Matzen, H.J. Zhao, J. Momand, A.S. Everhardt, G. Agnus, G.R. Blake, P. Lecoeur, B.J. Kooi, J. Íñiguez, B. Dkhil, and B. Noheda, *Nature Materials* **17**, 1095 (2018).
- 20 U. Schroeder, T. Mittmann, M. Materano, P.D. Lomenzo, P. Edgington, Y.H. Lee, M. Alotaibi, A.R. West, T. Mikolajick, A. Kersch, and J.L. Jones, *Advanced Electronic Materials* **8**, 2200265 (2022).
- 21 L. AzevedoAntunes, R. Ganser, C. Kuenneth, and A. Kersch, *Physica Status Solidi RRL* **16**, 2100636 (2022).
- 22 R. Materlik, C. Künneth, and A. Kersch, *Journal of Applied Physics* **117**, 134109 (2015).

- 23 R. Batra, T.D. Huan, J.L. Jones, G. Rossetti, and R. Ramprasad, *The Journal of Physical Chemistry C* **121**, 4139 (2017).
- 24 X. Xu, F.-T. Huang, Y. Qi, S. Singh, K.M. Rabe, D. Obeysekera, J. Yang, M.-W. Chu, and S.-W. Cheong, *Nature Materials* **20**, 826 (2021).
- 25 M. Materano, T. Mittmann, P.D. Lomenzo, C. Zhou, J.L. Jones, M. Falkowski, A. Kersch, T. Mikolajick, and U. Schroeder, *ACS Applied Electronic Materials* **2**, 3618 (2020).
- 26 R. Batra, T.D. Huan, G.A. Rossetti, and R. Ramprasad, *Chemistry of Materials* **29**, 9102 (2017).
- 27 C. Künneth, R. Materlik, M. Falkowski, and A. Kersch, *ACS Applied Nano Materials* **1**, 254 (2017).
- 28 R. Materlik, C. Künneth, M. Falkowski, T. Mikolajick, and A. Kersch, *Journal of Applied Physics* **123**, 164101 (2018).
- 29 S. Dutta, H. Aramberri, T. Schenk, and J. Íñiguez, *Physica Status Solidi RRL* **14**, 2000047 (2020).
- 30 J. Liu, S. Liu, L.H. Liu, B. Hanrahan, and S.T. Pantelides, *Physical Review Applied* **12**, (2019).
- 31 S. Dutta, P. Buragohain, S. Glinsek, C. Richter, H. Aramberri, H. Lu, U. Schroeder, E. Defay, A. Gruverman, and J. Íñiguez, *Nature Communications* **12**, 7301 (2021).
- 32 K.M.R. Yubo Qi Sebastian E. Reyes-Lillo, <https://doi.org/10.48550/ArXiv.2204.06999> (2022).
- 33 S. Clima, D.J. Wouters, C. Adelman, T. Schenk, U. Schroeder, M. Jurczak, and G. Pourtois, *Applied Physics Letters* **104**, 092906 (2014).
- 34 H. Aramberri and J. Íñiguez, *ArXiv* **arXiv:2302.00688**, (2023).
- 35 M. Falkowski and A. Kersch, *ACS Applied Materials Interfaces* **12**, 32915 (2020).

- 36 R. Ganser, S. Bongarz, A. von Mach, L.A. Antunes, and A. Kersch, *Physical Review Applied* **18**, 054066 (2022).
- 37 F. Delodovici, P. Barone, and S. Picozzi, *Physical Review Materials* **5**, 064405 (2021).
- 38 Y. Qi, S. Singh, and K.M. Rabe, <https://doi.org/10.48550/ArXiv.2108.12538> (2022).
- 39 H.-J. Lee, M. Lee, K. Lee, J. Jo, H. Yang, Y. Kim, S.C. Chae, U. Waghmare, and J.H. Lee, *Science* **369**, 1343 (2020).
- 40 J.-H. Yuan, G.-Q. Mao, K.-H. Xue, N. Bai, C. Wang, Y. Cheng, H. Lyu, H. Sun, X. Wang, and X. Miao, *Chemistry of Materials* **35**, 94 (2022).
- 41 M. Materano, P.D. Lomenzo, H. Mulaosmanovic, M. Hoffmann, A. Toriumi, T. Mikolajick, and U. Schroeder, *Applied Physics Letters* **117**, 262904 (2020).
- 42 W. Ding, Y. Zhang, L. Tao, Q. Yang, and Y. Zhou, *Acta Materialia* **196**, 556 (2020).
- 43 D.-H. Choe, S. Kim, T. Moon, S. Jo, H. Bae, S.-G. Nam, Y.S. Lee, and J. Heo, *Materials Today* **50**, 8 (2021).
- 44 P. Buragohain, A. Erickson, T. Mimura, T. Shimizu, H. Funakubo, and A. Gruverman, **32**, 2108876 (2021).
- 45 Y. Qi and K.M. Rabe, *Physical Review B* **102**, 214108 (2020).
- 46 M. Falkowski and A. Kersch, *Applied Physics Letters* **118**, 032905 (2021).
- 47 J. Wei, L. Jiang, M. Huang, Y. Wu, and S. Chen, **31**, 2104913 (2021).
- 48 J. Wu, Y. Zhang, L. Zhang, and S. Liu, *Physical Review B* **103**, 024108 (2021).
- 49 C. Verdi, F. Karsai, P. Liu, R. Jinnouchi, and G. Kresse, *Npj Computational Materials* **7**, 156 (2021).
- 50 Q. Wu, B. He, T. Song, J. Gao, and S. Shi, *Computational Materials Science* **125**, 243 (2016).
- 51 M. Hoffmann, F.P.G. Fengler, M. Herzig, T. Mittmann, B. Max, U. Schroeder, R. Negrea, P. Lucian, S. Slesazek, and T. Mikolajick, *Nature* **565**, 464 (2019).

- 52 J. Íñiguez, P. Zubko, I. Luk'yanchuk, and A. Cano, *Nature Reviews Materials* **4**, 243 (2019).
- 53 T.S. Böske, J. Müller, D. Bräuhäus, U. Schröder, and U. Böttger, *Applied Physics Letters* **99**, 102903 (2011).
- 54 S. Fan, S. Singh, X. Xu, K. Park, Y. Qi, S.W. Cheong, D. Vanderbilt, K.M. Rabe, and J.L. Musfeldt, *Npj Quantum Materials* **7**, 32 (2022).
- 55 T. Kiguchi, T. Shiraishi, T. Shimizu, H. Funakubo, and T.J. Konno, *Japanese Journal of Applied Physics* **57**, 11 (2018).
- 56 Y. Cheng, Z. Gao, K.H. Ye, H.W. Park, Y. Zheng, Y. Zheng, J. Gao, M.H. Park, J.-H. Choi, K.-H. Xue, C.S. Hwang, and H. Lyu, *Nature Communications* **13**, (2022).
- 57 S. Oh, H. Kim, A. Kashir, and H. Hwang, *Applied Physics Letters* **117**, 252906 (2020).
- 58 B.Y. Kim, H.W. Park, S.D. Hyun, Y.B. Lee, S.H. Lee, M. Oh, S.K. Ryoo, I.S. Lee, S. Byun, D. Shim, D.-Y. Cho, M.H. Park, and C.S. Hwang, *Advanced Electronic Materials* **8**, 2100042 (2021).
- 59 K. Katayama, T. Shimizu, O. Sakata, T. Shiraishi, S. Nakamura, T. Kiguchi, A. Akama, T.J. Konno, H. Uchida, and H. Funakubo, *Journal of Applied Physics* **119**, 134101 (2016).
- 60 Y. Yun, P. Buragohain, M. Li, Z. Ahmadi, Y. Zhang, X. Li, H. Wang, J. Li, P. Lu, L. Tao, H. Wang, J.E. Shield, E.Y. Tsymbal, A. Gruverman, and X. Xu, *Nature Materials* **21**, 903 (2022).
- 61 M. Sung, K. Rho, J. Kim, J. Cheon, K. Choi, D. Kim, H. Em, G. Park, J. Woo, Y. Lee, J. Ko, M. Kim, G. Lee, S.W. Ryu, D.S. Sheen, Y. Joo, S. Kim, C.H. Cho, M.-H. Na, and J. Kim, in *2021 IEEE International Electron Devices Meeting (IEDM)* (IEEE, 2021), pp. 33.3.1–33.3.4.
- 62 S.S. Cheema, N. Shanker, S.-L. Hsu, Y. Rho, C.-H. Hsu, V.A. Stoica, Z. Zhang, J.W. Freeland, P. Shafer, C.P. Grigoropoulos, J. Ciston, and S. Salahuddin, *Science* **376**, 648 (2022).

- 63 S.S. Cheema, N. Shanker, L.-C. Wang, C.-H. Hsu, S.-L. Hsu, Y.-H. Liao, M.S. Jose, J. Gomez, W. Chakraborty, W. Li, J.-H. Bae, S.K. Volkman, D. Kwon, Y. Rho, G. Pinelli, R. Rastogi, D. Pipitone, C. Stull, M. Cook, B. Tyrrell, V.A. Stoica, Z. Zhang, J.W. Freeland, C.J. Tassone, A. Mehta, G. Saheli, D. Thompson, D.I. Suh, W.-T. Koo, K.-J. Nam, D.J. Jung, W.-B. Song, C.-H. Lin, S. Nam, J. Heo, N. Parihar, C.P. Grigoropoulos, P. Shafer, P. Fay, R. Ramesh, S. Mahapatra, J. Ciston, S. Datta, M. Mohamed, C. Hu, and S. Salahuddin, *Nature* **604**, 65 (2022).
- 64 P. Buragohain, H. Lu, C. Richter, T. Schenk, P. Kariuki, S. Glinsek, H. Funakubo, J. Íñiguez, E. Defay, U. Schroeder, and A. Gruverman, *Advanced Materials* **34**, 2206237 (2022).
- 65 A. Chouprik, R. Kirtaev, E. Korostylev, V. Mikheev, M. Spiridonov, and D. Negrov, *Nanomaterials* **12**, 1483 (2022).
- 66 J. Liu, S. Liu, J.-Y. Yang, and L. Liu, *Physical Review Letters* **125**, 197601 (2020).
- 67 S. Kirbach, M. Lederer, S. Eßlinger, C. Mart, M. Czernohorsky, W. Weinreich, and T. Wallmersperger, *Applied Physics Letters* **118**, 012904 (2021).
- 68 T. Schenk, N. Godard, A. Mahjoub, S. Girod, A. Matavz, V. Bobnar, E. Defay, and S. Glinsek, *Phys. Status Solidi RRL* **14**, 1900626 (2019).
- 69 L. Collins, Y. Liu, O.S. Ovchinnikova, and R. Proksch, *ACS Nano* **13**, 8055 (2019).
- 70 R.K. Vasudevan, N. Balke, P. Maksymovych, S. Jesse, and S.V. Kalinin, *Applied Physics Reviews* **4**, 021302 (2017).
- 71 K.M.R. Yubo Qi Sebastian E. Reyes-Lillo, <https://doi.org/10.48550/ArXiv.2204.06999> (2022).
- 72 D.-S. Park, M. Hadad, L.M. Riemer, R. Ignatans, D. Spirito, V. Esposito, V. Tileli, N. Gauquelin, D. Chezganov, D. Jannis, J. Verbeeck, S. Gorfman, N. Pryds, P. Muralt, and D. Damjanovic, *Science* **375**, 653 (2022).
- 73 S. Wada, H. Kakemoto, and T. Tsurumi, *Materials Transactions* **45**, 178 (2004).

- 74 S. Starschich, T. Schenk, U. Schroeder, and U. Boettger, *Applied Physics Letters* **110**, 182905 (2017).
- 75 W. Zhong, D. Vanderbilt, and K.M. Rabe, *Physical Review Letters* **73**, 1861 (1994).
- 76 J.C. Wojde, P. Hermet, M.P. Ljungberg, P. Ghosez, and J. Iniguez, *Journal of Physics: Condensed Matter* **25**, 305401 (2013).
- 77 T.P. Senftle, S. Hong, M.M. Islam, S.B. Kylasa, Y. Zheng, Y.K. Shin, C. Junkermeier, R. Engel-Herbert, M.J. Janik, H.M. Aktulga, T. Verstraelen, A. Grama, and A.C.T. van Duin, *Npj Computational Materials* **2**, 15011 (2016).
- 78 S. Tinte, M.G. Stachiotti, M. Sepliarsky, R.L. Migoni, and C.O. Rodriguez, *Journal of Physics: Condensed Matter* **11**, 9679 (1999).
- 79 Y.-H. Shin, V.R. Cooper, I. Grinberg, and A.M. Rappe, *Physical Review B* **71**, 054104 (2005).
- 80 J. Liu, S. Liu, L.H. Liu, B. Hanrahan, and S.T. Pantelides, *Physical Review Applied* **12**, 034032 (2019).
- 81 S. Jachalke, T. Schenk, M.H. Park, U. Schroeder, T. Mikolajick, H. Stöcker, E. Mehner, and D.C. Meyer, *Applied Physics Letters* **112**, 142901 (2018).
- 82 P.D. Lomenzo, R. Alcala, C. Richter, S. Li, T. Mikolajick, and U. Schroeder, *Applied Physics Letters* **119**, 112903 (2021).
- 83 C. Mart, T. Kämpfe, S. Zybell, and W. Weinreich, *Applied Physics Letters* **112**, 052905 (2018).
- 84 C. Mart, K. Kühnel, T. Kämpfe, S. Zybell, and W. Weinreich, *Applied Physics Letters* **114**, 102903 (2019).
- 85 P.D. Lomenzo, S. Jachalke, H. Stoecker, E. Mehner, C. Richter, T. Mikolajick, and U. Schroeder, *Nano Energy* **74**, 104733 (2020).
- 86 C. Mart, T. Kämpfe, K. Kühnel, M. Czernohorsky, S. Kolodinski, M. Wiatr, W. Weinreich, and L.M. Eng, *APL Materials* **9**, 051120 (2021).

- 87 M. Neuber, M.W. Lederer, K. Mertens, T. Kämpfe, M. Czernohorsky, and K. Seidel, *Crystals* **12**, 1115 (2022).
- 88 M. Hoffmann, U. Schroeder, C. Künneth, A. Kersch, S. Starschich, U. Böttger, and T. Mikolajick, *Nano Energy* **18**, 154 (2015).
- 89 B. Ploss and S. Bauer, *Sensors and Actuators A: Physical* **26**, 407 (1991).
- 90 Q. Zhang and R.W. Whatmore, *Journal of Applied Physics* **94**, 5228 (2003).
- 91 T. Ali, D. Lehniger, M. Lederer, S. Li, K. Kühnel, C. Mart, K. Mertens, R. Hoffmann, R. Olivo, J. Emara, K. Biedermann, J. Metzger, R. Binder, M. Czernohorsky, T. Kämpfe, J. Müller, K. Seidel, and L.M. Eng, *Advanced Electronic Materials* **8**, 2100837 (2022).
- 92 C. Mart, W. Weinreich, M. Czernohorsky, S. Riedel, S. Zybell, and K. Kuhnel, in *2018 48th European Solid-State Device Research Conference (ESSDERC)* (IEEE, 2018), pp. 130–133.
- 93 R. Lehmkau, D. Mutschall, A. Kaiser, M. Ebermann, N. Neumann, M. Czernohorsky, M. Neuber, K. Hiller, J. Seiler, and T. Großmann, in *Oxide-Based Materials and Devices XIII*, edited by F.H. Teherani and D.J. Rogers (SPIE, 2022).
- 94 S. Jachalke, E. Mehner, H. Stöcker, J. Hanzig, M. Sonntag, T. Weigel, T. Leisegang, and D.C. Meyer, *Applied Physics Reviews* **4**, 021303 (2017).
- 95 A.K. Jonscher, *Journal of the Chemical Society Faraday Transactions 2* **82**, 75 (1986).
- 96 R. Landauer, *Collective Phenomena* **2**, 167 (1976).
- 97 A.M. Bratkovsky and A.P. Levanyuk, *Applied Physics Letters* **89**, 253108 (2006).
- 98 S. Salahuddin and S. Datta, *Nano Letters* **8**, 405 (2007).
- 99 A.I. Khan, D. Bhowmik, P. Yu, S.J. Kim, X. Pan, R. Ramesh, and S. Salahuddin, *Applied Physics Letters* **99**, 113501 (2011).
- 100 P. Zubko, J.C. Wojdeł, M. Hadjimichael, S. Fernandez-Pena, A. Sené, I. Luk'yanchuk, J.-M. Triscone, and J. Íñiguez, *Nature* **534**, 524 (2016).

- 101 M. Hoffmann, S. Slesazeck, and T. Mikolajick, *APL Materials* **9**, 020902 (2021).
- 102 M. Hoffmann and S. Salahuddin, *MRS Bulletin* **46**, 930 (2021).
- 103 M. Hoffmann, M. Pešić, K. Chatterjee, A.I. Khan, S. Salahuddin, S. Slesazeck, U. Schroeder, and T. Mikolajick, *Advanced Functional Materials* **26**, 8643 (2016).
- 104 K.D. Kim, Y.J. Kim, M.H. Park, H.W. Park, Y.J. Kwon, Y.B. Lee, H.J. Kim, T. Moon, Y.H. Lee, S.D. Hyun, B.S. Kim, and C.S. Hwang, *Advanced Functional Materials* **29**, 1808228 (2019).
- 105 M. Hoffmann, Z. Wang, N. Tasneem, A. Zubair, P.V. Ravindran, M. Tian, A.A. Gaskell, D. Triyoso, S. Consiglio, K. Tapily, R. Clark, J. Hur, S.S.K. Pentapati, S.K. Lim, M. Dopita, S. Yu, W. Chern, J. Kacher, S.E. Reyes-Lillo, D. Antoniadis, J. Ravichandran, S. Slesazeck, T. Mikolajick, and A.I. Khan, *Nature Communications* **13**, 1228 (2022).
- 106 M. Hoffmann, F.P.G. Fengler, B. Max, U. Schroeder, S. Slesazeck, and T. Mikolajick, *Advanced Energy Materials* **9**, 1901154 (2019).
- 107 T. Kim, J.A. del Alamo, and D.A. Antoniadis, *IEEE Transactions on Electron Devices* **69**, 4016 (2022).
- 108 Z. Liu, H. Jiang, B. Ordway, and T.P. Ma, *IEEE Electron Device Letters* **41**, 1492 (2020).
- 109 M. Si, C.-J. Su, C. Jiang, N.J. Conrad, H. Zhou, K.D. Maize, G. Qiu, C.-T. Wu, A. Shakouri, M.A. Alam, and P.D. Ye, *Nature Nanotechnology* **13**, 24 (2017).
- 110 M.A. Alam, M. Si, and P.D. Ye, *Applied Physics Letters* **114**, 090401 (2019).
- 111 B. Obradovic, T. Rakshit, R. Hatcher, J.A. Kittl, and M.S. Rodder, *IEEE Transactions on Electron Devices* **65**, 5157 (2018).
- 112 J.V. Houdt and P. Roussel, *IEEE Electron Device Letters* **39**, 877 (2018).
- 113 M. Hoffmann, S. Slesazeck, U. Schroeder, and T. Mikolajick, *Nature Electronics* **3**, 504 (2020).

- 114 A.K. Yadav, K.X. Nguyen, Z. Hong, P. García-Fernández, P. Aguado-Puente, C.T. Nelson, S. Das, B. Prasad, D. Kwon, S. Cheema, A.I. Khan, C. Hu, J. Íñiguez, J. Junquera, L.-Q. Chen, D.A. Muller, R. Ramesh, and S. Salahuddin, *Nature* **565**, 468 (2019).
- 115 E.D. Grimley, T. Schenk, T. Mikolajick, U. Schroeder, and J.M. LeBeau, *Advanced Materials Interfaces* **5**, 1701258 (2018).
- 116 A.K. Saha and S.K. Gupta, *Scientific Reports* **10**, 10207 (2020).
- 117 H.W. Park, M. Oh, and C.S. Hwang, *Advanced Functional Materials* **32**, 2200389 (2022).
- 118 M. Hoffmann, M. Gui, S. Slesazek, R. Fontanini, M. Segatto, D. Esseni, and T. Mikolajick, *Advanced Functional Materials* **32**, 2108494 (2021).
- 119 H. Lee, D.-H. Choe, S. Jo, J.-H. Kim, H.H. Lee, H.-J. Shin, Y. Park, S. Kang, Y. Cho, S. Park, T. Moon, D. Eom, M. Leem, Y. Kim, J. Heo, E. Lee, and H. Kim, *ACS Applied Materials Interfaces* **13**, 36499 (2021).
- 120 W. Cao and K. Banerjee, *Nature Communications* **11**, 196 (2020).
- 121 M. Hoffmann, *Innovation and Emerging Technologies* **9**, 2240002 (2022).
- 122 G.-D. Zhao, X. Liu, W. Ren, X. Zhu, and S. Yu, *Physical Review B* **106**, 064104 (2022).
- 123 A. Kashir, M.G. Farahani, J. Lančok, H. Hwang, and S. Kamba, *Nanotechnology* **33**, 155703 (2022).
- 124 S. Lombardo, C. Nelson, K. Chae, S. Reyes-Lillo, M. Tian, N. Tasneem, Z. Wang, M. Hoffmann, D. Triyoso, S. Consiglio, K. Tapily, R. Clark, G. Leusink, K. Cho, A. Kummel, J. Kacher, and A. Khan, in *2020 IEEE Symposium on VLSI Technology* (IEEE, 2020), pp. 1–2.
- 125in *International Electron Devices Meeting (IEDM)* (2022), pp. 13.2.1–13.2.4.
- 126 N. Zagni, P. Pavan, and M.A. Alam, *Applied Physics Letters* **114**, 233102 (2019).

- 127 I. Stolichnov, M. Cavaliere, C. Gastaldi, M. Hoffmann, U. Schroeder, T. Mikolajick, and A.M. Ionescu, *Applied Physics Letters* **117**, 172902 (2020).
- 128 S. Datta, <https://doi.org/10.48550/ArXiv.2112.12687> (2022).
- 129 G. Catalan, J. Seidel, R. Ramesh, and J.F. Scott, *Reviews of Modern Physics* **84**, 119 (2012).
- 130 P. Zhou, B. Zeng, W. Yang, J. Liao, F. Meng, Q. Zhang, L. Gu, S. Zheng, M. Liao, and Y. Zhou, *Acta Materialia* **232**, 117920 (2022).
- 131 P. Buragohain, C. Richter, T. Schenk, H. Lu, T. Mikolajick, U. Schroeder, and A. Gruverman, *Applied Physics Letters* **112**, 222901 (2018).
- 132 H. Bae, S.G. Nam, T. Moon, Y. Lee, S. Jo, D.-H. Choe, S. Kim, K.-H. Lee, and J. Heo, in *2020 IEEE International Electron Devices Meeting (IEDM)* (IEEE, 2020), pp. 31.3.1–31.3.4.
- 133 K. Lee, S. Kim, J.-H. Lee, B.-G. Park, and D. Kwon, *IEEE Electron Device Letters* **42**, 323 (2021).
- 134 X. Lyu, P.R. Shrestha, M. Si, P. Wang, J. Li, K.P. Cheung, S. Yu, and P.D. Ye, in *2022 IEEE Symposium on VLSI Technology and Circuits (VLSI Technology and Circuits)* (IEEE, 2022), pp. 338–339.
- 135 P. Buragohain, A. Erickson, T. Mimura, T. Shimizu, H. Funakubo, and A. Gruverman, *Adv. Func. Mater.* **32**, 2108876 (2021).
- 136 P. Hao, S. Zheng, B. Zeng, T. Yu, Z. Yang, L. Liao, Q. Peng, Q. Yang, Y. Zhou, and M. Liao, *Adv. Func. Mater.* (2023).
- 137 T. Maeda, B. Magyari-Kope, and Y. Nishi, in *2017 IEEE International Memory Workshop (IMW)* (IEEE, 2017).
- 138 Yubo Qi, Sebastian E. Reyes-Lillo, Karin M. Rabe, "Double-path" ferroelectrics and the sign of the piezoelectric response. arXiv:2204.06999

- 139 P. Nukala, M. Ahmadi, Y. Wei, S. de Graaf, E. Stylianidis, T. Chakraborty, S. Matzen, H.W. Zandbergen, A. Björling, D. Mannix, D. Carbone, B. Kooi, and B. Noheda, *Science* **372**, 630 (2021).
- 140 L. Chen, Z. Liang, S. Shao, Q. Huang, K. Tang, and R. Huang, *Nanoscale* **15**, 7014 (2023).
- 141 A. Silva, I. Fina, F. Sánchez, J.P.B. Silva, L. Marques, and V. Lenzi, *Materials Today Physics* **34**, 101064 (2023).
- 142 Yao Wu, Yuke Zhang, Jie Jiang, Limei Jiang, Minghua Tang, Yichun Zhou, Min Liao, Qiong Yang, Evgeny Y. Tsymbal, Unconventional polarization switching mechanism in (Hf, Zr)O₂ ferroelectrics. arXiv:2301.06248
- 143 D.-H. Choe, H. Bae, H. Lee, Y. Lee, T. Moon, S.G. Nam, S. Jo, H.J. Lee, E. Lee, and J. Heo, in *2021 IEEE International Electron Devices Meeting (IEDM)* (IEEE, 2021), pp. 15.1.1–15.1.4.
- 144 K. Chae, S.F. Lombardo, N. Tasneem, M. Tian, H. Kumarasubramanian, J. Hur, W. Chern, S. Yu, C. Richter, P.D. Lomenzo, M. Hoffmann, U. Schroeder, D. Triyoso, S. Consiglio, K. Tapily, R. Clark, G. Leusink, N. Bassiri-Gharb, P. Bandaru, J. Ravichandran, A. Kummel, K. Cho, J. Kacher, and A.I. Khan, *ACS Applied Materials Interfaces* **14**, 36771 (2022).
- 145 H. Yang, H.-J. Lee, J. Jo, C.H. Kim, and J.H. Lee, *Physical Review Applied* **14**, (2020).
- 146 A. Erba, J. Baima, I. Bush, R. Orlando, and R. Dovesi, *Journal of Chemical Theory and Computation* **13**, 5019 (2017).
- 147 A. Nakata, J.S. Baker, S.Y. Mujahed, J.T.L. Poulton, S. Arapan, J. Lin, Z. Raza, S. Yadav, L. Truflandier, T. Miyazaki, and D.R. Bowler, *The Journal of Chemical Physics* **152**, 164112 (2020).
- 148 P. Liu, C. Verdi, F. Karsai, and G. Kresse, *Physical Review B* **105**, 060102 (2022).

- 149 H.W. Park, J. Roh, Y.B. Lee, and C.S. Hwang, *Advanced Materials* **31**, 1805266 (2019).
- 150 M.H. Park, H.J. Kim, Y.J. Kim, T. Moon, and C.S. Hwang, *Applied Physics Letters* **104**, 072901 (2014).
- 151 Y. Qi, S. Singh, C. Lau, F.-T. Huang, X. Xu, F.J. Walker, C.H. Ahn, S.-W. Cheong, and K.M. Rabe, *Physical Review Letters* **125**, 257603 (2020).
- 152 D.H. Lee, Y. Lee, K. Yang, J.Y. Park, S.H. Kim, P.R.S. Reddy, M. Materano, H. Mulaosmanovic, T. Mikolajick, J.L. Jones, U. Schroeder, and M.H. Park, *Applied Physics Reviews* **8**, 021312 (2021).
- 153 K.A. Hunnestad, E.D. Roede, A.T.J. van Helvoort, and D. Meier, *Journal of Applied Physics* **128**, 191102 (2020).
- 154 Y. Liu, K.P. Kelley, H. Funakubo, S.V. Kalinin, and M. Ziatdinov, *Advanced Science* **9**, 2203957 (2022).
- 155 J.A.O. A. B. Chase, *American Mineralogist* **51**, 1808 (1966).
- 156 R. Ruh and P.W.R. Corfield, *Journal of the American Ceramic Society* **53**, 126 (1970).
- 157 V.V. Lozanov, N.I. Baklanova, V.R. Shayapov, and A.S. Berezin, *Crystal Growth Design* **16**, 5283 (2016).
- 158 F. Kadlec and P. Simon, *Materials Science and Engineering: B* **72**, 56 (2000).
- 159 M. Mann and J. Kolis, *Journal of Crystal Growth* **312**, 461 (2010).
- 160 S. Kurosawa, Y. Futami, V.V. Kochurikhin, M.A. Borik, Y. Yokota, T. Yanagida, and A. Yoshikawa, *Key Engineering Materials* **508**, 81 (2012).
- 161 H. Yu, C. Liu, Z. Zhang, S. Huang, Y. Yang, R. Mao, H. Feng, and J. Zhao, *Chemical Physics Letters* **738**, 136916 (2020).
- 162 K.J. Kim, K. Kamada, R. Murakami, T. Horiai, S. Ishikawa, V.V. Kochurikhin, M. Yoshino, A. Yamaji, Y. Shoji, S. Kurosawa, S. Toyoda, H. Sato, Y. Yokota, Y. Ohashi, and A. Yoshikawa, *Crystals* **10**, 619 (2020).

- 163 J. Müller, U. Schröder, T.S. Böске, I. Müller, U. Böttger, L. Wilde, J. Sundqvist, M. Lemberger, P. Kücher, T. Mikolajick, and L. Frey, *Journal of Applied Physics* **110**, 114113 (2011).
- 164 J. Müller, T.S. Böске, U. Schröder, S. Mueller, D. Bräuhaus, U. Böttger, L. Frey, and T. Mikolajick, *Nano Letters* **12**, 4318 (2012).
- 165 S. Mueller, C. Adelman, A. Singh, S.V. Elshocht, U. Schroeder, and T. Mikolajick, *ECS Journal of Solid State Science and Technology* **1**, 123 (2012).
- 166 S. Mueller, J. Mueller, A. Singh, S. Riedel, J. Sundqvist, U. Schroeder, and T. Mikolajick, *Advanced Functional Materials* **22**, 2412 (2012).
- 167 M. Pešić, F.P.G. Fengler, L. Larcher, A. Padovani, T. Schenk, E.D. Grimley, X. Sang, J.M. LeBeau, S. Slesazek, U. Schroeder, and T. Mikolajick, *Advanced Functional Materials* **26**, 4601 (2016).
- 168 T. Mittmann, M. Materano, P.D. Lomenzo, M.H. Park, I. Stolichnov, M. Cavalieri, C. Zhou, C.-C. Chung, J.L. Jones, T. Szyjka, M. Müller, A. Kersch, T. Mikolajick, and U. Schroeder, *Advanced Materials Interfaces* 1900042 (2019).
- 169 Y.-C. Chiu, C.-H. Cheng, C.-Y. Chang, Y.-T. Tang, and M.-C. Chen, *Physica Status Solidi (RRL) - Rapid Research Letters* **11**, 1600368 (2017).
- 170 Y. Tashiro, T. Shimizu, T. Mimura, and H. Funakubo, *ACS Applied Electronic Materials* **3**, 3123 (2021).
- 171 M. Hoffmann, U. Schroeder, T. Schenk, T. Shimizu, H. Funakubo, O. Sakata, D. Pohl, M. Drescher, C. Adelman, R. Materlik, A. Kersch, and T. Mikolajick, *Journal of Applied Physics* **118**, 072006 (2015).
- 172 T. Ito, T. Ushiyama, Y. Yanagisawa, Y. Tomioka, I. Shindo, and A. Yanase, *Journal of Crystal Growth* **363**, 264 (2013).
- 173 A. Pimenov, J. Ullrich, P. Lunkenheimer, A. Loidl, and C.H. Rüscher, *Solid State Ionics* **109**, 111 (1998).

- 174 T. Shimizu, T. Yokouchi, T. Shiraishi, T. Oikawa, P.S.S.R. Krishnan, and H. Funakubo, *Japanese Journal of Applied Physics* **53**, 09 (2014).
- 175 T. Shiraishi, K. Katayama, T. Yokouchi, T. Shimizu, T. Oikawa, O. Sakata, H. Uchida, Y. Imai, T. Kiguchi, T.J. Konno, and H. Funakubo, *Applied Physics Letters* **108**, 262904 (2016).
- 176 P. Polakowski, S. Riedel, W. Weinreich, M. Rudolf, J. Sundqvist, K. Seidel, and J. Muller, in *2014 IEEE 6th International Memory Workshop (IMW)* (IEEE, 2014).
- 177 K.D. Budd, S.K. Dey, and D.A. Payne, in *British Ceramic Proceedings*, *36*, 107-121 (1985).
- 178 S.K. Dey, K.D. Budd, and D.A. Payne, *IEEE Transactions on Ultrasonics Ferroelectrics and Frequency Control* **35**, 80 (1988).
- 179 S.K. Singh, R. Ueno, H. Funakubo, H. Uchida, S. Koda, and H. Ishiwara, *Japanese Journal of Applied Physics* **44**, 8525 (2005).
- 180 H. Uchida, R. Ueno, H. Funakubo, and S. Koda, *Journal of Applied Physics* **100**, 014106 (2006).
- 181 T.J. Boyle, C.D. Buchheit, M.A. Rodriguez, H.N. Al-Shareef, B.A. Hernandez, B. Scott, and J.W. Ziller, *Journal of Materials Research* **11**, 2274 (1996).
- 182 K. Kato, C. Zheng, J.M. Finder, S.K. Dey, and Y. Torii, *Journal of the American Ceramic Society* **81**, 1869 (2005).
- 183 S. Starschich, D. Griesche, T. Schneller, R. Waser, and U. Böttger, *Applied Physics Letters* **104**, 202903 (2014).
- 184 C. Abe, S. Nakayama, M. Shiokawa, H. Kawashima, K. Katayama, T. Shiraishi, T. Shimizu, H. Funakubo, and H. Uchida, *Ceramics International* **43**, 501 (2017).
- 185 S. Nakayama, H. Funakubo, and H. Uchida, *Japanese Journal of Applied Physics* **57**, 11 (2018).

- 186 S. Zheng, Z. Zhao, Z. Liu, B. Zeng, L. Yin, Q. Peng, M. Liao, and Y. Zhou, *Applied Physics Letters* **117**, 212904 (2020).
- 187 Mohit, T. Miyasako, and E. Tokumitsu, *Japanese Journal of Applied Physics* **60**, 02 (2021).
- 188 T. Miyasako, S. Yoneda, T. Hosokura, M. Kimura, and E. Tokumitsu, *Applied Physics Letters* **120**, 262901 (2022).
- 189 S. Starschich, D. Griesche, T. Schneller, and U. Böttger, *ECS Journal of Solid State Science and Technology* **4**, 419 (2015).
- 190 S. Starschich and U. Boettger, *Journal of Materials Chemistry C* **5**, 333 (2017).
- 191 Y. Yao, D. Zhou, S. Li, J. Wang, N. Sun, F. Liu, and X. Zhao, *Journal of Applied Physics* **126**, 154103 (2019).
- 192 M. Badillo, S. Taleb, T. Mokabber, J. Rieck, R. Castanedo-Perez, G. Torres-Delgado, B. Noheda, and M. Acuautla, (2022).
- 193 M. Ángel Badillo-Avila, S. Taleb, T. Mokabber, J. Rieck, R. Castanedo-Pérez, G. Torres-Delgado, B. Noheda, and M.I.A. Meneses, *Journal of Materials Chemistry C* (2022).
- 194 Mohit, K.-ichi Haga, and E. Tokumitsu, *Japanese Journal of Applied Physics* **59**, 02 (2020).
- 195 M. Shiokawa, K. Izaki, H. Funakubo, and H. Uchida, *MRS Proceedings* **1729**, 99 (2015).
- 196 F. Huang, X. Chen, X. Liang, J. Qin, Y. Zhang, T. Huang, Z. Wang, B. Peng, P. Zhou, H. Lu, L. Zhang, L. Deng, M. Liu, Q. Liu, H. Tian, and L. Bi, *Physical Chemistry Chemical Physics* **19**, 3486 (2017).
- 197 Q. Shao, X. Wang, W. Jiang, Y. Chen, X. Zhang, L. Tu, T. Lin, H. Shen, X. Meng, A. Liu, and J. Wang, *Applied Physics Letters* **115**, 162902 (2019).
- 198 M. Cavalieri, Éamon O'Connor, C. Gastaldi, I. Stolichnov, and A.M. Ionescu, *ACS Applied Electronic Materials* **2**, 1752 (2020).

- 199 T. Shimizu, K. Katayama, T. Kiguchi, A. Akama, T.J. Konno, O. Sakata, and H. Funakubo, *Scientific Reports* **6**, (2016).
- 200 J. Lyu, I. Fina, R. Solanas, J. Fontcuberta, and F. Sánchez, *Applied Physics Letters* **113**, 082902 (2018).
- 201 J. Lyu, I. Fina, R. Solanas, J. Fontcuberta, and F. Sánchez, *ACS Applied Electronic Materials* **1**, 220 (2019).
- 202 Z. Zhang, S.-L. Hsu, V.A. Stoica, H. Paik, E. Parsonnet, A. Qualls, J. Wang, L. Xie, M. Kumari, S. Das, Z. Leng, M. McBriarty, R. Proksch, A. Gruverman, D.G. Schlom, L.-Q. Chen, S. Salahuddin, L.W. Martin, and R. Ramesh, *Advanced Materials* **33**, 2006089 (2021).
- 203 T. Mimura, T. Shimizu, Y. Katsuya, O. Sakata, and H. Funakubo, *Japanese Journal of Applied Physics* **59**, 04 (2020).
- 204 T. Mimura, T. Shimizu, O. Sakata, and H. Funakubo, *Applied Physics Letters* **118**, 112903 (2021).
- 205 B. Prasad, V. Thakare, A. Kalitsov, Z. Zhang, B. Terris, and R. Ramesh, *Advanced Electronic Materials* **7**, 2001074 (2021).
- 206 Z. Shen, L. Liao, Y. Zhou, K. Xiong, J. Zeng, X. Wang, Y. Chen, J. Liu, T. Guo, S. Zhang, T. Lin, H. Shen, X. Meng, Y. Wang, Y. Cheng, J. Yang, P. Chen, L. Wang, X. Bai, J. Chu, and J. Wang, *Applied Physics Letters* **120**, 162904 (2022).
- 207 *Physica Status Solidi RRL* **15**, 2000481 (2021).
- 208 P. Jiao, J. Li, Z. Xi, X. Zhang, J. Wang, Y. Yang, Y. Deng, and D. Wu, *Applied Physics Letters* **119**, 252901 (2021).
- 209 T. Song, H. Tan, S. Estandía, J. Gàzquez, M. Gich, N. Dix, I. Fina, and F. Sánchez, *Nanoscale* **14**, 2337 (2022).
- 210 T. Song, S. Estandía, N. Dix, J. Gàzquez, M. Gich, I. Fina, and F. Sánchez, *Journal of Materials Chemistry C* **10**, 8407 (2022).

- 211 S. Estandía, N. Dix, J. Gazquez, I. Fina, J. Lyu, M.F. Chisholm, J. Fontcuberta, and F. Sánchez, *ACS Applied Electronic Materials* **1**, 1449 (2019).
- 212 T. Li, N. Zhang, Z. Sun, C. Xie, M. Ye, S. Mazumdar, L. Shu, Y. Wang, D. Wang, L. Chen, S. Ke, and H. Huang, *Journal of Materials Chemistry C* **6**, 9224 (2018).
- 213 J. Lyu, I. Fina, R. Bachelet, G. Saint-Girons, S. Estandía, J. Gázquez, J. Fontcuberta, and F. Sánchez, *Applied Physics Letters* **114**, 222901 (2019).
- 214 J. Lyu, I. Fina, J. Fontcuberta, and F. Sánchez, *ACS Applied Materials Interfaces* **11**, 6224 (2019).
- 215 K. Lee, T.Y. Lee, S.M. Yang, D.H. Lee, J. Park, and S.C. Chae, *Applied Physics Letters* **112**, 202901 (2018).
- 216 J. Lyu, T. Song, I. Fina, and F. Sánchez, *Nanoscale* **12**, 11280 (2020).
- 217 T. Mimura, T. Shimizu, and H. Funakubo, *Applied Physics Letters* **115**, 032901 (2019).
- 218 T. Song, R. Solanas, M. Qian, I. Fina, and F. Sánchez, *Journal of Materials Chemistry C* **10**, 1084 (2022).
- 219 H. Zhong, M. Li, Q. Zhang, L. Yang, R. He, F. Liu, Z. Liu, G. Li, Q. Sun, D. Xie, F. Meng, Q. Li, M. He, E.-jia Guo, C. Wang, Z. Zhong, X. Wang, L. Gu, G. Yang, K. Jin, P. Gao, and C. Ge, *Advanced Materials* **34**, 2109889 (2022).
- 220 M.H. Park, Y.H. Lee, T. Mikolajick, U. Schroeder, and C.S. Hwang, *Advanced Electronic Materials* **5**, 1800522 (2018).
- 221 M.D. Glinchuk, A.N. Morozovska, A. Lukowiak, W. Strk, M.V. Silibin, D.V. Karpinsky, Y. Kim, and S.V. Kalinin, *Journal of Alloys and Compounds* **830**, 153628 (2020).
- 222 M. Dawber, K.M. Rabe, and J.F. Scott, *Reviews of Modern Physics* **77**, 1083 (2005).
- 223 T. Song, S. Estandía, H. Tan, N. Dix, J. Gázquez, I. Fina, and F. Sánchez, *Advanced Electronic Materials* **8**, 2100420 (2021).

- 224 I.F. T. Song F. Sánchez, *APL Materials* **10**, 031108 (2022).
- 225 L. Bégon-Lours, M. Mulder, P. Nukala, S. de Graaf, Y.A. Birkhölzer, B. Kooi, B. Noheda, G. Koster, and G. Rijnders, *Physical Review Materials* **4**, 043401 (2020).
- 226 J. Müller, E. Yurchuk, T. Schlösser, J. Paul, R. Hoffmann, S. Müller, D. Martin, S. Slesazek, P. Polakowski, J. Sundqvist, and others, in *2012 Symposium on VLSI Technology (VLSIT)* (IEEE, 2012), pp. 25–26.
- 227 S. Dünkel, M. Trentzsch, R. Richter, P. Moll, C. Fuchs, O. Gehring, M. Majer, S. Wittek, B. Müller, T. Melde, and others, in *2017 IEEE International Electron Devices Meeting (IEDM)* (IEEE, 2017), pp. 19–7.
- 228 J. Okuno, T. Kunihiro, K. Konishi, H. Maemura, Y. Shuto, F. Sugaya, M. Materano, T. Ali, K. Kuehnel, K. Seidel, and others, in *2020 IEEE Symposium on VLSI Technology* (IEEE, 2020), pp. 1–2.
- 229 S.J. Kim, J. Mohan, S.R. Summerfelt, and J. Kim, *JOM* **71**, 246 (2019).
- 230 V. Cremers, R.L. Puurunen, and J. Dendooven, *Applied Physics Reviews* **6**, 021302 (2019).
- 231 S.M. George, *Chemical Reviews* **110**, 111 (2010).
- 232 K. Mistry, C. Allen, C. Auth, B. Beattie, D. Bergstrom, M. Bost, M. Brazier, M. Buehler, A. Cappellani, R. Chau, and others, in *2007 IEEE International Electron Devices Meeting* (IEEE, 2007), pp. 247–250.
- 233 B. Yu, L. Chang, S. Ahmed, H. Wang, S. Bell, C.-Y. Yang, C. Tabery, C. Ho, Q. Xiang, T.-J. King, and others, in *Digest. International Electron Devices Meeting*, (IEEE, 2002), pp. 251–254.
- 234 N. Singh, A. Agarwal, L.K. Bera, T.Y. Liow, R. Yang, S.C. Rustagi, C.H. Tung, R. Kumar, G.Q. Lo, N. Balasubramanian, and others, *IEEE Electron Device Letters* **27**, 383 (2006).

- 235 K.D. Kim, Y.H. Lee, T. Gwon, Y.J. Kim, H.J. Kim, T. Moon, S.D. Hyun, H.W. Park, M.H. Park, and C.S. Hwang, *Nano Energy* **39**, 390 (2017).
- 236 K.D. Kim, M.H. Park, H.J. Kim, Y.J. Kim, T. Moon, Y.H. Lee, S.D. Hyun, T. Gwon, and C.S. Hwang, *Journal of Materials Chemistry C* **4**, 6864 (2016).
- 237 D. Lehninger, R. Olivo, T. Ali, M. Lederer, T. Kämpfe, C. Mart, K. Biedermann, K. Kühnel, L. Roy, M. Kalkani, and others, *Physica Status Solidi (a)* **217**, 1900840 (2020).
- 238 D. Lehninger, T. Ali, R. Olivo, M. Lederer, T. Kämpfe, K. Mertens, and K. Seidel, in *2020 Joint Conference of the IEEE International Frequency Control Symposium and International Symposium on Applications of Ferroelectrics (IFCS-ISAF)* (IEEE, 2020), pp. 1–3.
- 239 H.-B. Kim, M. Jung, Y. Oh, S.W. Lee, D. Suh, and J.-H. Ahn, *Nanoscale* **13**, 8524 (2021).
- 240 H.A. Hsain, Y. Lee, M. Materano, T. Mittmann, A. Payne, T. Mikolajick, U. Schroeder, G.N. Parsons, and J.L. Jones, *Journal of Vacuum Science & Technology A: Vacuum, Surfaces, and Films* **40**, 010803 (2022).
- 241 N. Gong and T.-P. Ma, *IEEE Electron Device Letters* **39**, 15 (2017).
- 242 K. Ni, P. Sharma, J. Zhang, M. Jerry, J.A. Smith, K. Tapily, R. Clark, S. Mahapatra, and S. Datta, *IEEE Transactions on Electron Devices* **65**, 2461 (2018).
- 243 T. Ali, P. Polakowski, S. Riedel, T. Büttner, T. Kämpfe, M. Rudolph, B. Pätzold, K. Seidel, D. Löhr, R. Hoffmann, and others, *IEEE Transactions on Electron Devices* **65**, 3769 (2018).
- 244 A.J. Tan, Y.-H. Liao, L.-C. Wang, N. Shanker, J.-H. Bae, C. Hu, and S. Salahuddin, *IEEE Electron Device Letters* **42**, 994 (2021).
- 245 C.-Y. Chan, K.-Y. Chen, H.-K. Peng, and Y.-H. Wu, in *2020 IEEE Symposium on VLSI Technology* (IEEE, 2020), pp. 1–2.

- 246 S.H. Kim, G.T. Yu, G.H. Park, D.H. Lee, J.Y. Park, K. Yang, E.B. Lee, J.I. Lee, and M.H. Park, *Chemical Communications* **57**, 12452 (2021).
- 247 H.H. Kim, Enhanced Electrical Characteristics of Hf_{1-x}Zr_xO₂ Film Utilizing Discrete Feeding Method, Master's thesis, <http://dcollection.snu.ac.kr/common/orgView/000000158797>, 2020.
- 248 Y. Lee and S.M. George, *Journal of Vacuum Science Technology A* **36**, 061504 (2018).
- 249 M. Hoffmann, J.A. Murdzek, S.M. George, S. Slesazek, U. Schroeder, and T. Mikolajick, *Applied Physics Letters* **120**, 122901 (2022).
- 250 T.J. Park, J.H. Kim, J.H. Jang, U.K. Kim, S.Y. Lee, J. Lee, H.S. Jung, and C.S. Hwang, *Chemistry of Materials* **23**, 1654 (2011).
- 251 H. Hernández-Arriaga, E. López-Luna, E. Martínez-Guerra, M.M. Turrubiarres, A.G. Rodríguez, and M.A. Vidal, *Journal of Applied Physics* **121**, 064302 (2017).
- 252 C. Mart, K. Kühnel, T. Kämpfe, M. Czernohorsky, M. Wiatr, S. Kolodinski, and W. Weinreich, *ACS Applied Electronic Materials* **1**, 2612 (2019).
- 253 M.H. Park, H.J. Kim, G. Lee, J. Park, Y.H. Lee, Y.J. Kim, T. Moon, K.D. Kim, S.D. Hyun, H.W. Park, and others, *Applied Physics Reviews* **6**, 041403 (2019).
- 254 J.Y. Park, D.H. Lee, K. Yang, S.H. Kim, G.T. Yu, G.H. Park, E.B. Lee, K.H. Kim, and M.H. Park, *ACS Applied Electronic Materials* **4**, 1369 (2021).
- 255 C.-H. Chang, Y.-K. Chiou, C.-W. Hsu, and T.-B. Wu, *Electrochemical and Solid-State Letters* **10**, 5 (2007).
- 256 Y. Lee, H.A. Hsain, S.S. Fields, S.T. Jaszewski, M.D. Horgan, P.G. Edgington, J.F. Ihlefeld, G.N. Parsons, and J.L. Jones, *Applied Physics Letters* **118**, 012903 (2021).
- 257 Y.-K. Liang, W.-L. Li, Y.-J. Wang, L.-C. Peng, C.-C. Lu, H.-Y. Huang, S.H. Yeong, Y.-M. Lin, Y.-H. Chu, E.-Y. Chang, and C.-H. Lin, *IEEE Electron Device Letters* **43**, 1451 (2022).

- 258 H.-B. Kim, K.S. Dae, Y. Oh, S.-W. Lee, Y. Lee, S.-E. Ahn, J.H. Jang, and J.-H. Ahn, *Advanced Materials Interfaces* **9**, 2102528 (2022).
- 259 L. Xu, T. Nishimura, S. Shibayama, T. Yajima, S. Migita, and A. Toriumi, *Journal of Applied Physics* **122**, 124104 (2017).
- 260 R. Shimura, T. Mimura, T. Shimizu, Y. Tanaka, Y. Inoue, and H. Funakubo, *Journal of the Ceramic Society of Japan* **128**, 539 (2020).
- 261 X. Wang, T. Mikolajick, and M. Grube, *Physica Status Solidi RRL* **16**, 2100572 (2022).
- 262 J.P.B. Silva, R.F. Negrea, M.C. Istrate, S. Dutta, H. Aramberri, J. Íñiguez, F.G. Figueiras, C. Ghica, K.C. Sekhar, and A.L. Kholkin, *ACS Applied Materials & Interfaces* **13**, 51383 (2021).
- 263 V. Lenzi, J.P.B. Silva, B. Šmíd, V. Matolín, C.M. Istrate, C. Ghica, J.L. MacManus-Driscoll, and L. Marques, *Energy & Environmental Materials* **e12500**, (2022).
- 264 J.P.B. Silva, M.C. Istrate, M. Hellenbrand, A. Jan, M.T. Becker, J. Symonowicz, F.G. Figueiras, V. Lenzi, M.O. Hill, C. Ghica, K.N. Romanyuk, M.J.M. Gomes, G.D. Martino, L. Marques, and J.L. MacManus-Driscoll, *Applied Materials Today* **30**, 101708 (2023).
- 265 Y. Sun, G. Niu, W. Ren, J. Zhao, Y. Wang, H. Wu, L. Jiang, L. Dai, Y.-H. Xie, P.R. Romeo, J. Bouaziz, and B. Vilquin, *AIP Advances* **11**, 065229 (2021).
- 266 J. Bouaziz, P.R. Romeo, N. Baboux, and B. Vilquin, *ACS Applied Electronic Materials* **1**, 1740 (2019).
- 267 M.B. Hachemi, B. Salem, V. Consonni, H. Roussel, A. Garraud, G. Lefevre, S. Labau, S. Basrour, and A. Bsiesy, *AIP Advances* **11**, 085004 (2021).
- 268 J. Bouaziz, P.R. Romeo, N. Baboux, R. Negrea, L. Pintilie, and B. Vilquin, *APL Materials* **7**, 081109 (2019).
- 269 Y.H. Lee, H.J. Kim, T. Moon, K.D. Kim, S.D. Hyun, H.W. Park, Y.B. Lee, M.H. Park, and C.S. Hwang, *Nanotechnology* **28**, 305703 (2017).

- 270 S. Migita, H. Ota, H. Yamada, K. Shibuya, A. Sawa, and A. Toriumi, Japanese Journal of Applied Physics **57**, 04 (2018).
- 271 Q. Luo, H. Ma, H. Su, K.-H. Xue, R. Cao, Z. Gao, J. Yu, T. Gong, X. Xu, J. Yin, P. Yuan, L. Tai, D. Dong, S. Long, Q. Liu, X.-S. Miao, H. Lv, and M. Liu, IEEE Electron Device Letters **40**, 570 (2019).
- 272 T. Mittmann, M. Michailow, P.D. Lomenzo, J. Gärtner, M. Falkowski, A. Kersch, T. Mikolajick, and U. Schroeder, Nanoscale **13**, 912 (2021).
- 273 J. Bouaziz, P.R. Romeo, N. Baboux, and B. Vilquin, Applied Physics Letters **118**, 082901 (2021).
- 274 G. Segantini, R. Barhoumi, B. Manchon, I.C. Infante, P.R. Romeo, M. Bugnet, N. Baboux, S. Nirantar, D. Deleruyelle, S. Sriram, and B. Vilquin, Physica Status Solidi RRL **16**, 2100583 (2022).
- 275 B. Manchon, G. Segantini, N. Baboux, P.R. Romeo, R. Barhoumi, I.C. Infante, F. Alibert, D. Drouin, B. Vilquin, and D. Deleruyelle, Physica Status Solidi RRL **16**, 2100585 (2022).
- 276 J. Bouaziz, P.R. Romeo, N. Baboux, and B. Vilquin, Journal of Vacuum Science & Technology B **37**, 021203 (2019).
- 277 F. Mehmood, T. Mikolajick, and U. Schroeder, Physica Status Solidi (a) **217**, 2000281 (2020).
- 278 C. Zacharaki, P. Tsipas, S. Chaitoglou, S. Fragkos, M. Axiotis, A. Lagoyiannis, R. Negrea, L. Pintilie, and A. Dimoulas, Applied Physics Letters **114**, 112901 (2019).
- 279 C. Zacharaki, P. Tsipas, S. Chaitoglou, E.K. Evangelou, C.M. Istrate, L. Pintilie, and A. Dimoulas, Applied Physics Letters **116**, 182904 (2020).
- 280 C. Zacharaki, P. Tsipas, S. Chaitoglou, L. Bégon-Lours, M. Halter, and A. Dimoulas, Applied Physics Letters **117**, 212905 (2020).

- 281 N. Siannas, C. Zacharaki, P. Tsipas, S. Chaitoglou, L. Bégon-Lours, C. Istrate, L. Pintilie, and A. Dimoulas, *Communications Physics* **5**, (2022).
- 282 C. Zacharaki, S. Chaitoglou, N. Siannas, P. Tsipas, and A. Dimoulas, *ACS Applied Electronic Materials* **4**, 2815 (2022).
- 283 R. Zhang, N. Taoka, P.-C. Huang, M. Takenaka, and S. Takagi, in *2011 International Electron Devices Meeting* (IEEE, 2011).
- 284 J. Cao, S. Shi, Y. Zhu, and J. Chen, *Physica Status Solidi (RRL) Rapid Research Letters* **15**, 2100025 (2021).
- 285 H. Chen, X. Zhou, L. Tang, Y. Chen, H. Luo, X. Yuan, C.R. Bowen, and D. Zhang, *Applied Physics Reviews* **9**, 011307 (2022).
- 286 Z. Wen and D. Wu, *Advanced Materials* 1904123 (2019).
- 287 R.A. McKee, F.J. Walker, and M.F. Chisholm, *Physical Review Letters* **81**, 3014 (1998).
- 288 P. Nukala, J. Antoja-Lleonart, Y. Wei, L. Yedra, B. Dkhil, and B. Noheda, *ACS Applied Electronic Materials* **1**, 2585 (2019).
- 289 A. Dimoulas, G. Vellianitis, G. Mavrou, G. Apostolopoulos, A. Travlos, C. Wiemer, M. Fanciulli, and Z.M. Rittersma, *Applied Physics Letters* **85**, 3205 (2004).
- 290 S. Saitzek, Z. Shao, A. Bayart, A. Ferri, M. Huvé, P. Roussel, and R. Desfeux, *Journal of Materials Chemistry C* **2**, 4037 (2014).
- 291 A.G. Chernikova, M.G. Kozodaev, D.V. Negrov, E.V. Korostylev, M.H. Park, U. Schroeder, C.S. Hwang, and A.M. Markeev, *ACS Applied Materials Interfaces* **10**, 2701 (2018).
- 292 M.H. Park, Y.H. Lee, H.J. Kim, Y.J. Kim, T. Moon, K.D. Kim, S.D. Hyun, and C.S. Hwang, *ACS Applied Materials Interfaces* **10**, 42666 (2018).
- 293 H. Yang, K. Park, H.-J. Lee, J. Jo, H. Park, N. Park, J. Park, and J.H. Lee, *Inorganic Chemistry* **59**, 5993 (2020).

- 294 J. Wu, F. Mo, T. Saraya, T. Hiramoto, and M. Kobayashi, *Applied Physics Letters* **117**, 252904 (2020).
- 295 M.H. Park, C.-C. Chung, T. Schenk, C. Richter, K. Opsomer, C. Detavernier, C. Adelman, J.L. Jones, T. Mikolajick, and U. Schroeder, *Advanced Electronic Materials* **4**, 1800091 (2018).
- 296 I. Nettleship and R. Stevens, *International Journal of High Technology Ceramics* **3**, 1 (1987).
- 297 K. Chae, A.C. Kummel, and K. Cho, *ACS Applied Materials Interfaces* **14**, 29007 (2022).
- 298 M.G. Kozodaev, A.G. Chernikova, E.V. Korostylev, M.H. Park, R.R. Khakimov, C.S. Hwang, and A.M. Markeev, *Journal of Applied Physics* **125**, 034101 (2019).
- 299 M.I. Popovici, A.M. Walke, J. Bizindavyi, J. Meersschaut, K. Banerjee, G. Potoms, K. Katcko, G.V. den Bosch, R. Delhougne, G.S. Kar, and J.V. Houdt, *ACS Applied Electronic Materials* **4**, 1823 (2022).
- 300 J. Lee, D. Eom, C. Lee, W. Lee, J. Oh, C. Park, J. Kim, H. Lee, S. Lee, E. Lee, and H. Kim, *Applied Physics Letters* **120**, 222902 (2022).
- 301 P. Fan, Y.K. Zhang, Q. Yang, J. Jiang, L.M. Jiang, M. Liao, and Y.C. Zhou, *The Journal of Physical Chemistry C* **123**, 21743 (2019).
- 302 M.H. Park, D.H. Lee, K. Yang, J.-Y. Park, G.T. Yu, H.W. Park, M. Materano, T. Mittmann, P.D. Lomenzo, T. Mikolajick, U. Schroeder, and C.S. Hwang, *Journal of Materials Chemistry C* **8**, 10526 (2020).
- 303 K.Z. Rushchanskii, S. Blügel, and M. Ležaić, *Physical Review Letters* **127**, 087602 (2021).
- 304 B. Max, M. Pešić, S. Slesazek, and T. Mikolajick, *Journal of Applied Physics* **123**, 134102 (2018).

- 305 D.R. Islamov, T.M. Zalyalov, O.M. Orlov, V.A. Gritsenko, and G.Y. Krasnikov, *Applied Physics Letters* **117**, 162901 (2020).
- 306 F.P.G. Fengler, R. Nigon, P. Muralt, E.D. Grimley, X. Sang, V. Sessi, R. Hentschel, J.M. LeBeau, T. Mikolajick, and U. Schroeder, *Advanced Electronic Materials* **4**, 1700547 (2018).
- 307 D.R. Islamov, V.A. Gritsenko, T.V. Perevalov, V.A. Pustovarov, O.M. Orlov, A.G. Chernikova, A.M. Markeev, S. Slesazek, U. Schroeder, T. Mikolajick, and G.Y. Krasnikov, *Acta Materialia* **166**, 47 (2019).
- 308 V.A. Gritsenko and A.A. Gismatulin, *Applied Physics Letters* **117**, 142901 (2020).
- 309 M. Müller, P. Lömker, P. Rosenberger, M.H. Hamed, D.N. Mueller, R.A. Heinen, T. Szyjka, and L. Baumgarten, *Journal of Vacuum Science Technology A* **40**, 013215 (2022).
- 310 W. Hamouda, A. Pancotti, C. Lubin, L. Tortech, C. Richter, T. Mikolajick, U. Schroeder, and N. Barrett, *Journal of Applied Physics* **127**, 064105 (2020).
- 311 W. Hamouda, C. Lubin, S. Ueda, Y. Yamashita, O. Renault, F. Mehmood, T. Mikolajick, U. Schroeder, R. Negrea, and N. Barrett, *Applied Physics Letters* **116**, 252903 (2020).
- 312 S.R. Bradley, A.L. Shluger, and G. Bersuker, *Physical Review Applied* **4**, (2015).
- 313 T.V. Perevalov, I.P. Prosvirin, E.A. Suprun, F. Mehmood, T. Mikolajick, U. Schroeder, and V.A. Gritsenko, *Journal of Science: Advanced Materials and Devices* **6**, 595 (2021).
- 314 L. Baumgarten, T. Szyjka, T. Mittmann, M. Materano, Y. Matveyev, C. Schlueter, T. Mikolajick, U. Schroeder, and M. Müller, *Applied Physics Letters* **118**, 032903 (2021).
- 315 T. Szyjka, L. Baumgarten, T. Mittmann, Y. Matveyev, C. Schlueter, T. Mikolajick, U. Schroeder, and M. Müller, *ACS Applied Electronic Materials* **2**, 3152 (2020).
- 316 J. Lyu, I. Fina, and F. Sánchez, *Applied Physics Letters* **117**, 072901 (2020).
- 317 T. Hashimoto, P. Amann, A. Regoutz, N. Barrett, L.F.J. Piper, W. Hamouda, O. Renault, M. Lundwall, and M. Machida, *Vacuum and Surface Science* **64**, 493 (2021).

- 318 W. Hamouda, F. Mehmood, T. Mikolajick, U. Schroeder, T.O. Mentis, A. Locatelli, and N. Barrett, *Applied Physics Letters* **120**, 202902 (2022).
- 319 J.E. Rault, G. Agnus, T. Maroutian, V. Pillard, P. Lecoeur, G. Niu, B. Vilquin, M.G. Silly, A. Bendounan, F. Sirotti, and N. Barrett, *Physical Review B* **88**, 155107 (2013).
- 320 H. Mulaosmanovic, F. Muller, M. Lederer, T. Ali, R. Hoffmann, K. Seidel, H. Zhou, J. Ocker, S. Mueller, S. Dunkel, D. Kleimaier, J. Muller, M. Trentzsch, S. Beyer, E.T. Breyer, T. Mikolajick, and S. Slesazek, *IEEE Transactions on Electron Devices* **67**, 3466 (2020).
- 321 T.-H. Ryu, D.-H. Min, and S.-M. Yoon, *Journal of Applied Physics* **128**, 074102 (2020).
- 322 C. Huang, Y. Zhang, S. Zheng, Q. Yang, and M. Liao, *Physical Review Applied* **16**, 044048 (2021).
- 323 H. Chen, L. Tang, L. Liu, Y. Chen, H. Luo, X. Yuan, and D. Zhang, *Applied Surface Science* **542**, 148737 (2021).
- 324 Y.B. Lee, B.Y. Kim, H.W. Park, S.H. Lee, M. Oh, S.K. Ryoo, I.S. Lee, S. Byun, D. Shim, J.H. Lee, H. Kim, K.D. Kim, M.H. Park, and C.S. Hwang, *Advanced Electronic Materials* **8**, 2200310 (2022).
- 325 P.D. Lomenzo, P. Zhao, Q. Takmeel, S. Moghaddam, T. Nishida, M. Nelson, C.M. Fancher, E.D. Grimley, X. Sang, J.M. LeBeau, and J.L. Jones, *Journal of Vacuum Science & Technology B Nanotechnology and Microelectronics: Materials, Processing, Measurement, and Phenomena* **32**, 03 (2014).
- 326 C. Gaumer, E. Martinez, S. Lhostis, M.-J. Guittet, M. Gros-Jean, J.-P. Barnes, C. Licitra, N. Rochat, N. Barrett, F. Bertin, and A. Chabli, *Microelectronic Engineering* **88**, 72 (2011).
- 327 D. Martin, J. Müller, T. Schenk, T.M. Arruda, A. Kumar, E. Strelcov, E. Yurchuk, S. Müller, D. Pohl, U. Schröder, S.V. Kalinin, and T. Mikolajick, *Advanced Materials* **26**, 8198 (2014).

- 328 P.D. Lomenzo, Q. Takmeel, C. Zhou, C.M. Fancher, E. Lambers, N.G. Rudawski, J.L. Jones, S. Moghaddam, and T. Nishida, *Journal of Applied Physics* **117**, 134105 (2015).
- 329 Y. Lee, Y. Goh, J. Hwang, D. Das, and S. Jeon, *IEEE Transactions on Electron Devices* **68**, 523 (2021).
- 330 S.S. Fields, S.W. Smith, P.J. Ryan, S.T. Jaszewski, I.A. Brummel, A. Salanova, G. Esteves, S.L. Wolfley, M.D. Henry, P.S. Davids, and J.F. Ihlefeld, *ACS Applied Materials & Interfaces* **12**, 26577 (2020).
- 331 M.H. Park, H.J. Kim, Y.J. Kim, W. Lee, H.K. Kim, and C.S. Hwang, *Applied Physics Letters* **102**, 112914 (2013).
- 332 S.S. Fields, S.W. Smith, S.T. Jaszewski, T. Mimura, D.A. Dickie, G. Esteves, M.D. Henry, S.L. Wolfley, P.S. Davids, and J.F. Ihlefeld, *Journal of Applied Physics* **130**, 134101 (2021).
- 333 M.H. Park, H.J. Kim, Y.J. Kim, W. Jeon, T. Moon, and C.S. Hwang, *Physica Status Solidi (RRL) - Rapid Research Letters* **8**, 532 (2014).
- 334 Y. Goh, S.H. Cho, S.-H.K. Park, and S. Jeon, *IEEE Transactions on Electron Devices* **67**, 3431 (2020).
- 335 T. Mittmann, T. Szyjka, H. Alex, M.C. Istrate, P.D. Lomenzo, L. Baumgarten, M. Müller, J.L. Jones, L. Pintilie, T. Mikolajick, and U. Schroeder, *Physica Status Solidi RRL* **15**, 2100012 (2021).
- 336 T. Szyjka, L. Baumgarten, T. Mittmann, Y. Matveyev, C. Schlueter, T. Mikolajick, U. Schroeder, and M. Müller, *Phys. Status Solidi RRL* **15**, 2100027 (2021).
- 337 S. Starschich, S. Menzel, and U. Böttger, *Applied Physics Letters* **108**, 032903 (2016).
- 338 S. Zhao, B. Li, Y. Guo, and H. Li, *Applied Physics Letters* **120**, 012904 (2022).
- 339 M. Yadav, A. Kashir, S. Oh, R.D. Nikam, H. Kim, H. Jang, and H. Hwang, *Nanotechnology* **33**, 085206 (2021).

- 340 K. Mizutani, T. Hoshii, H. Wakabayashi, K. Tsutsui, E.Y. Chang, and K. Kakushima, *Japanese Journal of Applied Physics* **61**, 021006 (2022).
- 341 H.A. Hsain, Y. Lee, S. Lancaster, P.D. Lomenzo, B. Xu, T. Mikolajick, U. Schroeder, G.N. Parsons, and J.L. Jones, *Nanotechnology* **34**, 125703 (2023).
- 342 F. Mehmood, R. Alcala, P. Vishnumurthy, B. Xu, R. Sachdeva, T. Mikolajick, and U. Schroeder, *Advanced Materials Interfaces* 2202151 (2023).
- 343 R. Alcala, F. Mehmood, P. Vishnumurthy, T. Mittmann, T. Mikolajick, and U. Schroeder, in *2022 IEEE International Memory Workshop (IMW)* (IEEE, 2022), pp. 1–4.
- 344 M.H. Park, Y.H. Lee, H.J. Kim, T. Schenk, W. Lee, K.D. Kim, F.P.G. Fengler, T. Mikolajick, U. Schroeder, and C.S. Hwang, *Nanoscale* **9**, 9973 (2017).
- 345 H.J. Kim, M.H. Park, Y.J. Kim, Y.H. Lee, W. Jeon, T. Gwon, T. Moon, K.D. Kim, and C.S. Hwang, *Applied Physics Letters* **105**, 192903 (2014).
- 346 H.A. Hsain, Y. Lee, S. Lancaster, M. Materano, R. Alcala, B. Xu, T. Mikolajick, U. Schroeder, G.N. Parsons, and J.L. Jones, *ACS Applied Materials Interfaces* **14**, 42232 (2022).
- 347 G. Walters, P. Chojecki, Z. Forrester, and T. Nishida, *Applied Physics Letters* **118**, 032904 (2021).
- 348 M.H. Park, H.J. Kim, G. Lee, J. Park, Y.H. Lee, Y.J. Kim, T. Moon, K.D. Kim, S.D. Hyun, H.W. Park, H.J. Chang, J.-H. Choi, and C.S. Hwang, *Applied Physics Reviews* **6**, 041403 (2019).
- 349 Z. Zhao, Y.-R. Chen, J.-F. Wang, Y.-W. Chen, J.-R. Zou, Y. Lin, Y. Xing, C.W. Liu, and C. Hu, *IEEE Electron Device Letters* **43**, 553 (2022).
- 350 J. Casamento, H. Lee, C.S. Chang, M.F. Besser, T. Maeda, D.A. Muller, H.(G. Xing, and D. Jena, *APL Materials* **9**, 091106 (2021).
- 351 B. Liu, Y. Cao, W. Zhang, and Y. Li, *Applied Physics Letters* **119**, 172902 (2021).
- 352 Y. Goh, S.H. Cho, S.-H.K. Park, and S. Jeon, *Nanoscale* **12**, 9024 (2020).

- 353 S.S. Cheema, N. Shanker, C.-H. Hsu, A. Datar, J. Bae, D. Kwon, and S. Salahuddin, *Advanced Electronic Materials* **8**, 2100499 (2021).
- 354 Y.-C. Lin, F. McGuire, and A.D. Franklin, *Journal of Vacuum Science & Technology B Nanotechnology and Microelectronics: Materials, Processing, Measurement, and Phenomena* **36**, 011204 (2018).
- 355 R. Athle, A.E.O. Persson, A. Irish, H. Menon, R. Timm, and M. Borg, *ACS Applied Materials Interfaces* **13**, 11089 (2021).
- 356 M. Saadi, P. Gonon, C. Vallée, C. Mannequin, H. Grampeix, E. Jalaguier, F. Jomni, and A. Bsiesy, *Journal of Applied Physics* **119**, 114501 (2016).
- 357 H. Mulaosmanovic, E.T. Breyer, S. Dünkel, S. Beyer, T. Mikolajick, and S. Slesazek, *Nanotechnology* **32**, 502002 (2021).
- 358 M. Kobayashi, Y. Tagawa, F. Mo, T. Saraya, and T. Hiramoto, *IEEE Journal of the Electron Devices Society* **7**, 134 (2019).
- 359 R. Athle, A.E.O. Persson, A. Troian, and M. Borg, *ACS Applied Electronic Materials* **4**, 1002 (2022).
- 360 S. Im, S.-Y. Kang, Y. Kim, J.H. Kim, J.-P. Im, S.-M. Yoon, S.E. Moon, and J. Woo, *Micromachines* **11**, 910 (2020).
- 361 X. Lyu, M. Si, X. Sun, M.A. Capano, H. Wang, and P.D. Ye, in *2019 Symposium on VLSI Technology* (IEEE, 2019), pp. T44–T45.
- 362 S. Riedel, P. Polakowski, and J. Müller, *AIP Advances* **6**, 095123 (2016).
- 363 S.L. Weeks, A. Pal, V.K. Narasimhan, K.A. Littau, and T. Chiang, *ACS Applied Materials Interfaces* **9**, 13440 (2017).
- 364 T. Ali, P. Polakowski, K. Kuhnelt, M. Czernohorsky, T. Kampfe, M. Rudolph, B. Patzold, D. Lehninger, F. Muller, R. Olivo, M. Lederer, R. Hoffmann, P. Steinke, K. Zimmermann, U. Muhle, K. Seidel, and J. Muller, in *2019 IEEE International Electron Devices Meeting (IEDM)* (IEEE, 2019).

- 365 M. Lederer, K. Seidel, R. Olivo, T. Kämpfe, and L.M. Eng, *Frontiers in Nanotechnology* **4**, 900379 (2022).
- 366 J. Liao, B. Zeng, Q. Sun, Q. Chen, M. Liao, C. Qiu, Z. Zhang, and Y. Zhou, *IEEE Electron Device Letters* **40**, 1868 (2019).
- 367 H. Joh, T. Jung, and S. Jeon, *IEEE Transactions on Electron Devices* **68**, 2538 (2021).
- 368 A. Navrotsky and S.V. Ushakov, in *Materials Fundamentals of Gate Dielectrics* (Springer-Verlag, n.d.), pp. 57–108.
- 369 D.G. Schlom, L.-Q. Chen, C.-B. Eom, K.M. Rabe, S.K. Streiffer, and J.-M. Triscone, *Annual Review of Materials Research* **37**, 589 (2007).
- 370 X. Tian, S. Shibayama, T. Nishimura, T. Yajima, S. Migita, and A. Toriumi, *Applied Physics Letters* **112**, 102902 (2018).
- 371 C.-I. Wang, H.-Y. Chen, C.-Y. Wang, T.-J. Chang, Y.-S. Jiang, C.-S. Chang, and M.-J. Chen, *Journal of Materials Chemistry C* **9**, 12759 (2021).
- 372 X. Liu, Y. Wang, P.V. Lukashev, J.D. Burton, and E.Y. Tsymbal, *Physical Review B* **85**, 125407 (2012).
- 373 Z. Gao, Y. Luo, S. Lyu, Y. Cheng, Y. Zheng, Q. Zhong, W. Zhang, and H. Lyu, *IEEE Electron Device Letters* **42**, 1303 (2021).
- 374 M. Dogan, S. Fernandez-Peña, L. Kornblum, Y. Jia, D.P. Kumah, J.W. Reiner, Z. Krivokapic, A.M. Kolpak, S. Ismail-Beigi, C.H. Ahn, and F.J. Walker, *Nano Letters* **18**, 241 (2017).
- 375 T. Mikolajick, S. Slesazek, M.H. Park, and U. Schroeder, *MRS Bulletin* **43**, 340 (2018).
- 376 J.A. Rodriguez, C. Zhou, T. Graf, R. Bailey, M. Wiegand, T. Wang, M. Ball, H.C. Wen, K.R. Udayakumar, S. Summerfelt, T. San, and T. Moise, in *2016 IEEE 8th International Memory Workshop (IMW)* (IEEE, 2016), pp. 1–4.

377 T. Francois, J. Coignus, A. Makosiej, B. Giraud, C. Carabasse, J. Barbot, S. Martin, N. Castellani, T. Magis, H. Grampeix, S.V. Duijn, C. Mounet, P. Chiquet, U. Schroeder, S. Slesazek, T. Mikolajick, E. Nowak, M. Bocquet, N. Barrett, F. Andrieu, and L. Grenouillet, in *2021 IEEE International Electron Devices Meeting (IEDM)* (IEEE, 2021), pp. 33.1.1–33.1.4.

378 Y. Wang, C. Zhang, H. Yu, and W. Zhang, in *Proceedings of the 2012 ACM/IEEE International Symposium on Low Power Electronics and Design* (ACM, 2012), pp. 197–202.

379 M. Trentzsch, S. Flachowsky, R. Richter, J. Paul, B. Reimer, D. Utes, S. Jansen, H. Mulaosmanovic, S. Muller, S. Slesazek, J. Ocker, M. Noack, J. Muller, P. Polakowski, J. Schreiter, S. Beyer, T. Mikolajick, and B. Rice, in *2016 IEEE International Electron Devices Meeting (IEDM)* (IEEE, 2016), pp. 11.5.1–11.5.4.

380 AMD Ryzen™ Threadripper™ PRO 5995WX Product Specifications.

381 DDR5 SDRAM MT60B2G8HB-48B Product Core Data Sheet.

382 J. Okuno, T. Kunihiro, K. Konishi, H. Maemura, Y. Shuto, F. Sugaya, M. Materano, T. Ali, M. Lederer, K. Kuehnel, K. Seidel, U. Schroeder, T. Mikolajick, M. Tsukamoto, and T. Umebayashi, in *2021 IEEE International Memory Workshop (IMW)* (IEEE, 2021), pp. 1–3.

383 J. Okuno, T. Kunihiro, K. Konishi, H. Maemura, Y. Shuto, F. Sugaya, M. Materano, T. Ali, K. Kuehnel, K. Seidel, U. Schroeder, T. Mikolajick, M. Tsukamoto, and T. Umebayashi, in *2020 IEEE Symposium on VLSI Technology* (IEEE, 2020), pp. 1–2.

384 T. Francois, J. Coignus, A. Makosiej, B. Giraud, C. Carabasse, J. Barbot, S. Martin, N. Castellani, T. Magis, H. Grampeix, S.V. Duijn, C. Mounet, P. Chiquet, U. Schroeder, S. Slesazek, T. Mikolajick, E. Nowak, M. Bocquet, N. Barrett, F. Andrieu, and L. Grenouillet, *IEEE Transactions on Electron Devices* **69**, 2108 (2022).

385 R. Alcala, M. Materano, P.D. Lomenzo, L. Grenouillet, T. Francois, J. Coignus, N. Vaxelaire, C. Carabasse, S. Chevalliez, F. Andrieu, T. Mikolajick, and U. Schroeder, *IEEE Journal of the Electron Devices Society* **907** (2022).

- 386 R. Alcala, P.D. Lomenzo, T. Mittman, B. Xu, R. Guido, S. Lancaster, P. Vishnumurthy, L. Grenouillet, S. Martin, J. Coignus, T. Mikolajick, and U. Schroeder, in *2022 IEEE International Electron Devices Meeting (IEDM)* (IEEE, 2022).
- 387 S. Lancaster, P.D. Lomenzo, M. Engl, B. Xu, T. Mikolajick, U. Schroeder, and S. Slesazeck, *Frontiers in Nanotechnology* **4**, 939822 (2022).
- 388 T. Mikolajick, S. Slesazeck, U. Schroeder, P.D. Lomenzo, E.T. Breyer, H. Mulaosmanovic, M. Hoffmann, T. Mittmann, F. Mehmood, and B. Max, in *2019 IEEE International Electron Devices Meeting (IEDM)* (IEEE, 2019).
- 389 M. Pešić, M. Hoffmann, C. Richter, T. Mikolajick, and U. Schroeder, *Advanced Functional Materials* **26**, 7486 (2016).
- 390 T. Ravsher, H. Mulaosmanovic, E.T. Breyer, V. Havel, T. Mikolajick, and S. Slesazeck, in *2019 26th IEEE International Conference on Electronics Circuits and Systems (ICECS)* (IEEE, 2019).
- 391 S. Beyer, S. Dunkel, M. Trentzsch, J. Muller, A. Hellmich, D. Utess, J. Paul, D. Kleimaier, J. Pellerin, S. Muller, J. Ocker, A. Benoist, H. Zhou, M. Mennenga, M. Schuster, F. Tassan, M. Noack, A. Pourkeramati, F. Muller, M. Lederer, T. Ali, R. Hoffmann, T. Kampfe, K. Seidel, H. Mulaosmanovic, E.T. Breyer, T. Mikolajick, and S. Slesazeck, in *2020 IEEE International Memory Workshop (IMW)* (IEEE, 2020), pp. 1–4.
- 392 M.M. Dahan, H. Mulaosmanovic, O. Levit, S. Dünkel, S. Beyer, and E. Yalon, *Nano Letters* **23**, 1395 (2023).
- 393 A.I. Khan, A. Keshavarzi, and S. Datta, *Nature Electronics* **3**, 588 (2020).
- 394 A.F. Laguna, X. Yin, D. Reis, M. Niemier, and X.S. Hu, in *Proceedings of the 2019 on Great Lakes Symposium on VLSI* (ACM, 2019), pp. 373–378.
- 395 T. Soliman, F. Muller, T. Kirchner, T. Hoffmann, H. Ganem, E. Karimov, T. Ali, M. Lederer, C. Sudarshan, T. Kampfe, A. Guntoro, and N. Wehn, in *2020 IEEE International Electron Devices Meeting (IEDM)* (IEEE, 2020), pp. 29.2.1–29.2.4.

- 396 M. Hoffmann, A.J. Tan, N. Shanker, Y.-H. Liao, L.-C. Wang, J.-H. Bae, C. Hu, and S. Salahuddin, *IEEE Electron Device Letters* **43**, 717 (2022).
- 397 K. Ni, P. Sharma, J. Zhang, M. Jerry, J.A. Smith, K. Tapily, R. Clark, S. Mahapatra, and S. Datta, *IEEE Transactions on Electron Devices* **65**, 2461 (2018).
- 398 E. Yurchuk, J. Muller, S. Muller, J. Paul, M. Pesic, R. van Bentum, U. Schroeder, and T. Mikolajick, *IEEE Transactions on Electron Devices* **63**, 3501 (2016).
- 399 N. Gong and T.-P. Ma, *IEEE Electron Device Letters* **37**, 1123 (2016).
- 400 A.J. Tan, Y.-H. Liao, L.-C. Wang, N. Shanker, J.-H. Bae, C. Hu, and S. Salahuddin, *IEEE Electron Device Letters* **42**, 994 (2021).
- 401 A.A. Sharma, B. Doyle, H.J. Yoo, I.-C. Tung, J. Kavalieros, M.V. Metz, M. Reshotko, P. Majhi, T. Brown-Heft, Y.-J. Chen, and V.H. Le, in *2020 IEEE International Electron Devices Meeting (IEDM)* (IEEE, 2020), pp. 18.5.1–18.5.4.
- 402 S. Dutta, H. Ye, A.A. Khandker, S.G. Kirtania, A. Khanna, K. Ni, and S. Datta, *IEEE Electron Device Letters* **43**, 382 (2022).
- 403 Z. Lin, M. Si, and P.D. Ye, in *2022 IEEE Symposium on VLSI Technology and Circuits (VLSI Technology and Circuits)* (IEEE, 2022), pp. 1–2.
- 404 S. Dunkel, M. Trentzsch, R. Richter, P. Moll, C. Fuchs, O. Gehring, M. Majer, S. Wittek, B. Muller, T. Melde, H. Mulaosmanovic, S. Slesazeck, S. Muller, J. Ocker, M. Noack, D.-A. Lohr, P. Polakowski, J. Muller, T. Mikolajick, J. Hontschel, B. Rice, J. Pellerin, and S. Beyer, in *2017 IEEE International Electron Devices Meeting (IEDM)* (IEEE, 2017), pp. 19.7.1–19.7.4.
- 405 M.Y. Zhuravlev, S.S. Jaswal, E.Y. Tsymbal, and R.F. Sabirianov, *Applied Physics Letters* **87**, 222114 (2005).
- 406 V. Garcia, S. Fusil, K. Bouzehouane, S. Enouz-Vedrenne, N.D. Mathur, A. Barthélemy, and M. Bibes, *Nature* **460**, 81 (2009).
- 407 E.Y. Tsymbal and H. Kohlstedt, *Science* **313**, 181 (2006).

- 408 F. Ambriz-Vargas, G. Kolhatkar, R. Thomas, R. Nouar, A. Sarkissian, C. Gomez-Yáñez, M.A. Gauthier, and A. Ruediger, *Applied Physics Letters* **110**, 093106 (2017).
- 409 Y. Wei, S. Matzen, T. Maroutian, G. Agnus, M. Salverda, P. Nukala, Q. Chen, J. Ye, P. Lecoeur, and B. Noheda, *Physical Review Applied* **12**, 031001 (2019).
- 410 Y. Wei, S. Matzen, C.P. Quinteros, T. Maroutian, G. Agnus, P. Lecoeur, and B. Noheda, *Npj Quantum Materials* **4**, (2019).
- 411 A. Chanthbouala, V. Garcia, R.O. Cherifi, K. Bouzehouane, S. Fusil, X. Moya, S. Xavier, H. Yamada, C. Deranlot, N.D. Mathur, M. Bibes, A. Barthélémy, and J. Grollier, *Nature Materials* **11**, 860 (2012).
- 412 S.S. Cheema, N. Shanker, C.-H. Hsu, A. Datar, J. Bae, D. Kwon, and S. Salahuddin, *Advanced Electronic Materials* **8**, 2100499 (2021).
- 413 H. Kohlstedt, A. Petraru, K. Szot, A. Rüdiger, P. Meuffels, H. Haselier, R. Waser, and V. Nagarajan, *Applied Physics Letters* **92**, 062907 (2008).
- 414 V. Mikheev, A. Chouprik, Y. Lebedinskii, S. Zarubin, A.M. Markeev, A.V. Zenkevich, and D. Negrov, *Nanotechnology* **31**, 215205 (2020).
- 415 M.C. Sulzbach, S. Estandía, X. Long, J. Lyu, N. Dix, J. Gàzquez, M.F. Chisholm, F. Sánchez, I. Fina, and J. Fontcuberta, *Advanced Electronic Materials* **6**, 1900852 (2019).
- 416 N. Gong, X. Sun, H. Jiang, K.S. Chang-Liao, Q. Xia, and T.P. Ma, *Applied Physics Letters* **112**, 262903 (2018).
- 417 Y. Wei, G. Vats, and B. Noheda, *Neuromorphic Computing and Engineering* **2**, 044007 (2022).
- 418 A.E. Boutaybi, T. Maroutian, L. Largeau, S. Matzen, and P. Lecoeur, *Physical Review Materials* **6**, (2022).
- 419 C.L. Platt, B. Dieny, and A.E. Berkowitz, *Journal of Applied Physics* **81**, 5523 (1997).
- 420 M.Y. Zhuravlev, S. Maekawa, and E.Y. Tsymbal, *Physical Review B* **81**, 104419 (2010).

- 421 V. Garcia, M. Bibes, L. Bocher, S. Valencia, F. Kronast, A. Crassous, X. Moya, S. Enouz-Vedrenne, A. Gloter, D. Imhoff, C. Deranlot, N.D. Mathur, S. Fusil, K. Bouzehouane, and A. Barthélémy, *Science* **327**, 1106 (2010).
- 422 M.Y. Zhuravlev, A. Alexandrov, L.L. Tao, and E.Y. Tsymbal, *Applied Physics Letters* **113**, 172405 (2018).
- 423 X. Du, H. Sun, H. Wang, J. Li, Y. Yin, and X. Li, *ACS Applied Materials Interfaces* **14**, 1355 (2021).
- 424 M.C. Sulzbach, H. Tan, S. Estandía, J. Gàzquez, F. Sánchez, I. Fina, and J. Fontcuberta, *ACS Applied Electronic Materials* **3**, 3657 (2021).
- 425 L. Bégon-Lours, M. Halter, F.M. Puglisi, L. Benatti, D.F. Falcone, Y. Popoff, D.D. Pineda, M. Sousa, and B.J. Offrein, *Advanced Electronic Materials* **8**, 2101395 (2022).
- 426 Y. Wang, Q. Wang, J. Zhao, T. Niermann, Y. Liu, L. Dai, K. Zheng, Y. Sun, Y. Zhang, J. Schwarzkopf, T. Schroeder, Z. Jiang, W. Ren, and G. Niu, *Applied Materials Today* **29**, 101587 (2022).
- 427 M.C. Sulzbach, S. Estandía, J. Gàzquez, F. Sánchez, I. Fina, and J. Fontcuberta, *Advanced Functional Materials* **30**, 2002638 (2020).
- 428 M.L. Müller, M.T. Becker, N. Strkalj, and J.L. MacManus-Driscoll, *Applied Physics Letters* **121**, 093501 (2022).
- 429 P. Wang, C.J. Perini, A. OHara, H. Gong, P. Wang, E.X. Zhang, M.W. Mccurdy, D.M. Fleetwood, R.D. Schrimpf, S.T. Pantelides, and E.M. Vogel, *IEEE Transactions on Nuclear Science* **66**, 420 (2019).
- 430 P. Chaudhary, P. Buragohain, M. Kozodaev, S. Zarubin, V. Mikheev, A. Chouprik, A. Lipatov, A. Sinitskii, A. Zenkevich, and A. Gruverman, *Applied Physics Letters* **118**, 083106 (2021).
- 431 J.P.B. Silva, K.C. Sekhar, H. Pan, J.L. MacManus-Driscoll, and M. Pereira, *ACS Energy Letters* **6**, 2208 (2021).

- 432 M.G. Kozodaev, A.G. Chernikova, R.R. Khakimov, M.H. Park, A.M. Markeev, and C.S. Hwang, *Applied Physics Letters* **113**, 123902 (2018).
- 433 J.P.B. Silva, J.M.B. Silva, K.C. Sekhar, H. Palneedi, M.C. Istrate, R.F. Negrea, C. Ghica, A. Chahboun, M. Pereira, and M.J.M. Gomes, *Journal of Materials Chemistry A* **8**, 14171 (2020).
- 434 D. Das, V. Gaddam, and S. Jeon, *IEEE Electron Device Letters* **42**, 331 (2021).
- 435 Y. He, G. Zheng, X. Wu, W.-J. Liu, D.W. Zhang, and S.-J. Ding, *Nanoscale Advances* **4**, 4648 (2022).
- 436 T. Zhang, X. Chen, Y. Thakur, B. Lu, Q. Zhang, J. Runt, and Q.M. Zhang, *Science Advances* **6**, 1 (2020).
- 437 J. Sun, B. Luo, and H. Li, *Advanced Energy and Sustainability Research* **3**, 2100191 (2022).
- 438 Q. Li, F. Liu, T. Yang, M.R. Gadinski, G. Zhang, L.-Q. Chen, and Q. Wang, *Proceedings of the National Academy of Sciences* **113**, 9995 (2016).
- 439 A.R. Jayakrishnan, J.P.B. Silva, K. Kamakshi, D. Dastan, V. Annapureddy, M. Pereira, and K.C. Sekhar, *Progress in Materials Science* **132**, 101046 (2023).
- 440 J. Chen, Y. Wang, X. Xu, Q. Yuan, Y. Niu, Q. Wang, and H. Wang, *Journal of Materials Chemistry A* **7**, 3729 (2019).
- 441 J. Gao, D.-K. Kwon, S. Perini, J. Long, S. Zhang, and M.T. Lanagan, *Journal of the American Ceramic Society* **99**, 4045 (2016).
- 442 X. Wu, X. Chen, Q.M. Zhang, and D.Q. Tan, *Energy Storage Materials* **44**, 29 (2022).
- 443 F. Shang, J. Wei, J. Xu, G. Zhang, M. Li, K. Xu, X. Liu, B. Li, H. Huang, G. Chen, and H. Xu, *ACS Applied Materials & Interfaces* **14**, 53081 (2022).
- 444 T. Song, R. Bachelet, G. Saint-Girons, R. Solanas, I. Fina, and F. Sánchez, *ACS Applied Electronic Materials* **2**, 3221 (2020).

- 445 A.P.S. Crema, M.C. Istrate, A. Silva, V. Lenzi, L. Domingues, M.O. Hill, V.S. Teodorescu, C. Ghica, M.J.M. Gomes, M. Pereira, L. Marques, J.L. MacManus-Driscoll, and J.P.B. Silva, *Advanced Science* **10**, 2207390 (2023).
- 446 Y.A. Hassan and H. Hu, *Composites Part A: Applied Science and Manufacturing* **138**, 106064 (2020).
- 447 S. Kang, W.-S. Jang, A.N. Morozovska, O. Kwon, Y. Jin, Y.-H. Kim, H. Bae, C. Wang, S.-H. Yang, A. Belianinov, S. Randolph, E.A. Eliseev, L. Collins, Y. Park, S. Jo, M.-H. Jung, K.-J. Go, H.W. Cho, S.-Y. Choi, J.H. Jang, S. Kim, H.Y. Jeong, J. Lee, O.S. Ovchinnikova, J. Heo, S.V. Kalinin, Y.-M. Kim, and Y. Kim, *Science* **376**, 731 (2022).
- 448 S. Cheema, N. Shanker, S.-L. Hsu, J. Schaadt, N. Ellis, M. Cook, R. Rastogi, R. Pilawa-Podgurski, J. Ciston, M. Mohamed, and S. Salahuddin, (2023).
- 449 X. Li, C. Li, Z. Xu, Y. Li, Y. Yang, H. Hu, Z. Jiang, J. Wang, J. Ren, C. Zheng, C. Lu, and Z. Wen, *Physica Status Solidi RRL* **15**, 2000481 (2021).
- 450 H. Pan, S. Lan, S. Xu, Q. Zhang, H. Yao, Y. Liu, F. Meng, E.-J. Guo, L. Gu, D. Yi, X.R. Wang, H. Huang, J.L. MacManus-Driscoll, L.-Q. Chen, K.-J. Jin, C.-W. Nan, and Y.-H. Lin, *Science* **374**, 100 (2021).
- 451 H. Chen, L. Liu, Z. Yan, X. Yuan, H. Luo, and D. Zhang, *Advanced Science* **2300792**, 1 (2023).
- 452 E.T. Breyer, H. Mulaosmanovic, J. Trommer, T. Melde, S. Dunkel, M. Trentzsch, S. Beyer, T. Mikolajick, and S. Slesazeck, in *ESSDERC 2019 - 49th European Solid-State Device Research Conference (ESSDERC)* (IEEE, 2019), pp. 118–121.
- 453 S. Lancaster, Q.T. Duong, E. Covi, T. Mikolajick, and S. Slesazeck, in *ESSCIRC 2022-IEEE 48th European Solid State Circuits Conference (ESSCIRC)* (IEEE, 2022), pp. 137–140.
- 454 A. Kazemi, F. Müller, M.M. Sharifi, H. Errahmouni, G. Gerlach, T. Kämpfe, M. Imani, X.S. Hu, and M. Niemier, *Scientific Reports* **12**, 19201 (2022).

- 455 H. Mulaosmanovic, S. Dunkel, M. Trentzsch, S. Beyer, E.T. Breyer, T. Mikolajick, and S. Slesazek, *IEEE Transactions on Electron Devices* **67**, 5804 (2020).
- 456 H. Mulaosmanovic, J. Ocker, S. Müller, U. Schroeder, J. Müller, P. Polakowski, S. Flachowsky, R. van Bentum, T. Mikolajick, and S. Slesazek, *ACS Applied Materials Interfaces* **9**, 3792 (2017).
- 457 M. Jerry, P.-Y. Chen, J. Zhang, P. Sharma, K. Ni, S. Yu, and S. Datta, in *2017 IEEE International Electron Devices Meeting (IEDM)* (IEEE, 2017), pp. 6.2.1–6.2.4.
- 458 S. Beyer, S. Dünkkel, M. Trentzsch, J. Müller, A. Hellmich, D. Utess, J. Paul, D. Kleimaier, J. Pellerin, S. Müller, J. Ocker, A. Benoist, H. Zhou, M. Mennenga, M. Schuster, F. Tassan, M. Noack, A. Pourkeramati, F. Müller, M. Lederer, T. Ali, R. Hoffmann, T. Kämpfe, K. Seidel, H. Mulaosmanovic, E.T. Breyer, T. Mikolajick, and S. Slesazek, In *IEEE Inter. Memory Workshop, IMW,IEEE, Piscataway, NJ 1* (2020).
- 459 H. Mulaosmanovic, T. Mikolajick, and S. Slesazek, *IEEE Electron Device Letters* **39**, 135 (2018).
- 460 E. Covi, H. Mulaosmanovic, B. Max, S. Slesazek, and T. Mikolajick, *Neuromorphic Computing and Engineering* **2**, 012002 (2022).
- 461 M. Halter, L. Bégon-Lours, V. Bragaglia, M. Sousa, B.J. Offrein, S. Abel, M. Luisier, and J. Fompeyrine, *ACS Applied Materials Interfaces* **12**, 17725 (2020).
- 462 P. Buragohain, A. Erickson, P. Kariuki, T. Mittmann, C. Richter, P.D. Lomenzo, H. Lu, T. Schenk, T. Mikolajick, U. Schroeder, and A. Gruverman, *ACS Applied Materials Interfaces* **11**, 35115 (2019).
- 463 R. Fontanini, J. Barbot, M. Segatto, S. Lancaster, Q. Duong, F. Driussi, L. Grenouillet, L. Triozon, J. Coignus, T. Mikolajick, S. Slesazek, and D. Esseni, *IEEE Journal of the Electron Devices Society* **10**, 593 (2022).
- 464 K. Ni, J.A. Smith, B. Grisafe, T. Rakshit, B. Obradovic, J.A. Kittl, M. Rodder, and S. Datta, in *2018 IEEE International Electron Devices Meeting (IEDM)* (IEEE, 2018), pp. 13.2.1–13.2.4.

- 465 Z. Jiang, Z. Zhao, S. Deng, Y. Xiao, Y. Xu, H. Mulaosmanovic, S. Duenkel, S. Beyer, S. Meninger, M. Mohamed, R. Joshi, X. Gong, S. Kurinec, V. Narayanan, and K. Ni, *IEEE Transactions on Electron Devices* **69**, 6722 (2022).
- 466 C.B. Sawyer and C.H. Tower, *Physical Review* **35**, 269 (1930).
- 467 K. Prume, T. Schmitz, and S. Tiedke, *Polar Oxides* (Wiley, 2004), pp. 53–75.
- 468 R. Meyer, R. Waser, K. Prume, T. Schmitz, and S. Tiedke, *Applied Physics Letters* **86**, 142907 (2005).
- 469 J.F. Scott, L. Kammerdiner, M. Parris, S. Traynor, V. Ottenbacher, A. Shawabkeh, and W.F. Oliver, *Journal of Applied Physics* **64**, 787 (1988).
- 470 M. Massarotto, F. Driussi, A. Affanni, S. Lancaster, S. Slesazek, T. Mikolajick, and D. Esseni, *Solid-State Electronics* **200**, 108569 (2023).
- 471 S. Mueller, J. Muller, U. Schroeder, and T. Mikolajick, *IEEE Transactions on Device and Materials Reliability* **13**, (2012).
- 472 R. Alcala, M. Materano, P.D. Lomenzo, L. Grenouillet, T. Francois, J. Coignus, N. Vaxelaire, C. Carabasse, S. Chevalliez, F. Andrieu, T. Mikolajick, and U. Schroeder, in *2022 6th IEEE Electron Devices Technology & Manufacturing Conference (EDTM)* (IEEE, 2022).
- 473 B. Max, M. Hoffmann, H. Mulaosmanovic, S. Slesazek, and T. Mikolajick, *ACS Applied Electronic Materials* **2**, 4023 (2020).
- 474 F. Ambriz-Vargas, G. Kolhatkar, M. Broyer, A. Hadj-Youssef, R. Nouar, A. Sarkissian, R. Thomas, C. Gomez-Yáñez, M.A. Gauthier, and A. Ruediger, *ACS Applied Materials Interfaces* **9**, 13262 (2017).
- 475 N. Balke, P. Maksymovych, S. Jesse, A. Herklotz, A. Tselev, C.-B. Eom, I.I. Kravchenko, P. Yu, and S.V. Kalinin, *ACS Nano* **9**, 6484 (2015).
- 476 M. Segatto, R. Fontanini, F. Driussi, D. Lizzit, and D. Esseni, *IEEE Journal of the Electron Devices Society* **10**, 324 (2022).

- 477 M. Si, X. Lyu, and P.D. Ye, *ACS Applied Electronic Materials* **1**, 745 (2019).
- 478 H.-H. Huang, T.-Y. Wu, Y.-H. Chu, M.-H. Wu, C.-H. Hsu, H.-Y. Lee, S.-S. Sheu, W.-C. Lo, and T.-H. Hou, in *2019 IEEE International Electron Devices Meeting (IEDM)* (IEEE, 2019), pp. 32.2.1–32.2.4.
- 479 B. Max, M. Hoffmann, S. Slesazek, and T. Mikolajick, *IEEE Journal of the Electron Devices Society* **7**, 1175 (2019).
- 480 J. Barbot, J. Coignus, F. Triozon, C. Carabasse, O. Glorieux, F. Aussenac, F. Andrieu, and L. Grenouillet, in *International Conference on Solid State Devices and Materials (SSDM)* (2022).
- 481 K. Nair, M. Holzer, C. Dubourdieu, and V. Deshpande, *ACS Applied Electronic Materials* **Accepted**, (2023).
- 482 S. Narayanan, E. Covi, V. Havel, C. Frenkel, S. Lancaster, Q. Duong, S. Slesazek, T. Mikolajick, M. Payvand, and G. Indiveri, in *2022 IEEE International Symposium on Circuits and Systems (ISCAS)* (2022), pp. 717–721.
- 483 F. Huang, M. Passlack, S.L. Liew, Z. Yu, Q. Lin, A. Babadi, V.D.-H. Hou, P.C. McIntyre, and S.S. Wong, *IEEE Electron Device Letters* **43**, 212 (2022).
- 484 J. Li, M. Si, Y. Qu, X. Lyu, and P.D. Ye, *IEEE Transactions on Electron Devices* **68**, 1214 (2021).
- 485 L. Benatti and F.M. Puglisi, in *2021 IEEE International Integrated Reliability Workshop (IIRW)* (IEEE, 2021), pp. 1–6.
- 486 A.K. Tagantsev, I. Stolichnov, N. Setter, J.S. Cross, and M. Tsukada, *Physical Review B* **66**, (2002).
- 487 Y. Ishibashi and Y. Takagi, *J. Phys. Soc.* **31**, (1971).
- 488 X. Lyu, M. Si, P.R. Shrestha, K.P. Cheung, and P.D. Ye, in *2019 IEEE International Electron Devices Meeting (IEDM)* (IEEE, 2019), pp. 15.2.1–15.2.4.

489 T. Francois, L. Grenouillet, J. Coignus, N. Vaxelaire, C. Carabasse, F. Aussenac, S. Chevalliez, S. Slesazeck, C. Richter, P. Chiquet, M. Bocquet, U. Schroeder, T. Mikolajick, F. Gaillard, and E. Nowak, *Applied Physics Letters* **118**, 062904 (2021).

490 J.A. Rodriguez, K. Remack, K. Boku, K.R. Udayakumar, S. Aggarwal, S.R. Summerfelt, F.G. Celii, S. Martin, L. Hall, K. Taylor, T. Moise, H. McAdams, J. McPherson, R. Bailey, G. Fox, and M. Depner, *IEEE Transactions on Device and Materials Reliability* **4**, 436 (2004).

491 T. Nishimura, L. Xu, S. Shibayama, T. Yajima, S. Migita, and A. Toriumi, *Japanese Journal of Applied Physics* **55**, 08 (2016).

492 A. Chouprik, E. Kondratyuk, V. Mikheev, Y. Matveyev, M. Spiridonov, A. Chernikova, M.G. Kozodaev, A.M. Markeev, A. Zenkevich, and D. Negrov, *Acta Materialia* **204**, 116515 (2021).

493 S. Mueller, J. Muller, U. Schroeder, and T. Mikolajick, *IEEE Transactions on Device and Materials Reliability* **13**, 93 (2013).

494 *IEEE International Electron Devices Meeting (IEDM)* 6 (2021).

495 E.D. Grimley, T. Schenk, X. Sang, M. Pešić, U. Schroeder, T. Mikolajick, and J.M. LeBeau, *Advanced Electronic Materials* **2**, 1600173 (2016).

496 K. Tahara, K. Toprasertpong, Y. Hikosaka, K. Nakamura, H. Saito, M. Takenaka, and S. Takagi, *2021 Symposium on VLSI Technology* 1 (2021).

497 P.D. Lomenzo, S. Slesazeck, M. Hoffmann, T. Mikolajick, U. Schroeder, B. Max, and T. Mikolajick, in *2019 19th Non-Volatile Memory Technology Symposium (NVMTS)* (IEEE, 2019), pp. 1–8.

498 L. Grenouillet, T. Francois, J. Coignus, S. Kerdiles, N. Vaxelaire, C. Carabasse, F. Mehmood, S. Chevalliez, C. Pellissier, F. Triozon, F. Mazen, G. Rodriguez, T. Magis, V. Havel, S. Slesazeck, F. Gaillard, U. Schroeder, T. Mikolajick, and E. Nowak, in *2020 IEEE Symposium on VLSI Technology* (IEEE, 2020), pp. 1–2.

- 499 T. Mittmann, M. Materano, S.-C. Chang, I. Karpov, T. Mikolajick, and U. Schroeder, in *2020 IEEE International Electron Devices Meeting (IEDM)* (IEEE, 2020), pp. 18.4.1–18.4.4.
- 500 Y.D. Lin, H.Y. Lee, Y.T. Tang, P.C. Yeh, H.Y. Yang, P.S. Yeh, C.Y. Wang, J.W. Su, S.H. Li, S.S. Sheu, T.H. Hou, W.C. Lo, M.H. Lee, M.F. Chang, Y.C. King, and C.J. Lin, *2019 IEEE International Electron Devices Meeting (IEDM)* 15 (2019).
- 501 R. Alcala, M. Materano, P.D. Lomenzo, L. Grenouillet, T. Francois, J. Coignus, N. Vaxelaire, C. Carabasse, S. Chevalliez, F. Andrieu, T. Mikolajick, and U. Schroeder, *IEEE Journal of the Electron Devices Society* **10**, 907 (2022).
- 502 H. Mulaosmanovic, E.T. Breyer, T. Mikolajick, and S. Slesazek, in *2020 4th IEEE Electron Devices Technology & Manufacturing Conference (EDTM)* (IEEE, 2020), pp. 1–4.
- 503 M. Halter, L. Bégon-Lours, M. Sousa, Y. Popoff, U. Drechsler, V. Bragaglia, and B.J. Offrein, *Commun Mater* **4**, 14 (2023).
- 504 P. Nukala, M. Ahmadi, Y. Wei, S. de Graaf, E. Stylianidis, T. Chakraborty, S. Matzen, H.W. Zandbergen, A. Björling, D. Mannix, D. Carbone, B. Kooi, and B. Noheda, *Microscopy and Microanalysis* **28**, 2268 (2022).
- 505 L. Bégon-Lours, M. Halter, M. Sousa, Y. Popoff, D.D. Pineda, D.F. Falcone, Z. Yu, S. Reidt, L. Benatti, F.M. Puglisi, and B.J. Offrein, *Neuromorphic Computing and Engineering* **2**, 024001 (2022).
- 506 M. Materano, P.D. Lomenzo, A. Kersch, M.H. Park, T. Mikolajick, and U. Schroeder, *Inorganic Chemistry Frontiers* **8**, 2650 (2021).
- 507 S. Belahcen, T. Francois, L. Grenouillet, A. Bsiesy, J. Coignus, and M. Bonvalot, *Applied Physics Letters* **117**, 252903 (2020).
- 508 F. Mehmood, T. Mikolajick, and U. Schroeder, *Applied Physics Letters* **117**, 092902 (2020).

- 509 J.Y. Park, D.H. Lee, K. Yang, S.H. Kim, G.T. Yu, G.H. Park, E.B. Lee, K.H. Kim, and M.H. Park, *ACS Applied Electronic Materials* **4**, 1369 (2021).
- 510 H. Jang, A. Kashir, S. Oh, and H. Hwang, *Nanotechnology* **33**, 395205 (2022).
- 511 T. Mimura, Y. Tashiro, T. Shimizu, and H. Funakubo, *ACS Applied Electronic Materials* **5**, 1600 (2023).
- 512 P.D. Lomenzo, C. Richter, M. Materano, T. Mikolajick, U. Schroeder, T. Schenk, D. Spirito, and S. Gorfman, in *2020 Joint Conference of the IEEE International Frequency Control Symposium and International Symposium on Applications of Ferroelectrics (IFCS-ISAF)* (IEEE, 2020), pp. 1–4.
- 513 T. Shimizu, T. Mimura, T. Kiguchi, T. Shiraishi, T. Konno, Y. Katsuya, O. Sakata, and H. Funakubo, *Applied Physics Letters* **113**, 212901 (2018).
- 514 M. Lederer, T. Kämpfe, N. Vogel, D. Utess, B. Volkmann, T. Ali, R. Olivo, J. Müller, S. Beyer, M. Trentzsch, K. Seidel, and L.M. Eng, *Nanomaterials* **10**, 384 (2020).
- 515 L.-Y. Ma and S. Liu, *Physical Review Letters* **130**, (2023).
- 516 E.V. Skopin, N. Guillaume, L. Alrifai, P. Gonon, and A. Bsiesy, *Applied Physics Letters* **120**, 172901 (2022).
- 517 D. Bondurant, *Ferroelectrics* **112**, 273 (1990).
- 518 T.P. Ma and J.-P. Han, *IEEE Electron Device Letters* **23**, 386 (2002).
- 519 J.-M. Koo, J.-E. Lim, D.-C. Yoo, S.-O. Park, H.-S. Kim, H. Han, S. Baik, J.-Y. Choi, Y.J. Park, Y. Park, B.-S. Seo, S. Kim, S. Shin, J.-H. Lee, H. Baik, J.-H. Lee, J.H. Lee, and B.-J. Bae, in *IEEE International Electron Devices Meeting 2005. IEDM Technical Digest* (IEEE, 2005), pp. 340–343.
- 520 S. Yoon, S.-I. Hong, G. Choi, D. Kim, I. Kim, S.M. Jeon, C. Kim, and K. Min, in *2022 IEEE International Memory Workshop (IMW)* (IEEE, 2022), pp. 1–4.
- 521 T. Mikolajick, M.H. Park, L. Begon-Lours, and S. Slesazek, *Advanced Materials* **2206042** (2022).

- 522 H. Zhou, J. Ocker, A. Padovani, M. Pesic, M. Trentzsch, S. Dunkel, H. Mulaosmanovic, S. Slesazeck, L. Larcher, S. Beyer, S. Muller, and T. Mikolajick, in *2020 IEEE International Electron Devices Meeting (IEDM)* (IEEE, 2020), pp. 18.6.1–18.6.4.
- 523 F. Hamzaoglu, U. Arslan, N. Bisnik, S. Ghosh, M.B. Lal, N. Lindert, M. Meterelliyoz, R.B. Osborne, J. Park, S. Tomishima, Y. Wang, and K. Zhang, in *2014 IEEE International Solid-State Circuits Conference Digest of Technical Papers (ISSCC)* (IEEE, 2014), pp. 230–231.
- 524 S.-C. Chang, N. Haratipour, S. Shivaraman, T.L. Brown-Heft, J. Peck, C.-C. Lin, I.-C. Tung, D.R. Merrill, H. Liu, C.-Y. Lin, F. Hamzaoglu, M.V. Metz, I.A. Young, J. Kavalieros, and U.E. Avci, in *2020 IEEE International Electron Devices Meeting (IEDM)* (IEEE, 2020), pp. 28.1.1–28.1.4.
- 525 S.-C. Chang, N. Haratipour, S. Shivaraman, C. Neumann, S. Atanasov, J. Peck, N. Kabir, I.-C. Tung, H. Liu, B. Krist, A. Oni, S. Sung, B. Doyle, G. Allen, C. Engel, A. Roy, T. Hoff, H. Li, F. Hamzaoglu, R. Bristol, M. Radosavljevic, B. Turkot, M. Metz, I. Young, J. Kavalieros, and U. Avci, in *2021 IEEE International Electron Devices Meeting (IEDM)* (IEEE, 2021), pp. 33.2.1–33.2.4.
- 526 T.S. Boscke, J. Muller, D. Brauhaus, U. Schroder, and U. Bottger, in *2011 International Electron Devices Meeting* (IEEE, 2011), pp. 24.5.1–24.5.4.
- 527 Z. Wang, N. Tasneem, J. Hur, H. Chen, S. Yu, W. Chern, and A. Khan, in *2021 IEEE International Electron Devices Meeting (IEDM)* (IEEE, 2021), pp. 19.3.1–19.3.4.
- 528 M. Kim, J. Kim, G. Park, L. Everson, H. Kim, S. Song, S. Lee, and C.H. Kim, in *2018 IEEE International Electron Devices Meeting (IEDM)* (IEEE, 2018), pp. 15.4.1–15.4.4.
- 529 G. Spadini, I. Karpov, and D. Kencke, in *2010 International Conference on Simulation of Semiconductor Processes and Devices, Bologna, Italy*, (IEEE, 2010), pp. 223–226.
- 530 M. Saitoh, R. Ichihara, M. Yamaguchi, K. Suzuki, K. Takano, K. Akari, K. Takahashi, Y. Kamiya, K. Matsuo, Y. Kamimuta, K. Sakuma, K. Ota, and S. Fujii, in *2020 IEEE International Electron Devices Meeting (IEDM)* (IEEE, 2020), pp. 18.1.1–18.1.4.

This is the author's peer reviewed, accepted manuscript. However, the online version of record will be different from this version once it has been copyedited and typeset.

PLEASE CITE THIS ARTICLE AS DOI: 10.1063/5.0148068

531 K. Ishimaru, in *2019 IEEE International Electron Devices Meeting (IEDM)* (IEEE, 2019), pp. 1.3.1–1.3.6.

532 U. Schroeder, C. Richter, M. H. Park, T. Schenk, M. Pešić, M. Hoffmann, F. P. G. Fengler, D. Pohl, B. Rellinghaus, C. Zhou, C.-C. Chung, J. L. Jones, T. Mikolajick, *Inorg. Chem.* **57**, 2752 (2018).

533 M. M. Dahan, H. Mulaosmanovic, O. Levit, S. Dünkel, S. Beyer, E. Yalon, *Nano Lett.* **23**, 1395–1400 (2023).

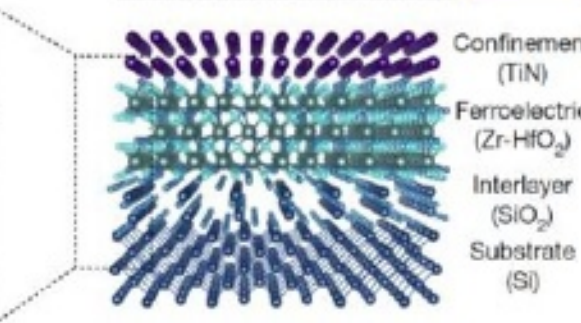
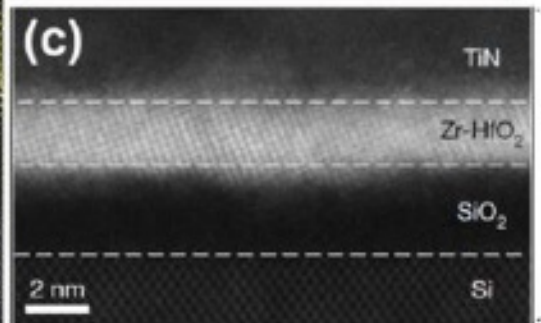
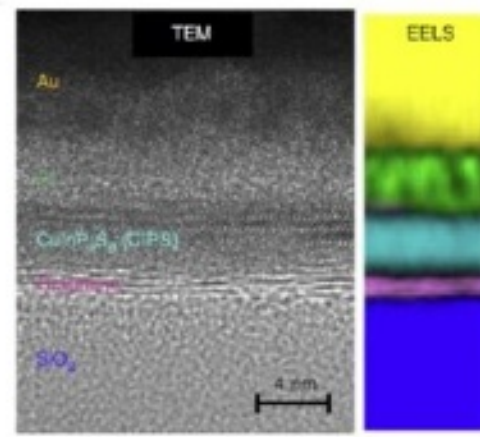
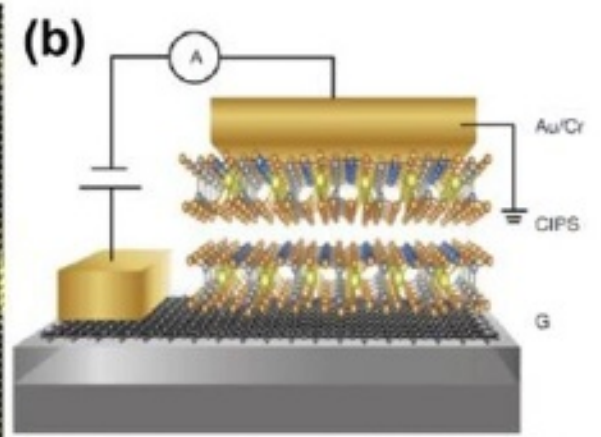
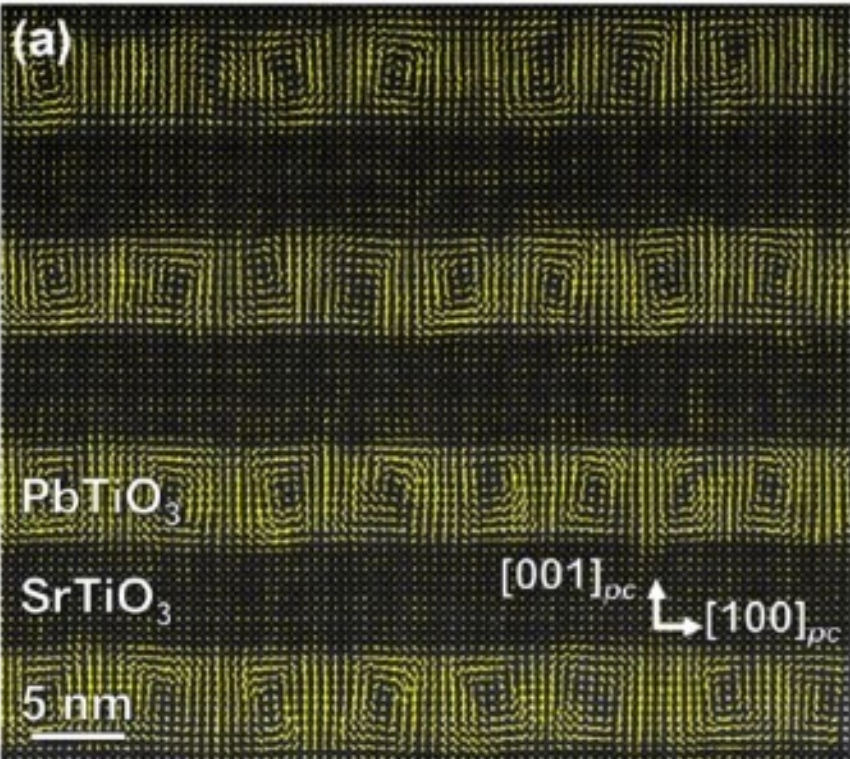

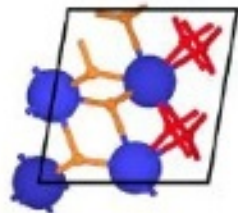
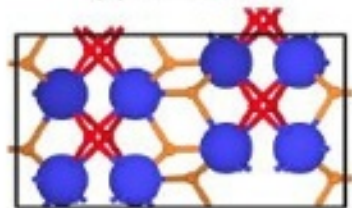
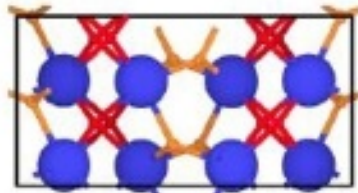
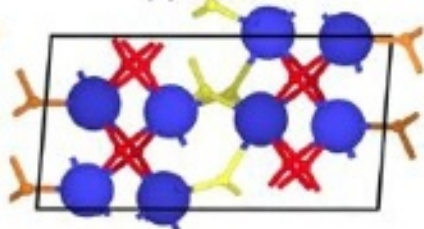
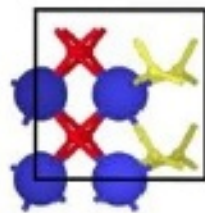
(a) $m P2_1/c$ (b) $ol^* Pbc_a$ (c) $ol Pbc_a$ (d) $mlll Pc$ (e) $olll Pca2_1$ 

E

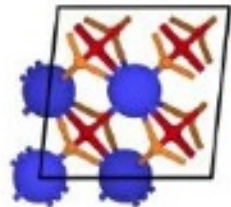
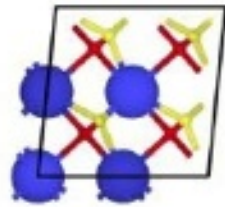
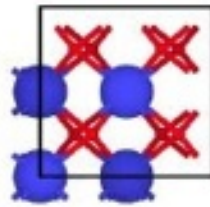
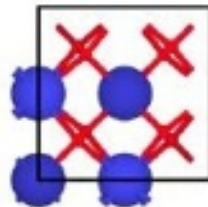
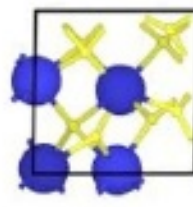
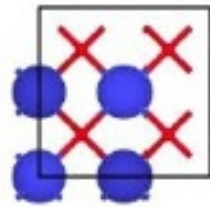
(f) $oV Pnma$ (g) $oIV Pmn2_1$ (h) $t P4_2/nmc$ (i) $cll P\bar{4}3m$ (j) $r R3$ (k) $c Fm\bar{3}m$ 

highest energy E

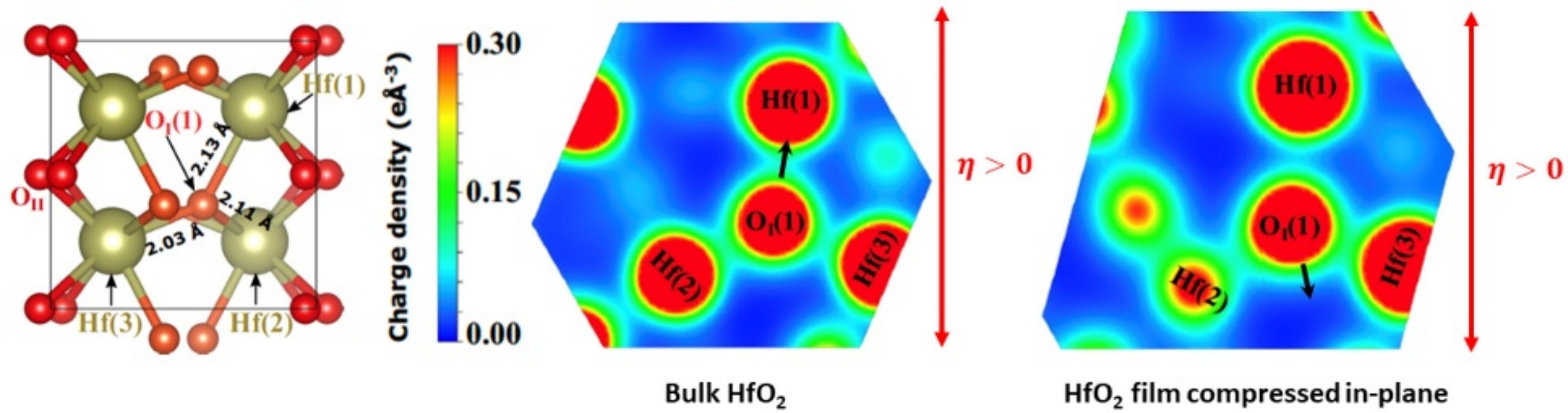

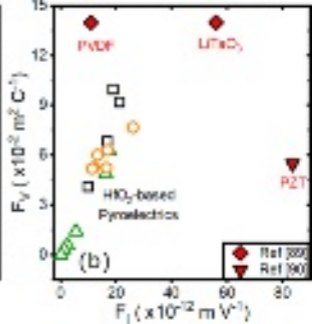
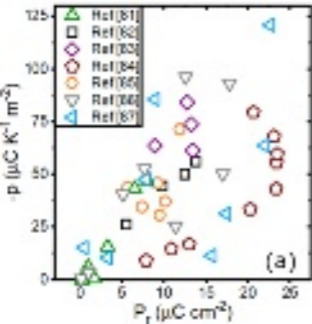

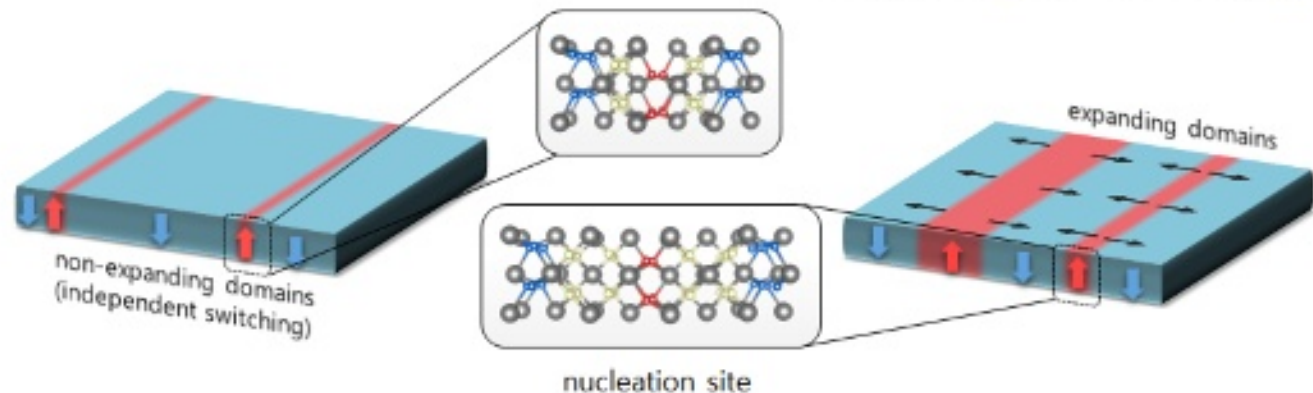
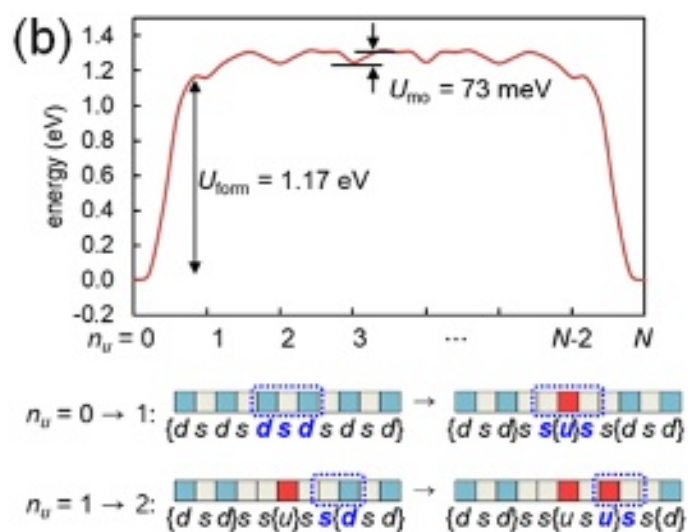
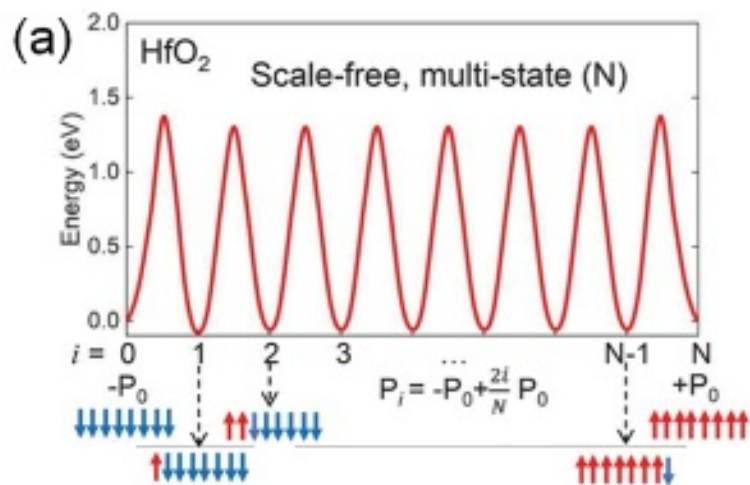

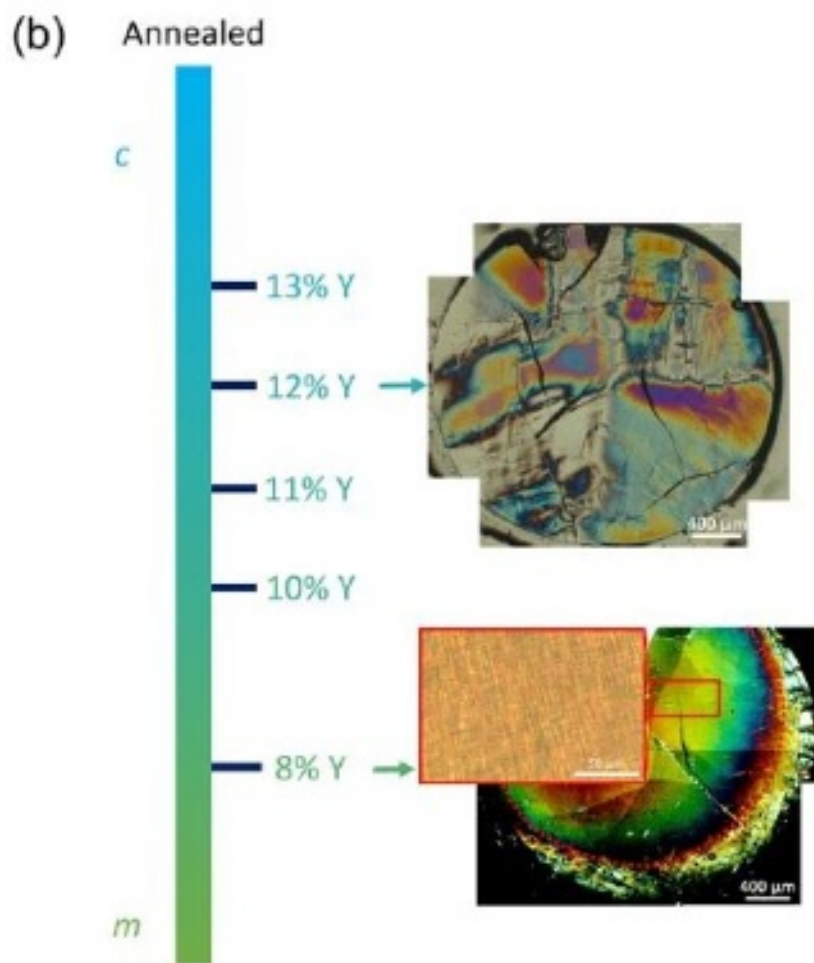
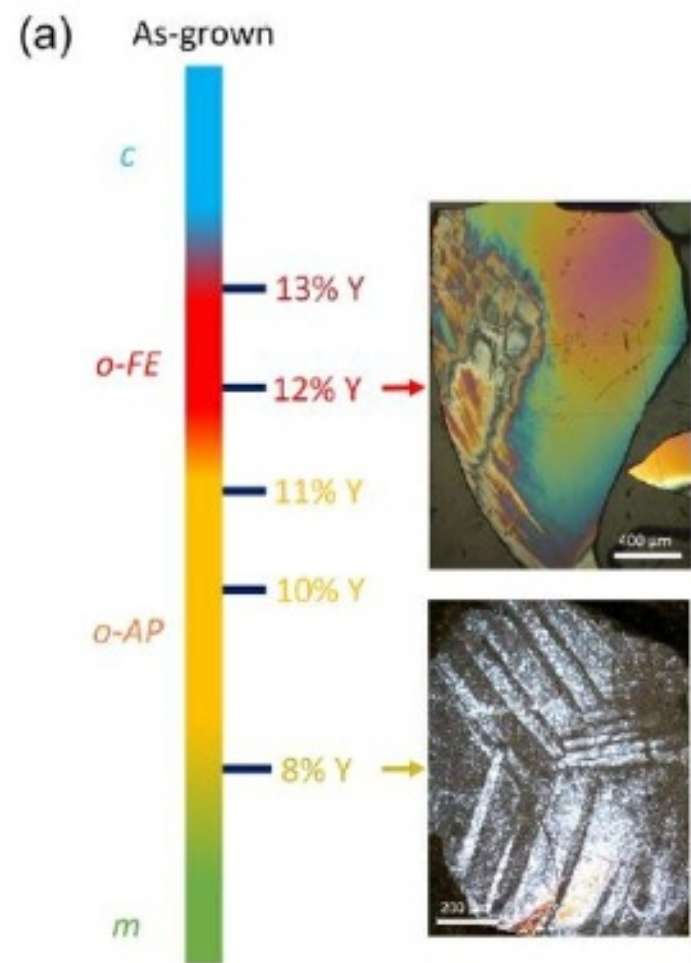

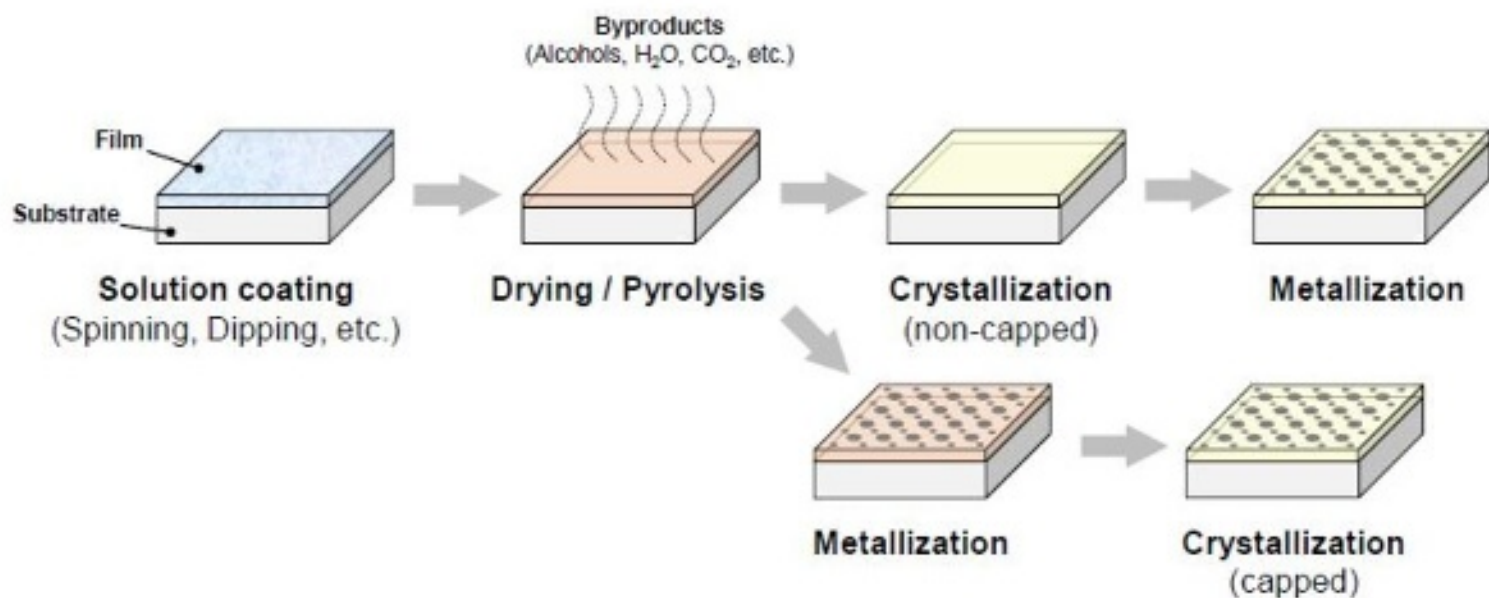
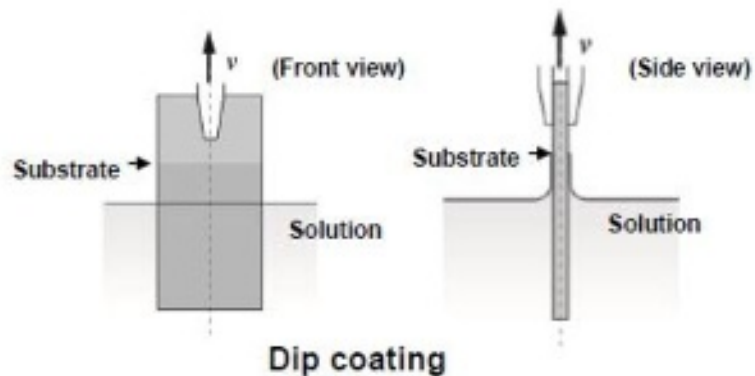
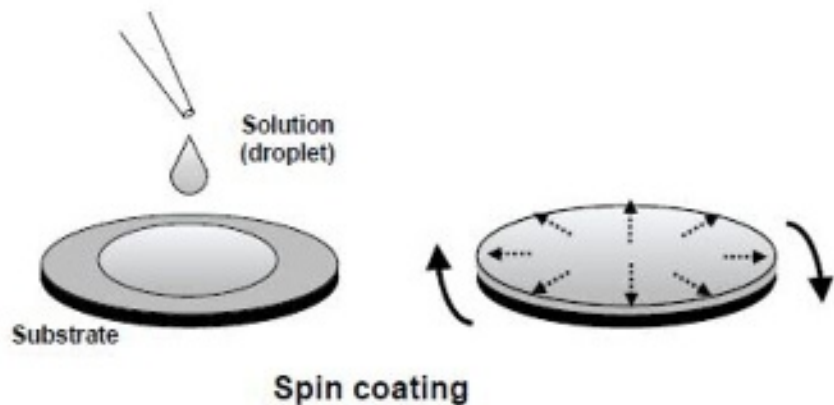

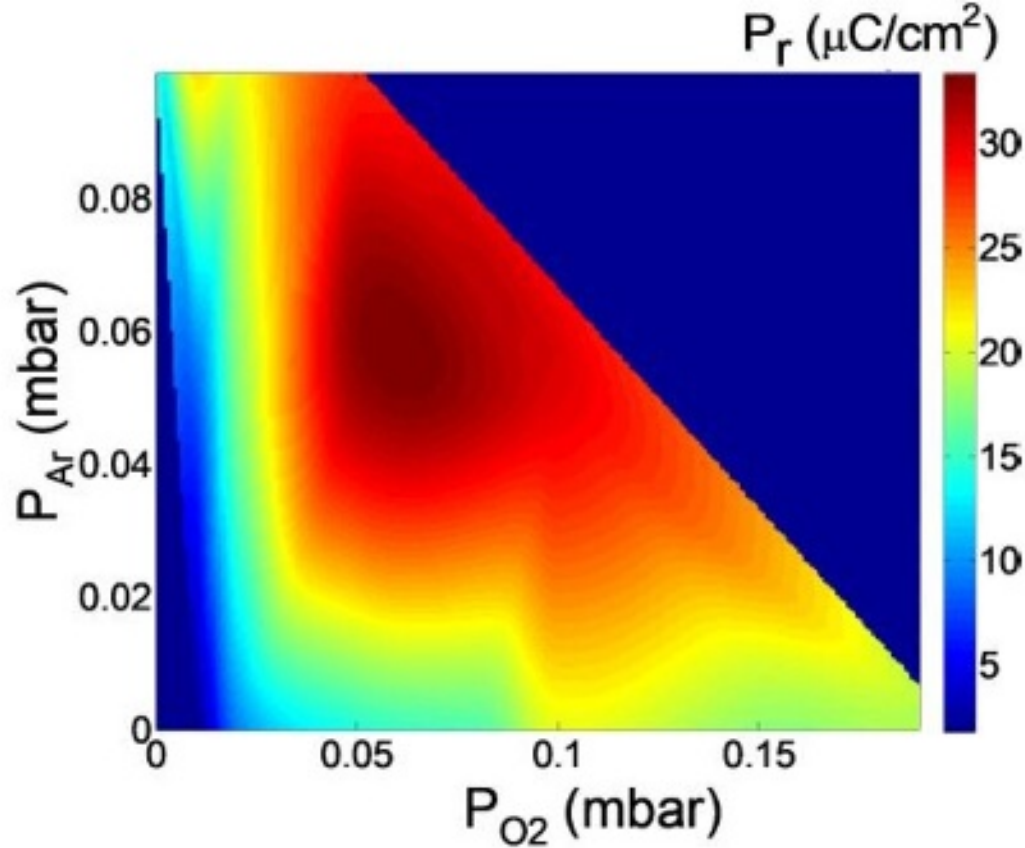

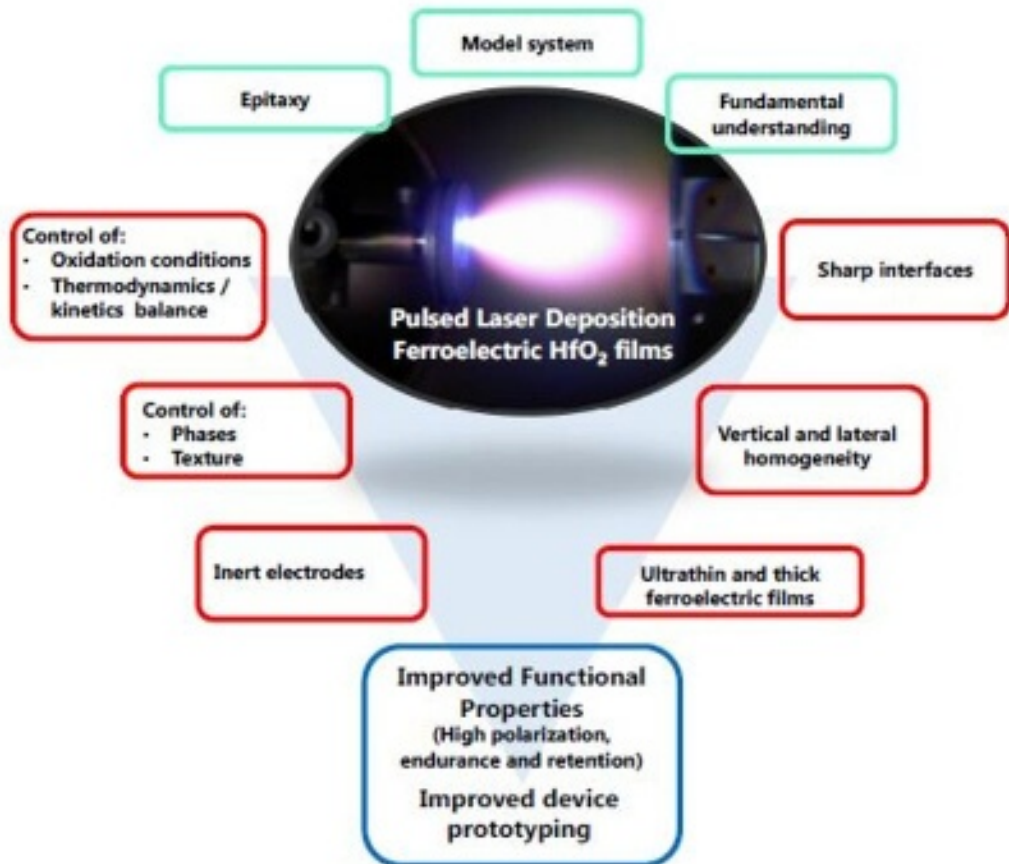

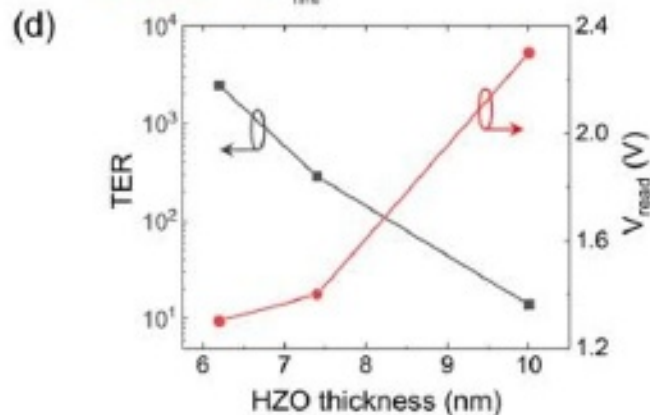
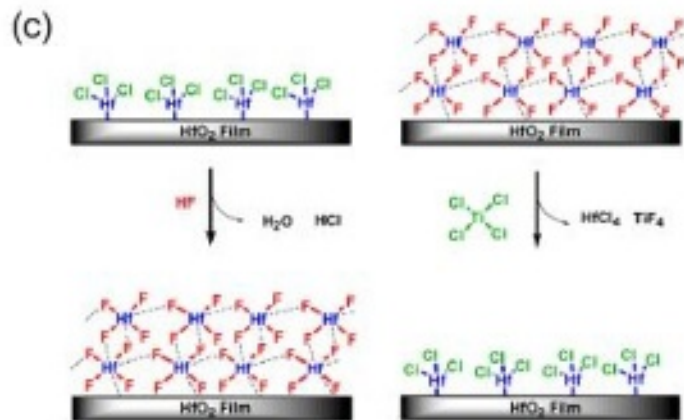
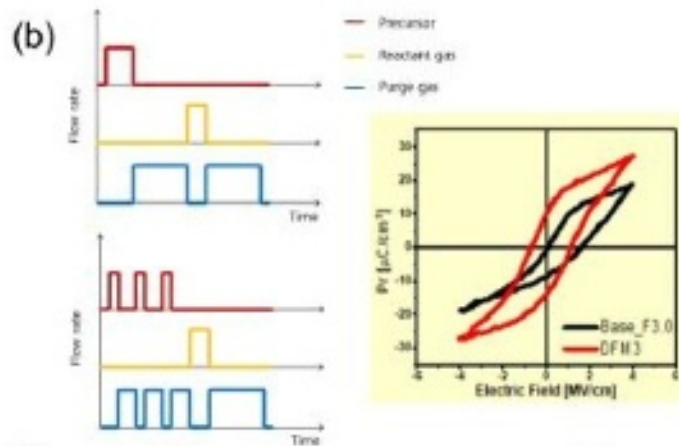
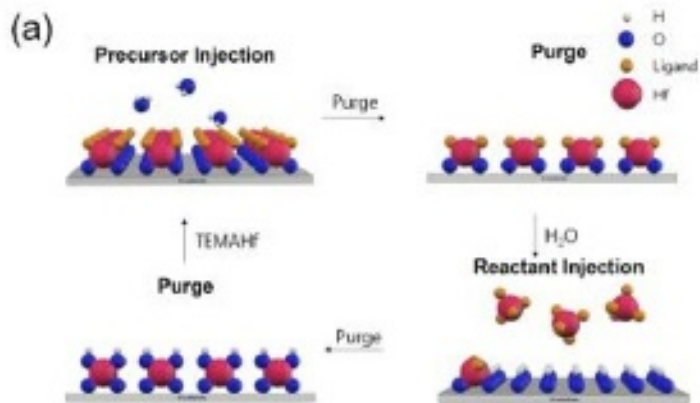

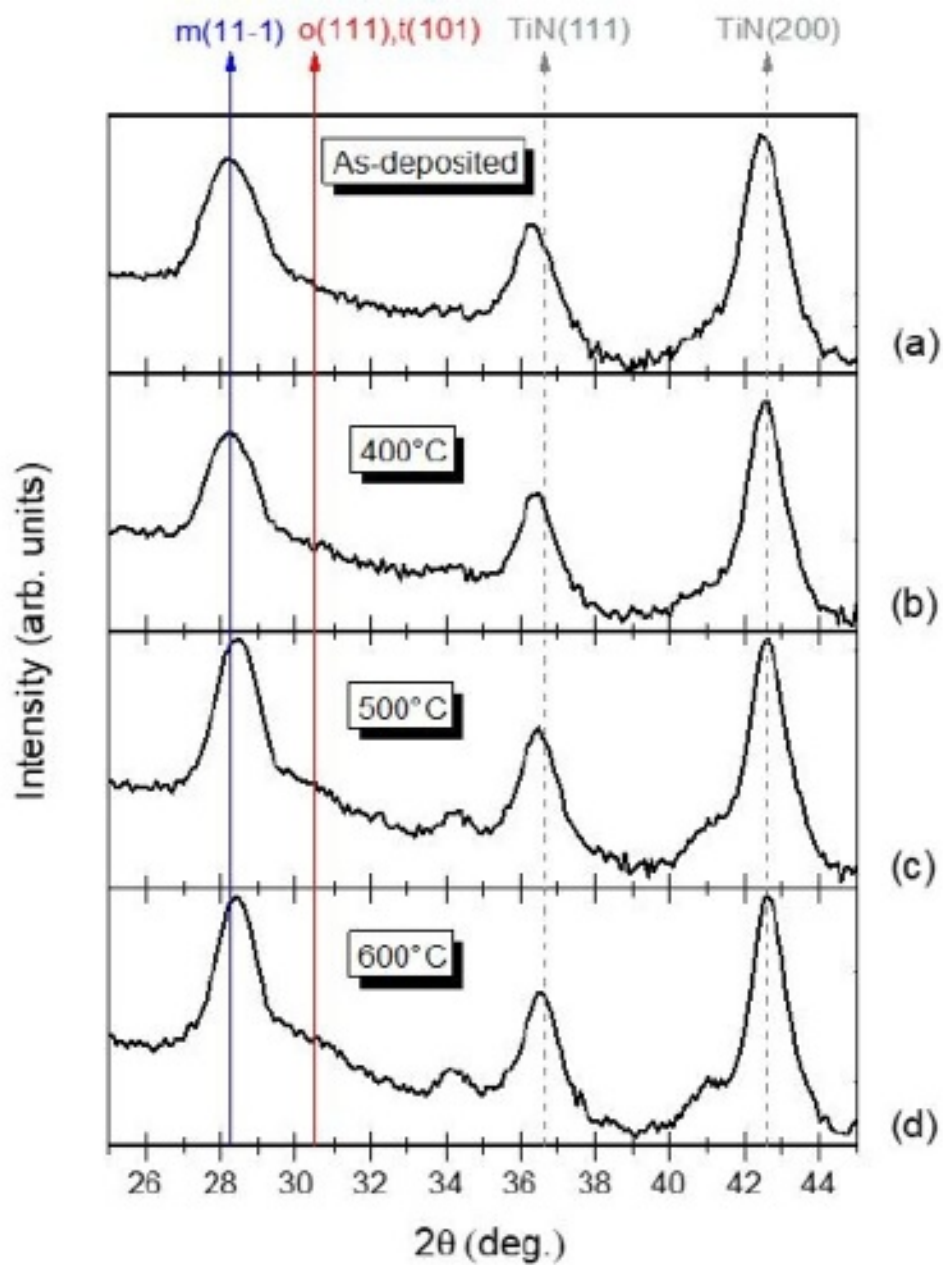

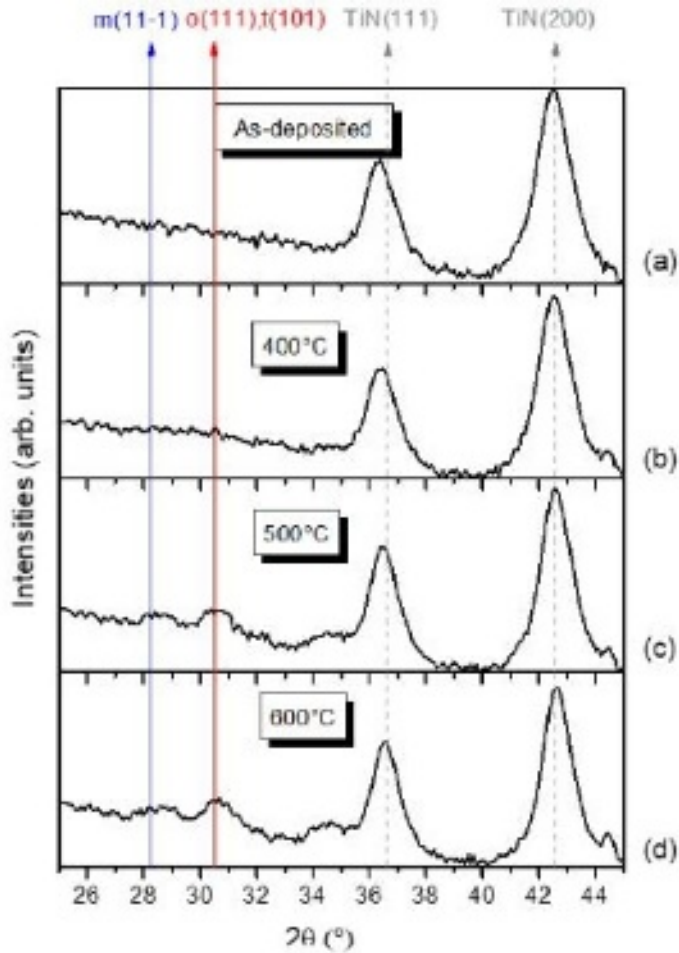

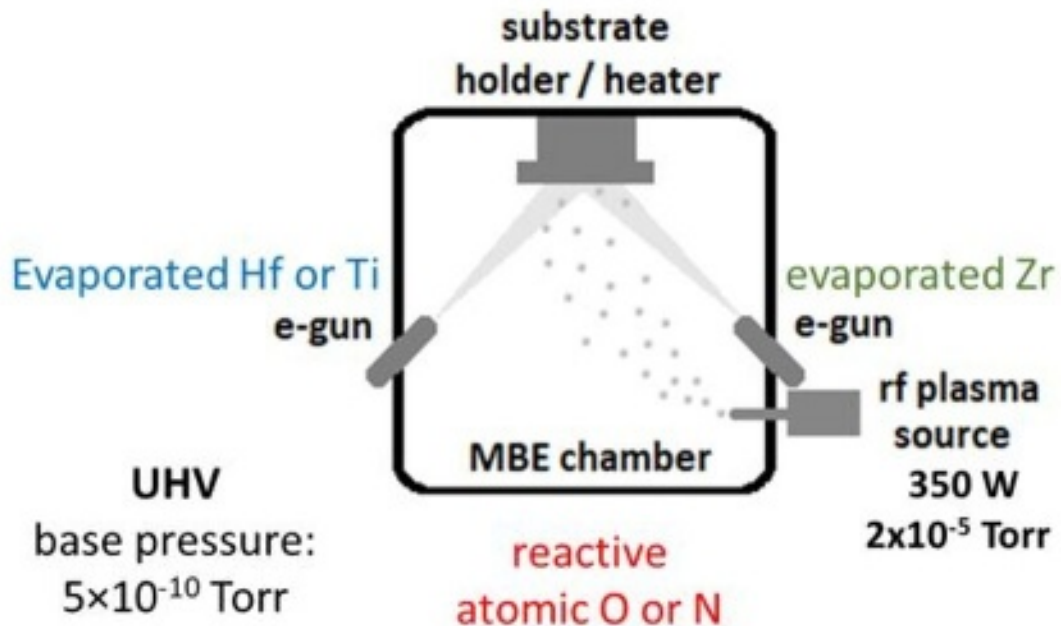

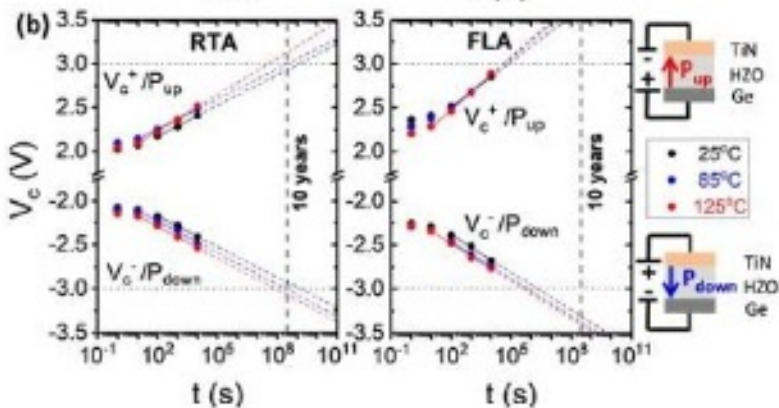
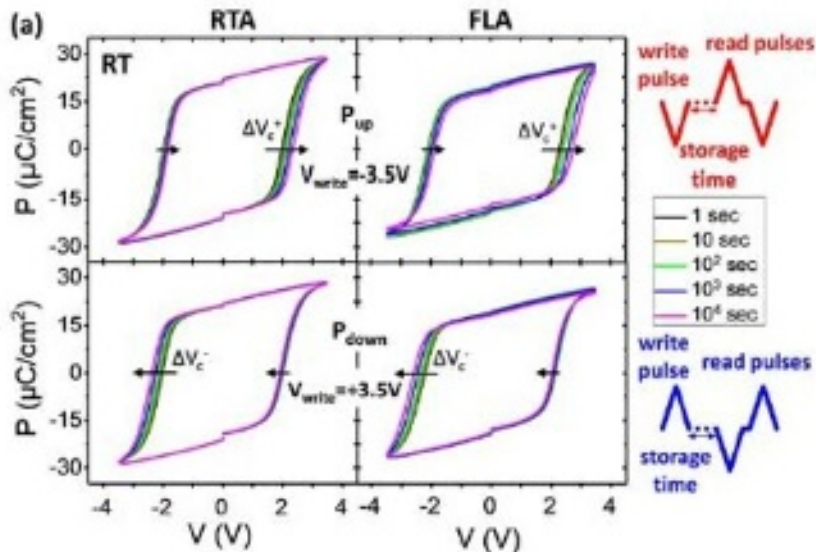

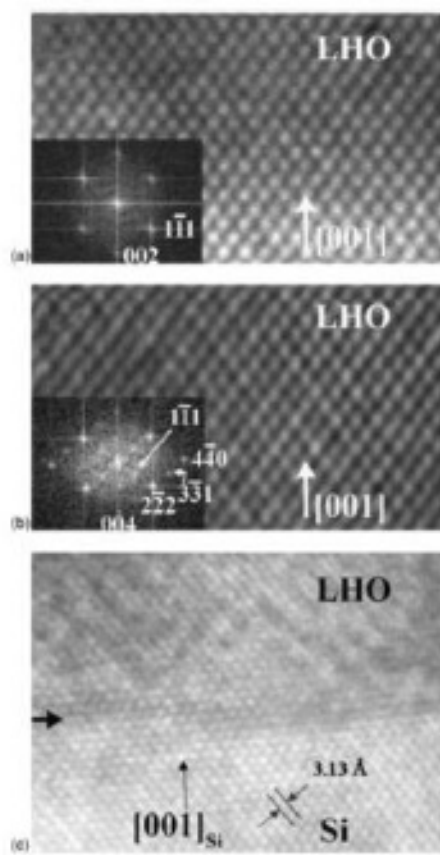
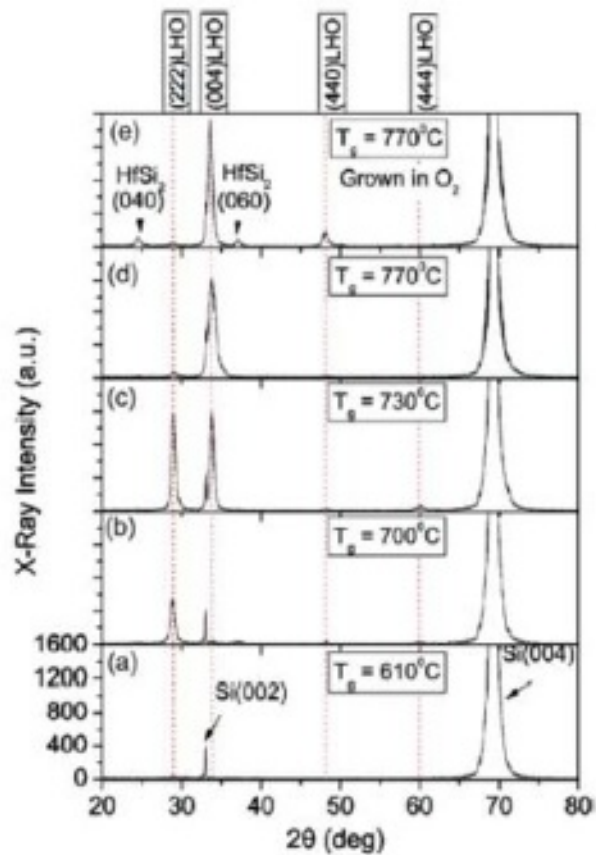

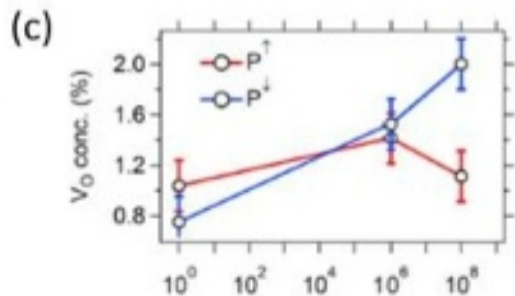
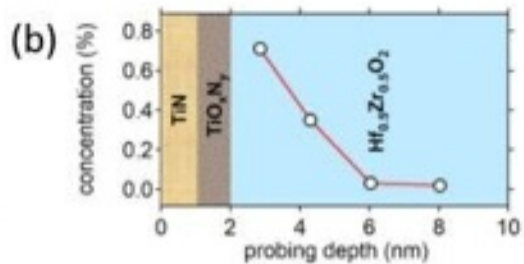
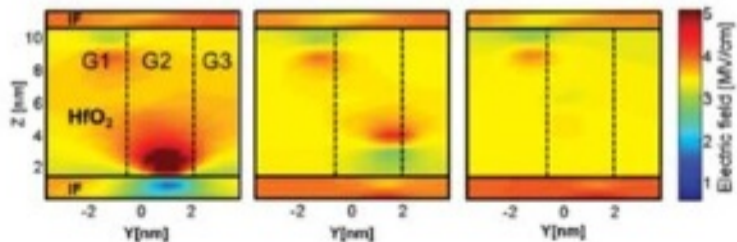
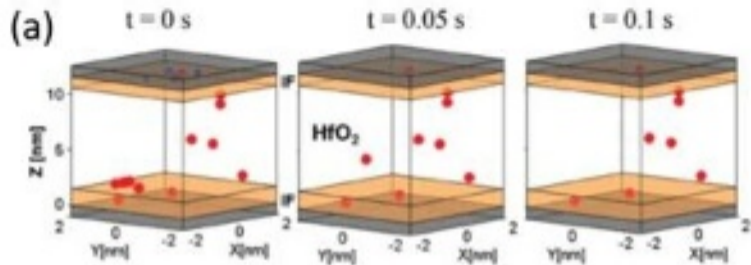

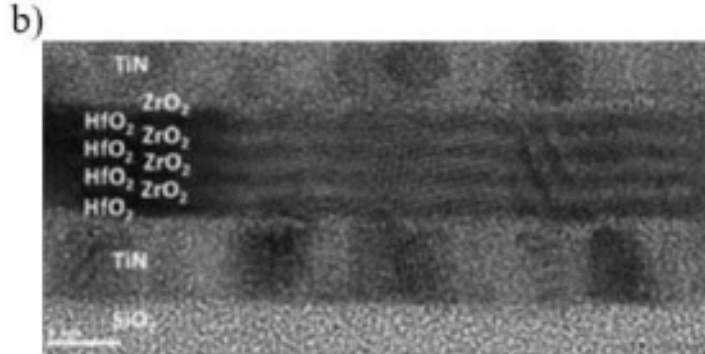
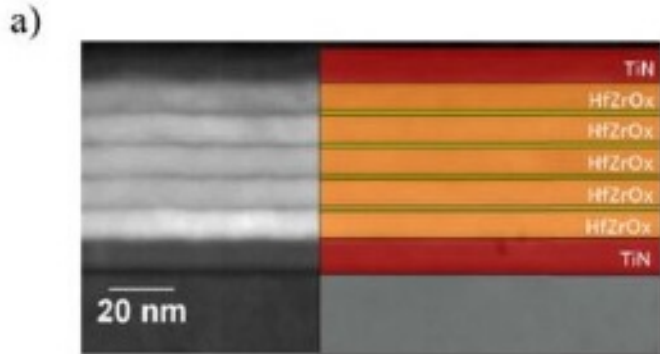

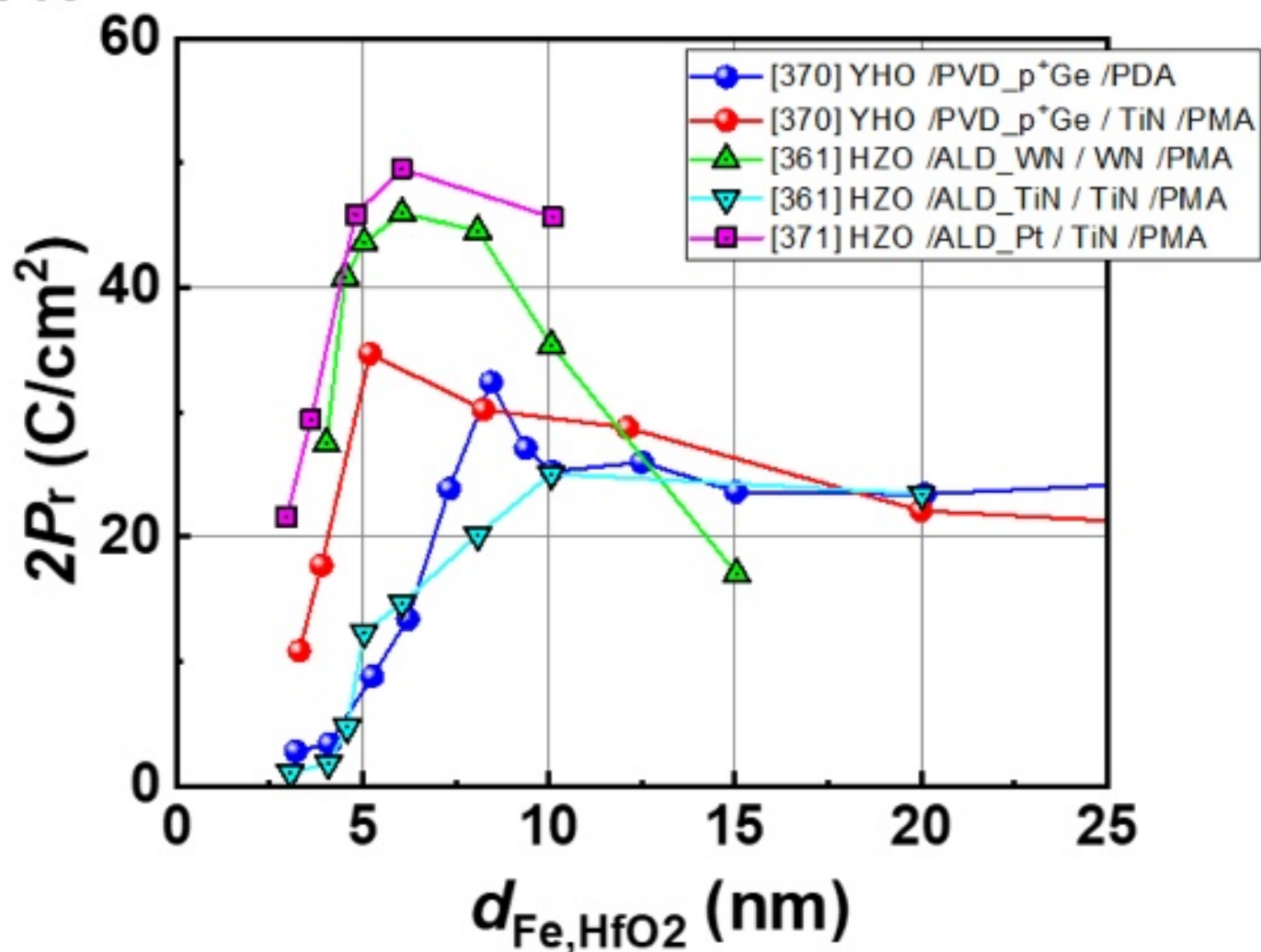
$\times 10^{-6}$ 

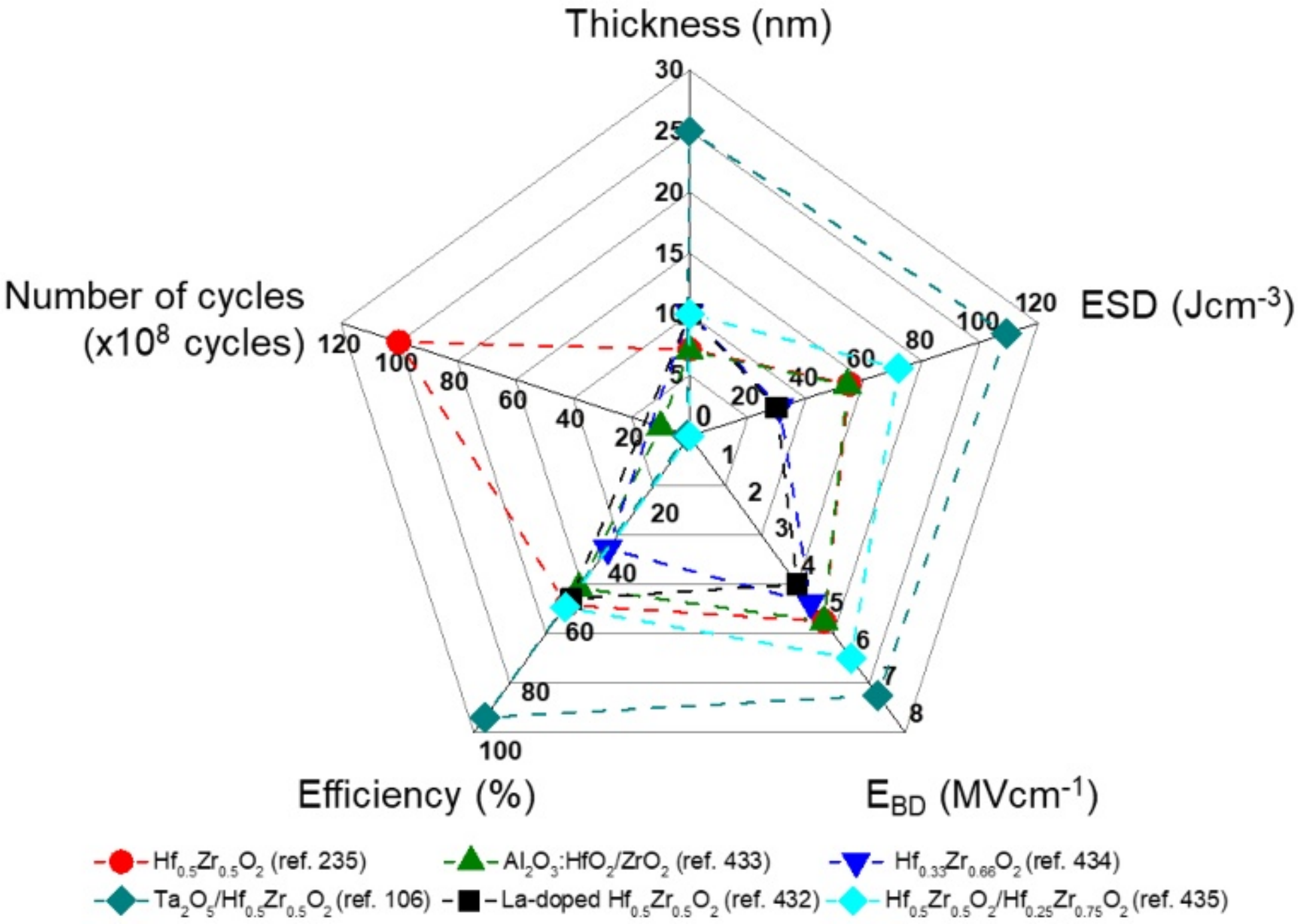

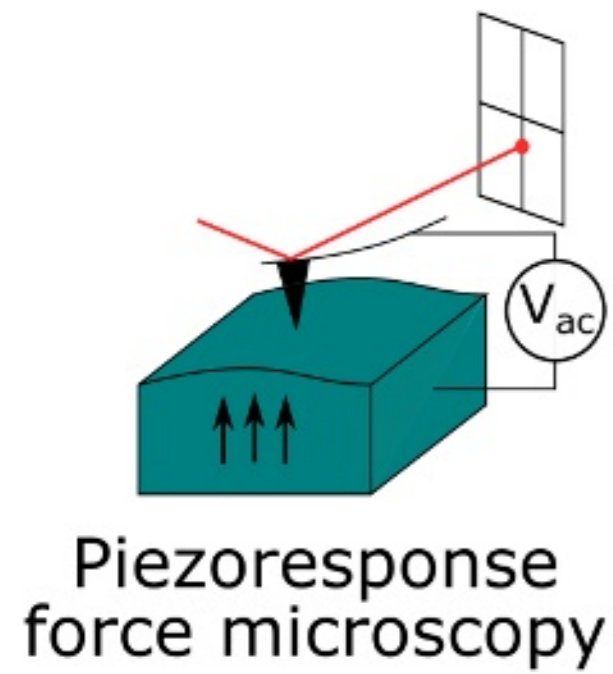
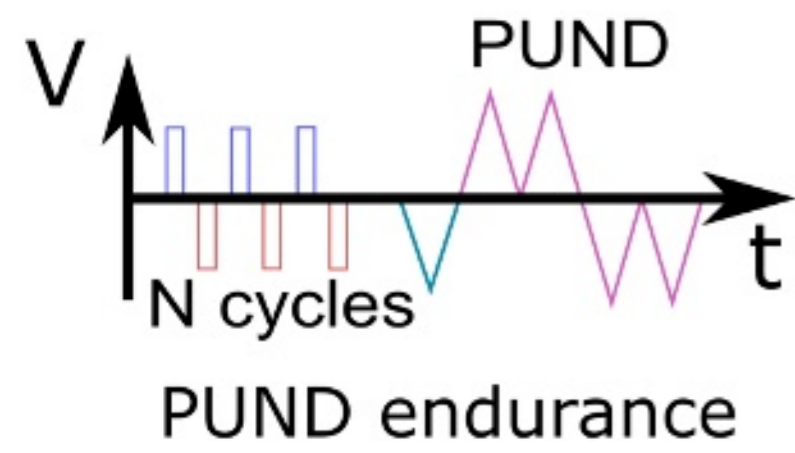

FeCAP	FTJ	FeFET
Remnant polarization (PUND/PV)	On/Off states (quasi-static/current sampling)	I_D - V_G sweeps (for different polarization states)
Leakage (quasi-static/DC-IV)	Multi-level/analog switching (polarization/resistance states)	Multi-level/analog switching (polarization/resistance states)
Endurance (different cycling parameters)	Retention (polarization/resistance states)	Retention (polarization/resistance states)
Retention (switched charge/imprint)	Endurance	Endurance
Piezoresistance force microscopy (for leaky samples)	Piezoresistance force microscopy (for leaky samples)	Capacitance-Voltage on gate capacitor

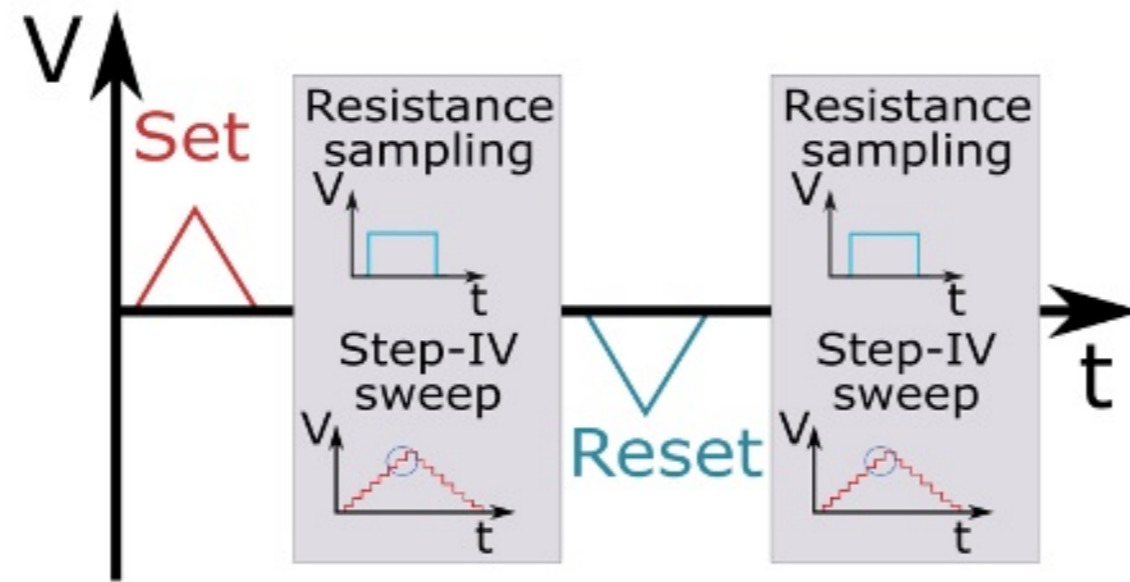
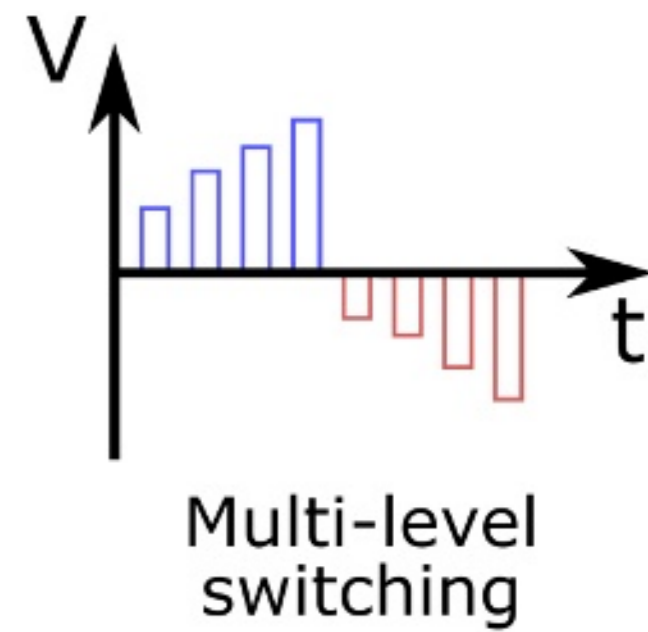

FTJ On/Off states

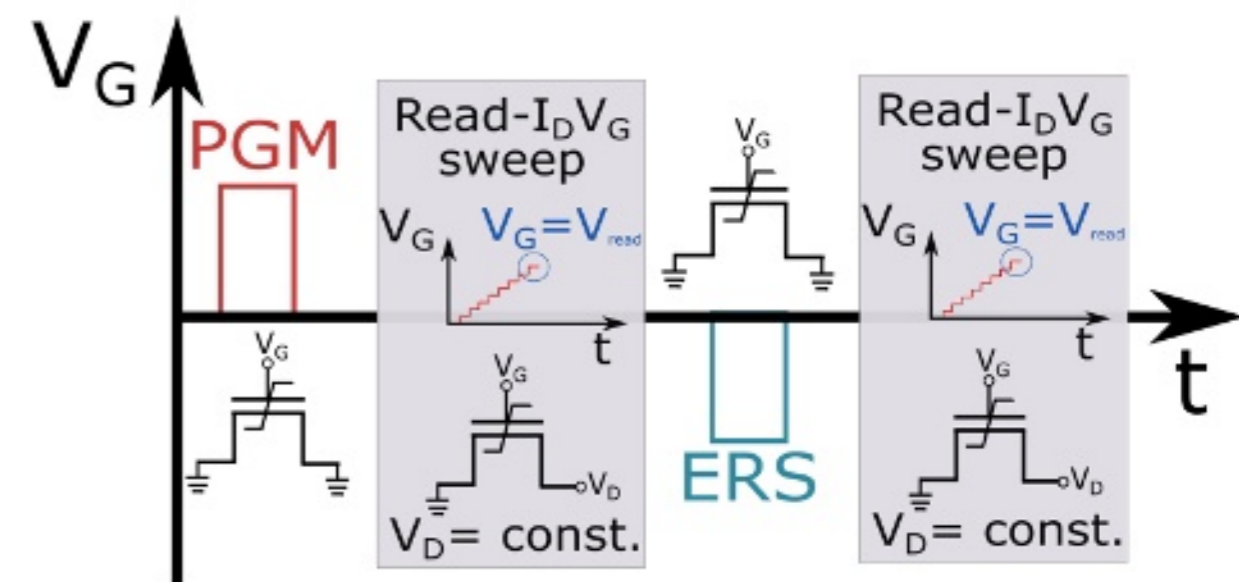

FeFET On/Off states

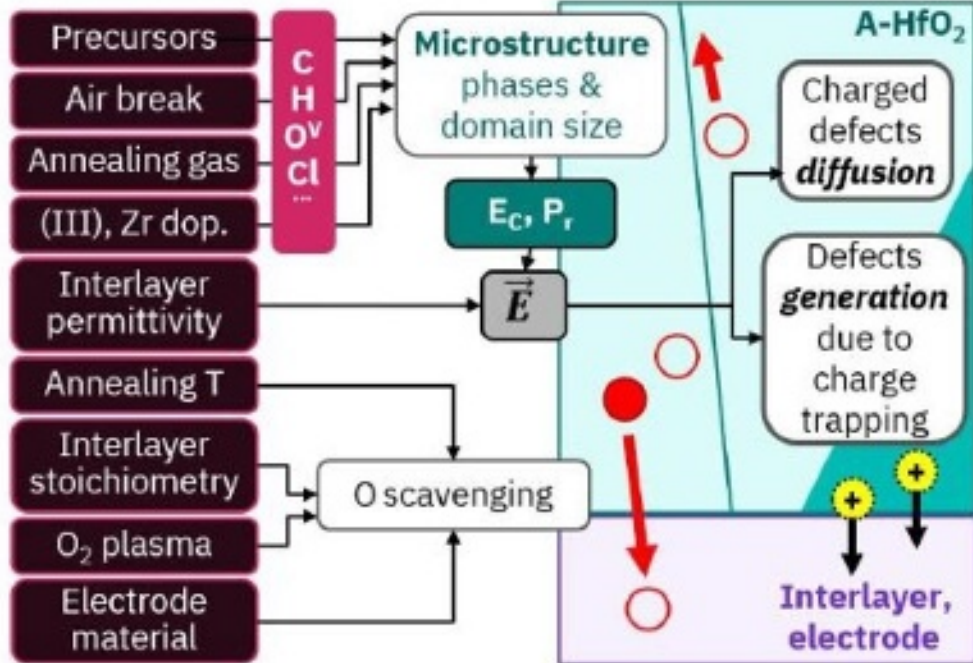

Neuromorphic Computing

In-Memory Computing

NVRAM

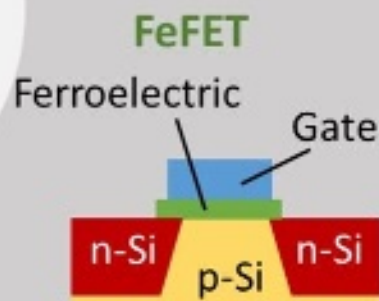
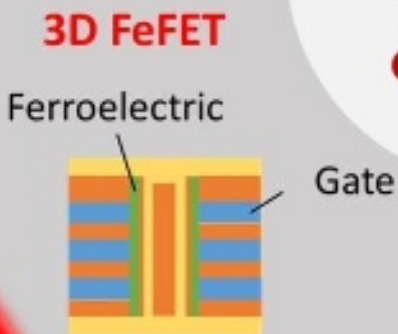
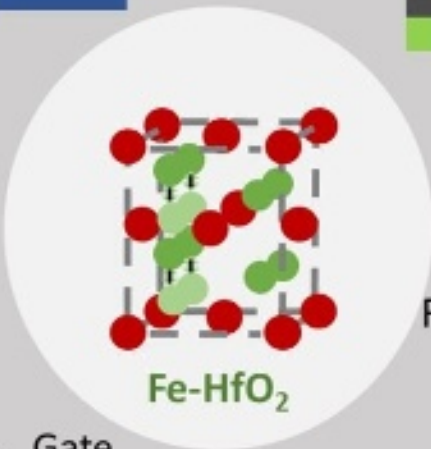
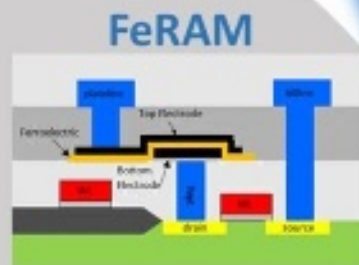
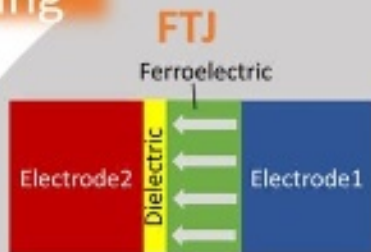

SCM

In-Memory Computing

Memory Devices

Embedded NVM

In-Memory Computing

Neuromorphic Computing