



HAL
open science

Characterization of an experimental bench for lowcarbon hydrogen production, storage, and conversion

Thomas Dapra, Eric Dalmau, Patrick Poulichet, E. Nefzaoui

► To cite this version:

Thomas Dapra, Eric Dalmau, Patrick Poulichet, E. Nefzaoui. Characterization of an experimental bench for lowcarbon hydrogen production, storage, and conversion. International Conference on Electrical, Computer, Communications and Mechatronics Engineering (ICECCME 2023), Jul 2023, Tenerife, Spain. hal-04190360

HAL Id: hal-04190360

<https://hal.science/hal-04190360>

Submitted on 29 Aug 2023

HAL is a multi-disciplinary open access archive for the deposit and dissemination of scientific research documents, whether they are published or not. The documents may come from teaching and research institutions in France or abroad, or from public or private research centers.

L'archive ouverte pluridisciplinaire **HAL**, est destinée au dépôt et à la diffusion de documents scientifiques de niveau recherche, publiés ou non, émanant des établissements d'enseignement et de recherche français ou étrangers, des laboratoires publics ou privés.

Characterization of an experimental bench for low-carbon hydrogen production, storage, and conversion

Thomas DAPRA
Univ Gustave Eiffel, CNRS,
ESYCOM, F-77454 Marne la
Vallee, France
thomas.dapra@edu.esiee.fr

Eric DALMAU
AKKODIS, Albero - Les
Quadrants, 3 Av. du Centre
78280 Guyancourt, France
eric.dalmau@akka.eu

Patrick POULICHET
Univ Gustave Eiffel, CNRS,
ESYCOM, F-77454 Marne la
Vallee, France
patrick.poulichet@univ-eiffel.fr

Elyes NEFZAOU
Univ Gustave Eiffel, CNRS,
ESYCOM, F-77454 Marne la
Vallee, France
elyes.nefzaoui@univ-eiffel.fr

Abstract— We present in this article simulations and experiments on the production, storage, and conversion into electricity of low-carbon hydrogen using solar panels, a Proton Exchange Membrane (PEM) hydrogen generator, and a PEM Fuel Cell (FC). The experimental configuration also includes backup electric storage (battery and supercapacitors) and is controlled and monitored using a homemade LabVIEW program. The present paper focuses on the static and dynamic characterization of the fuel cell. We present the I-V and power curves obtained numerically, using a MATLAB Simulink model, and experimentally and compare them to the ones provided in the FC specifications. We also compute, based on the experimental data, the efficiency of the FC when responding to a specific dynamic load and evaluate the effect of the ancillaries' energy consumption on the device performances. We obtain a maximum measured efficiency of the FC of 60 percent.

Keywords— *Low Carbon Hydrogen, Fuel Cell, Hydrogen Generator, Experiment, Simulation*

I. INTRODUCTION

The widespread use of carbon-based fossil fuels over the last two centuries has resulted in significant carbon emissions, making it one of the most important challenges in human history. The energy sector is both the cause and a substantial part of the solution to decarbonizing the economy. Hydrogen is considered today a primary tool to address this challenge [1] if produced from low-carbon sources. Indeed, “green” Hydrogen is a clean and renewable energy source that has zero carbon emissions when used in fuel cells to generate electricity. Hydrogen can be produced from renewable sources such as wind and solar energy, making it a critical component of a low-carbon energy system. It can also be used as an energy storage medium, allowing excess energy from intermittent renewable sources like wind and solar to be stored and used when needed. This helps to balance the grid and ensure a stable supply of energy. In addition, Hydrogen is a versatile energy vector. It can be used in various applications, including transportation, heating, and electricity generation. This versatility makes it an attractive option for reducing emissions across multiple sectors. Therefore, using hydrogen as a fuel source can help decarbonize several sectors currently reliant on fossil fuels,

including buildings[2], [3], transportation[2] and industry[4]. Overall, hydrogen, when produced from sources such as wind and solar energy, has the potential to play a crucial role in the transition to a low-carbon economy and in mitigating the impacts of climate change. However, there are still challenges that need to be addressed, such as the cost of production and distribution infrastructure, before hydrogen can become a widespread and cost-effective solution, the integration of hydrogen solutions for different fields, including stationary and mobile applications as well as the training of the required technical professionals to meet the needs of the rapid growth of this technology. Due to the significant role hydrogen technologies are expected to play in tackling the energy decarbonization challenge, many works have addressed the problem of hydrogen production [5], storage [6], and conversion [7], [8] during the past decade. Nevertheless, very few works addressed the experimental evaluation of the whole value chain from renewable electricity production for hydrogen generation to hydrogen storage and conversion back to electricity. Most recent works addressed this question using modeling and simulation [9], [10], and the few experimental works addressed only a part of the whole value chain [11], [12]. In the present work, we report on an experimental bench we recently developed for producing, storing, and converting decarbonized hydrogen for stationary and mobile applications to assess experimentally the performance of the whole integrated value chain at a small scale.

The manuscript is organized as follows: Section II describes the hydrogen bench, its components, and the LabVIEW program used for the experimental setup control and monitoring. We also describe in this section the numerical model used for the fuel cell simulation and define the used and computed efficiency. We present in section III a sub-set of results on the static characteristics of the fuel cell, its response to a specific dynamic load, and its efficiency when used in such a configuration.

II. MATERIALS AND METHODS

A. The experimental setup and protocol

a) The experimental setup

The experimental bench is composed of 1.32 kWp of solar panels (made of 4 mono-crystalline panels of 330 Wp each from SYSTOVI AE solar), a Proton Exchange Membrane (PEM) hydrogen generator (HG) (HG 4U PRO 2000 - Hydrogen Generator 2000 cc/min UHP RACK 19" 4U from LNI SWISSGAS), metal hydride canisters for hydrogen storage (3 canisters MyH2 600 from H2planet), a Proton PEM Fuel Cell (PEMFC) (H-500 from Horizon Fuel Cells), a variable programmable electronic load (EA-EL 9080-45 T, 80V, 45A, 600W from Elektro-Automatik), a small battery (12 V, 5 Ah) for the fuel cell startup, backup electric storage (a Tyva Modulo lithium ion 48.1 V – 30 Ah BMS PRO 1440 VAh battery and 4 supercapacitors BMOD0058 E016 C02, 16 VDC, 58 Farads each, for a total of 232 Farads from Maxwell Technologies) to back-up the FC in case of loads exceeding the FC maximal power. Several DC-DC converters are used to adapt the voltage to the different elements. The whole system is sized for a nominal power of 500 W corresponding to the FC nominal power and a maximum power of 1 kW when the electric backup storage is used. The bench monitoring is done using a dedicated homemade LabVIEW program on the bench control and monitoring computer. We show in Fig. 1 a schematic of the considered bench.

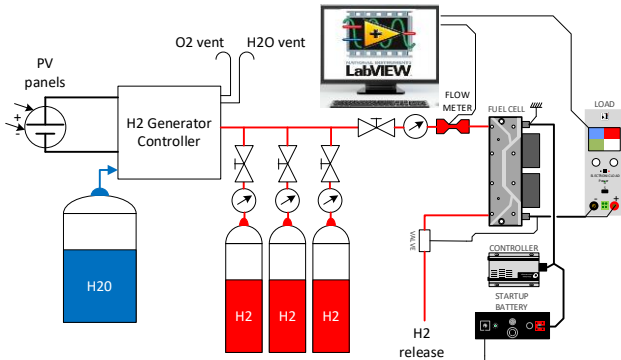

Fig. 1 Schematic of the experimental bench developed for decarbonized hydrogen production, storage, and conversion.

We can distinguish three subsystems: one for renewable electricity production (PV panels in our case), one for backup electric storage (Battery and supercapacitors), and the main subsystem inside the dashed box for hydrogen production, storage, and conversion to provide a requested load. Only the latter is detailed in this schematic and described in the present paper. We also show in Fig. 2 a photograph of the actual system where we can see more details and the instrumentation used for the main parameters measurement.

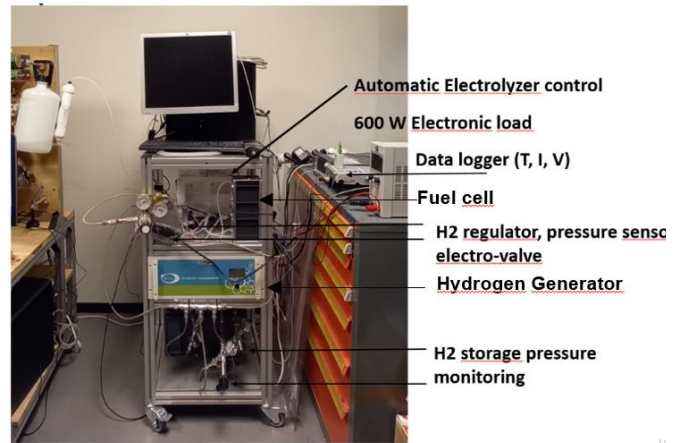

Fig. 1: Photography of the hydrogen subsystem.

The PV panels are connected to the grid using an inverter. The HG is connected to the same grid and is automatically activated by the generator controller when the hydrogen pressure inside the storage canisters is lower than a threshold set by the operator. In our case, this limit is set to 15 bars. The maximum hydrogen flow rate the HG provides is 2000 cc/min. The pressure upper limit in the storage canisters is 16 bars. We use three canisters of 600 NI (Normal liter) each for a total of 1800 NI. The fuel cell consumption at its nominal power of 500 W is 6.5 NI /mn enabling more than 4.5 hours of operation at nominal power with the fully charged storage.

The FC voltage is 22 V for no load and 14.4 V for a 35 A current. It is operated with a DC-DC converter and an external power supply (a battery, for instance) to ensure the FC starting and the ancillaries (fans, DC-DC converter) power supply.

b) Instrumentation, control, and monitoring

The LabVIEW software is used to communicate with the different components of the hydrogen bench and to display in real-time the hydrogen consumption, the power supplied by the FC, the electric load, and the ancillaries' consumption. This enables determining the efficiency of the fuel cell. We show in Fig. 2 a picture of the used software interface with including the communication with the hydrogen mass flow meter (top left); the real time hydrogen consumption (top right), the ancillaries consumption (bottom left) and the power delivered to the load (bottom right).

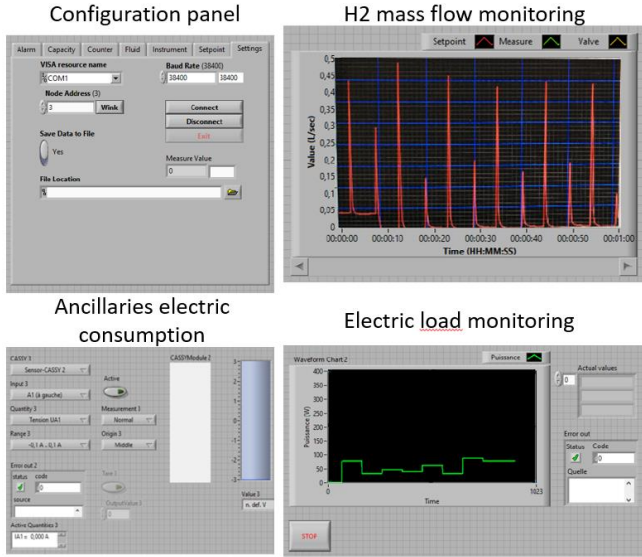

Fig. 2: Interface of the developed LabVIEW program for the bench control and monitoring.

To test the fuel cell with different load profiles is performed by setting a load profile on the electronic load using the LabVIEW Virtual Instrument (VI). The voltages, current, power, and hydrogen quantity are then measured, recorded, and displayed on the LabVIEW software. The hydrogen mass flow rate is measured with a dedicated flowmeter (Bronkhorst F-111B). The efficiency of the FC is obtained by calculating the ratio of the power supplied by the cell and the power corresponding to the hydrogen flow rate.

B. Numerical model

We show in Fig. 3 a model of the FC developed using MATLAB Simulink.

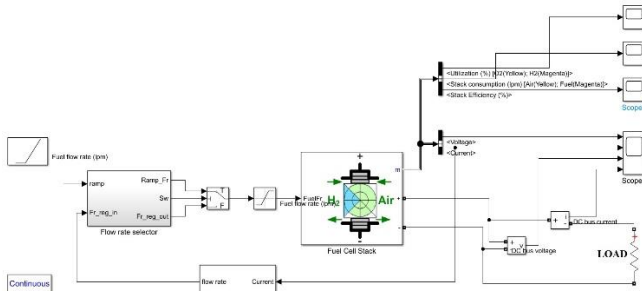

Fig. 3 Model of the Fuel Cell simulated with MATLAB Simulink.

This model contains a central block modeling the fuel cell. We have defined the electrical characteristics of the fuel cell so that they correspond to the measured ones. The "Flow rate selector" block enables setting the hydrogen flow rate to be used by the FC. A looping system enables the system to adapt the flow rate delivered according to the output current of the cell. This functionality is realized in the "Flow rate regulator" block. Finally, "Scope" blocks are placed at the output of the stack and for the different stack parameters monitoring during its operation. Simulation results are presented in section III.

C. Performance evaluation

We evaluate the performance of the FC by calculating its efficiency. The efficiency is defined as the ratio of the output power by the input power provided by the fuel, hydrogen in our case, flow rate and is given by Eq. 1:

$$\eta_0 = \frac{P}{\dot{m}e_{H_2}} = \frac{I \times V}{\dot{V}\rho_{H_2}e_{H_2}} \quad (1)$$

where P, I and V are the FC output power, current and voltage, respectively, and \dot{m} , e_{H_2} , \dot{V} and ρ_{H_2} are the hydrogen mass flow rate, energy density, volume flow rate and density, respectively. The use of Eq. 1 over-estimates the FC efficiency since it does not account for the ancillaries consumption. Indeed, the ancillaries (Fans, DC-DC converter, etc.) are power supplied by a battery which is charged by the FC which reduces the available net power.

A more accurate expression of the efficiency accounting for the ancillaries consumption can be given by:

$$\eta_1 = \frac{P_{FC} - P_{anc}}{\dot{m}e_{H_2}} = \frac{I_{FC} \times V_{FC} - I_{anc}V_{anc}}{\dot{V}\rho_{H_2}e_{H_2}} \quad (2)$$

where P_{anc} , I_{anc} and V_{anc} are the power, current and voltage consumed by the respectively.

III. RESULTS AND DISCUSSION

In this section, we present numerical and experimental results of the characterization of the fuel cell (FC). First, we obtain using the numerical model the I-V and power curves of the FC and compare them to the experimentally measured one and the one provided by the FC manufacturer. Then, we test the FC under different operating conditions to assess its ability to fulfill different electric loads. We consider in particular a simple load obtained with the concatenation of Heaviside functions with a 30-second duration and increasing the load by 50 W after every time-step of 30 s.

A. The fuel-cell I-V curves

First, we perform a static characterization of the FC to obtain its I-V and power curves. Those characteristics are already provided by the FC manufacturer in the datasheet. The I-V curve is obtained experimentally and by simulation using the MATLAB-Simulink model presented in section II-B. Experimentally, the electronic load is used to vary the load current from 1 to 40 A which covers the entire range of operation of the FC. According to the FC specifications, the generated current is of 35 A at a voltage of 14.4 V which corresponds to a power of 504 W, very close to the FC nominal power. The FC operation limits are 12 V (lower limit), 42 A (upper limit), and 65 °C (upper limit) for voltage, current, and temperature respectively.

We show in Fig. 5-a the I-V curves and in Fig. 5-b the power curves obtained by simulation, experiment, and from the FC specifications. We observe similar behaviors illustrated by three different regions of the IV curve: first, an activation region for low current exhibiting a significant voltage drop for a small increase of the output current. Second, an ohmic region in a wide current range up to 35 A where the voltage exhibits a linear dependence to the current with a small negative coefficient. Third, a mass transport region where, again, the voltage drops

significantly for a small increase in output current, for very large currents, between 35 A and the upper current limit of 42 A. In our case, the experimental I-V and power curves are always below the theoretical ones obtained from the FC specifications. This is probably due to partial dehydration of the cells due to long periods of time of un-use. Indeed, our FC is not used continuously and experiences repetitive periods of un-use when the institution is closed. This assumption can be confirmed after rehydration of the cell either by direct water injection in the hydrogen inlet or indirectly by a water spray behind the cooling air blowers. A vertical shift of the I-V and power curves would confirm this assumption.

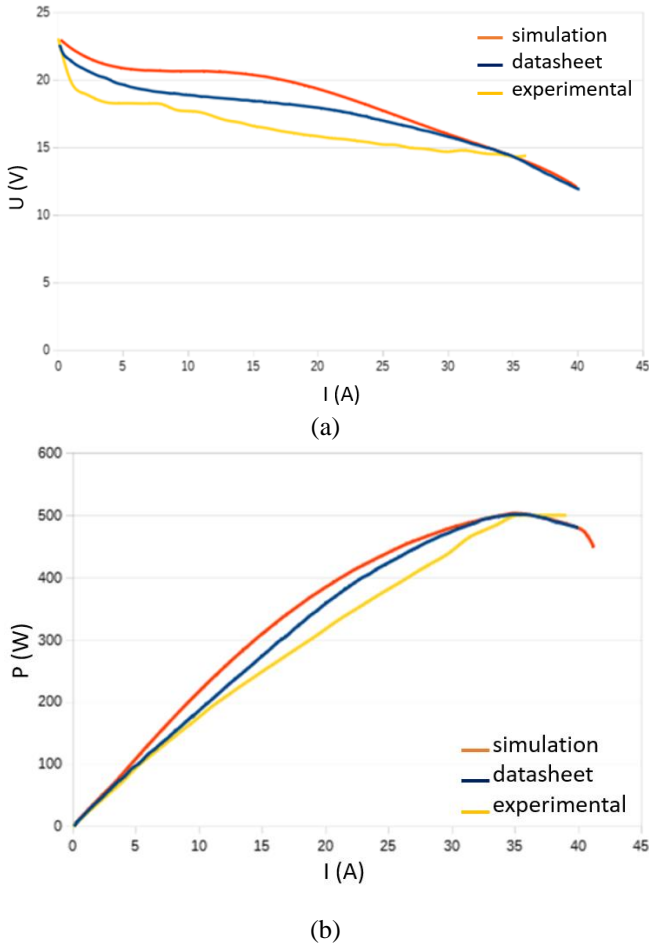

Fig. 4 : (a) I-V and (b) Power curves of the FC.

B. The fuel-cell efficiency

We show in Fig. 6 the used load profile at the FC, which corresponds to the generated power, and the hydrogen consumed by the FC versus time. We observe that these two quantities follow similar trends which is obviously expected since an increase of the output power leads to an increase of the fuel flow rate.

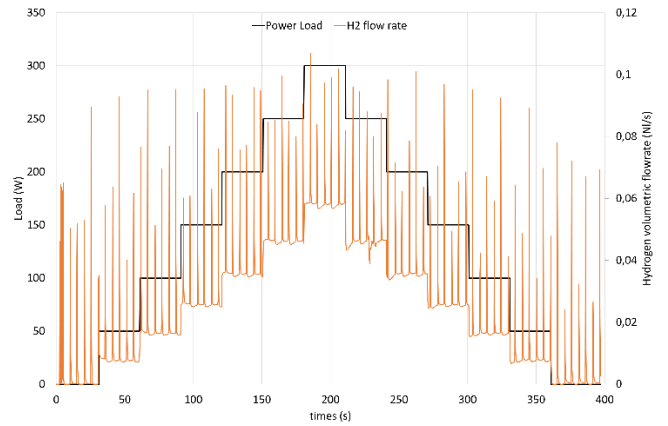

Fig. 5 : The load profile of the electronic load and the consumed hydrogen flowrate versus time.

This information is already available in the FC specifications where the manufacturer provides a curve of the fuel flow rate versus the output power as an increasing curve from 0 l/s at 0 W up to 6.5 l/s at 500 W. The results are shown on Figure 6. We observe not only this increase of the average consumed hydrogen flow rate but also the transient variation of the consumed hydrogen flow rate at constant power levels that exhibits regular peaks corresponding to a periodic short circuit of the FC as programmed in the manufacturer provided controller.

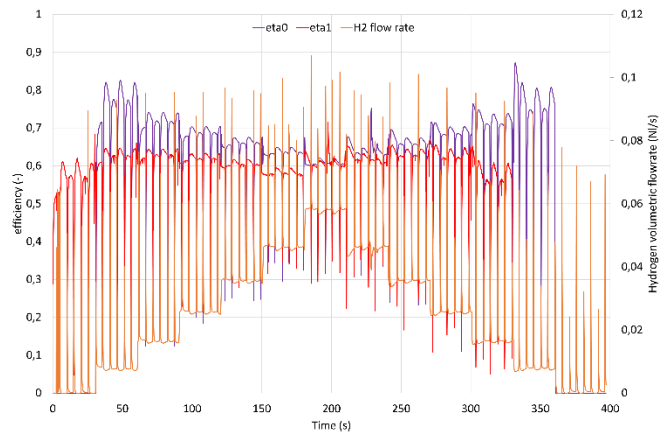

Fig. 6 : Efficiency of the FC and the consumed hydrogen flowrate vs time with (red) and without (purple) accounting for the ancillaries' consumption.

Finally, we plot in Fig. 7 the efficiency of the FC calculated according to Eq. 1 and Eq. 2 respectively. We observe the same transient behavior as for Hydrogen flowrate consumption and a decrease, as expected, of the efficiency when we account for the ancillaries' consumption. In average, the efficiency decreases from 65% to 55% when we account for this phenomenon. A more accurate estimation of the efficiency can be obtained by accounting for the purge hydrogen flow rate not consumed and ejected by the FC.

CONCLUSION

We have developed an experimental setup for the production, storage and conversion of green hydrogen using a PEM fuel cell

(FC). The bench is instrumented and monitored to characterize the performances and the efficiency of the energy conversion process. We show results of static characterization of the FC in the form of I-V and power curves that are in good agreement with the theoretical data. We also report on a dynamic characterization of the FC through efficiency calculations under a specific load profile and obtain efficiency values between 55% and 65% depending on the efficiency definition used. Efficiency calculations can be further improved by account for other phenomena observed on the bench. The efficiency also depends on the shape and magnitude of the load profile. Additional characterization in other situations can provide more insights on the system dynamics. In addition, the characterization of the whole system including renewable electricity production and the backup storage is still to be done.

REFERENCES

- [1] N. A. Pambudi, K. Itaoka, A. Kurosawa, et N. Yamakawa, « Impact of Hydrogen fuel for CO₂ Emission Reduction in Power Generation Sector in Japan », *Energy Procedia*, vol. 105, p. 3075-3082, mai 2017, doi: 10.1016/j.egypro.2017.03.642.
- [2] K. Alanne et S. Cao, « Zero-energy hydrogen economy (ZEH2E) for buildings and communities including personal mobility », *Renew. Sustain. Energy Rev.*, vol. 71, p. 697-711, mai 2017, doi: 10.1016/j.rser.2016.12.098.
- [3] V. M. Maestre, A. Ortiz, et I. Ortiz, « The role of hydrogen-based power systems in the energy transition of the residential sector », *J. Chem. Technol. Biotechnol.*, vol. 97, n° 3, p. 561-574, 2022, doi: 10.1002/jctb.6938.
- [4] D. Parra, L. Valverde, F. J. Pino, et M. K. Patel, « A review on the role, cost and value of hydrogen energy systems for deep decarbonisation », *Renew. Sustain. Energy Rev.*, vol. 101, p. 279-294, mars 2019, doi: 10.1016/j.rser.2018.11.010.
- [5] S. Shiva Kumar et V. Himabindu, « Hydrogen production by PEM water electrolysis – A review », *Mater. Sci. Energy Technol.*, vol. 2, n° 3, p. 442-454, déc. 2019, doi: 10.1016/j.mset.2019.03.002.
- [6] E. Rivard, M. Trudeau, et K. Zaghbi, « Hydrogen Storage for Mobility: A Review », *Materials*, vol. 12, n° 12, Art. n° 12, janv. 2019, doi: 10.3390/ma12121973.
- [7] W. R. W. Daud, R. E. Rosli, E. H. Majlan, S. A. A. Hamid, R. Mohamed, et T. Husaini, « PEM fuel cell system control: A review », *Renew. Energy*, vol. 113, p. 620-638, déc. 2017, doi: 10.1016/j.renene.2017.06.027.
- [8] Y. Wang, D. F. Ruiz Diaz, K. S. Chen, Z. Wang, et X. C. Adroher, « Materials, technological status, and fundamentals of PEM fuel cells – A review », *Mater. Today*, vol. 32, p. 178-203, janv. 2020, doi: 10.1016/j.mattod.2019.06.005.
- [9] R. Aruna, S. T. Jaya Christa, et P. P. Jeyapaul, « Modeling, analysis and design of Solar PV based hydrogen energy storage system for residential applications », *International Journal of Advanced Technology and Engineering Exploration*, vol. 9, n° 91, p. 788-806, 2022.
- [10] A. Brka, G. Kothapalli, et Y. M. Al-Abdeli, « Predictive power management strategies for stand-alone hydrogen systems: Lab-scale validation », *International Journal of Hydrogen Energy*, vol. 40, n° 32, p. 9907-9916, 2015.
- [11] D. Parra, M. Gillott, et G. S. Walker, « Design, testing and evaluation of a community hydrogen storage system for end user applications », *International Journal of Hydrogen Energy*, vol. 41, n° 10, p. 5215-5229, 2016.
- [12] A. Fopah-Lele, A. Kabore-Kere, J. G. Tamba, et I. Yaya-Nadjo, « Solar electricity storage through green hydrogen production: A case study », *International Journal of Energy Research*, vol. 45, n° 9, p. 13007-13021, 2021.