



**HAL**  
open science

## On the role of binder in all-solid state battery using sulphide based electrolytes

Lucas Trassart, Fannie Alloin, Ove Korjus, Lauréline Marchal, François Fauth, Claire Villevieille

### ► To cite this version:

Lucas Trassart, Fannie Alloin, Ove Korjus, Lauréline Marchal, François Fauth, et al.. On the role of binder in all-solid state battery using sulphide based electrolytes. International Bunsen discussion Meeting "Solid-state Batteries V", Nov 2022, Francfort, Germany. . hal-04189928

**HAL Id: hal-04189928**

**<https://hal.science/hal-04189928>**

Submitted on 29 Aug 2023

**HAL** is a multi-disciplinary open access archive for the deposit and dissemination of scientific research documents, whether they are published or not. The documents may come from teaching and research institutions in France or abroad, or from public or private research centers.

L'archive ouverte pluridisciplinaire **HAL**, est destinée au dépôt et à la diffusion de documents scientifiques de niveau recherche, publiés ou non, émanant des établissements d'enseignement et de recherche français ou étrangers, des laboratoires publics ou privés.

# On the role of binder in all-solid state battery using sulphide based electrolytes

L. Trassart<sup>1,2</sup>, F. Alloin<sup>1</sup>, O. Korjus<sup>3</sup>, L. Marchal<sup>2</sup>, F. Fauth<sup>4</sup>, C. Villeveuille<sup>1</sup>

<sup>1</sup> Univ. Grenoble Alpes, Univ. Savoie Mont Blanc, CNRS, Grenoble INP, LEPMI, 38000 Grenoble, France  
<sup>2</sup> Arkema – Centre de Recherche Rhône-Alpes, Rue Henri Moissan – CS 42063, 69 491 Pierre Benite Cedex, France  
<sup>3</sup> University Grenoble Alpes, CNRS, CEA, IRIG-SyMMES, 38000 Grenoble, France  
<sup>4</sup> CELLS–ALBA Synchrotron, Cerdanyola del Valles, Barcelona, E-08290, Spain  
[lucas.trassart@arkema.com](mailto:lucas.trassart@arkema.com)

## Introduction

Sulphide solid electrolytes

- Very good ionic conductivity
- Easy processing (cold sintering)
- Poor electrochemical stability windows (**chemical decomposition**)
- Poor mechanical properties during cycling (**mechanical decomposition**)



Can the binder help improving the mechanical stability of the solid electrolytes ?

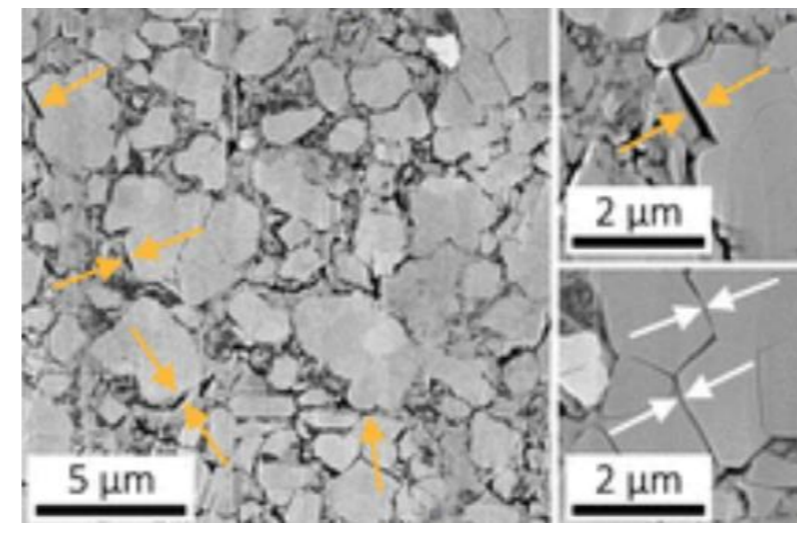

Doerr C, et al. ACS Appl Mater Interfaces. 2021;13(31):37809

## Strategy

Checking the impact of the binder on:

- The ionic conductivity
  - Impedance measurement
- The electrochemical stability window
  - Cyclic voltammetry
- The mechanical/chemical stability
  - X-ray tomography
  - Synchrotron XRD

## Experimental setup

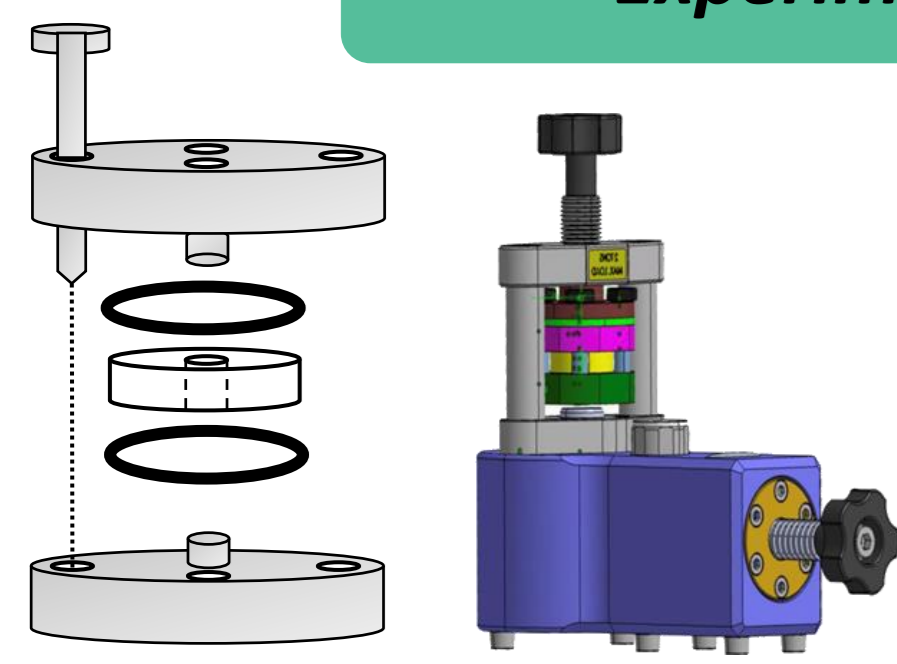

Electrochemical cell closed under pressure in Ar-filled glovebox  
 Pressure up to 250MPa

## Chemicals

**Solid electrolyte**

Commercial LPSCI NEI

**Binder**

Polymer

**Protocol**

Mixing LPSCI with X wt% of binder  
 Dry route  
 Hand mixing

**Ionic conductivity cell**

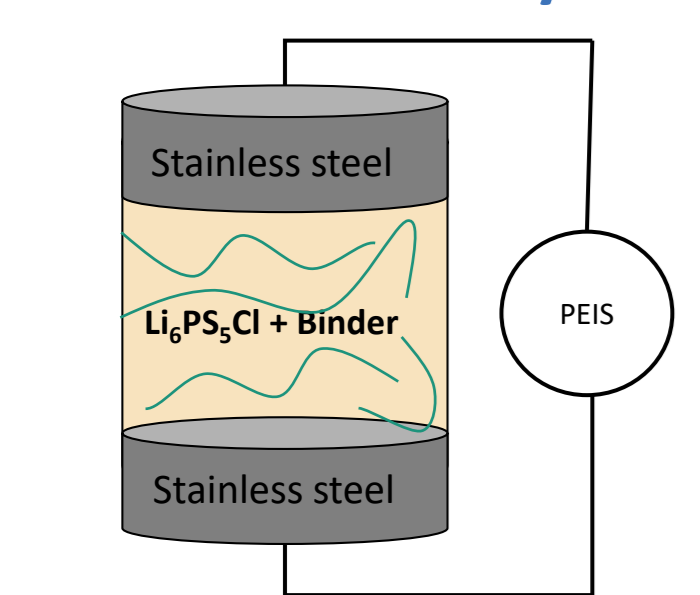

**Cyclic voltammetry cell**

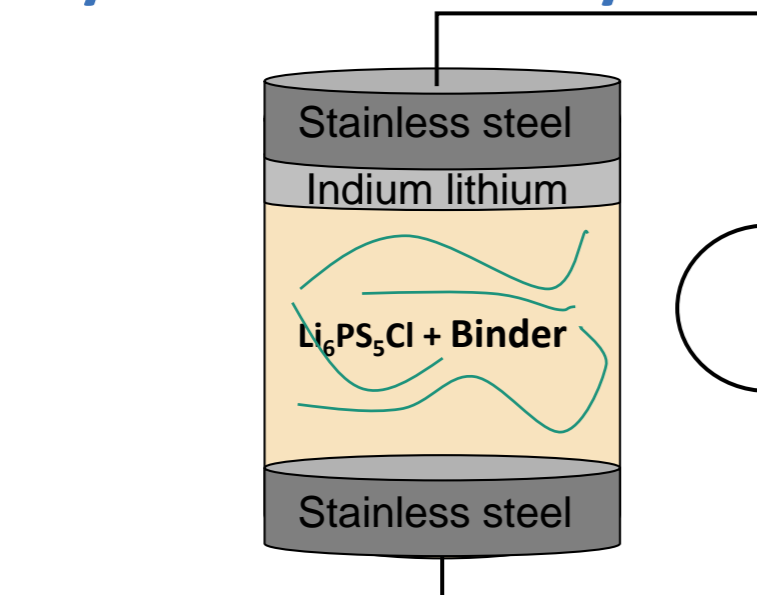

## Ionic conductivity

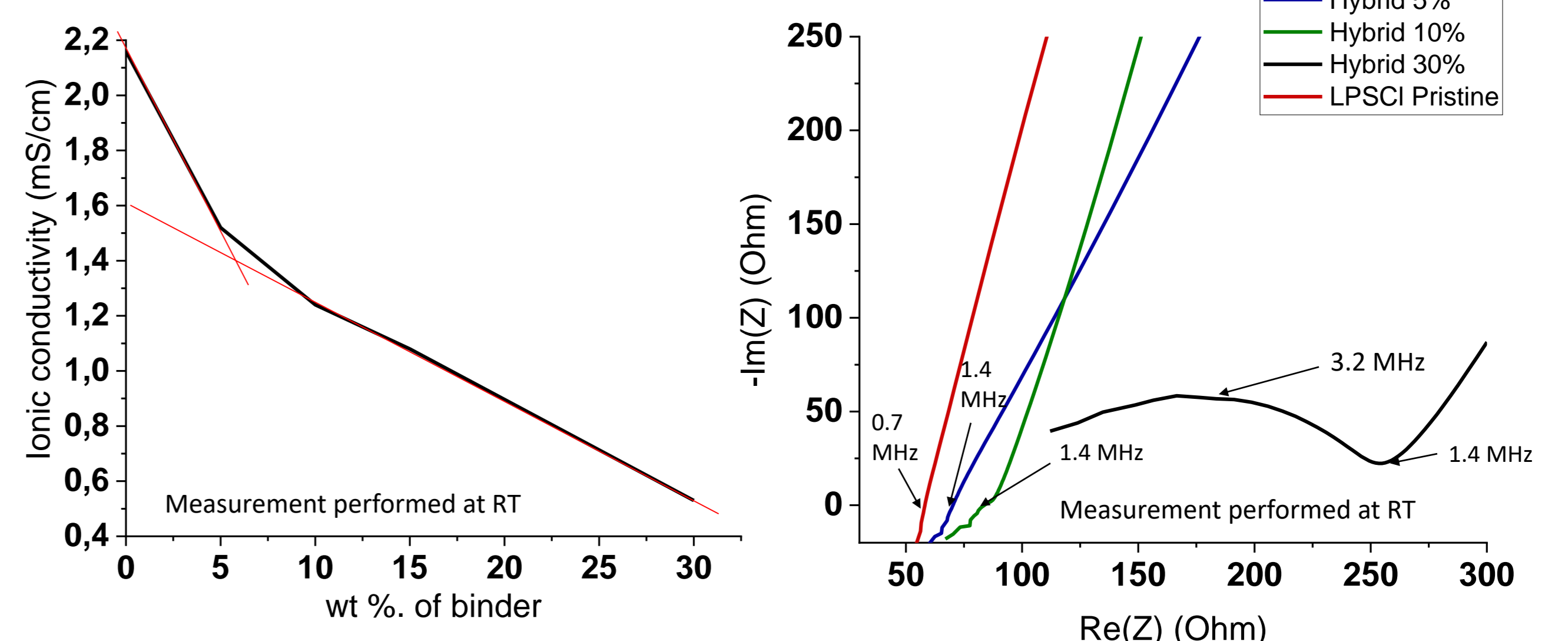

At low wt%, binder has a low impact of the ionic conductivity 😊  
 Ideal ratio content between 5-10 wt%.

## Structural evolution

### At RT

**LPSCI**

Well indexed as compared to the literature

**Hybrid**

Amorphous background coming from the binder

Little changes at 15 wt% (nothing at 10%)  
 Additional contribution at 30 wt% showing **chemical reaction** at RT

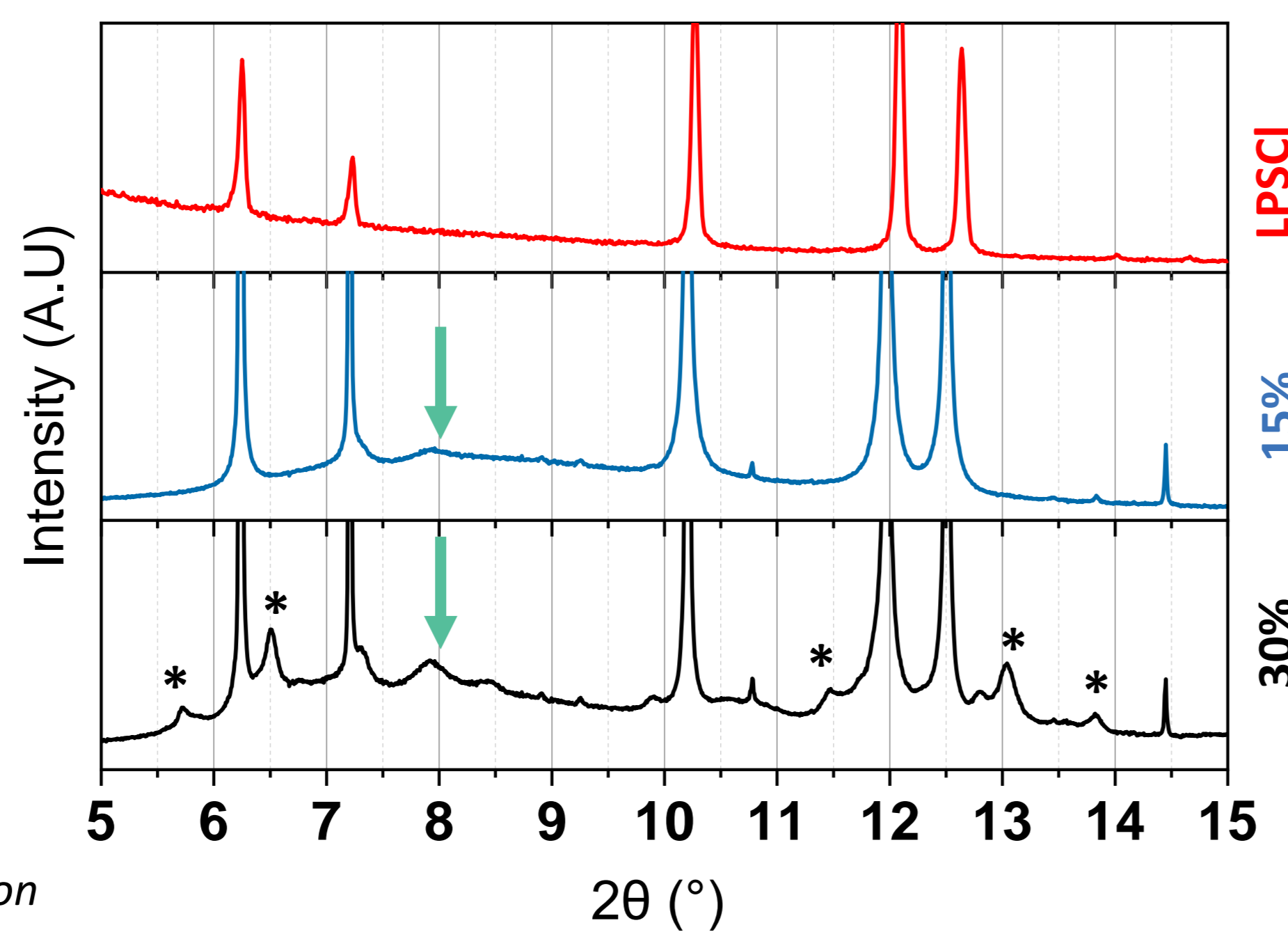

XRD patterns collected at ALBA synchrotron

### During heating

Sample containing 30 wt% binder

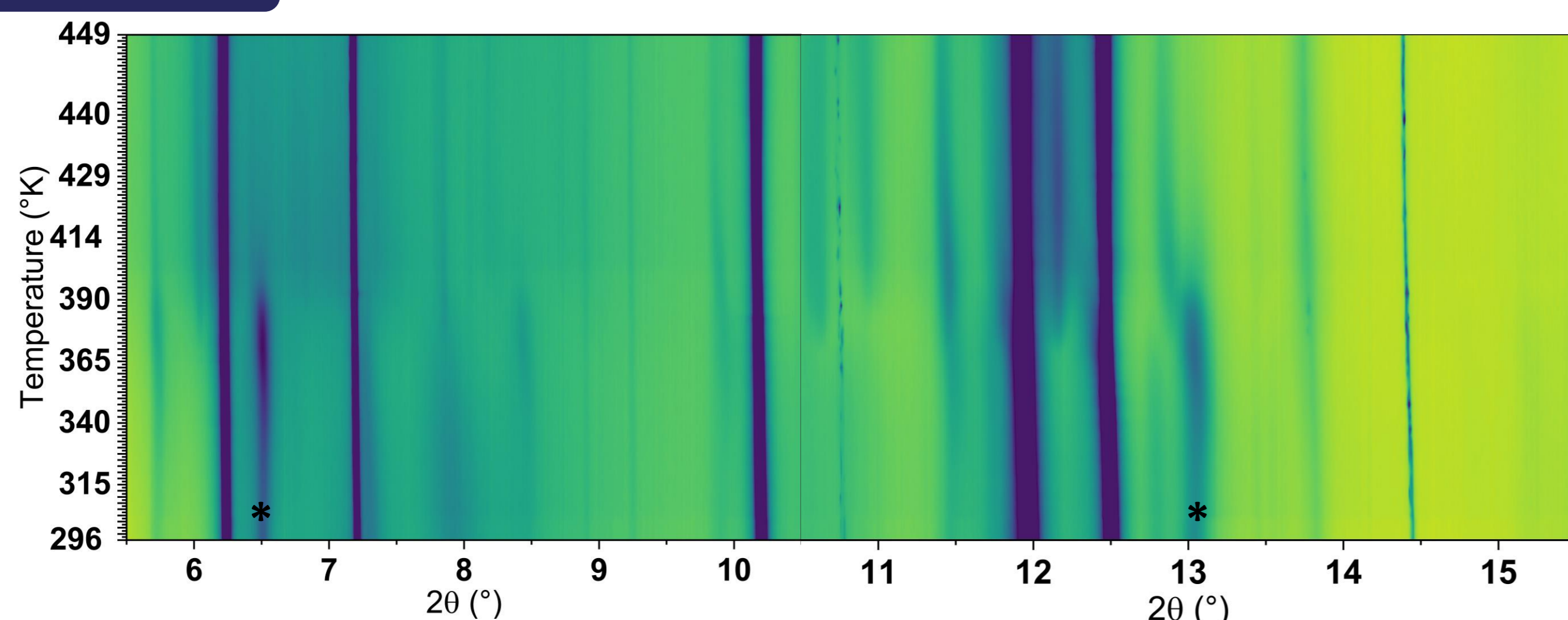

- Chemical decomposition visible at 25 °C with 30 wt% binder
- Impurities disappear with temperature treatment
- Other impurities appear with T°
- Irreversible structural transition from the binder under T°

## Does the binder influence the grain boundaries?

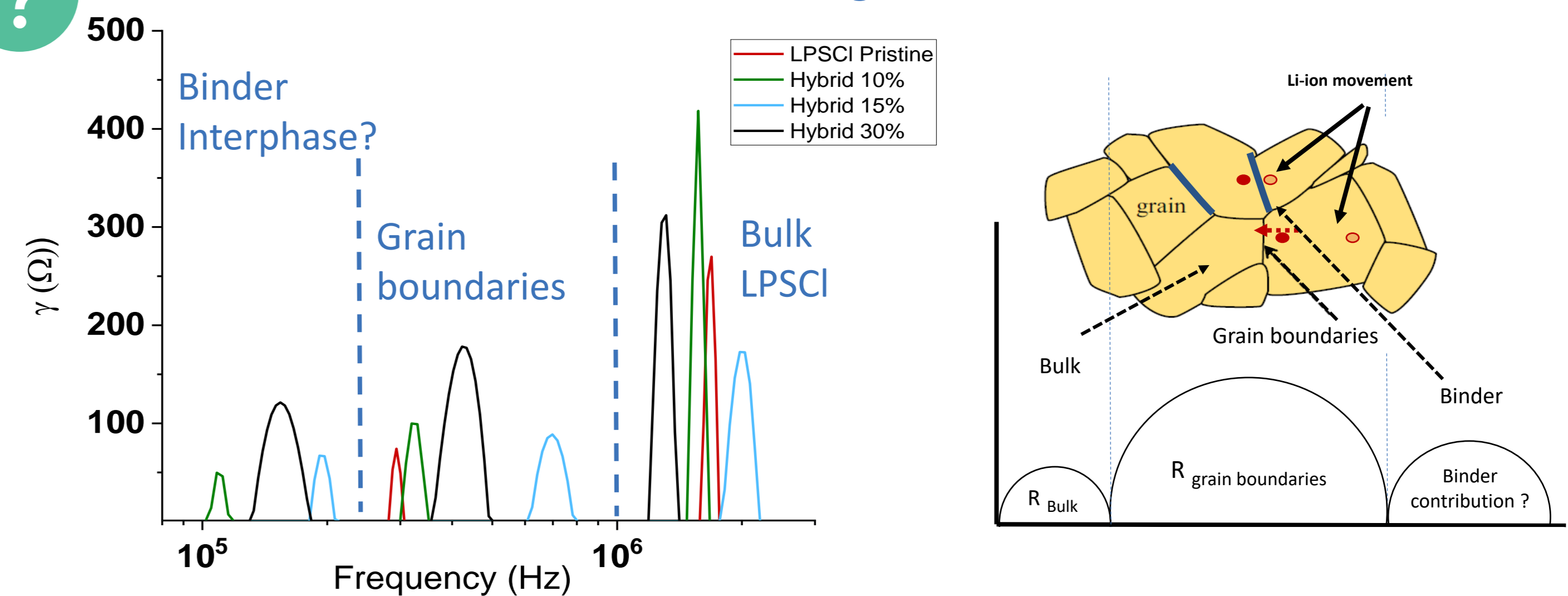

- At 10 wt% binder, the **hybrid electrode keeps LPSCI properties** with an additional contribution
- At higher loading, the frequency of R<sub>binder</sub> and R<sub>grain boundaries</sub> changed  
 → **chemical modification**

## Cyclic voltammetry

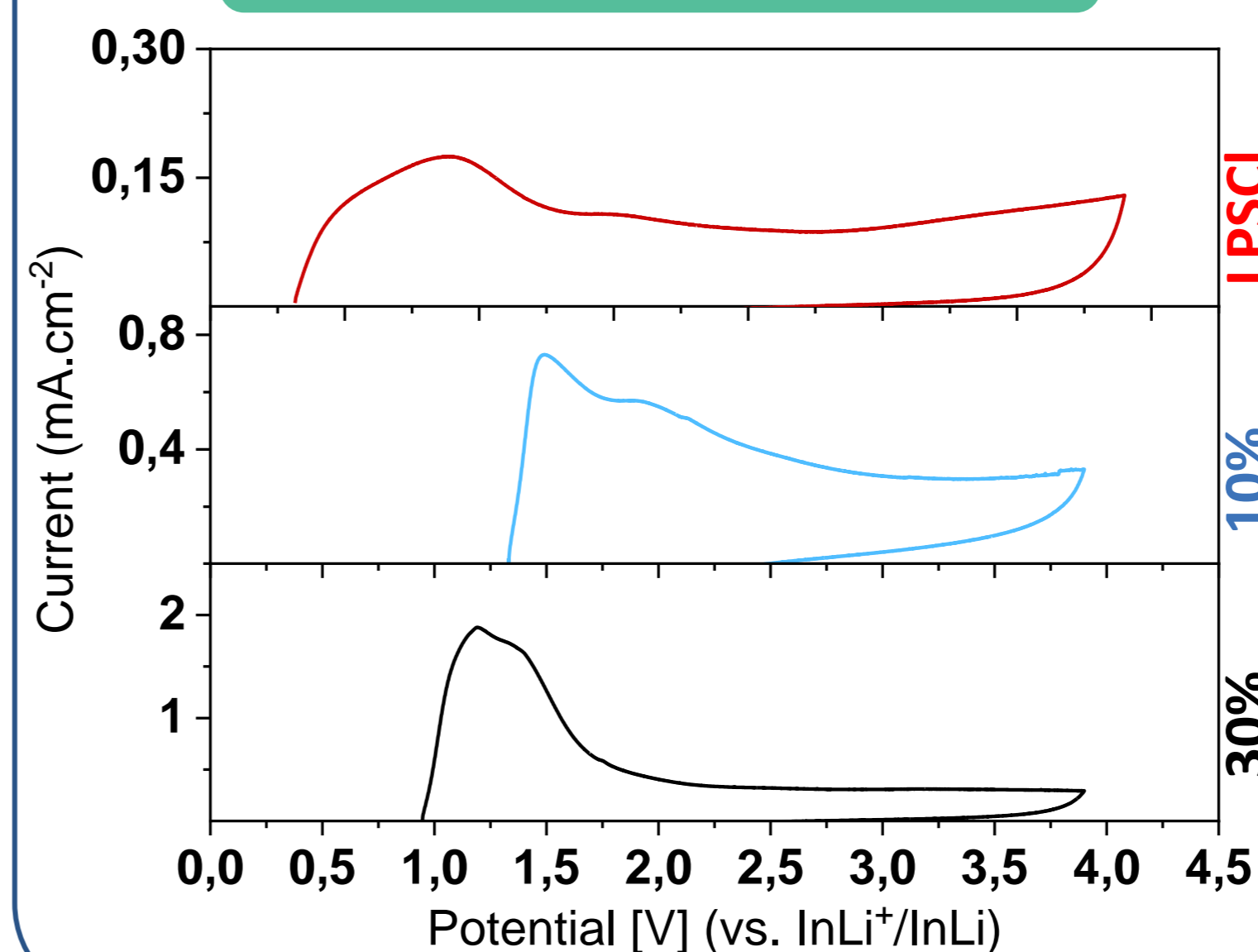

- Starting by oxidation
  - Decomposition visible at the beginning of the oxidation scan
- OCV shifts when binder is added : **chemistry evolved prior cycling (see XRD)**
- Current in oxidation is higher
  - Decomposition of the solid electrolyte **enhanced**

## Conclusion

- Impact of binder on hybrid ionic conductivity at room temperature :  
 - high ionic conductivity at 5 wt% :  $\sigma = 1.5 \text{ mS.cm}^{-1}$
- High percentage of binder is detrimental but help understanding the degradation process
- Optimal ratio to keep good LPSCI properties  
**Between 5-10 wt%**

## Outlook

- Degradation of hybrid electrolyte as a function of time
- Use different binder chemistry to tune the binder effects
- Study of morphology by tomography at ESRF : in progress

