

Saccade dysmetria during functional perturbation of the caudal fastigial nucleus in the monkey

Laurent Goffart *, Longtang L. Chen & David L. Sparks

* INSERM u534, Bron, France
 Division of Neuroscience, Baylor College of Medicine, Houston, U.S.A.

The medio-posterior cerebellum

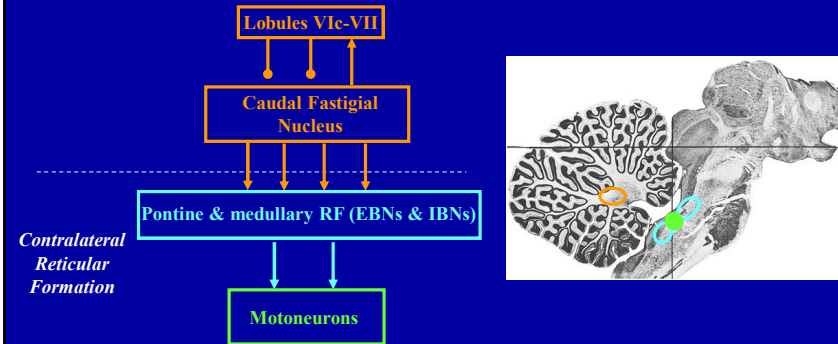

Pharmacological inactivation of cFN

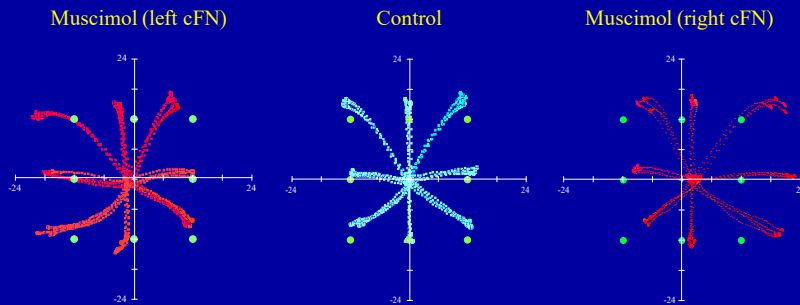

Horizontal component of ipsiversive saccades is **hypermetric**
 Horizontal component of contraversive saccades is **hypometric**
 Ipsilateral **fixation offset** Ipsilateral **bias** of vertical saccades

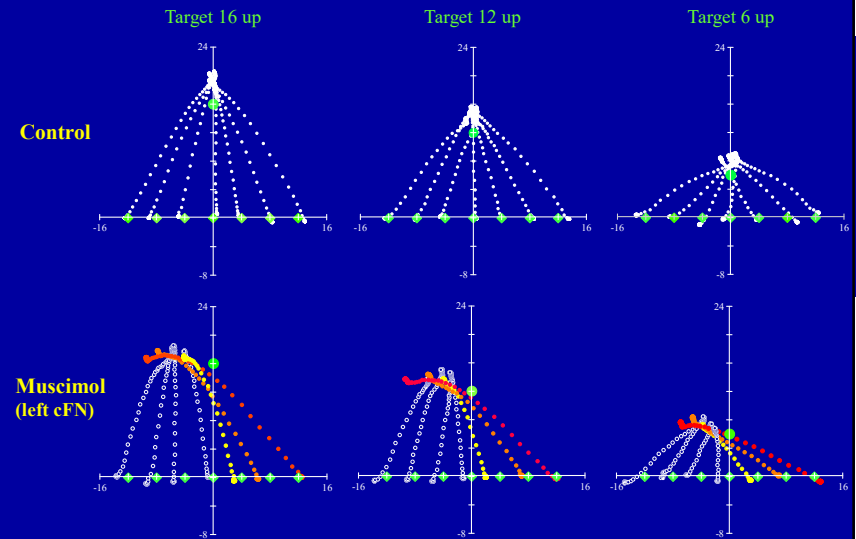

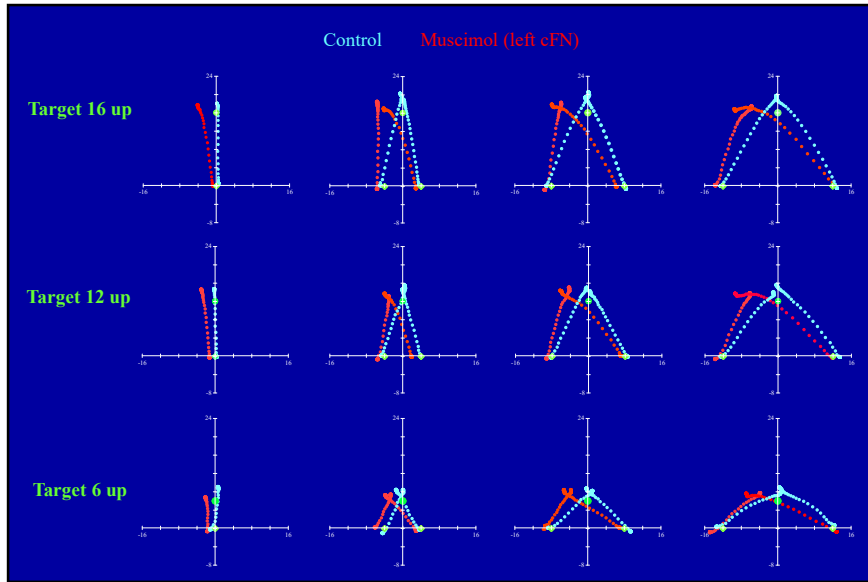

Pharmacological inactivation of cFN : no temporal resolution

Is the saccade trajectory biased because of an imbalance between the 2 cFN
- in the **pre-saccadic** activity ?
- in the **intra-saccadic** activity ?

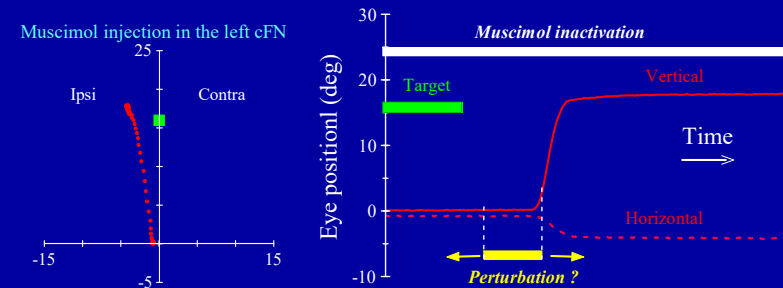

Transient inhibition of cFN activity by electrical microstimulation of inhibitory afferents

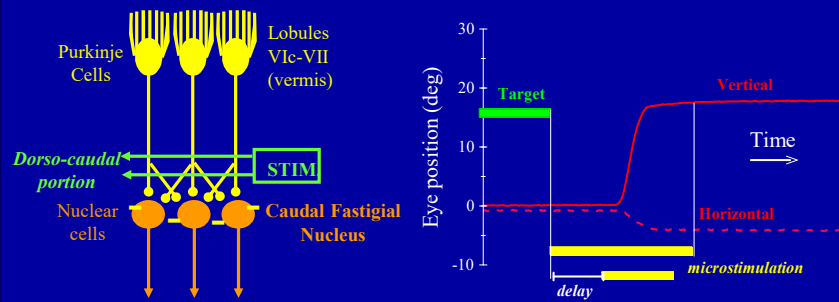

Microstimulation of Fastigial Nucleus

Noda, Murakami, Yamada & Aso, *Journal of Neurophysiology* 60, 1988.

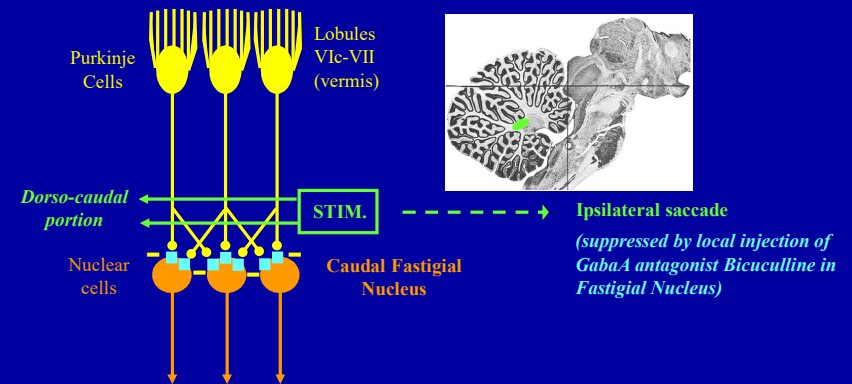

Microstimulation of Fastigial Nucleus

Noda, Murakami, Yamada & Aso, *Journal of Neurophysiology* 60, 1988.

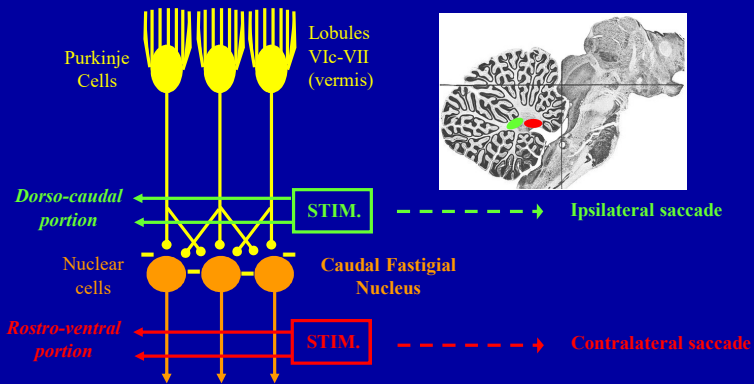

Purpose of experiments : microstimulation-induced inhibition of cFN

GOAL :

1. Find microstimulation parameters that:
 - inhibit FOR activity
 - without evoking ipsilateral saccade
2. Reproduce the muscimol-induced deficits on saccades towards visual target with a well-timed microstimulation !

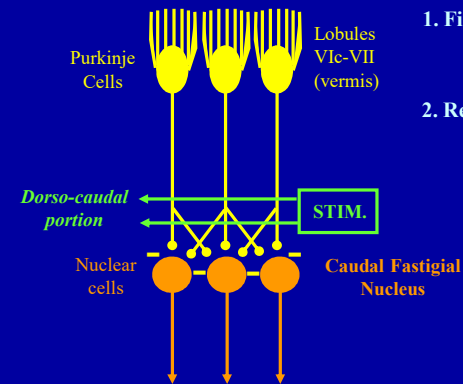

Methods

- Head-restrained rhesus monkey (n=3)
- Recording of eye movements with the search coil technique
- Tangent LED board in dimly illuminated room
- Identification of cFN :
 - Recording of omnidirectional saccade-related bursts
 - Low-current for evoking ipsilateral saccades (60 ms, 600 Hz, <math><50 \mu\text{A}</math>)
 - Direction of evoked saccades is reversed when the electrode is lowered in the contralateral side

Experimental design

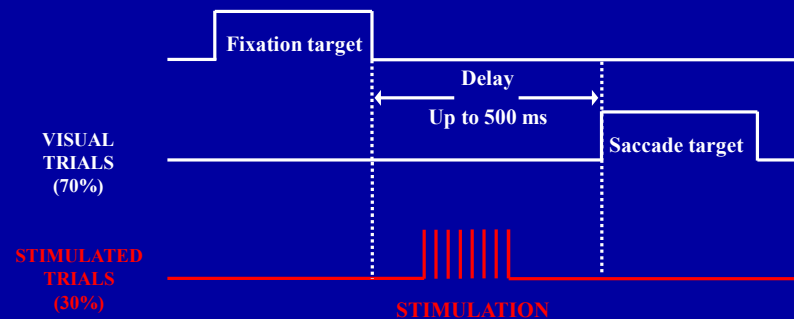

Monkey is rewarded after foveating the saccade target

Saccades evoked AFTER stimulation offset

Right cFN, frequency = 100 Hz, intensity = 20 μ A

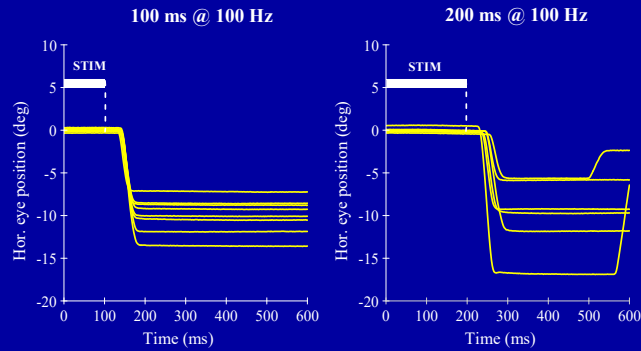

Saccades evoked AFTER stimulation offset

Left cFN, frequency = 100 Hz, intensity = 35 μ A

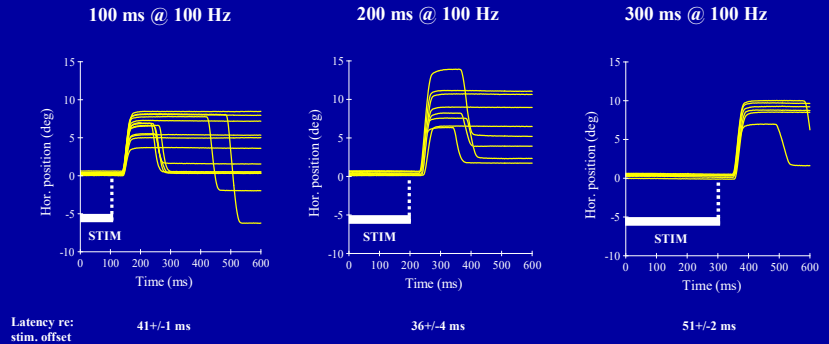

Microstimulation of Fastigial Nucleus

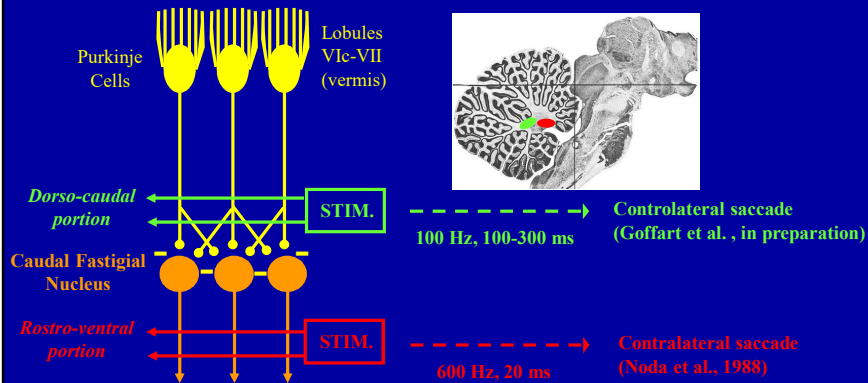

Low-frequency stimulation during saccade generation

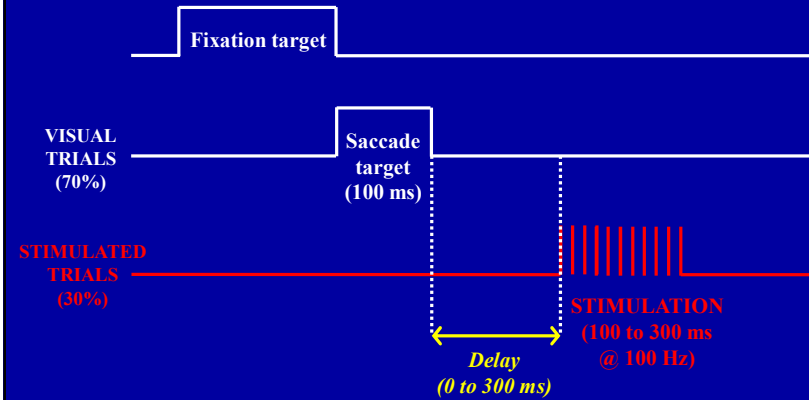

Low frequency microstimulation during a visual saccade

(Left cFN, 100 ms @ 100Hz)

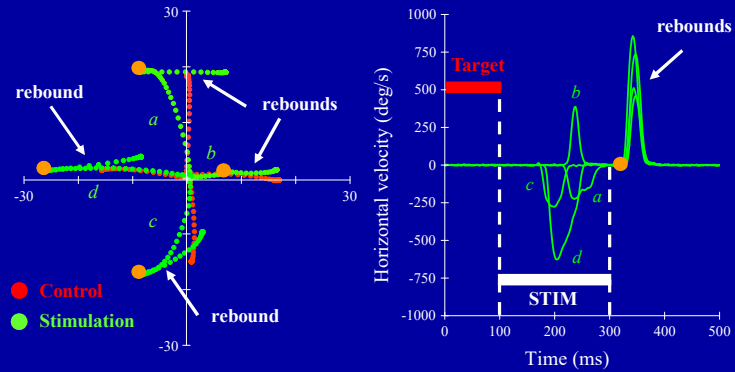

Muscimol-like effect of electrical microstimulation

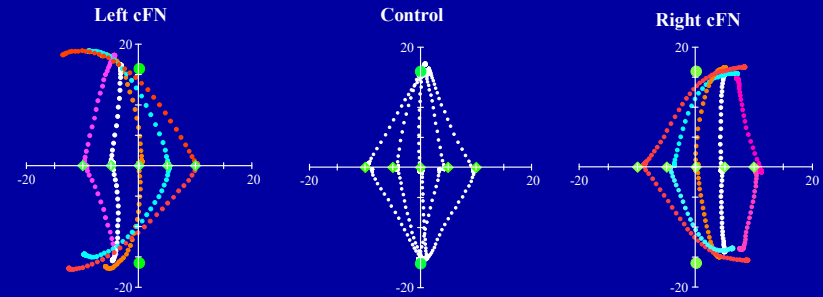

Horizontal component of ipsiversive saccades is **hypermetric**
 Horizontal component of contraversive saccades is **hypometric**
 Ipsilateral bias of vertical saccades

Stimulation before saccade onset

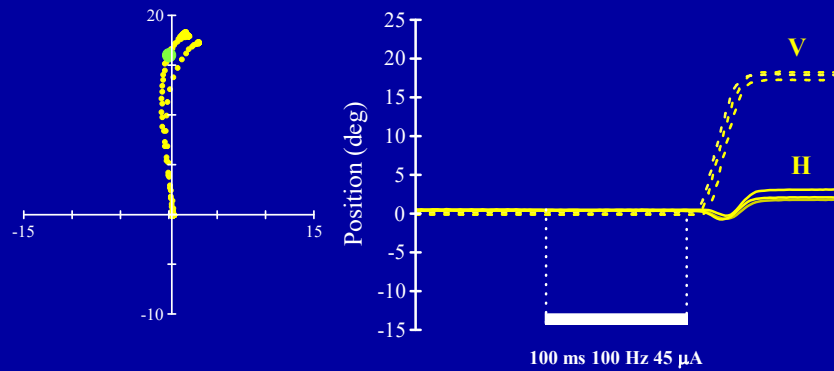

Stimulation during the saccade (early part)

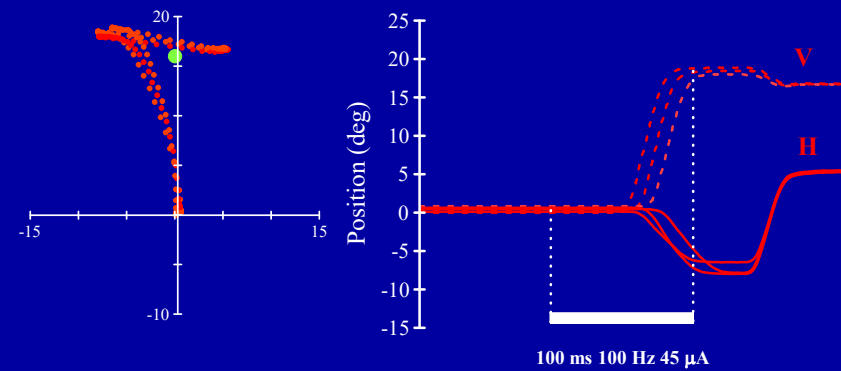

Stimulation during the saccade (late part)

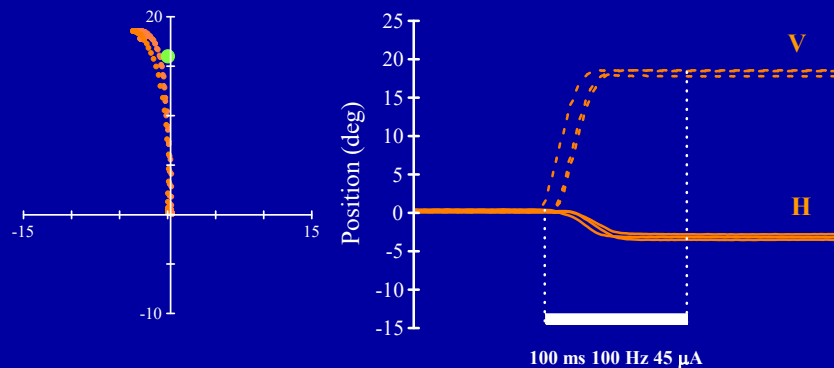

Conclusions (1/4)

- The muscimol-like effect of the stimulation on visual saccades suggests that **the microstimulation is inhibiting** the activity of cFN neurons by recruiting the axons of Purkinje cells.
- The contralateral saccades elicited after stimulation offset would result from a **post-inhibitory rebound depolarization** and spike bursting by cFN neurons (see the study in vitro by Aizenman and Linden *J. Neurophysiol.* 1999).

Conclusions (2/4)

This **hypothesis** of contralateral saccades evoked by a post-inhibitory rebound mechanism is consistent with :

a. the crossed projections from the cFN towards the horizontal saccade generator in the contralateral reticular formation

b. the contralateral direction of saccades evoked by microstimulating the axons of cFN neurons

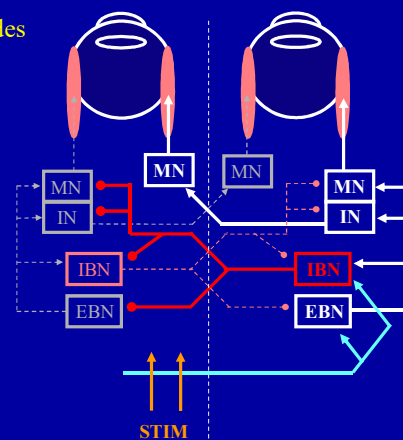

Conclusions (3/4)

- Since low-frequency microstimulation must be applied during the saccade to bias its trajectory, the horizontal bias observed in the head-restrained monkey during muscimol inactivation likely results from an impairment in the **intrasaccadic** activity of cFN neurons.
- The **fixation offset** may correspond to
 - * either a deficit in encoding eye position
 - * or a deficit in triggering small amplitude saccades

Conclusions (4/4)

- The horizontal bias of vertical saccades suggests a **balanced input**, in the normal situation, from the 2 cFN to the left and right saccade generators during vertical saccades.
- The intrasaccadic bias could result from an impairment in the pathway connecting the (inactivated) cFN towards the contralateral IBN area.

Acknowledgements



Grant EY01189



Human Frontier Science Program

LT58/96



Inserm

Institut national
de la santé et de la recherche médicale