



**HAL**  
open science

## **Product Service System: definitions and design approaches**

Paolo Gaiardelli, Xavier Boucher, Giuditta Pezzotta, Shaun West

► **To cite this version:**

Paolo Gaiardelli, Xavier Boucher, Giuditta Pezzotta, Shaun West. Product Service System: definitions and design approaches. McGraw Hill Professional. Maynard's Industrial and Systems Engineering Handbook, pp.1127-1154, 2023, 978-1-260-46156-5. <hal-04188474>

**HAL Id: hal-04188474**

**<https://hal.science/hal-04188474v1>**

Submitted on 7 Sep 2023

HAL is a multi-disciplinary open access archive for the deposit and dissemination of scientific research documents, whether they are published or not. The documents may come from teaching and research institutions in France or abroad, or from public or private research centers.

L'archive ouverte pluridisciplinaire HAL, est destinée au dépôt et à la diffusion de documents scientifiques de niveau recherche, publiés ou non, émanant des établissements d'enseignement et de recherche français ou étrangers, des laboratoires publics ou privés.



HAL Authorization

## Product Service System: definitions and design approaches

Prof. Paolo Gaiardelli, Prof. Xavier Boucher, Dr. Giuditta Pezzotta, and Prof. Dr. Shaun West

### 1 Introduction to Product-Service Systems

Ever-increasing customer expectations coupled with rising competition compel companies to seek new value propositions and business models. Among these are Product Service Systems (PSSs) where customer demand is met by selling satisfaction instead of providing the product per se. The transition of physical products to PSS can be seen as the evolution of product identity based on material content to a position where the material component is inseparable from the service system (Figure 1). Introduced for the first time by Vandermerwe and Rada in 1988 with the term “servitization”, the transition of industrial companies towards PSS identifies a challenging and complex management transformation based on *“innovation of an organization’s capabilities and processes to better create mutual value through a shift from selling product to selling PSS”* (T. S. Baines et al., 2007). It also represents an economical transition: (i) from a product-oriented economy towards a function-oriented economy, (ii) from value transactional economic models towards value-in-use relational models, (iii) from industrial strategies of production volumes towards strategies of value co-creation along the lifecycles, which requires active collaborative processes among networks of stakeholders and value creation actors (Medini and Boucher, 2016).

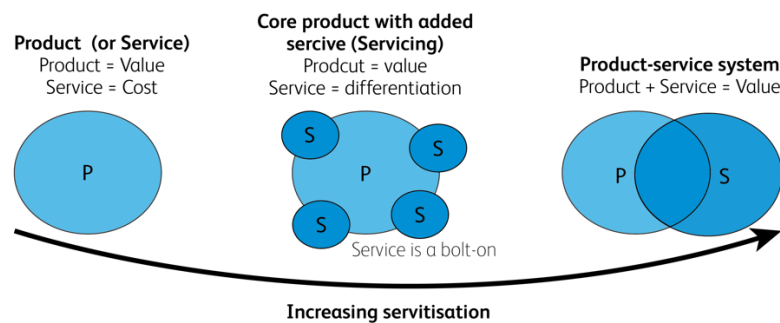

Figure 1: The transition from pure product to a Product Service System (based on Vandermerwe and Rada, 1988) (Illustration by Kodel Bahram)

Literature highlights different scenarios that can result in poor PSS. It mainly happens when the design is dominated by one side (product or service) over the other. Indeed, as pointed out by Kowalkowski (2016) and highlighted in Figure 2, the processes characterizing new product and new service development do not differ in their distinctive components, but on the time and resources involved. As a result, a product orientation that is too high, rather than an emphasis on service orientation, can lead PSS designers to develop sub-optimal solutions.

Adopting design and engineering methods and methodologies that are able to capture both product and service perspectives in a comprehensive and collaborative way, emerges as essential to create successful PSS, as done by companies such as GE Aero, Caterpillar, Hilti, and Xerox. At the same time, the ever-increasing importance played by digital technologies calls for the implementation of new methods supporting the design and engineering of technology-based PSS.

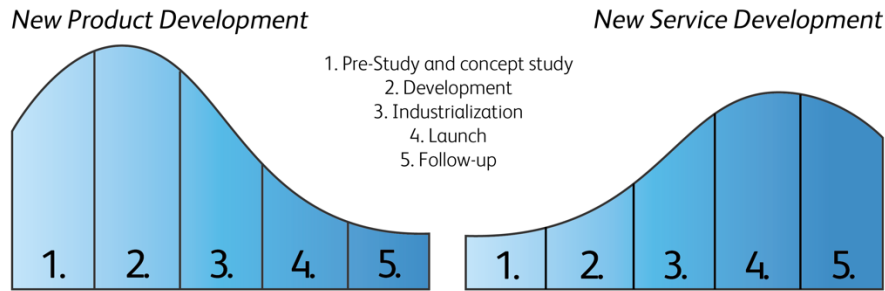

Figure 2: Spend profiles for new product development and new service development (based on Kowalkowski, 2016) (Illustration by Kodel Bahram)

Based on this premise, this chapter introduces, through an extensive analysis of existing literature and the presentation of successful industrial applications, the main methods, methodologies, and tools for designing and engineering traditional and smart PSSs.

## 2 Notion of Product Service Systems and conceptual definitions

PSS is an interdisciplinary research field, which attracts many different points of view and contributions. The concepts, definitions and typologies come from distinct complementary areas. Typically, business management investigates the bundling of products and services to form solutions. A well-recognized definition in this area considers PSS as *“a market proposition that extends the traditional functionality of a product by incorporating additional services”* (T. S. Baines et al., 2007). However, the emphasis on sustainable development has been a key focus for the deployment of this type of business model, leading Mont to define PSS as *“A system of products, services, supporting networks and infrastructure that is designed to be: competitive, satisfy customer needs and have a lower environmental impact than traditional business models”* (Mont, 2002). By integrating the industrial dimension of business model transformation, Meier considers that *“an Industrial Product-Service System is characterized by the integrated and mutually determined planning, development, provision and use of product and service shares including its immanent software components in Business-to-Business applications and represents a knowledge-intensive socio-technical system”* (Meier, Völker, and Funke, 2010). Although these three definitions are not exhaustive, they underline some of the crucial perspectives of PSS development, leading to the statements that PSSs:

- are defined as “value propositions” where the transactional unit is no longer the product by itself, but the outcome or utility delivered by the system.
- consist of a bundle offer of products and services, designed and coordinated throughout the process of value creation, and integrated by the PSS delivery processes' internal organization.
- are considered as a system-of-systems (e.g., an aircraft engine on an aircraft).
- are characterized by a transformation of the “focus” of the design and manufacturing processes with the integration of product and service activities over the whole lifecycle (Figure 3).
- are characterized by dynamics of networked co-production (customer/provider relationship, collaborative value networks, and multiple actors and stakeholders).
- generate new forms of value co-creation processes and key-value factors where collaboration and cooperation are crucial.
- increase the value of the product-in-use to satisfy the outcomes better and come with a perspective of minimizing environmental impact.

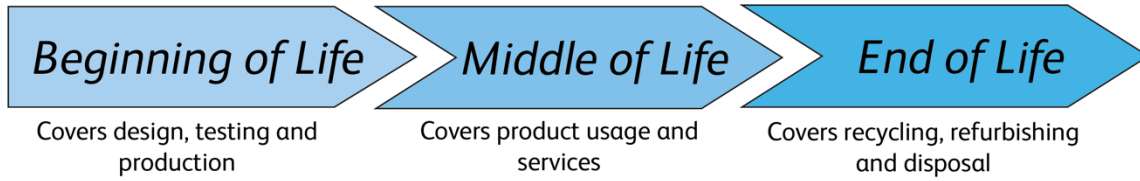

Figure 3: The three main phases within the PSS lifecycle (based on Wuest *et al.*, 2016) (Illustration by Kodel Bahram)

Table 1 provides an overview on the different kinds of definitions for PSS, with their specificities.

Table 1: PSS definitions

Definition	Source							
		Concept of system	Marketing	Tangibility, intangibility	Networks, infrastructures	Sustainability	Social Aspects and partnerships	Industrial process
A marketable set of products and services capable of jointly fulfilling a user's need. The PS system is provided either by a single company or by an alliance of companies. It can enclose products (or just one) plus additional services. It can enclose a service plus an additional product. And product and service can be equally important for the function fulfilment.	Goedkoop, 1999	X	X					
A system of products, services, supporting networks and Infrastructure that is designed to be competitive, satisfy customer needs and have a lower environmental impact than traditional business models.	Mont, 2002	X	X		X	X	X	
A product service system (PSS) can be defined as "an innovation strategy, shifting the business focus from designing (and selling) physical products only, to designing (and selling) a system of products and services which are jointly capable of fulfilling specific client demands".	Manzini and Vezzoli, 2003	X	X					
A system consisting of tangible products and intangible services designed and combined so that they jointly are capable of fulfilling specific customer needs.	Tukker, 2004	X	X	X				
A social construction, based on "attraction forces" (such as goals, expected results and problem-solving criteria), which catalyze the participation of several partners. A PSS is a result of a value co-production process within such a partnership. Its effectiveness is based on a shared vision of possible and desirable scenarios.	Morelli, 2006				X		X	X
A market proposition that extends the traditional functionality of a product by incorporating additional services.	Baines <i>et al.</i> , 2007		X					
An Industrial Product Service System is characterized by the integrated and mutually determined planning, development, provision, and use of product and service shares, including its immanent software components, in Business-to-Business applications and represents a knowledge-intensive socio-technical system	Meier <i>et al.</i> , 2010	X			X		X	X
A Product Service System (PSS) is an integrated bundle of products and service which aims at creating customer utility and generating value.	Boehm and Thomas, 2013	X	X					

## 2.1 Basic PSS typologies

Different kinds of PSS can be considered, depending on how products and services can be associated or integrated, but also depending on the type of economic model deployed. PSS typologies provide interesting support to help creativity during the design of value offers and then PSS solutions. A first basic, and widely accepted, typology of PSS has been proposed based on the work of Hockerts (1999) and reinforced by several authors, notably Goedkoop (1999) and Tukker in 2004 (Figure 4). There are many examples of the three typologies described by Tukker, however, many of the PSS are hybrids of the three typologies combining aspects of product-, use- and result-orientation within the individual value proposition.

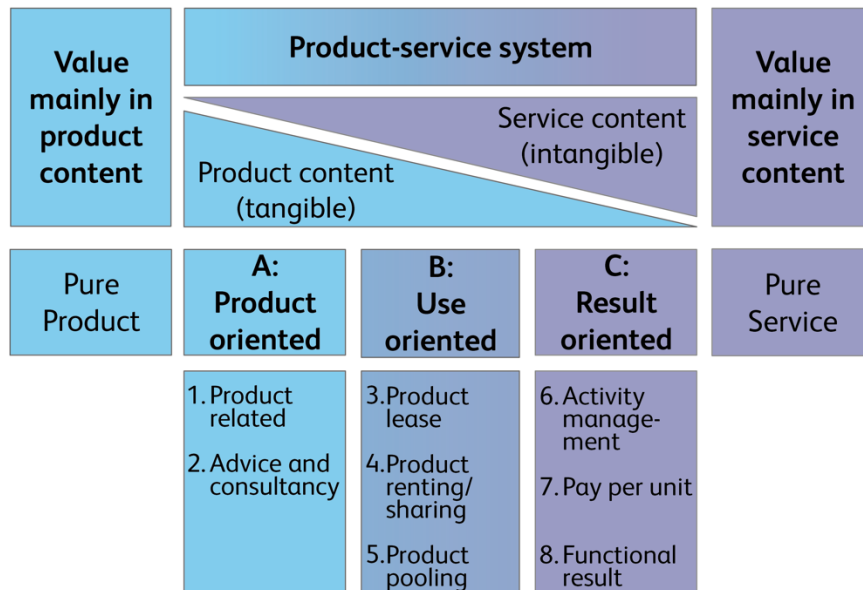

Figure 4: Usual PSS typology (based on Tukker 2004) (Illustration by Kodel Bahram)

### 2.1.1 Product-Oriented PSS

The product is sold in a transactional model, but the sales contract includes services deployed along the product lifecycle to support the management of the asset in use. This includes all after-sales services, such as maintenance (in its different contractual formats), diagnosis, repair and overhaul, spare parts and consumables, transportation, installation and commissioning, cleaning, refurbishing, updates, upgrades (recycling and take back), as well as information, training and consulting services on the use of the product, and management related activities. These can include help desk support, product, process and business trainings and consultancy solutions. Each solution can be provided individually or in the form of packages. Examples of packages can be all-inclusive maintenance programs or promotional packages for spare parts and options installation.

Examples of product-orientated PSS include GE's Multi-year Maintenance Program or ABB Turbo Systems' basic maintenance agreements, where all of the services are bundled into a contract with a performance commitment for the service level (e.g., availability of spares or call out time). Other examples include the installation and startup services offered by HP (Care Pack) and Cisco (IOS Auto-Upgrade Manager), and remanufacturing solutions such as the Caterpillar Certified Rebuild Program.

### 2.1.2 Use-Oriented PSS

The provider contracts with the customer for access to the product or use of the product without purchasing it (relational economic model). The products remain the property of the provider or a financial intermediary. Both product usage and additional services are embedded in the contract: the providers are generally responsible for maintaining the functioning of the product system, according to a pre-defined level of quality, as part of the contract. This approach involves an advantage for the service supplier, reducing its commercial efforts in service sales, as services are already included

in the provided solution. On the other hand, customers enjoy better control of the total cost of ownership, and by transferring the risk directly to the supplier benefit from simpler asset management.

Examples of use-oriented PSS include leasing, short and long period renting services, product sharing and pooling. There are many practical examples of use-oriented solutions, ranging from automotive to office solutions (e.g., pay per use solutions provided by Xerox), from toys (Rent-That-Toy), to equipment for transport like pallets and containers (e.g., Chep). For instance, Caterpillar provides a broad range of value propositions based on this model on both short- and long-term contracts. Hilti, known for manufacturing high-quality hand tools, has seen over 70% of its growth from its service business based on use-oriented contracts. GE Aero or Rolls-Royce both provide advanced forms of use-orientated PSS: here the product is sold to a financial intermediary who leases the product to the airline while the OEM's revenue model is based on operational hours and rewards the outcomes (e.g., unit availability and fuel efficiency).

### 2.1.3 Result-Oriented PSS

Independently of any pre-defined product, the provider guarantees to answer specific customer needs, with a contracted defined by the final result/performance. Service activities are embedded in the contract, but the provider's engagement is defined according to the performance defined in the agreement between the firms. This is very similar in content to traditional out-sourcing.

Examples here are Thales Training & Simulation, a leading provider of simulation software in the field of defense, transportation and energy management, who offer integrated training solutions for the use of their software systems with the formula "you pay according to what you have learned", while Aggreko offers a "rental" of their generation units based on the power they deliver. Nobel Enterprises moved into results-orientated PSS with their explosive services, where the explosives are only part of the overall PSS.

## 2.2 **Extended PSS typologies**

Several complementary contributions addressing PSS typology can be found in literature (Adrodegari *et al.*, 2015, Gaiardelli *et al.*, 2014 and Park *et al.*, 2012).

An extended vision of Tukker's typology has been proposed by Boucher and Peillon (2015), built from academic contributions and the result of a quantitative study of industrial service deployment. The approach gives a generally applicable, yet pragmatic PSS classification, useful for any sector of activity as a design aid. The classification proposed is based on the typologies established by Gebauer and Kowalkowski (2012), Hockerts (1999), and Tukker (2004). The classification, which can support the design of new PSS (Figure 5) and extend existing PSS offerings, has two levels:

- i. The first level differentiates the solution according to the level of maturity/complexity of the PSS offer: the three first categories are associated with product-oriented PSS, but add value to the usual 'after-sale' services (e.g., maintenance), moving towards services offering the customer diagnostic capacity and reconfiguration of its activities or processes. Categories 4 and 5 correspond to the use- then result-oriented PSS of Tukker's (2004) typology.
- ii. The second level of the classification differentiates sub-categories of PSS solutions for each of the 5 main classes. For the 3 first ones, the sub-categories depend on the services' situation in the life cycle (before sale; supporting the selling process itself; or after-sales services).

More specifically, in the use- and result-oriented PSS the sub-categories correspond to generic types of PSS in the industrial area: for instance, a 'Mutualized Resource Platform' offers an open panel of customers the opportunity to pay for a limited utilization of a technological system, made available and functional through a platform implemented by an intermediary (Territorial Innovation Hubs often provide such opportunities for SMEs).

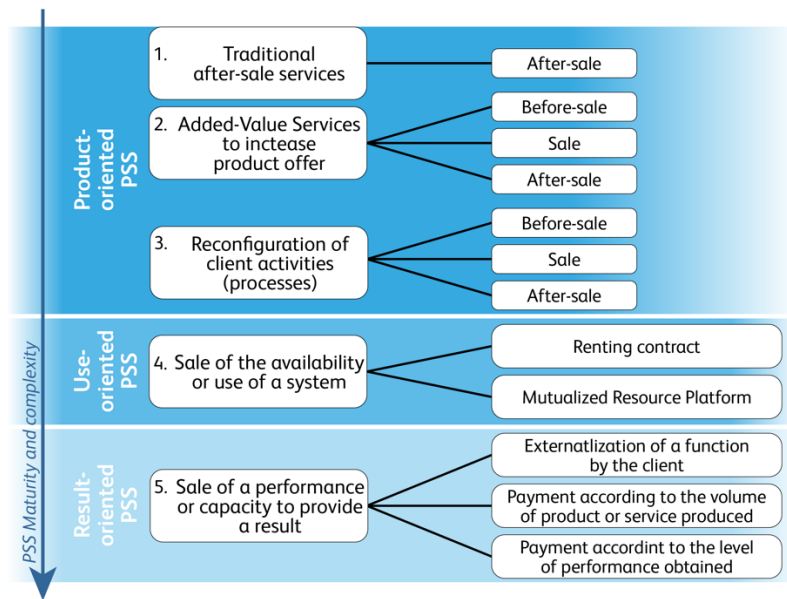

Figure 5: PSS Typology proposed by Boucher and Peillon, 2015 (Illustration by Kodel Bahram)

### 2.3 Industrial capabilities for PSS design and delivery

PSS development can lead to the transformation of industrial companies' culture and management through changes to support the integration of service activities in their business models. In general terms, the transformation of manufacturing firms has been studied in depth through servitization research. One of the key managerial questions is identifying the key generic capabilities to be developed internally. Story et al., (2017) made a large study of UK-based industrial companies concerning their capabilities to deliver "advanced services" based on PSS, offering insights and lessons for firms moving from product-based to PSS-based value propositions.

The first lesson from this study is a proposal to structure the analysis of capabilities by using as filters a set of "key business activities" considered crucial for companies. Six business activities are identified: Innovation; Interaction processes; Actor insight; Business culture evolution; Working with other actors; Infrastructure development and management. As these six activities are necessarily developed in interactions among various actors of the business ecosystem, the implementation and management are found to be highly dependent on the capabilities of all actors of the network. The study also highlights the need for multi-actor capabilities. This emphasizes the collaborative nature of PSS design and development: any company engaged in servitization has to be aware of its internal competencies and the capabilities of its potential partners. Specifically, three key actors in the value chain are considered: the manufacturer, the intermediary and the customer.

For manufacturers, six key capabilities are proposed, corresponding to the 6 structuring business activities. Among these capabilities, three are as unique and critical for the development of advanced services:

- Manufacturers need to balance product and service innovation – without service innovation they are often limited to offer basic services.
- Managing risk-reward service contracts – Customer-focused through-life service methodologies appear to be critical to managing risk/reward service contracts.
- Creating distinct, yet synergistic product and service cultures – this is one of the most significant challenges, requiring changing organizational mindset from a product to a product- and service-focus.

Intermediary actors often form a critical part of the PSS value network: they install or integrate the system and are necessary to coordinate and integrate third-party products/services. Five key capabilities for servitization are identified, but only one is considered critical for the deployment of more advanced services:

- Becoming informed providers – because of their key role in the value network, in interaction with third-party partners, intermediary actors need to become informed providers of products and services, able to push advanced offerings towards customers.

Finally, for customers, two capabilities appear critical for advanced services:

- Co-creating innovation – this is particularly important, since advanced services are based on building then offering a collaborative vision of value delivery, which requires customers and suppliers to work at new offer development collaboratively.
- Contract management capabilities – customers need to develop a capability to manage and contract service outsourcing to ensure the efficient delivery of their proper key operational processes, including product-related processes.

## 2.4 PSS design

Companies encounter many difficulties in formulating a PSS value position. These are related to the external contextual environment and to internal aspects in the firm. The external factors mainly relate to the market norms and customer's preferences. The internal aspects refer to the definition of processes, methods and techniques required to support its design and engineering. Designing and developing solutions that simultaneously cover both tangible and intangible aspects are far from traditional product engineering. Above all, manufacturing firms generally do not think systematically about both aspects, because historically, services have always been managed either by the after-sales function or by the marketing department.

The lack of a systematic approach has been well underlined by Behara and Chase (1993): "if we designed cars the way we seem to design services, they would probably come with one axle and five wheels". Problems that generally occur in the engineering of PSS solutions can be due to the lack of:

- an appropriate innovation management process,
- organizational structures and qualified personnel,
- appropriate models and methods,
- digital tools to support the development process.

To find a systematic way to address these issues, Product Service Design and Service Engineering fields were consolidated during the 1990s, mainly in Germany and Israel, as a branch of engineering sciences that study the systematic development and design of integrated product-service solutions through the use of appropriate procedures, methods and tools (Bullinger, Fähnrich, and Meiren, 2003). Product Service Design and Engineering adopt a technical-methodological approach trying to use both existing engineering know-how in the product and systems development area and tools from the world of marketing (New Service Development) and design thinking (Service Design Thinking) in order to create innovative services and PSS.

Designing and developing a PSS is a complex task due to the long and unpredictable lifecycle, the number of interactions among the actors involved, and the constituent components. While designing integrated product and service solutions, the fundamental elements to consider are:

- integrated solution or value proposition – a PSS system is composed of product and service content, the network of actors and the infrastructure to support its delivery.
- lifecycle perspective – a PSS value proposition and implementation presupposes the extension of the producer's responsibility and the involvement of the customer throughout the entire life cycle from the beginning of life (e.g., design, build, install) through the middle of life (e.g., operations and maintenance) to the end of life (e.g., upgrade, recycle or disposal).
- ecosystem actors – engineering an integrated solution requires all actors' active involvement (including the active stakeholders and the beneficiaries) over the lifecycle.

***Example of ecosystem actors involved in PSS design***

Ecosystem actors include all the value chain actors that deliver the PSS over the lifecycle. These actors must be actively involved in the engineering phases as they are fundamental to creating value and satisfaction. For example, an aero-engine will have the following actors involved in the PSS design and delivery:

- the manufacturer – the firm who develops and manufactures the engine,
- system integrator – typically the airframe manufacturer,
- regulators – often the Federal Aviation Administration as well as environmental regulators,
- financial leasing firms – often the owner of the engine,
- aircraft maintenance service – the providers of maintenance, completions, repair, and overhaul services for aircraft and engines,
- airline – the operator of the aircraft and the engines,
- airport – the owners and operators of the airport.

Most of the models, methods, and tools developed in this field allow the customer's active involvement either as co-designer or co-producer.

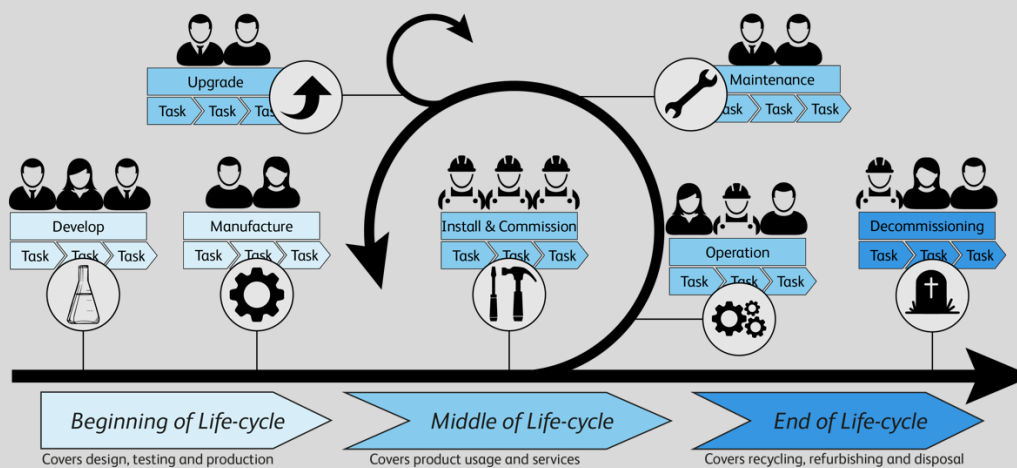

Figure 6: Actors and their roles over the PSS lifecycle (Illustration by Kodel Bahram)

To design a PSS, it is necessary to adopt a formal development process to convert new PSS ideas into real elements of value (Froehle and Roth, 2007). However, formalizing a development process does not mean adopting rigid and inflexible schemes, but rather defining guidelines that help companies work effectively and with focus (Bullinger, Fähnrich, and Meiren, 2003).

The development processes are generally based on reference models that contain internal indexes. The V-model is one such reference model, which involves early and comprehensive identification of outcomes based on use cases, that describes the user and their needs within an operating environment. The needs and operating environment are then translated into detailed and testable system requirements, detailed design, implementation, and acceptance testing of the implemented system to ensure it meets the stated requirements (system verification). The process emphasizes requirements-driven design and testing with all design elements and acceptance tests traceable to one or more system requirements. Individual requirements must be addressed by at least one design element and acceptance test.

The adoption of a structured development approach is fundamental because it highlights the need for proper resource capabilities, the level of involvement of different customers and stakeholders, the perspective along the life cycle, and the development process on the added value the company aims to provide. There are different methodologies, methods, and techniques for

developing a PSS, Table 2 lists the main ones. For each method, the description and the engineering phase in which the methods are used (Cavalieri and Pezzotta, 2012) are reported.

Table 2: Methods used in PSS design

Method or tool	Description	Phase based on (Cavalieri and Pezzotta 2012)	Source
<b>Actor and (eco)system maps</b>	Method to map and visualize all the actors involved in the PSS provision process	Requirements identification and analysis; PSS Design	Lindahl et al., 2014
<b>Analytic Hierarchical Process (AHP) and Analytic Network Process (ANP)</b>	Multi criteria decision making method for organizing complex decisions. It is based on pairwise comparison of different criteria	Requirements identification and analysis; Concept development	Fargnoli and Haber, 2019; Song and Sakao, 2017
<b>Avatar mapping</b>	The Avatar map represents the product or machine, showing inputs, process and outputs allowing its interactions with other actors to be clearly defined. It is the counterpart to the empathy map	Requirements analysis; Concept Development	West <i>et al.</i> , 2020
<b>DEMATEL</b>	Decision Making Trial and Evaluation Laboratory (DEMATEL) is a method dealing with large problems of group decision-making by assessing the direct and indirect relationships among all elements as well as studying the direction and intensity of the relationships among already defined components.	Requirements analysis and Test	Liu, Ming and Song, 2019
<b>Empathy Map</b>	The map provides an overview of who the focal actor is, and helps identify inconsistencies in the perception of the same actor from various team members.	Requirements analysis; Concept Development	Ferreira <i>et al.</i> , 2015
<b>EVA</b>	A 2-step procedure composed of multi-criteria decision-making methods with specific criteria for a comprehensive value assessment of PSS from both the customers' and the provider's perspectives.	Concept Evaluation	Rondini <i>et al.</i> , 2020
<b>Extended Functional Analysis</b>	Method helping define which PSS features (functions) should or should not be included in a solution. Based on cost or customer value.	PSS Design	Andriankaja <i>et al.</i> , 2018
<b>Journey mapping</b>	A representation that describes step-by-step how actors interact with a service. The process is mapped from the focal actor's perspective. It is closely related to service blueprinting	Requirements analysis; Concept Development	West, Stoll, Østerlund, <i>et al.</i> , 2020
<b>Kano model</b>	Method that classifies customer preferences in five different categories	Requirements identification and analysis	Haber <i>et al.</i> , 2020; Van Halen <i>et al.</i> , 2005
<b>Persona</b>	Method is mainly adopted in user-centered design. A persona is a fictional person created to represent a user type of a PSS. People belonging to the same persona would act in the same way.	Requirements identification and analysis	Hara <i>et al.</i> , 2009
<b>Product-Service Concept Tree</b>	Method developed to support the definition of a PSS solution starting from customer needs.	Requirements analysis	Rondini Alice <i>et al.</i> , 2016
<b>Prototyping</b>	This method consists of creating samples or models of the PSS to test its functionality.	PSS Design and Test	Exner <i>et al.</i> , 2016
<b>ProVa</b>	A structured method to analyze the provider value for each PSS.	Concept Evaluation	Matschewsky <i>et al.</i> , 2018
<b>QFD</b>	Quality Function Deployment (QFD) analysis is a structured method to define customer needs and	Requirements analysis; Concept Development	Fargnoli and Haber, 2019; Kim and Yoon,

	translate them into product/service requirements.		2012; Peruzzini <i>et al.</i> , 2015
<b>Service Blueprinting</b>	Method adopted to represent the service process. It gives a cross-functional perspective of the resources involved in the process.	PSS Design	Pezzotta <i>et al.</i> , 2016; Sakao <i>et al.</i> , 2009
<b>Simulation</b>	Method consisting of the representation of a business process in a dynamic process, helping predict outcome.	Test	Bertoni <i>et al.</i> , 2019; Pezzotta <i>et al.</i> , 2016; Rondini Alice <i>et al.</i> , 2017
<b>TOPSIS</b>	A method designed to designate a preferred alternative according to a finite number of criteria.	Concept Evaluation	Song and Sakao, 2017
<b>TRIZ</b>	A problem-solving, analysis and forecasting tool derived from studying patterns of invention in the global patent literature. The method is based on logic and data, not intuition.	Concept development; Requirements identification and analysis; PSS Idea generation	Song and Sakao, 2016

In addition to all the different methods proposed, comprehensive methodologies have been developed to design a PSS. Among the pioneer works on the topic, two of them pave the way: the Service CAD on which a tool (Service Explorer software) has also been developed, and the MePSS (Methodology for Product Service Systems - (Van Halen, Vezzoli, and Wimmer, 2005)). The approaches adopt a broad perspective, addressing many issues such as development strategies and innovation in services, aspects of organizational design and human resources management in service development, and information technology support. A list of the most comprehensive methodologies is provided in Table 3.

Table 3: Methodologies for PSS design

Aim or purpose	Source	Methodology developed (description)	Reference method
Define a methodology based on a modeling method for PSS and a method to evaluate the modeled services	Hara <i>et al.</i> , 2009	The methodology aims at designing an integrated Product Service solution considering as main goal the change of the RSP (customer satisfaction). It consists of the following phases: 1. Persona model (to define customer features); 2. View model (to define product and service function associated to the customer); 3. Blueprinting (to correlate customer value and service activities); 4. Evaluation of structure of the service delivery process designed considering three different indexes (visibility to receiver, interactivity with the receiver and degree of receiver participation).	The methods adopted are: Functional analysis (for the definition of requirements) Blueprinting (for the definition of the processes) and AHP method to calculate the RSP of customer.
Definition of a PSS engineering methodology aiming at offering a solution to the customer that balances both customer satisfaction and company internal performances	Pezzotta, <i>et al.</i> , 2016	SEEM is a step-by-step methodology which considers both customer and the company perspective by adopting an iterative approach. It has been developed in collaboration with an industrial company	The methods adopted are: Functional analysis, QFD; Service Blueprinting Simulation, F2F Interviews
Propose a methodology for designing service activity and product concurrently and collaboratively.	Sakao <i>et al.</i> , 2009	The methodology developed is based on the following phases: 1. Functional analysis (through view model) used to describe service content; 2. Service blueprinting used to describe the service processes; 3. QFD used to match together functional analysis and blueprinting. AHP used to define the importance of Receiver state parameters (RSP).	The methods adopted are: Blueprinting, QFD, Functional Analysis, AHP Method
It aims to define a structured and systematic PSS development	Van Halen <i>et al.</i> , 2005	The methodology developed (MEPSS) is composed of 5 main phases that are supposed to be followed to implement a PSS successfully.	The MEPSS is based on the following methods: Gate model, Project

methodology to exploit existing business and technologies to enter new markets properly.		Each phase is composed by a different number of steps by specific input, output and actions. At the end of each phase, their decision node would define the project worthiness to be continued. For each phase/step specific tools are suggested	management model, Need and function analysis, Kano model for customer needs, F2F interviews, Focus groups, life cycle costing
It represents a systematic procedure for the development of Product Service Systems (PSSs) by focusing on designing services related to the proper functioning of their products fulfilling customers' needs and expectations.	Fagnoli <i>et al.</i> , 2019; Haber <i>et al.</i> , 2020	The methodology is based on 3 steps: PSS Components definition; Services' Modules definition; PSS optimization.	The methods adopted are: Kano Model, AHP and QFD.
The Product Service System Lean Design Methodology (PSSLDM), is a structured methodology to develop PSSs along their entire lifecycle integrating product and service design perspectives.	Pezzotta <i>et al.</i> , 2018; Sassanelli <i>et al.</i> , 2018	The PSSLDM encompasses four phases, namely: customer analysis, solution concept design, solution final design, and offering analysis.	The methods adopted are: Persona Model, PSCT, Blueprinting with BPMN; DfX techniques.
The Extended Functional Analysis (EFA) approach has been developed as a PSS design method for Business to Business context. The objective is to cover the full design process from analysis of the strategic context until decision for the PSS solution's industrialization.	Andriankaja <i>et al.</i> , 2018	To facilitate industrial acceptability EFA approach is based on the integration of a PSS design approach and an industrially used product design methodology (Functional Analysis). The five key phases of the methodology cover PSS context & usage analysis; PSS external functional analysis; PSS internal functional analysis; PSS Detailed design; PSS industrialization. The design covers 3 main PSS dimensions: products, services, value network (with its economic model).	Additional to usual design methods (notably product functional analysis), a method and tool are proposed for Service and Value Proposition design (PS3M tool), then for Value Network simulation (PS3A tool).

Among the more recent methodologies, the methodology SEEM (Service Engineering Methodology) (Pezzotta et al., 2016) focused on the engineering and re-engineering of the service offering and the PSS design framework based on the Extended Functional Analysis (EFA) approach (Andriankaja, Boucher, and Medini, 2018), covering the three dimensions of product, service, and value network design.

#### 2.4.1 SEEM: Service Engineering Methodology

SEEM aims to support companies making the shift from a traditional product business offering basic services to one with a more advanced PSS value proposition based on service-dominant logic, as well as re-engineering an already servitized business. In particular, SEEM supports companies in engineering and re-engineering their PSS while balancing the value perceived by customers with the service delivery processes' internal efficiency and productivity. The SEEM framework, shown in Figure 7, is divided into two main areas:

- i. Customer area – the analysis of customer needs, that represents the starting point to design new product-services, and the re-arrangement of the company service portfolio.
- ii. Company area – it deals with the design and assessment of the service delivery process to support the definition of a service delivery process considering the company's external and internal performance.

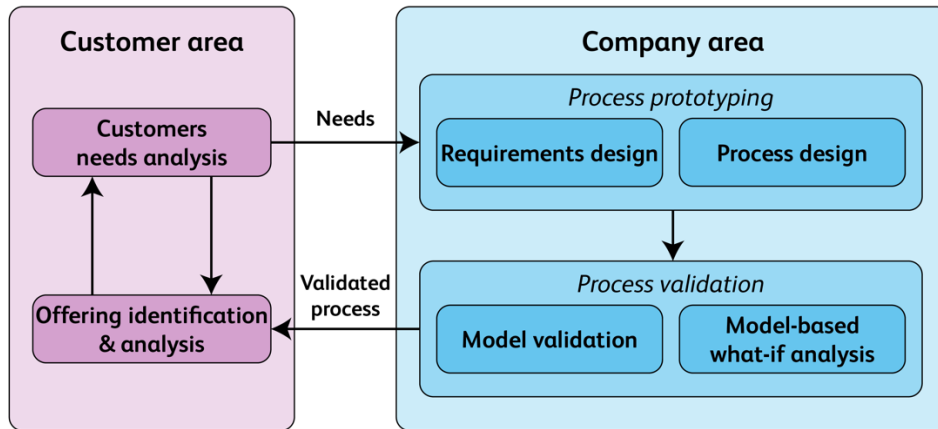

Figure 7: The Service Engineering Methodology (SEEM) (Pezzotta et al., 2016) (Illustration by Kodel Bahram)

As shown in Figure 7, the first two phases belong in the customer area, while the remaining two address the company area. Customer needs analysis is based on the customers' needs and outcomes (expressed or not expressed), analyzed through feedback and complaints analysis (if an offer already exists), market research, interviews, focus groups, or more innovative tools such as sentiment analysis. In addition, the customer journey map can be a useful tool to highlight all the client's decision-making moments and all the interactions between client and company. Process Prototyping includes: the generation of the concept, the evaluation and selection of the concept to be added in the value proposition and, finally, the delivery process's design. In this phase, the Product Service Concept Tree (PSCT) (Rondini et al., 2016), is used, which is based on the principles of design thinking. The purpose of this tool is to support the analysis of customer needs, defining the relationship between customer needs and provider's resources. The PSCT in Figure 8 is presented as a tree consisting of four hierarchically arranged levels: needs (N), wishes (W), solutions (S), and resources (R).

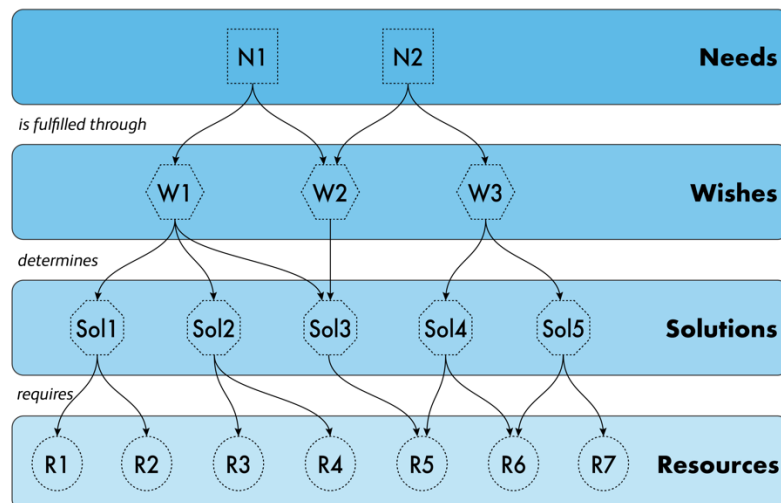

Figure 8: Product Service Concept Tree (PSCT) (Illustration by Kodel Bahram)

The solutions defined are evaluated using the Engineering Value Assessment (EVA) (Rondini, Bertoni, and Pezzotta, 2020) a MCDM approach to support the selection of the most suitable solution(s) to be added to the company offer. This phase represents one of the most critical aspects to date for manufacturing companies that tend to develop services without having analyzed in detail which are the most appropriate.

Once selected, the solution is designed in detail. Product and service design activities will follow separate paths by staying connected thanks to the work done in these preliminary phases. In

particular, product design will follow the traditional approaches already available in most companies, while for the service the design is based on the definition of possible alternative delivery processes. The method proposed to describe the delivery process is Service Blueprinting. In re-engineering, this phase involves mapping the existing process (if any) and identifying possible alternatives for improvement.

Process validation assesses the performance of the alternative service delivery processes previously designed, as well as identifying the most suitable process and its best resource configuration. To this end, SEEM adopts a process simulation approach (e.g., DES, ABS, hybrid approaches), since it allows for the dynamic analysis of a system (the service process, in our case) under different conditions and scenarios.

Offering/value proposition identification and analysis is a post-launch confirmation of market acceptance. KPIs are defined to monitor its performance, to have an effective and efficient value proposition with close market fit. The analysis carried out in this phase can then be used to start a new design or re-engineering process.

**Case: Low voltage breakers as a PSS**

This application deals with re-engineering the actual product-related service portfolio of a company operating low voltage breakers. The rationale behind this decision is threefold. Firstly, more than fifty service-related employees are working in the service delivery process, making it difficult for the service manager to assess how balanced it is. Secondly, the product-related service portfolio is complex, redundant, and not aligned with real customer needs due to the company's traditional product and technological orientation. Finally, the customer segments are highly diversified.

**Customer area: customer needs analysis and company service portfolio**

The initial step of the SEEM application has been about the identification of the main customer needs and the analysis of the company service portfolio. Two customer types have been identified as the most relevant for the service offerings:

- *Customers type I:* are those that trust company capabilities to maintain their installed base in a good operating condition.
- *Customers type II:* are those that directly take care of their installed base maintenance, and only resort to company support for complex service jobs and for spare parts.

Both of these customer types share the same need: maximize availability.

Currently, 90% of the revenues of the company's BU service is based on the following offering:

- *Preventive and corrective maintenance,*
- *Replacement,*
- *Retrofit,*
- *Spare parts provision.*

From this analysis, it has been decided that the focus of the re-engineering task performed in the next two phases of the methodology should be on both customer types and the four service products.

**Company area: Process prototyping**

The process prototyping phase uses the customer needs identified in the first step, as an input to define the service delivery process. The first SEEM task is the definition of the process's main requirements. Starting from the main customer need – i.e., to maximize availability - the PSCT has been deployed. After the definition of the tree, the application of the EVA has been performed. The service delivery manager and customer interfacing engineers were responsible for assessing all the criteria considering the two customer categories' different behaviors towards achieving higher availability of their installed base. The result is aligned with the definition of the customer type I: if they want to perform the maintenance by their own, they will need a good training and a fast spare parts delivery. On the other hand, the customer type II, who relies entirely on the company, recognizes the importance of a proper definition of the contract terms and conditions and the service job.

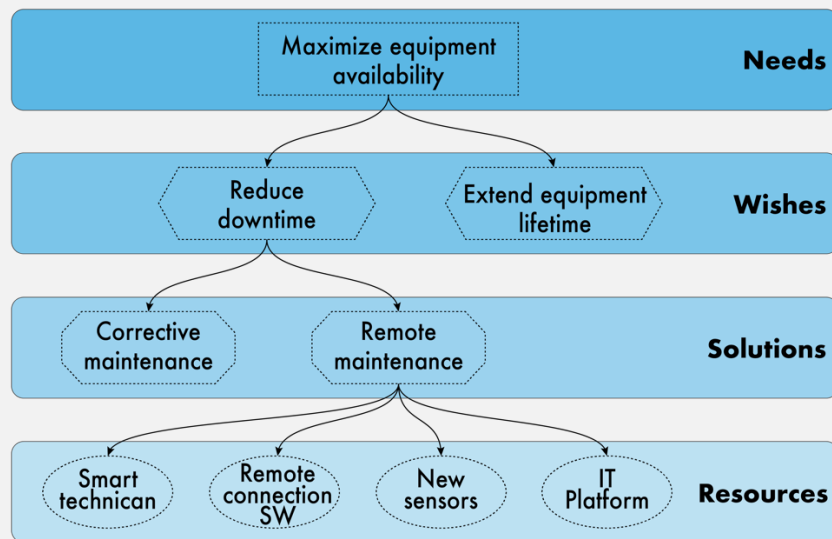

Figure 9: Short extract of the PSCT(Illustration by Kodel Bahram)

The second step in the process prototyping is the process design using the blueprinting methodology. Four service delivery blueprints have been drawn, one for each service offering analyzed. The set of activities identified (about 120 for each blueprint) are performed by either the customer, by front-end resources (e.g., proposal, onsite technicians), by backstage resources (order handlers, workshop technicians) or support processes (e.g., logistics, administration).

Once the service blueprinting maps were complete, a good static overview of the processes was available. No product changes have been required, so no product redesign has been proposed to the company product development team.

#### Process validation

In this case, the main goal of process validation is the assessment of the process's performance and the identification of the resource configuration that maximizes the tradeoff between customer satisfaction and internal efficiency, also considering the company future targets. To this purpose, SEEM suggests using simulation to develop a "what-if" analysis. Thus, considering the company predicted targets in its service business and a change in the offering composition, a "what-if" analysis has been carried out in order to understand how the current process ("AS-IS") would perform when the future targets are set. Based on these results, it would be possible to identify the best ("TO BE") configuration of the service delivery that ensures a proper balance between customer value and process performance.

In the simulation model, the *entities* are the customer requests for the different services and the *events* represent the process activities.

The main variables considered in the analysis were the following:

- Number of completed service jobs in one year for each kind of service,
- Lead time to complete a service job, split for the different services,
- Saturation of the resources.

For each kind of service, the improvement actions suggested in the scenarios helped in designing a new delivery process better able to answer changing customer needs in terms of the composition of the service offering and capturing the new trends. Thanks to the new configuration, the company defined a solution focused on reaching a higher customer satisfaction (measured in terms of Lead Time) and a proper resource utilization (lower than 80%).

#### 2.4.2 Extended Functional Analysis (FA) approach and application

As highlighted by the methodological scheme of Figure 10, the EFA framework covers design from contextual analysis of the PSS situation to support for solution industrialization. It has 5 main methodological blocks: PSS context & usage analysis; PSS external functional analysis; PSS internal functional analysis; PSS Detailed design; and PSS industrialization, which aim at designing the products, the services, and the economic model of the value network.

**The PSS context and usage analysis** embed activities related to the strategy and context analyses, as well as usage analysis. Standard approaches are used to capture these strategical insights, like SWOT and PEST (Political, Economic, Social and Technological analysis (Clulow, 2005)) analyses. As mentioned in the previous sections, this initial PSS contextualization is important before getting to the core of the design method. The usage analysis follows, to identify expectations and requirements for products and services, translating them into functionalities and service opportunities throughout the

product life cycle. From a larger stakeholders' point of view, usage analysis defines various PSS opportunities and the key value creation factors for all actors involved. The potential PSS functionalities resulting from this analysis can be broken down into primary and secondary usage functions to support the 'external functional analysis' of the PSS.

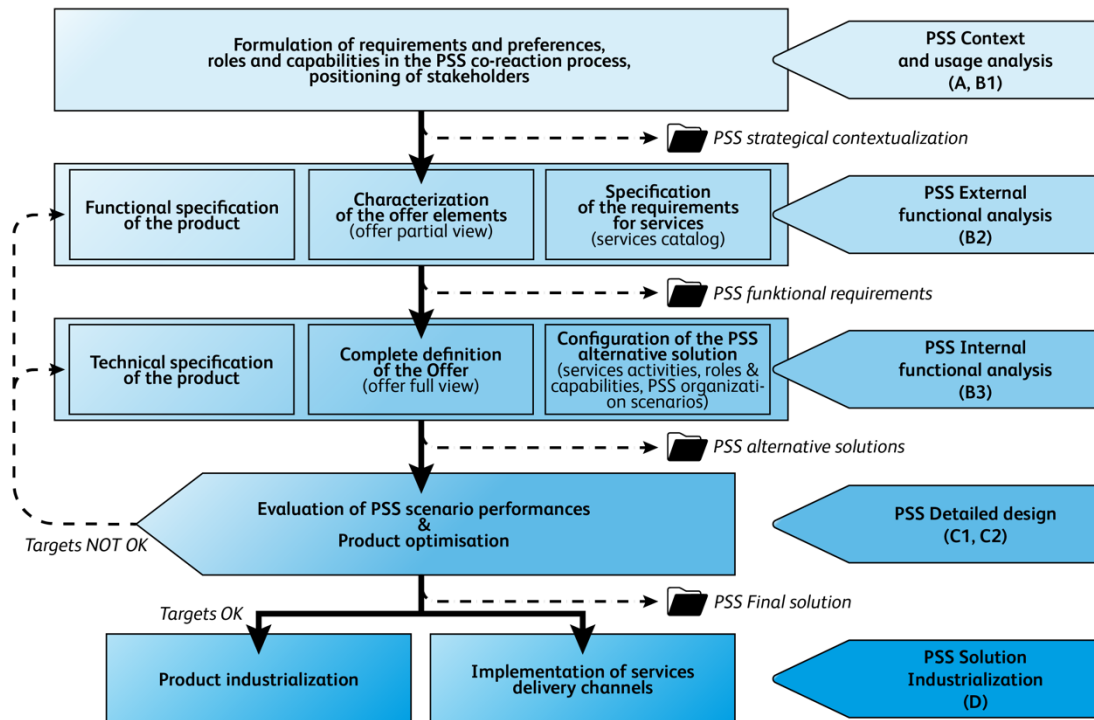

Figure 10: Extended Functional Analysis Framework (Andriankaja et al., 2018) (Illustration by Kodel Bahram)

**The PSS external functional analysis** is at the core of the PSS design process. This stage gathers all tasks required for both product and service offers. The usage analysis outcomes are on one side (tangible) transformed into technical functions and on the other side (intangible) transformed into service offer specifications. Service design starts with the 'service ideation' by identifying key service ideas from the product usage functions and exploring new service opportunities (creativity sessions) through the whole PSS life cycle. After exploring the organizational impacts vs. opportunities of service delivery for each PSS actor, service ideas are refined and specified in a 'catalog of service offers'. The value proposition is then characterized from an economic point of view by a first definition of the PSS global offer validated by the design team.

**The PSS internal functional analysis** stage completes the PSS design's functional phase by transforming product specifications into technical functions, and service opportunities into service activities. For product it is supported for the product by standard FA tools such as: SADT, FAST or FBD models. A specific PSS design tool developed for the EFA framework, the PS3M environment provides computer-based support for specifying services catalog, delivery activities, delivery scenarios and value offer structure. Thus, PS3M is used by the design teams to build a full specification of the whole PSS offer.

**The PSS detailed and quantitative design** stage covers quantitative analysis of expected performances and progressive decision-making on selecting the PSS delivery chain for implementation. On the product side, detailed design is executed with the usual tools, and the product's technical performance parameters are characterized. In parallel, the PSS delivery scenario has to be assessed. This starts with prioritizing key PSS delivery scenarios to reduce the scope of the subsequent

quantitative evaluation. A contextualized simulator is built to evaluate performance and compare delivery scenarios, aiming to consolidate performance evaluation with the customer’s objectives. This simulator is built by customizing a generic PSS simulation platform (PS3A platform). Third, using this contextualized simulator, performance analysis on alternative PSS delivery scenarios identifies the most effective performance drivers and looks for trade-offs among various value chain actors, including the customers.

**The industrialization of PSS solution** deals with the deployment of product manufacturing processes, as well as the concrete implementation of service delivery solutions and integrating the value network. The industrialization decision-making consists of company-oriented operational decisions. The EFA Framework does not include specific tools to perform this post-design process. Nonetheless, it seems crucial that companies make sure that they can complete the implementation and market launch.

**Case: Industrial Autonomous Cleaning Robot**

The case study focuses on the qualitative design stage of both the robot and the service opportunities for characterizing the PSS offer specifications, then on the assessment of the PSS delivery scenario to help decision-making for industrialization. The key customers for the PSS under design are in the meat transformation industry, facing increasing international competition as well as evolving hygiene standards. Industrial cleaning should benefit from innovative solutions to increase the cleaning process's efficacy. The PSS will be implemented within a French meat transformation enterprise (E1) to clean cold storage warehouses. The adoption of PSS thinking is motivated by a desire to unleash the potential of high-added value solutions coupling robotics with service. The innovation consortium involves 3 industrials: a medium-sized company from the meat industry (E1), a small-sized company manufacturing special machines including robotics and providing customized solutions (E2), a small-sized company manufacturing batteries (E3). Only some results of the 3 main phases of EFA framework are underlined.

**PSS external functional analysis**

This phase of the design methodology led to lots of results. The definition of the PSS requirements is customer-driven as it stems from the customer expectations identified during context and usage analysis. PS3M is a modelling design tool, with ‘PS3M function hierarchy view’, in which the external FA of the robot and the PSS usage services identification are performed following the Functional Hierarchy Modelling (FHM) principles adapted from (Van Ostaeyen et al., 2013). The decisions about technical functions relating to the product part of the PSS are impacted by service ideas and vice versa, resulting in a functional analysis tree that mixes both technical and service functions.

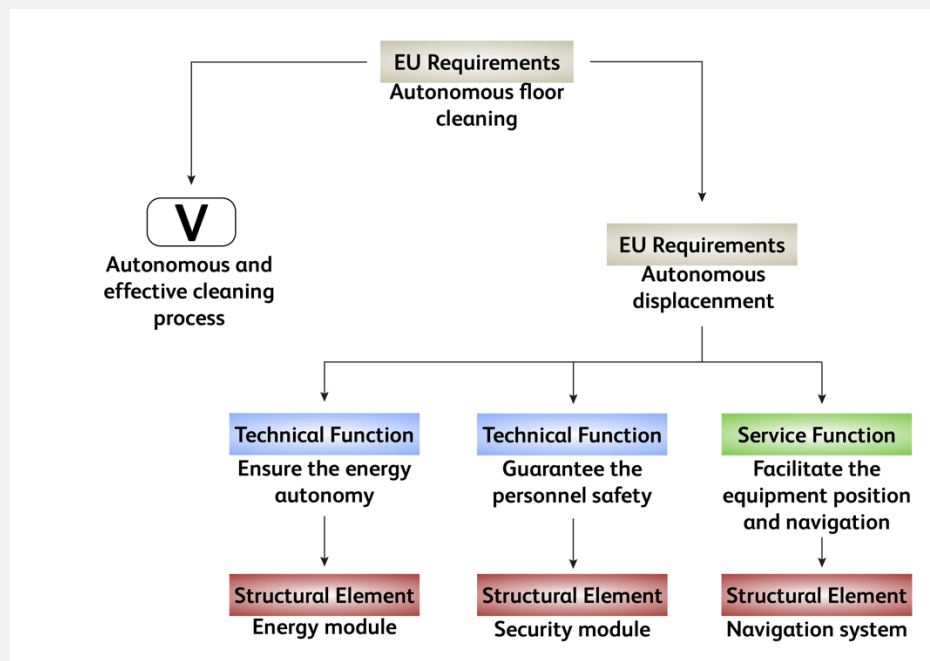

Figure 11: PS3M hierarchy modelling view(Illustration by Kodel Bahram)

Service opportunities are defined using a generic service opportunity typology which covers the full PSS lifespan. A creativity session brings together the PSS project team to identify pertinent service ideas, which could maximize the value of the robot throughout the whole PSS usage scenario. The refined services are then a ‘Service catalogue’ characterizing service opportunities by the key required competencies, indicia or priority and deployment time horizon (Andriankaja,

Boucher, and Medini 2018). This service catalogue is the input to go one step further for specifying offer selling modes. In the case of the PSS design 3 complementary value propositions:

- i. A *product-oriented contract*, where the customer buys the robot while the PSS provider offers and charges after-sales services (significant revenue from the robot usage for the PSS provider).
- ii. A *user-oriented contract*: where the robot is owned by its manufacturer who sells the use of the robot by a leasing or renting contract to the customer. The robot usage lifecycle can be extended and multiple customers served. The high availability of the robot(s) becomes a key factor.
- iii. A *result-oriented contract*: the robot manufacturer sells the cleaning activity, with a mix of services provided by several stakeholders, while the PSS provider maintains the ownership of the robot and the customer pays only for the cleaning services.

### The PSS internal functional analysis

Using PS3M as a modelling tool, the three offerings are further specified during the internal functional analysis, by defining a structured model of each offer (including first specification of contractual elements), then by defining a delivery scenario representing the value networks to be implemented for each of these offers. Such scenarios gather the key pieces of design knowledge from the previous steps. Figure 12 displays an example of this scenario.

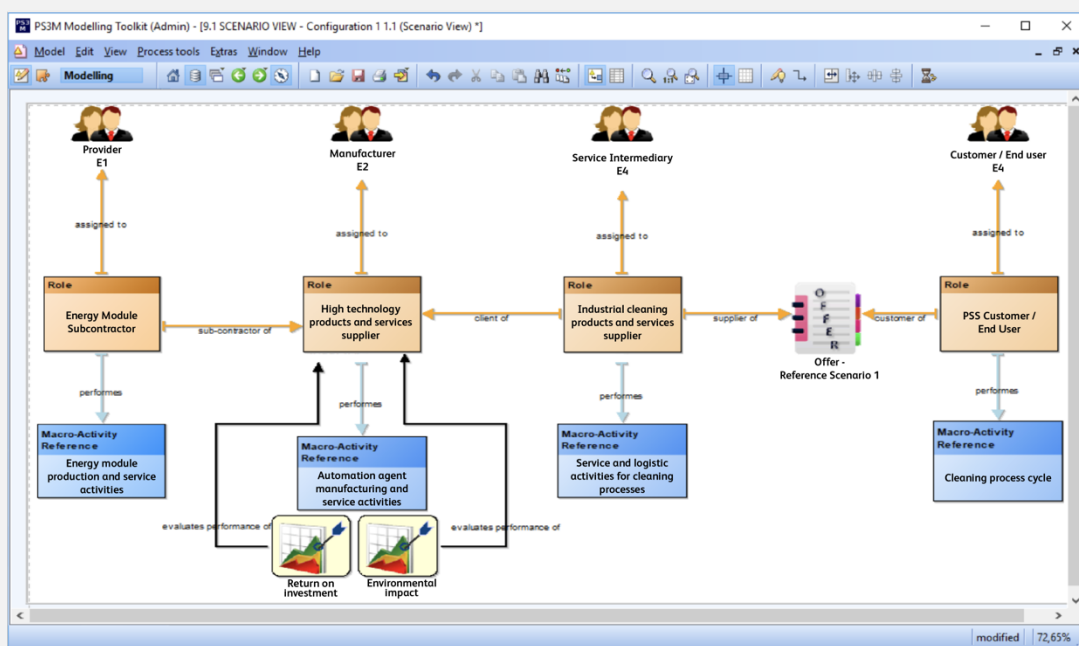

Figure 12: Graphical representation of delivery scenario with PS3M (Illustration by Kodel Bahram)

### PSS detailed and quantitative design

As displayed in Figure 12, each scenario corresponds to a specific offer associated with a specific economic model for the stakeholders and specific responsibilities and activities (roles) for the actors. Behind the graphical representation, the model includes all the economic factors making it possible to evaluate quantitatively the comparative performance of these scenarios. Using the EFA simulation platform, a simulator was built dedicated to this PSS design, which led to interesting conclusions of the various scenarios. A full comparative analysis of all alternative scenarios was developed to study uncertainty factors and their impact on economic results (Boucher and al., 2019) and to provide recommendations to decision-makers. In this specific context, comparing the alternative scenarios along a period of ten years, the simulation highlighted the economic advantage of moving from the usual product-oriented model towards a user-oriented PSS for both providers E2 and E3, while the customer E1 maintains an economic advantage with their current cleaning process

## 2.5 Transition from PSS towards Smart PSS

The growing interest in the digital transformation of manufacturing firms has raised academic interest on incorporating tech-based research into traditional PSS areas of investigation (Lee and Lee 2019). In this context, Smart PSSs, defined as “IT-driven value co-creation business strategy consisting of various stakeholders [...], intelligent systems [...], smart, connected products [...], and their generated services [...] that continuously strives to meet individual customer needs in a sustainable manner” (Lerch and Gotsch, 2015) express the most recent manifestation of digital technologies integration into products and services (Zheng et al., 2019). The paper by Zheng et al., (2019) is in alignment with the

earlier work of Porter and Heppelmann (2014), who provided a five-step model from pure product to system-of system (Figure 13).

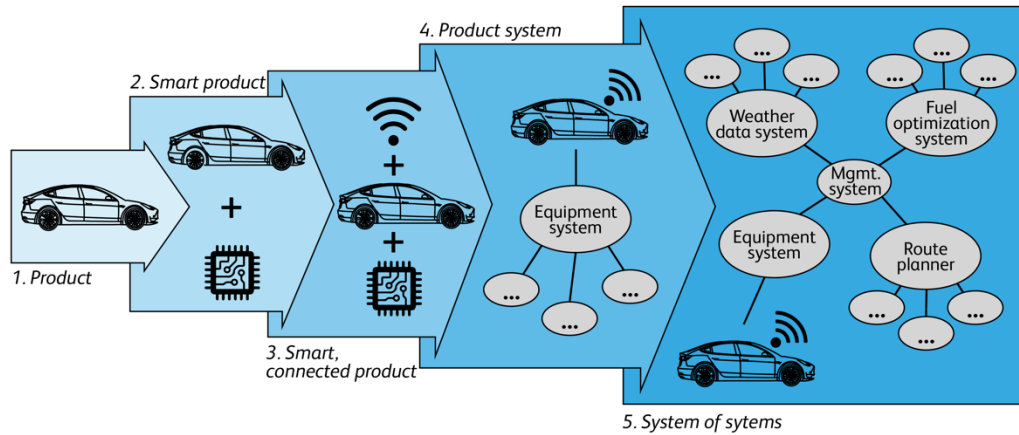

Figure 13: Connected products within complex systems creating a new perspective of PSS (based on Porter and Heppelmann, 2014) (Illustration by Kodel Bahram)

As described in recent state of the art (Pirola et al., 2020), the role played by technological innovation is supporting the evolution of Smart PSSs, which can be depicted as:

- i. Value offering manifestation,
- ii. Customer value manifestation,
- iii. Value creation interaction,
- iv. Technology capabilities.

### 2.5.1 Value offering manifestation

Advanced technologies promote the creation of new forms of product-service value propositions. The transformation of data into information and knowledge enhances the development of different Smart PSSs (Ardolino et al., 2017; Hartmann et al., 2016). In particular, according to Allmendinger and Lombreglia (2005), the adoption of data-driven technologies supports manufacturing companies to expand and complement their offerings by developing advanced services. For instance, technology improves the visibility of the asset in use in terms of operating conditions, improving maintenance and repair activities, or providing opportunities for operational support activities. This can then feed back to the Beginning Of Life (BOL) and enhance equipment design and operation behavior while reducing, at the same time, service delivery costs (Lightfoot, Baines, and Smart, 2011). This approach can be accompanied by, or substituted for a different logic, where adding intelligence and communication into the products allows service providers to expand their business opportunities, by offering broader high-value activities.

In the agricultural machinery sector, precision farming systems not only ensure the minimization of vehicles' travels, but also to optimize herbicide and fertilizer yield. Tracking of vehicle position in real-time, integrated with information about mission, allows the system to assist the driver to set the best vehicle trajectories and automatically configure the fertilizer dosage according to the soil conditions. In the automotive industry, installing a black box to record all events by associating them to the external and/or vehicle conditions as well as driving style, allows the creation of targeted insurance policies. In some cases, data collected can be sold to insurance companies, instantly monetizing the information.

### 2.5.2 Customer value manifestation

Researchers and experts agree that easy access to real-time information provides the opportunity to develop a better understanding of customer behavior, easing the development of new PSS. Nevertheless, as technological innovation accelerates, it becomes possible to deliver original,

customized service solutions that meet new customer needs and expectations (Marilungo et al., 2017; Huang, 2014). In addition, thanks to the adoption of innovative technologies, products and services become proactive smart entities able to anticipate customer needs through new complementary value-added services (Wuest et al., 2018), thus overcoming co-design methods that are generally implemented to develop innovative PSS addressing multiple customer requirements.

A clear example comes from business mobility, in particular from sharing services. Here the use of technology not only facilitates the process of service booking, purchase, and payment, as well as the traceability and management of each vehicle, but also allows customer profiling in time and space. This makes it possible to create "ad hoc" solutions according to different customer needs, styles, and profiles. For instance, a bike sharing service proposed by Piaggio becomes a powerful tool that the Italian company adopts to deliver customized services based on each individual's experience of the city, which change throughout the day, week or year and depend on needs and wishes concerning work, family, home, health, culture, sport and the environment. Similarly, in the world of communication equipment, information panels, television sets and monitors are transformed from passive to dynamic information tools, which change their role according to people's needs. Then a monitor moves from being an advertising screen to an information totem, while a television set is transformed from an entertainment tool to an agenda for the planning of work, family, and health activities.

### 2.5.3 Value creation interaction

Comprehensive information sharing and coordination enhanced by technologies supports the development of new forms of PSS based on cooperation (Auramo and Ala-risku, 2005) (Martinez et al., 2010) and leads to value co-creation (Baines et al., 2017; Benedettini, Neely, and Swink, 2015). In particular, platforms interconnecting products and actors are adopted to simplify the information flow within the ecosystem and enhance knowledge sharing among all the service actors involved (Sakao, Öhrwall Rönnbäck, and Ölundh Sandström, 2013; Selviaridis and Norrman, 2014). The availability of information opens up new forms of competition, where actors from sectors not necessarily similar, but converging for the same interest in technology, develop strategies of cooperation rather than competition. In this sense, thanks to technological innovation, linear PSS configuration characterized by transactional relationships, moves towards sophisticated non-hierarchical networks organized around shared relationships (Y. Liu and Xu, 2016).

Google and Volkswagen have recently signed a joint research in the field of quantum computing, aimed at improving machine learning systems for traffic management. Similarly, CNH Industrial and Microsoft have reached an agreement to redefine the world of connected industrial vehicles. This has resulted, on the one hand, in a new integrated platform for simplified access to vehicle data and, on the other, in the development of a mixed reality tool to facilitate remote maintenance.

### 2.5.4 Technology capabilities

Technological infrastructures embody a key point to support integrating products and services in a "system management" perspective (Park, Geum, and Lee, 2012). Although current literature recognizes technology as a fundamental enabler of Smart PSSs, it fails to provide a unique model able to identify the best set of technologies that can ease such a journey. Therefore, the selection of suitable technological infrastructure emerges as essential to support Smart PSS implementation (Grubic and Jennions, 2017). In this perspective, the identification of technological capabilities supporting PSSs at the different phases of the product-service life cycle becomes fundamental. In particular, the progressive intensification of collaboration between partners driven by Smart PSS implies the development of open technological infrastructures, based on shared standards and interoperability protocols. These are necessary to ensure information sharing and exchange among all product and actors operating in the value chain, in order to meet market demands (Thoben et al., 2017).

In the heavy transport industry this transformation is already taking place even if in an embryonic phase. MAN, a German company belonging to the Volkswagen group, leader in the heavy transport sector, has recently improved its exposure to the digital market by developing a partnership with RIO

Cloud, a marketplace that allows customers to manage vehicle-related information through a single platform. This is a first example of the creation of a virtual cloud ecosystem that, through an integrated digital platform adopting common standards, allows all actors to connect virtually, balancing contractual power of involved users, customers, IT solution providers and vehicle producers.

## 2.6 PSS, digitalization and smartness

Product-Service-Systems are intrinsically linked to digitalization, in the sense that selling a product as a service induces change from a transactional model towards a relational economic model. Here, the management of the relationship with the customer becomes central in the process of service-oriented value creation. However, in the first generations of PSS, this was not necessarily embedded in the product itself. The transition from PSS towards Smart PSS consists of three steps:

- i. profoundly extending the digital capabilities of PSS systems along the whole life cycle of the system from a passive provision to active digital services, increasing the added value along the entire lifecycle.
- ii. embedding part of the data treatment chain on-board on the physical product with capacities of interoperability with its environment.
- iii. broadening the digital added value to various stakeholders.

To understand Smart PSS, it is important to question the notion of smartness. Unfortunately, 'smart systems' are still not fully defined. The notion of smartness has been rarely analyzed scientifically. Romero *et al.*, (2020) consider that Smart Systems "*can be considered as systems that are able to update their internal knowledge used for reasoning to make optimum decisions. For this purpose, Smart Systems must have the capability to continuously perceive the environment and to control it, and to allow communication between their elements*". They identify six key characteristics of smart systems as intrinsic capabilities: communication capability; embedded knowledge; learning capability; reasoning capability; perception capability; and control capability. Two properties are considered as results: self-organization and context-awareness. Not all of the components necessary to implement such smartness need to be embedded on the product but can be distributed both on the product and in its environment, making it necessary to generalize interoperability.

Consequently, considering smartness for PSS makes us consider on the one hand the extension of the digital capabilities of the system under development to include smart characteristics and, on the other hand, to transform these basic capabilities into new value offers along the life cycle. This means that the design process for Smart PSS requires new advances: (i) systematically manage all digital development associated with product and service delivery, but also (ii) create new forms of digitally-based value exchanges.

## 2.7 Implications for design methods

The complexity of PSS offers generates a complexity of design processes and methodology, however, the three following orientations highlight three key considerations:

- the need for a strongly integrated design process,
- the pre-eminence of value-driven design,
- the importance of considering smartness at all levels of the design.

### 2.7.1 Integration of the design process

Integrated design is usual in product design, embedding various technical areas of a complex product (mechanical, electronics, automatics, ...), as in a typical example of mechatronics. However, PSS design requires an even higher level of integration by the necessity to involve three key conceptual areas of system design: products, services, and value networks. Value Network design requires innovative methodologies oriented on value capture, and value channel configuration, as well as economic model calibration: this requires an important transformation of firms' internal design skills (Andriankaja, Boucher, and Medini, 2018). This integrated PSS design process is now relatively well-known and structured (Andriankaja *et al.*, 2018; Cavalieri and Pezzotta, 2012). This makes it possible

to address a fourth dimension of the integration: time. PSS and Smart PSS designs must respect the lifecycles of the full system solution, with an intricate interlacing among product lifecycles and service lifecycles. This allows the integration of design-oriented Decision-Support-Systems (DSS) that can address the various stages of the lifecycles, with consistent interoperability (Haber, Fagnoli, and Sakao, 2020), which should encompass the three key conceptual dimensions of PSS design mentioned above, namely products, services, and value networks.

### 2.7.2 Value-driven design methodologies

Value-driven design starts with the methodologies to capture and analyze value expectations from the customers. Most PSS design methods include Design Thinking approaches to capture and understand the articulated and unarticulated customer expectations for PSS requirements. The notion of value itself has to be enlarged, to cope with several non-economical dimensions, including ecological, societal, information or relational impacts of the PSS solution (C.-H. Lee, Chen, and Trappey, 2019; Pirola et al., 2020). Existing Smart PSS Design and Engineering approaches commonly use design-thinking tools like customer journey mapping and customer personas (C.-H. Lee, Chen, and Trappey, 2019; Z. Liu et al., 2019), helping to manage low-structured, uncertain and evolving 'value expectations' from the customers and stakeholders. However, beyond value capture, two crucial issues should also be addressed: the design of a value delivery system, and the balance of value sharing mechanisms among stakeholders. The design of the value system includes modeling and integrating the value flows among all the actors of the delivery chains. Designing value-sharing mechanisms addresses the distribution of risks amongst the actors of the PSS value network, with Decision Support Systems helping to ensure win-win conditions for all actors involved in the delivery of the Smart PSS solution.

### 2.7.3 Smartness considerations

Even if the digital functionalities linked to product lifecycle are intrinsic to PSS, the transition towards Smart PSS induces a systematic integration of embedded and interoperable digital capabilities in the solution. This high-level Product/IT integration opens new ways to contribute to service delivery and broaden the potential and variety of value offerings. For design methodologies and decision-supporting tools, this means the necessity to consider smartness at all levels of the design (Pirola et al., 2020), whereas with PSS the integration of products and services has been managed without considering all the implications of smartness. Smartness has to be anticipated in the very early design phases of value expectation capture and analysis, followed by service ideation. Smartness should be considered through its specific digital risks along all the design process. Smartness requires the analysis of the economic implications of data-value for the actors in the value chain (data monetization). Smartness opens the opportunity to design innovative ways to manage PSS delivery and PSS life-cycles, providing performance and value management support systems for all the stakeholders. Designers' skills and methods should evolve to address all these features.

Managerial literature underlines the existence of several challenges concerning successful PSS engineering applications. To the evident difficulty of capturing changing customer needs, which are generally vague due to unexpressed needs related to complex contexts, are added other aspects, mainly related to the complexity of the PSS delivery process. The latter is characterized by ecosystems consisting of a large constellation of different stakeholders and by difficulties in developing effective revenue models, often quite difficult to monetize due to a higher influence of service components and uncontrollable risks. Such complexity leads to ambiguous situations that lead to the development of conflicting ecosystems. Consequently, there is a clear need to develop a formal structured approach to guide decision-makers and designers to effectively engineer Smart PSS solutions.

## **2.8 Methods for Smart PSS design**

The growing diffusion of technology into PSSs has called for a rethinking of both logic and design methods. In particular, as highlighted by Pirola et al., (2020) and outlined in Figure 14, this evolution has concerned two main directions. On the one hand, research emphasis has been placed

on the output (PSS), with the aim of developing new methods capable of capturing its smart perspective. On the other hand, studies have been focused on the development of smart enabled methods, to seize the opportunities offered by technology to create more efficient and effective PSSs, regardless of their level of smartness.

However, as underlined by literature, most of the work currently available for Smart PSS design is based upon approaches, methods and tools very similar to those already used for traditional PSSs, except for minor changes. Conversely, simulation (Medini et al., 2015; Rondini Alice et al., 2017; Wibowo, Tjahjono, and Tomiyama, 2017) and, more recently, digital twins (Loizou et al., 2019; Schroeder et al., 2016) are increasingly being used to facilitate decision-making and the development of the main PSS components. Finally, it emerges that new technologies are also used to improve the design of traditional PSSs. In particular, several studies have recently proposed using the Internet of Things (IoT) to capture customer behaviors (Hara, 2018; Kammerl et al., 2016), while Machine Learning and Artificial Intelligence have been recommended to collect and integrate customer feedback (Neves-Silva et al., 2016), supporting data and information transformation into knowledge and wisdom (Abramovici et al., 2018; Chowdhery and Bertoni, 2018), in order to build PSS solutions suited to distinctive market features.

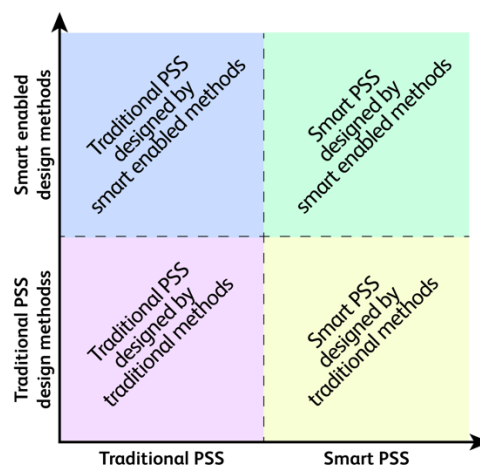

Figure 14: PSS design evolution (Source (Pirola et al., 2020)) (Illustration by Kodel Bahram)

Among different methodologies proposed to enhance the design of Smart PSS, (Coba et al., 2020) is the introduction of a risk-oriented methodological framework to support the development of effective PSS engineering activities. Based upon the integration of Design Thinking, Systems Engineering, and PSS prototyping, the framework consists of five methodological blocks (Elicitation of stakeholder needs; Prototype of the general value concept; Prototype of the detailed value concept; Experimental prototyping of the Smart PSS solution; and Simulation of the PSS value network scenarios) developed around three main principles:

- i. Iterative prototyping of Smart PSS – the Smart PSS solution is tested and validated throughout the whole engineering process, following a structured but flexible process. Cost analysis and risk management activities are incorporated in the activities of the blocks to assure the financial success of the Smart PSS concept in the market.
- ii. Risk management along the design process – risks are identified, characterized, assessed, and monitored continually, to guide decision-makers in deciding whether to continue/reformulate the Smart PSS development.
- iii. Economic value-sharing risk modelling and assessment – economical risk-share distribution amongst the actors of the Smart PSS value network is represented, to ensure win conditions for actors involved in the delivery of the Smart PSS solution. This can be in the form of risk-reward outcome focused revenues or embedded risks that are implicit to the value proposition and its revenue model.

From establishing of stakeholder's expectations to the evaluation of PSS delivery value networks, the engineering process is structured by the five methodological blocks of the framework (Figure 15) and makes various iterative design loops, depending on the risks identified along the process.

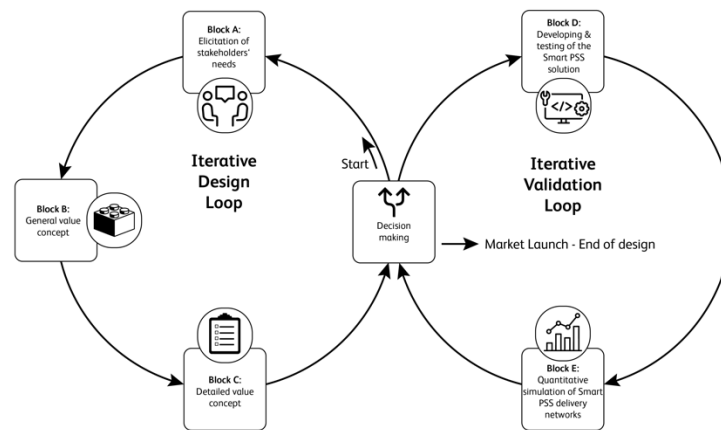

Figure 15: Smart PSS engineering framework (Coba et al., 2020,) (Illustration by Kodel Bahram)

### 3 Concluding remarks

The potential economic-financial advantages arising from the integration of products and services explain why, in recent years, the industrial world has been characterized by an acceleration of the servitization phenomenon, highlighted by the growing interest in PSS. Combining product and service components allows a growth strategy, even in mature sectors, increasing market penetration through a longer and deeper contact with customers. Recently, the dynamics at the basis of this path have been further articulated by the increasing integration of technology in the PSS, leading to a growing interest in developing digital servitization strategies, which correspond to numerous operational, marketing and business benefits.

Although research has, over the years, promoted several methods and methodologies to support the engineering of PSS, the design of win-win solutions is not so obvious. Indeed, empirical cases evidence that successful PSS engineering requires a multi-perspective and multidimensional vision, calling companies to develop suitable organizational structures and governance approaches. Nevertheless, even though in recent years many companies have started to develop (digital) servitization strategies through (smart) PSS, the concept still remains distant from many realities, especially SMEs. Therefore, a complete rethinking of operational processes and organization structures, as well the development of suitable skills and competences focused on PSS engineering, become a prerequisite for organizations to develop and implement in a systematic way with effective methods and methodologies for PSS design and engineering.

### References

- Abramovici, Michael, Philip Gebus, Jens Christian Göbel, and Philipp Savarino. 2018. 'Semantic Quality Assurance of Heterogeneous Unstructured Repair Reports'. *Procedia CIRP*, 10th CIRP Conference on Industrial Product-Service Systems, IPS2 2018, 29-31 May 2018, Linköping, Sweden, 73 (January): 265–70. <https://doi.org/10.1016/j.procir.2018.03.334>.
- Adrodegari, Federico, Andrea Alghisi, Marco Ardolino, and Nicola Saccani. 2015. 'From Ownership to Service-Oriented Business Models: A Survey in Capital Goods Companies and a PSS Typology'. *Procedia CIRP* 30 (January): 245–50. <https://doi.org/10.1016/j.procir.2015.02.105>.

- Allmendinger, Glen, and Ralph Lombreglia. 2005. 'Four Strategies for the Age of Smart Services'. *Harvard Business Review*, 1 October 2005. <https://hbr.org/2005/10/four-strategies-for-the-age-of-smart-services>.
- Andriankaja, Hery, Xavier Boucher, and Khaled Medini. 2018. 'A Method to Design Integrated Product-Service Systems Based on the Extended Functional Analysis Approach'. *CIRP Journal of Manufacturing Science and Technology* 21 (May): 120–39. <https://doi.org/10.1016/j.cirpj.2018.02.001>.
- Ardolino, Marco, Mario Rapaccini, Nicola Saccani, Paolo Gaiardelli, Giovanni Crespi, and Carlo Ruggeri. 2017. 'The Role of Digital Technologies for the Service Transformation of Industrial Companies'. *International Journal of Production Research* 56 (6): 2116–2132. <https://doi.org/10.1080/00207543.2017.1324224>.
- Auramo, Jaana, and Timo Ala-risku. 2005. 'Challenges for Going Downstream'. *International Journal of Logistics* 8 (4): 333–345. <https://doi.org/10.1080/13675560500407358>.
- Baines, T. S., H. W. Lightfoot, S. Evans, A. Neely, R. Greenough, J. Peppard, R. Roy, et al. 2007. 'State-of-the-Art in Product-Service Systems'. *Proceedings of the Institution of Mechanical Engineers, Part B: Journal of Engineering Manufacture* 221 (10): 1543–1552. <https://doi.org/10.1243/09544054jem858>.
- Baines, Tim, Ali Ziaee Bigdeli, Oscar F. Bustinza, Victor Guang Shi, James Baldwin, and Keith Ridgway. 2017. 'Servitization: Revisiting the State-of-the-Art and Research Priorities'. *International Journal of Operations & Production Management* 37 (2): 256–78. <https://doi.org/10.1108/IJOPM-06-2015-0312>.
- Behara, Ravi S., and Richard B. Chase. 1993. 'Service Quality Deployment: Quality Service by Design'. In *Perspectives in Operations Management: Essays in Honor of Elwood S. Buffa*, edited by Rakesh K. Sarin, 87–99. Boston, MA: Springer US. [https://doi.org/10.1007/978-1-4615-3166-1\\_5](https://doi.org/10.1007/978-1-4615-3166-1_5).
- Benedettini, Ornella, Andy Neely, and Morgan Swink. 2015. 'Why Do Servitized Firms Fail? A Risk-Based Explanation'. *International Journal of Operations & Production Management* 35 (6): 946–79. <https://doi.org/10.1108/IJOPM-02-2014-0052>.
- Bertoni, Marco, Giuditta Pezzotta, Beatrice Scandella, J. Wall, and P. Jonsson. 2019. 'Life Cycle Simulation to Support Cross-Disciplinary Decision Making in Early PSS Design' 83: 260–65. <https://doi.org/10.1016/j.procir.2019.03.138>.
- Boehm, Matthias, and Oliver Thomas. 2013. 'Looking beyond the Rim of One's Teacup: A Multidisciplinary Literature Review of Product-Service Systems in Information Systems, Business Management, and Engineering & Design'. *Journal of Cleaner Production* 51 (July): 245–60. <https://doi.org/10.1016/j.jclepro.2013.01.019>.
- Boucher, Xavier, and Sophie Peillon. 2015. 'Diagnosis of Servitisation Potential Proposal of a Strategic Diagnosis Framework Dedicated to SME'. In . Kyoto, Japan.
- Bullinger, Hans-Jörg, Klaus-Peter Fähnrich, and Thomas Meiren. 2003. 'Service Engineering—Methodical Development of New Service Products'. *International Journal of Production Economics, Structuring and Planning Operations*, 85 (3): 275–87. [https://doi.org/10.1016/S0925-5273\(03\)00116-6](https://doi.org/10.1016/S0925-5273(03)00116-6).
- Cavaliere Sergio, and Pezzotta Giuditta. 2012. 'Product–Service Systems Engineering: State of the Art and Research Challenges'. *COMPUTERS IN INDUSTRY* 63 (4): 278–88. <https://doi.org/10.1016/j.compind.2012.02.006>.
- Chowdhery, S.A., and M. Bertoni. 2018. 'Modeling Resale Value of Road Compaction Equipment: A Data Mining Approach'. *IFAC-PapersOnLine* 51 (11): 1101–6. <https://doi.org/10.1016/j.ifacol.2018.08.457>.
- Clulow, Val. 2005. 'Futures Dilemmas for Marketers: Can Stakeholder Analysis Add Value?' Edited by Michael Jay Polonsky. *European Journal of Marketing* 39 (9/10): 978–97. <https://doi.org/10.1108/03090560510610671>.
- Coba, Camilo Murillo, Xavier Boucher, Jesus Gonzalez-Feliu, François Vuillaume, and Alexandre Gay. 2020. 'Towards a Risk-Oriented Smart PSS Engineering Framework'. *Procedia CIRP* 93: 753–58. <https://doi.org/10.1016/j.procir.2020.03.054>.

- Exner, Konrad, Thomas Damerau, and Rainer Stark. 2016. 'Innovation in Product-Service System Engineering Based on Early Customer Integration and Prototyping'. *Procedia CIRP* 47 (January): 30–35. <https://doi.org/10.1016/j.procir.2016.03.084>.
- Fargnoli, Mario, and Nicolas Haber. 2019. 'A Practical ANP-QFD Methodology for Dealing with Requirements' Inner Dependency in PSS Development'. *Computers & Industrial Engineering* 127 (January): 536–48. <https://doi.org/10.1016/j.cie.2018.10.042>.
- Fargnoli, Mario, Nicolas Haber, and Tomohiko Sakao. 2019. 'PSS Modularisation: A Customer-Driven Integrated Approach'. *International Journal of Production Research* 57 (13): 4061–77. <https://doi.org/10.1080/00207543.2018.1481302>.
- Ferreira, Bruna, W. Silva, E. Oliveira, and T. Conte. 2015. 'Designing Personas with Empathy Map'. In *SEKE*. <https://doi.org/10.18293/SEKE2015-152>.
- Froehle, Craig M., and Aleda V. Roth. 2007. 'A Resource-Process Framework of New Service Development'. *Production and Operations Management* 16 (2): 169–88. <https://doi.org/10.1111/j.1937-5956.2007.tb00174.x>.
- Gaiardelli, Paolo, Barbara Resta, Veronica Martinez, Roberto Pinto, and Pavel Albores. 2014. 'A Classification Model for Product-Service Offerings'. *Journal of Cleaner Production* 66 (March): 507–19. <https://doi.org/10.1016/j.jclepro.2013.11.032>.
- Gebauer, Heiko, and Christian Kowalkowski. 2012. 'Customer-focused and Service-focused Orientation in Organizational Structures'. Edited by Thomas Brashear. *Journal of Business & Industrial Marketing* 27 (7): 527–37. <https://doi.org/10.1108/08858621211257293>.
- Goedkoop, Mark J. 1999. 'Product Service Systems, Ecological and Economic Basics', 133.
- Grubic, Tonci, and Ian Jennions. 2017. 'Remote Monitoring Technology and Servitised Strategies – Factors Characterising the Organisational Application'. *International Journal of Production Research*, 1–17. <https://doi.org/10.1080/00207543.2017.1332791>.
- Haber, Nicolas, Mario Fargnoli, and Tomohiko Sakao. 2020. 'Integrating QFD for Product-Service Systems with the Kano Model and Fuzzy AHP'. *Total Quality Management & Business Excellence* 31 (9–10): 929–54. <https://doi.org/10.1080/14783363.2018.1470897>.
- Hara, Tatsunori. 2018. 'Integrating Usage Information into Quality Function Deployment for Further PSS Development'. *Procedia CIRP*, 10th CIRP Conference on Industrial Product-Service Systems, IPS2 2018, 29-31 May 2018, Linköping, Sweden, 73 (January): 21–25. <https://doi.org/10.1016/j.procir.2018.03.323>.
- Hara, Tatsunori, Tamio Arai, and Yoshiki Shimomura. 2009. 'A CAD System for Service Innovation: Integrated Representation of Function, Service Activity, and Product Behaviour'. *Journal of Engineering Design* 20 (4): 367–88. <https://doi.org/10.1080/09544820903151715>.
- Hartmann, Philipp Max, Mohamed Zaki, Niels Feldmann, and Andy Neely. 2016. 'Capturing Value from Big Data – a Taxonomy of Data-Driven Business Models Used by Start-up Firms'. *International Journal of Operations & Production Management* 36 (10): 1382–1406. <https://doi.org/10.1108/IJOPM-02-2014-0098>.
- Hockerts, Kai. 1999. 'Innovation of Eco-Efficient Services: Increasing the Efficiency of Products and Services'. In . [https://doi.org/10.9774/GLEAF.978-1-907643-20-0\\_8](https://doi.org/10.9774/GLEAF.978-1-907643-20-0_8).
- Huang, Hui-Ling. 2014. 'Performance Effects of Aligning Service Innovation and the Strategic Use of Information Technology'. *Service Business* 8 (2): 171–95. <https://doi.org/10.1007/s11628-013-0192-z>.
- Kammerl, D., G. Novak, C. Hollauer, and M. Mortl. 2016. 'Integrating Usage Data into the Planning of Product-Service Systems'. In *2016 IEEE International Conference on Industrial Engineering and Engineering Management (IEEM)*, 375–79. Bali, Indonesia: IEEE. <https://doi.org/10.1109/IEEM.2016.7797900>.
- Kim, Sojung, and Byungun Yoon. 2012. 'Developing a Process of Concept Generation for New Product-Service Systems: A QFD and TRIZ-Based Approach'. *Service Business* 6 (3): 323–48. <https://doi.org/10.1007/s11628-012-0138-x>.
- Kowalkowski, Christian. 2016. 'Service Innovation in Industrial Contexts'. In *Service Innovation: Novel Ways of Creating Value in Actor Systems*, edited by Marja Toivonen, 235–49. Translational Systems Sciences. Tokyo: Springer Japan. [https://doi.org/10.1007/978-4-431-54922-2\\_11](https://doi.org/10.1007/978-4-431-54922-2_11).

- Lee, C.-H., C.-H. Chen, and A.J.C. Trappey. 2019. 'A Structural Service Innovation Approach for Designing Smart Product Service Systems: Case Study of Smart Beauty Service'. *Advanced Engineering Informatics* 40: 154–67. <https://doi.org/10.1016/j.aei.2019.04.006>.
- Lee, Sang M., and DonHee Lee. 2019. "'Untact": A New Customer Service Strategy in the Digital Age'. *Service Business*, September. <https://doi.org/10.1007/s11628-019-00408-2>.
- Lerch, Christian, and Matthias Gotsch. 2015. 'Digitalized Product-Service Systems in Manufacturing Firms: A Case Study Analysis'. *Research-Technology Management* 58 (5): 45–52. <https://doi.org/10.5437/08956308x5805357>.
- Lightfoot, H.W., T. Baines, and P. Smart. 2011. 'Examining the Information and Communication Technologies Enabling Servitized Manufacture'. *Proceedings of the Institution of Mechanical Engineers, Part B: Journal of Engineering Manufacture* 225 (10): 1964–68. <https://doi.org/10.1177/0954405411399019>.
- Lindahl, Mattias, Tomohiko Sakao, and Emma Carlsson. 2014. 'Actor's and System Maps for Integrated Product Service Offerings – Practical Experience from Two Companies'. *Procedia CIRP* 16 (January): 320–25. <https://doi.org/10.1016/j.procir.2014.01.030>.
- Liu, Yongkui, and Xun Xu. 2016. 'Industry 4.0 and Cloud Manufacturing: A Comparative Analysis'. *Journal of Manufacturing Science and Engineering* 139 (3): 034701–034701–8. <https://doi.org/10.1115/1.4034667>.
- Liu, Z., X. Ming, S. Qiu, Y. Qu, and X. Zhang. 2019. 'A Framework with Hybrid Approach to Analyse System Requirements of Smart PSS toward Customer Needs and Co-Creative Value Propositions'. *Computers and Industrial Engineering*. <https://doi.org/10.1016/j.cie.2019.03.040>.
- Liu, Z., X. Ming, and W. Song. 2019. 'A Framework Integrating Interval-Valued Hesitant Fuzzy DEMATEL Method to Capture and Evaluate Co-Creative Value Propositions for Smart PSS'. *Journal of Cleaner Production* 215: 611–25. <https://doi.org/10.1016/j.jclepro.2019.01.089>.
- Loizou, S., A. Elgammal, I. Kumara, P. Christodoulou, M.P. Papazoglou, and A.S. Andreou. 2019. 'A Smart Product Co-Design and Monitoring Framework via Gamification and Complex Event Processing'. In , 2:237–44.
- Manzini, E., and C. Vezzoli. 2003. 'A Strategic Design Approach to Develop Sustainable Product Service Systems: Examples Taken from the "Environmentally Friendly Innovation" Italian Prize'. *Journal of Cleaner Production*, Product Service Systems and Sustainable Consumption, 11 (8): 851–57. [https://doi.org/10.1016/S0959-6526\(02\)00153-1](https://doi.org/10.1016/S0959-6526(02)00153-1).
- Marilungo, Eugenia, Alessandra Papetti, Michele Germani, and Margherita Peruzzini. 2017. 'From PSS to CPS Design: A Real Industrial Use Case Toward Industry 4.0'. *Procedia CIRP* 64: 357–62. <https://doi.org/10.1016/j.procir.2017.03.007>.
- Matschewsky, Johannes, Mattias Lindahl, and Tomohiko Sakao. 2018. 'Capturing and Enhancing Provider Value in Product-Service Systems throughout the Lifecycle: A Systematic Approach'. *CIRP Journal of Manufacturing Science and Technology*, September. <https://doi.org/10.1016/j.cirpj.2018.08.006>.
- Medini, Khaled, and Xavier Boucher. 2016. 'Configuration of Product-Service Systems Value Networks – Evidence from an Innovative Sector for Sludge Treatment'. *CIRP Journal of Manufacturing Science and Technology* 12 (January): 14–24. <https://doi.org/10.1016/j.cirpj.2015.10.003>.
- Medini, Khaled, Sophie Peillon, Xavier Boucher, and Hervé Vaillant. 2015. 'Performance Measurement for the Design of Product-Service Systems'. In *Risks and Resilience of Collaborative Networks*, edited by Luis M. Camarinha-Matos, Frédérick Bénaben, and Willy Picard, 518–25. IFIP Advances in Information and Communication Technology. Cham: Springer International Publishing. [https://doi.org/10.1007/978-3-319-24141-8\\_48](https://doi.org/10.1007/978-3-319-24141-8_48).
- Meier, Horst, Oliver Völker, and Birgit Funke. 2010. 'Industrial Product-Service Systems (IPS2)'. *The International Journal of Advanced Manufacturing Technology* 52 (9–12): 1175–1191. <https://doi.org/10.1007/s00170-010-2764-6>.
- Mont, O. K. 2002. 'Clarifying the Concept of Product-Service System'. *Journal of Cleaner Production* 10 (3): 237–45. [https://doi.org/10.1016/S0959-6526\(01\)00039-7](https://doi.org/10.1016/S0959-6526(01)00039-7).

- Morelli, Nicola. 2006. 'Developing New Product Service Systems (PSS): Methodologies and Operational Tools'. *Journal of Cleaner Production*, Product Service Systems: reviewing achievements and refining the research agenda, 14 (17): 1495–1501. <https://doi.org/10.1016/j.jclepro.2006.01.023>.
- Neves-Silva, Rui, Paulo Pina, Philipp Spindler, Giuditta Pezzotta, Dimitris Mourtzis, Mariangela Lazoi, Dimitris Ntalaperas, and Ana Rita Campos. 2016. 'Supporting Context Sensitive Lean Product Service Engineering'. *Procedia CIRP* 47: 138–143. <https://doi.org/10.1016/j.procir.2016.03.103>.
- Park, Yongtae, Youngjung Geum, and Hakyoon Lee. 2012. 'Toward Integration of Products and Services: Taxonomy and Typology'. *Journal of Engineering and Technology Management* 29 (4): 528–45. <https://doi.org/10.1016/j.jengtecman.2012.08.002>.
- Peruzzini, Margherita, Eugenia Marilungo, and Michele Germani. 2015. 'Structured Requirements Elicitation for Product-Service System'. *International Journal of Agile Systems and Management* 8 (3/4): 189. <https://doi.org/10.1504/IJASM.2015.073516>.
- Pezzotta, Giuditta, Fabiana Pirola, Alice Rondini, Roberto Pinto, and Mohamed-Zied Ouertani. 2016. 'Towards a Methodology to Engineer Industrial Product-Service System – Evidence from Power and Automation Industry'. *CIRP Journal of Manufacturing Science and Technology* 15 (November): 19–32. <https://doi.org/10.1016/j.cirpj.2016.04.006>.
- Pezzotta, Giuditta, Claudio Sassanelli, Fabiana Pirola, Roberto Sala, Monica Rossi, Sophia Fotia, Angelos Koutoupes, Sergio Terzi, and Dimitris Mourtzis. 2018. 'The Product Service System Lean Design Methodology (PSSLDM): Integrating Product and Service Components along the Whole PSS Lifecycle'. *Journal of Manufacturing Technology Management* 29 (8): 1270–95. <https://doi.org/10.1108/JMTM-06-2017-0132>.
- Pirola, Fabiana, Xavier Boucher, Stefan Wiesner, and Giuditta Pezzotta. 2020. 'Digital Technologies in Product-Service Systems: A Literature Review and a Research Agenda'. *Computers in Industry* 123 (December): 103301. <https://doi.org/10.1016/j.compind.2020.103301>.
- Porter, M.E., and J.E. Heppelmann. 2014. 'How Smart, Connected Products Are Transforming Competition'. *Harvard Business Review*, no. November 2014.
- Romero, Marcelo, Wided Guédria, Hervé Panetto, and Béatrix Barafort. 2020. 'Towards a Characterisation of Smart Systems: A Systematic Literature Review'. *Computers in Industry* 120 (September): 103224. <https://doi.org/10.1016/j.compind.2020.103224>.
- Rondini, Alice, Marco Bertoni, and Giuditta Pezzotta. 2020. 'At the Origins of Product Service Systems: Supporting the Concept Assessment with the Engineering Value Assessment Method'. *CIRP Journal of Manufacturing Science and Technology*, New research advances on Product Service System along the Lifecycle, 29 (May): 157–75. <https://doi.org/10.1016/j.cirpj.2018.08.002>.
- Rondini Alice, Pezzotta Giuditta, Pirola Fabiana, Rossia Monica, and Pina Paulo. 2016. 'How to Design and Evaluate Early PSS Concepts: The Product Service Concept Tree' 50: 366–71. <https://doi.org/10.1016/j.procir.2016.04.177>.
- Rondini Alice, Tornese Fabiana, Gnoni Maria Grazia, Pezzotta Giuditta, and Pinto Roberto. 2017. 'Hybrid Simulation Modelling as a Supporting Tool for Sustainable Product Service Systems: A Critical Analysis'. *INTERNATIONAL JOURNAL OF PRODUCTION RESEARCH* 55 (23): 6932–45. <https://doi.org/10.1080/00207543.2017.1330569>.
- Sakao, Tomohiko, Anna Öhrwall Rönnbäck, and Gunilla Ölundh Sandström. 2013. 'Uncovering Benefits and Risks of Integrated Product Service Offerings — Using a Case of Technology Encapsulation'. *Journal of Systems Science and Systems Engineering* 22 (4): 421–39. <https://doi.org/10.1007/s11518-013-5233-6>.
- Sakao, Tomohiko, Yoshiki Shimomura, Erik Sundin, and Mica Comstock. 2009. 'Modeling Design Objects in CAD System for Service/Product Engineering'. *Computer-Aided Design* 41 (3): 197–213. <https://doi.org/10.1016/j.cad.2008.06.006>.
- Sassanelli Claudio, Pezzotta Giuditta, Pirola Fabiana, Sala Roberto, Margarito Antonio, Lazoi Mariangela, Corallo Angelo, Rossi Monica, and Terzi Sergio. 2018. 'Using Design Rules to Guide the PSS Design in an Engineering Platform Based on the Product Service Lifecycle Management

- (PSLM) Paradigm'. *INTERNATIONAL JOURNAL OF PRODUCT LIFECYCLE MANAGEMENT* 11 (2): 91–115. <https://doi.org/10.1504/IJPLM.2018.10011567>.
- Schroeder, G.N., C. Steinmetz, C.E. Pereira, and D.B. Espindola. 2016. 'Digital Twin Data Modeling with AutomationML and a Communication Methodology for Data Exchange'. *IFAC-PapersOnLine* 49 (30): 12–17. <https://doi.org/10.1016/j.ifacol.2016.11.115>.
- Selviaridis, Kostas, and Andreas Norrman. 2014. 'Performance-Based Contracting in Service Supply Chains: A Service Provider Risk Perspective'. *Supply Chain Management: An International Journal* 19 (2): 153–72. <https://doi.org/10.1108/SCM-06-2013-0216>.
- Song, Wenyan, and Tomohiko Sakao. 2016. 'Service Conflict Identification and Resolution for Design of Product–Service Offerings'. *Computers & Industrial Engineering* 98 (August): 91–101. <https://doi.org/10.1016/j.cie.2016.05.019>.
- . 2017. 'A Customization-Oriented Framework for Design of Sustainable Product/Service System'. *Journal of Cleaner Production* 140 (January): 1672–85. <https://doi.org/10.1016/j.jclepro.2016.09.111>.
- Story, Vicky M., Chris Raddats, Jamie Burton, Judy Zolkiewski, and Tim Baines. 2017. 'Capabilities for Advanced Services: A Multi-Actor Perspective'. *Industrial Marketing Management* 60 (January): 54–68. <https://doi.org/10.1016/j.indmarman.2016.04.015>.
- Thoben, Klaus-Dieter, Stefan Wiesner, Thorsten Wuest, BIBA – Bremer Institut für Produktion und Logistik GmbH, the University of Bremen, Faculty of Production Engineering, University of Bremen, Bremen, Germany, and Industrial and Management Systems Engineering,. 2017. "'Industrie 4.0" and Smart Manufacturing – A Review of Research Issues and Application Examples'. *International Journal of Automation Technology* 11 (1): 4–16. <https://doi.org/10.20965/ijat.2017.p0004>.
- Tukker, Arnold. 2004. 'Eight Types of Product–Service System: Eight Ways to Sustainability? Experiences from SusProNet'. *Business Strategy and the Environment* 13 (4): 246–260. <https://doi.org/10.1002/bse.414>.
- Van Halen, Cees, Carlo Vezzoli, and Robert Wimmer. 2005. *Methodology for Product Service System Innovation: How to Develop Clean, Clever and Competitive Strategies in Companies*. Uitgeverij Van Gorcum.
- Van Ostaeyen, Joris, Adriaan Van Horenbeek, Liliane Pintelon, and Joost R. Duflo. 2013. 'A Refined Typology of Product–Service Systems Based on Functional Hierarchy Modeling'. *Journal of Cleaner Production* 51 (July): 261–76. <https://doi.org/10.1016/j.jclepro.2013.01.036>.
- Vandermerwe, Sandra, and Juan Rada. 1988. 'Servitization of Business: Adding Value by Adding Services'. *European Management Journal* 6 (4): 314–324. [https://doi.org/10.1016/0263-2373\(88\)90033-3](https://doi.org/10.1016/0263-2373(88)90033-3).
- West, Shaun, Oliver Stoll, and Petra Mueller Csernetzky. 2020. "'Avatar Journey Mapping" for Manufacturing Firms to Reveal Smart-Service Opportunities over the Product Life-Cycle'. *International Journal of Business Environment* 11 (3): 298. <https://doi.org/10.1504/IJBE.2020.110906>.
- West, Shaun, Oliver Stoll, Marika Østerlund, Petra Müller-Csernetzky, Felix Keiderling, and Christian Kowalkowski. 2020. 'Adjusting Customer Journey Mapping for Application in Industrial Product-Service Systems'. *International Journal of Business Environment* 11 (3): 275–97. <https://doi.org/10.1504/IJBE.2020.110911>.
- Wibowo, A., B. Tjahjono, and T. Tomiyama. 2017. 'Designing Contracts for Aero-Engine MRO Service Providers: Models and Simulation'. In , 59:246–51. <https://doi.org/10.1016/j.procir.2016.10.124>.
- Wuest, Thorsten, Tim Schmidt, N.A. Wei, and David Romero. 2018. 'Towards (pro-)Active Intelligent Products'. *International Journal of Product Lifecycle Management* 11 (2): 154. <https://doi.org/10.1504/IJPLM.2018.092829>.
- Wuest, Thorsten, Stefan Wellsandt, and Klaus-Dieter Thoben. 2016. 'Information Quality in PLM: A Production Process Perspective'. In *Product Lifecycle Management in the Era of Internet of Things*, edited by Abdelaziz Bouras, Benoit Eynard, Sebti Foufou, and Klaus-Dieter Thoben,

826–34. IFIP Advances in Information and Communication Technology. Cham: Springer International Publishing. [https://doi.org/10.1007/978-3-319-33111-9\\_75](https://doi.org/10.1007/978-3-319-33111-9_75).

Zheng, Pai, Zuoxu Wang, Chun-Hsien Chen, and Li Pheng Khoo. 2019. 'A Survey of Smart Product-Service Systems: Key Aspects, Challenges and Future Perspectives'. *Advanced Engineering Informatics* 42 (October): 100973. <https://doi.org/10.1016/j.aei.2019.100973>.