

# FAST DATA ASSIMILATION OF SPARSE MEASUREMENTS FOR TIME EXTRAPOLATION OF MAIN FLOW PATTERNS

V. Resseguier, L. Wallian & D. Heitz



# CONTENT

- I. Context & results:  
Observer for unsteady aerodynamism
- II. Methodology
  - a) Physics, data & reduced order model (ROM)
  - b) Simulation, measurements & data assimilation
  - c) Reduced order model under location uncertainty
- III. New implementation & results

# PART I

Context & results:

Observer for unsteady  
aerodynamism



# CONTEXT

## Observer for unsteady aerodynamism

*Application:* Real-time estimation and prediction of 3D fluid flow  
using strongly-limited computational resources & few sensors

---



Wind  
turbine  
blade

# CONTEXT

## Observer for unsteady aerodynamism

*Application:* Real-time estimation and prediction of 3D fluid flow  
using strongly-limited computational resources & few sensors

---

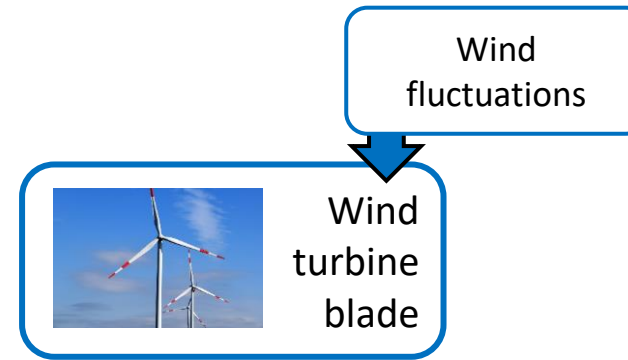

# CONTEXT

## Observer for unsteady aerodynamism

*Application:* Real-time estimation and prediction of 3D fluid flow  
using strongly-limited computational resources & few sensors

---

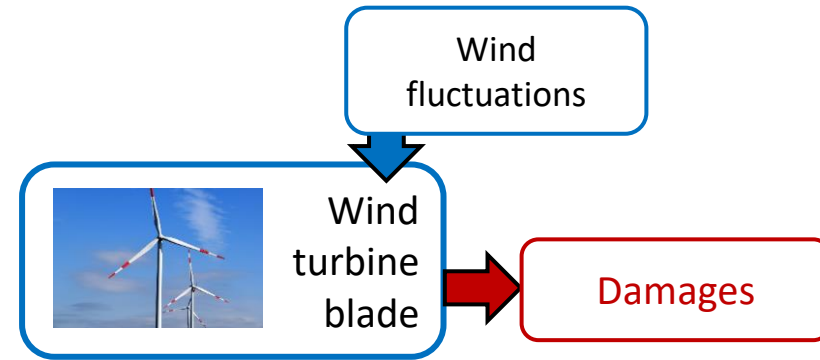

# CONTEXT

## Observer for unsteady aerodynamism

*Application:* Real-time estimation and prediction of 3D fluid flow using strongly-limited computational resources & few sensors

Estimation and prediction:

- Air flow
- Lift, drag, inflow
- ...

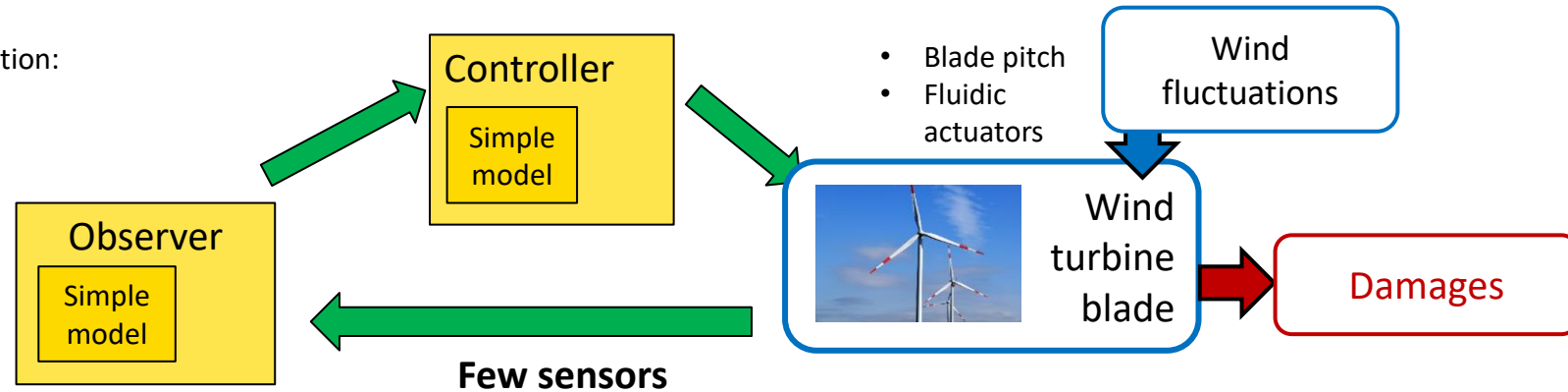

# CONTEXT

## Observer for unsteady aerodynamism

*Application:* Real-time estimation and prediction of 3D fluid flow using strongly-limited computational resources & few sensors

Estimation and prediction:

- Air flow
- Lift, drag, inflow
- ...

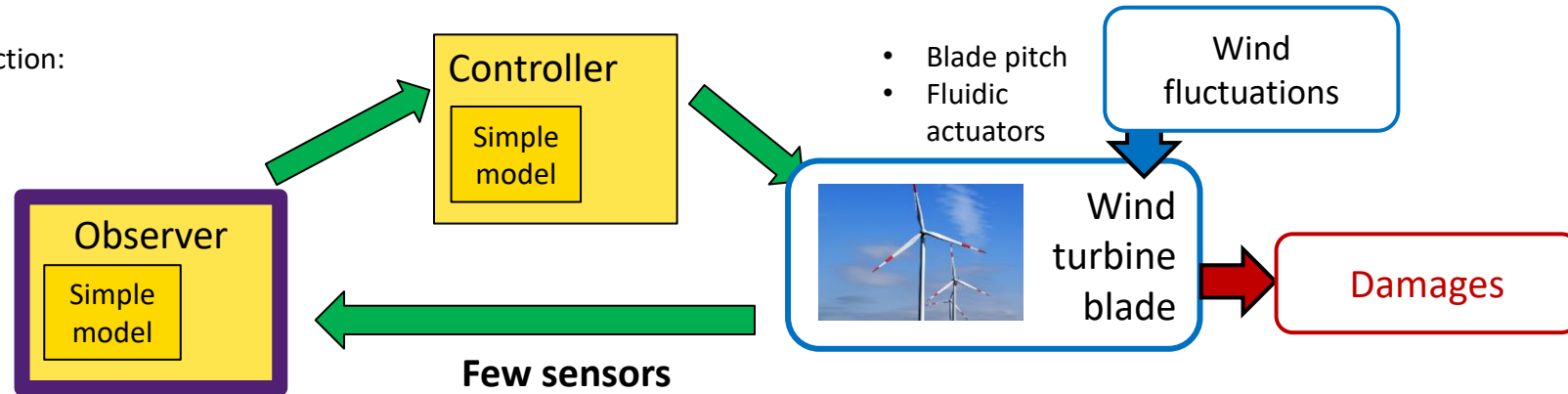



# CONTEXT

## Observer for unsteady aerodynamism

*Application:* Real-time estimation and prediction of 3D fluid flow using strongly-limited computational resources & few sensors

Estimation and prediction:

- Air flow
- Lift, drag, inflow
- ...

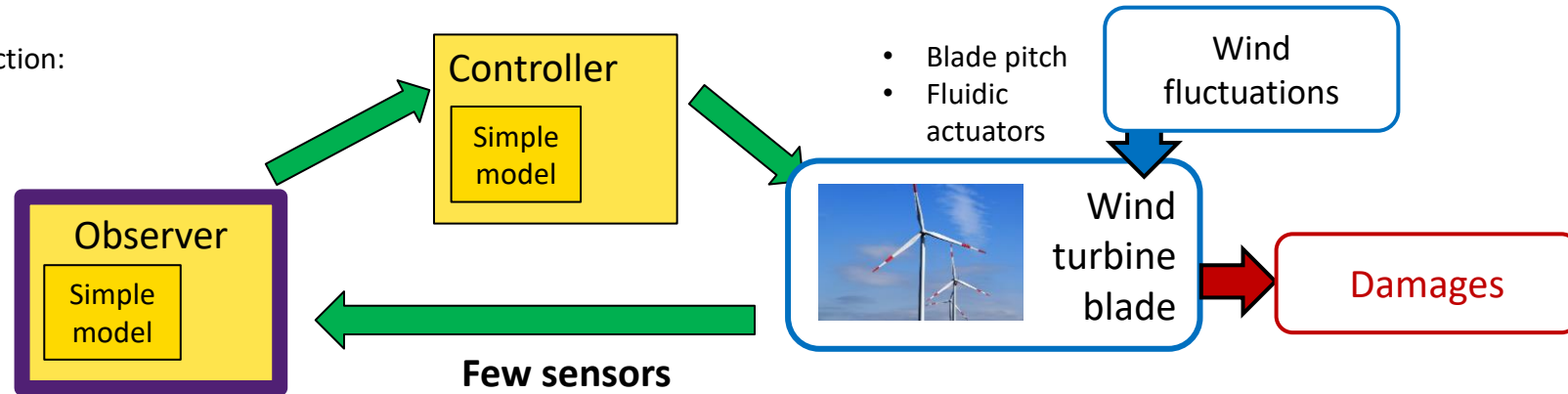

Which simple model? How to combine model & measurements?

# CONTEXT

## Observer for unsteady aerodynamism

*Application:* Real-time estimation and prediction of 3D fluid flow using strongly-limited computational resources & few sensors

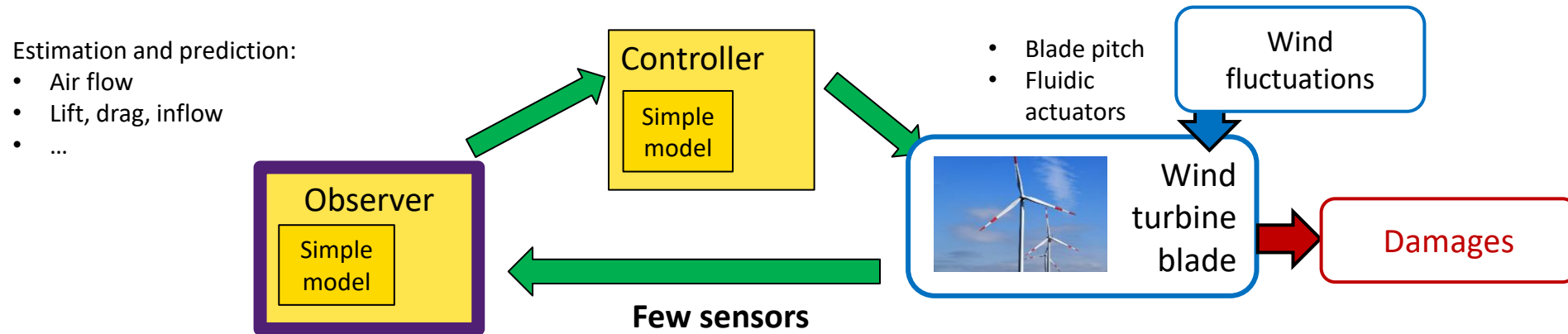

Which simple model? How to combine model & measurements?

**Scientific problem :**

**Simulation & data assimilation under severe dimensional reduction**

typically,  $10^7 \rightarrow O(10)$  degrees of freedom

# RESULTS

**DNS**  
“true” simulation  
( $10^7$  degrees of  
freedom)

# RESULTS

DNS  
“true” simulation  
( $10^7$  degrees of freedom)

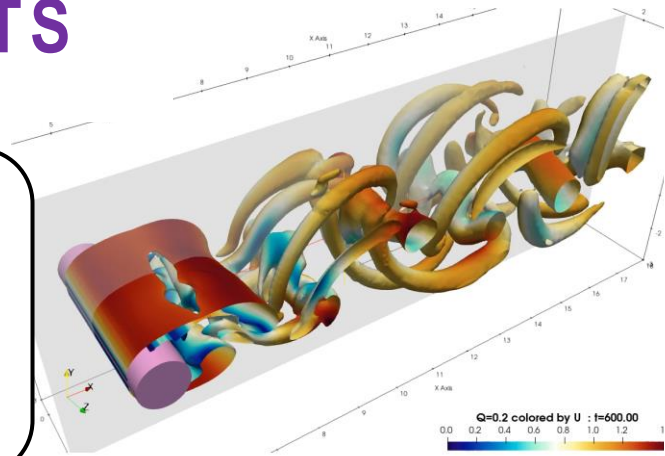

# RESULTS

DNS  
 “true” simulation  
 ( $10^7$  degrees of freedom)

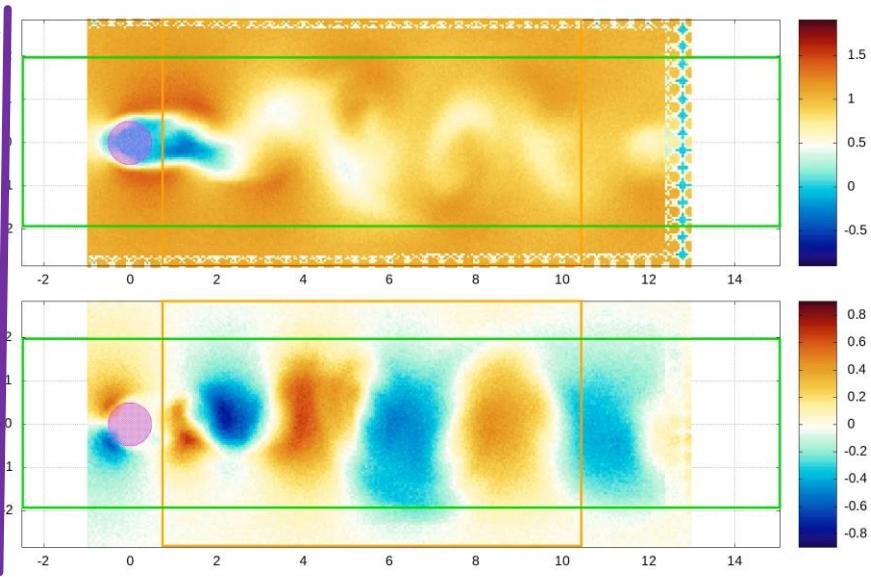
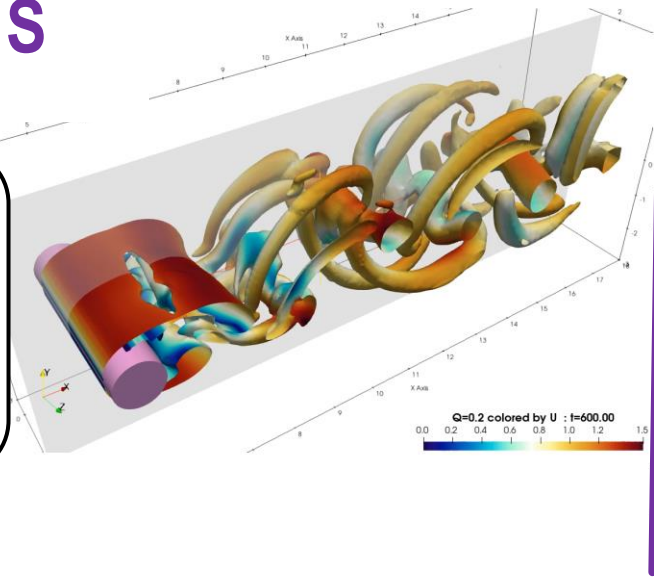

Synthetic PIV  
 blurred & noisy  
 2D velocity

# RESULTS

DNS  
 "true" simulation  
 ( $10^7$  degrees of freedom)

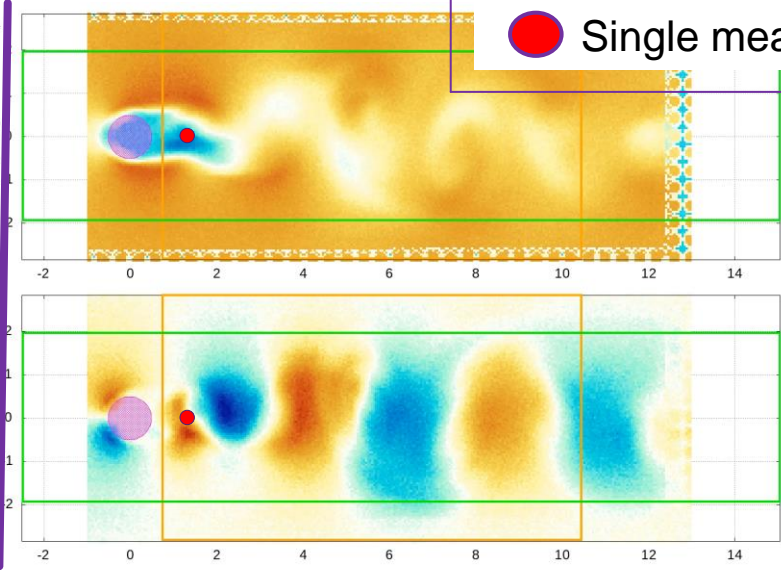
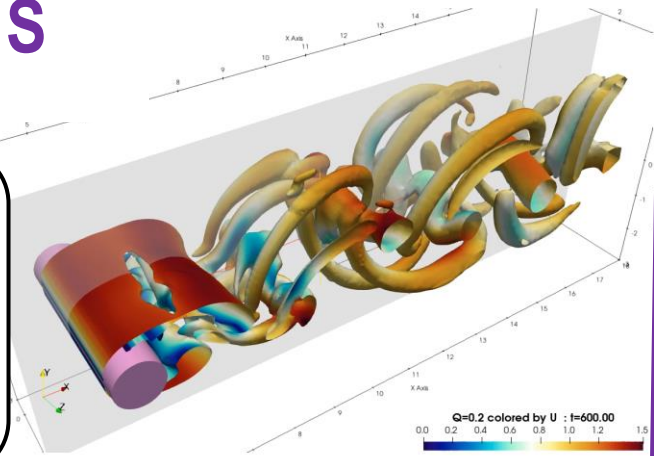

From  $10^7$  to 4 degrees of freedom

● Single measurement point (blurred & noisy velocity)

Synthetic PIV  
 blurred & noisy  
 2D velocity

# RESULTS

DNS  
 "true" simulation  
 ( $10^7$  degrees of freedom)

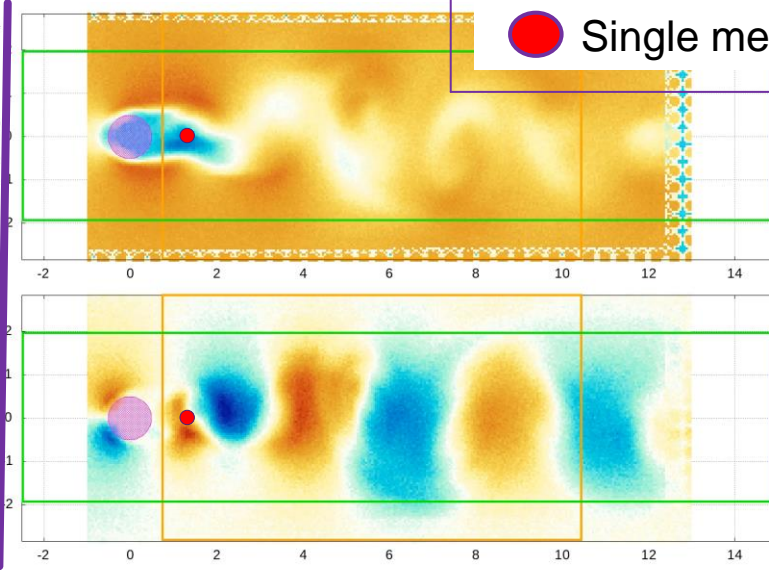
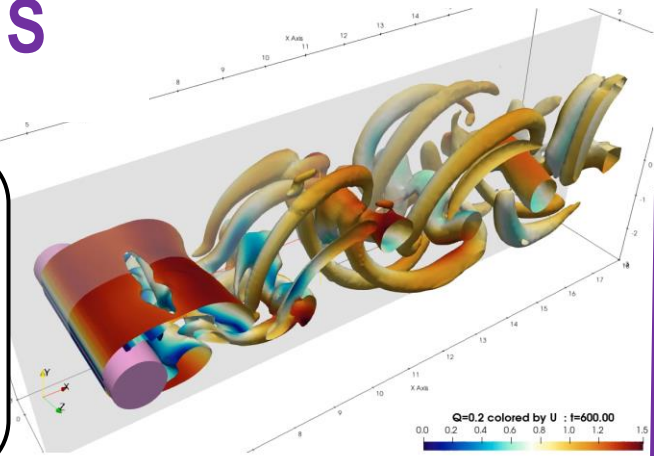

From  $10^7$  to 4 degrees of freedom

● Single measurement point (blurred & noisy velocity)

Synthetic PIV  
 blurred & noisy  
 2D velocity



# RESULTS

DNS  
"true" simulation  
( $10^7$  degrees of freedom)

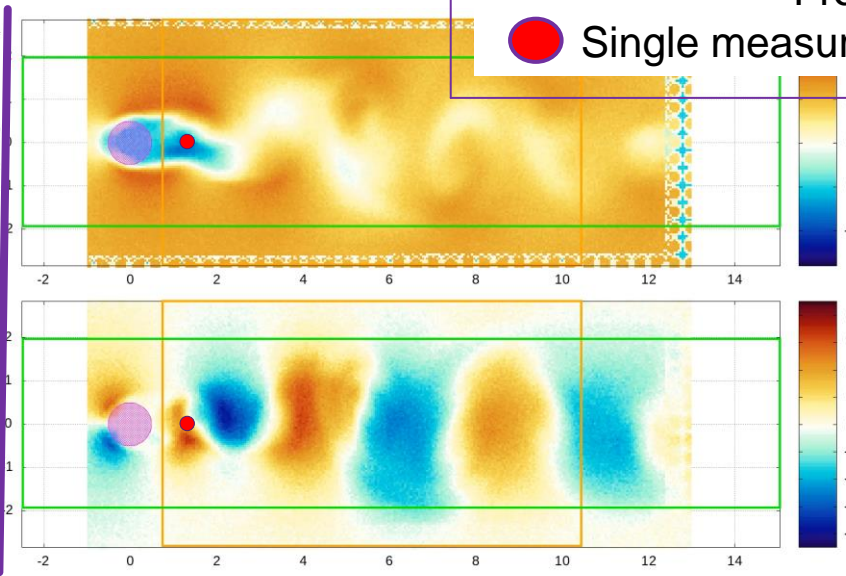
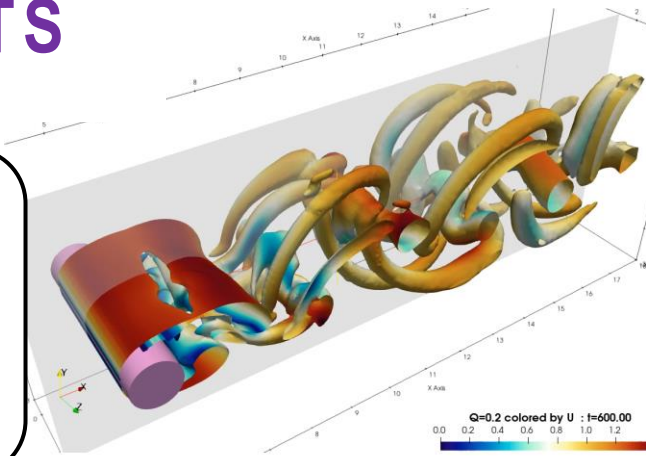

From  $10^7$  to 4 degrees of freedom

Synthetic PIV  
blurred & noisy  
2D velocity

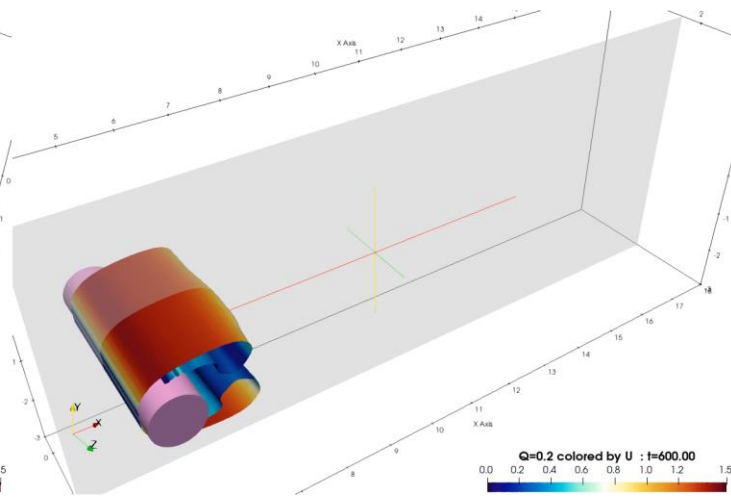
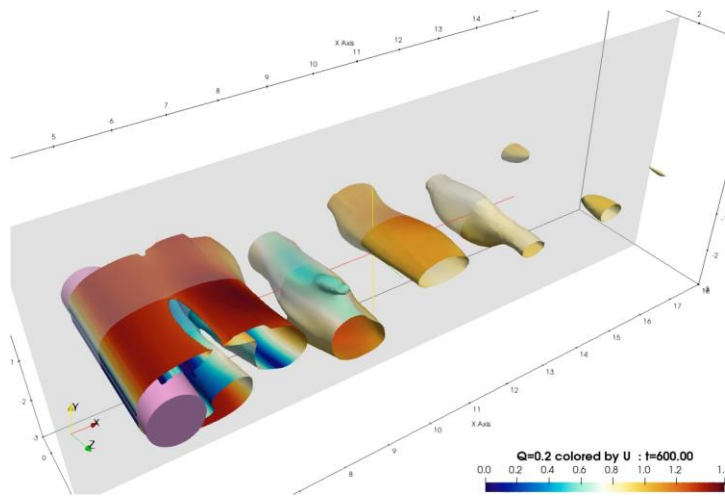



# RESULTS

**DNS**  
 “true” simulation  
 ( $10^7$  degrees of freedom)

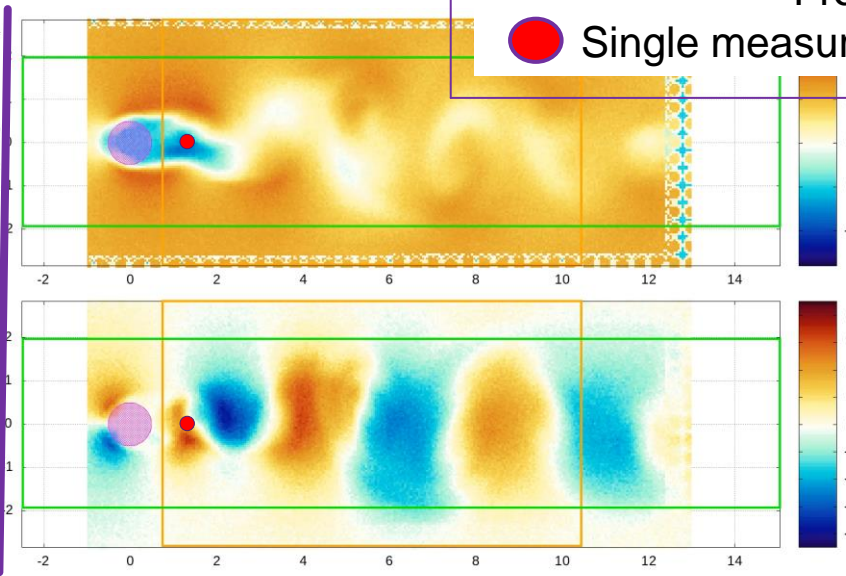
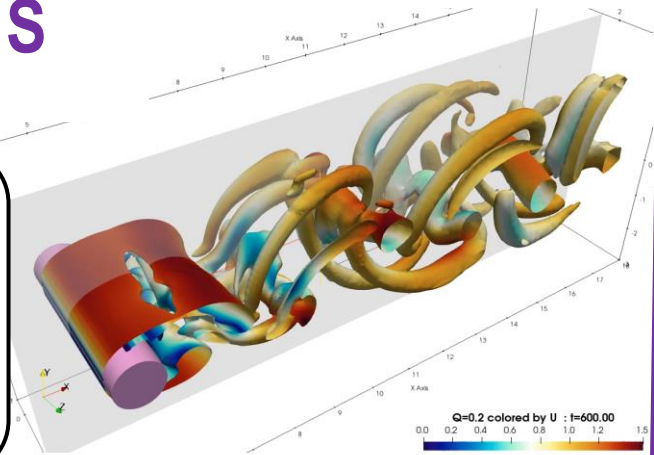

From  $10^7$  to 4 degrees of freedom

● Single measurement point (blurred & noisy velocity)

**Synthetic PIV**  
 blurred & noisy  
 2D velocity

**Reference :**  
 PCA-projection of the  
 “true” simulation  
 (DNS)  
 (Optimal from 4-  
 degrees of freedom  
 linear decomposition)

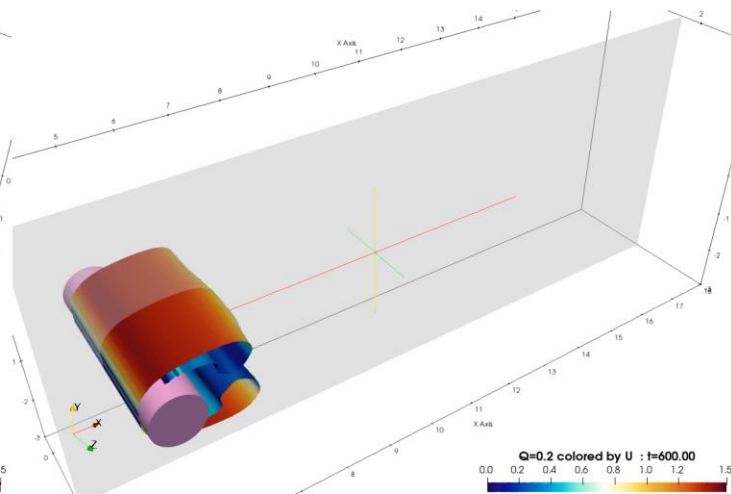
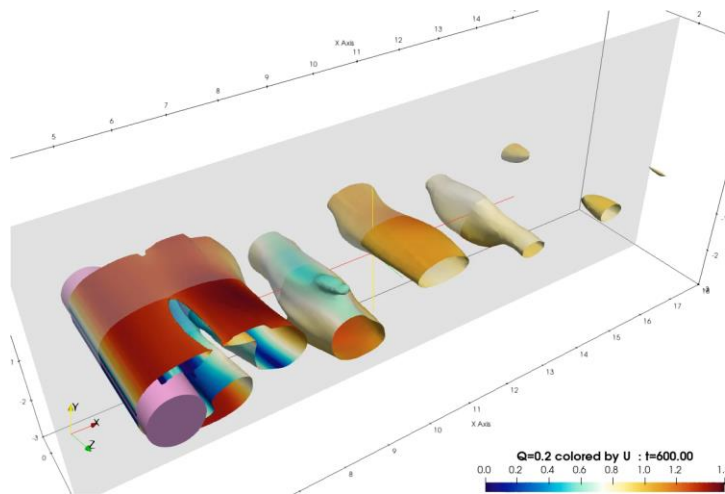

**Our method :**  
 Data assimilation  
 with  
 POD-Galerkin of  
 randomized  
 Navier-Stokes  
 (LUM)  
 (4 degrees of freedom)

# RESULTS

**DNS**  
 “true” simulation  
 ( $10^7$  degrees of freedom)

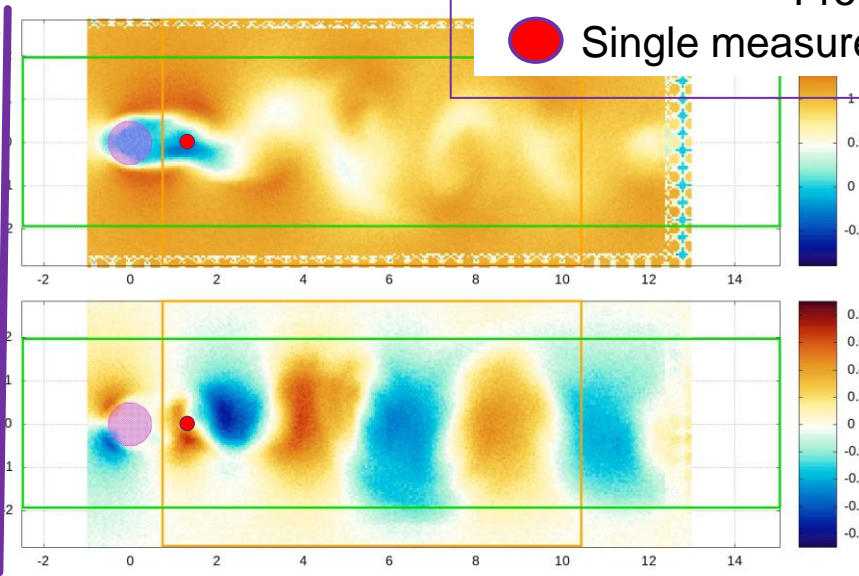
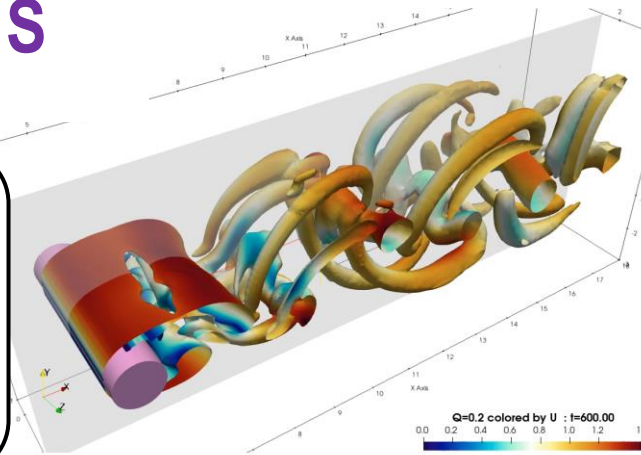

From  $10^7$  to 4 degrees of freedom

● Single measurement point (blurred & noisy velocity)

**Synthetic PIV**  
 blurred & noisy  
 2D velocity

**Reference :**  
 PCA-projection of the  
 “true” simulation  
 (DNS)  
 (Optimal from 4-  
 degrees of freedom  
 linear decomposition)

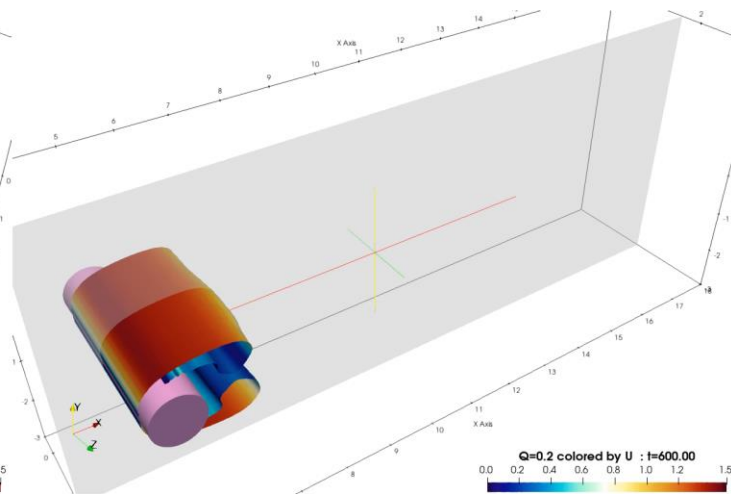
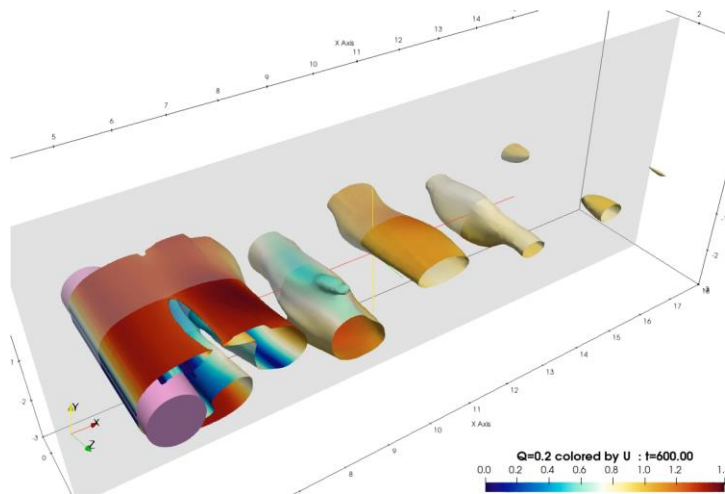

**Our method :**  
 Data assimilation  
 with  
 POD-Galerkin of  
 randomized  
 Navier-Stokes  
 (LUM)  
 (4 degrees of freedom)

# PART II

## Methodology

- a) Physics, data  
& reduced order model (ROM)
- b) Simulation, measurements  
& data assimilation
- c) Reduced order model  
under location uncertainty

# INTRUSIVE REDUCED ORDER MODEL

Combine physical models and learning approaches

- Principal Component Analysis (PCA) on a *dataset* to reduce the dimensionality:

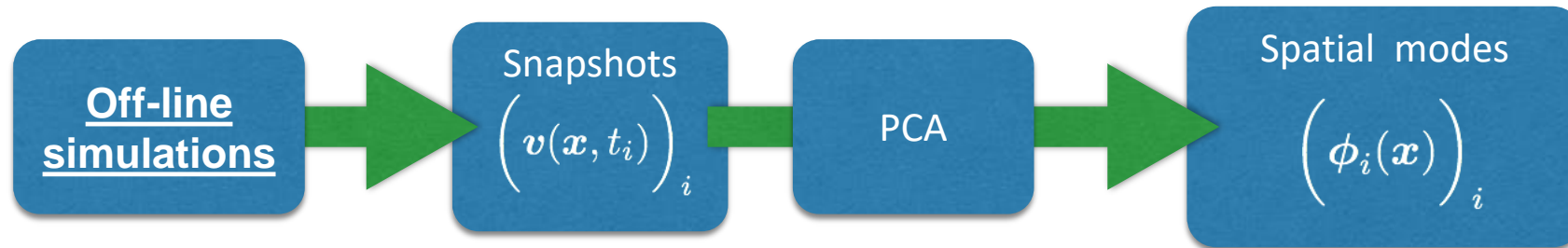

- Approximation:

$$v(x, t) \approx \sum_{i=0}^n b_i(t) \phi_i(x)$$

# INTRUSIVE REDUCED ORDER MODEL

Combine physical models and learning approaches

- Principal Component Analysis (PCA) on a *dataset* to reduce the dimensionality:

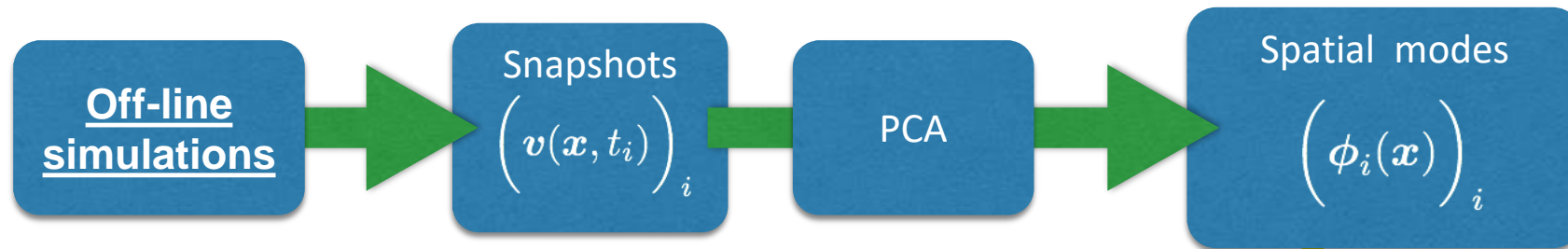

- Approximation:

$$v(x, t) \approx \sum_{i=0}^n b_i(t) \phi_i(x)$$

A yellow arrow points from the  $\phi_i(x)$  term in the equation to the "Spatial modes" box in the diagram above.

# INTRUSIVE REDUCED ORDER MODEL

Combine physical models and learning approaches

- Principal Component Analysis (PCA) on a *dataset* to reduce the dimensionality:

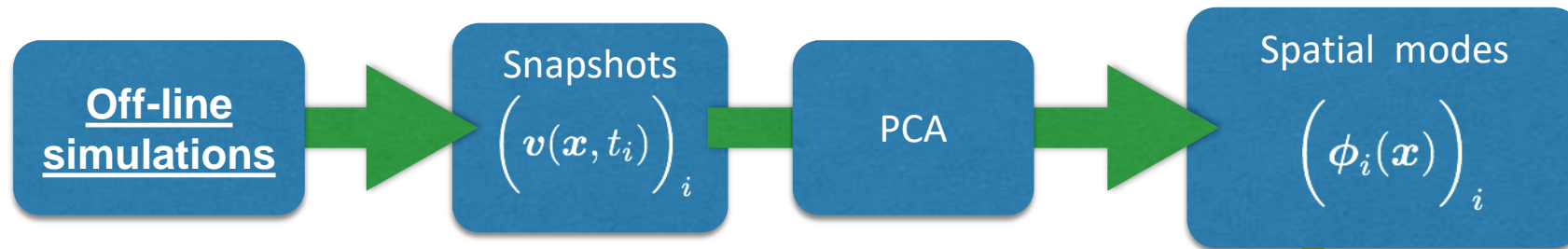

- Approximation:

$$v(x, t) \approx \sum_{i=0}^n \underbrace{b_i(t)}_{\text{Resolved modes}} \phi_i(x)$$

# INTRUSIVE REDUCED ORDER MODEL

Combine physical models and learning approaches

- Principal Component Analysis (PCA) on a *dataset* to reduce the dimensionality:

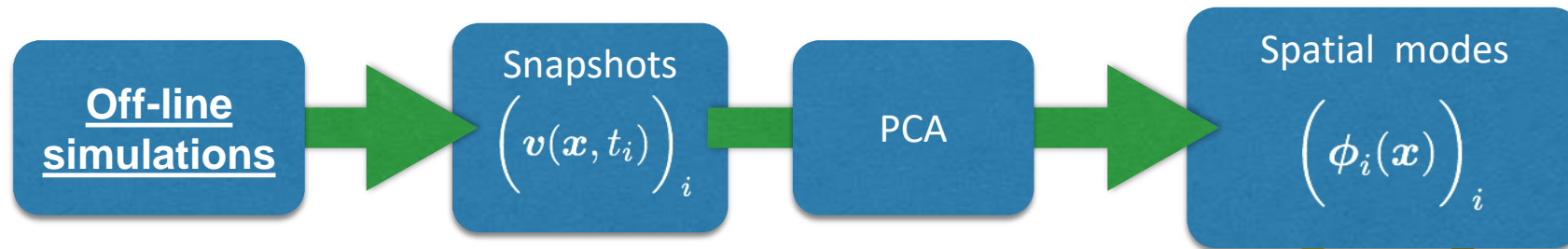

- Approximation:

$$v(x, t) \approx \sum_{i=0}^n \underbrace{b_i(t)}_{\text{Resolved modes}} \phi_i(x)$$

- Projection of the “*physics*”  
onto the spatial modes  
(POD-Galerkin)

$$\int_{\Omega} dx \phi_i(x) \cdot (\text{Physical equation (e.g. Navier-Stokes)})$$



# INTRUSIVE REDUCED ORDER MODEL

Combine physical models and learning approaches

- Principal Component Analysis (PCA) on a *dataset* to reduce the dimensionality:

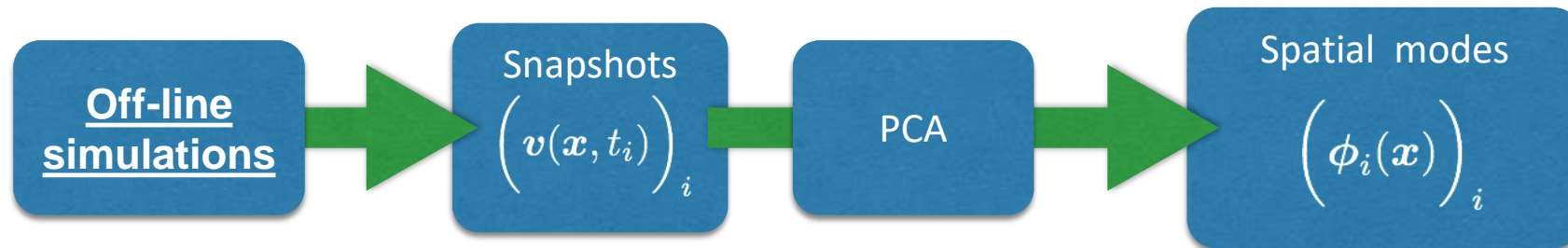

- Approximation:

$$v(x, t) \approx \sum_{i=0}^n \underbrace{b_i(t)}_{\text{Resolved modes}} \phi_i(x)$$

- Projection of the “*physics*”  
onto the spatial modes  
(POD-Galerkin)

$$\int_{\Omega} dx \phi_i(x) \cdot (\text{Physical equation (e.g. Navier-Stokes)})$$

→ ROM for very fast simulation of temporal modes



# INTRUSIVE REDUCED ORDER MODEL

Combine physical models and learning approaches

- Principal Component Analysis (PCA) on a *dataset* to reduce the dimensionality:

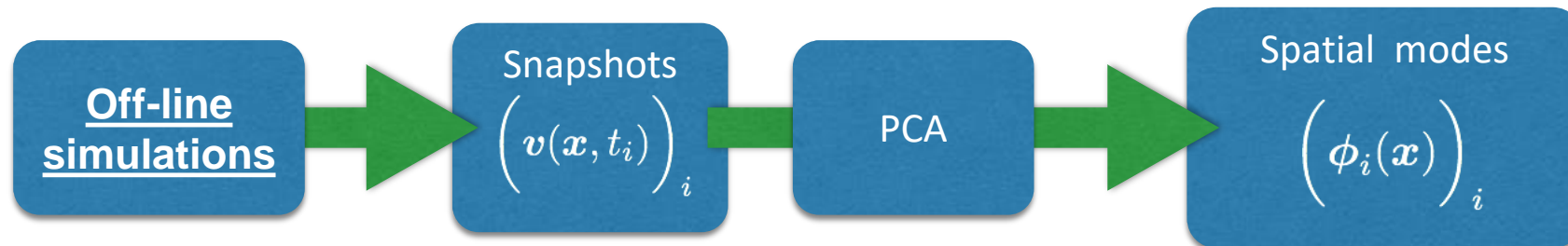

- Approximation:

$$v(x, t) \approx \sum_{i=0}^n \underbrace{b_i(t)}_{\text{Resolved modes}} \phi_i(x)$$

Don't work in extrapolation for advection-dominated problem

- Projection of the "physics" onto the spatial modes (POD-Galerkin)

$$\int_{\Omega} dx \phi_i(x) \cdot (\text{Physical equation (e.g. Navier-Stokes)})$$

→ ROM for very fast simulation of temporal modes

# INTRUSIVE REDUCED ORDER MODEL

Combine physical models and learning approaches

- Principal Component Analysis (PCA) on a *dataset* to reduce the dimensionality:

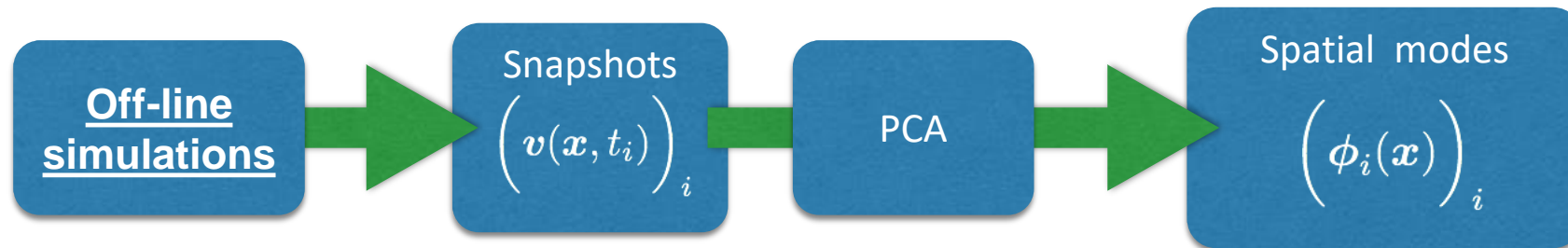

- Approximation:

$$v(x, t) \approx \sum_{i=0}^n \underbrace{b_i(t)}_{\text{Resolved modes}} \phi_i(x)$$

Don't work in extrapolation for advection-dominated problem

- Projection of the "physics" onto the spatial modes (POD-Galerkin)

$$\int_{\Omega} dx \phi_i(x) \cdot \left( \text{Physical equation (e.g. Navier-Stokes)} \right)$$

→ ROM for very fast simulation of temporal modes

# INTRUSIVE REDUCED ORDER MODEL

Combine physical models and learning approaches

- Principal Component Analysis (PCA) on a *dataset* to reduce the dimensionality:

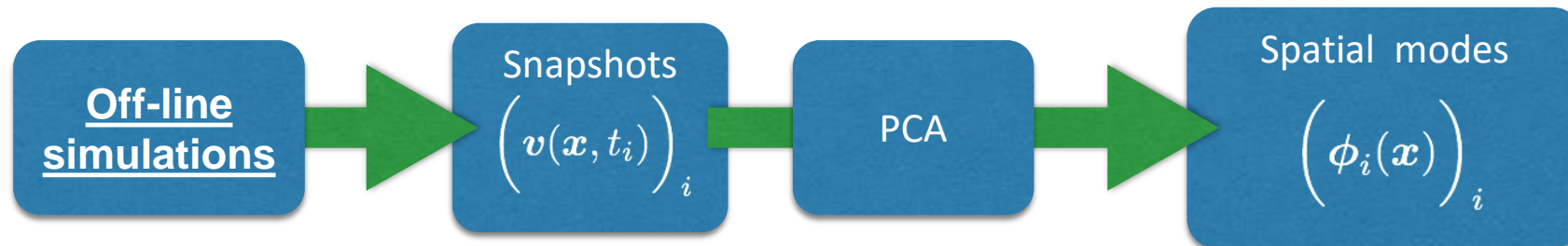

- Approximation:

$$v(x, t) \approx \sum_{i=0}^n \underbrace{b_i(t)}_{\text{Resolved modes}} \phi_i(x)$$

- Projection of the “*physics*”  
onto the spatial modes  
(POD-Galerkin)

$$\int_{\Omega} dx \phi_i(x) \cdot \left( \text{Physical equation (e.g. Navier-Stokes)} \right)$$

→ ROM for very fast simulation of temporal modes

# INTRUSIVE REDUCED ORDER MODEL

Combine physical models and learning approaches

- Principal Component Analysis (PCA) on a *dataset* to reduce the dimensionality:

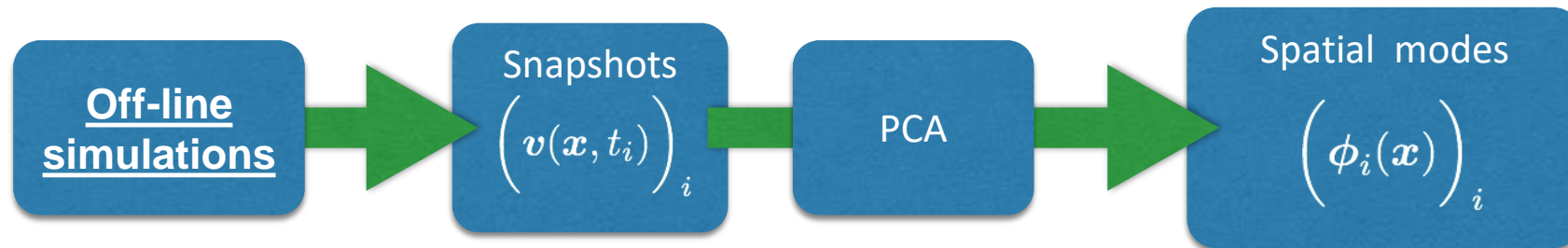

- Approximation:

$$v(x, t) \approx \sum_{i=0}^n \underbrace{b_i(t)}_{\text{Resolved modes}} \phi_i(x)$$

SPOILER

- Projection of the "physics" onto the spatial modes (POD-Galerkin)

$$\int_{\Omega} dx \phi_i(x) \cdot \text{(Randomized Navier-Stokes)}$$

→ ROM for very fast simulation of temporal modes

# DATA ASSIMILATION

= Coupling simulations and measurements  $y$

**Numerical  
Simulation  
(ROM)**

→ erroneous

**On-line  
measurements**

→ incomplete  
→ possibly noisy

Velocity

# DATA ASSIMILATION

= Coupling simulations and measurements  $y$

**Numerical  
Simulation  
(ROM)**

→ erroneous

**On-line  
measurements**

→ incomplete  
→ possibly noisy

$3 \text{ m} \cdot \text{s}^{-1}$

Velocity

# DATA ASSIMILATION

= Coupling simulations and measurements  $y$

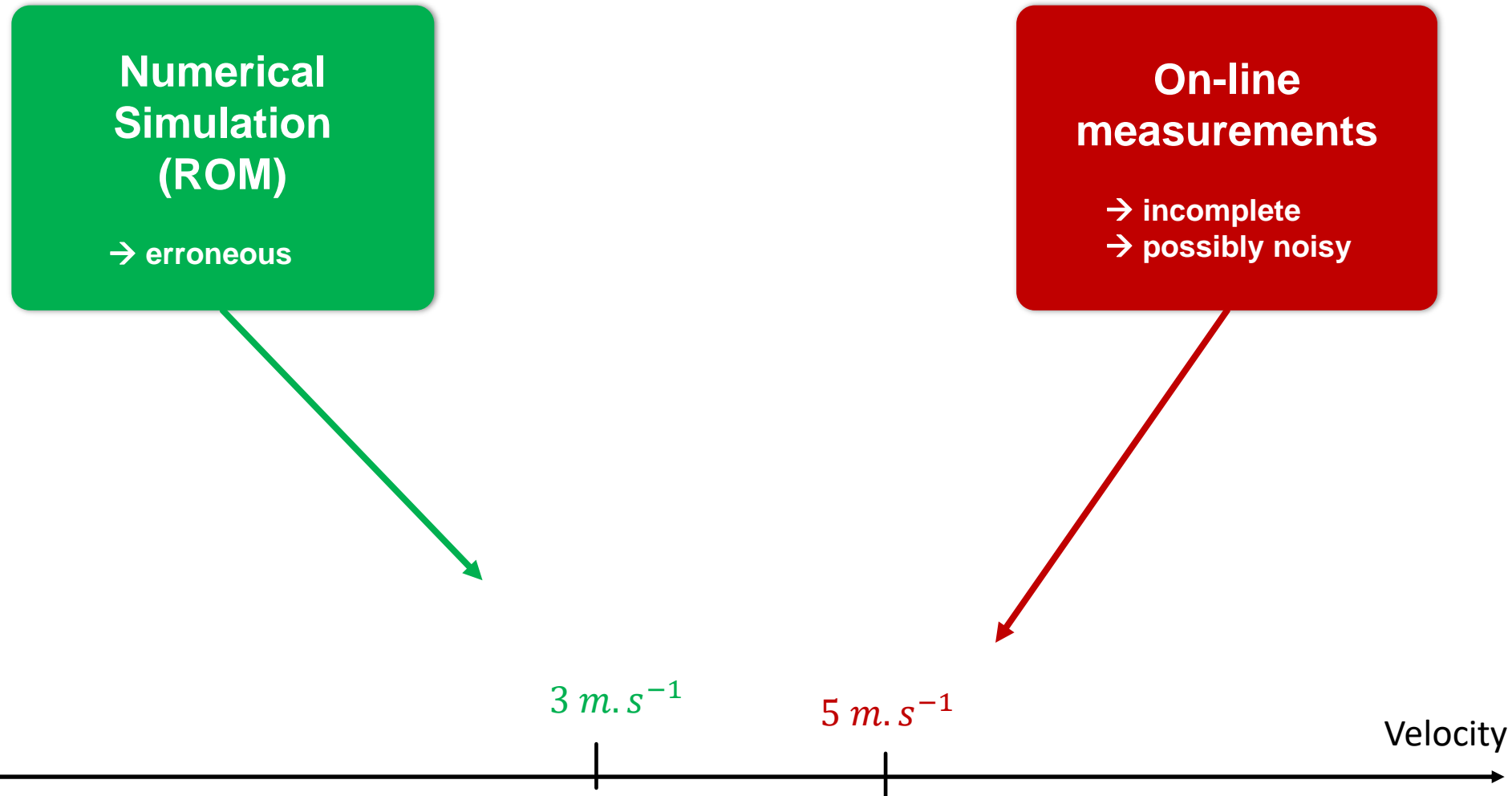

# DATA ASSIMILATION

= Coupling simulations and measurements  $y$

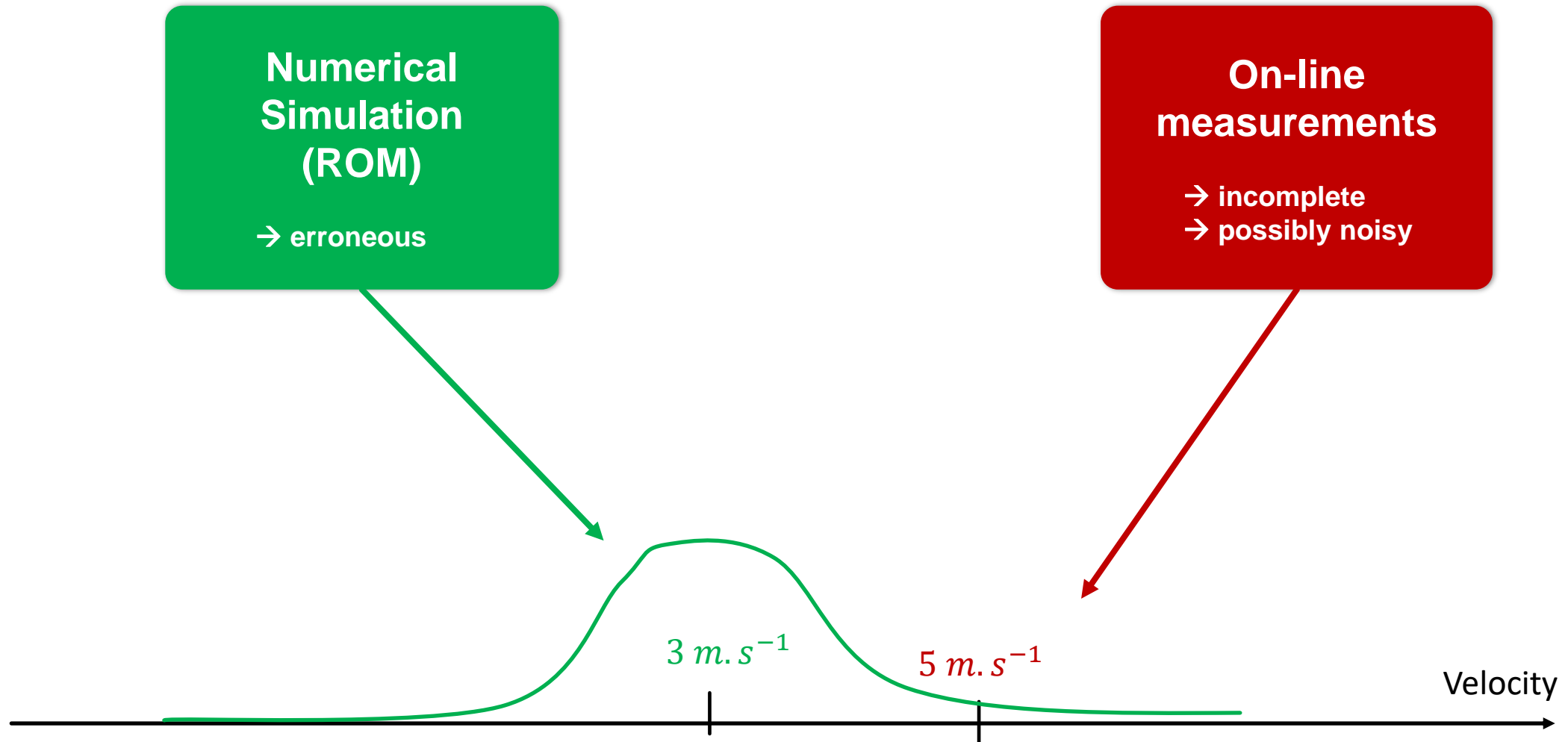



# DATA ASSIMILATION

= Coupling simulations and measurements  $y$

**Numerical  
Simulation  
(ROM)**

→ erroneous

**On-line  
measurements**

→ incomplete  
→ possibly noisy

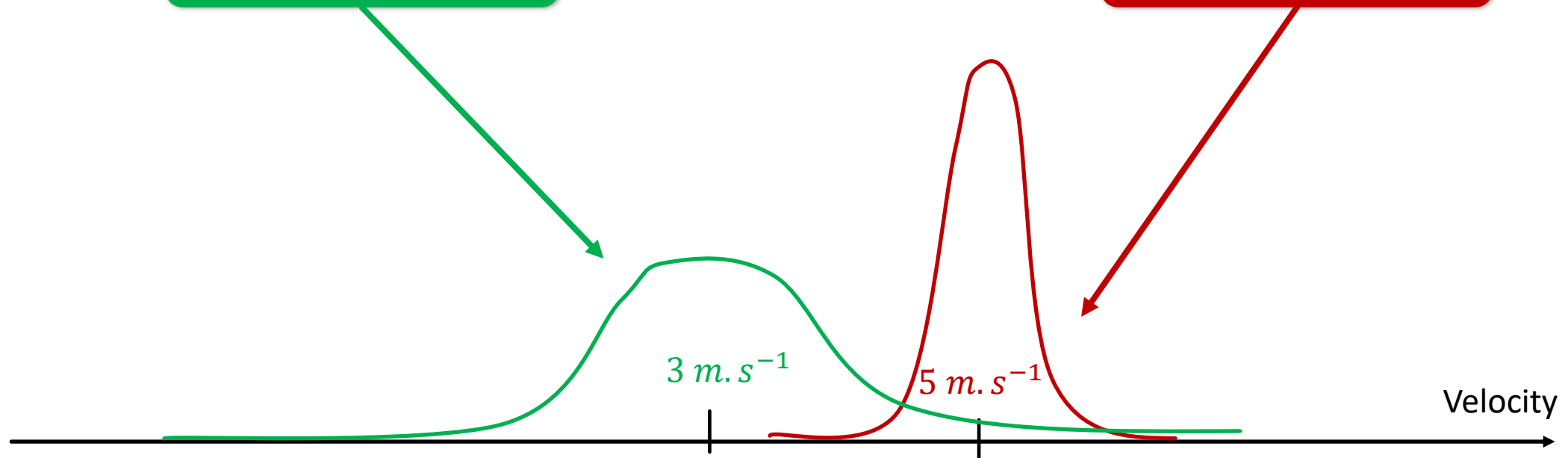

# DATA ASSIMILATION

= Coupling simulations and measurements  $y$

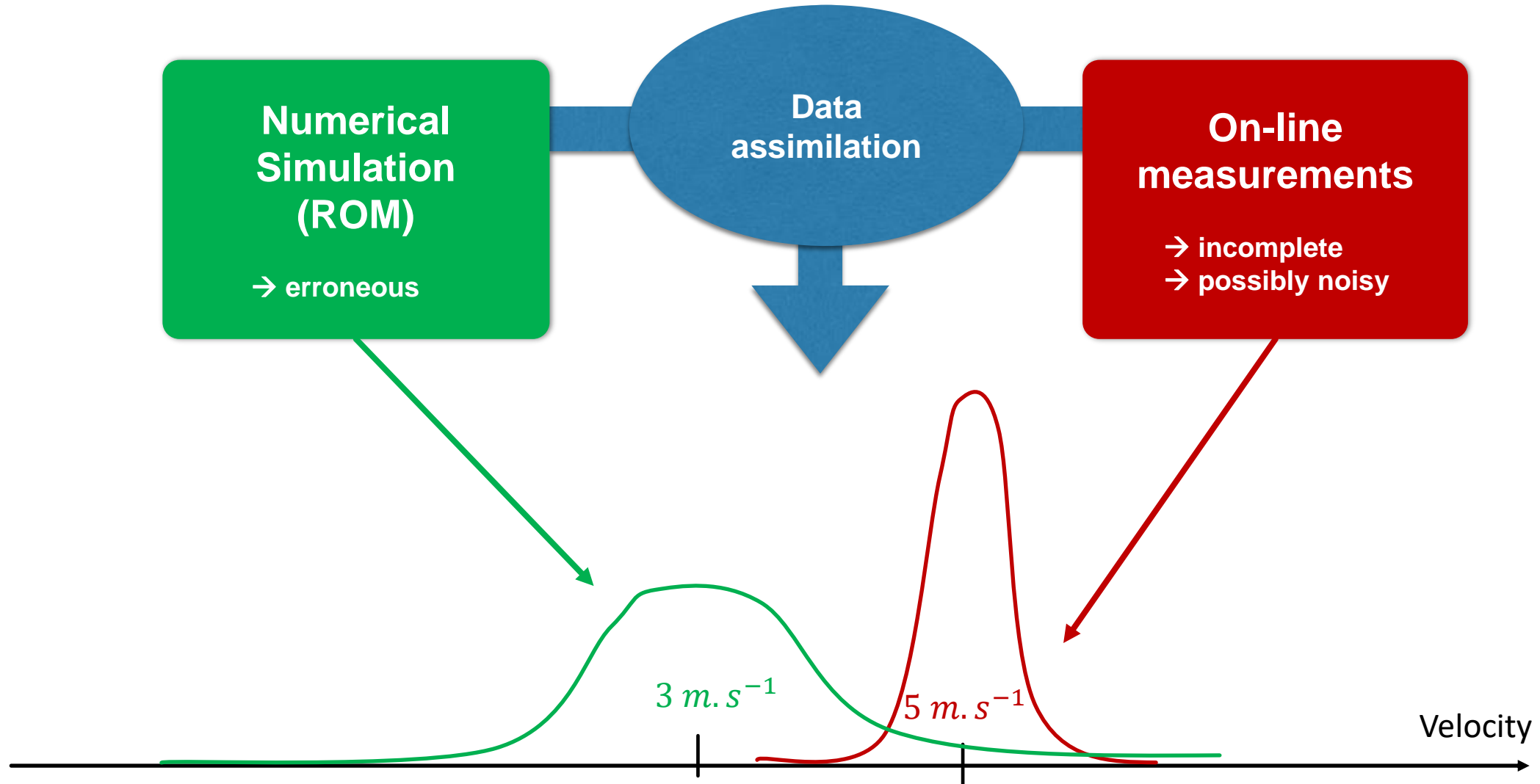

# DATA ASSIMILATION

= Coupling simulations and measurements  $y$

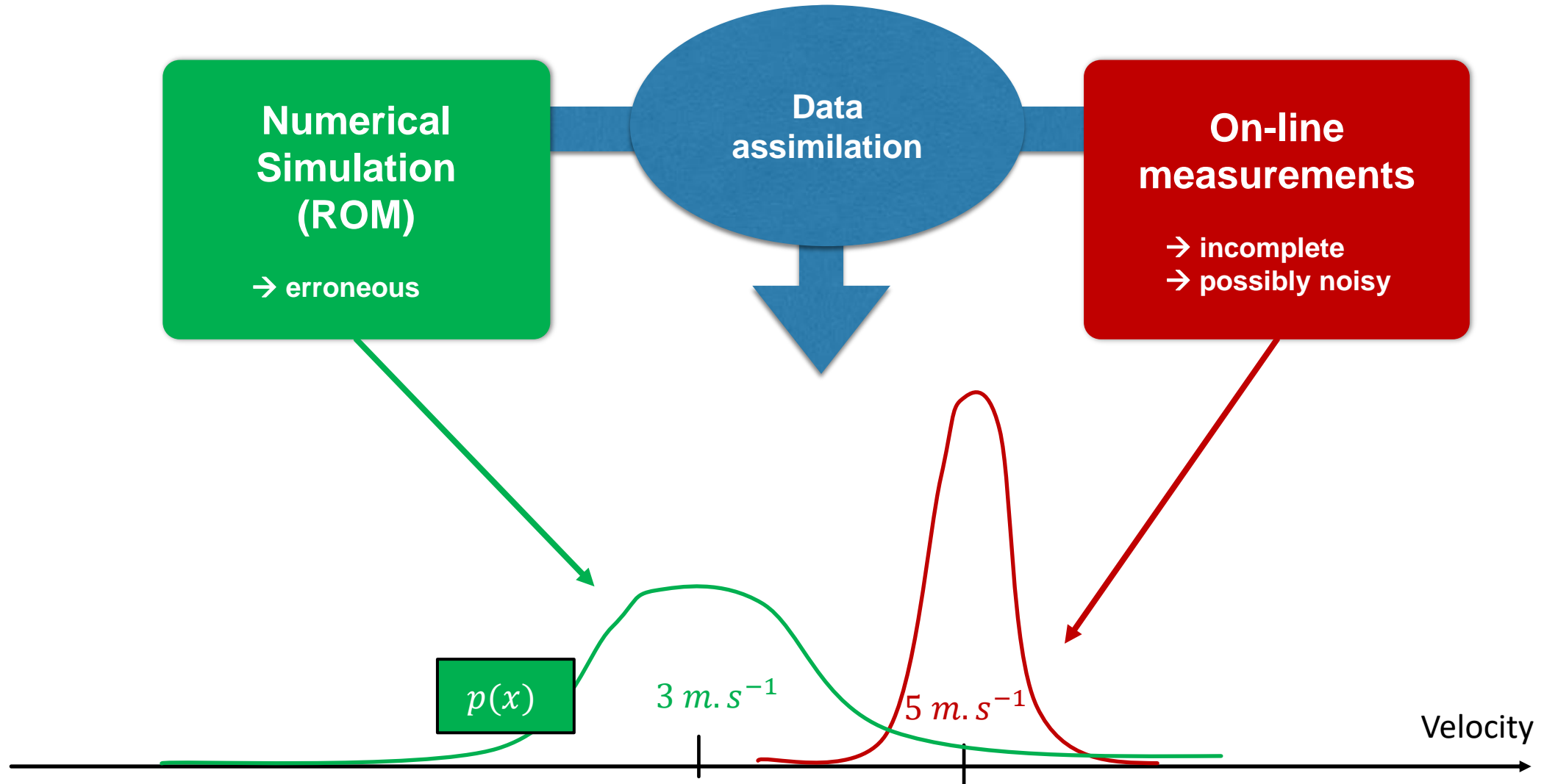

# DATA ASSIMILATION

= Coupling simulations and measurements  $y$

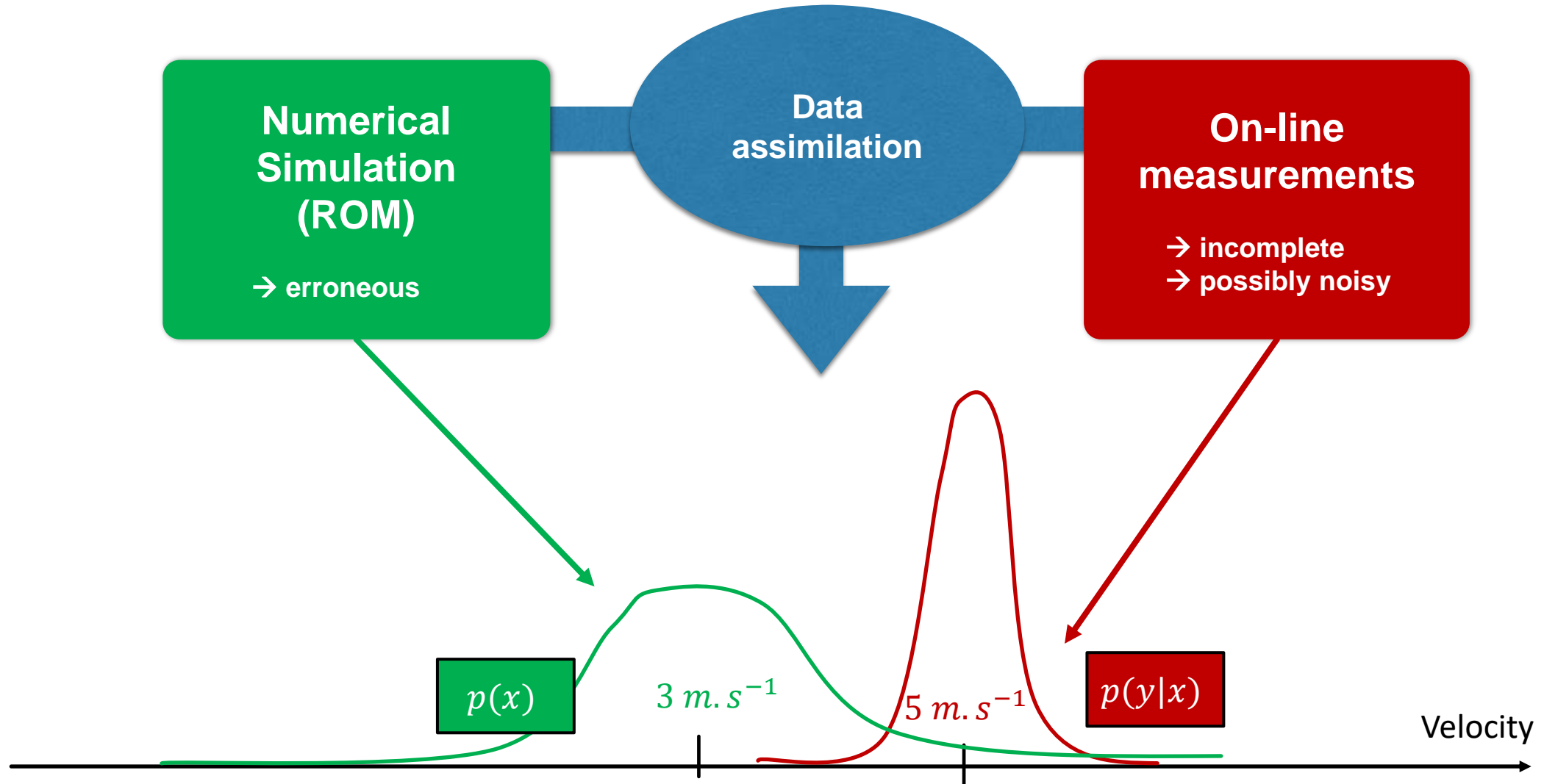

# DATA ASSIMILATION

= Coupling simulations and measurements  $y$

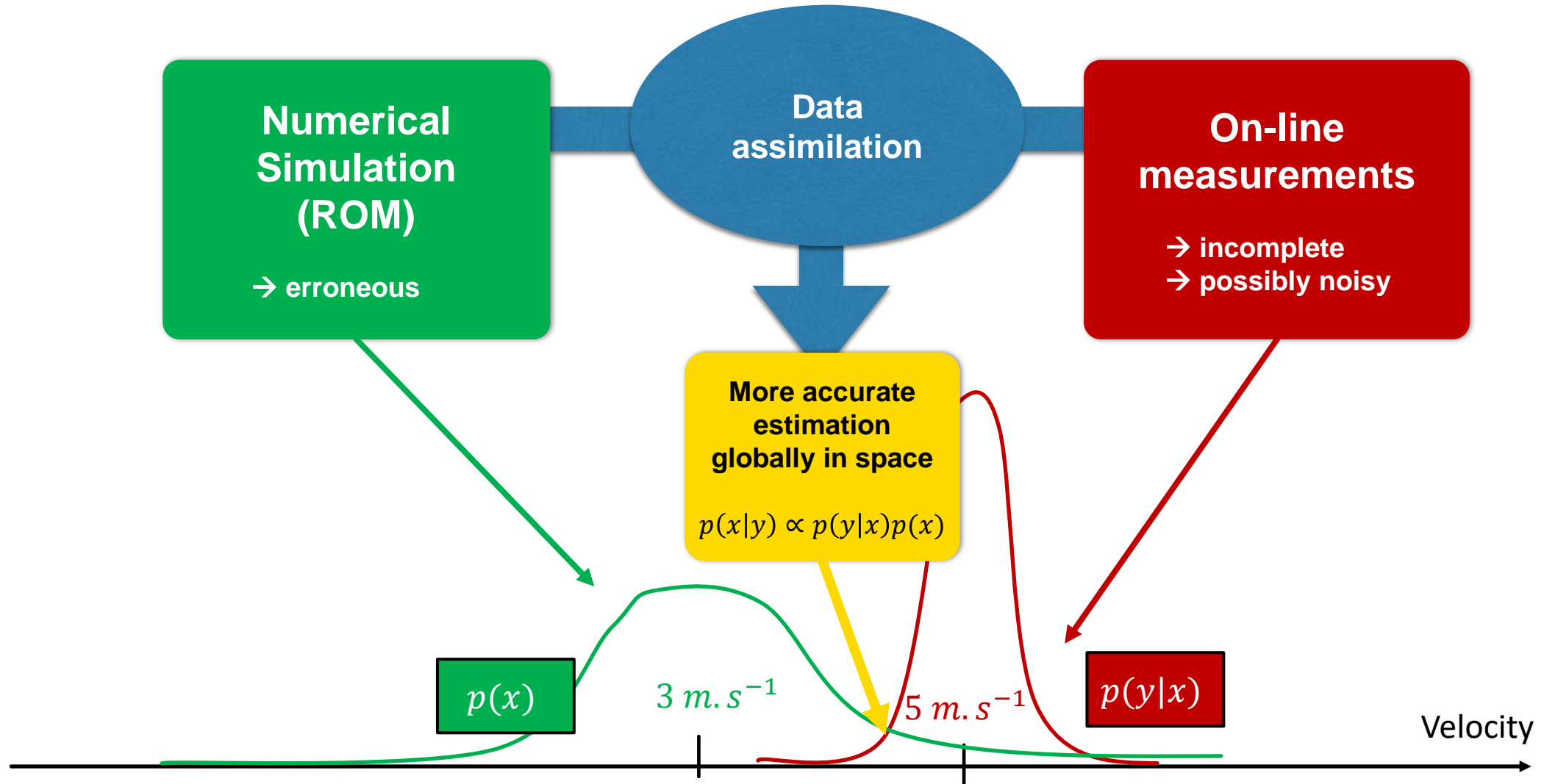

# DATA ASSIMILATION

= Coupling simulations and measurements  $y$

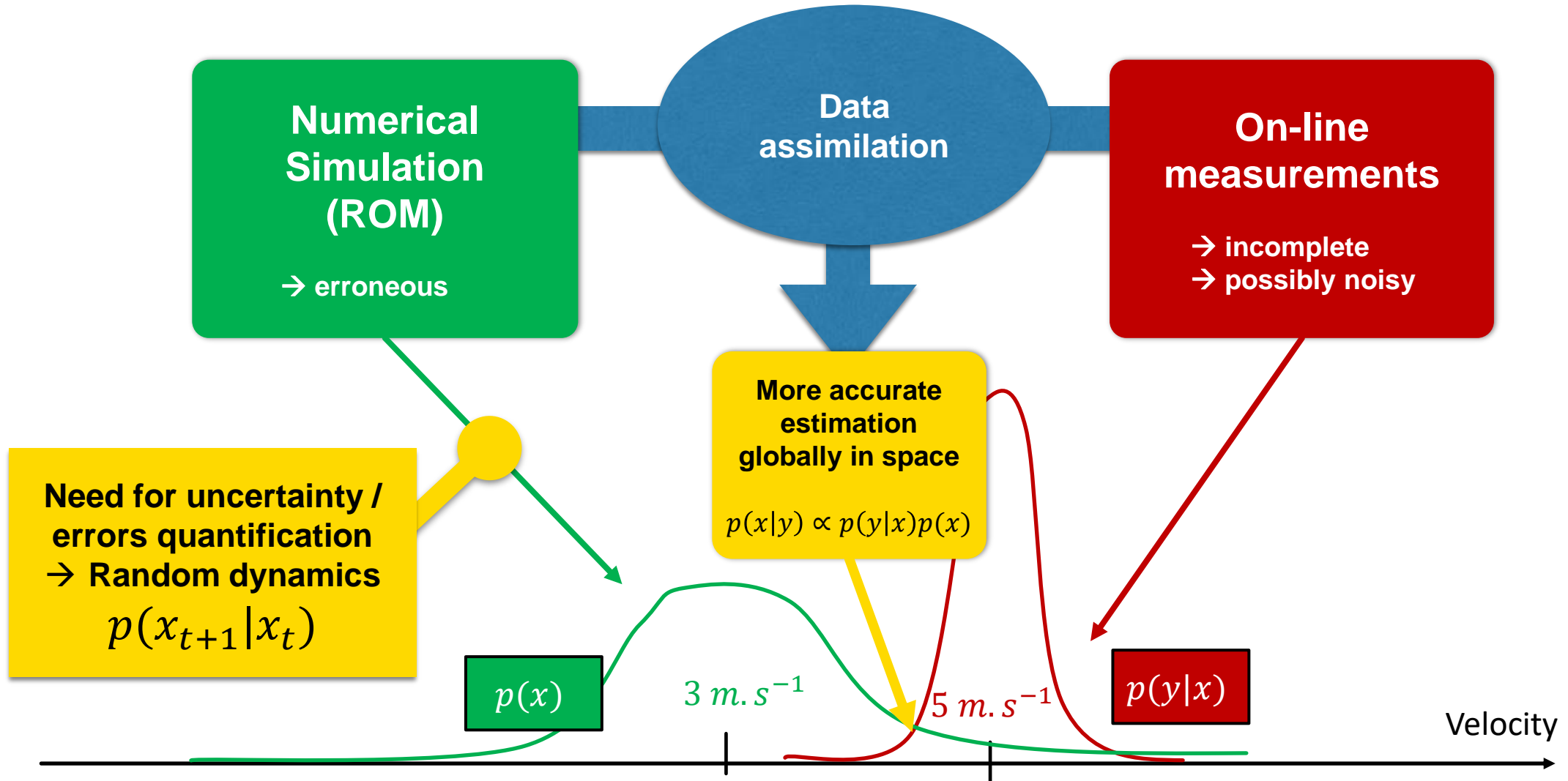

## LOCATION UNCERTAINTY MODELS (LUM)

$$v = \sum_{i=0}^n b_i \phi_i + v'$$

The equation is presented with a blue box around the sum term labeled "Resolved modes" and a green box around the residual term labeled "Residual  $v'$ ".

# LOCATION UNCERTAINTY MODELS (LUM)

Assumed  
time-uncorrelated

$$v = \sum_{i=0}^n b_i \phi_i + \text{Residual } v'$$

The diagram illustrates the Location Uncertainty Model (LUM) equation. It shows a blue-bordered box containing the sum of resolved modes,  $\sum_{i=0}^n b_i \phi_i$ , and a green-bordered box containing the residual  $v'$ . A green arrow points from the text 'Assumed time-uncorrelated' to the residual box.



# LOCATION UNCERTAINTY MODELS (LUM)

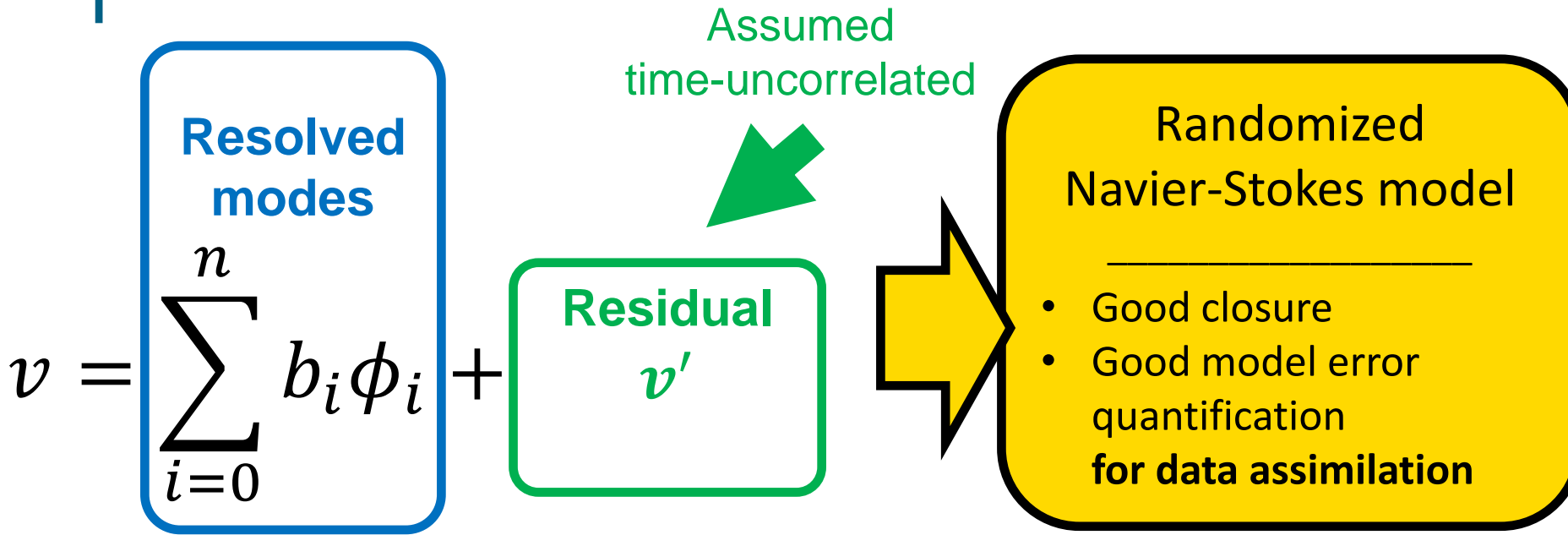

# LOCATION UNCERTAINTY MODELS (LUM)

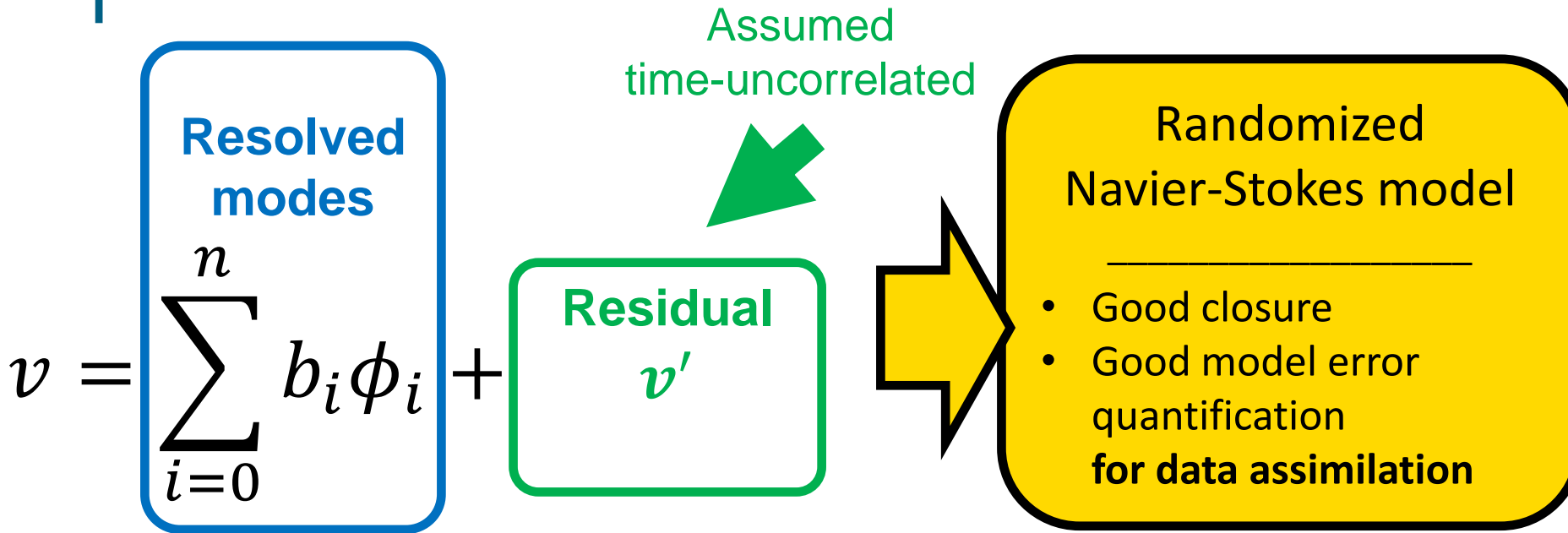

References :

Mikulevicius & Rozovskii, 2004  
Flandoli, 2011

## LUM

Memin, 2014  
**Resseguier et al. 2017 a, b, c, d** Cai et al. 2017  
Chapron et al. 2018  
Yang & Memin 2019  
...

## SALT

Crisan et al., 2017  
Gay-Balmaz & Holm 2017  
Cotter and al. 2018 a, b  
Cotter and al. 2019  
...

Cotter and al. 2017 Resseguier et al. 2020, 2021a, Zhen et al., 2023

# LOCATION UNCERTAINTY MODELS (LUM)

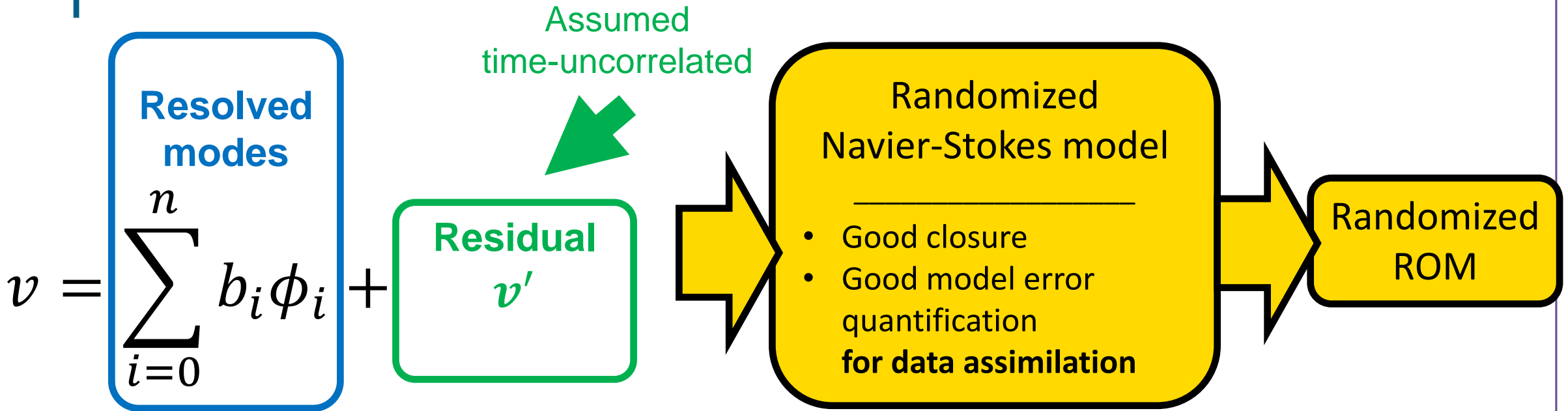

References :

Mikulevicius & Rozovskii, 2004  
Flandoli, 2011

## LUM

Memin, 2014  
**Resseguier et al. 2017 a, b, c, d** Cai et al. 2017  
Chapron et al. 2018  
Yang & Memin 2019  
...

## SALT

Crisan et al., 2017  
Gay-Balmaz & Holm 2017  
Cotter and al. 2018 a, b  
Cotter and al. 2019  
...

Cotter and al. 2017 Resseguier et al. 2020, 2021a, Zhen et al., 2023

# LOCATION UNCERTAINTY MODELS (LUM)

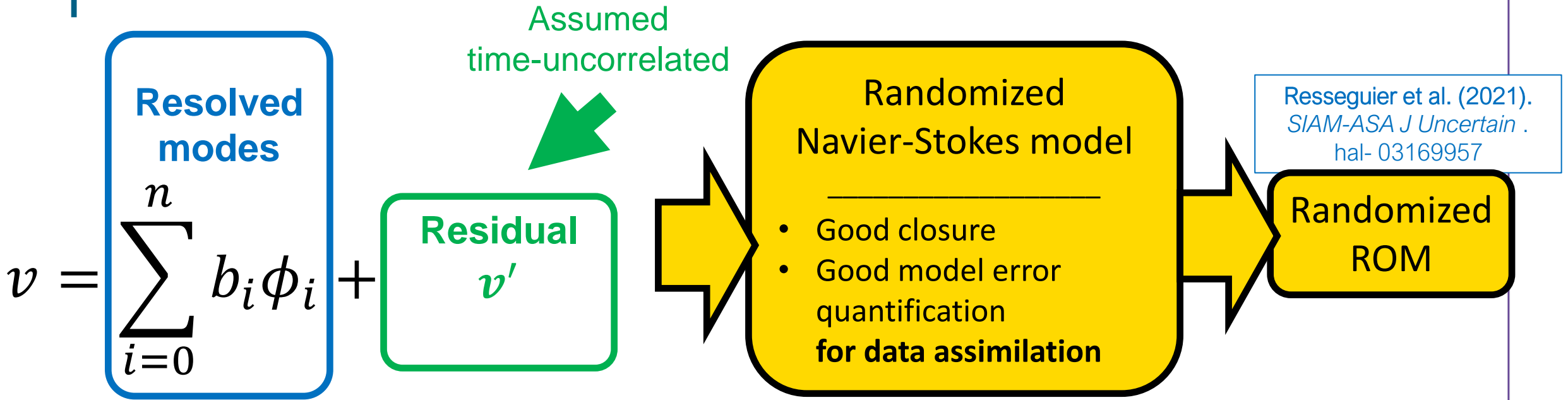

References :

Mikulevicius & Rozovskii, 2004  
Flandoli, 2011

LUM	SALT
Memin, 2014 <b>Resseguier et al. 2017 a, b, c,</b> d Cai et al. 2017 Chapron et al. 2018 Yang & Memin 2019 ...	Crisan et al., 2017 Gay-Balmaz & Holm 2017 Cotter and al. 2018 a, b Cotter and al. 2019 ...
Cotter and al. 2017    Resseguier et al. 2020, 2021a, Zhen et al., 2023	

# SUMMARY

## Stochastic ROM (SROM) + Data assimilation

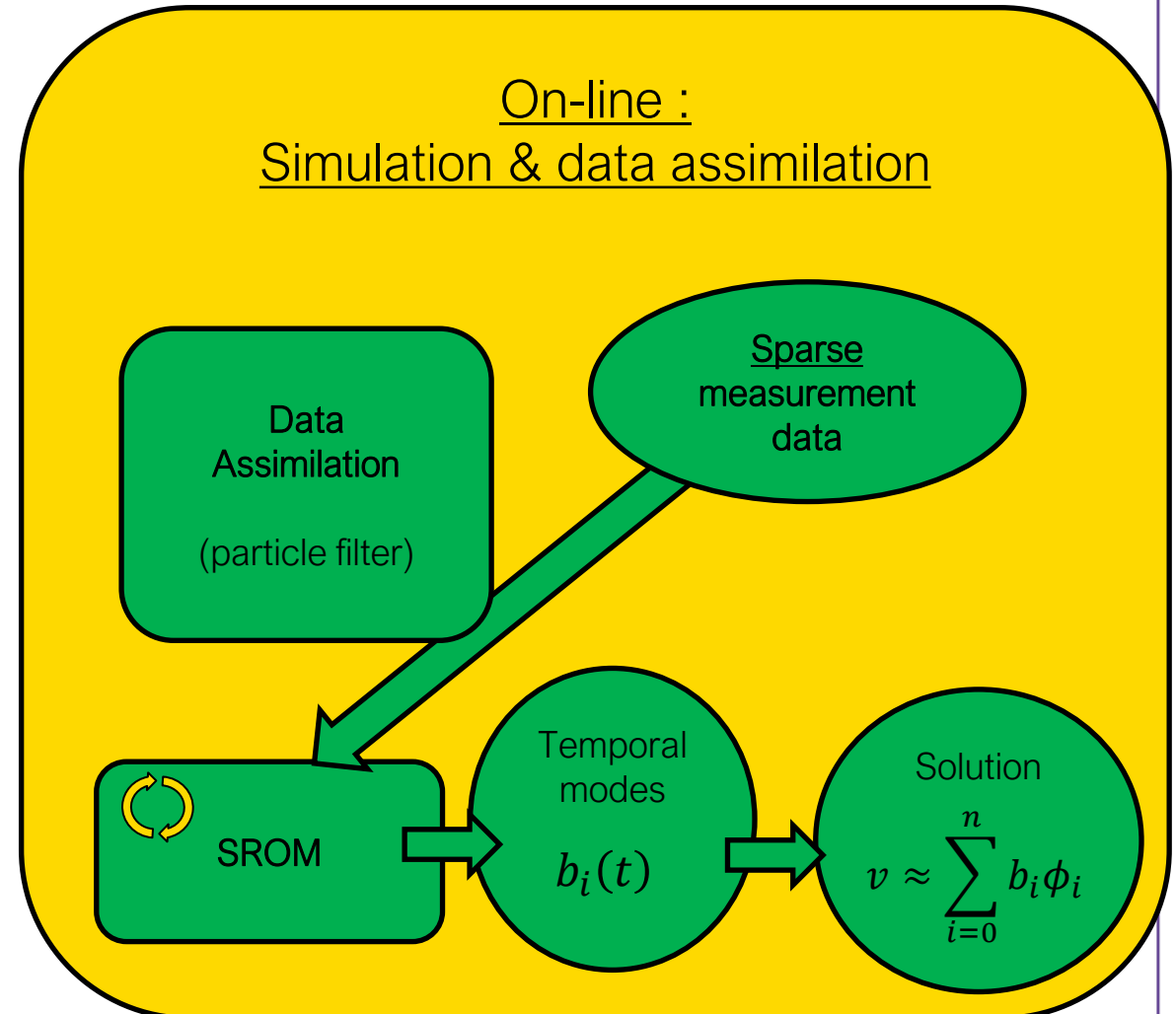
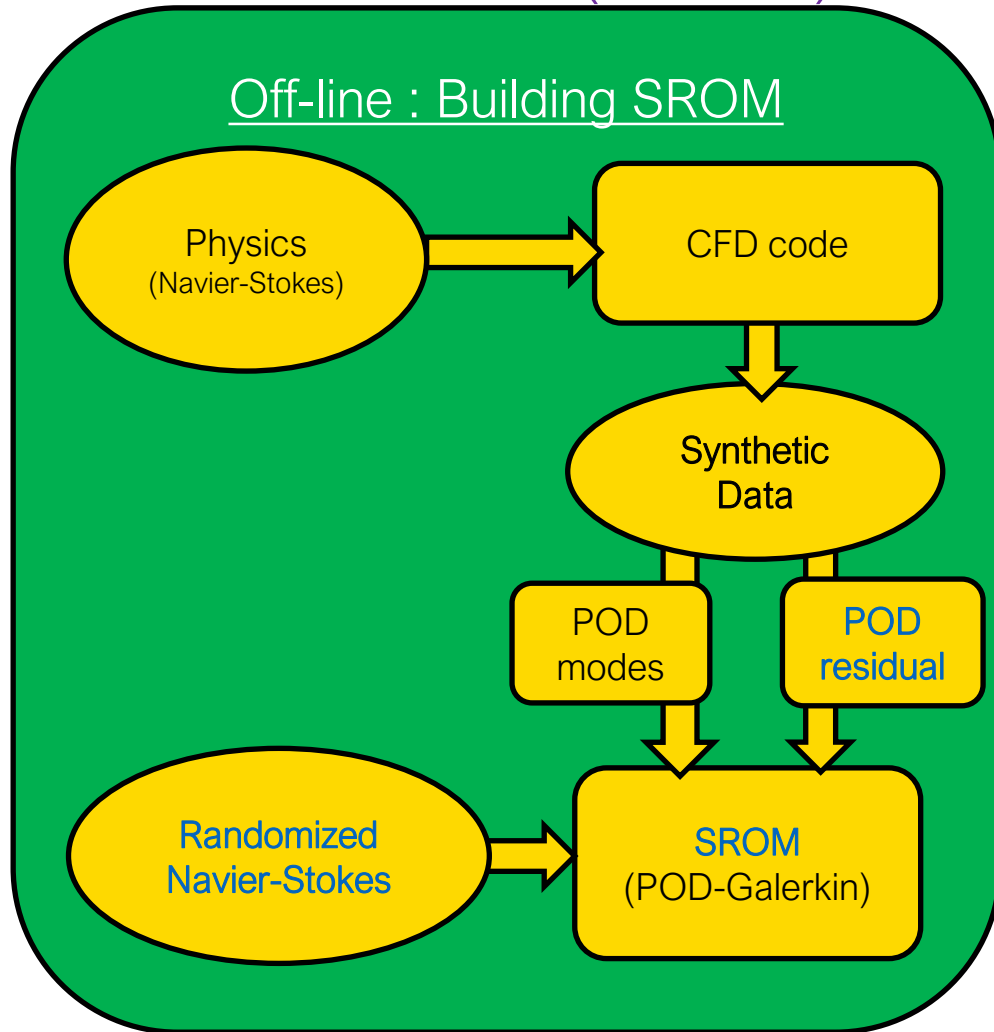

# SUMMARY

## Stochastic ROM (SROM) + Data assimilation

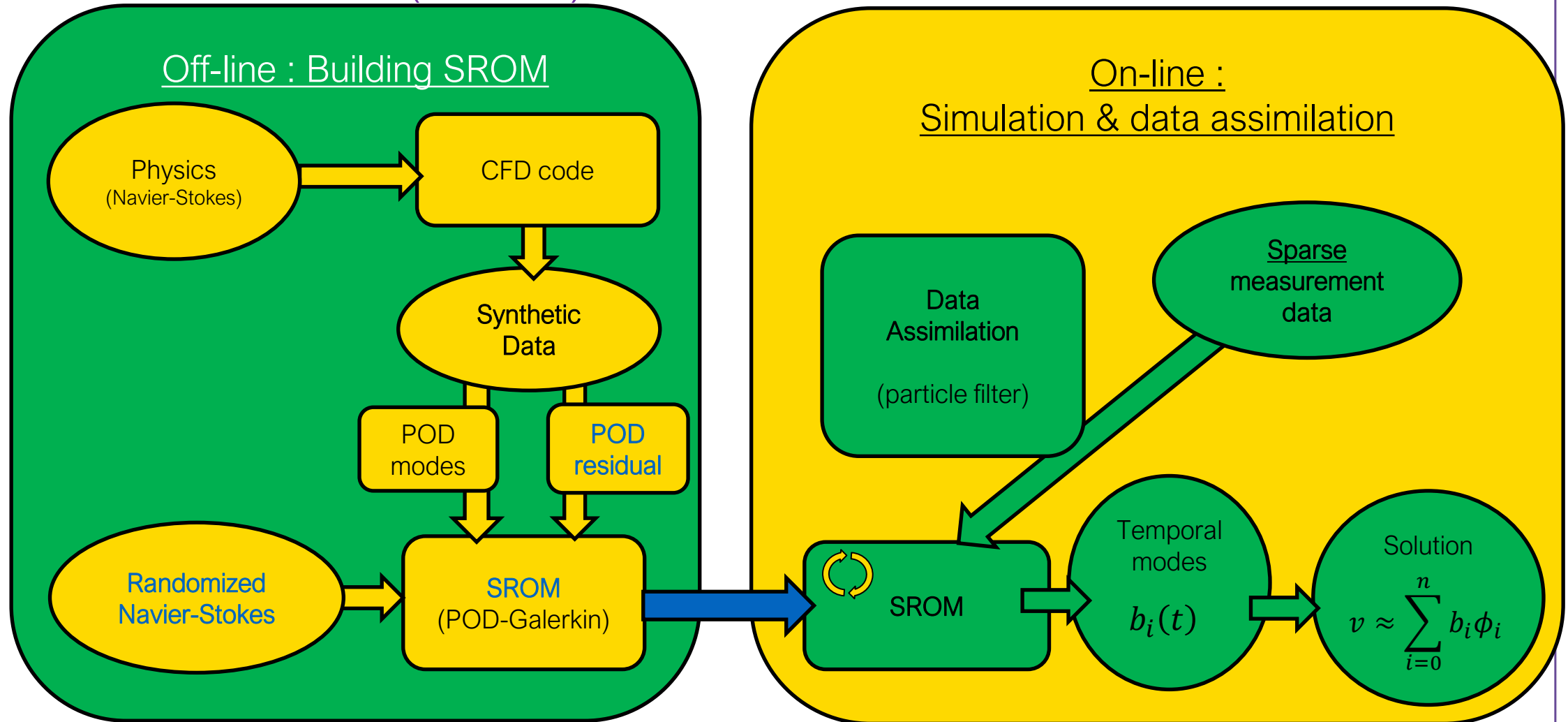

# SUMMARY

## Stochastic ROM (SROM) + Data assimilation

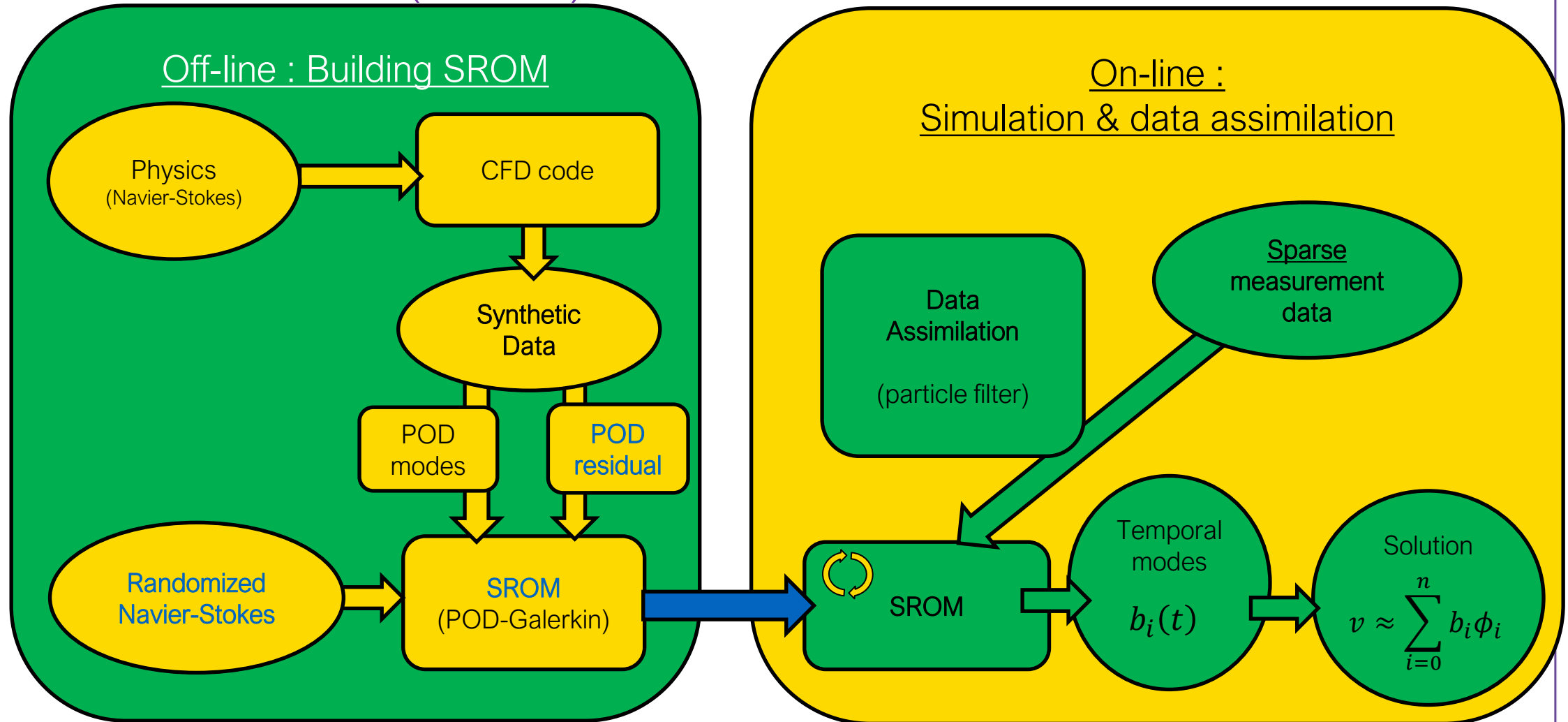

# PART III

## New implementation & results





# Stochastic ROM (SROM) + Data assimilation with Incompact3d (finite differences)

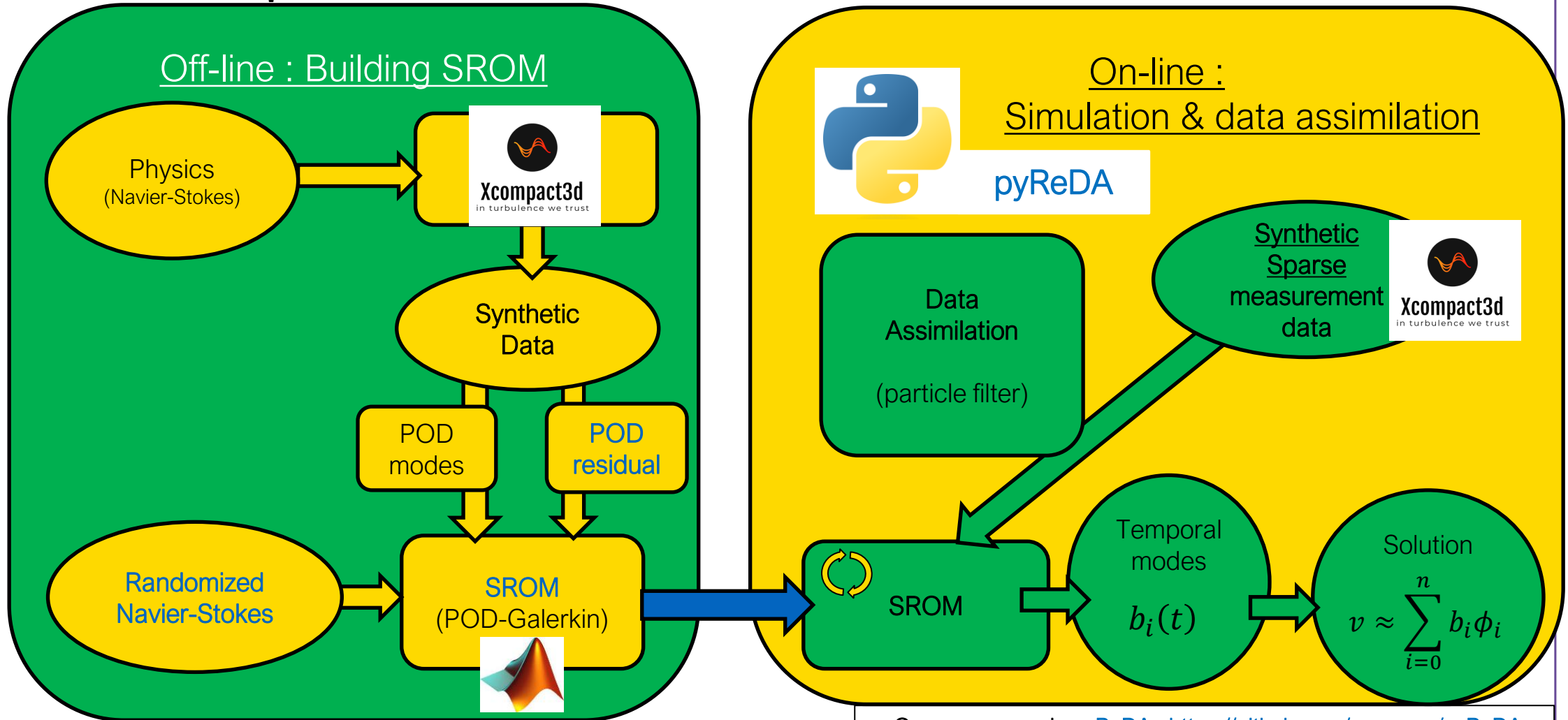

- Opensource code **pyReDA** : <https://github.com/vressegu/pyReDA>
- Resseguier et al. (2022). *J Comp.Phys* . hal-03445455

# DATA ASSIMILATION RESULTS

with **Incompact3d** (finite differences)



# DATA ASSIMILATION RESULTS

with Incompact3d (finite differences)



From  $10^7$  to 8 degrees of freedom

 Single measurement point (blurred & noisy velocity)

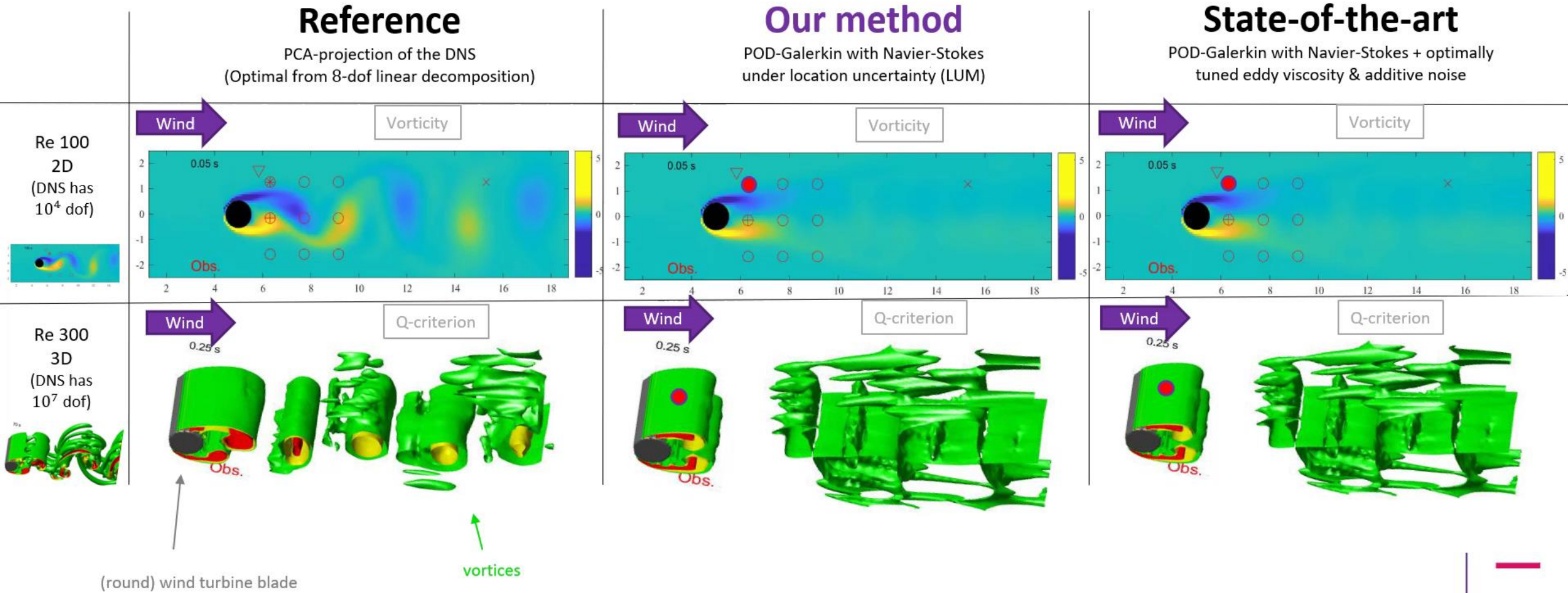

# Stochastic ROM (SROM) + Data assimilation Scale up with OpenFOAM & Ithaca-FV



OpenFOAM®

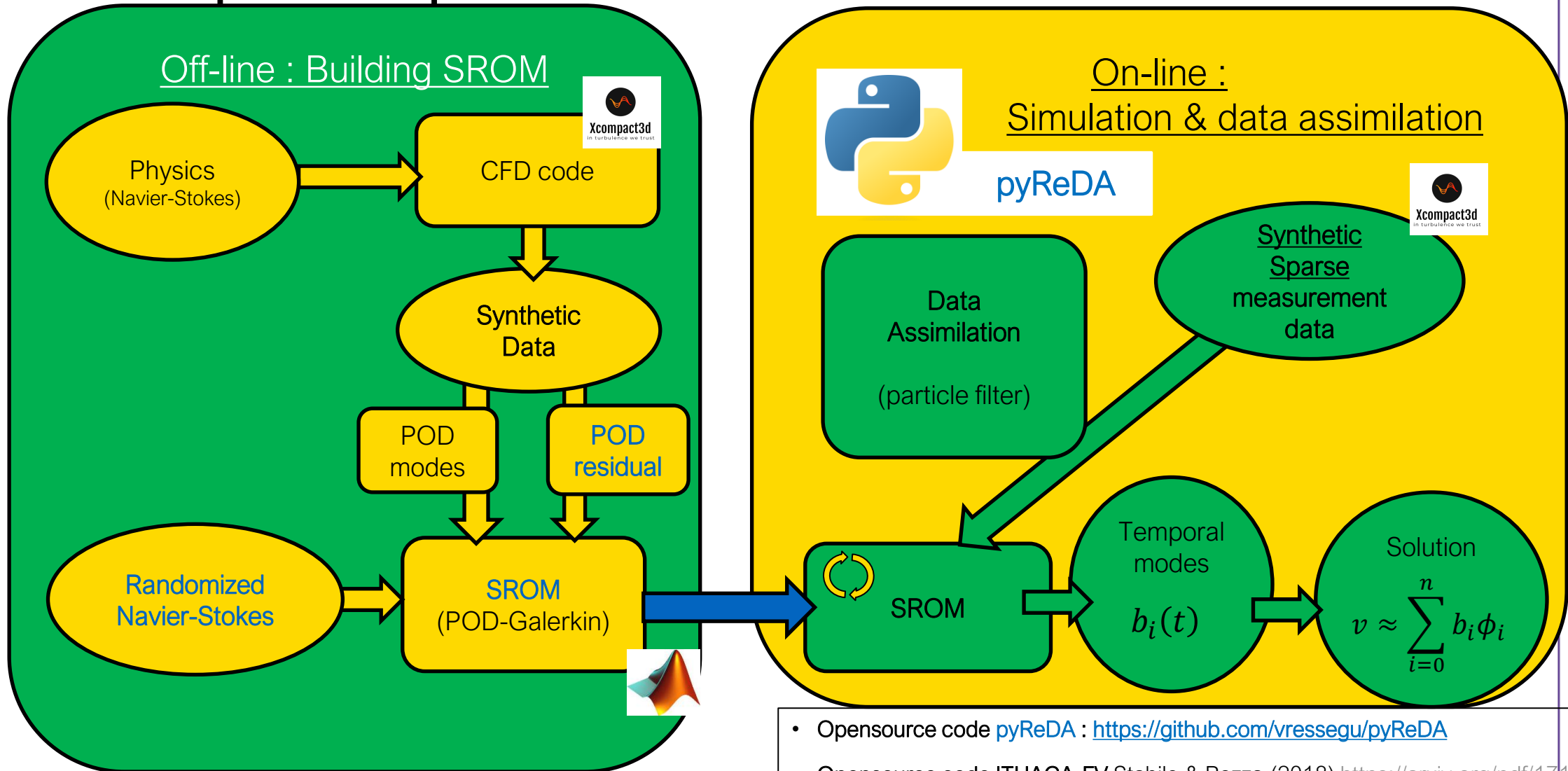

• Opensource code **pyReDA** : <https://github.com/vressegu/pyReDA>

• Opensource code ITHACA-FV Stabile & Rozza (2018) <https://arxiv.org/pdf/1710.11580>

# Stochastic ROM (SROM) + Data assimilation Scale up with OpenFOAM & Ithaca-FV



OpenFOAM®

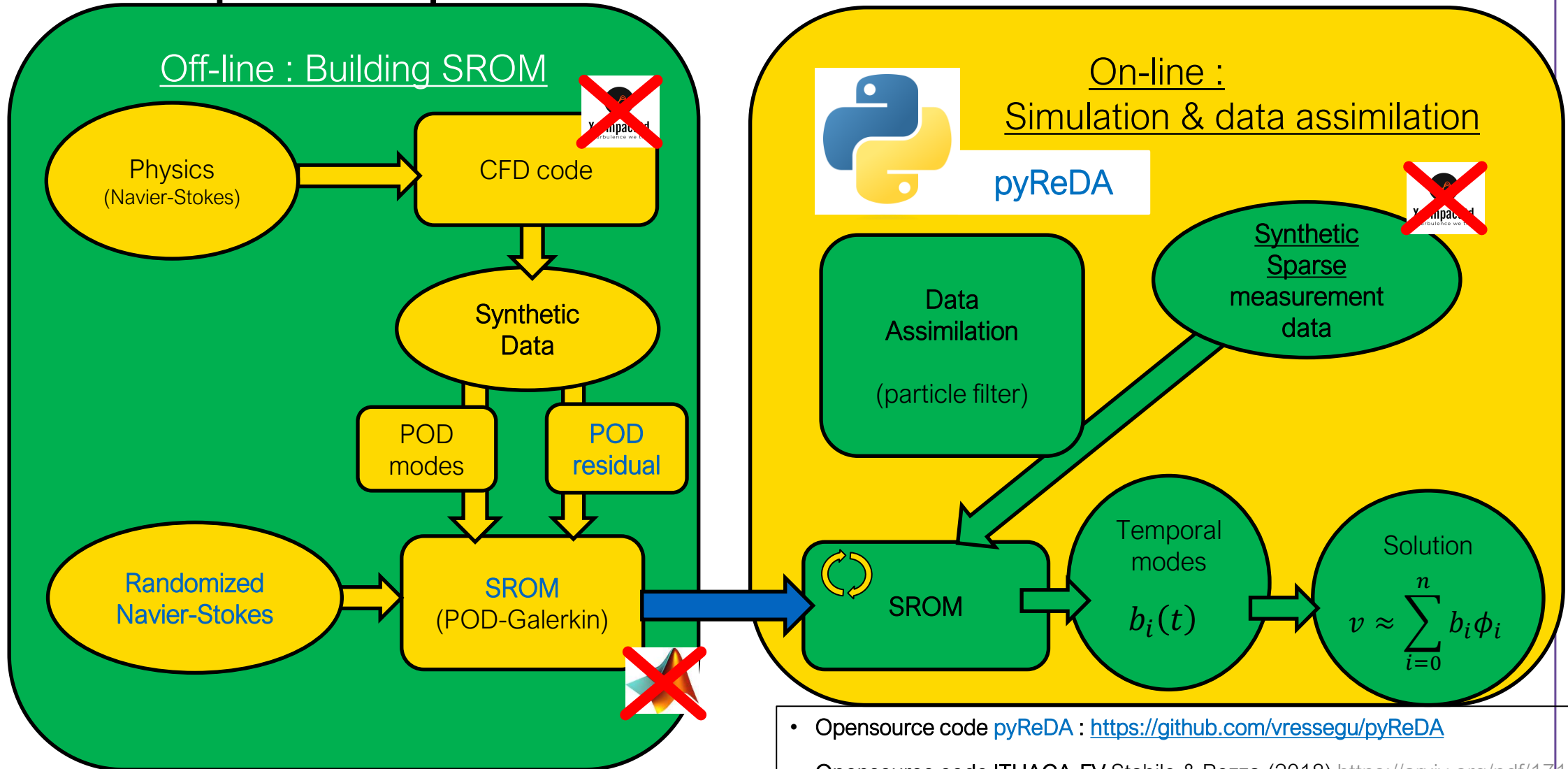

- Opensource code **pyReDA** : <https://github.com/vressegu/pyReDA>
- Opensource code ITHACA-FV Stabile & Rozza (2018) <https://arxiv.org/pdf/1710.11580>

# Stochastic ROM (SROM) + Data assimilation Scale up with OpenFOAM & Ithaca-FV



OpenFOAM®

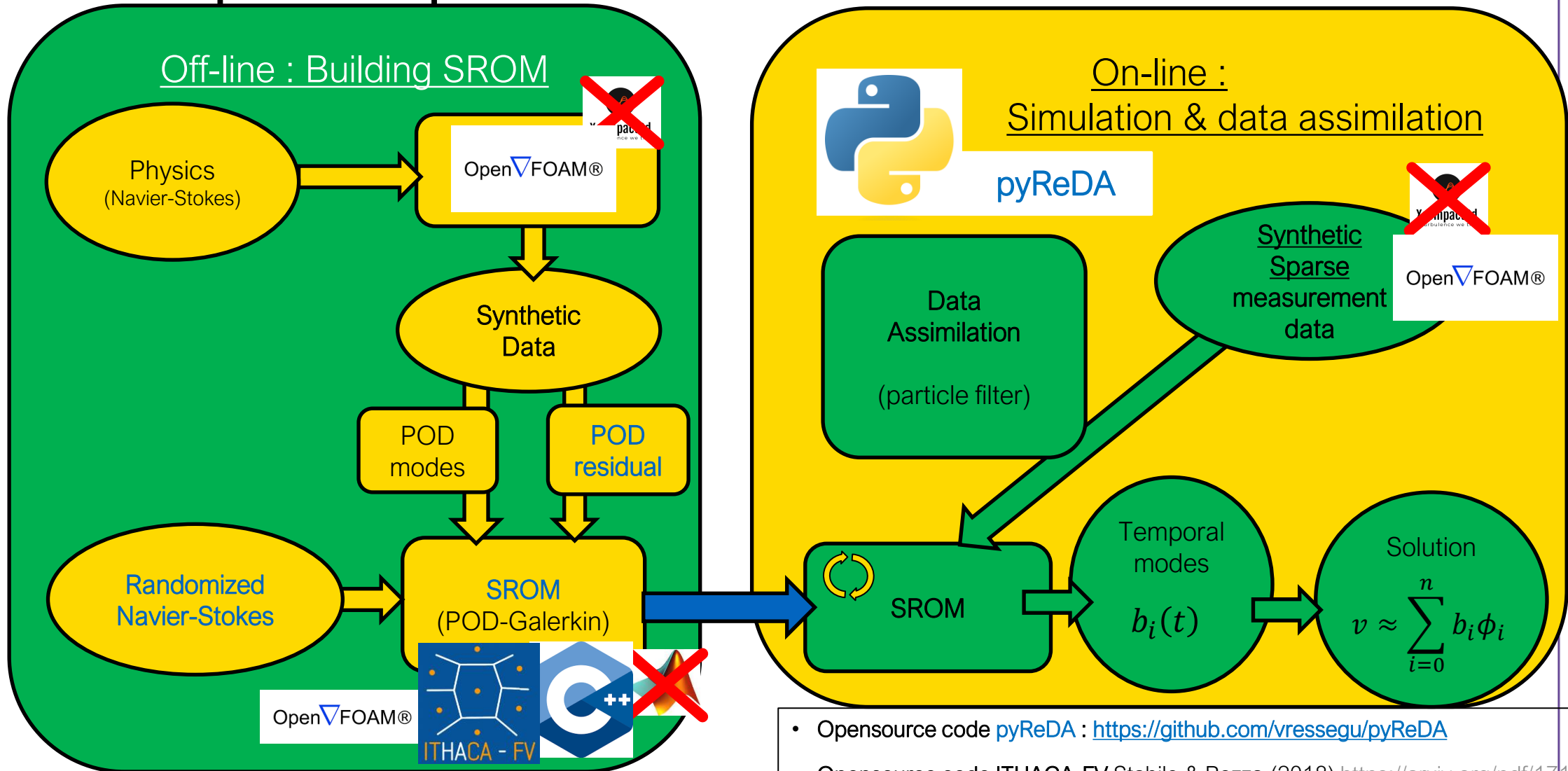

- Opensource code **pyReDA** : <https://github.com/vressegu/pyReDA>
- Opensource code **ITHACA-FV** Stabile & Rozza (2018) <https://arxiv.org/pdf/1710.11580>



# DATA ASSIMILATION RESULTS

## with OpenFOAM & Ithaca-FV

**DNS**  
 “true” simulation  
 ( $10^7$  degrees of freedom)

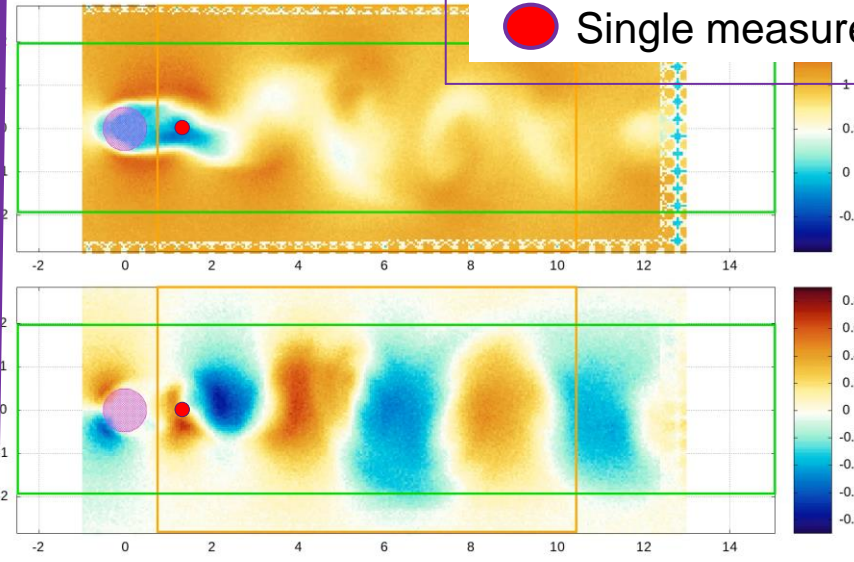
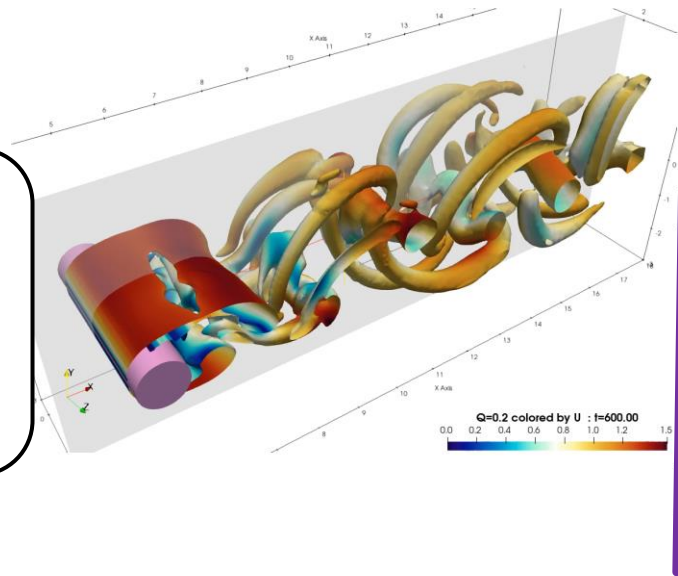

From  $10^7$  to 4 degrees of freedom

● Single measurement point (blurred & noisy velocity)

**Synthetic PIV**  
 blurred & noisy  
 2D velocity

**Reference :**  
 PCA-projection of the  
 “true” simulation  
 (DNS)  
 (Optimal from 4-  
 degrees of freedom  
 linear decomposition)

**Our method :**  
 Data assimilation  
 with  
 POD-Galerkin of  
 randomized  
 Navier-Stokes  
 (LUM)  
 (4 degrees of freedom)

# DATA ASSIMILATION RESULTS with OpenFOAM & Ithaca-FV

Flashback!

From  $10^7$  to 4 degrees of freedom

DNS  
"true" simulation  
( $10^7$  degrees of freedom)

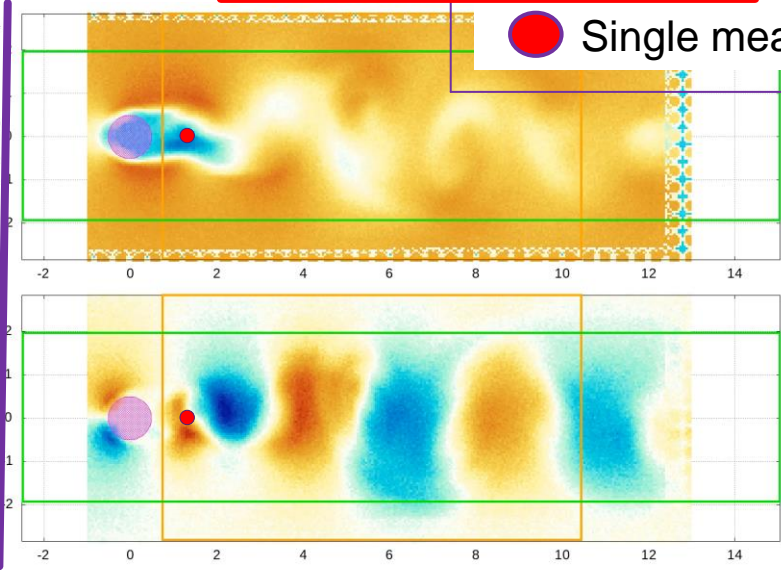
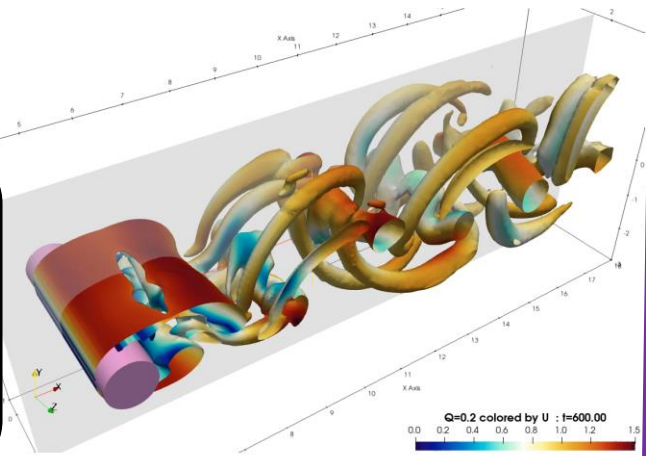

● Single measurement point (blurred & noisy velocity)

Synthetic PIV  
blurred & noisy  
2D velocity

**Reference :**  
PCA-projection of the  
"true" simulation  
(DNS)  
(Optimal from 4-  
degrees of freedom  
linear decomposition)

**Our method :**  
Data assimilation  
with  
POD-Galerkin of  
randomized  
Navier-Stokes  
(LUM)  
(4 degrees of freedom)



# DATA ASSIMILATION RESULTS with OpenFOAM & Ithaca-FV

Flashback!

From  $10^7$  to 4 degrees of freedom

**DNS**  
"true" simulation  
( $10^7$  degrees of freedom)

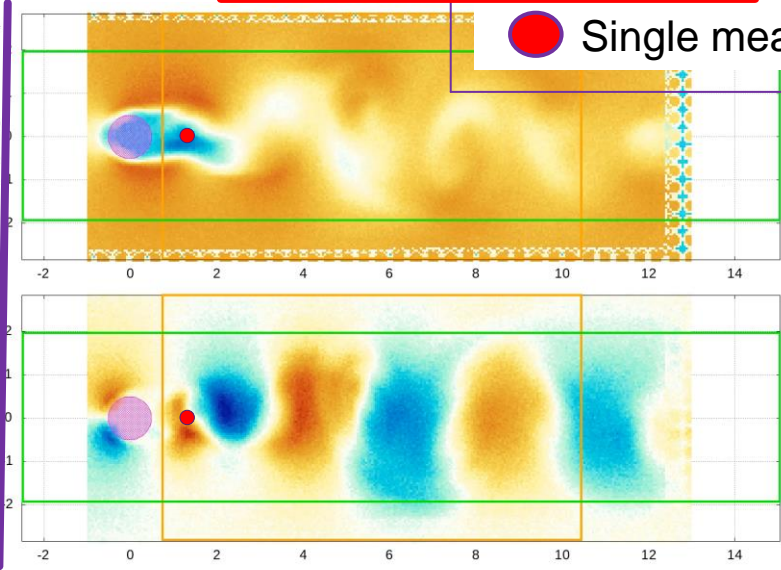
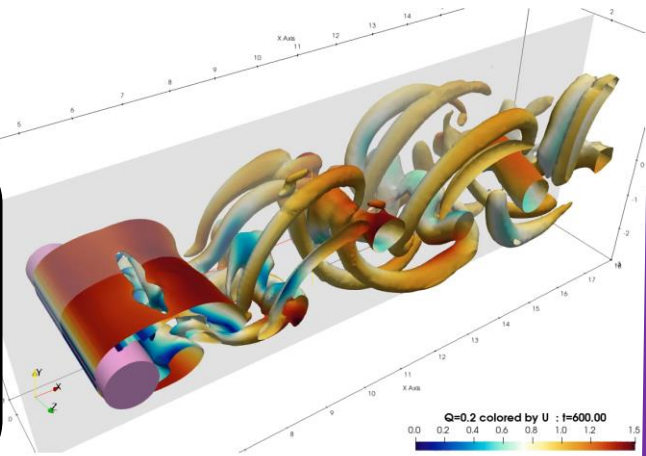

● Single measurement point (blurred & noisy velocity)

Synthetic PIV  
blurred & noisy  
2D velocity

**Reference :**  
PCA-projection of the  
"true" simulation  
(DNS)  
(Optimal from 4-  
degrees of freedom  
linear decomposition)

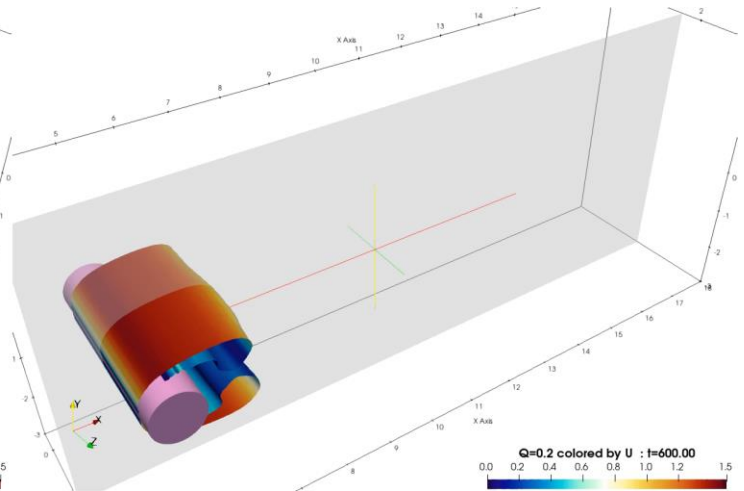
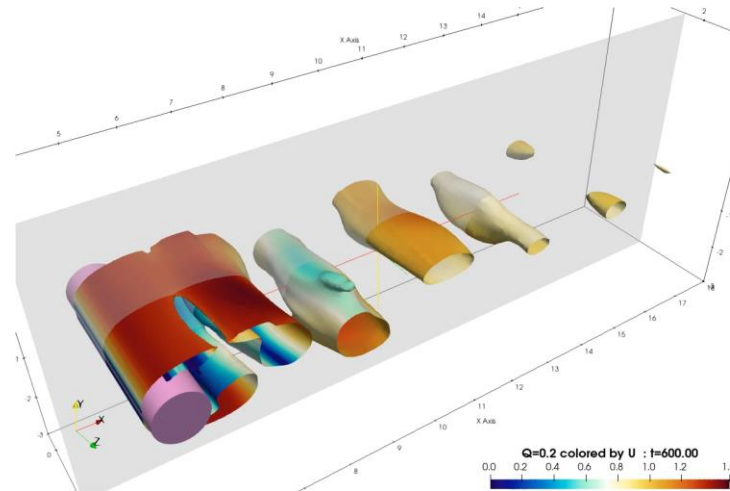

**Our method :**  
Data assimilation  
with  
POD-Galerkin of  
randomized  
Navier-Stokes  
(LUM)  
(4 degrees of freedom)

# Stochastic ROM (SROM) + Data assimilation

## Generalizable ???

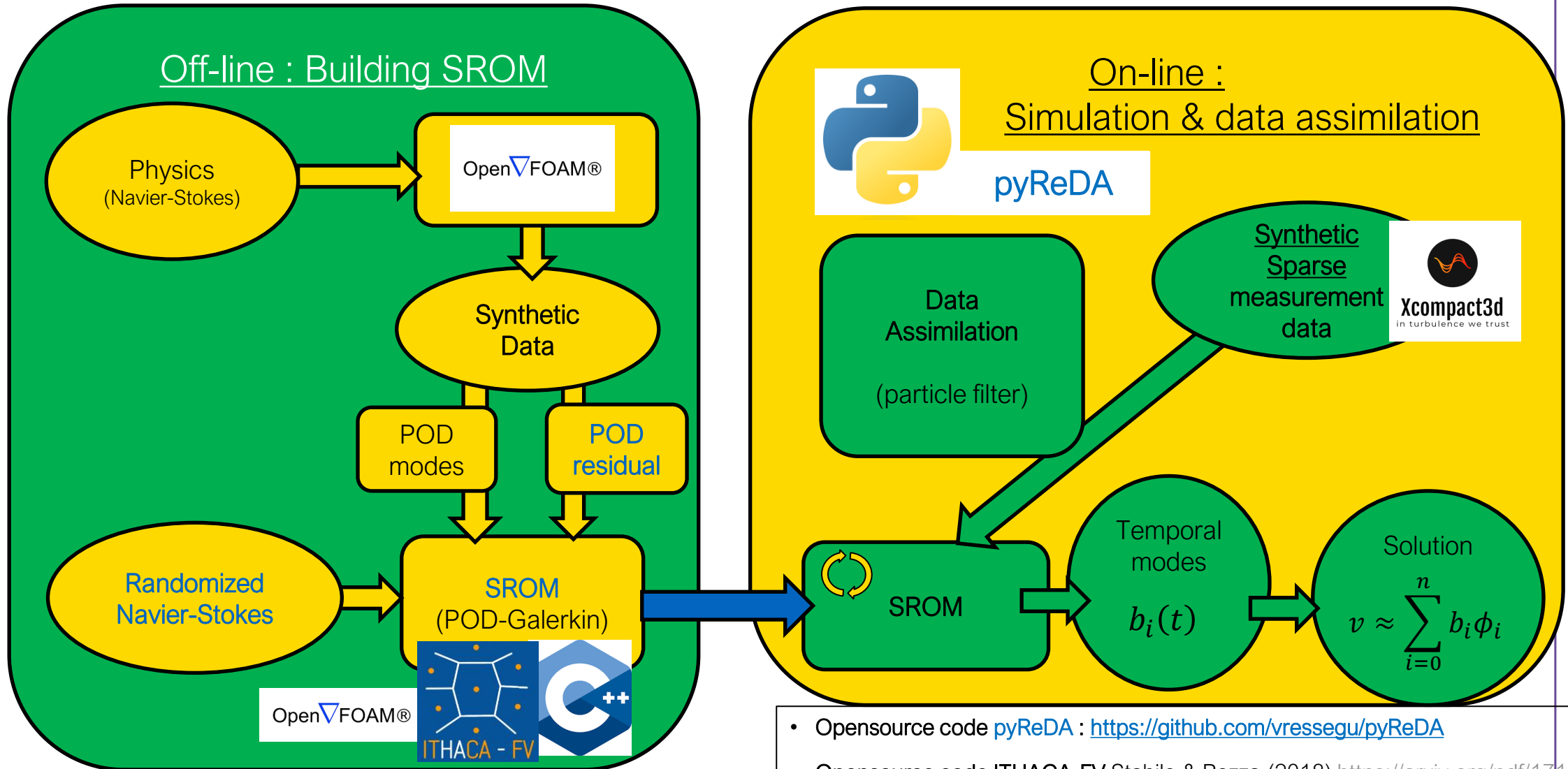

- Opensource code `pyReDA` : <https://github.com/vressegu/pyReDA>
- Opensource code ITHACA-FV Stabile & Rozza (2018) <https://arxiv.org/pdf/1710.11580>

# Stochastic ROM (SROM) + Data assimilation

## Generalizable ???

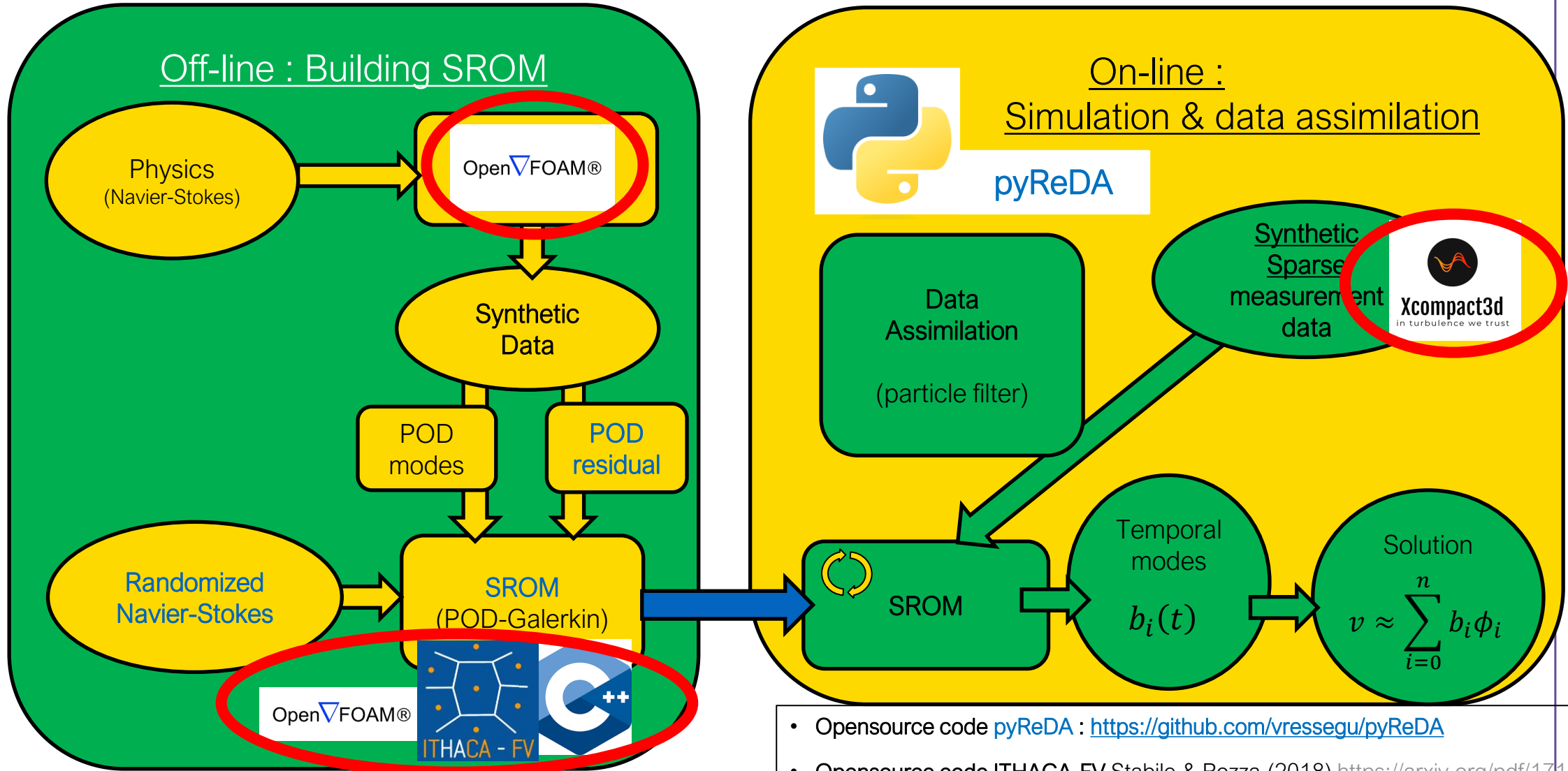

- Opensource code pyReDA : <https://github.com/vressegu/pyReDA>
- Opensource code ITHACA-FV Stabile & Rozza (2018) <https://arxiv.org/pdf/1710.11580>

# DATA ASSIMILATION RESULTS

## Generalizable ???

Test with

- OpenFOAM (finite volumes) train set
- Incompact3d (finite differences) test set

From  $10^7$  to 4 degrees of freedom

 Single measurement point (blurred & noisy velocity)

### Reference :

PCA-projection of the  
"true" simulation  
(DNS)  
(Optimal from 4-  
degrees of freedom  
linear decomposition)

### Our method :

Data assimilation  
with  
POD-Galerkin of  
randomized  
Navier-Stokes  
(LUM)  
(4 degrees of freedom)

# DATA ASSIMILATION RESULTS

## Generalizable ???

Test with

- OpenFOAM (finite volumes) train set
- Incompact3d (finite differences) test set

From  $10^7$  to 4 degrees of freedom

 Single measurement point (blurred & noisy velocity)

**Reference :**  
PCA-projection of the  
“true” simulation  
(DNS)  
(Optimal from 4-  
degrees of freedom  
linear decomposition)

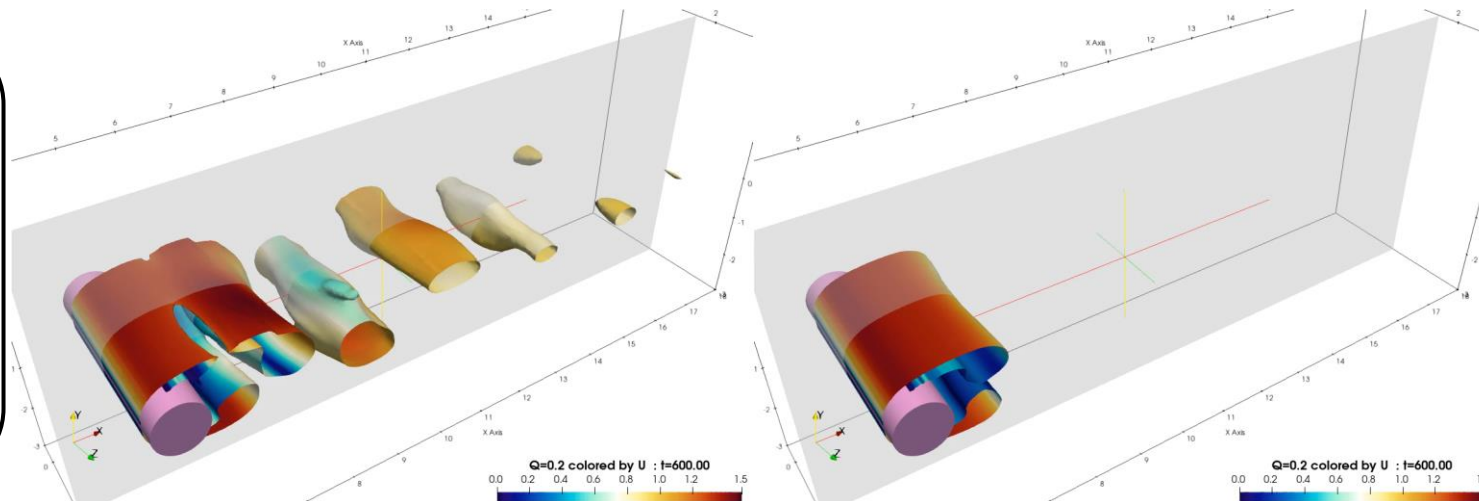

**Our method :**  
Data assimilation  
with  
POD-Galerkin of  
randomized  
Navier-Stokes  
(LUM)  
(4 degrees of freedom)

# CONCLUSION



# CONCLUSION

- ▶ Reduced order model (ROM) : for very fast and robust CFD ( $10^7 \rightarrow O(10)$  degrees of freedom.)
  - Combine data & physics (built off-line)
  - Closure problem handled by LUM
  - Now implemented in OpenFOAM / ITHACA-FV
- ▶ Data assimilation : to correct the fast simulation on-line by incomplete/noisy measurements
  - Model error quantification handled by LUM
- ▶ Results
  - Optimal **unsteady 3D flow** estimation/prediction in the whole spatial domain (large-scale structures)
  - Robust far outside the training set (time extrapolation / out of sample)



## CONCLUSION

- ▶ Reduced order model (ROM) : for very fast and robust CFD ( $10^7 \rightarrow O(10)$  degrees of freedom.)
  - Combine data & physics (built off-line)    ▪ Now implemented in OpenFOAM / ITHACA-FV
  - Closure problem handled by LUM
- ▶ Data assimilation : to correct the fast simulation on-line by incomplete/noisy measurements
  - Model error quantification handled by LUM
- ▶ Results
  - Optimal **unsteady 3D flow** estimation/prediction in the whole spatial domain (large-scale structures)
  - Robust far outside the training set (time extrapolation / out of sample)

## WORK IN PROGRESS:

- ▶ Increasing Reynolds (ROM of LES, DDES)
  - Hyperreduction (=interpolation with a POD basis) of turbulence model terms





# BONUS SLIDES



# LOCATION UNCERTAINTY MODELS (LUM), Randomized incompressible Navier-Stokes

$$v = w + v'$$

Resolved fluid velocity:  
 $w$

Unresolved fluid velocity:  
 $v' = \sigma \dot{B}$  (Gaussian, white wrt  $t$ )  
(assuming  $\nabla \cdot w = 0$  and  $\nabla \cdot v' = 0$ )

Momentum conservation

$$\frac{Dw}{Dt} = F \text{ (Forces)}$$

# LOCATION UNCERTAINTY MODELS (LUM), Randomized Navier-Stokes

$$v = w + v'$$

Resolved fluid velocity:

$w$

Unresolved fluid velocity:

$$v' = \sigma \dot{B} \text{ (Gaussian, white wrt } t)$$

(assuming  $\nabla \cdot w = 0$  and  $\nabla \cdot v' = 0$ )

Variance tensor:

$$a(x, x) = \frac{\mathbb{E}\{(\sigma dB_t)(\sigma dB_t)^T\}}{dt}$$

$$\partial_t w + w^* \cdot \nabla w + \sigma \dot{B} \cdot \nabla w - \nabla \cdot \left( \frac{1}{2} a \nabla w \right) = F$$

From Ito-Wentzell  
formula (Kunita 1990)  
with Ito notations

# LOCATION UNCERTAINTY MODELS (LUM), Randomized Navier-Stokes

$$v = w + v'$$

Resolved fluid velocity:

$w$

Unresolved fluid velocity:

$$v' = \sigma \dot{B} \text{ (Gaussian, white wrt } t)$$

(assuming  $\nabla \cdot w = 0$  and  $\nabla \cdot v' = 0$ )

Variance tensor:

$$a(x, x) = \frac{\mathbb{E}\{(\sigma dB_t)(\sigma dB_t)^T\}}{dt}$$

Advection

$$\partial_t w + w^* \cdot \nabla w + \sigma \dot{B} \cdot \nabla w - \nabla \cdot \left( \frac{1}{2} a \nabla w \right) = F$$

From Ito-Wentzell  
formula (Kunita 1990)  
with Ito notations

# LOCATION UNCERTAINTY MODELS (LUM), Randomized Navier-Stokes

$$v = w + v'$$

Resolved fluid velocity:

$w$

Unresolved fluid velocity:

$$v' = \sigma \dot{B} \text{ (Gaussian, white wrt } t)$$

(assuming  $\nabla \cdot w = 0$  and  $\nabla \cdot v' = 0$ )

Variance tensor:

$$a(x, x) = \frac{\mathbb{E}\{(\sigma dB_t)(\sigma dB_t)^T\}}{dt}$$

$$\partial_t w + \underbrace{w^* \cdot \nabla w + \sigma \dot{B} \cdot \nabla w}_{\text{Advection}} - \underbrace{\nabla \cdot \left( \frac{1}{2} a \nabla w \right)}_{\text{"Turbulent" diffusion}} = F$$

From Ito-Wentzell  
formula (Kunita 1990)  
with Ito notations

# LOCATION UNCERTAINTY MODELS (LUM), Randomized Navier-Stokes

From Ito-Wentzell  
formula (Kunita 1990)  
with Ito notations

$$v = w + v'$$

Resolved fluid velocity:  
 $w$

Unresolved fluid velocity:  
 $v' = \sigma \dot{B}$  (Gaussian, white wrt  $t$ )

(assuming  $\nabla \cdot w = 0$  and  $\nabla \cdot v' = 0$ )

Variance tensor:

$$a(x, x) = \frac{\mathbb{E}\{(\sigma dB_t)(\sigma dB_t)^T\}}{dt}$$

$$\partial_t w + \underbrace{w^* \cdot \nabla w + \sigma \dot{B} \cdot \nabla w}_{\text{Advection}} - \underbrace{\nabla \cdot \left( \frac{1}{2} a \nabla w \right)}_{\text{"Turbulent" diffusion}} = \underbrace{F}_{\text{Forces}}$$

# LOCATION UNCERTAINTY MODELS (LUM), Randomized Navier-Stokes

From Ito-Wentzell formula (Kunita 1990) with Ito notations

$v = w + v'$

Resolved fluid velocity:  
 $w$

Unresolved fluid velocity:  
 $v' = \sigma \dot{B}$  (Gaussian, white wrt  $t$ )  
(assuming  $\nabla \cdot w = 0$  and  $\nabla \cdot v' = 0$ )

Variance tensor:  
 $a(x, x) = \frac{\mathbb{E}\{(\sigma dB_t)(\sigma dB_t)^T\}}{dt}$

$$\partial_t w + w^* \cdot \nabla w + \sigma \dot{B} \cdot \nabla w - \nabla \cdot \left( \frac{1}{2} a \nabla w \right) = F$$

Advection

"Turbulent" diffusion

Forces

Usual terms

# LOCATION UNCERTAINTY MODELS (LUM), Randomized Navier-Stokes

From Ito-Wentzell formula (Kunita 1990) with Ito notations

$v = w + v'$

Resolved fluid velocity:  
 $w$

Unresolved fluid velocity:  
 $v' = \sigma \dot{B}$  (Gaussian, white wrt  $t$ )  
(assuming  $\nabla \cdot w = 0$  and  $\nabla \cdot v' = 0$ )

Variance tensor:  
 $a(x, x) = \frac{\mathbb{E}\{(\sigma dB_t)(\sigma dB_t)^T\}}{dt}$

$$\partial_t w + w^* \cdot \nabla w + \sigma \dot{B} \cdot \nabla w - \nabla \cdot \left( \frac{1}{2} a \nabla w \right) = F$$

Usual terms

Skew-symmetric multiplicative random forcing



# LOCATION UNCERTAINTY MODELS (LUM), Randomized Navier-Stokes

From Ito-Wentzell formula (Kunita 1990) with Ito notations

$v = w + v'$

Resolved fluid velocity:  
 $w$

Unresolved fluid velocity:  
 $v' = \sigma \dot{B}$  (Gaussian, white wrt  $t$ )  
(assuming  $\nabla \cdot w = 0$  and  $\nabla \cdot v' = 0$ )

Variance tensor:  
 $a(x, x) = \frac{\mathbb{E}\{(\sigma dB_t)(\sigma dB_t)^T\}}{dt}$

$$\partial_t w + w^* \cdot \nabla w + \sigma \dot{B} \cdot \nabla w - \nabla \cdot \left( \frac{1}{2} a \nabla w \right) = F$$

Advection

"Turbulent" diffusion

Forces

Usual terms

Skew-symmetric multiplicative random forcing

# LOCATION UNCERTAINTY MODELS (LUM), Randomized Navier-Stokes

$v = w + v'$

Resolved fluid velocity:  
 $w$

Unresolved fluid velocity:  
 $v' = \sigma \dot{B}$  (Gaussian, white wrt  $t$ )  
(assuming  $\nabla \cdot w = 0$  and  $\nabla \cdot v' = 0$ )

Variance tensor:  
 $a(x, x) = \frac{\mathbb{E}\{(\sigma dB_t)(\sigma dB_t)^T\}}{dt}$

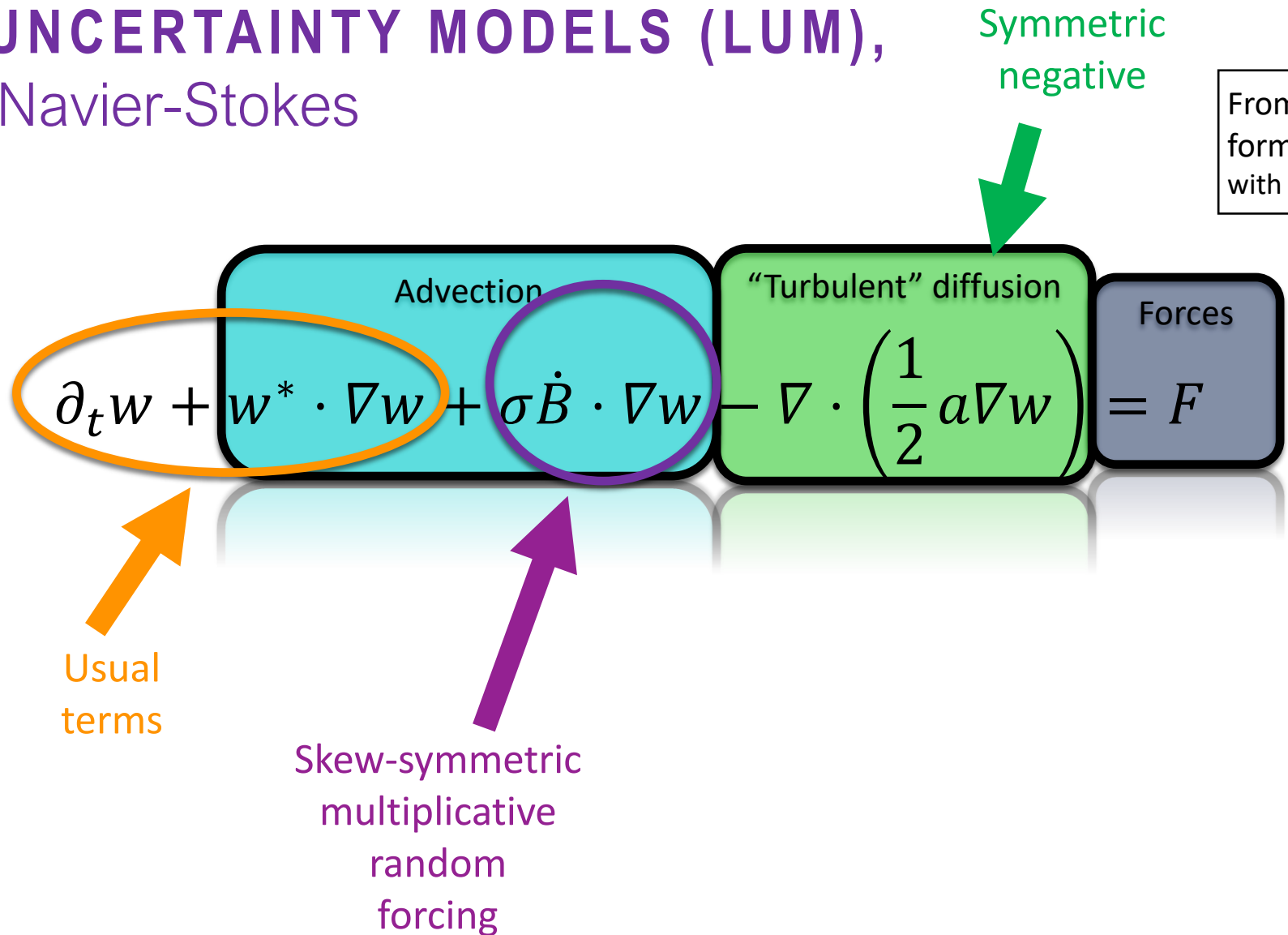

From Ito-Wentzell formula (Kunita 1990) with Ito notations

# LOCATION UNCERTAINTY MODELS (LUM), Randomized Navier-Stokes

$v = w + v'$

Resolved fluid velocity:  
 $w$

Unresolved fluid velocity:  
 $v' = \sigma \dot{B}$  (Gaussian, white wrt  $t$ )  
(assuming  $\nabla \cdot w = 0$  and  $\nabla \cdot v' = 0$ )

Variance tensor:  
 $a(x, x) = \frac{\mathbb{E}\{(\sigma dB_t)(\sigma dB_t)^T\}}{dt}$

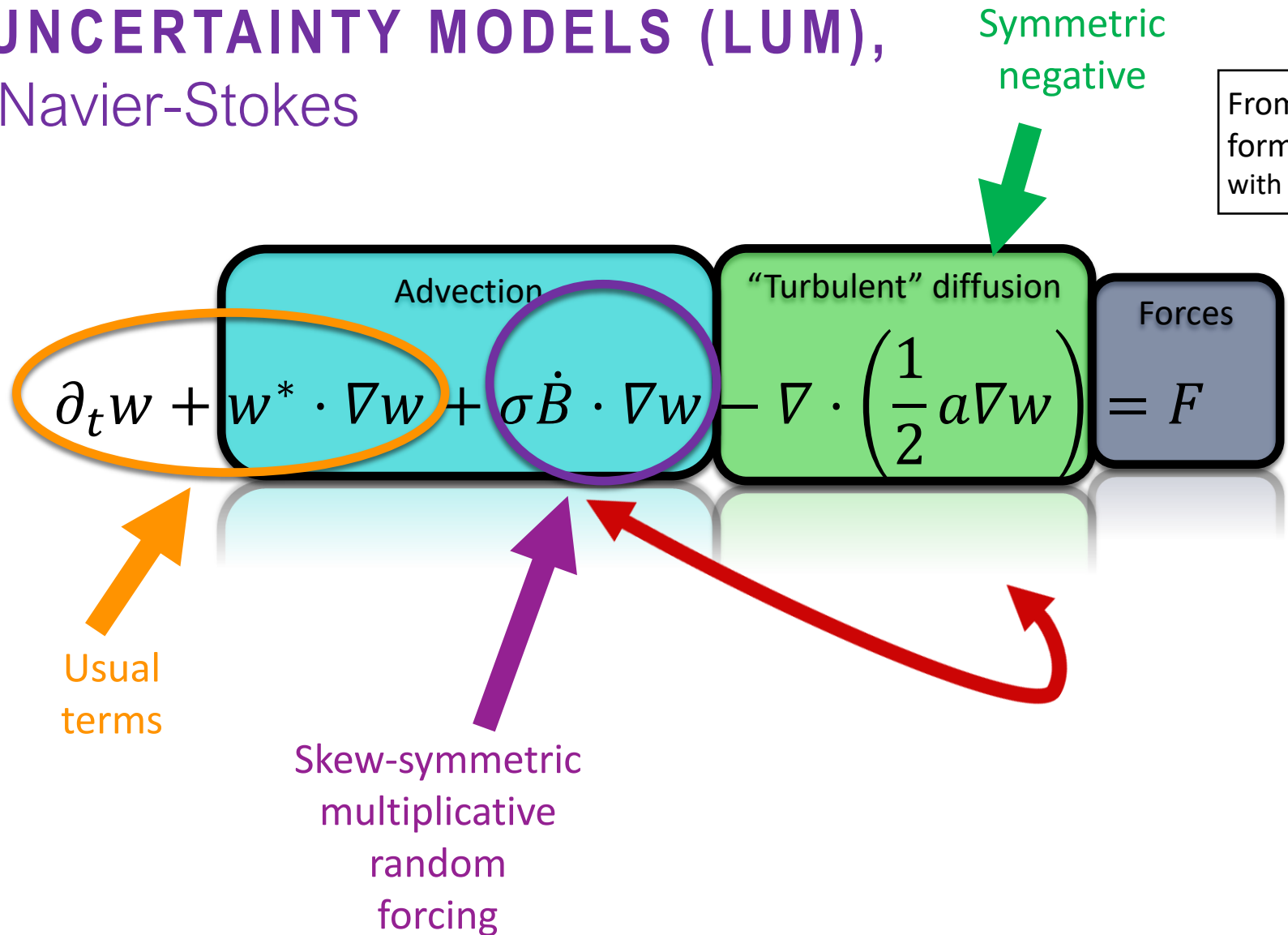

From Ito-Wentzell formula (Kunita 1990) with Ito notations

# LOCATION UNCERTAINTY MODELS (LUM), Randomized Navier-Stokes

$v = w + v'$

Resolved fluid velocity:  
 $w$

Unresolved fluid velocity:  
 $v' = \sigma \dot{B}$  (Gaussian, white wrt  $t$ )  
(assuming  $\nabla \cdot w = 0$  and  $\nabla \cdot v' = 0$ )

Variance tensor:  
 $a(x, x) = \frac{\mathbb{E}\{(\sigma dB_t)(\sigma dB_t)^T\}}{dt}$

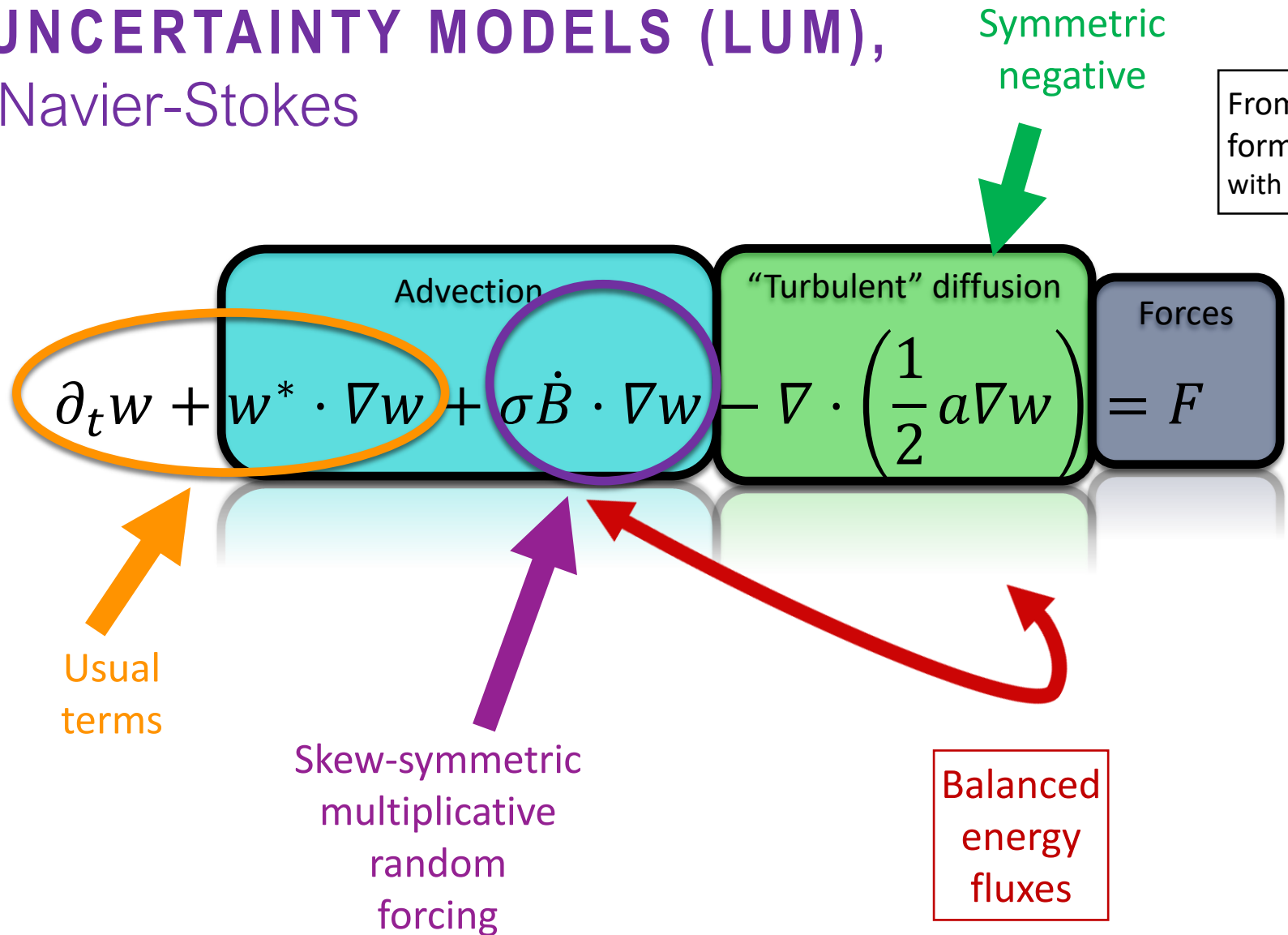

From Ito-Wentzell formula (Kunita 1990) with Ito notations

# LOCATION UNCERTAINTY MODELS (LUM), Randomized Navier-Stokes

$v = w + v'$

Resolved fluid velocity:  
 $w$

Unresolved fluid velocity:  
 $v' = \sigma \dot{B}$  (Gaussian, white wrt  $t$ )

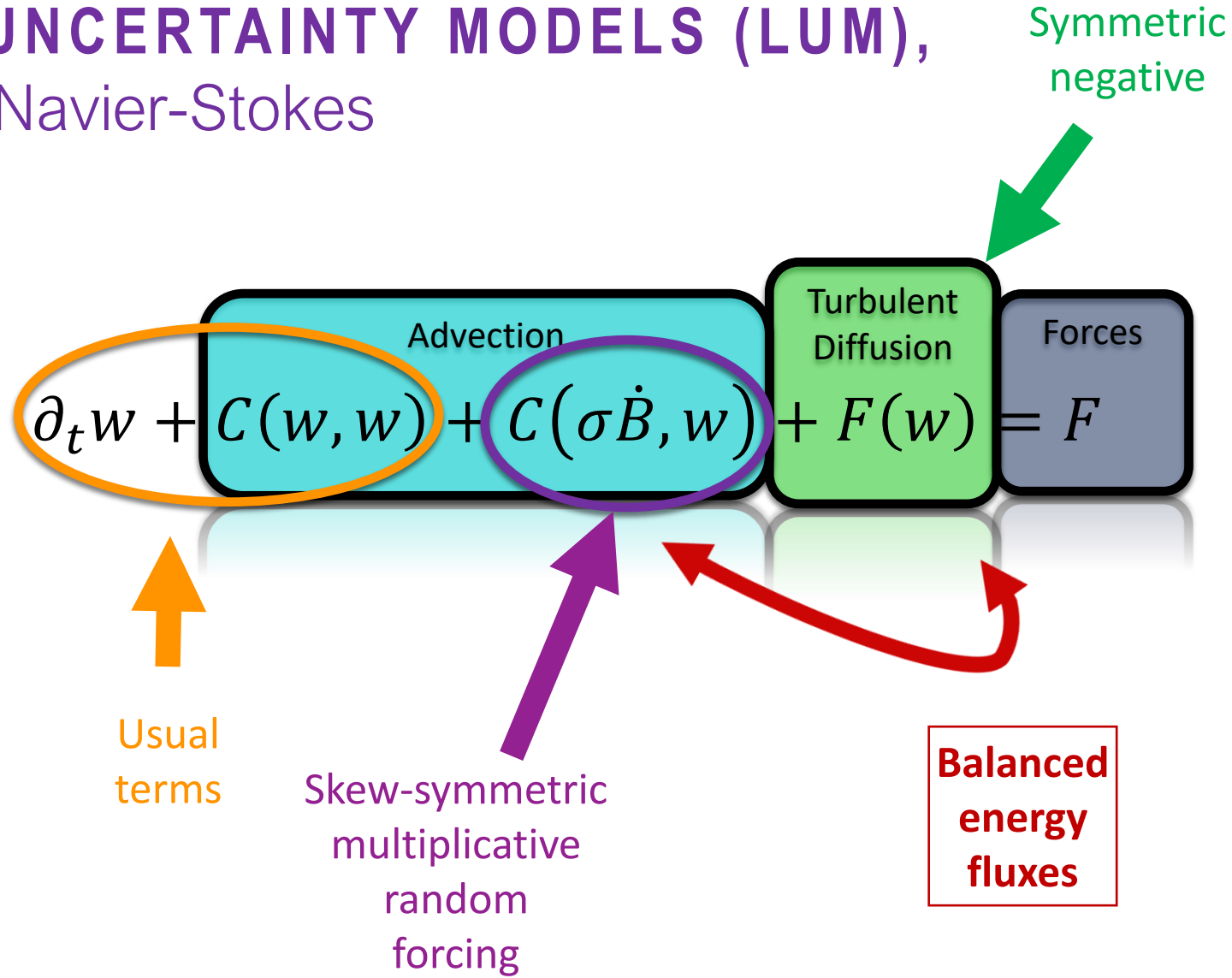

From Ito-Wentzell formula (Kunita 1990) with Ito notations

# REDUCED LUM (RED LUM)

POD-Galerkin gives SDEs for resolved modes

Full order :  $M \sim 10^7$   
 Reduced order :  $n \sim 10$

$$v = w + v'$$

Resolved fluid velocity:

$$w(x, t) = \sum_{i=0}^n b_i(t) \phi_i(x)$$

Unresolved fluid velocity:

$$v' = \sigma \dot{B} \text{ (Gaussian, white wrt } t)$$

Variance tensor:

$$a(x, x) = \frac{\mathbb{E}\{(\sigma dB_t)(\sigma dB_t)^T\}}{dt}$$

$$\int_{\Omega} \phi_i(x) \cdot (\partial_t w + C(w, w) + C(\sigma \dot{B}, w) + F(w) = F) dx$$

# REDUCED LUM (RED LUM)

POD-Galerkin gives SDEs for resolved modes

Full order :  $M \sim 10^7$   
 Reduced order :  $n \sim 10$

$v = w + v'$

Resolved fluid velocity:  
 $w(x, t) = \sum_{i=0}^n b_i(t) \phi_i(x)$

Unresolved fluid velocity:  
 $v' = \sigma \dot{B}$  (Gaussian, white wrt  $t$ )

Variance tensor:  
 $a(x, x) = \frac{\mathbb{E}\{(\sigma dB_t)(\sigma dB_t)^T\}}{dt}$

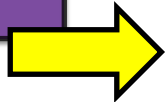

$$\int_{\Omega} \phi_i(x) \cdot (\partial_t w + C(w, w) + C(\sigma \dot{B}, w) + F(w) = F) dx$$

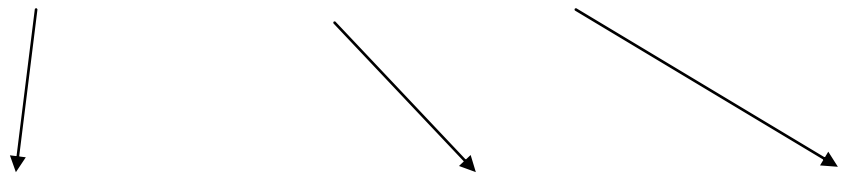

$$\frac{db(t)}{dt} = c(b(t), b(t)) + K(\sigma \dot{B}) b(t) + f b(t) = \dots$$

# REDUCED LUM (RED LUM)

POD-Galerkin gives SDEs for resolved modes

Full order :  $M \sim 10^7$   
 Reduced order :  $n \sim 10$

$v = w + v'$

Resolved fluid velocity:  
 $w(x, t) = \sum_{i=0}^n b_i(t) \phi_i(x)$

Unresolved fluid velocity:  
 $v' = \sigma \dot{B}$  (Gaussian, white wrt  $t$ )

Variance tensor:  
 $a(x, x) = \frac{\mathbb{E}\{(\sigma dB_t)(\sigma dB_t)^T\}}{dt}$

$$\int_{\Omega} \phi_i(x) \cdot (\partial_t w + C(w, w) + C(\sigma \dot{B}, w) + F(w) = F) dx$$

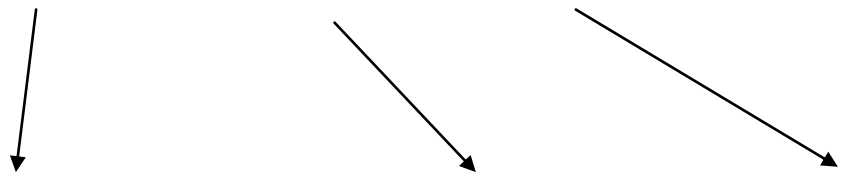

$$\frac{db(t)}{dt} = c(b(t), b(t)) + K(\sigma \dot{B}) b(t) + f b(t) = \dots$$



Advection : 2<sup>nd</sup> order polynomial



# REDUCED LUM (RED LUM)

POD-Galerkin gives SDEs for resolved modes

Full order :  $M \sim 10^7$   
 Reduced order :  $n \sim 10$

$v = w + v'$

Resolved fluid velocity:  
 $w(x, t) = \sum_{i=0}^n b_i(t) \phi_i(x)$

Unresolved fluid velocity:  
 $v' = \sigma \dot{B}$  (Gaussian, white wrt  $t$ )

Variance tensor:  
 $a(x, x) = \frac{\mathbb{E}\{(\sigma dB_t)(\sigma dB_t)^T\}}{dt}$

$$\int_{\Omega} \phi_i(x) \cdot (\partial_t w + C(w, w) + C(\sigma \dot{B}, w) + F(w) = F) dx$$

$$\frac{db(t)}{dt} = c(b(t), b(t)) + K(\sigma \dot{B}) b(t) + f b(t) = \dots$$

Multiplicative skew-symmetric noise

Advection : 2<sup>nd</sup> order polynomial

# REDUCED LUM (RED LUM)

POD-Galerkin gives SDEs for resolved modes

Full order :  $M \sim 10^7$   
 Reduced order :  $n \sim 10$

$v = w + v'$

Resolved fluid velocity:  
 $w(x, t) = \sum_{i=0}^n b_i(t) \phi_i(x)$

Unresolved fluid velocity:  
 $v' = \sigma \dot{B}$  (Gaussian, white wrt  $t$ )

Variance tensor:  
 $a(x, x) = \frac{\mathbb{E}\{(\sigma dB_t)(\sigma dB_t)^T\}}{dt}$

$$\int_{\Omega} \phi_i(x) \cdot (\partial_t w + C(w, w) + C(\sigma \dot{B}, w) + F(w) = F) dx$$

$$\frac{db(t)}{dt} = c(b(t), b(t)) + K(\sigma \dot{B}) b(t) + f b(t) = \dots$$

Multiplicative skew-symmetric noise

Advection : 2<sup>nd</sup> order polynomial

$$K_{jq}[\xi] = - \int_{\Omega} \phi_j \cdot C(\xi, \phi_q)$$

# REDUCED LUM (RED LUM)

POD-Galerkin gives SDEs for resolved modes

Full order :  $M \sim 10^7$   
 Reduced order :  $n \sim 10$

$v = w + v'$

Resolved fluid velocity:  
 $w(x, t) = \sum_{i=0}^n b_i(t) \phi_i(x)$

Unresolved fluid velocity:  
 $v' = \sigma \dot{B}$  (Gaussian, white wrt  $t$ )

Variance tensor:  
 $a(x, x) = \frac{\mathbb{E}\{(\sigma dB_t)(\sigma dB_t)^T\}}{dt}$

$$\int_{\Omega} \phi_i(x) \cdot (\partial_t w + C(w, w) + C(\sigma \dot{B}, w) + F(w) = F) dx$$

$$\frac{db(t)}{dt} = c(b(t), b(t)) + K(\sigma \dot{B}) b(t) + f b(t) = \dots$$

Advection : 2<sup>nd</sup> order polynomial

Multiplicative skew-symmetric noise

→ Covariance to estimate

$$K_{jq}[\xi] = - \int_{\Omega} \phi_j \cdot C(\xi, \phi_q)$$

# REDUCED LUM (RED LUM)

POD-Galerkin gives SDEs for resolved modes

Full order :  $M \sim 10^7$   
 Reduced order :  $n \sim 10$

$v = w + v'$

Resolved fluid velocity:  
 $w(x, t) = \sum_{i=0}^n b_i(t) \phi_i(x)$

Unresolved fluid velocity:  
 $v' = \sigma \dot{B}$  (Gaussian, white wrt  $t$ )

Variance tensor:  
 $a(x, x) = \frac{\mathbb{E}\{(\sigma dB_t)(\sigma dB_t)^T\}}{dt}$

$$\int_{\Omega} \phi_i(x) \cdot (\partial_t w + C(w, w) + C(\sigma \dot{B}, w) + F(w) = F) dx$$

**New estimator**

- Consistency proven ( $\Delta t \rightarrow 0$ )
- Numerically efficient
- Data-based & Physics-based  
 → Robustness in extrapolation

$$\frac{db(t)}{dt} = c(b(t), b(t)) + K(\sigma \dot{B}) b(t) + f b(t) = \dots$$

Advection : 2<sup>nd</sup> order polynomial

Multiplicative skew-symmetric noise  
 → Covariance to estimate

$$K_{jq}[\xi] = - \int_{\Omega} \phi_j \cdot C(\xi, \phi_q)$$

# REDUCED LUM (RED LUM)

POD-Galerkin gives SDEs for resolved modes

Full order :  $M \sim 10^7$   
 Reduced order :  $n \sim 10$

$v = w + v'$

Resolved fluid velocity:  
 $w(x, t) = \sum_{i=0}^n b_i(t) \phi_i(x)$

Unresolved fluid velocity:  
 $v' = \sigma \dot{B}$  (Gaussian, white wrt  $t$ )

Variance tensor:  
 $a(x, x) = \frac{\mathbb{E}\{(\sigma dB_t)(\sigma dB_t)^T\}}{dt}$

$$\int_{\Omega} \phi_i(x) \cdot (\partial_t w + C(w, w) + C(\sigma \dot{B}, w) + F(w) = F) dx$$

**New estimator**

- Consistency proven ( $\Delta t \rightarrow 0$ )
- Numerically efficient
- Data-based & Physics-based  
 → Robustness in extrapolation

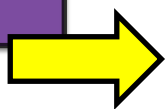

$$\frac{db(t)}{dt} = c(b(t), b(t)) + K(\sigma \dot{B}) b(t) + f b(t) = \dots$$

Advection : 2<sup>nd</sup> order polynomial



Multiplicative skew-symmetric noise  
 → Covariance to estimate

“Turbulent” diffusion  
 with  $a(x) \approx \Delta t \overline{v' (v')^T}$

$$K_{jq}[\xi] = - \int_{\Omega} \phi_j \cdot C(\xi, \phi_q)$$

# REDUCED LUM (RED LUM)

POD-Galerkin gives SDEs for resolved modes

Full order :  $M \sim 10^7$   
 Reduced order :  $n \sim 10$

$v = w + v'$

Resolved fluid velocity:  
 $w(x, t) = \sum_{i=0}^n b_i(t) \phi_i(x)$

Unresolved fluid velocity:  
 $v' = \sigma \dot{B}$  (Gaussian, white wrt  $t$ )

Variance tensor:  
 $a(x, x) = \frac{\mathbb{E}\{(\sigma dB_t)(\sigma dB_t)^T\}}{dt}$

$$\int_{\Omega} \phi_i(x) \cdot (\partial_t w + C(w, w) + C(\sigma \dot{B}, w) + F(w) = F) dx$$

**$\approx$  globally balanced energy fluxes**

**New estimator**

- Consistency proven ( $\Delta t \rightarrow 0$ )
- Numerically efficient
- Data-based & Physics-based
- Robustness in extrapolation

$$\frac{db(t)}{dt} = c(b(t), b(t)) + K(\sigma \dot{B}) b(t) + f b(t) = \dots$$

Advection : 2<sup>nd</sup> order polynomial

Multiplicative skew-symmetric noise  
 → Covariance to estimate

**“Turbulent” diffusion**  
 with  $a(x) \approx \Delta t \overline{v' (v')^T}$

$$K_{jq}[\xi] = - \int_{\Omega} \phi_j \cdot C(\xi, \phi_q)$$





# UNCERTAINTY QUANTIFICATION (PRIOR)

$n = 4$  resolved degrees of freedom  
 No data assimilation  
 Known initial conditions  $b(t = 0)$

$v = w + v'$

Resolved fluid velocity:  
 $w = \sum_{i=0}^n b_i \phi_i$

Unresolved fluid velocity:  
 $v'$

One realization	
Mean	
Confidence interval	
Reference	
No closure	

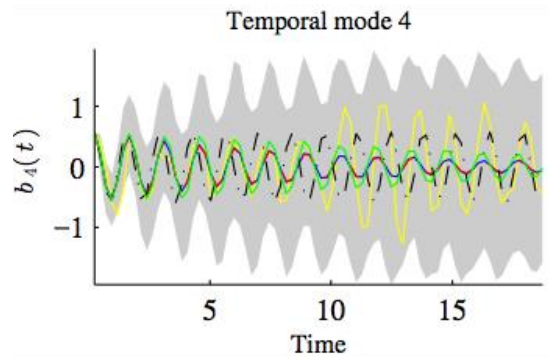
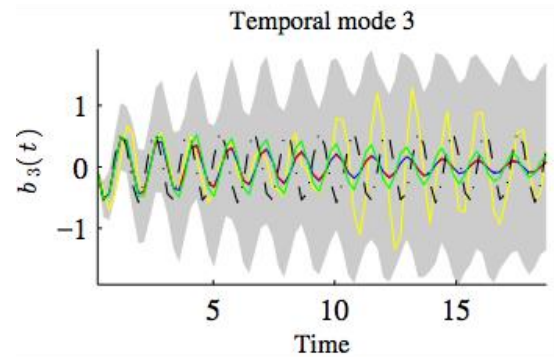
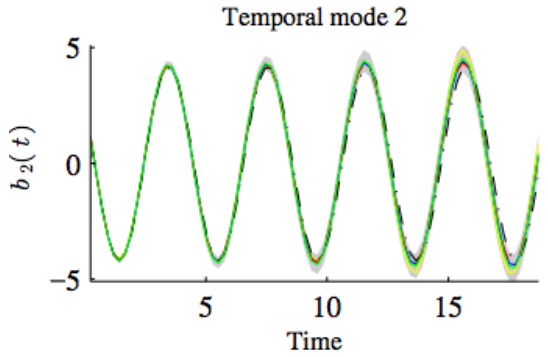
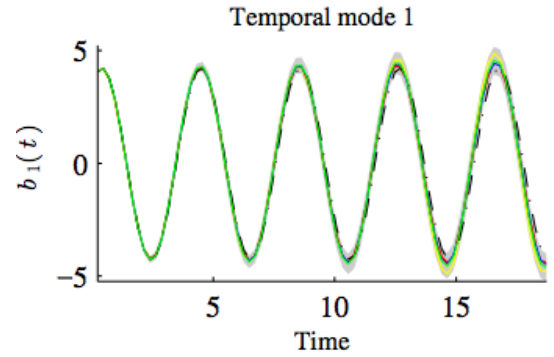

# UNCERTAINTY QUANTIFICATION (PRIOR)

$n = 4$  resolved degrees of freedom  
 No data assimilation  
 Known initial conditions  $b(t = 0)$

Mainly from  
 the mean  $\bar{v} = \phi_0$

Energy

Linearly unstable modes

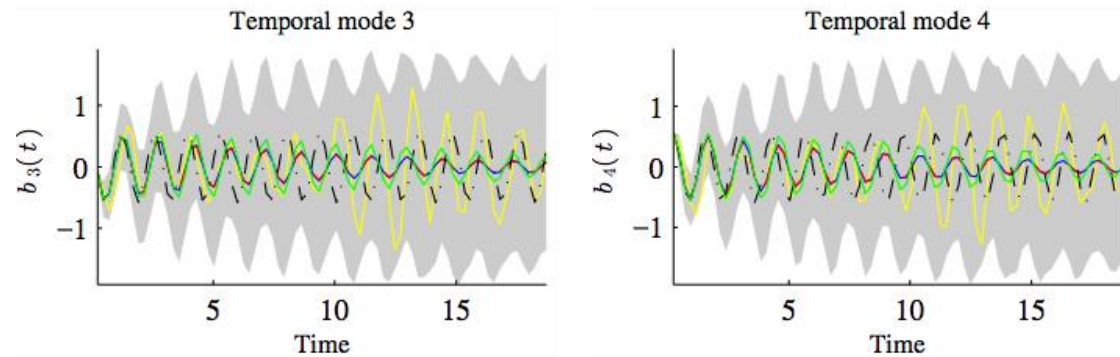
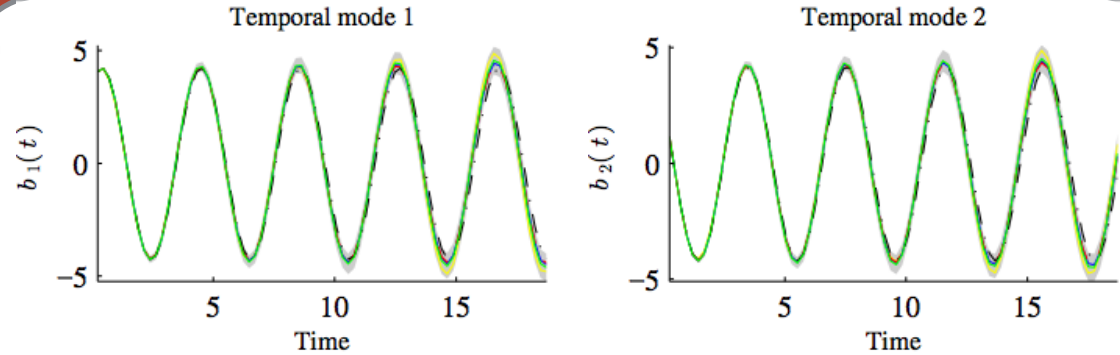

One realization	
Mean	
Confidence interval	
Reference	
No closure	

$v = w + v'$

Resolved fluid velocity:  
 $w = \sum_{i=0}^n b_i \phi_i$

Unresolved fluid velocity:  
 $v'$



# UNCERTAINTY QUANTIFICATION (PRIOR)

$n = 4$  resolved degrees of freedom  
 No data assimilation  
 Known initial conditions  $b(t = 0)$

Mainly from  
 the mean  $\bar{v} = \phi_0$

$$c(b(t), b(t))$$

Energy

Linearly unstable modes

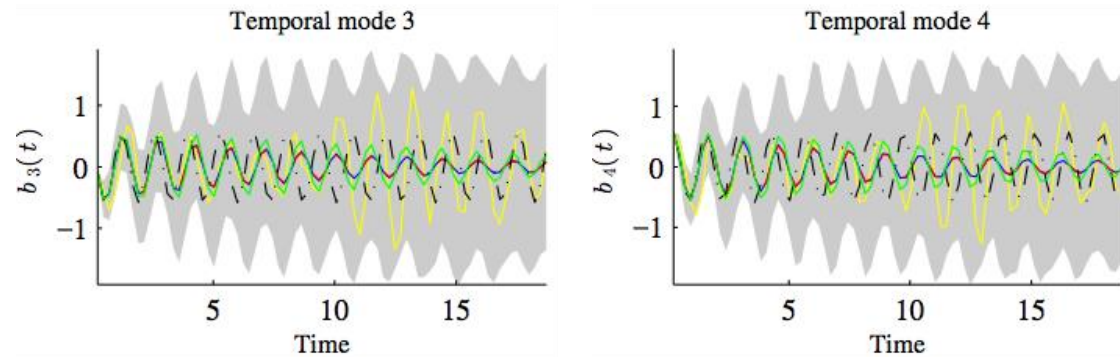
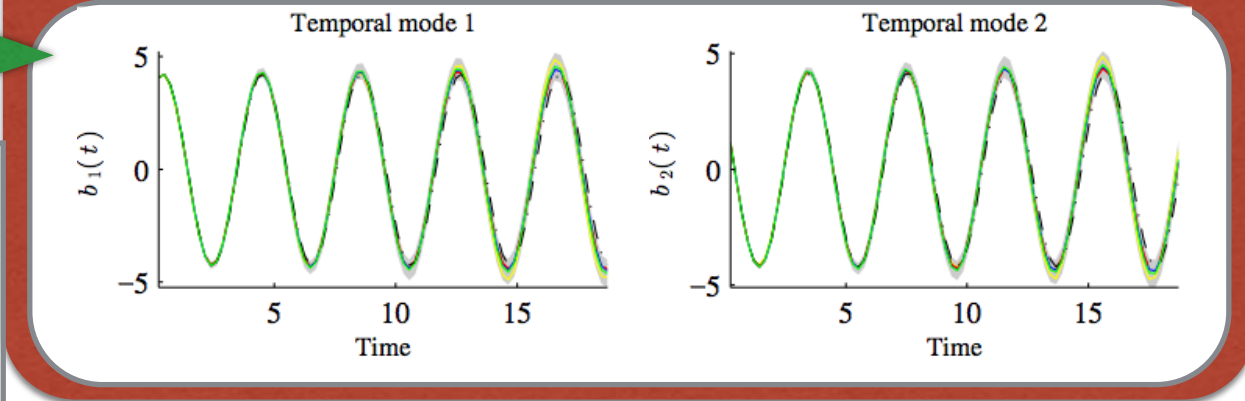

One realization	
Mean	
Confidence interval	
Reference	
No closure	

$v = w + v'$   
 Resolved fluid velocity:  
 $w = \sum_{i=0}^n b_i \phi_i$   
 Unresolved fluid velocity:  
 $v'$

# UNCERTAINTY QUANTIFICATION (PRIOR)

$n = 4$  resolved degrees of freedom  
 No data assimilation  
 Known initial conditions  $b(t = 0)$

Mainly from  
 the mean  $\bar{v} = \phi_0$

$$c(b(t), b(t))$$

Energy

Linearly unstable modes

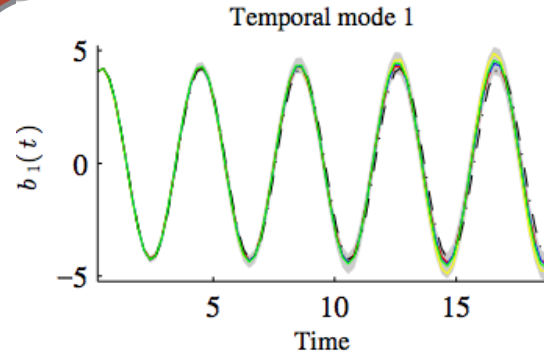

Linearly stable modes

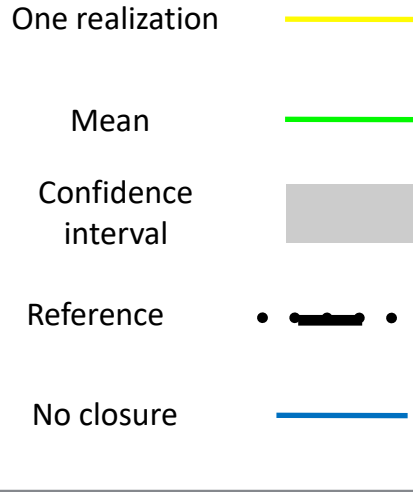
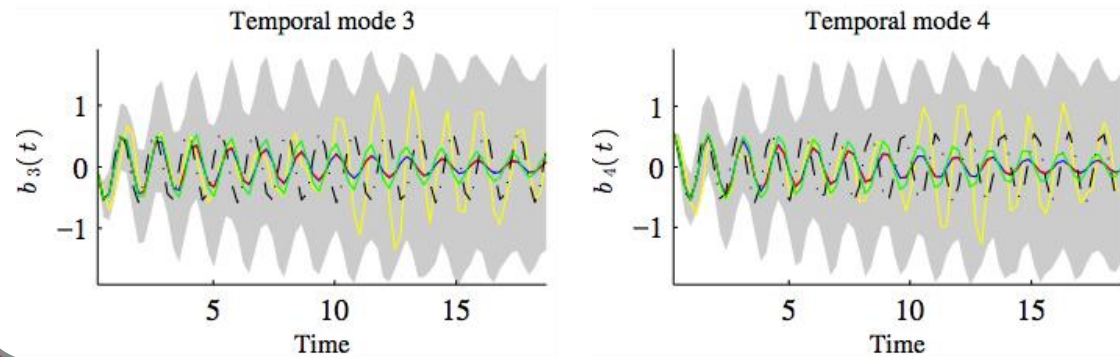

$$v = w + v'$$

Resolved fluid velocity:

$$w = \sum_{i=0}^n b_i \phi_i$$

Unresolved fluid velocity:

$$v'$$

Mainly to  
 the mean  $\bar{v} = \phi_0$

Energy

# UNCERTAINTY QUANTIFICATION (PRIOR)

$n = 4$  resolved degrees of freedom  
 No data assimilation  
 Known initial conditions  $b(t = 0)$

Mainly from  
 the mean  $\bar{v} = \phi_0$

$$c(b(t), b(t))$$

Energy

Linearly unstable modes

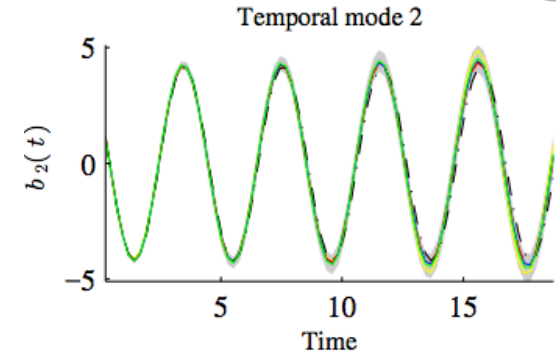
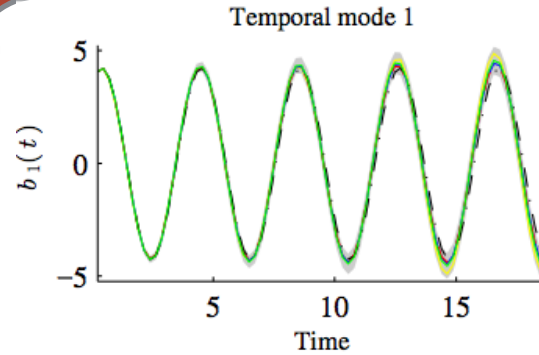

Linearly stable modes

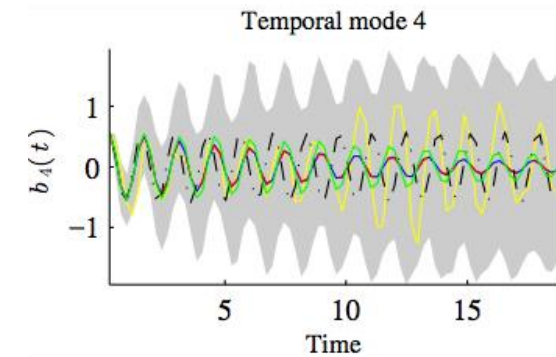
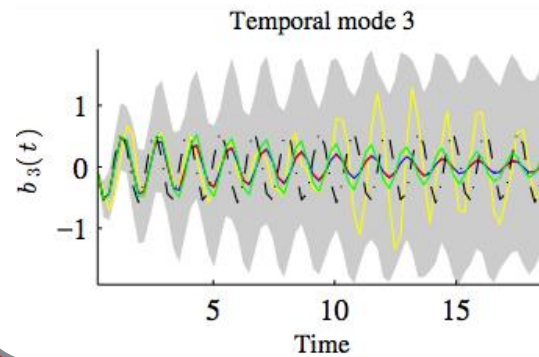

One realization	
Mean	
Confidence interval	
Reference	
No closure	

$$v = w + v'$$

Resolved fluid velocity:

$$w = \sum_{i=0}^n b_i \phi_i$$

Unresolved fluid velocity:

$$v'$$

Mainly to  
 the mean  $\bar{v} = \phi_0$

Energy

$$c(b(t), b(t))$$

# UNCERTAINTY QUANTIFICATION (PRIOR)

$n = 4$  resolved degrees of freedom  
 No data assimilation  
 Known initial conditions  $b(t = 0)$

Mainly from  
 the mean  $\bar{v} = \phi_0$

$$c(b(t), b(t))$$

Energy

Linearly unstable modes

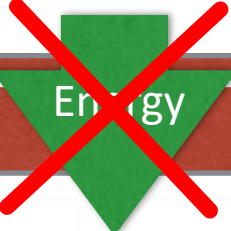
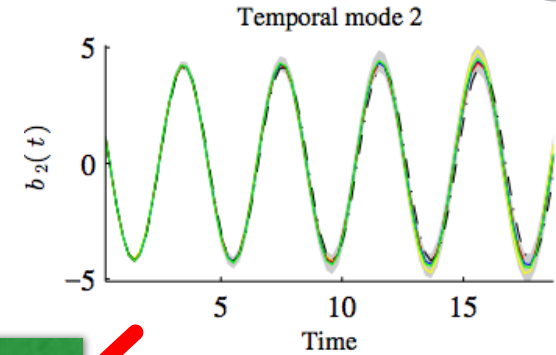
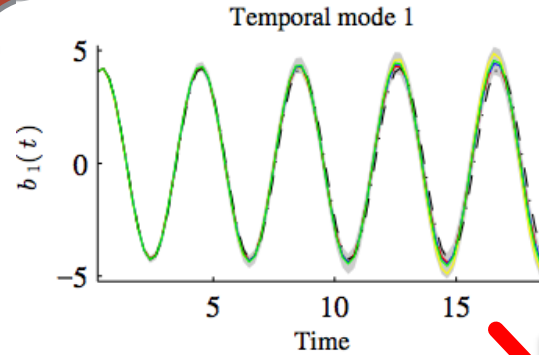

Linearly stable modes

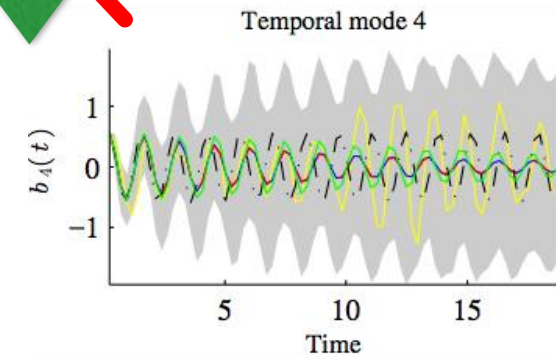
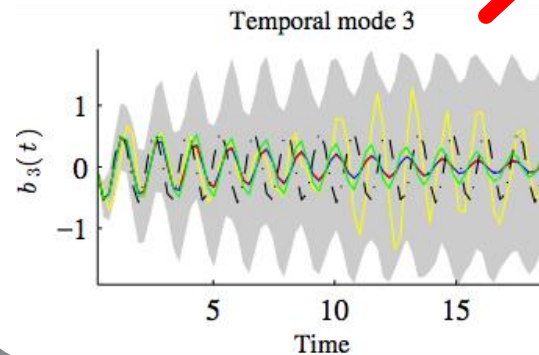

$v = w + v'$   
 Resolved fluid velocity:  
 $w = \sum_{i=0}^n b_i \phi_i$   
 Unresolved fluid velocity:  
 $v'$

One realization	
Mean	
Confidence interval	
Reference	
No closure	

Mainly to  
 the mean  $\bar{v} = \phi_0$

$$c(b(t), b(t))$$

Energy



# UNCERTAINTY QUANTIFICATION (PRIOR)

$n = 4$  resolved degrees of freedom  
 No data assimilation  
 Known initial conditions  $b(t = 0)$

Mainly from  
 the mean  $\bar{v} = \phi_0$

$$c(b(t), b(t))$$

Energy

Linearly unstable modes

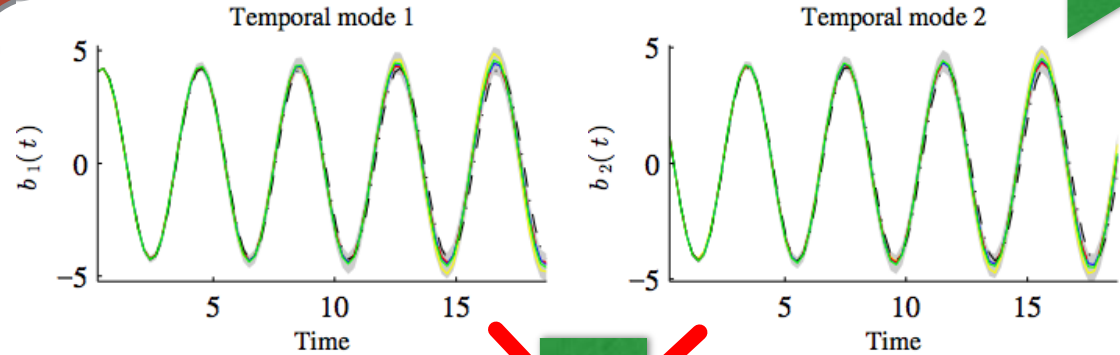

Stabilized by  
 turbulent  
 diffusion  
 $f b(t)$

$v = w + v'$   
 Resolved fluid velocity:  
 $w = \sum_{i=0}^n b_i \phi_i$

Unresolved fluid velocity:  
 $v'$

- One realization —
- Mean —
- Confidence interval
- Reference • — •
- No closure —

Energy

Linearly stable modes

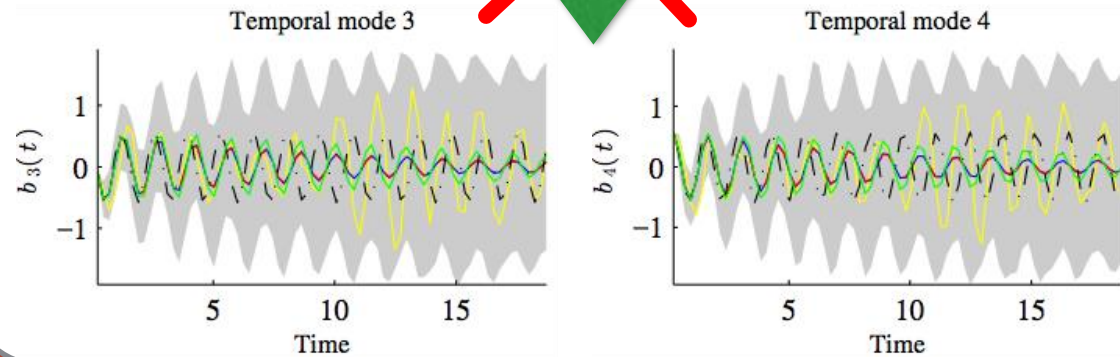

Mainly to  
 the mean  $\bar{v} = \phi_0$

Energy

$$c(b(t), b(t))$$

# UNCERTAINTY QUANTIFICATION (PRIOR)

$n = 4$  resolved degrees of freedom  
 No data assimilation  
 Known initial conditions  $b(t = 0)$

Mainly from the mean  $\bar{v} = \phi_0$

$$c(b(t), b(t))$$

Energy

Linearly unstable modes

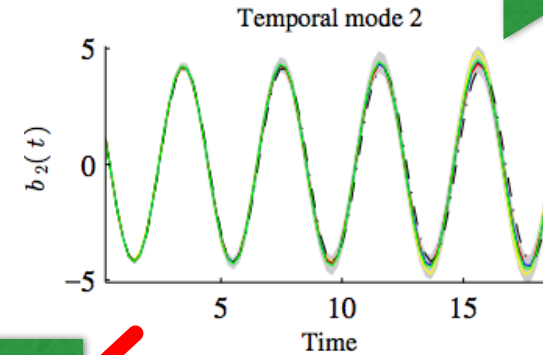
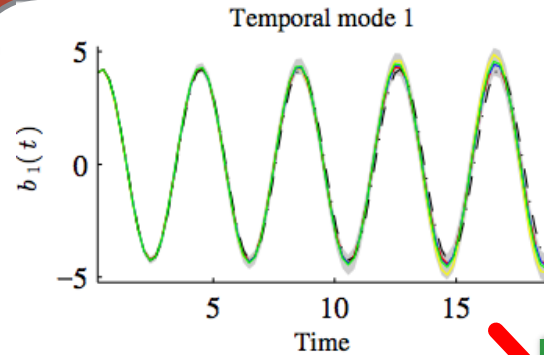

Stabilized by turbulent diffusion  $f b(t)$

$v = w + v'$   
 Resolved fluid velocity:  
 $w = \sum_{i=0}^n b_i \phi_i$   
 Unresolved fluid velocity:  
 $v'$

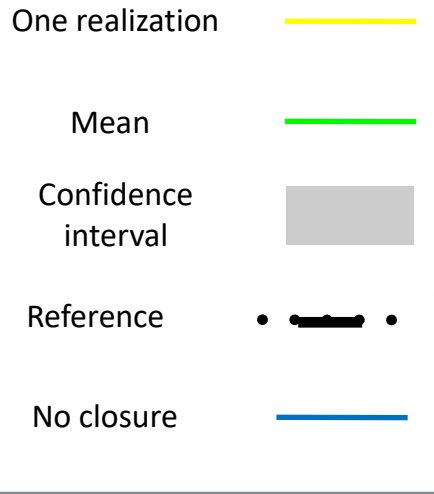

Energy

Linearly stable modes

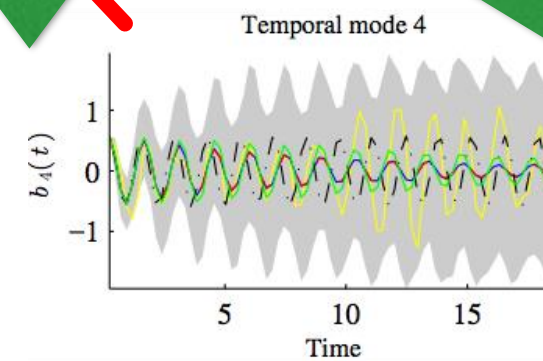
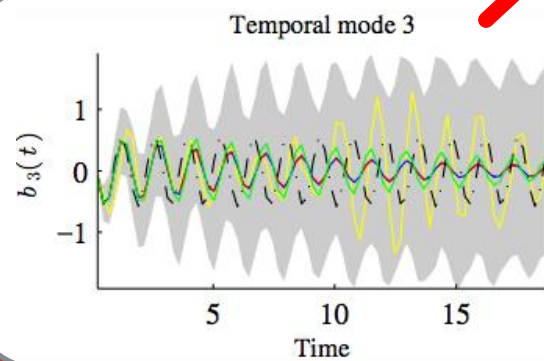

Variability maintained by random energy transfert  $K(\sigma \dot{B}) b(t)$

Mainly to the mean  $\bar{v} = \phi_0$

$$c(b(t), b(t))$$

Energy

# UNCERTAINTY QUANTIFICATION (PRIOR)

$n = 8$  resolved degrees of freedom  
 No data assimilation  
 Known initial conditions  $b(t = 0)$

$$v = w + v'$$

Resolved fluid velocity:

$$w = \sum_{i=0}^n b_i \phi_i$$

Unresolved fluid velocity:

$$v'$$

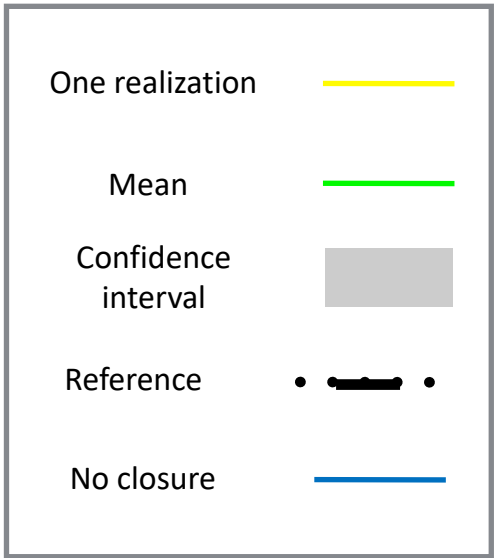
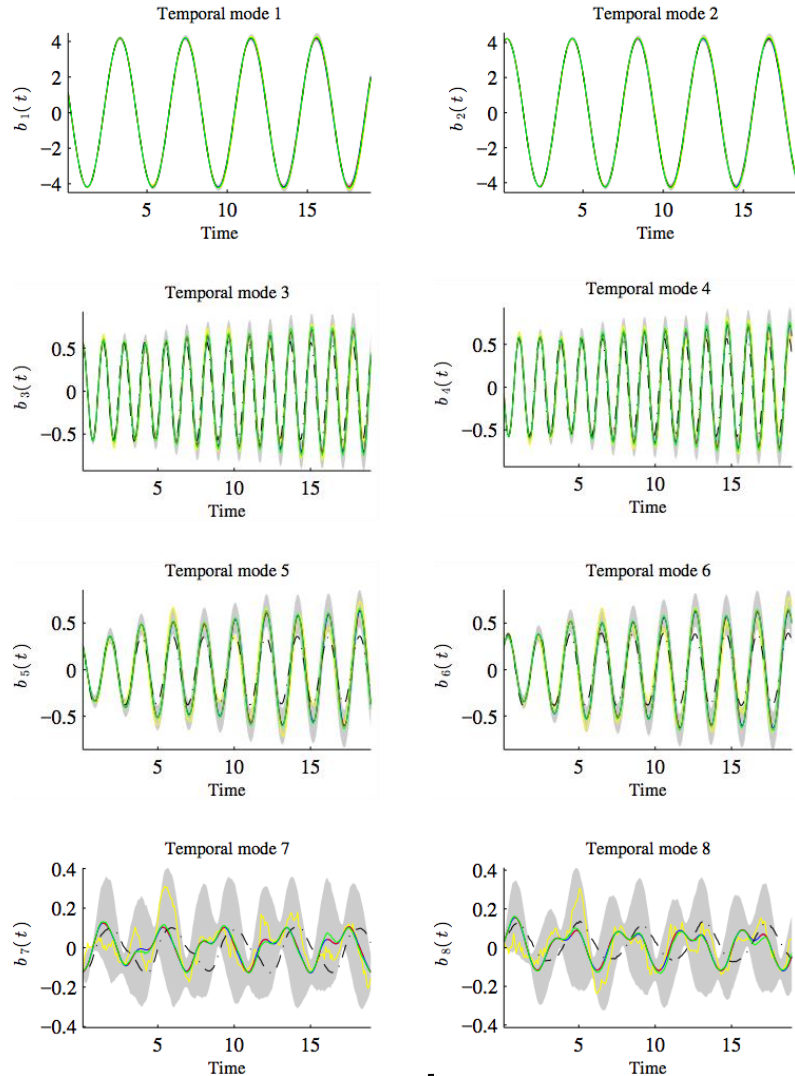

# UNCERTAINTY QUANTIFICATION (PRIOR)

$n = 8$  resolved degrees of freedom  
 No data assimilation  
 Known initial conditions  $b(t = 0)$

$v = w + v'$

Resolved fluid velocity:  
 $w = \sum_{i=0}^n b_i \phi_i$

Unresolved fluid velocity:  
 $v'$

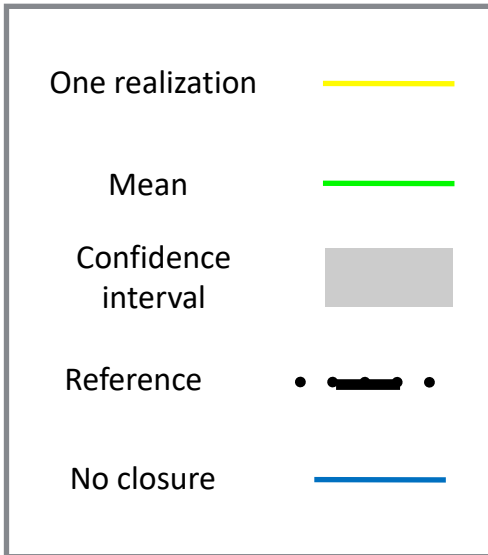
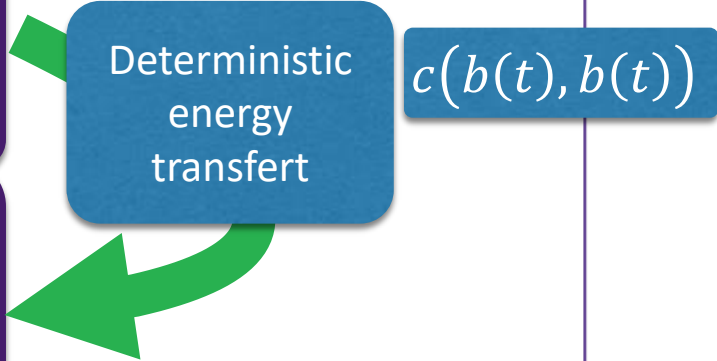
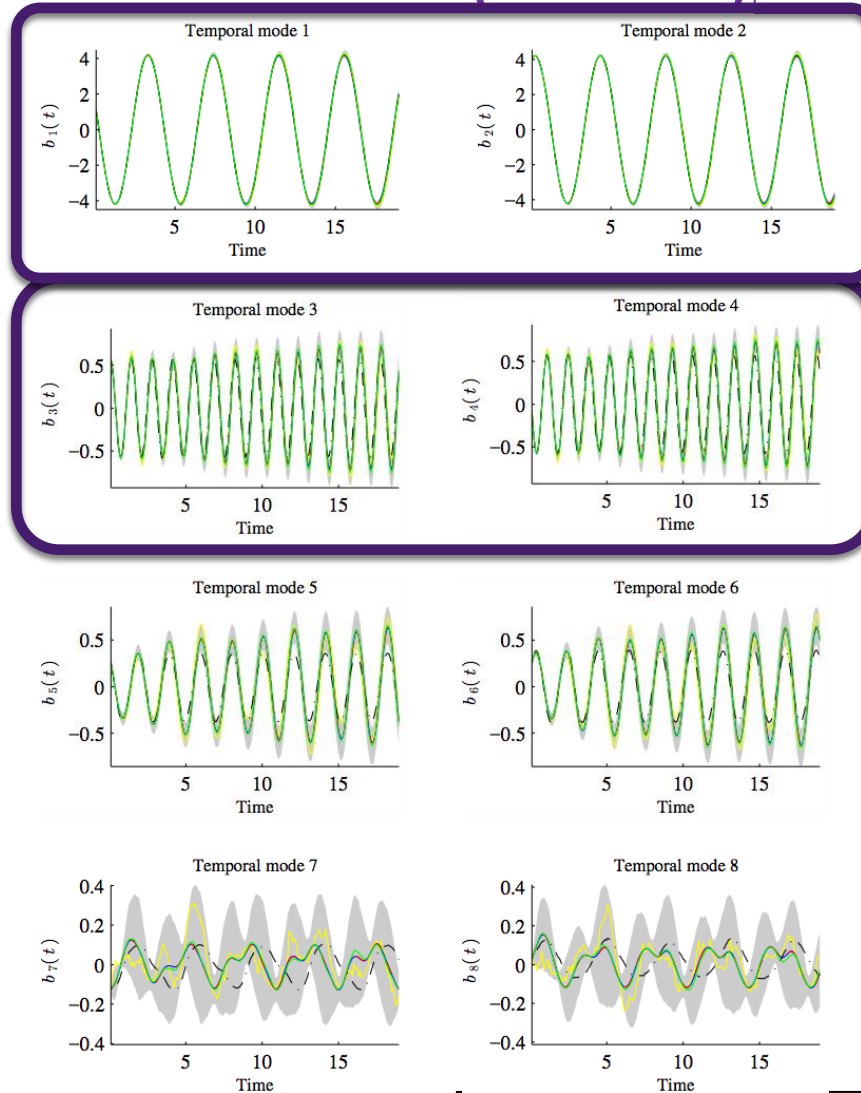



# UNCERTAINTY QUANTIFICATION (PRIOR)

$n = 8$  resolved degrees of freedom  
 No data assimilation  
 Known initial conditions  $b(t = 0)$

$v = w + v'$

Resolved fluid velocity:  
 $w = \sum_{i=0}^n b_i \phi_i$

Unresolved fluid velocity:  
 $v'$

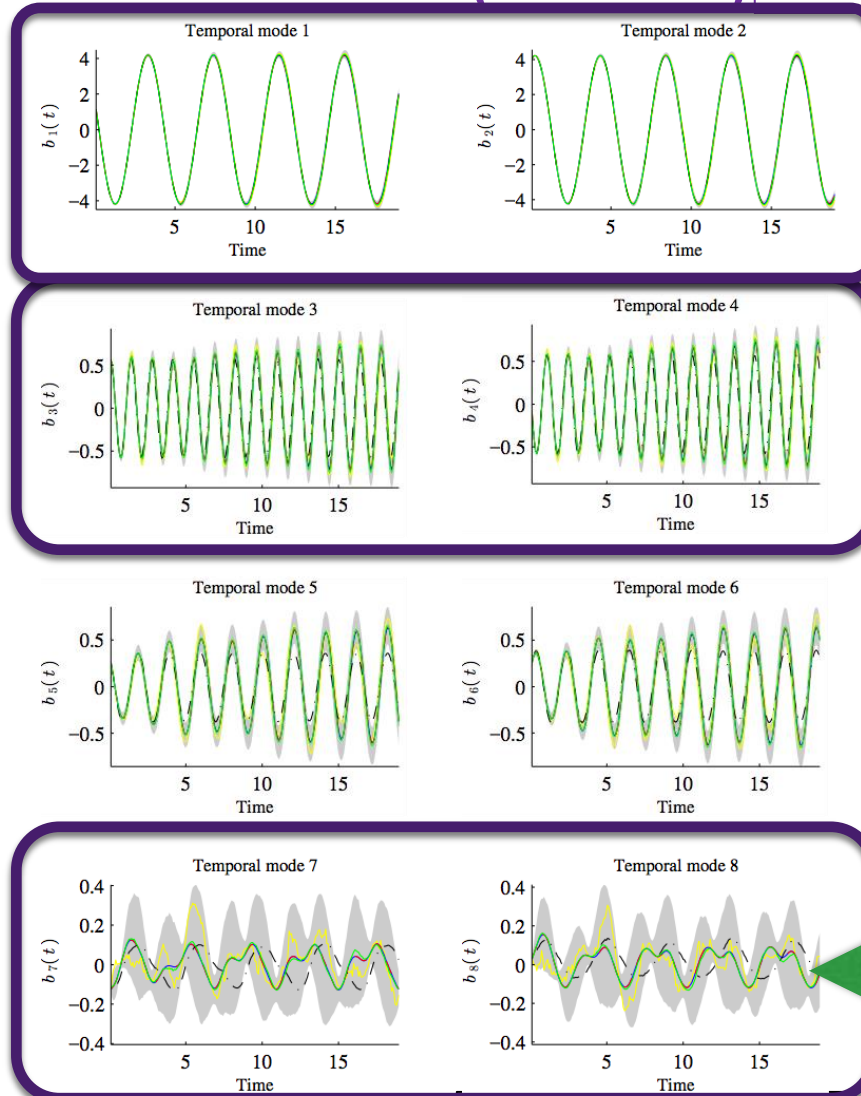

Deterministic energy transfert

$c(b(t), b(t))$



Random energy transfert

$K(\sigma \dot{B}) b(t)$

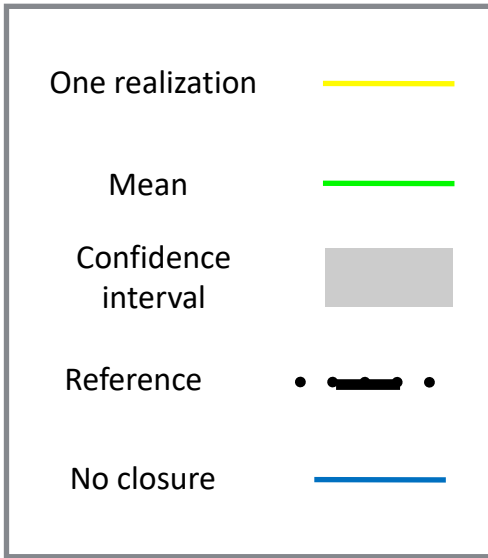
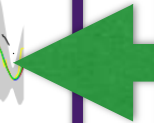

# DATA ASSIMILATION (POSTERIOR)

## Error on the solution estimation

$$v = w + v'$$

Resolved fluid velocity:

$$w = \sum_{i=0}^n b_i \phi_i$$

Unresolved fluid velocity:

$$v'$$

Reynolds number (Re) = 100 / 2D  
(full-order simulation has  $10^4$  dof)

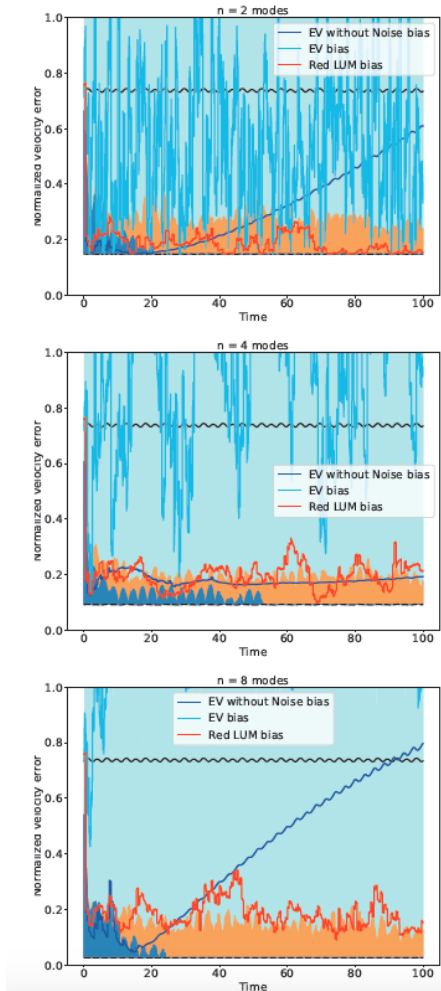
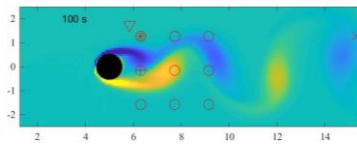

State of the art

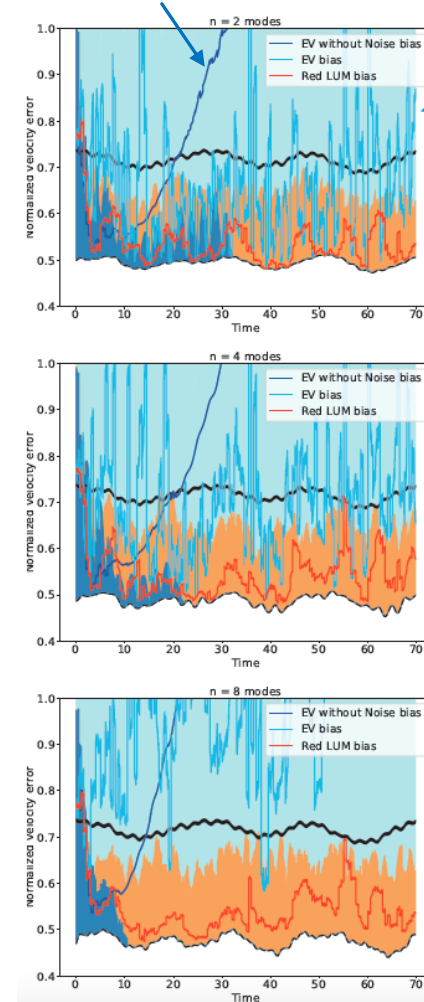

State of the art

Red. LUM std  
Red. LUM bias

Reynolds number (Re) = 300 3D  
(full-order simulation has  $10^7$  dof)

