



HAL
open science

Stacked Revenues for Energy Storage Participating in Energy and Reserve Markets with an Optimal Frequency Regulation Modeling

Ahmed Mohamed, Rémy Rigo-Mariani, Vincent Debusschere, Lionel Pin

► **To cite this version:**

Ahmed Mohamed, Rémy Rigo-Mariani, Vincent Debusschere, Lionel Pin. Stacked Revenues for Energy Storage Participating in Energy and Reserve Markets with an Optimal Frequency Regulation Modeling. *Applied Energy*, 2023, 350, pp.121721. 10.1016/j.apenergy.2023.121721 . hal-04182119

HAL Id: hal-04182119

<https://hal.science/hal-04182119>

Submitted on 17 Aug 2023

HAL is a multi-disciplinary open access archive for the deposit and dissemination of scientific research documents, whether they are published or not. The documents may come from teaching and research institutions in France or abroad, or from public or private research centers.

L'archive ouverte pluridisciplinaire **HAL**, est destinée au dépôt et à la diffusion de documents scientifiques de niveau recherche, publiés ou non, émanant des établissements d'enseignement et de recherche français ou étrangers, des laboratoires publics ou privés.

Stacked Revenues for Energy Storage Participating in Energy and Reserve Markets with an Optimal Frequency Regulation Modeling

Ahmed MOHAMED ^a, Rémy RIGO-MARIANI ^a, Vincent DEBUSSCHERE ^a, Lionel PIN ^b

^a Univ. Grenoble Alpes, CNRS, Grenoble INP, G2Elab Grenoble, 38000, France

^b Atos Worldgrid Solutions for Energy and Utilities , Grenoble , 38130 , France

Email: ahmed.mohamed@grenoble-inp.fr

Email: remy.rigo-mariani@grenoble-inp.fr

Email: vincent.debusschere@grenoble-inp.fr

Email: lionel.pin@atos.net

ABSTRACT

This paper investigates the opportunity for a Battery Energy Storage System (BESS) to participate in multiple energy markets. The study proposes an offline assessment to calculate the maximum annual revenues to reach the optimum stack of services through deterministic simulations. The markets include wholesale energy markets (day-ahead and intraday), ancillary services (frequency regulation and reserve), and the capacity mechanism. The study case performed on the French markets shows that frequency services overperform the other markets, where the long-term capacity market has the least potential. Moreover, providing multiple services maximizes the battery's revenues, for example, participating in joint energy and reserve markets showed a 76 % increase in annual profits. Furthermore, a novel operation approach was proposed to enhance the performance of these joint markets, by indirectly utilizing energy products as frequency reserves. The results demonstrate that the proposed formulation allows a revenue increase of ~23% compared to the conventional framework for the provision of frequency regulation with BESSs. Additionally, the joint markets have been shown to be economically viable with 6.2 years payback period after considering battery degradation and depreciation cost.

KEYWORDS

Energy Markets, Optimization, Stacked revenues, Energy Storage, Modelling, and Ancillary Services.

ABBREVIATIONS:

ESS	Energy storage system
BESS	Battery Energy storage system
MILP	Mixed integer linear programming
DA	Day ahead market
ID	Intraday market
BM	Balancing market
FCR	Frequency containment reserve
aFRR	Automatic frequency restorations reserve
mFRR	Manual frequency restoration reserve
RR	Replacement reserve
SOC	State of charge

NOMENCLATURE:

PARAMETERS:

π_t^{da}	Day ahead market -DA energy prices (€/MWh)
π_t^{id}	Intraday market -ID energy prices (€/MWh)
$\pi_t^{fcr, r}, \pi_t^{fcr, a}$	FCR reserve price (€/MW/4h), activated energy price (€/MWh)
$\pi_t^{afrr, r}, \pi_t^{afrr, a}$	aFRR reserve price (€/MW/1h), activated energy price (€/MWh)
$\pi_t^{mfrr, r}, \pi_t^{mfrr, a +/-}$	mFRR reserve price (€/MW/30min), activated energy price (€/MWh)
$\pi_t^{rr, r}, \pi_t^{rr, a +/-}$	RR reserve price (€/MW/30min), activated energy price (€/MWh)
π_t^{cap}	Capacity market Energy prices (€/MWh)
$a_{t,j}^{bm, +/-}$	Activation signals for upward and downward reserve: $bm = \{fcr, afrr, mfrr, rr\}$
a_t^{bm}	Manual reserve signals for upward and downward reserve: $bm = \{mfrr, rr\}$
a_t^{cap}	Activation signals of the capacity market
dt^{da}	Time resolution for DA market (1 h)
dt^{id}	Time resolution for ID market (30 min)
dt^{bm}	Time resolution for BM markets: $bm = \{fcr, afrr, mfrr, rr\}$ (15 min)
P_{max}	Maximum power capacity for the battery (MW)
E_{cap}	Maximum Energy capacity for the battery (MWh)
η^-, η^+	Charging and discharging efficiency (%)
β	An activated portion of upward and downward BM reserves (%)
soc_{max}, soc_{min}	Maximum and Minimum value for the stage of charge (%)

VARIABLES:

p_t^+, p_t^-	Discharging and charging ESS powers (MW)
$p_t^{da, +}, p_t^{da, -}$	Discharging and charging DA powers (MW)
$p_t^{id, +}, p_t^{id, -}$	Discharging and charging ID powers (MW)
$p_t^{fcr}, \Delta p_{t,j}^{fcr, +/-}$	FCR reserve (MW), activated energy up/down FCR (MWh)
$p_t^{afrr, +/-}, p_{t,j}^{afrr, +/-}$	aFRR up/down reserve (MW), activated energy up/down aFRR (MWh)
$p_t^{mfrr}, \Delta p_{t,j}^{mfrr}$	Upward mFRR reserve (MW), activated energy up mFRR (MWh)
$p_t^{rr}, \Delta p_{t,j}^{rr}$	Upward RR reserve (MW), activated energy up RR (MWh)
$p_t^{mfrr, +/-}$	Energy products for mFRR up/down balancing energy (MWh)
$p_t^{rr, +/-}$	Energy products for RR up/down balancing energy (MWh)
p_t^{cap}	Discharged power in capacity market (MW)
u_t	Binary variable, = 1 if discharging, = 0 if charging
soc_t	Battery state of charge (%)
$p_t^{dir}, \Delta p_{t,j}^{dir, +/-}$	FCR reserve with same sign as DA(MW), activated energy up/down FCR (MWh)
$p_t^{opp}, \Delta p_{t,j}^{opp, +/-}$	FCR reserve with opposite sign as DA (MW), activated energy up/down FCR (MWh)
$u_t^{+/-}$	Binary variables for charging and discharging (same direction as DA)
$u_t^{opp, +/-}$	Binary variables for charging and discharging (opposite direction of DA)

1. INTRODUCTION

Energy Storage Systems (ESSs) deployment in power grid systems has significantly increased in recent years. In 2021, the installed capacity in Europe reached 3,000 MWh, doubling the previous year's investments¹. This growth aligns with international efforts to reduce carbon emissions and promote green industries, as outlined in the COP 21 conference² in Paris [1]. Furthermore, as renewable energy sources increase, power grids may become more volatile and uncertain, with less inertia available [2]. ESSs, with their ability to quickly respond to the changes in the generation of renewables and the grid's demand, can provide flexibility for more secure and efficient network operations in those conditions, and thus generate revenue for their owners³.

Battery Energy Storage Systems (BESS) have potential applications and services that can be provided to power systems depend on their grid location and capacity [3,4]. For instance, large utility-scale batteries connected to the transmission grid can provide ancillary services to the transmission system operator (TSO), while systems connected to medium voltage can support the DSO for loss reduction and/or voltage regulation [5]. End-Users can also install their batteries 'behind the meter' and make use of some services without participating in the wholesale market - e.g. increase their self-consumption or self-sufficiency ratios, or simply lower their electricity bill [6]. Three categories of applications have been summarized in Table.1, based on [7], while identifying the value of each market based on the ESS location in the scope of this work.

Given the many identified uses, and after characterizing the main parameters and the value of each market, the primary concern is determining the best way to model them to assess their potential revenues. Various models and approaches are used for the provisions of energy services/products by storage systems, including rule-based algorithms [8] and optimization methods such as linear programming [9], mixed-integer linear programming (MILP) [10], and non-linear programming [11]. These models vary in terms of computational complexity and accuracy, with rule-based algorithms being easier to implement but less precise, while optimization methods result in the optimal operation of ESS but require more computational resources. Typical assessment of the economic performances of ESS is based on market models, and whether the market prices are fixed or variable concerning the storage output. Some case studies consider small-scale ESS that does not have market power [12], while others consider large-scale ESS which requires the submission of strategic bids to take advantage of price differences without lowering them [13]. In this paper, MILP models are used to model ESS, where the ESS owner is considered a price taker, in wholesale energy markets, frequency services, and the capacity market.

Several studies have highlighted the relevance of storage systems for grid services, with an estimation of the expected revenues based on the targeted markets. ESSs that participate in wholesale energy markets typically perform

¹ "Total Annual Energy Storage Market in Europe Expected to Reach 3,000 MWh in 2021," *European Association for Storage of Energy*, 2020. <https://www.eia.gov/analysis/studies/electricity/batterystorage/>

² "United Nations Treaty Collection." Chapter XXVII environment, 7. d Paris Agreement, Nov. 04, 2016. [Online]. Available: <https://treaties.un.org>.

³ "European Environment Agency." Total greenhouse gas emission trends and projections, 2019. [Online]. Available: <https://www.eea.europa.eu/data-and-maps/indicators/greenhouse-gas-emission-trends-6/assessment-2>

an energy arbitrage (EA), which is buying energy at low prices during off-peak periods and selling it at higher prices during peaks. The ESS owner benefits from this service by taking advantage of the energy price variations over time [14]. Maximizing the profits of wholesale energy markets using MILP has been studied in [15], where the work included both the day ahead (DA) and intraday (ID) markets. The case study, in the PJM market USA, showed that ID has the potential to achieve almost double the profits of the DA market. Despite the potential interest of ID price volatility, it underlined the importance of forecast accuracy [16]. Real-time and dynamic optimization have then been introduced to face the challenge of low-accuracy forecasts [17].

Table.1:Applications of energy storage in power system

Application	Stakeholder	Value
Wholesale market applications:		
- Day ahead market - Intraday Market - Imbalance settlement		Arbitrage of energy prices (€/MWh)
- Capacity Market	Supplier / Large consumer	Guarantee certificate (€/MW/Year)
- Manage Curtailment requests		Buffer to store generation when not needed (€/MW)
- Compensate forecast error		Buffer to produce extra generation when needed (€/MW)
Ancillary services:		
- Frequency containment reserve (FCR) - Automatic frequency restoration reserve(aFRR) - Manual frequency restoration reserve (mFRR) - Replacement reserve (RR)	TSO	Capacity remuneration for the reserve (€/MW) and energy remuneration for activated reserve (€/MWh)
- Black start - Synthetic Inertia		In the future
- Voltage control - Congestion management - Power limit optimization	TSO / DSO	Assure that the grid capacity withstands the charging and discharging demands (€/MW)
Consumer-oriented applications:		
- Self Consumption - Peak Shaving - Power quality - Uninterruptible power supply (UPS)	Consumer	Paid for each service as (€/MW) or
- Time of use bill management - Storing excess generation		(€/MWh)

ESS can also provide ancillary services such as frequency regulation [18] and get remunerated accordingly to their participation. MILP was used to estimate the revenues of ESS participating in both the energy arbitrage (EA) and the balancing market (BM) in the CAISO, ERCOT, and NYISO markets in California, Texas, and New York respectively in the USA [19,20]. The results showed that revenues from BM were proven to be four times the revenues from EA in the context of the study. ESSs have proven economic feasibility to be used as a spinning reserve for

primary reserve (frequency containment reserve - FCR) in the German market [21], and then later introduced also as a potential solution for secondary reserve instead of conventional power plants [22]. Furthermore, case studies on the German market investigated the combination services provided to both TSO and DSO [23,24]. The results showed that none of the suggested scenarios was profitable without considering the frequency of reserve services. A similar trend was shown in the Nordic market, where the share of frequency services in total revenues highly varies with wind production, especially in Denmark. Even with the high uncertainty of the BM market, frequency reserve services enhance the return on investment of ESS [25].

Furthermore, running multiple applications on grid-connected ESSs is a recent control method that leads to maximum profits while taking advantage of price heterogeneity among different products [26]. But, it is complicated to ensure that all services are fulfilled optimally [27]. Multiple grid services can almost double the profits of ESSs compared to the provision of a single one [28,29]. For instance, stacking the services returned around 80% of the sum of the services revenues taken individually in a case study on California ISO markets [30]. Also, the approach of stacking services allows the ESS owner to prioritize some of them, such as outage mitigation for grid security [31], over others depending on the time of the day. Many possibilities are available, like a mix between TSO and DSO services, or only behind-the-meter services [32].

The potential revenue streams for energy storage systems in European markets have not been fully explored in the literature. Most of the studies have focused on the potential of ESS services in the USA, where frequency services are based on capability and performance credits – e.g. according to PJM regulation [33,34] - or as a non-symmetric reserve product [29], [35-37]. However, the new regulations with symmetric reserve products and the ESS's charges to provide downward regulation energy were not modeled. None of the existing works have considered all types of reserves [37], particularly manual reserves such as mFRR or RR in the European market, as a potential revenue stream for BESS. Therefore, this paper aims to fill this gap by presenting MILP models for wholesale energy products, frequency regulation market, and capacity market that adhere to the latest European regulation up to the year 2021.

The paper first estimates the maximum annual revenues for different combinations of provided products, including 1) day-ahead market (DA), 2) intraday market (ID), 3) Balancing market (BM) services such as frequency containment reserve (FCR), automatic frequency restoration reserve (aFRR), manual frequency restoration reserve (mFRR), and replacement reserve (RR), 4) capacity market. Additionally, annual simulation using historical data are performed to reach the optimum stack of services for a single grid connected battery. Furthermore, a novel approach is introduced for modeling joint energy and reserve (DA + FCR) markets. The method is based on the provision of more FCR reserves by utilizing the DA energy products as stand-by reserves, using the so-called “Direct/Opposite reserves control”. Finally, a sensitivity study is presented to assess the impact of changing the quantity of activated energy in the frequency services. Hence, the variation in annual revenues is calculated and comparison between the performance of conventional formulation and the novel approach is presented.

The main contributions of the paper are summarized in the following:

- Comprehensive modeling of wholesale energy markets, frequency services, and capacity markets in Europe.

- Introduction of new modeling for the provision of frequency regulation that allows direct/opposite reserves to be allocated in four modes of operation , hence reaching higher revenues by utilizing more reserves.
- Running multiple annual simulations to identify the best combination of provided products and sensitivity analysis on activation of frequency services.

The rest of the paper is organized as presented in Fig. 1. Section 2 presents the modeling of each market in the form of a deterministic optimization problem with price and activation signals inputs. Section 3 introduces a new approach to model the joint energy and reserve markets (DA + FCR) with possible operations in “direct/opposite reserves”. Section 4 presents the annual simulation results with the expected maximum revenues for each service. Also, it shows the optimal stack of services to be considered for BESS. Furthermore, the enhanced performance with the new approach and sensitivity analysis to frequency regulation activation signals are presented. Section 5 concludes the paper with perspectives on future works.

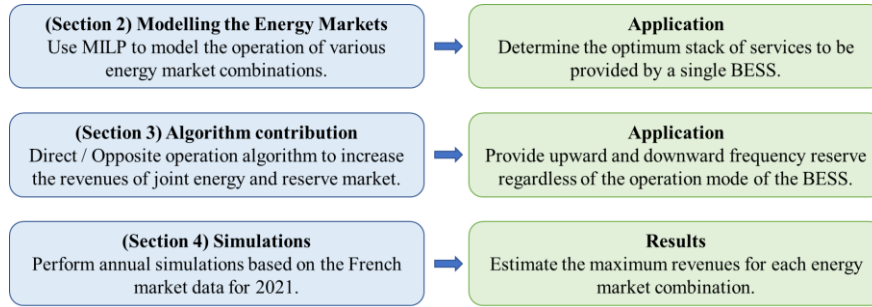

Fig. 1 Technical road map for the research work

2. ENERGY MARKETS AND PROBLEM FORMULATION

In this section, the potential revenue streams for ESS are identified and modeled using MILP in the French market framework for energy, balancing, and capacity. A combination of different services can be modeled by adding/modifying the problem objective function and constraints. Note that through all the models, the ESS operator is considered a price taker (with deterministic data based on history). Hence, there is no optimization for the bidding price for each product, the assumption is made that the bid is always accepted (e.g. bid at a zero price). The models presented in this section will be used to estimate the maximum revenues of each combination of markets and hence determine the optimum stack of services in a somewhat off-line mode

2.1. Energy storage model for the MILP optimization

The model considers energy storage capacity, maximum charging and discharging rates, charging and discharging efficiencies, battery state of charge's limits, and initial and final charge states.

$$0 \leq p_t^+ \leq p_{max} \times u_t \quad (1)$$

$$0 \leq p_t^- \leq p_{max} \times (1 - u_t) \quad (2)$$

$$soc_t = soc_{t-1} + \left(p_t^- \times \eta^- - p_t^+ / \eta^+ \right) \times 100 \times dt \times (1 / E_{cap}) \quad (3)$$

$$soc_{min} \leq soc_t \leq soc_{max} \quad (4)$$

$$SOC_{t=T} = SOC_{t=0} \quad (5)$$

Constraints (1) and (2) limit the charging and discharging power flows (p^+ , p^-) of the battery power capacity. The values of these variables are to be determined based on the selected markets. A binary variable u_t is introduced to avoid potential simultaneous charging and discharging. Here the binary variable denotes the charging mode of the storage. Note that a typical alternative could have consisted in introducing two distinct variables for charging and discharging modes. It has not been considered here for a reduced problem complexity. The stored energy is updated at each time step accounting for charging and discharging efficiencies (η , η^+) in (3). This stored energy is limited by (4) between predefined maximum and minimum state of charge (SOC) levels. Equation (5) guarantees that the SOC of the battery at the end of the day is equal to the one at the beginning of the day to allow daily optimization.

2.2. Wholesale energy market

2.2.1. Day-ahead market

This market aims at providing an initial operating schedule for the TSO to meet the daily predicted demand. It has a horizon of 24 hours and a resolution of one hour in all European countries except in united kingdom, where the resolution is 30 min [38]. It is an energy product with bids and remuneration in €/MWh. Bidding in DA enables the energy storage operator to perform an arbitrage taking advantage of the energy price variations over the day. Hence, the ESS participating in DA optimizes its operation to charge at the lowest possible prices, then to discharge at peak prices. The objective function (6) models the ESS participation in the DA market, where $t \in T$ is a temporal set representing one day at a resolution of one hour (dt^{da}).

$$\max_{p_t^{da,-}, p_t^{da,+}} C_{da} = \sum_{t \in T} \pi_t^{da} \times (p_t^{da,+} - p_t^{da,-}) \times dt^{da} \quad (6)$$

2.2.2. Intraday market

The objective of this market is to adjust the energy balance right before delivery time to account for the latest demand forecast (more recently updated). After the initial schedule is determined in the DA market, additional bidding can then be done to change the energy delivered at a given time step (from the producer's perspective). The trading in Intraday market can be done through auctions or continuous trading as in all European countries. The resolution of the intraday market varies according to the country. The ID auction resolution is either 30 min as in France and United kingdom or 15 min as in Austria and Netherland. On the other hand, Continuous trading resolution can vary between 1 h, 30 min, 15 min according to the country. In this paper, the French market is considered with 30 min resolution, where offers and bids are matched and executed according to the demand with higher volatility than DA [39]. The objective function (7) represents the participation of the ESS in the intraday market, where $t \in T$ is a temporal set for one day at a resolution of 30 min (dt^{id}).

$$\max_{p_t^{id,-}, p_t^{id,+}} C_{id} = \sum_{t \in T} \pi_t^{id} \times (p_t^{id,+} - p_t^{id,-}) \times dt^{id} \quad (7)$$

2.3. Frequency regulation and reserve

The electricity balancing⁴ (EB) cooperation integrates all resources across European countries to increase the security of supply and decrease costs for the customers. The sequence of activation of these reserves is shown in Fig.2. The primary reserve, or Frequency containment reserve (FCR), is automatically activated within 30 s after the frequency deviation incident, to stop the frequency from further deteriorating [40]. Then the secondary reserve is activated, which includes both automatic frequency restoration reserve (aFRR) and manual frequency restoration reserve (mFRR). It provides the energy balance to restore the frequency into the safe range. This reserve is activated after 5 min and for a longer duration (12.5 min) for the manually activated one [40]. The last reserve is the replacement reserve (RR) or tertiary control. Its activation starts after 15 min and lasts up to 60 min or even several hours in case of multiple incidents. The goal is mainly to recharge the consumed primary and secondary reserves while clearing the last imbalances [40].

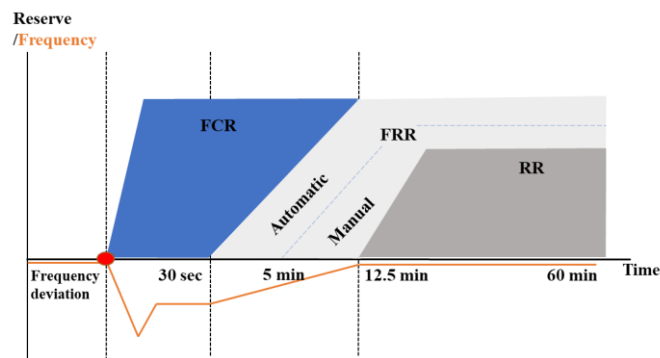

Fig.2 Frequency regulation services characteristics [40]

ESSs can uptake additional revenues with the provision of balancing reserves and energy products for both upward and downward frequency regulations. When the reserve is activated, the battery modifies the output power values either charging or discharging to cover the required change. Regulation profits are typically divided into two parts. Firstly, there is a remuneration for the reserved capacity, where the operator gets paid per each MW reserved (€/MW). Secondly, there is a remuneration/cost for actual energy supplied/consumed in case of activation (€/MWh) [40]. Note that while reserve remuneration is always positive, energy remuneration is either positive if discharging (upward reserve) or negative if charging (downward reserve). The modeling of frequency regulation services is accounting for price data collection and also activation signals.

Since it is difficult to retrieve the activation signals for a single asset, an assumption of the fixed portion of the reserve to be activated is done in the following models. Four main parameters are introduced to model the energy quantity and activation time for each reserve. The activated energy (in MWh) is considered a fixed portion of the frequency reserve capacity (in MW), and a fixed coefficient β is used to represent this ratio for both upward and downward regulation with a value assumed to be 0.15 [41,42]. However, a side study has been made to determine the

⁴ European Commission, “Commission Regulation (EU) 2017/1485 of 2 August 2017 establishing a guideline on electricity transmission system operation.”

optimum values of the distinctive activation ratios in upward and downward directions that accurately describe the frequency deviation of the grid. Furthermore, two binary parameters $a_t^{bm,+}$, $a_t^{bm,-}$ (with $bm \in \{fcr, afrr, mfr, rr\}$) represent the time steps at which the reserve is activated. The values for these parameters are determined based on collected frequency measures and reserve activation from RTE [43]. In each of the following sections, an assumption is introduced to capture the values of these parameters per market.

2.3.1. Frequency containment reserve – FCR

The reserve product for FCR is symmetric, which means that the same reserve power is to be committed in both upward and downward directions. FCR has six daily reserve products with four-hour time resolutions each [44]. However, the activated energy changes according to the grid frequency deviations within a fast time response, in the interval of 30 s. This activated energy is constant for a duration of 15 min after the reception of activation signals [44]. The objective function (8) maximizes the revenues from both the reserve and the activated energy of FCR throughout the day. The first part represents the reserve power remuneration (€/MW), where $t \in T$ is a temporal set representing one day at a resolution of 4 h. The second part represents the activated energy remuneration (€/MWh), where $j \in J$ is a subset of T with a resolution of 15 min. The negative sign in the activation part shows that the ESS owner pays while supplying downward regulation for the amount of charged energy.

The energy quantity for the reserve is limited by the battery power capacity, as expressed in (9). The activated quantities in both upward and downward regulations ($\Delta p_{t,j}^{fcr,+}$, $\Delta p_{t,j}^{fcr,-}$) are defined in the equations (10) and (11), where $a_{t,j}^{fcr,+} = 1$, if frequency measures are below 50 Hz hence upward regulation is needed. In the same manner $a_{t,j}^{fcr,-} = 1$, if frequency measures are above 50 Hz and downward regulation shall be supplied. The binary parameters for reserve activation are updated each 15 min (dt^{fcr}).

$$\max_{p_t^{fcr}} C_{fcr} = \sum_{t \in T} \sum_{j \in J} \pi_t^{fcr,r} \times p_t^{fcr} + \pi_{t,j}^{fcr,a} \times dt^{fcr} \times (\Delta p_{t,j}^{fcr,+} - \Delta p_{t,j}^{fcr,-}) \quad (8)$$

$$p_t^{fcr} \leq p_{\max} \quad (9)$$

$$\Delta p_{t,j}^{fcr,+} = p_t^{fcr} \times \beta \times a_{t,j}^{fcr,+} \quad (10)$$

$$\Delta p_{t,j}^{fcr,-} = p_t^{fcr} \times \beta \times a_{t,j}^{fcr,-} \quad (11)$$

2.3.2. Automatic frequency restoration reserve – aFRR

The reserve products for aFRR are non-symmetric, which means that reserve can be allocated in only one direction. That gives a higher potential for ESS as the direction and quantity of reserve can be changed every hour. On the other hand, the activated energy still changes according to the frequency deviations and activation with a maximum 15 min activation duration. Similar to FCR, the objective function (12) is the revenue from the aFRR reserve and energy products, but in that case, $t \in T$ is a temporal set of a day at a resolution of 1 h.

The constraint (13) represents the power capacity limits for upward and down reserves (only one is allowed at each time step). The activated quantities in both upward and downward regulations ($\Delta p_{t,j}^{afrr,+}$, $\Delta p_{t,j}^{afrr,-}$) are defined in equations (14) and (15). The values for the activation binary parameters are assigned using the collected historical

data from RTE. If the aFRR upward activation energy quantity was higher than zero in the considered time step, $a_{t,j}^{afrr,+} = 1$. In the same manner $a_{t,j}^{afrr,-} = 1$, if the aFRR downward activation energy quantity was higher than zero in the considered time step. These parameters are updated every 15 min (dt^{afrr}).

$$\max_{p_t^{afrr,+}, p_t^{afrr,-}} C_{afrr} = \sum_{t \in T} \sum_{j \in J} \left(\pi_t^{afrr,r} \times (p_t^{afrr,+} + p_t^{afrr,-}) \right) + \left(\pi_{t,j}^{afrr,a} \times (\Delta p_{t,j}^{afrr,+} - \Delta p_{t,j}^{afrr,-}) \times dt^{afrr} \right) \quad (12)$$

$$p_t^{afrr,+} + p_t^{afrr,-} \leq p_{\max} \quad (13)$$

$$\Delta p_{t,j}^{afrr,+} = p_t^{afrr,+} \times \beta \times a_{t,j}^{afrr,+} \quad (14)$$

$$\Delta p_{t,j}^{afrr,-} = p_t^{afrr,-} \times \beta \times a_{t,j}^{afrr,-} \quad (15)$$

2.3.3. Balancing reserve - mFRR and RR

The products for manual reserves, mFRR, and RR are divided into balancing reserves (br) and balancing energy (be) markets. In balancing reserve, the products are only upward reserves, at a 30 min resolution. Hence, the ESS operator is only paid for the reserved power (€/MW). No energy is considered in this market. On the other hand, the committed reserve in this market can be activated in the balancing energy market based on the TSO's needs. The objective function (16) represents the revenues from the mFRR and RR reserve markets, where $br \in \{mfrr, RR\}$, and $t \in T$ is a temporal set for one day at a resolution of 30 min. Unlike FCR and aFRR, manual reserves are not always procured. Hence, the binary parameter a_t^{br} is used to represent the procurement signals, that depend on the need of the TSO for the reserve at each delivery period. Constraint (17) limits the total reserve provided for the two products by the battery power capacity.

$$\max_{p_t^{br}} C_{br} = \sum_{t \in T} (\pi_t^{br,r} \times p_t^{br} \times a_t^{br}) \quad (16)$$

$$p_i^{br} \leq p_{\max} \quad (17)$$

2.3.4. Balancing energy - mFRR and RR

The activated energy for manual reserves can be either upward or downward, with a 15 min resolution. Upward energy products consist of an activated percentage of the committed reserve in the balancing reserve market, in addition to new energy products that can be introduced only as energy bid (no capacity). Downward energy products for manual regulation can only be introduced in this market and the ESS operator is only paid for the energy (€/MWh). Ultimately, the objective function for balancing energy in (18) sums all the revenues from the activated reserve and energy products, where $br \in \{mfrr, RR\}$, and $t \in T$ is a temporal set for one day at a resolution of 15 min.

The first part is the activated upward reserve from the balancing capacity, where the quantity to be activated from the upward reserve (Δp_t^{be}) is determined by the constraints (19). The second part introduces new energy products for manual energy regulation (mFRR and/or RR) that can be used either in upward or downward regulation. Contrary to the other reserves, manual reserves have distinctive prices for charging and discharging energy products. The values of binary parameters $a_t^{be,a+/-}$ is collected from historical data based on whether there was an activated quantity for each type of reserve or not. The operation of the balancing reserve and balancing energy markets can be combined

into one optimization problem. In this paper, it was represented as a two-stage optimization process to have a more accurate representation of the real operation in the European energy market and for the sake of clarity.

$$\max_{p_t^{be,+}, p_t^{be,-}} C_{be} = \sum_{t \in T} (\pi_t^{be,a+} \times dt^{be} \times \Delta p_t^{be}) + ((\pi_t^{be,a+} \times p_t^{be,+} \times a_t^{be,+} - \pi_t^{be,a-} \times p_t^{be,-} \times a_t^{be,-}) \times dt^{be}) \quad (18)$$

$$\Delta p_t^{be} = p_t^{be} \times \beta \times a_t^{be,+} \quad (19)$$

2.4. Capacity market

The capacity market vary between European countries based on the physical need. The market design and remuneration scheme reflect the usage of these reserve. That can vary between providing flexibility, coordination, and providing peak load [45]. The French capacity mechanism guarantees the security of the power supply during peak demand periods, especially in winter. The TSO notifies the day before the peak periods, during which capacity operators will have to fulfill their respective obligations. Capacity can be called upon from ten to twenty-five days a year, from November to March, in the time slots from 7 am to 3 pm and from 6 pm to 8 pm, which is represented using the binary parameter a_t^{cap} [45]. The revenue from this service is given by (20) where $t \in T$ is a set of a day with a 1 h timestep. It is clear in (20) that capacity is modeled as only discharged power, that is activated when notified by TSO. The binary parameter a_t^{cap} indicates whether or not a capacity reserve is needed by the TSO. When $a_t^{cap} = 1$, the storage shall provide a constant power value along the notified time slot (21).

$$\max_{p_t^{cap}} C_{cap} = \sum_{t \in T} \pi_t^{cap} \times p_t^{cap} \times a_t^{cap} \quad (20)$$

$$p_t^{cap} = p_{t+1}^{cap} \quad (21)$$

2.5. Multiple service formulation

The formulation of stacking multiple services is presented in (22), where all objective functions introduced before are summed. The corresponding energy products for each market are stacked also to form the total discharged and charged energy from the battery in equations (23) and (24). The latter two equations are used to update the battery SOC at each time step, as introduced in (3). The fixed time index (t) is used for clarification only, however, in real life and the implementation of simulation in this work it follows distinctive time sets and resolutions for each product. In the case of comparing various market combinations, when the objective function of a certain market is not considered, the corresponding variables are set to zero in both (23) and (24).

$$\max C_{total} = C_{da} + C_{id} + C_{fcr} + C_{afrr} + C_{br} + C_{be} + C_{cap} \quad (22)$$

$$p_t^+ = p_t^{da,+} + p_t^{id,+} + \Delta p_t^{fcr,+} + \Delta p_t^{afrr,+} + \Delta p_t^{br} + p_t^{be,+} + p_t^{cap} \quad (23)$$

$$p_t^- = p_t^{da,-} + p_t^{id,-} + \Delta p_t^{fcr,-} + \Delta p_t^{be,-} + p_t^{rr,-} \quad (24)$$

3. DIRECT / OPPOSITE RESERVES MODELING FOR FCR

Preliminary results that will be further discussed in section 4 showed that frequency regulation services are the most lucrative for BESS. The manual reserves (mFRR and RR) achieve the highest revenues among the different

frequency services, however, the current regulations in Europe only permit ESS to participate in FCR and automatic reserves (aFRR). Hence, we propose a novel modelling approach in this section that allows BESS to provide more frequency reserve (FCR or aFRR) while participating in a joint reserve and energy market. As FCR is more intricate to model due to symmetric bidding and longer bidding resolution, the presented algorithm accounts for FCR and DA. It can subsequently be adjusted to aFRR with non-symmetric reserve products and different bidding resolution.

The proposed model is based on four modes of operations to provide reserve: charging less, charging more, discharging less, and discharging more. Indeed, previous conventional formulations for frequency containment reserve (FCR) in power systems have been dependent on the battery charging/discharging state [10–15], following the regulation for storage systems, meaning that upward reserve can only be supplied while discharging and downward reserve can only be provided while charging, these reserves are noted in this study as direct reserve. In contrast, the proposed formulation allows for two more modes, where the provision of upward or downward reserve in either the charging or discharging mode, the final four modes are illustrated in Fig.3. In the charging state, the downward reserve can be provided by increasing the charging power, while the upward reserve can be provided by charging less. Similarly, in discharging mode, the downward reserve can be provided by discharging less, and an upward reserve can be provided by discharging more. The operation of the four modes are. By utilizing this reserve formulation, a joint energy and reserve model can increase the capacity of ESS reserves by utilizing the committed discharge energy as a downward reserve, and the committed charge energy as an upward reserve, which are donated as opposite reserves.

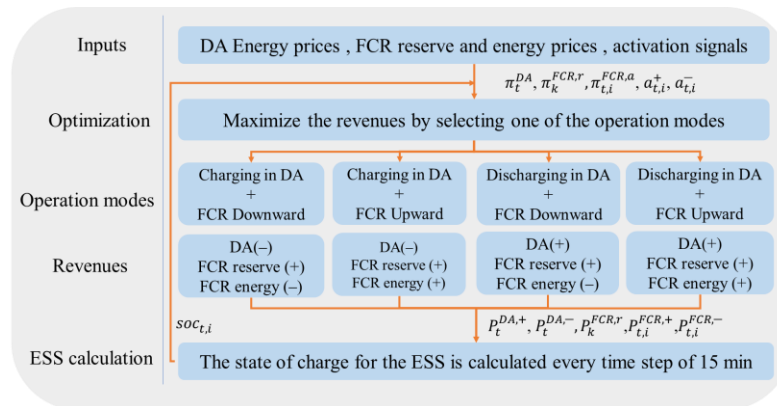

Fig.3 Technical operation of Direct / opposite joint DA and FCR reserve algorithm

This approach allows for greater flexibility in the provision of ESS reserves, enabling the system to optimize its performance and maximize its profitability. In addition, it reduces the cost of charged energy by providing down-regulation through the mode of “discharging less”. However, this strategy also leads to a change in the committed energy and shifts the ESS from one battery status to another. As a result, it is necessary to ensure that the operation algorithm aligns with the regulations established by the TSO. A similar approach was proposed in [35], where there was the option to switch from charging to discharging state and the only non-symmetric reserve was modeled. In this work, the symmetric reserve is considered and the activated energy to frequency regulation is modeled.

To formulate the joint day-ahead (DA) and frequency containment reserve (FCR) with a four modes model, two continuous variables are introduced for upward and downward regulation, as shown in the objective function (25). Those variables p_t^{dir} and p_t^{opp} represent the FCR reserves over a set of time, denoted as $t \in T$, which is set to one day with a resolution of 4 h. Specifically, p_t^{dir} represents the direct FCR reserve for regulation in the same sign as the committed energy in the DA market, and p_t^{opp} represents the FCR reserve for regulation in the opposite sign. In addition, the variables $\Delta p_{t,j}^{dir,+}$, $\Delta p_{t,j}^{dir,-}$, $\Delta p_{t,j}^{opp,+}$, $\Delta p_{t,j}^{opp,-}$, represent the FCR activation quantities over the time set, denoted as $j \in J$, which is set to 4 h with a resolution of 15 min. The variables $p_{t,k}^{da,+}$, $p_{t,k}^{da,-}$ represent the charging and discharging quantities for the DA over the time set, denoted as $k \in K$, which is set of 4 h with 1 h resolution.

$$\begin{aligned} & \max_{p_t^{fcrl}, p_t^{fcrl2}, p_{t,k}^{da,-}, p_{t,k}^{da,+}} \sum_{t \in T} \sum_{k \in K} \sum_{j \in J} \pi_{t,k}^{da} \times (p_{t,k}^{da,-} - p_{t,k}^{da,+}) \times dt^{da} + \pi_t^{fcrl,r} \times p_t^{dir} + \pi_{t,j}^{fcrl,a} \times dt^{fcrl} \times (\Delta p_{t,j}^{dir,+} - \Delta p_{t,j}^{dir,-}) \\ & + \pi_t^{fcrl,r} \times p_t^{opp} + \pi_{t,j}^{fcrl,a} \times dt^{fcrl} \times (\Delta p_{t,j}^{opp,+} - \Delta p_{t,j}^{opp,-}) \end{aligned} \quad (25)$$

The constraints for modes 1 and 3 (FCR reserve for regulation with the same sign as the committed energy in DA) are:

$$p_{t,j}^{dir,+} + p_{t,k}^{da,+} \leq p_{\max} \times u_{t,j}^+ \quad (26)$$

$$p_{t,j}^{dir,-} + p_{t,k}^{da,-} \leq p_{\max} \times u_{t,j}^- \quad (27)$$

$$p_{t,j}^{dir} = \min(p_{t,j}^{dir,+}, p_{t,j}^{dir,-}) \quad (28)$$

$$u_{t,j}^+ + u_{t,j}^- \leq 1 \quad (29)$$

$$\Delta p_{t,j}^{dir,+} = p_t^{dir} \times \beta \times a_{t,j}^{fcrl,+} \quad (30)$$

$$\Delta p_{t,j}^{dir,-} = p_t^{dir} \times \beta \times a_{t,j}^{fcrl,-} \quad (31)$$

The traditional constraints for the operation of joint energy and reserve problem are presented in (26) - (31). Constraints (26) and (27) limit the total battery output at charging and discharging modes. They represent the operations of discharging more to supply upward regulation and charging more to supply downward regulation respectively, as shown in Fig.4 for both modes 1 and 3. Since FCR is a symmetric reserve product, the minimum value from both up and down reserves ($p_{t,j}^{dir,+}$, $p_{t,j}^{dir,-}$) is selected (28). The binary variables $u_{t,j}^+$, and $u_{t,j}^-$ are introduced to avoid charging and discharging at the same time in (29). Constraints (30) and (31) define the activated energy for FCR using binary parameters, similar to the previous market models.

The constraints for modes 2 and 4 (FCR reserve for regulation with an opposite sign of the committed energy in DA) are:

$$p_{t,k}^{da,+} - p_t^{opp,-} \times u_{t,j}^{+,opp} \geq 0 \quad (32)$$

$$p_{t,k}^{da,-} - p_t^{opp,+} \times u_{t,j}^{-,opp} \geq 0 \quad (33)$$

$$u_{t,j}^{+,opp} \leq u_{t,j}^+ \quad (34)$$

$$u_{t,j}^{-,opp} \leq u_{t,j}^- \quad (35)$$

$$p_{t,j}^{opp} = \min(p_{t,j}^{opp,+}, p_{t,j}^{opp,-}) \quad (36)$$

$$\Delta p_{t,j}^{opp,+} = p_t^{opp} \times \beta \times a_{t,j}^{fcr,+} \quad (37)$$

$$\Delta p_{t,j}^{opp,-} = p_t^{opp} \times \beta \times a_{t,j}^{fcr,-} \quad (38)$$

$$p_t^+ = p_{t,k}^{da,+} + \Delta p_{t,j}^{dir,+} - \Delta p_{t,j}^{opp,-} \quad (39)$$

$$p_t^- = p_{t,k}^{da,-} + \Delta p_{t,j}^{dir,-} - \Delta p_{t,j}^{opp,+} \quad (40)$$

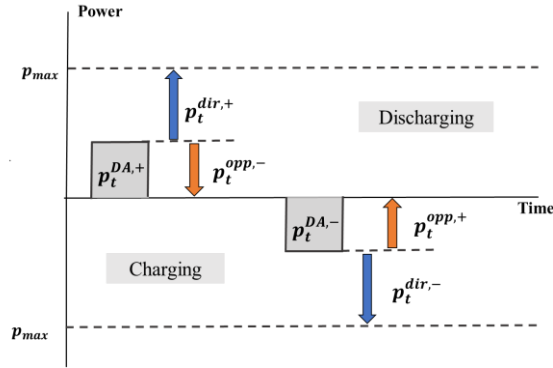

Fig.4 Illustration of battery operation using the four modes method

Constraints (32) and (33) introduce the new reserves that allow the ESS to provide FCR regulation in the opposite sign of the committed energy in DA. Where (32) allocates the discharge energy product of DA as a downward FCR reserve, and (33) allocates the charge energy product of DA as an upward FCR reserve. That is illustrated in Fig.4 for both modes 2 and 4 respectively. The constraints (32) and (33) are non-linear, due to the multiplication of the binary variables with the continuous variables. Linearized constraints are then introduced in (41) – (44) to replace them, using the Big M method [36], where the continuous variables ($z_t^{opp,+}$, $z_t^{opp,-}$) and the binary variables ($u_{t,j}^{opp,+}$, $u_{t,j}^{opp,-}$) were introduced. Constraints (34) and (35) define the four modes slots by allowing to provide FCR regulation in the opposite sign of DA energy products. Equations (39) and (40) define the total discharged and charged energy at each time step to be used for soc update in (3).

$$p_{t,k}^{da,+} - z_t^{opp,+} \geq 0 \quad (41)$$

$$z_t^{opp,+} \geq p_t^{opp} - (1 - u_{t,j}^{opp,+}) \times p_{\max} \quad (42)$$

$$p_{t,k}^{da,-} - z_t^{opp,-} \geq 0 \quad (43)$$

$$z_t^{opp,-} \geq p_t^{opp} - (1 - u_{t,j}^{opp,-}) \times p_{\max} \quad (44)$$

4. MAIN RESULTS

Potential revenues for ESS and opportunities to participate in different energy markets are assessed over a year, considering historical data in 2021 for the French electricity market. Various market combinations were tested to reach

the optimum stack of services and evaluate the expected profits. Energy, reserve prices, and activation signals were collected from RTE and Ensto-e 2021 databases [43]. A 10 MW/10 MWh ESS is considered with the following parameters: $\eta^- = \eta^+ = 0.9$, $soc_{min} = 0.2$, $soc_{max} = 0.9$, $soc_0 = 0.5$. The assumption of a fixed portion of the reserve that is activated is used in this work, and the coefficient value is assumed to be $\beta = 0.15$ [41]. The yearly simulation is done with successive daily optimizations (i.e. $T = 24$ hours) and distinctive resolution for each market (i.e. 1 h for DA, 30 min for ID, 1 h / 4 h reserve products for FCR / aFRR, 30 m for Balancing capacity and 15 m for Balancing energy).

The main objective of the study is to assess the maximum expected revenue by individually providing each service detailed in Section 2, as well as exploring the possibility of stacking multiple services utilizing the same BESS. The subsequent section presents the outcomes of the novel approach for the joint energy and reserve market (FCR + DA), along with a comparative analysis of annual revenues generated by both the conventional model (detailed in Section 2) and the new proposed model (detailed in Section 3). Additionally, a sensitivity analysis is conducted to illustrate the impact of alterations in the volume of activated energy on frequency regulation revenues. Finally, an economic analysis using Net present value is presented to evaluate the risks of BESS investment.

4.1. Stacked revenues simulation

In this simulation, various combinations of energy markets were analyzed to assess their impact on the revenues of an energy storage system (ESS). The results show that wholesale energy markets DA and ID achieve less revenues than frequency services, as presented in Fig.5. The study also indicates that the long-term capacity market exhibits limited potential. The analysis shows that ID profits are higher than DA due to higher volatility in prices and shorter market resolution that allows better arbitrage opportunities. Moreover, in frequency reserves, aFRR overperforms other services due to unsymmetrical bidding and high reserve prices. In the case of FCR, symmetric bidding forces the battery to participate in downward regulation, which leads to negative costs that eliminate the profits from the upward regulation. On the other hand, in manual frequency reserves, the remuneration for reserves is much less than other types of reserves.

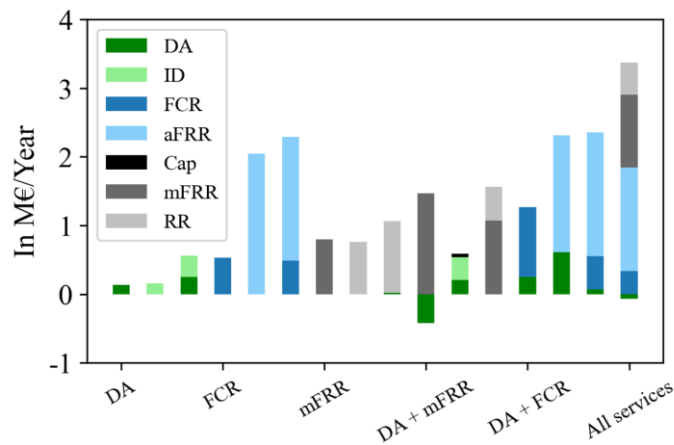

Fig.5 Multiple service revenues of ESS for annual simulation

As displayed in Fig.6, the prices for manually activated energy products (mFRR and RR) are more volatile than those for FCR and aFRR. Note that, there are distinct prices for upward and downward regulation in mFRR and RR,

which differ from the reference price (DA). This discrepancy in prices allows for increased revenues by charging at low rates and discharging in the DA market or providing upward regulation at higher prices, leading to greater profits and better opportunities in mFRR and RR - either as standalone services or in combination with energy products as DA.

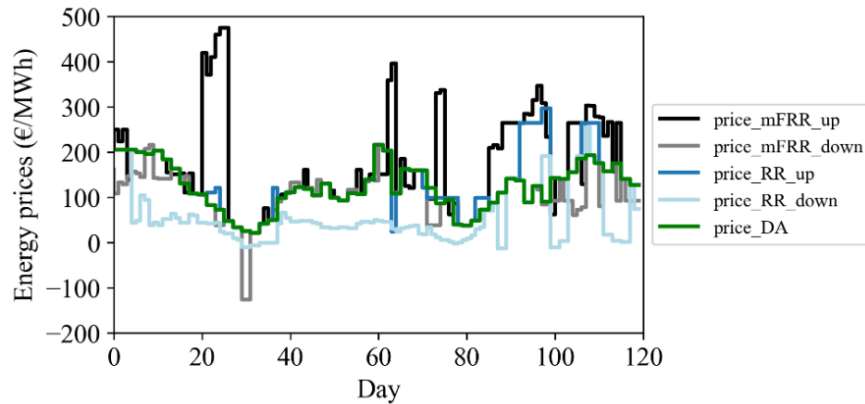

Fig.6 Energy prices in the last two months in 2021

The simulation study found that stacking all markets (except capacity) increases the annual revenues up to around 3.3 M€ for a 10 MW/10 MWh ESS. Providing multiple services allows for the maximization of annual revenues, which are higher than those generated by any single market or even any combination of two markets, as presented in Fig.5. Combining the DA and ID markets increased revenues from 258 k€ (the sum of DA and ID when provided as single services) to 560 k€. Similarly, the profits of stacking DA and FCR are 76 % more than the sum of profits generated by two separate batteries. Moreover, the results highlight the significance of thoughtful service selection when implementing service stacking strategies. While frequency services demonstrate high performance individually, stacking them together does not guarantee increased profitability. This is evident in the case of stacking FCR with aFRR or mFRR with RR, as the combined revenue falls short of the sum of the individual services. This outcome can be attributed to the similarities between the market products and the specific remuneration structure. Simulation results support the notion that stacking markets with distinct product types is more financially advantageous. For example, combining the DA with FCR allows the BESS to leverage the interaction between reserve and energy products across the two markets. The DA market facilitates battery charging, while the reserves can be allocated to FCR to achieve higher profits without significantly impacting the battery's state of charge.

Overall, joint energy and reserve services are well-suited to leverage the characteristics of both services to optimize the economic performance of the ESS. These revenues depend on the type of frequency service included, as shown in Fig.7. An analysis of the components of frequency service revenue shows that the majority of profits in certain combinations of services (DA + mFRR and DA + RR) are generated from energy products, while in other combinations (DA + FCR or DA + aFRR), profits are dependent solely on reserve revenues (for the reserved power/capacity). This is because providing downward regulation to the grid in FCR and aFRR incur costs while charging from the grid, while manual reserves (mFRR and RR) have lower costs associated with downward regulation.

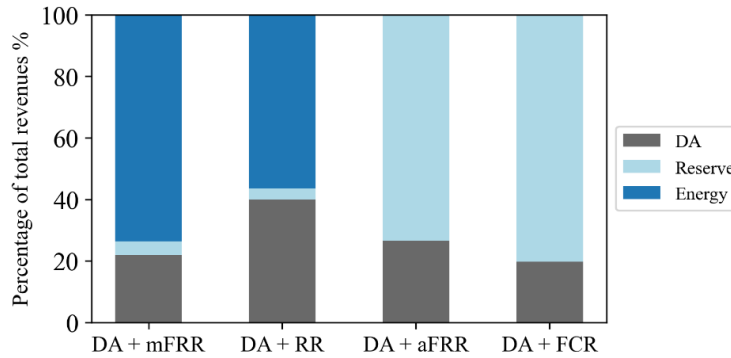

Fig.7 Services percentages of total annual revenues

4.2. Direct / opposite reserves control simulations

Since DA+FCR showed the highest increase in profits using the stacked services approach, it was intuitive to further enhance the operation of this joint energy and reserve market. The four modes of operation allow the ESS to increase its reserve capacity and energy supply independently from the battery's charging and discharging mode. The performances of the proposed approach are here assessed with an ESS providing DA and FCR products daily and annually using the data of 2021. This analysis revealed that the four modes' operation enabled a higher allocation of FCR reserve power by 11 %, as evidenced by the comparison between panels (a) and (b) of Fig. 8. This outcome can be attributed to the ability of the ESS to utilize the energy committed in the DA market as a reserve and to provide both upward and downward regulation at any time. For example, between 8 am and 12 am, the conventional modeling for reserve provision could only allocate discharging DA, with no FCR participation. By contrast, the four modes of operation allow the ESS to provide downward regulation by committing more energy in DA and allocating this energy product as a reserve for FCR. This reserve was used to provide downward regulation (discharging less) in this time interval, the four modes slots are shown in Fig. 8(b). The increase in the committed DA energy products and FCR power reserves resulted in a 35.7 % increase in total daily revenues for the analyzed day.

Annual simulations show that the approach can significantly enhance the performance of an energy storage system (ESS), with a 22.8 % revenue increase when combining DA and FCR services, as shown in Table.2. As previously mentioned, this increase in profits can be attributed to the ability of the ESS to utilize the energy committed in the DA market as a reserve for frequency regulation. This utilization increases profits for both wholesale energy and frequency reserve, as it allows the ESS to allocate more energy products that act as reserves for FCR services. Every year, this increased allocation leads to a higher total annual FCR reserve by 10.2 % and, consequently, greater activation of energy for FCR services. However, it is noted that the energy revenues for FCR are still negative revenues due to the costs when charging to provide downward regulation. Overall, the approach described represents a significant advancement in the ability of ESSs to generate revenues through the provision of reserve capacity and energy supply in energy markets.

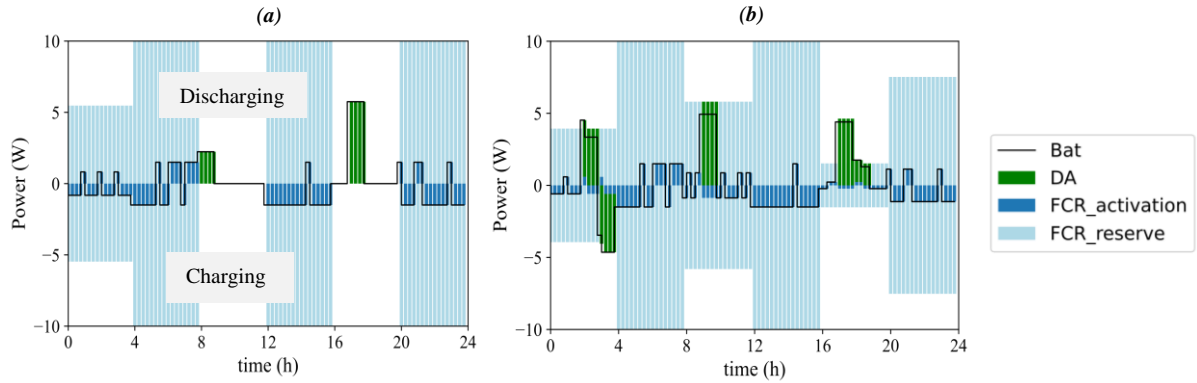

Fig. 8 A day time series (n=347) for battery output profile a) normal operation b) Direct/opposite reserve operation

Table.2: Four modes' annual revenues in € for the conventional modeling and the proposed "four modes" approach

	Conventional operation	Direct/opposite reserves	Gain
DA	197,934 €	453,625 €	+129 %
FCR reserve	15,931 MW	17,563 MW	+10.2 %
FCR total	983,716 €	997,624 €	+1.4 %
FCR reserve	1,212,276 €	1,277,655 €	+5.4 %
FCR energy	-228,560 €	-280,031 €	+22.5 %
Total profits	1,181,651 €	1,451,249 €	+22.8 %

4.3. Effect of activation signals (β) on annual profits

Revenue from the FCR market strongly depends on the assumption made on the activation. Especially, the coefficients β^+ and β^- represent the ratio of the activated reserve over the total reserve capacity whenever there is a response to frequency deviations. Therefore, their values significantly impact the battery output contribution to the FCR market. When those ratios increase, more energy is activated and the ESS owner receives more money for upward activation or pays more for downward activation. This relationship can be seen in Fig. 9(a), in normal operation using conventional modeling, where the annual revenues from the FCR market decrease as the activation ratio increases. A similar trend for FCR revenues is also observed using the four-mode operation, though with a smaller decrease in revenues. This is due to the reliance on reserve to generate profits in the FCR market, as revenues are not achieved through energy activation, which incurs additional costs for the ESS owner.

In contrast, the revenues from the DA market (in normal operation) increase with higher values of β , as more energy can be monetized in the DA trading market. More importantly, a significant increase in DA profits is observed when using the four-mode operation. This is due to the commitment of more DA energy products that act as reserves for the FCR market, resulting in increased profits in both DA and FCR markets. Overall, after the combination of both DA and FCR revenues, the decrease in FCR revenues with the conventional modeling is more significant than the increase in DA revenues. This results in a decrease in total revenues, as shown in Fig. 9(b). In contrast, the direct/opposite reserve control maximizes revenues even when the activation ratio is changed, by utilizing the DA reserves. That limits the decrease in revenues to only 2 % compared to 24.2 % in traditional operations. Thus, the

four-mode approach is more robust against high activation percentages of the reserve and allows higher revenues in all studied cases.

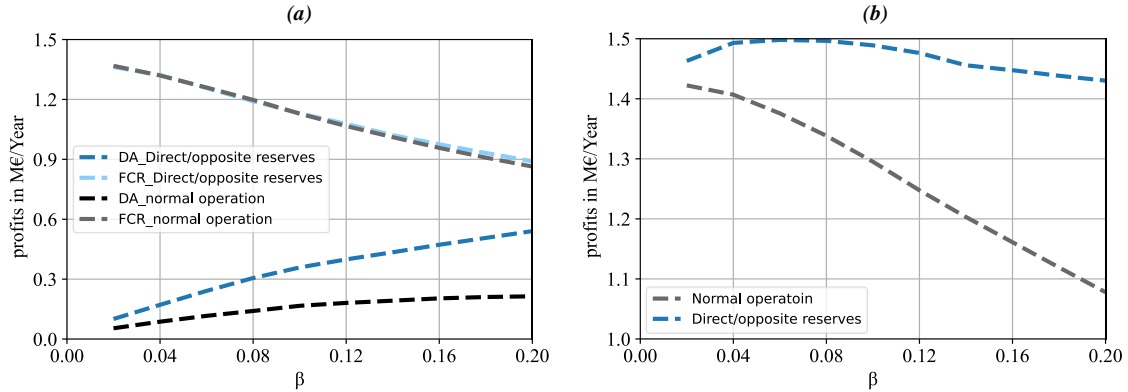

Fig. 9 Effect of β on ESS annual revenues a) DA and FCR annual profits b) Total annual profits (DA+FCR)

4.4. Economical assessment

In this subsection a simple economic analysis is performed using the Net Present Value (NPV) metric to assess the investment of BESS in joint energy and reserve (DA + FCR) markets. BESS degradation highly affects the system operation and costs it must be taken into consideration while evaluating the markets application [46]. The BESS degradation has been simply modeled with an assumption of decreasing the battery capacity due to aging. NPV is used to calculate the present value of future cash flows generated by a project, which includes both investment costs and expected revenue streams over the project's lifespan [47]. The NPV is calculated as presented in (45), where C_0 is the initial cost for both the battery and power converters, C_t is the yearly operational cost, i is the discount rate which is calculated by adding both interest and inflation rates, r_t is the annual BESS revenues from both DA and FCR markets, t is the number of the year, n is the BESS lifetime, and s_n represents the salvage value of the storage system at the end of the project. This residual value depends on the depreciation rate of the battery, as calculated in (46).

$$NPV = -c_0 + \sum_{t=0}^n \frac{r_t - c_t}{(1+i)^t} + \frac{s_n}{(1+i)^n} \quad (45)$$

$$s_n = c_0 \times (1-d)^n \quad (46)$$

Table 3 BESS parameters used in the economic analysis

BESS Parameter	Value
BESS fixed cost (c_0)	400 €/KWh, 300 €/KW [48]
BESS operational cost (c_t)	8 €/KW [48]
Lifetime guaranteed (n)	10 years [47]
Interest rate	3.5 % [47]
Inflation rate	2.07 % (2021 year) ⁵
Depreciation rate (d)	12% [47]

⁵ <https://www.statista.com/statistics/270353/inflation-rate-in-france/>

The Net Present Value (NPV) was calculated for three different cases to assess the economic feasibility with different assumptions. In the first case, discount rate of zero was considered, which equates to a calculation of total cash inflows minus total cash outflows without accounting for the time value of money. In the second case, a discount rate of 5.7 % was used to reflect the investment risk along with including the depreciation cost. In the third case, degradation was factored in by considering a 2 % annual decrease in battery capacity. Results demonstrate that the NPV for the BESS is always positive, indicating the project's economic viability. However, the break-even point or payback period varies depending on the assumptions made, as presented in Fig. 10. The analysis revealed that risk and depreciation had a considerable impact on the results, leading to an increase in the payback period from 5 years to 6.2 years. However, the effect of degradation was relatively minor, leading to an increase of only 0.2 years in the payback period. The optimum bids for energy and reserve products were not changed with considering capacity reduction, which indicate an oversizing issue in the battery selection. These findings highlight the importance of optimal sizing and accurate modeling of degradation for each market separately in future studies.

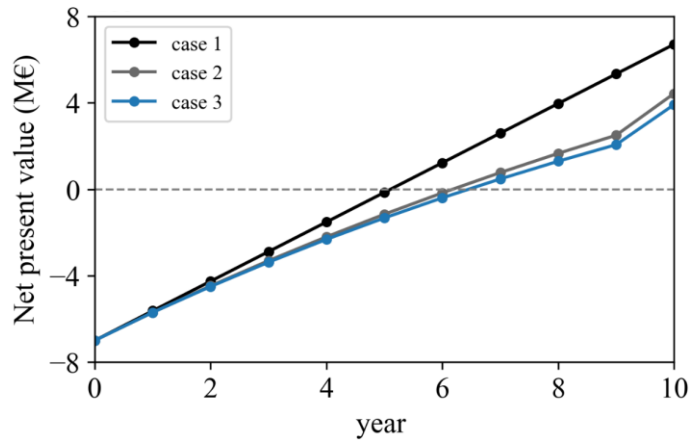

Fig. 10 Economical analysis for BESS in DA + FCR market using NPV

5. DISCUSSION

This study highlights the potential revenue streams for energy storage systems participating in various energy markets. The paper presents updated mixed integer linear programming models that conform to the 2021 European regulations regarding product types, bidding horizons, and resolution. FCR modeling included the symmetric bidding unlike previous publication that handled FCR as normal reserve market [33,35] or modeled as local products in the German market with pay as bid products and different bidding regulations [22,23]. Moreover, capacity market was not investigated before in literature unless in [29] where the European regulation for capacity activation were not considered. Manual frequency reserves (mFRR and RR) have been proposed for BESS applications in this work , which was not proposed before. The models also distinguished the new introduced products of balancing capacity and balancing energy for the manual reserves. It was found that providing manual regulation offers a competitive revenue potential. However, currently batteries are not allowed to participate in manual reserve in Europe due to specific technical capabilities and complex regulation. With the advance in storage types and large capacities that could be offered, that manual frequency will be open soon as real market opportunity.

The analysis conducted in this study utilized historical data and employed deterministic optimization techniques to assess various markets and estimate the maximum expected profits. However, achieving these revenues necessitates the implementation of an effective energy storage system (ESS) management strategy. Operational planning should be customized to accommodate uncertainties arising from factors such as prices and activation signals. The findings from the case studies reveal that the regulation market constitutes the primary source of profit for the BESS, but it is also accompanied by frequent cycling. Subsequent research endeavors could incorporate more precise modeling techniques that account for degradation and aging, thereby providing a more accurate representation of the efficiency impacts during part-load operations. Furthermore, considering the declining prices in the regulation markets, particularly with the integration of European markets, BESS operators should factor in this aspect when projecting future investment revenue estimates.

6. CONCLUSIONS

This paper provides a comprehensive investigation into the combination of various energy markets for a Battery Energy Storage System (BESS) participation. Specifically, the study considers six markets, namely the day-ahead market (DA), intraday market (ID), frequency containment reserve (FCR), frequency restoration reserve (FRR), replacement reserve (RR), and capacity market. The findings reveal that offering multiple services yields the highest revenues for a connected ESS, where 3.3 million euros could be reached using 10MW/10MWh battery. In particular, the combined profits obtained from participating in only stacked FCR and DA markets were observed to be 76% higher than the total profits generated by two individual batteries, each operating in a single market.

Additionally, a novel formulation, termed "Direct/opposite reserve control," was proposed to model joint energy and reserve operations. This approach enables the allocation of more frequency reserves by utilizing the energy products of the day-ahead market as reserves. The proposed approach achieved 22.8% higher annual profits in the joint energy and reserve markets (DA + FCR), allocating 10.2% more FCR reserves annually compared to existing models in the literature. Economic viability was confirmed through the Net Present Value metric, even when considering degradation and depreciation costs. However, the inclusion of degradation led to a slight increase in the payback period from 6 years to 6.2 years. Overall, this study underscores the significance of regulatory adjustments for ESSs participating in wholesale energy markets and ancillary services to ensure grid stability during operation.

ACKNOWLEDGMENT

This work was performed in the framework of the project OSS platform, financed by La Région, Auvergne Rhone Alpes, France. This project has received funding from the European Union's ERDF (European Regional Development Fund).

7. REFERENCES

- [1] N. Kittner, F. Lill, and D. M. Kammen, "Energy storage deployment and innovation for the clean energy transition," *Nat. Energy*, vol. 2, no. 9, p. 17125, Jul. 2017, doi: 10.1038/nenergy.2017.125.
- [2] P. Tielens and D. Van Hertem, "The relevance of inertia in power systems," *Renew. Sustain. Energy Rev.*, vol. 55, pp. 999–1009, Mar. 2016, doi: 10.1016/j.rser.2015.11.016.
- [3] M. Zidar, P. S. Georgilakis, N. D. Hatziaegyriou, T. Capuder, and D. Škrlec, "Review of energy storage allocation in power distribution networks: applications, methods and future research," *IET Gener. Transm. Distrib.*, vol. 10, no. 3, pp. 645–652, Feb. 2016, doi: 10.1049/iet-gtd.2015.0447.

- [4] V. Krishnan and T. Das, "Optimal allocation of energy storage in a co-optimized electricity market: Benefits assessment and deriving indicators for economic storage ventures," *Energy*, vol. 81, pp. 175–188, Mar. 2015, doi: 10.1016/j.energy.2014.12.016.
- [5] D. McConnell, T. Forcey, and M. Sandiford, "Estimating the value of electricity storage in an energy-only wholesale market," *Appl. Energy*, vol. 159, pp. 422–432, Dec. 2015, doi: 10.1016/j.apenergy.2015.09.006.
- [6] L. Maeyaert, L. Vandeveldel, and T. Döring, "Battery Storage for Ancillary Services in Smart Distribution Grids," *J. Energy Storage*, vol. 30, p. 101524, Aug. 2020, doi: 10.1016/j.est.2020.101524.
- [7] Engels, Jonas, Deconinck, Geert, and Claessens, Bert, "Integration of Flexibility from Battery Storage in the Electricity Market," PhD thesis, KU LEUVEN, 2020.
- [8] A. Shcherbakova, A. Kleit, and J. Cho, "The value of energy storage in South Korea's electricity market: A Hotelling approach," *Appl. Energy*, vol. 125, pp. 93–102, Jul. 2014, doi: 10.1016/j.apenergy.2014.03.046.
- [9] J. Deboever and S. Grijalva, "Energy storage dispatch under different ownership and control models," in *2017 IEEE Power & Energy Society General Meeting*, Chicago, IL: IEEE, Jul. 2017, pp. 1–5. doi: 10.1109/PESGM.2017.8274434.
- [10] S. Vejdani and S. Grijalva, "The Value of Real-Time Energy Arbitrage with Energy Storage Systems," in *2018 IEEE Power & Energy Society General Meeting (PESGM)*, Portland, OR: IEEE, Aug. 2018, pp. 1–5. doi: 10.1109/PESGM.2018.8585767.
- [11] M. A. Mosa and A. A. Ali, "Energy management system of low voltage dc microgrid using mixed-integer nonlinear programming and a global optimization technique," *Electr. Power Syst. Res.*, vol. 192, p. 106971, Mar. 2021, doi: 10.1016/j.epsr.2020.106971.
- [12] D. Zafirakis, K. J. Chalvatzis, G. Baiocchi, and G. Daskalakis, "The value of arbitrage for energy storage: Evidence from European electricity markets," *Appl. Energy*, vol. 184, pp. 971–986, Dec. 2016, doi: 10.1016/j.apenergy.2016.05.047.
- [13] D. Krishnamurthy, C. Uckun, Z. Zhou, P. R. Thimmapuram, and A. Botterud, "Energy Storage Arbitrage Under Day-Ahead and Real-Time Price Uncertainty," *IEEE Trans. Power Syst.*, vol. 33, no. 1, pp. 84–93, Jan. 2018, doi: 10.1109/TPWRS.2017.2685347.
- [14] A. Akbari-Dibavar, K. Zare, and S. Nojavan, "A hybrid stochastic-robust optimization approach for energy storage arbitrage in day-ahead and real-time markets," *Sustain. Cities Soc.*, vol. 49, p. 101600, Aug. 2019, doi: 10.1016/j.scs.2019.101600.
- [15] S. Vejdani and S. Grijalva, "The Value of Real-Time Energy Arbitrage with Energy Storage Systems," in *2018 IEEE Power & Energy Society General Meeting (PESGM)*, Portland, OR: IEEE, Aug. 2018, pp. 1–5. doi: 10.1109/PESGM.2018.8585767.
- [16] M. Salles, J. Huang, M. Aziz, and W. Hogan, "Potential Arbitrage Revenue of Energy Storage Systems in PJM," *Energies*, vol. 10, no. 8, p. 1100, Jul. 2017, doi: 10.3390/en10081100.
- [17] H. Khani, R. K. Varma, M. R. D. Zadeh, and A. H. Hajimiragha, "A Real-Time Multistep Optimization-Based Model for Scheduling of Storage-Based Large-Scale Electricity Consumers in a Wholesale Market," *IEEE Trans. Sustain. Energy*, vol. 8, no. 2, pp. 836–845, Apr. 2017, doi: 10.1109/TSTE.2016.2622003.
- [18] T. Zhang, S. X. Chen, H. B. Gooi, and J. M. Maciejowski, "A Hierarchical EMS for Aggregated BESSs in Energy and Performance-Based Regulation Markets," *IEEE Trans. Power Syst.*, vol. 32, no. 3, pp. 1751–1760, May 2017, doi: 10.1109/TPWRS.2016.2598186.
- [19] R. H. Byrne, R. J. Conception, and C. A. Silva-Monroy, "Estimating potential revenue from electrical energy storage in PJM," in *2016 IEEE Power and Energy Society General Meeting (PESGM)*, Boston, MA, USA: IEEE, Jul. 2016, pp. 1–5. doi: 10.1109/PESGM.2016.7741915.
- [20] R. Walawalkar, J. Apt, and R. Mancini, "Economics of electric energy storage for energy arbitrage and regulation in New York," *Energy Policy*, vol. 35, no. 4, pp. 2558–2568, Apr. 2007, doi: 10.1016/j.enpol.2006.09.005.
- [21] J. Fleer *et al.*, "Techno-economic evaluation of battery energy storage systems on the primary control reserve market under consideration of price trends and bidding strategies," *J. Energy Storage*, vol. 17, pp. 345–356, Jun. 2018, doi: 10.1016/j.est.2018.03.008.
- [22] M. Merten, C. Olk, I. Schoeneberger, and D. U. Sauer, "Bidding strategy for battery storage systems in the secondary control reserve market," *Appl. Energy*, vol. 268, p. 114951, Jun. 2020, doi: 10.1016/j.apenergy.2020.114951.
- [23] B. Zakeri, S. Syri, and F. Wagner, "Economics of energy storage in the German electricity and reserve markets," in *2017 14th International Conference on the European Energy Market (EEM)*, Dresden, Germany: IEEE, Jun. 2017, pp. 1–6. doi: 10.1109/EEM.2017.7981914.
- [24] J. Engels, B. Claessens, and G. Deconinck, "Optimal Combination of Frequency Control and Peak Shaving With Battery Storage Systems," *IEEE Trans. Smart Grid*, vol. 11, no. 4, pp. 3270–3279, Jul. 2020, doi: 10.1109/TSG.2019.2963098.
- [25] B. Zakeri and S. Syri, "Value of energy storage in the Nordic Power market - benefits from price arbitrage and ancillary services," in *2016 13th International Conference on the European Energy Market (EEM)*, Porto, Portugal: IEEE, Jun. 2016, pp. 1–5.
- [26] M. Kazemi, H. Zareipour, N. Amjadi, W. D. Rosehart, and M. Ehsan, "Operation Scheduling of Battery Storage Systems in Joint Energy and Ancillary Services Markets," *IEEE Trans. Sustain. Energy*, vol. 8, no. 4, pp. 1726–1735, Oct. 2017, doi: 10.1109/TSTE.2017.2706563.
- [27] E. Namor, F. Sossan, R. Cherkaoui, and M. Paolone, "Control of Battery Storage Systems for the Simultaneous Provision of Multiple Services," *IEEE Trans. Smart Grid*, vol. 10, no. 3, pp. 2799–2808, May 2019, doi: 10.1109/TSG.2018.2810781.
- [28] S. Yamujala, A. Jain, R. Bhakar, and J. Mathur, "Multi-service based economic valuation of grid-connected battery energy storage systems," *J. Energy Storage*, vol. 52, p. 104657, Aug. 2022, doi: 10.1016/j.est.2022.104657.
- [29] S. Vejdani and S. Grijalva, "Analysis of multiple revenue streams for privately-owned energy storage systems," in *2018 IEEE Power and Energy Conference at Illinois (PECI)*, Champaign, IL, USA: IEEE, Feb. 2018, pp. 1–5. doi: 10.1109/PECI.2018.8334979.
- [30] D. Wu, C. Jin, P. Balducci, and M. Kintner-Meyer, "An energy storage assessment: Using optimal control strategies to capture multiple services," in *2015 IEEE Power & Energy Society General Meeting*, Denver, CO, USA: IEEE, Jul. 2015, pp. 1–5.
- [31] S. Tong, H. Yang, and W. Torre, "Energy Storage System Dispatching Optimization in Stacked Applications for Utility Grid," *ElectEnergy Storage Appl Technol Conf EESAT San Diego CA USA*, 2018.
- [32] W. Seward, M. Qadrdan, and N. Jenkins, "Revenue stacking for behind the meter battery storage in energy and ancillary services markets," *Electr. Power Syst. Res.*, vol. 211, p. 108292, Oct. 2022, doi: 10.1016/j.epsr.2022.108292.
- [33] Y. Tian, A. Bera, M. Benidris, and J. Mitra, "Stacked Revenue and Technical Benefits of a Grid-Connected Energy Storage System," *IEEE Trans. Ind. Appl.*, vol. 54, no. 4, pp. 3034–3043, Jul. 2018, doi: 10.1109/TIA.2018.2825303.
- [34] G. He, Q. Chen, C. Kang, P. Pinson, and Q. Xia, "Optimal Bidding Strategy of Battery Storage in Power Markets Considering Performance-Based Regulation and Battery Cycle Life," *IEEE Trans. Smart Grid*, vol. 7, no. 5, pp. 2359–2367, Sep. 2016.
- [35] Z. Tang, J. Liu, Y. Liu, and L. Xu, "Stochastic reserve scheduling of energy storage system in energy and reserve markets," *Int. J. Electr. Power Energy Syst.*, vol. 123, p. 106279, Dec. 2020, doi: 10.1016/j.ijepes.2020.106279.
- [36] A. Khazali and M. Kalantar, "Stochastic reserve scheduling in smart systems incorporating energy storage systems," in *2017 IEEE International Conference on Environment and Electrical Engineering and 2017 IEEE Industrial and Commercial Power Systems Europe (EEEIC / I&CPS Europe)*, Milan, Italy: IEEE, Jun. 2017, pp. 1–6. doi: 10.1109/EEEIC.2017.7977427.

- [37] “ENSTO-E Balancing Report,” 2022, [Online]. Available: https://ee-public-nc-downloads.azureedge.net/strapi-test-assets/strapi-assets/2022_ENTSO_E_Balancing_Report_Web_2bddb9ad4f.pdf
- [38] “EPEX Spot - Operational Rules 2022.” EPEX SPOT, Oct. 22, 2021. [Online]. Available: <https://www.epexspot.com/en/regulation>
- [39] “EPEX Spot market data results - France,” EPEX SPOT, 2022, [Online]. Available: <https://www.epexspot.com/en/market-data>
- [40] “Frequency and Ancillary services regulations.” 2021. [Online]. Available: <https://www.services-rte.com/en/learn-more-about-our-services/providing-frequency-ancillary-services.html>
- [41] A. Berrada, K. Loudiyi, and I. Zorkani, “Valuation of energy storage in energy and regulation markets,” *Energy*, vol. 115, pp. 1109–1118, Nov. 2016, doi: 10.1016/j.energy.2016.09.093.
- [42] P. V. Brogan, R. Best, J. Morrow, R. Duncan, and M. Kubik, “Stacking battery energy storage revenues with enhanced service provision,” *IET Smart Grid*, vol. 3, no. 4, pp. 520–529, Aug. 2020, doi: 10.1049/iet-stg.2018.0255.
- [43] “Download data published by RTE - 2021.”, [Online]. Available: <https://www.services-rte.com/en/download-data-published-by-rte>
- [44] “Standard certification framework for primary frequency control capability ‘Storage Only.’” RTE , [in french : Annexe 15 : Trame type de certification de l’aptitude au réglage primaire de fréquence « Agrégats » ou « Stockage Seul »], 2021. [Online]. Available: https://www.cre.fr/content/download/22614/file/200722_2020-185_Approbation_Regles_Annexe15_TrameTypeAptitudesFCR.pdf
- [45] “French Capacity mechanism.” RTE , [in french : Retour d’expérience sur le mécanisme de capacité français], 2021. [Online]. Available: <https://www.services-rte.com/fr/actualites/mecanisme-de-capacite-publication-du-retour-d-experience.html>
- [46] P. V. H. Seger, R. Rigo-Mariani, P.-X. Thivel, and D. Riu, “A storage degradation model of Li-ion batteries to integrate ageing effects in the optimal management and design of an isolated microgrid,” *Appl. Energy*, vol. 333, p. 120584, Mar. 2023, doi: 10.1016/j.apenergy.2022.120584.
- [47] A. A. R. Mohamed, R. J. Best, X. Liu, and D. J. Morrow, “A Comprehensive Robust Techno-Economic Analysis and Sizing Tool for the Small-Scale PV and BESS,” *IEEE Trans. Energy Convers.*, vol. 37, no. 1, pp. 560–572, Mar. 2022, doi: 10.1109/TEC.2021.3107103.
- [48] W. Cole, A. W. Frazier, and C. Augustine, “Cost Projections for Utility-Scale Battery Storage: 2021 Update,” National Renewable Energy Laboratory, June 2021.