



HAL
open science

Bounds and Extremal Graphs for Total Dominating Identifying Codes

Florent Foucaud, Tuomo Lehtilä

► **To cite this version:**

Florent Foucaud, Tuomo Lehtilä. Bounds and Extremal Graphs for Total Dominating Identifying Codes. *The Electronic Journal of Combinatorics*, 2023, 30 (3), 10.37236/11342 . hal-04173548

HAL Id: hal-04173548

<https://hal.science/hal-04173548v1>

Submitted on 29 Jul 2023

HAL is a multi-disciplinary open access archive for the deposit and dissemination of scientific research documents, whether they are published or not. The documents may come from teaching and research institutions in France or abroad, or from public or private research centers.

L'archive ouverte pluridisciplinaire **HAL**, est destinée au dépôt et à la diffusion de documents scientifiques de niveau recherche, publiés ou non, émanant des établissements d'enseignement et de recherche français ou étrangers, des laboratoires publics ou privés.

Bounds and Extremal Graphs for Total Dominating Identifying Codes

Florent Foucaud^a

Tuomo Lehtilä^{b,c}

Submitted: Jun 19, 2022; Accepted: Jul 2, 2023; Published: Jul 28, 2023

© The authors. Released under the CC BY-ND license (International 4.0).

Abstract

An identifying code C of a graph G is a dominating set of G such that any two distinct vertices of G have distinct closed neighbourhoods within C . The smallest size of an identifying code of G is denoted $\gamma^{\text{ID}}(G)$. When every vertex of G also has a neighbour in C , it is said to be a total dominating identifying code of G , and the smallest size of a total dominating identifying code of G is denoted by $\gamma_t^{\text{ID}}(G)$.

Extending similar characterizations for identifying codes from the literature, we characterize those graphs G of order n with $\gamma_t^{\text{ID}}(G) = n$ (the only such connected graph is P_3) and $\gamma_t^{\text{ID}}(G) = n - 1$ (such graphs either satisfy $\gamma^{\text{ID}}(G) = n - 1$ or are built from certain such graphs by adding a set of universal vertices, to each of which a private leaf is attached).

Then, using bounds from the literature, we remark that any (open and closed) twin-free tree of order n has a total dominating identifying code of size at most $\frac{3n}{4}$. This bound is tight, and we characterize the trees reaching it. Moreover, by a new proof, we show that this upper bound actually holds for the larger class of all twin-free graphs of girth at least 5. The cycle C_8 also attains the upper bound. We also provide a generalized bound for all graphs of girth at least 5 (possibly with twins).

Finally, we relate $\gamma_t^{\text{ID}}(G)$ to the similar parameter $\gamma^{\text{ID}}(G)$ as well as to the location-domination number of G and its variants, providing bounds that are either tight or almost tight.

Mathematics Subject Classifications: 05C69

Keywords: Identifying codes; total dominating sets; extremal problem; upper bound

^aUniversité Clermont Auvergne, CNRS, Clermont Auvergne INP, Mines Saint-Étienne, LIMOS, 63000 Clermont-Ferrand, France (florent.foucaud@uca.fr).

^bDepartment of Mathematics and Statistics, University of Turku, Finland (tualeh@utu.fi).

^cUniv Lyon, Université Claude Bernard, CNRS, LIRIS - UMR 5205, F-69622, France

1 Introduction

An identifying code of a graph is a dominating set that allows distinguishing all pairs of vertices by means of their neighbourhoods within the identifying code. This extensively studied concept is related to other similar notions that deal with domination-based identification of the vertices/edges of a graph or hypergraph, such as locating-dominating sets [39], separating systems [2, 3], discriminating codes [7], or test covers [29]. This class of problems has applications in fault-detection in networks [27, 40], biological diagnosis [29] and machine learning [4], to name a few. A total dominating set is a set D of vertices such that every vertex has a neighbour in D . The concept of a total dominating set is perhaps the most studied alternative variant in the field of graph domination, see the dedicated book [22] on this topic.

In this paper, we study total dominating identifying codes, that are sets of vertices that are both identifying codes and total dominating sets. Our focus is on upper bounds and extremal graphs for the smallest size of such a set, as well as bounds involving other related concepts.

Notations and definitions. In this paper, we consider finite undirected graphs. We first define some basic notations. A vertex $u \in V(G)$ is said to be a *leaf*, if it has degree exactly 1. A vertex $v \in V(G)$ is said to be a *support vertex* if it has an adjacent leaf. We denote by $L(G)$ the set of leaves and by $S(G)$ the set of support vertices in graph G . Moreover, we denote the number of leaves and support vertices by $\ell(G) = |L(G)|$ and $s(G) = |S(G)|$, respectively. The *girth* of a graph is the smallest length of one of its cycles.

We denote by $N(v) \subseteq V(G)$ the *open neighbourhood* of vertex v and by $N[v] = N(v) \cup \{v\}$, its *closed neighbourhood*. If C is a set of vertices, or a *code*, and v , a vertex, we denote the intersection between $N[v]$ and code C by the *I-set* of v , $I(v) = N[v] \cap C$. *Identifying codes* were defined over twenty years ago in [27] by Karpovsky et al. and since then they (and related concepts) have been studied in a large number of articles, see [28] for an online bibliography. A set $C \subseteq V(G)$ is called a *separating code* of G if for each pair of distinct vertices $u, v \in V(G)$, their *I-sets* are distinct, that is,

$$I(u) \neq I(v).$$

An *identifying code* of G is a set of vertices that covers every vertex v , that is, $I(v) \neq \emptyset$, and is a separating code. (Note that every separating code is “almost” an identifying code, as at most one vertex may remain uncovered by the separating code.) A *total dominating identifying code* is a separating code that is also a total dominating set, that is, every vertex of the graph has a neighbour in the code. Any total dominating identifying code is also an identifying code.

The vertices of a code are called *codewords*. A codeword x is said to *separate* two vertices if it belongs to the closed neighbourhood of exactly one of them. We also say that the codeword x separates vertex u from vertex v or vice versa meaning that codeword x separates these two vertices. (We sometimes use *distinguish* as a synonym of separate.)

Two vertices are *open twins* if their open neighbourhoods are the same, and *closed twins* if their closed neighbourhoods are the same. A graph admits a separating code if and only if it has no pairs of closed twins [27]; in that case we say the graph is *identifiable*. We say that a graph is *twin-free* if it contains neither open nor closed twins. Twins are important for (total dominating) identifying codes, indeed closed twins cannot be separated, and for any set of mutually open twins, at most one can be absent from any separating code. A graph admits a total dominating set if and only if its minimum degree is at least 1. For an identifiable graph G , we denote by $\gamma^{\text{ID}}(G)$ the smallest size of an identifying code of G . In the context of total dominating identifying codes, by saying a graph is *identifiable* we also assume implicitly that it admits a total dominating set. For such an identifiable graph G , we denote by $\gamma_t^{\text{ID}}(G)$ the smallest size of a total dominating identifying code of G . Total dominating identifying codes have been studied only in a handful of papers, see [8, 21, 30, 31, 32, 33, 35].

Identifying codes have sometimes been called *differentiating-dominating sets* in the literature, see for example [18]. Total dominating identifying codes have been called *differentiating-total dominating sets*, however due to the now standard term of “identifying code” we believe, it is a better choice to call them *total dominating identifying codes*, thus we do so in this paper.

Further related concepts. Besides identifying and total dominating identifying codes, quite many other related concepts have been studied. We present the relationships between some of these different types of dominating and locating codes in connected graphs in Figure 1. As one can see on the figure, total dominating identifying codes are directly related to several important concepts in the area.

A set C is *locating-dominating* if we have $I(u) \neq I(v)$ for each distinct $u, v \notin C$ [39]. Furthermore, set C is *locating-total dominating* if it is locating-dominating and total dominating [21]. A code is *self-identifying* if for any distinct u, v we have $I(u) \setminus I(v) \neq \emptyset$ [26]. Self-identifying codes have also been studied as $(1, \leq 1)^+$ -*identifying codes* [23]. Denote by $I(X) = \bigcup_{u \in X} I(u)$ where X is a set of vertices. Code C is a $(1, \leq 4)$ -*identifying code* if for any distinct sets X, Y with $|X|, |Y| \leq 4$ we have $I(X) \neq I(Y)$ [23, 27]. Moreover, code C is an *error-correcting identifying code* if $|I(u)| \geq 3$ for each vertex u and $|I(u) \Delta I(v)| \geq 3$ for any distinct vertices v and u [25, 36]. Finally, set C is an *open (neighbourhood) locating-dominating* if we have $N(v) \cap C \neq \emptyset$ for each vertex v and for each distinct pair of vertices u, v , we have $N(v) \cap C \neq N(u) \cap C$ [24, 37].

Each arc in Figure 1 follows trivially from the above definitions, with the possible exception of the arc from SID to TID and the arcs adjacent to OLD. Assume that C is a self-identifying code in graph G which also admits a total dominating identifying code. If for any $c \in C$ we have $I(c) = \{c\}$ and $u \in N(c)$, then $I(c) \subseteq I(u)$, a contradiction. Thus, C is total dominating and it is identifying by definition. Then, consider the arc from OLD to TLD. Let C be an open locating-dominating set in G . Then, $N(v) \cap C \neq \emptyset$ and thus, C is total dominating. Moreover, we have $I(v) \neq I(u)$ for each pair of distinct pair of non-codewords u and v . Then, consider the arc from EID to OLD. Let C be an error-correcting-identifying code in connected graph G . If $I(v) = \{v\}$ and $u \in N(v)$, then

$I(u) = I(\{u, v\})$. Thus, C is total dominating. Moreover, if $N(u) \cap C = N(v) \cap C$, then $I(u) \Delta I(v) \subseteq \{v, u\}$, a contradiction.

The cardinality of an optimal locating-dominating sets in graph G is denoted by $\gamma^L(G)$. Similarly, we use $\gamma_t^L(G)$ for locating-total dominating sets, $\gamma^{OL}(G)$ for open-locating-dominating sets, $\gamma_E^{ID}(G)$ for error-correcting identifying codes and $\gamma_S^{ID}(G)$ for self-identifying codes.

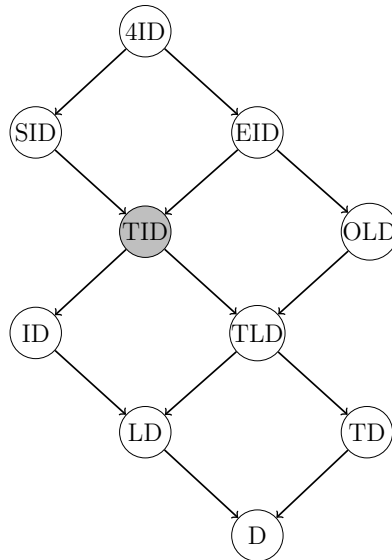

Figure 1: Relations between some types of dominating sets in connected graphs. An arrow from X to Y denotes that each code of type X in a graph is also a code of type Y (when that graph admits codes of both types). The gray node corresponds to total dominating identifying codes, the main focus of the paper. D stands for dominating set, TD stands for total dominating set, LD stands for locating-dominating set, TLD stands for locating-total dominating set, OLD stands for open-locating-dominating set, ID stands for identifying code, TID stands for total dominating identifying code, EID stands for error-correcting identifying code, SID stands for self-identifying code and $4ID$ stands for $(1, \leq 4)$ -identifying code.

The computational problem associated with determining $\gamma_t^{ID}(G)$ for an input graph G is NP-hard, and has been studied in [33]. Lower and upper bounds for parameter γ_t^{ID} in trees have been proved in [8, 21, 30, 35]. Different graph classes, in particular graph products, were studied in [31, 32].

Our results. Our main result is to characterize those graphs G of order n for which $\gamma_t^{ID}(G) \geq n - 1$. We show that the only connected graph G with $\gamma_t^{ID}(G) = n$ is the 3-vertex path P_3 . The graphs G for which $\gamma_t^{ID}(G) = n - 1$ form a rich graph class. This class of graphs includes those graphs for which $\gamma^{ID}(G) = n - 1$, characterized in [12] as essentially (1) stars, (2) the complements of half-graphs, and (3) graphs built from any number of graphs from (2) using complete join operations and potentially, the addition of a single

universal vertex. We show that besides these examples, one can obtain a graph G with $\gamma_t^{\text{ID}}(G) \geq n - 1$ from a graph from (2) or (3) or the empty graph, by completely joining it to a copy of K_m (for any integer $m \geq 1$), and add a private leaf to each vertex of K_m . We then show that these cases are essentially the only possibilities to obtain an extremal graph for parameter γ_t^{ID} .

All the graphs in the above constructions either have many twins, or have (many) short cycles. We show that in the absence of these two obstructions, one can obtain an upper bound on γ_t^{ID} significantly smaller than n . Indeed, we first notice that two bounds from the literature imply that every twin-free tree T of order n satisfies $\gamma_t^{\text{ID}}(T) \leq 3n/4$, and by a new proof, we generalize this upper bound to all identifiable graphs of girth at least 5. The bound is shown to be tight for certain trees, and for the cycle C_8 .

Finally, we study the ratio between parameter γ_t^{ID} and related parameters; natural lower bounds for $\gamma_t^{\text{ID}}(G)$ are $\gamma^{\text{L}}(G)$, $\gamma_t^{\text{L}}(G)$ and $\gamma^{\text{ID}}(G)$, as we can see from Figure 1. We show that for any identifiable graph G , $\gamma_t^{\text{ID}}(G) \leq 2\gamma^{\text{ID}}(G) - 2$ and $\gamma_t^{\text{ID}}(G) \leq 2\gamma_t^{\text{L}}(G)$ (both bounds are tight). Interestingly, we can show that $\gamma_t^{\text{ID}}(G) \leq 3\gamma^{\text{L}}(G) - \log_2(\gamma^{\text{L}}(G) + 1)$, and we show the bound is nearly tight, as there are infinitely many connected graphs G for which $\gamma_t^{\text{ID}}(G) = 3\gamma^{\text{L}}(G) - 2\log_2(\gamma^{\text{L}}(G) + 1)$. Moreover, we also show that without restricting the class of graphs, neither $\gamma_S^{\text{ID}}(G)$ nor $\gamma_E^{\text{ID}}(G)$ gives a useful upper bound for $\gamma_t^{\text{ID}}(G)$. In other words, there are graphs for which $\gamma_t^{\text{ID}}(G)$ is much smaller than either of $\gamma_S^{\text{ID}}(G)$ or $\gamma_E^{\text{ID}}(G)$.

We present our characterization of extremal graphs in Section 2. The bound for twin-free graphs of girth at least 5 is presented in Section 3. The bounds relating γ_t^{ID} to related parameters are presented in Section 4. We conclude in Section 5.

Further related work. Our results were inspired by the related work below.

Characterizations of extremal graphs for identifying codes and related parameters were studied in several papers, for example for locating-dominating sets [5, 6], for identifying codes [6, 12], for open neighbourhood locating-dominating sets [11], and for discriminating codes [7].

Bounds for twin-free graphs have been studied for related graph parameters. It was proved in [15] that for every twin-free bipartite graph G of order n , $\gamma^{\text{ID}}(G) \leq 2n/3$, and the bound is tight exactly for 2-coronas of bipartite graphs (that is, bipartite graphs B for which a private copy of P_2 is attached to each vertex of B by one of the ends of P_2). It was proved in [17] that every twin-free bipartite graph and every twin-free graph with no 4-cycles has a locating-dominating set of size at most $n/2$; the bound is tight for infinitely many trees, which are characterized in [14]. In [13], it was proved that every twin-free graph with no 4-cycle has a locating-total dominating set of size at most $2n/3$. It is conjectured that these two bounds hold for all twin-free graphs [13, 17].

Bounds for graphs of girth at least 5 were given for identifying codes in [1, 15, 16]. In particular, generalizing a result from [1], it is shown in [15] that for every graph G of order n and girth at least 5, we have $\gamma^{\text{ID}}(G) \leq \frac{5n+2\ell(G)}{7}$, a bound which is tight.

Relations between identification-type graph parameters were provided in [20] (locating-dominating sets and identifying codes) and [38] (locating-dominating sets, identifying

codes, and open-locating-dominating sets). It is shown that for every graph G , any two of these parameters' values cannot be more than a factor 2 apart from each other. Such bounds do not seem to be known for total dominating identifying codes, however, in [32, Theorem 2.3], infinitely many graphs G satisfying $\gamma_t^{\text{ID}}(G) = \frac{3}{2}\gamma^{\text{ID}}(G)$ are constructed.

2 Characterizing graphs with largest possible total dominating identifying codes

In this section, we characterize the graphs which attain extremal values for total dominating identifying codes.

2.1 Preliminaries

One can easily check that no graph of order at most 2 admits a total dominating identifying code, since P_1 has no total dominating set and P_2 is not identifiable. We start by showing that P_3 is the only connected identifiable graph of order n whose smallest total dominating identifying code has size n .

Proposition 1. *If G is a connected identifiable graph of order n (thus $n \geq 3$), then we have $\gamma_t^{\text{ID}}(G) \leq n - 1$, unless G is P_3 (and $\gamma_t^{\text{ID}}(P_3) = 3$).*

Proof. Since P_3 is the only identifiable graph of order at most 3 admitting a total dominating set and $\gamma_t^{\text{ID}}(P_3) = 3$, we may assume $n \geq 4$. It is known that for any identifiable graph G with at least one edge, there is always a vertex x such that $V(G) \setminus \{x\}$ is an identifying code of G , see [19]. Moreover, $V(G) \setminus \{x\}$ is a total dominating set, unless x is a support vertex. Thus, if there are no support vertices in G , we are done. Otherwise, let x be a support vertex of G and let y be a leaf neighbour of x . Since $V(G) \setminus \{y\}$ is a total dominating set, if $V(G) \setminus \{y\}$ is also an identifying code, then we are done. Otherwise, there must exist two vertices u, v of G that can only be distinguished by y , that is, such that $N[u] = N[v] \cup \{y\}$. If $y \in \{u, v\}$, then $y = u$ and $v = x$, but this is not possible since y separates u and v , a contradiction. Hence, u is a neighbour of y , that is, $u = x$. Since $n \geq 4$, u and v have a common neighbour, say w . As v is not a support vertex, the set $V(G) \setminus \{v\}$ is a total dominating set. We claim that it is also an identifying code of G , which would prove the claim. Indeed, any pair s, t of vertices with $y \notin \{s, t\}$ such that v separates s from t , is also separated by u , and y is separated from x by w (and from every other vertex by itself). \square

The authors of [21] characterized the trees T of order $n \geq 4$ with $\gamma_t^{\text{ID}}(T) = n - 1$ to be exactly the set of stars, and P_4 . The set of graphs G of order $n \geq 4$ with $\gamma_t^{\text{ID}}(G) = n - 1$ necessarily contains all those graphs without isolated vertices for which $\gamma^{\text{ID}}(G) = n - 1$ (except P_3). The graphs G of order n with $\gamma^{\text{ID}}(G) = n - 1$ were characterized in [12], based on the following graph families.

Definition 2 ([12]). For any non-negative integer k , we define the graph A_k of order $2k$ as the graph on vertex set $\{x_1, \dots, x_{2k}\}$ where x_i is adjacent to x_j if and only if $|i - j| \leq k - 1$.

We denote by \mathcal{A} the set of graphs obtained by taking any number (possibly, zero) of disjoint copies of graphs in the family $\{A_k \mid k \geq 1\}$ and joining every pair of these graphs by all possible edges between them. We denote by \mathcal{A}^* the set \mathcal{A} without the graphs A_0 and A_1 .

For two graphs G and H , we denote by $G \bowtie H$ the *complete join* of G and H , that is, the graph obtained from a copy of G and a copy of H by adding all possible edges between the two copies. For a set \mathcal{C} of graphs, we denote by $\mathcal{C} \bowtie K_1$ the set of graphs $\{G \bowtie K_1 \mid G \in \mathcal{C}\}$.

Note that A_0 is the empty graph, A_1 is the edgeless graph of order 2, and A_2 is the 4-vertex path. For $k \geq 2$, the graph A_k is isomorphic to the $(k - 1)$ -th power of the path P_{2k} and can be partitioned into two cliques, as shown in Figure 2. In fact A_k is the complement of the *half-graph* of order $2k$ (half-graphs form a family of special bipartite graphs defined by Erdős and Hajnal, see [9]).

An example of a graph in \mathcal{A} is provided in Figure 3. As a special case, the set \mathcal{A} contains all even-order complete graphs minus a maximum matching (by considering only copies of A_1 in the construction), and by the addition of a universal vertex, $\mathcal{A} \bowtie K_1$ contains all odd-order complete graphs minus a maximum matching.

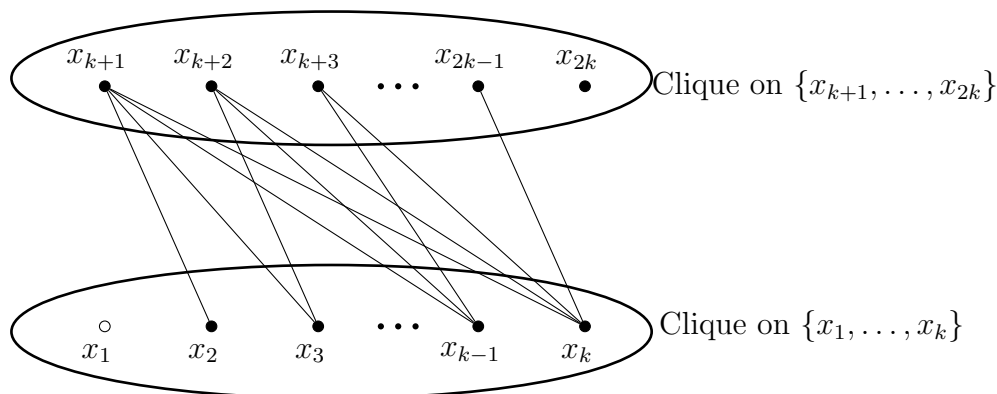

Figure 2: The graph A_k of order $n = 2k$ has total dominating identifying code number $n - 1$ (the black vertices form an optimal total dominating identifying code).

For completeness, we give a proof for the following result from [12], initially stated for usual identifying codes but which also holds for total dominating identifying codes.

Proposition 3 ([12]). *For every graph G of order n in $\mathcal{A}^* \cup (\mathcal{A}^* \bowtie K_1)$, every separating code has size at least $n - 1$, and $\gamma_t^{ID}(G) = n - 1$. Moreover, if $G \in \mathcal{A}^* \bowtie K_1$, then the only separating code is $V(G)$ minus the unique universal vertex.*

Proof. First, assume that $k \geq 2$, we show that $\gamma_t^{ID}(A_k) = 2k - 1$. For every i with $1 \leq i \leq k - 1$, x_{k+i} is the only vertex separating x_i from x_{i+1} and similarly, x_{k-i+1} is the only vertex separating x_{2k-i} and x_{2k-i+1} ; thus, all of x_2, \dots, x_{2k-1} must belong to any separating code of A_k . Finally, x_k and x_{k+1} can only be separated by one of x_1 and x_{2k} .

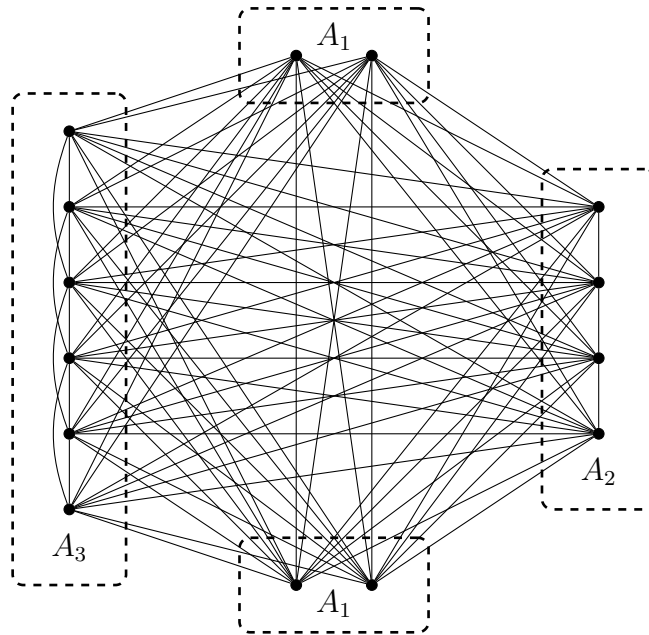

Figure 3: A graph in \mathcal{A}^* built from two copies of A_1 and from one copy of each of A_2 and A_3 .

Thus, any separating code has size at least $2k - 1 = n - 1$, and so $\gamma_t^{\text{ID}}(G) \geq n - 1$. The set $V(A_k) \setminus \{x_1\}$ is a total dominating identifying code of size $n - 1$.

Now, consider any graph in \mathcal{A}^* and number the $\ell \geq 1$ copies of graphs in $\{A_k \mid k \geq 1\}$ as $A_{i_1}^1, \dots, A_{i_\ell}^\ell$ where $A_{i_s}^s$ is a copy of A_{i_s} whose vertices are labeled $x_1^s, \dots, x_{2i_s}^s$. Consider any copy A_t^s (where $t = i_s$) of A_t from the construction of G . If $t \geq 2$, by the same arguments as above, we see that all the vertices x_2^s, \dots, x_{2t-1}^s from A_t^s must belong to any separating code of G (since all vertices of A_t^s have the same neighbourhoods outside of A_t^s), and at least one of x_1^s and x_{2t}^s in A_t^s must belong to the code in order to separate x_t^s from x_{t+1}^s . If $t = 1$, one of x_1^s and x_2^s necessarily belongs to the code since these two vertices are open twins in G . Without loss of generality, by the symmetries of x_1^s and x_{2t}^s , we assume that x_1^s belongs to the code, and we also assume that x_1^s belongs to the code for each copy $A_{i_s}^s$ in G ($1 \leq s \leq \ell$). Now, for any pair of copies $A_{i_s}^s$ and $A_{i_t}^t$ in G , notice that $x_{i_s}^s$ and $x_{i_t}^t$ can only be separated by one of $x_{2i_s}^s$ and $x_{2i_t}^t$. Hence, at most one vertex of type $x_{2i_j}^j$ in some $A_{i_j}^j$ can be omitted from any separating code, and so any separating code has size $n - 1$. Note that $V(G) \setminus \{x_{2i_j}^j\}$ is a total dominating identifying code of size $n - 1$.

Assume now that $G \in \mathcal{A}^* \bowtie K_1$ and let u be the universal vertex from the copy of K_1 in G . We use the same reasoning, to show that all vertices except possibly u and some $x_{2i_j}^j$ must belong to the separating code. However, to separate u from $x_{i_j}^j$, we must also include vertex $x_{2i_j}^j$, and so again any separating code has size at least $n - 1$, and $\gamma_t^{\text{ID}}(G) \geq n - 1$. Moreover, $V(G) \setminus \{u\}$ is a total dominating identifying code of size $n - 1$. \square

The following characterization was proved in [12].

Theorem 4 ([12]). *If G is a connected identifiable graph on n vertices, then $\gamma^{\text{ID}}(G) = n - 1$ if and only if $G \in \{K_{1,t} \mid t \geq 2\} \cup \mathcal{A}^* \cup (\mathcal{A}^* \bowtie K_1)$.*

2.2 The characterization

We next state our characterization theorem, which we will prove after some preliminary lemmas.

Theorem 5. *For any connected graph G on $n \geq 3$ vertices, we have $\gamma_t^{\text{ID}}(G) \geq n - 1$ if and only if either:*

- (i) $\gamma^{\text{ID}}(G) \geq n - 1$, that is $G \in \{K_{1,t} \mid t \geq 2\} \cup \mathcal{A}^* \cup (\mathcal{A}^* \bowtie K_1)$, or
- (ii) $G' = G'' \bowtie K_m$, where $m \geq 1$ and $G'' \in \mathcal{A} \cup (\mathcal{A} \bowtie K_1)$, and G is obtained from G' by attaching a leaf to each vertex in the clique K_m .

Moreover, $\gamma_t^{\text{ID}}(G) = n$ if and only if $G = P_3$.

Next, we prove that the family of graphs described in Theorem 5(ii) (whose members have an identifying code of size less than $n - 1$), indeed is extremal for total dominating identifying codes.

Proposition 6. *If $G' = G'' \bowtie K_m$, where $m \geq 1$ and $G'' \in \mathcal{A} \cup (\mathcal{A} \bowtie K_1)$, and the graph G of order $n \geq 3$ is obtained from G' by attaching a leaf to each vertex in the clique K_m , then $\gamma_t^{\text{ID}}(G) \geq n - 1$.*

Proof. Let G be obtained from G' and G'' as described in the statement (note that possibly, G'' is the empty graph, the graph of order 1, or the edgeless graph of order 2).

Let C be an optimal total dominating identifying code in G . Observe that for it to be total dominating, every vertex in K_m has to be in C . Moreover, to separate vertices in the clique K_m , at least $m - 1$ of the leaves must be in the code. Furthermore, none of the vertices in the clique K_m separate vertices in G'' from each other. Thus, $C \cap V(G'')$ must be a separating code of G'' , but in any separating code of G'' , there is at most one non-codeword by Proposition 3. Thus, we have $|C| \geq n - 2$, and the two vertices not yet fixed to be in C are a leaf and a vertex of G'' that can be omitted from a separating code of G'' .

Assume now that $|C| = n - 2$, w is the non-codeword in G'' and u , which is adjacent to v , is the non-codeword leaf in G . Observe that if $G'' \in \mathcal{A} \bowtie K_1$, then w is the universal vertex in G'' and hence, $I(w) = I(v)$, a contradiction. Moreover, if $G'' \in \mathcal{A} \setminus \{A_0, A_1\}$, then the non-codeword corresponds to a vertex of type x_1 or x_{2i_j} in some subgraph A_{i_j} , say, x_1 . However, now $I(x_{2i_j-1}) = I(v)$, again a contradiction. Therefore, C has cardinality $n - 1$. By the same arguments, when $|V(G'')| \leq 2$, we also have $\gamma_t^{\text{ID}}(G) \geq n - 1$. \square

Some example graphs G of order n for which $\gamma_t^{\text{ID}}(G) = n - 1$ but $\gamma^{\text{ID}}(G) < n - 1$ are depicted in Figure 4.

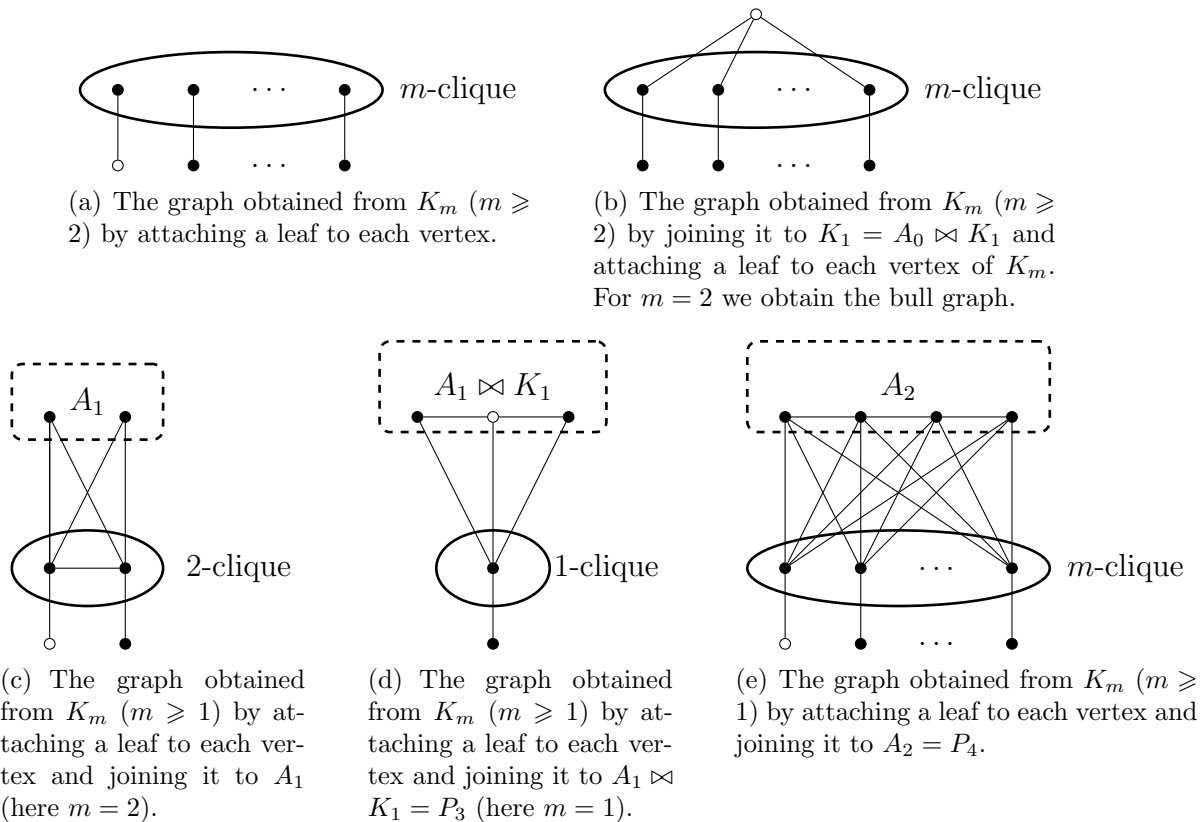

Figure 4: Some examples of graphs of order n with total dominating identifying code number $n - 1$ but a smaller identifying code. Black vertices form a minimum total dominating identifying code.

2.3 The proof

In the following lemma, we show that the extremal graphs are exactly the same for identification and total dominating identification, when the graphs do not contain any leaves.

Lemma 7. *If G be a connected identifiable graph with minimum degree $\delta(G) \geq 2$ on $n \geq 4$ vertices, then $\gamma_t^{ID}(G) = n - 1$ if and only if $\gamma^{ID}(G) = n - 1$.*

Proof. Let G be a connected graph with minimum degree $\delta(G) \geq 2$ on $n \geq 4$ vertices with $\gamma_t^{ID}(G) = n - 1$. Assume by contradiction that $\gamma^{ID}(G) \leq n - 2$. We may assume that C' is an identifying code of cardinality $n - 2$ in G . We notice that C' cannot be total dominating since $\gamma_t^{ID}(G) = n - 1$. Thus, there exists a vertex $v \in C'$ such that $\deg(v) = 2$ (since G has no degree 1 vertex) and there are two adjacent non-codewords u and u' and these two vertices are the only non-codewords in G . Since $\gamma_t^{ID}(G) = n - 1$, we cannot shift codeword v to any of u or u' and obtain a total dominating identifying code. Since v was not helpful with total domination in C' , there exists a vertex w such that

$N[u] \cup \{u'\} = N[w] \cup \{v, u'\}$ or $N[u'] \cup \{u\} = N[w] \cup \{v, u\}$. Without loss of generality we assume the first case.

Assume first that u and u' are not adjacent. In this case, we may shift the codeword in w to u . Notice that the resulting code is total dominating. Moreover, since u and u' are not adjacent, u and w separate exactly the same set of vertex pairs with the exception of those with v (and possibly u' if w is adjacent to u') in them. Moreover, $I(v)$ is unique since $I(v) = \{u, v\}$, and u' is the only vertex with v in its I -set while not having u in its I -set. Hence, the resulting code is total dominating identifying. Moreover, it is a total dominating identifying code with cardinality of $n - 2$, a contradiction. Hence, we may assume from now on that u and u' are adjacent. If we again do the same shift of codewords, then we notice that we have a total dominating identifying code unless w was the vertex which separated u and u' . That is, $N[u] = N[u'] \cup \{w\}$.

Recall that we could not shift the codeword in v to u' and get an identifying code. Since u' separates w and u , we have a vertex $w' \neq w$ with $N[u] = N[w'] \cup \{v\}$ or $N[u'] = N[w'] \cup \{v\}$. If $N[u] = N[w'] \cup \{v\}$, then $N[w] \cup \{v, u'\} = N[w'] \cup \{v\}$. Hence, u' is the only vertex which can separate w and w' and u' has to be a codeword in any identifying code, a contradiction since C' did not contain it. Hence, we may assume that $N[u'] = N[w'] \cup \{v\}$. However, now we may shift the codeword from w' to u' and get a total dominating identifying code. Hence, we have $\gamma_t^{\text{ID}}(G) = n - 2$, a contradiction, and we have $\gamma^{\text{ID}}(G) = n - 1$.

The other direction is clear. If $\gamma^{\text{ID}}(G) = n - 1$, then $\gamma_t^{\text{ID}}(G) = n - 1$ since G is not P_3 . \square

To exactly characterize the extremal graphs for total dominating identification, we require some lemmas which will later be utilized in the induction.

Lemma 8. *Let G be a connected graph of order $n \geq 5$ other than a star, with a leaf u and an adjacent support vertex v . If $\gamma_t^{\text{ID}}(G) = n - 1$, then $\gamma_t^{\text{ID}}(G - u - v) \geq n - 3$ and $G - u - v$ is identifiable and connected.*

Proof. Let G be a connected graph other than a star with $\gamma_t^{\text{ID}}(G) = n - 1 \geq 4$ with leaf u and adjacent support vertex v . We denote graph $G - u - v$ by G_v . We prove the following facts.

(1) G_v has no components of size 2. Suppose on the contrary that such a component exists in G_v , say, with x, y as its vertices and $x \in N_G(v)$ (thus $y \notin N_G(v)$ since G is identifiable). Now, $V(G) \setminus \{y, u\}$ is a total dominating identifying code of cardinality $n - 2$ in G , a contradiction. Indeed, the code is clearly total dominating and y is the only vertex with $I(y) = \{x\}$, x is the only one with $I(x) = \{v, x\}$ since $n \geq 5$, u the only one with $I(u) = \{v\}$, v is the only other vertex which is adjacent to x and hence is separated from the rest of codewords. Finally, the other vertices will have unique I -sets since G is identifiable.

(2) G_v is connected. Suppose on the contrary that we have several components in G_v . By the above paragraph, none of them has size 2.

Consider the case where each component in G_v has at least three vertices. Notice that if a component, say A , is not identifiable, then $G[A \cup \{v\}]$ is identifiable (and not isomorphic to P_3), by Proposition 1 there is a total dominating identifying code of $G[A \cup \{v\}]$ of cardinality at most $|A|$, and it must contain vertex v . On the other hand, if a component of G_v is identifiable, then again by Proposition 1 it has a total dominating identifying code which does not contain each vertex in that component (unless the component is P_3 , in which case that component together with v has a total dominating identifying code of size 3, with a non-codeword other than v). If we now consider graph G , then, by combining the codes in each component (together with u and v), we find a code which contains at most $n - 2$ codewords. Resulting code is clearly total dominating and each vertex within the components is separated by codewords within those components or by v . Moreover, v and u are separated from every other vertex by u . Hence, we have a total identifying code unless $I(u) = I(v)$. However, if $I(u) = I(v)$ holds, then we can just move the codeword from u to any other vertex adjacent to v . Now u is the only vertex adjacent to only v and each other vertex adjacent to v already had, before the codeword shift, another codeword which is adjacent to it. This leads to a contradiction.

Finally, to show that G is connected, it remains to deal with the case where some component of G_v is a single vertex, that is, v has at least two adjacent leaves. By (1) we know that no component of G_v has size 2. Let $U = \{u, u_1, \dots, u_k\}$, for some $k \geq 1$, be the set of leaves adjacent to v in G . Denote graph $G - U - v$ by G'' . Similarly as above, we can check that G'' is not P_2 or P_3 . Assume first that G'' is not identifiable. Then, $G - U$ is identifiable, has size at least 3 (because G is not a star) and is not isomorphic to P_3 and hence, by Proposition 1, it has a total dominating identifying code C' of size at most $n - |U| - 1$. Moreover, $v \in C'$ since it is the only vertex which separates some pair of closed twins in G'' . However, now C' together with all but one vertex in U is a total dominating identifying code of G of cardinality at most $n - 2$, a contradiction. Hence, we may assume that G'' is identifiable. Moreover, if G'' has a total dominating identifying code C' of size at most $n - |U| - 3$, then $C' \cup U \cup \{v\}$ is a total dominating identifying code of size at most $n - 2$ in G , a contradiction. Thus, $\gamma_t^{\text{ID}}(G'') = n - |U| - 2$ since G'' is not isomorphic to P_3 .

Let C' be a total dominating identifying code of G'' with $|C'| = n - |U| - 2$. Assume first that C' contains a neighbour of v (this is true in particular if $\deg(v) \geq |U| + 2$ in G). Then $C' \cup \{v\}$ together with all the vertices of U but one is a total dominating identifying code of size $n - 2$ in G since v has a codeword neighbour in C' , again a contradiction. Thus, we may assume that $\deg(v) = |U| + 1$ in G (we denote by w the neighbour of v not in U), and $w \notin C'$. Thus, w is not a support vertex. Then, $G'' - w$ is identifiable. If $G'' - w$ is P_3 , then it is easy to check that G has a total dominating identifying code of size at most $n - 2$. Otherwise, if $G'' - w$ is connected, then, by Proposition 1, it satisfies $\gamma_t^{\text{ID}}(G'' - w) \leq n - |U| - 3$. If $G'' - w$ is disconnected, then none of the components is a P_2 (otherwise w would be a codeword in C') and if a component is a P_3 , then each vertex in that P_3 is a codeword in C' . We can now just shift one of the codewords in the P_3 to w in C' and obtain a total dominating identifying code of G'' . (The codeword that can be shifted depends on which edges exist between w and the P_3 -component. At the

beginning of this paragraph we have shown that if v has an adjacent codeword vertex in a total dominating identifying code of G'' of size at most $n - |U| - 2$, then we have a total dominating identifying code of size $n - 2$ in G , a contradiction. Hence, we may assume that we do not have any such P_3 -components in $G'' - w$. Thus, each component in $G'' - w$ has at least four vertices and hence, by Proposition 1, $\gamma_t^{\text{ID}}(G'' - w) \leq n - |U| - 3$. Now, in G , the code $C'' \cup \{v, w\}$ together with all the vertices of U but one, is total dominating identifying with cardinality at most $n - 2$, a contradiction.

Hence we have proved that G_v is connected.

(3) G_v is identifiable. By contradiction, assume G_v has some closed twins. Assume first that G_v has three mutually twin vertices x, y and z such that $N_{G_v}[x] = N_{G_v}[y] = N_{G_v}[z]$. Now, v cannot separate all three of these vertices in G and hence, we have a contradiction.

Assume next that we have at least two disjoint pairs of closed twins, that is, $N_{G_v}[x] = N_{G_v}[y]$ and $N_{G_v}[z] = N_{G_v}[w]$. We may assume that $v \in N_G(x)$ and $v \in N_G(z)$ but $v \notin N_G(y)$ and $v \notin N_G(w)$. Now, $V(G) \setminus \{y, w\}$ is a total dominating identifying code in G . Clearly the code is total dominating. Moreover, v separates x and y as well as z and w . Furthermore, u separates v from other vertices and x separates v from u . Since $N_{G_v}[x] = N_{G_v}[y]$ and $N_{G_v}[z] = N_{G_v}[w]$, adding w or y to the code will not separate any new vertices and since G is identifiable, this code is an identifying code.

Thus, we now assume that there is exactly one pair of closed twins in G_v , that is, $N_{G_v}[x] = N_{G_v}[y]$ where $v \in N_G[x] \setminus N_G[y]$. Notice that by (1), G_v has no components of size 2, hence x and y have a common neighbour, z . Then, consider the graph $G'' = G - \{u, v, x\}$. Notice that G''_v is identifiable since G is identifiable and if $N_{G''}[a] = N_{G''}[b]$ for some vertices a, b , then u cannot separate them in G , v cannot be the only one to separate them in G since there is exactly one pair of closed twins in G_v , and x cannot separate them either since $N_{G_v}[x] = N_{G_v}[y]$. Thus, G'' is identifiable, as claimed.

Notice that if G'' is isomorphic to P_3 , then G is one of four possible graphs (see Figure 5), and in each case one can check that $\gamma_t^{\text{ID}}(G) \leq 4 = n - 2$, a contradiction.

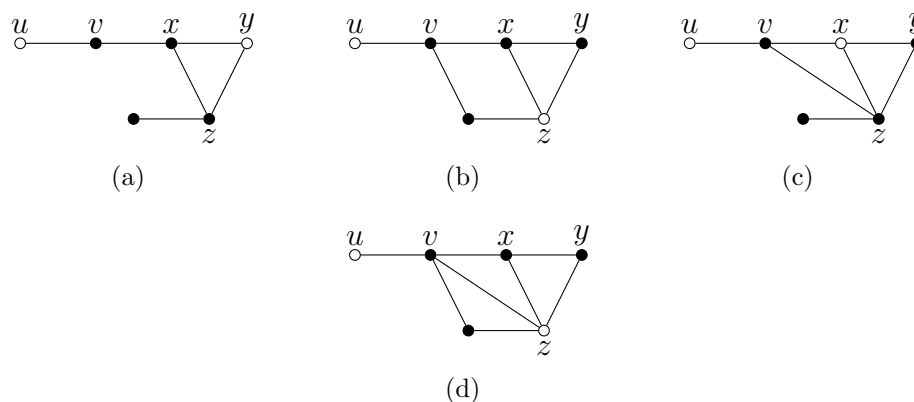

Figure 5: The possibilities for graph G when G'' is isomorphic to P_3 , in part (3) of the proof of Lemma 8. The black vertices form total dominating sets of size $n - 2$.

Hence, by Proposition 1, we have $\gamma_t^{\text{ID}}(G'') \leq n - 4$. Let C'' be an optimal total dominating identifying code of G'' .

Observe first that $|C''| = n - 4$. Indeed, if $|C''| \leq n - 5$, then $C = C'' \cup \{u, v, x\}$ is a total dominating identifying code of G of cardinality at most $n - 2$. Indeed, C is clearly total dominating and v is separated from all vertices except u by u and u is separated from v by x . Moreover, u is the only vertex with $I(u) = \{u, v\}$. Furthermore, if $I(x) = I(a)$ for some vertex a , then $I(a) = I(y) \cup \{v\}$ and a and y are not separated in G'' , a contradiction. Thus, C is total dominating identifying with $n - 2$ codewords since all other vertices are dominated and separated by C' . Hence $|C''| = n - 4$.

Consider the two codes $C_x = C'' \cup \{v, x\}$ and $C_y = C'' \cup \{v, y\}$. C_x is a total dominating set, and C_y is also a total dominating set, except if v has degree 2 in G . Observe that for both codes, $I(u) = \{v\}$ and is unique if $\deg(v) \geq 3$. All vertex pairs in G'' are separated by the vertices in C'' . Moreover, in both codes, if some vertex b of G'' is not separated from x , then this means that $I(b) = I(y) \cup \{v\}$ but then b and y are not separated by C'' in G'' , a contradiction. Thus, in both codes, x is separated from all vertices of G , except possibly v . Hence, for each of the two codes, if v is also separated from all other vertices and has a neighbour in the code, then that code is a total dominating identifying code of size at most $n - 2$, a contradiction, and we are done.

Hence, we assume that neither C_x nor C_y are total dominating identifying codes. Since C_x is total dominating, it is not identifying; hence, by the above discussion, there is some vertex b with $I(v) = I(b)$ in C_x . Thus, b is dominated by v and x (possibly, $b = x$): b must be a neighbour of y . Then, $y \notin C''$, for otherwise, b and v would be separated by y in C_x , a contradiction. Thus, we have $N[v] \Delta N[b] = \{u, y\}$. If $b = x$, then C_y is a total dominating identifying code, indeed x, y have at least one common neighbour in C'' , which is a neighbour of v , so C_y is total dominating. Moreover, all neighbours of v except u are neighbours of y , so v is also separated from all other vertices either by v or by y . Therefore, we have $b \neq x$. Hence, $\deg_G(v) \geq 3$ and C_y is total dominating. Thus, C_y is not identifying, that is, there is a vertex c with $I(c) = I(v)$ in C_y . Hence, c is not adjacent to y (hence, not to x) and is adjacent to b , and $N[c] \Delta N[v] = \{u, x\}$. It follows that $N[b] \Delta N[c] = \{x, y\}$, however that is a contradiction, since $N_G[x] = N_G[y] \cup \{v\}$.

Thus, we have shown that G_v is identifiable.

(4) $\gamma_t^{\text{ID}}(G_v) \geq n - 3$. Suppose on the contrary that there exists a total dominating identifying code C' with cardinality $n - 4$ in G_v . Consider code $C = C' \cup \{u, v\}$ in G . It is clearly total dominating and has cardinality of $n - 2$. Moreover, u separates itself and v from all other vertices. Hence, we are done unless $I(v) = I(u) = \{v, u\}$, thus, assume that $N(v) \cap C' = \emptyset$. Since G is connected, v has at least one neighbour, w , other than u . Let us instead consider code $C_w = C \cup \{w, v\}$. Again, the code is clearly total dominating. Moreover, u is the only vertex with $I(u) = \{v\}$ since C' is total dominating in G_v . Furthermore, $I(v) = \{v, w\}$ and if $I(a) = \{v, w\}$ for some vertex a , then a is not dominated by C' in G_v , a contradiction. Thus, we found a total dominating identifying code of cardinality $n - 2$ in G , a contradiction. \square

In the following lemma, we find the set of graphs of order n which have (usual)

identifying code number $n - 1$ and to which we may add a leaf and a support vertex so that the resulting graph has total dominating identifying code number $n' - 1 = n + 1$, but larger than the usual identifying code number. Small stars are special cases for the lemma that are excluded. In particular, star $K_{1,3}$ can actually be constructed from $A_1 \in \mathcal{A}$ by adding a universal vertex v and a leaf u to v . The star $K_{1,2}$ is isomorphic to P_3 and the bull graph (illustrated in Figure 6(d)) can be constructed from it by adding a non-universal support vertex. However, the bull graph can also be constructed from K_1 by joining it to a copy of K_2 and adding leaves to the two newly added vertices.

Lemma 9. *Let G be a connected graph on $n \geq 3$ vertices with support vertex v and an adjacent leaf u and $G' = G - u - v \neq K_{1,p}$ with $p \leq 3$. If $\gamma_t^{\text{ID}}(G) = n - 1$ and $\gamma^{\text{ID}}(G') = n - 3$, then $G' \in \mathcal{A}^* \cup (\mathcal{A}^* \bowtie K_1)$ and v is a universal vertex in G .*

Proof. Since $|V(G')| = n - 2$ and $\gamma^{\text{ID}}(G') = n - 3$, we have $G' \in \{K_{1,t} \mid t \geq 2\} \cup \mathcal{A}^* \cup (\mathcal{A}^* \bowtie K_1)$ by Theorem 4. Based on this, we distinguish several cases. Notice that we have $n \geq 5$.

Case 1: G' is $A_k \in \mathcal{A}$. Assume by contradiction that v is not a universal vertex in G . By Lemma 8, G' must be connected, hence we have $k \geq 2$. Moreover, assume that i is the smallest integer for which $x_i \notin N(v)$ and $x_{i-1} \in N(v)$. If $x_1 \notin N(v)$, then let i be the smallest integer for which $x_i \notin N(v)$ and $x_{i+1} \in N(v)$. Moreover, assume that v does not separate the two maximum cliques in A_k , that is, we do not have $N(v) \cap V(A_k) = \{x_1, \dots, x_k\}$ or $N(v) \cap V(A_k) = \{x_{k+1}, \dots, x_{2k}\}$. Assume now that $i \leq k$ and $x_{i-1} \in N(v)$. Thus, v separates x_i and x_{i-1} . Consider code $C = \{v, u\} \cup V(A_k) \setminus \{x_{2k}, x_{i+k-1}\}$. Code C is clearly a total dominating set and it has $n - 2$ vertices. Moreover, $V(A_k) \setminus \{x_{2k}\}$ is an identifying code in A_k and codeword x_{i+k-1} is used to separate vertices x_i and x_{i-1} from each other. Furthermore, each vertex x_j , $2 \leq j \leq 2k$, $j \neq i, i - 1$, is identified in the same way as in A_k , and vertices x_i and x_{i-1} are separated by v . Finally, since v and u are the only vertices with u in their I -sets, they have unique I -sets. The case where $x_1 \notin N(v)$ is similar with the exception that we have x_1 as the non-codeword instead of x_{2k} . Now, we are left with the case where $N(v) \cap V(A_k) = \{x_1, \dots, x_k\}$ or $N(v) \cap V(A_k) = \{x_{k+1}, \dots, x_{2k}\}$. These two cases are symmetric, thus without loss of generality, we may assume that the first one holds. Consider the code $C = \{v, u\} \cup V(A_k) \setminus \{x_1, x_{2k}\}$. Recall that $V(A_k) \setminus \{x_1\}$ is an identifying code in A_k . Moreover, the only identical I -sets with the code $V(A_k) \setminus \{x_1, x_{2k}\}$ in A_k are $I(x_k)$ and $I(x_{k+1})$. However, in G , the codeword v separates these two vertices. Thus, C is a total dominating identifying code in G .

Thus, v is a universal vertex, as claimed.

Case 2: $G' \in \mathcal{A}$ but G' is not any graph A_i . Assume that v is not a universal vertex in G . Recall that G' is constructed with a sequence of joins of graphs A_{i_j} . Notice that if there exists a subgraph A_{i_j} of G' such that v is adjacent to some but not all of the vertices of that subgraph, then we can find a new non-codeword as in Case 1 if $i_j \geq 2$. When $i_j = 1$, $\deg_G(v) \geq 3$ and v separates vertices in A_{i_j} , we can proceed as in Case 1, that is, have both vertices of A_{i_j} as non-codewords. When $i_j = 1$ and $N(v) = \{u, x_1\}$ where $x_1 \in V(A_{i_j})$, we can consider total dominating identifying code $V(G) \setminus \{u, x_2\}$ where $x_2 \neq x_1$ is the other vertex of A_{i_j} .

Moreover, if, for each j , every vertex in subgraph A_{i_j} is either adjacent or non-adjacent to v and, say, $V(A_{i_1}) \subseteq N(v)$ and $V(A_{i_2}) \cap N(v) = \emptyset$, then we may choose as the two non-codewords the vertices corresponding to x_1 in each of the subgraphs A_{i_1} and A_{i_2} . Without v , we could not do this since nothing would separate vertices x_{i_1+1} and x_{i_2+1} in the corresponding subgraphs, but now v separates them. Hence, we can construct a total dominating identifying code of size at most $n - 2$, a contradiction, and v is universal.

Case 3: $G' \in \mathcal{A} \bowtie K_1$. Notice that $A_1 \bowtie K_1$ is $K_{1,2}$ and hence, by our assumptions, we do not have to consider it. Hence, $|V(G')| \geq 5$. Denote by y the universal vertex of G' . Recall (see Proposition 3) that the only minimum identifying code in G' consists of every vertex except y . Assume first that there does not exist any vertex $z \in V(G')$ with $N[v] = N[z] \cup \{u\}$. Then we may consider code $C = V(G) \setminus \{u, y\}$. Code C is total dominating since $G' \neq A_1 \bowtie K_1$ and $|V(G')| \geq 5$. Moreover, all vertices in G' have pairwise distinct I -sets since $C \setminus \{v\}$ is a total dominating identifying code in G' . Furthermore, u is the only vertex with $I(u) = \{v\}$ while v is separated from other vertices since it has a unique closed neighbourhood.

Assume then that there exists a vertex $z \in V(G')$ with $N[v] = N[z] \cup \{u\}$ and $z \neq y$. Now, we consider code $C = V(G) \setminus \{z, y\}$. Again, code C is a total dominating set since $V(G') \setminus \{y\}$ is total dominating in G' and v is adjacent to any vertex which would be dominated by z . Moreover, $V(G') \setminus \{y\}$ is an identifying code in graph G' . Codeword u separates u and v from other vertices in G and $|I(v)| > |I(u)|$. Since $N[v] = N[z] \cup \{u\}$, any vertices that would be separated by z in G' by code $V(G') \setminus \{y\}$ are now separated by v . Hence, C is a total dominating identifying code in G of cardinality $n - 2$ and v is universal.

Case 4: $G' \in \{K_{1,t} \mid t \geq 2\}$. We first show that G' has exactly two leaves. Consider on the contrary that $G' = K_{1,t}$. By our assumption that G' is not $K_{1,p}$ for $p \leq 3$, we have $t \geq 4$. Denote by w the central vertex of G' and by $\{w_1, \dots, w_t\} = L(G')$ the t leaves of G' . Observe first that if v is adjacent to at most $t - 2$ leaves of G' , then the graph $G - w - w_1$, where $w_1 \notin N_G(v)$, is disconnected and hence, by Lemma 8, $\gamma_t^{\text{ID}}(G) < n - 1$, a contradiction. Then, consider the case where v is adjacent to $t - 1$ leaves w_2, \dots, w_t (possibly, v is adjacent to w as well). We choose $C = V(G) \setminus \{w_2, u\}$, and show it is a total dominating identifying code of cardinality $n - 2$. Observe that it is clearly total dominating. Moreover, C is identifying since w_1 separates w_1 and w from other vertices and $|I(w)| > |I(w_1)|$, u is the only vertex with $I(u) = \{v\}$, v is adjacent to multiple codewords in $L(G')$ and hence separated from the leaves in $L(G')$ and each codeword in $L(G')$ is separated by itself from all other leaves. Thus, C is identifying, a contradiction.

Assume then that v is adjacent to each leaf in G' (possibly, v is adjacent to w). Now we choose $C = V(G) \setminus \{w, w_1\}$. Again, code C is clearly total dominating and has cardinality of $n - 2$. Moreover, it is identifying. Indeed, u and v are separated from other vertices by u and $|I(v)| > |I(u)|$, w is clearly separated from the leaves of G' , $I(w_1) = \{v\}$ and is unique, and each leaf codeword is separated from the other leaves by itself. Hence, the claim follows. \square

Now we are ready to prove the exact characterization of extremal graphs from Theo-

rem 5.

Proof of Theorem 5. By Proposition 1, $\gamma_t^{\text{ID}}(G) = n$ if and only if $G = P_3$.

Let us first see that the graphs of the statement are indeed extremal. If $G \in \{K_{1,t} \mid t \geq 2\} \cup \mathcal{A}^* \cup (\mathcal{A}^* \bowtie K_1)$, then $\gamma_t^{\text{ID}}(G) \geq n - 1$, since $\gamma^{\text{ID}}(G) \geq n - 1$ by Theorem 4. If $G' = G'' \bowtie K_m$ where $m \geq 1$ and $G'' \in \mathcal{A} \cup (\mathcal{A} \bowtie K_1)$, and we add attach a leaf to each vertex in the clique K_m , then $\gamma_t^{\text{ID}}(G) \geq n - 1$ by Proposition 6.

We then show that these are the only graphs attaining the extremal value of $n - 1$. Let $\gamma_t^{\text{ID}}(G) = n - 1$ and G be a graph other than a star. By Lemma 7, if there are no leaves in G , then $\gamma^{\text{ID}}(G) = n - 1$ and we are done by Theorem 4. Thus, we assume that G has at least one leaf u and an adjacent support vertex v , and we proceed by induction on the number n of vertices.

For the base cases, let us first go through all the graphs with $3 \leq n \leq 6$, with leaves, and $\gamma_t^{\text{ID}}(G) = n - 1$. Let v be a support vertex in G and u be the adjacent leaf. The only identifiable graph with $n = 3$ is P_3 , which is isomorphic to $K_{1,2}$ and hence in the family. When $n = 4$ we have P_4 , which is isomorphic to A_2 and in the family as well.

For $n = 5$, due to Lemma 8 we are only interested in the graphs for which $G - u - v$ is identifiable, connected and $\gamma_t^{\text{ID}}(G - u - v) \geq 2$; that is, $G - u - v$ is P_3 . The possible graphs are depicted in Figure 6. The three graphs in (a), (b) and (c) have a total dominating identifying code of size at most $n - 2$, while the two other ones are in the extremal family. Indeed, (d) is the bull graph, which is obtained from K_1 (i.e. $A_0 \bowtie K_1$) in $\mathcal{A} \bowtie K_1$ by joining it to K_2 and adding an adjacent leaf to each vertex of K_2 . Moreover, (e) is obtained from P_3 (i.e. $A_1 \bowtie K_1$) in $\mathcal{A} \bowtie K_1$ by joining it to K_1 and adding an adjacent leaf to its vertex.

When $n = 6$, again by Lemma 8, we are only interested in the connected identifiable graphs for which $\gamma_t^{\text{ID}}(G - u - v) \geq 3$, that is, for which $G - u - v$ is P_4 , C_4 or $K_{1,3}$. There exist nine such graphs for which $G - u - v$ is P_4 , five graphs for which $G - u - v$ is C_4 and seven graphs for which $G - u - v$ is $K_{1,3}$. However, by Lemma 8, we may omit each graph G from which we may obtain an unconnected or non-identifiable graph by deleting a leaf-support vertex pair. After that we are left with six graphs for which $G - u - v$ is P_4 , five graphs for which $G - u - v$ is C_4 and four graphs for which $G - u - v$ is $K_{1,3}$, see Figure 7. Apart from graphs (d), (f), (k) and (n), all have a total dominating identifying code of size at most $n - 2$. Graph (d) is in the family, since it is isomorphic to the empty graph A_0 in \mathcal{A} , to which has been joined a copy of K_3 with a leaf attached to each vertex. Graphs (f) and (k) are in the family as well, as they are either P_4 (i.e. A_2 in \mathcal{A}) or C_4 (i.e. $A_1 \bowtie A_1$ in \mathcal{A}) joined to K_1 whose vertex a leaf is attached to. Finally, (n) is also in the family, as it is A_1 joined to K_2 whose vertices we have attached leaves.

Hence, we can assume from now on that $n \geq 7$ and we proceed with the inductive step.

By Lemma 8, $G_v = G - u - v$ is a connected, identifiable graph with $\gamma_t^{\text{ID}}(G_v) = n - 3$ for any leaf u and adjacent support vertex v . Notice that if G_v is a star, then $\gamma^{\text{ID}}(G_v) = n - 3$ and we have a contradiction with Lemma 9. Moreover, if $\delta(G_v) \geq 2$, then by Lemma 7, $\gamma^{\text{ID}}(G_v) \geq n - 3$ and we are done by Lemma 9. Hence, we can assume that G_v is not

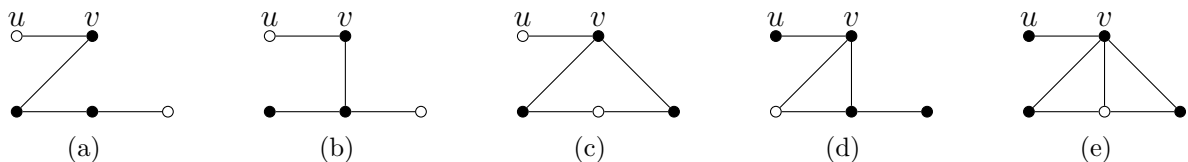

Figure 6: The possibilities for graph G when $G - u - v$ is isomorphic to P_3 , in the proof of Theorem 5. The black vertices form total dominating identifying codes.

a star and has a vertex of degree 1. Then, since G_v is also not a P_4 since $n \geq 7$, we have $\gamma^{\text{ID}}(G_v) \leq n - 4$ by Theorem 4. Thus, by induction, G_v has the claimed structure of part (ii) of the statement. That is, there exist graphs $G'' \in \mathcal{A} \cup (\mathcal{A} \bowtie K_1)$ and $G' = G'' \bowtie K_m$, for $m \geq 1$, such that we can form the graph G_v by adding a leaf to every vertex in the clique K_m of graph G' .

We claim that the only way to add vertex v to G_v is by making it a universal vertex in G' and adding no edges between v and the leaves of G_v .

We first show that there can be no edges in G between v and the set $L(G_v)$. Suppose on the contrary that there exists an edge between w' and v , where $w' \in L(G_v)$ and $w \in S(G_v)$ is the support vertex adjacent to w' . Due to issues with total domination, we first consider the case where $N(v) = \{w', u\}$. By Lemma 8 we have $\gamma_t^{\text{ID}}(G_v - w - w') \geq n - 5$. Let C' be a total dominating identifying code in $G_v - w - w'$. Now $C' \cup \{u, v, w'\}$ is a total dominating identifying code in G of cardinality $n - 2$, a contradiction.

We then consider the case where v has at least three neighbours in G . We split this case based on whether there exists a universal vertex y of G' such that $y \notin S(G_v)$ (such a vertex exists only if $G'' \in \mathcal{A} \bowtie K_1$). Assume first that such vertex y does not exist. In this case, we may consider the code $C = V(G) \setminus \{w, w'\}$. It is total dominating since v has at least three neighbours. Moreover, $V(G_v) \setminus \{w'\}$ is an identifying code in G_v and we only need codeword w to dominate w' . When we consider C and graph G , we notice that u and v clearly have unique I -sets. Moreover, w is the only non-codeword which is a universal vertex in G' and every other vertex universal in G' has an adjacent leaf codeword (since y does not exist). Thus, w is separated from other vertices. Finally, w' is the only vertex which has exactly v in its I -set.

Assume then that the vertex $y \in S(G_v)$ exists. Now, we may consider code $C = V(G) \setminus \{y, w\}$. Code C is clearly total dominating. Moreover, $V(G) \setminus \{w\}$ and $V(G) \setminus \{y\}$ are identifying codes in G_v and w is only needed to total dominate w' in G_v . Since y and w are universal vertices in G' , they do not separate anything in G' . Moreover, u and v are clearly separated by C . Thus, the code is total dominating and identifying. Hence, we may from now on assume that v is not adjacent to any leaf of G_v , that is, $L(G) = L(G_v) \cup \{u\}$.

We consider the case where there are some non-edges between the clique K_m in G' , and v . Let us not have edge vw in graph G , where w is some vertex in the clique K_m of G' and w' is either the universal vertex in G'' , if such a vertex exists, and otherwise the leaf adjacent to w . Now, $C = V(G) \setminus \{w', u\}$ is a total dominating identifying code of G .

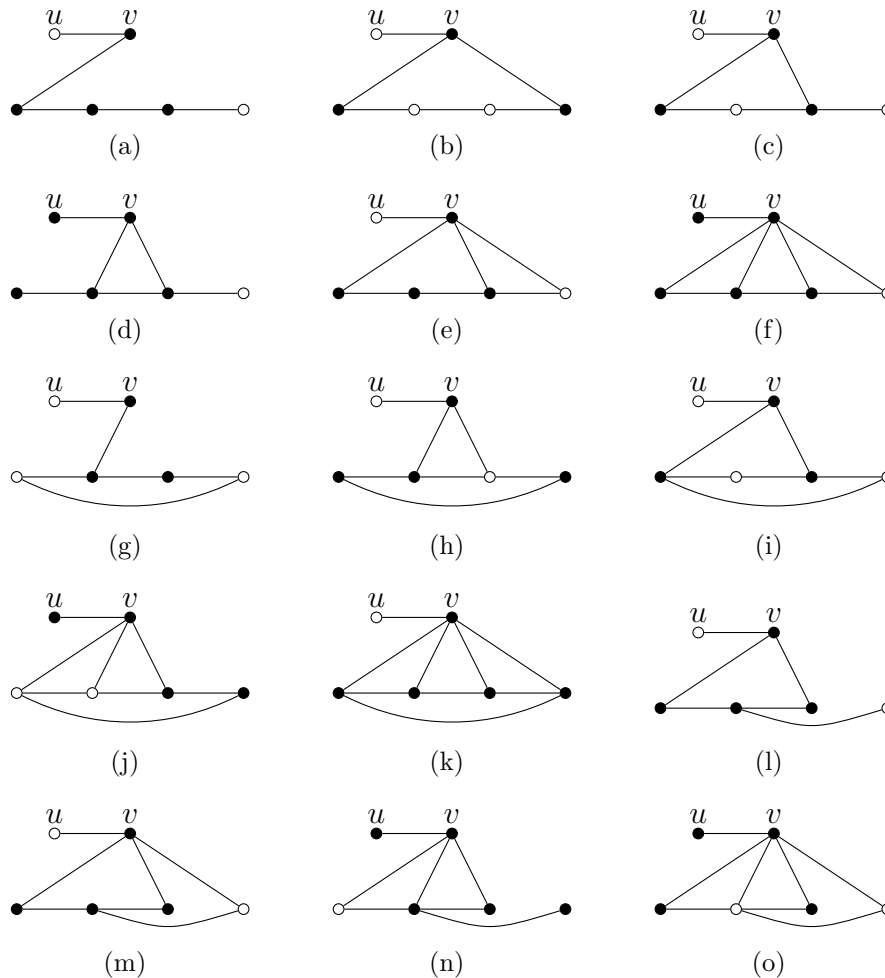

Figure 7: The possibilities for graph G when $G - u - v$ is isomorphic to P_4 , C_4 or $K_{1,3}$, in the proof of Theorem 5. The black vertices form total dominating identifying codes.

Indeed, $V(G_v) \setminus \{w'\}$ is a total dominating identifying code in G_v and u is now the only vertex which has exactly v in its I -set while v is separated from all other vertices since it is the only non-leaf vertex which is not adjacent to w . Hence, we may from now on assume that v has an edge with each vertex of clique K_m in G' .

Finally, we are left with the case where we have some non-edges between v and G'' . Assume first that there does not exist a vertex $z \in V(G'')$ such that $N_G[z] \cup \{u\} = N_G[v]$. Now, we may consider code $C = V(G) \setminus \{u, w'\}$ where w' is either the universal vertex in G'' , if such a vertex exists, and otherwise some leaf in $L(G)$ other than u . Code C is total dominating. Moreover, $V(G_v) \setminus \{w'\}$ is an identifying code in G_v . Finally, u has a unique I -set as the only vertex adjacent to only v , while v is separated from every other vertex in clique K_m by having some non-edge to G'' and it is separated from every vertex in G'' since z does not exist. Thus, C is a total dominating identifying code of size $n - 2$, a contradiction.

Consider then the case where we have the vertex $z \in V(G'')$ with $N_G[z] \cup \{u\} = N_G[v]$. Notice that since v is not a universal vertex to G'' , neither is z . Thus, we may consider $C = V(G) \setminus \{z, w'\}$ where w' is either the universal vertex in G'' , if such a vertex exists, and otherwise some leaf in $L(G)$ other than u . Again, C is clearly total dominating and $V(G_v) \setminus \{w'\}$ is an identifying code in G_v . Again, u and v have unique I -sets with the same arguments as before. Moreover, any pair of vertices separated by z in G_v , is now separated by v in G and hence, C is an identifying code in G . Now, we have exhausted all the possibilities and the claim follows. \square

3 An upper bound for graphs of girth at least 5

Notice that the extremal graphs from the previous section either have many twins (stars for example), or small cycles. In this section, we prove a (tight) upper bound for total identifying codes of twin-free graphs of girth at least 5 that is much smaller than the one for the general case. Similar upper bounds for twin-free graphs have been studied in the context of location-domination, see [13, 14, 17] and usual identifying codes [1, 15].

We will need the following lemma, whose proof was given in [21] (note that it was extended to a larger graph class in [15], that includes all identifiable triangle-free graphs).

Lemma 10 ([21]). *If T is a tree on $n \geq 4$ vertices that is not the path P_4 , then*

$$\gamma_t^{ID}(T) \leq n - s(T).$$

Lemma 10 was shown to be tight in [15], for example for the 3-corona of any graph, the 1-corona of any triangle-free graph of order at least 3, or any star of order at least 3.

For total dominating identifying codes in trees, the following upper bound is known.

Theorem 11 ([30, Theorem 14]). *If T is a tree on $n \geq 3$ vertices, then $\gamma_t^{ID}(T) \leq \frac{3(n+\ell(T))}{5}$.*

This upper bound, together with Lemma 10, yields the following corollary.

Corollary 12. *If T is a twin-free tree on at least $n \geq 3$ vertices, then*

$$\gamma_t^{ID}(T) \leq 3n/4.$$

Proof. Since G is twin-free, we have $s(T) = \ell(T)$, thus by Lemma 10 we have $\gamma_t^{ID}(T) \leq n - \ell(T)$. Thus, if $\ell(T) \geq \frac{n}{4}$, we are done. On the other hand, if $\ell(T) < \frac{n}{4}$, by Theorem 11, we have $\gamma_t^{ID}(T) \leq 3(n + \ell(T))/5 < \frac{3n}{4}$. \square

Observe that we have $\gamma_t^{ID}(C_6) = 4 > (3 \cdot 6)/5$ and hence, one cannot generalize the bound $\gamma_t^{ID}(T) \leq 3(n + \ell(T))/5$ to a class of twin-free graphs including 6-cycles. However, we can generalize Corollary 12 to all twin-free graphs of girth at least 5 by finding a small total dominating identifying code in a well chosen sub-tree.

Theorem 13. *If G is a connected twin-free graph of girth at least 5 on $n \geq 3$ vertices, then*

$$\gamma_t^{ID}(G) \leq 3n/4.$$

Proof. Observe first that if G has a twin-free spanning tree T , then T has a total-dominating identifying code of size at most $3n/4$ by Corollary 12. Moreover, since G does not have any triangles or 4-cycles, one can check that the same code is also total dominating identifying in G .

Assume that every spanning tree of G has some twins, that is, leaves with the same adjacent support vertex, and assume that T is the spanning tree with the least amount of twins among all spanning trees of G . Now, for each support vertex, we remove all but one adjacent leaf and we denote by T' the resulting twin-free tree and say that it has n' vertices. Notice that $n' \geq 4$. Indeed, if $n' \leq 3$, then T does not contain a P_4 as a subgraph. Since T is connected, it is a star. However because $n \geq 4$ and G is twin- and triangle-free, we get a contradiction. Thus, $n' \geq 4$. Now, $\gamma_t^{\text{ID}}(T') \leq 3n'/4$ by Corollary 12. Let C be a total dominating identifying code in T' of at most size $3n'/4$; observe that $S(T') \subseteq C$, since each leaf needs a neighbour in C in order to be totally dominated.

If $v \in S(T)$ is a support vertex which has $u, w \in N_T(v) \cap L(T)$, then we have removed either u or w to form T' . However, since G is twin-free, u or w , say u , has some other neighbours in G . Consider $x \in N_G(u)$. Observe that since T had the minimal number of twins among all the spanning trees, we have $x \in S(T')$. Indeed, otherwise $T - uv + xu$ would have at least one twin less than T , a contradiction. However, then, $x \in C$ and hence, $|I_G(C; u)| \geq 2$ and because G has no 4-cycles, u is uniquely distinguished. Thus, C is a total dominating identifying code of G with cardinality at most $3n'/4 < 3n/4$. \square

Note that Theorem 13 cannot hold for graphs that contain twins (because of complete bipartite graphs, for which the total identifying code number is $n - 2$ or $n - 1$) or triangles (because of complements of half-graphs, for which the (total dominating) identifying code number is $n - 1$ [12] as seen in Proposition 3). However, in the following corollary, we give a generalized form for all connected graphs of girth at least 5.

Corollary 14. *If G is a connected graph of girth at least 5 on $n \geq 3$ vertices, then*

$$\gamma_t^{\text{ID}}(G) \leq (3n + \ell(G) - s(G))/4.$$

Proof. Let G be a connected graph of girth at least 5 on $n \geq 3$ vertices. If G is a star, then $(3n + \ell(G) - s(G))/4 = n - 1/2$ and the claim holds. Assume then that G is not a star. Notice that if we have any twins, then they are leaves with the same adjacent support vertex. Denote by G' the graph obtained from G by removing leaves until G' is twin-free and let G' have order n' . Since G is not a star, we have $n' \geq 3$ and thus by Theorem 14, $\gamma_t^{\text{ID}}(G') \leq 3n'/4$. Let C' be an optimal total dominating identifying code in G' . We have $S(G') \subseteq C'$. Thus, we may construct a total dominating identifying code C for G as $C = C' \cup (L(G) \setminus L(G'))$. We have $|C| \leq 3n'/4 + (\ell(G) - \ell(G')) = 3(n - \ell(G) + s(G))/4 + (\ell(G) - s(G)) = (3n + \ell(G) - s(G))/4$. \square

Remark 15. Theorem 13 improves the known upper bound for usual identifying codes in connected twin-free graphs of girth at least 5 when $\ell(G) > n/8$. Indeed, the current best known upper bound for such graphs is $\gamma^{\text{ID}}(G) \leq (5n + 2\ell(G))/7$, [15]. When $\ell(G) \geq n/8$, we have $(5n + 2\ell(G))/7 \geq 3n/4$. Furthermore, Corollary 14 improves the bound when $s(G) > n/(a + 7)$ where $\ell(G) = a \cdot s(G)$ and $a \geq 1$ is a constant.

Consider now some graphs which actually attain the $\frac{3n}{4}$ upper bound. In [30], the authors have shown that if $\gamma_t^{\text{ID}}(T) = 3(n + \ell(T))/5$, then $T \in \mathcal{T}$, where \mathcal{T} is defined with the following iterative process. Let $T_0 = P_8$ and let there exist four different *statuses* of vertices, A , B , C and D , denoted by $s(v)$ for vertex v . For T_0 , leaves have status C , support vertices status A , non-leaf vertices adjacent to support vertices status B and the remaining two vertices have status D . Now, we can create a tree T_i from a tree $T_{i-1} \in \mathcal{T}$ by applying either of two operations ϕ_1 or ϕ_2 .

In operation ϕ_1 , we add a path P_5 to T_{i-1} , with vertices y, z, u, v, w , where the consecutive vertices have an edge between them, with an edge between y and any vertex $x \in V(T_{i-1})$ with $s(x) = C$. Moreover, we have statuses $s(y) = D$, $s(z) = D$, $s(u) = B$, $s(v) = A$ and $s(w) = C$.

In operation ϕ_2 , we add path P_4 to T_{i-1} , with vertices y, z, u, v , where the consecutive vertices have an edge between them, with an edge between y and any vertex $x \in V(T_{i-1})$ with $s(x) = D$. Moreover, we have statuses $s(y) = D$, $s(z) = B$, $s(u) = A$ and $s(v) = C$.

For a graph H , the *3-corona* of H is the graph of order $4|V(H)|$ obtained from H by adding a vertex-disjoint copy of a path P_3 for each vertex v of H and adding an edge joining v to one end of the added path (see [15] and [22, Section 1.3]).

Since a twin-free tree T on $n \geq 8$ vertices can attain the upper bound in Corollary 12 only when $T \in \mathcal{T}$ and $s(T) = n/4$, we can construct T from T_0 by iteratively applying operation ϕ_2 . Moreover, this is equivalent with saying that T is the 3-corona of some tree H on at least two vertices where $s(v) = D$ if $v \in V(H)$. This leads to the following theorem (noticing that the path P_4 is also an example).

Theorem 16. *If T is a twin-free tree on $n \geq 4$ vertices with $\gamma_t^{\text{ID}}(T) = 3n/4$, then T is the 3-corona of some tree H .*

Observe that we cannot generalize Theorem 16 to all twin-free graphs of girth at least 5, since $\gamma_t^{\text{ID}}(C_8) = 6$, but we do not know if there exist other counterexamples. However, we can deduce from the proof of Theorem 13 that if some other counterexample exists, then that graph has only 3-coronas as its twin-free spanning trees.

4 Bounds between related parameters

In this section we prove bounds relating the parameter γ_t^{ID} to similar parameters. Tight bounds relating the parameters γ^{ID} , γ^{L} and γ^{OL} were provided in the literature. It was indeed proved in [20] that for any identifiable graph G , $\gamma^{\text{ID}}(G) \leq 2\gamma^{\text{L}}(G)$ holds (and is tight). Similar bounds were proved in the PhD thesis [38, Chapter 2.4.1], showing that $\gamma^{\text{ID}}(G) \leq 2\gamma^{\text{OL}}(G)$, $\gamma^{\text{OL}}(G) \leq 2\gamma^{\text{L}}(G)$ and $\gamma^{\text{OL}}(G) \leq 2\gamma^{\text{ID}}(G)$, and providing tight families of examples for each bound. As we will see, we can also bound $\gamma_t^{\text{ID}}(G)$ by a constant times $\gamma^{\text{L}}(G)$, $\gamma_t^{\text{L}}(G)$ and $\gamma^{\text{ID}}(G)$, but not exactly by a factor of 2 like in the other bounds. We have presented some relationships between these types of codes in Figure 1. Thus, we have $\gamma_t^{\text{ID}}(G) \leq \gamma_E^{\text{ID}}(G)$ and $\gamma_t^{\text{ID}}(G) \leq \gamma_S^{\text{ID}}(G)$. As we will see, we cannot get similar constant type bounds for these parameters.

4.1 Relation with (classic) identifying codes

Theorem 17. *Let G be a connected graph with $\gamma^{\text{ID}}(G) \geq 3$, then*

$$\gamma_t^{\text{ID}}(G) \leq 2\gamma^{\text{ID}}(G) - 2.$$

Proof. Assume that C is an optimal identifying code in G with cardinality at least 3. Since G is connected and C is identifying, if $I(c) = \{c\}$ for some codeword $c \in C$, then we may add any adjacent non-codeword to C and vertex c becomes totally dominated. Since at least the first non-codeword we add to the code can be chosen to connect two codewords (indeed the non-codeword cannot be only dominated by the codeword), we immediately get that we need at most $|C| - 1$ vertices in this process, and so $\gamma_t^{\text{ID}}(G) \leq 2\gamma^{\text{ID}}(G) - 1$.

Observe that if any two codewords are adjacent in C , then there is also a third codeword adjacent to one of them, that distinguishes them. Thus, we need at most $|C| - 3 + |C| = 2|C| - 3$ codewords to form a total dominating identifying code and we are done. Hence, we assume from now on that every optimal identifying code in G has only isolated codewords. Therefore, each non-codeword has at least two adjacent codewords. Observe that if any non-codeword x has three or more adjacent codewords, then we are done by adding vertex x to the code and then proceeding as in the first step. Likewise, if a pair of non-codewords together has four or more distinct adjacent codewords, we can proceed similarly. Thus, we may now assume that this does not occur.

Moreover, we may assume that $2|C| \leq n$. Otherwise, the claim follows from Proposition 1. Now, consider the bipartite graph B obtained from G by keeping only the edges between the codewords and non-codewords. If we contract non-codewords into edges (recall that each non-codeword has degree 2 in B) of B to obtain a graph G' , since $2|C| \leq n$, we notice that we have $|C|$ vertices and at least $|C|$ edges in G' . Moreover, graph B could not have a 4-cycle since C is an identifying code and hence, we do not contract non-codewords into parallel edges. Thus, the resulting graph G' has a cycle of length at least 3. If this cycle has at least four vertices, then there existed two non-codewords in G with at least two distinct adjacent codewords each (this corresponds to a matching of size 2 in G'), a contradiction, and the claim follows. The same is true, if the cycle is a triangle and there exist any other vertex in G' (then here also, G' contains a matching of size 2).

Finally, we are left with the case where $\gamma^{\text{ID}}(G) = 3$. Moreover, by the previous argumentation, the only case we need to consider is the one where each codeword has degree 2, is adjacent to exactly two non-codewords, and there is a total of six vertices. If none of the non-codewords are adjacent in G , then G is the cycle C_6 which has $\gamma_t^{\text{ID}}(C_6) = 4$, and we are done. Thus, we may assume that there is an edge between some non-codewords. However, now we can find an induced path P_4 c_1, u, v, c_2 which starts with $c_1 \in C$, has non-codewords u and v as the middle vertices and ends with $c_2 \in C$. The path is induced due to the properties of codeword vertices. We claim that these four vertices form a total dominating identifying code C' . Observe that the single vertex w which belongs to neither C nor C' is the only vertex with I -set $\{c_1, c_2\}$ and the single vertex in $C \setminus C'$ is the only vertex which is not adjacent to either codeword in $C \cap C'$. Finally, the vertices in C' are pairwise separated since $G[C']$ is a 4-path. \square

The upper bound of Theorem 17 is tight for 1-coronas of complete graphs from which we remove a single leaf.

4.2 Relation with locating-total dominating sets

Theorem 18. *If G is a connected identifiable graph on at least three vertices, then*

$$\gamma_t^L(G) \leq \gamma_t^{LD}(G) \leq 2\gamma_t^L(G).$$

Proof. In [19, Proof of Theorem 8], the authors have shown that if D' is a locating-dominating set in G , then there exists an identifying code D such that $D' \subseteq D$ and $|D| \leq 2|D'|$.

Assume now that C' is an optimal locating-total dominating set in graph G . Thus, C' is a locating-dominating set and hence, there exists an identifying code C such that $C' \subseteq C$ of cardinality $|C| \leq 2|C'| = 2\gamma_t^L(G)$. Moreover, since C' is total dominating, also C is total dominating and hence, $\gamma_t^{LD}(G) \leq 2\gamma_t^L(G)$ as we claimed. \square

The upper bound from Theorem 18 is tight for complete graphs of odd order from which we have removed a maximal matching, indeed for such a graph G of order $n = 2k + 1$ we have $\gamma_t^{LD}(G) = n - 1 = 2k$ by Proposition 3 but $\gamma_t^L(G) = k$ (for every edge of the removed matching, the two endpoints are twins in G , so one of them must belong to any locating-dominating set and $\gamma_t^L(G) \geq k$; on the other hand, selecting one such vertex for each pair gives a locating-total dominating set of size k).

4.3 Relation with locating-dominating sets

We first relate the locating-total domination number with the usual location-domination number.

Theorem 19. *If G is a connected graph on at least three vertices, then*

$$\gamma^L(G) \leq \gamma_t^L(G) \leq 2\gamma^L(G) - 1.$$

Proof. Let G be a connected graph and let C be an optimal locating-dominating set in G . We can create a locating-total dominating set from C by adding a codeword adjacent to each codeword in C . Thus, $\gamma_t^L(G) \leq 2\gamma^L(G)$. However, since G is connected, there exists a non-codeword u with $|I(u)| \geq 2$ if $\gamma^L(G) \geq 3$. Thus, we may add u and $\gamma^L(G) - 2$ other vertices to the code and we get the claimed upper bound. Notice that $\gamma^L(G) \geq 2$, since we have at least three vertices in G . Moreover, if $\gamma^L(G) = 2$ and we have $|I(u)| = 1$ for each vertex in $V(G)$, then G is a path on four vertices. However, $\gamma_t^L(P_4) \leq \gamma_t^{LD}(P_4) = 3$ and the claim follows. \square

The upper bound from Theorem 19 is tight for stars which have all but one of their edges subdivided once. Indeed, for such a tree T_k of order $n = 3k + 2$, we have $\gamma^L(T_k) = k + 1$ and $\gamma_t^L(T_k) = 2k + 1$. For each leaf of T_k , either the leaf or its support vertex must be in any dominating set to dominate the leaf, so $\gamma^L(T_k) \geq k + 1$. Moreover, to get a

total dominating set, we need two vertices in each branch which has three vertices and the central vertex, so $\gamma_t^L(T_k) \geq 2k + 1$. On the other hand, taking every support vertex gives a locating-dominating set of size $k + 1$. Taking every support vertex together with its degree 2 neighbour gives a locating-total dominating set of size $2k + 1$.

Notice that Theorems 17, 18 and 19 together with [19, Theorem 8] and Figure 1 imply that $\gamma_t^{ID}(G) \leq 2\gamma^{ID}(G) - 2 \leq 4\gamma^L(G) - 2$ and that $\gamma_t^{ID}(G) \leq 2\gamma_t^L(G) \leq 4\gamma^L(G) - 2$. However, as we can see in the following theorem, this bound is not tight.

Theorem 20. *If G is a connected identifiable graph with $\gamma^L(G) \geq 2$, then*

$$\gamma_t^{ID}(G) \leq 3\gamma^L(G) - \log_2(\gamma^L(G) + 1).$$

Proof. Let C_{LD} be an optimal locating-dominating set with at least two codewords in an identifiable connected graph G . We have $\gamma^{ID}(G) \leq 2|C_{LD}|$ by [20, Theorem 8]. Moreover, following the proof of [20], we may construct an identifying code from C_{LD} by just adding at most $|C_{LD}|$ additional vertices to C_{LD} . Denote by C_A a smallest set of vertices which we can add to C_{LD} so that $C_A \cup C_{LD} = C_{ID}$ is an identifying code. Observe that every vertex in C_A is adjacent to a vertex in C_{LD} (since every vertex not in C_{LD} is adjacent to a vertex in C_{LD}). Moreover, when we add the $|C_A|$ new codewords, those new codewords are also total dominating some (old) codewords of C_{LD} . We denote the dominated codewords by $C_D \subseteq C_{LD}$. In particular, we have $2^{|C_D|} - 1 \geq |C_A|$ since the vertices in C_A were all dominated and separated among each other by the vertices of C_D .

Therefore, to make C_{ID} total dominating, it suffices to add only codewords which dominate vertices in $C_{LD} \setminus C_D$. Hence, we can build a total dominating identifying code of cardinality at most $|C_{LD}| + (|C_{LD}| - |C_D|) + |C_A| \leq 2|C_{LD}| + |C_A| - \log_2(|C_A| + 1) \leq 3|C_{LD}| - \log_2(|C_{LD}| + 1)$. \square

We can show that the bound of Theorem 20 is almost tight, as follows.

Proposition 21. *For every integer $k \geq 2$, there is a connected identifiable graph G_k with $\gamma^L(G_k) = 2^k - 1$ and $\gamma_t^{ID}(G_k) = 3 \cdot 2^k - 2k - 3 = 3\gamma^L(G_k) - 2\log_2(\gamma^L(G_k) + 1)$.*

Proof. We build G_k as follows. G_k contains a set $A = \{a_1, \dots, a_k\}$ of k vertices. For each vertex a_i in A , we add a leaf b_i adjacent to a_i . Moreover, for each subset S of A of size at least 2 (there are $2^k - k - 1$ such sets), we have vertices x_S, x'_S, y_S and z_S with the following edges. Vertices x_S and x'_S have all the vertices a_i with $a_i \in S$ as neighbours. Moreover, x_S is adjacent to x'_S and to y_S . Vertex z_S is adjacent to x_S, x'_S and y_S . See Figure 8 for an illustration.

To see that $\gamma^L(G_k) \leq 2^k - 1$, notice that the set consisting of A and each vertex y_S forms a locating-dominating set. Moreover we need at least $2^k - k - 1$ vertices to dominate the vertices of type y_S , and k vertices to dominate the vertices of type b_i , so $\gamma^L(G_k) \geq 2^k - 1$.

Next, observe that each vertex y_S needs to be in any identifying code to separate x_S from x'_S , for each subset S of A of size at least 2. We also need one of z_S and x_S to totally dominate y_S . Moreover, x'_S must belong to the code in order to separate y_S from z_S .

Vertex a_i must belong to the code to totally dominate b_i , for each i in $\{1, \dots, k\}$. Thus, $\gamma_t^{\text{ID}}(G_k) \geq 3(2^k - k - 1) + k = 3 \cdot 2^k - 2k - 3$. Finally, the set consisting of A , each vertex y_S , z_S , and x'_S forms a total dominating identifying code, thus $\gamma_t^{\text{ID}}(G_k) \leq 3 \cdot 2^k - 2k - 3$. \square

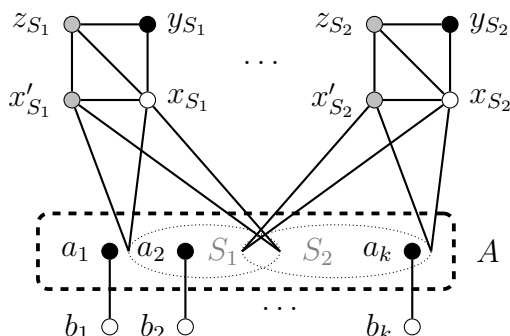

Figure 8: Sketch of the graph G_k built in Proposition 21, where S_1 and S_2 are two subsets of A of size at least 2. The black vertices form an optimal locating-dominating set, while the black and gray vertices together form an optimal total dominating identifying code.

4.4 Relations with self-identifying and error-correcting identifying codes

In the following two propositions, we show that there does not exist general bounds of types $\gamma_S^{\text{ID}}(G) \leq c\gamma_t^{\text{ID}}(G)$ or $\gamma_E^{\text{ID}}(G) \leq c\gamma_t^{\text{ID}}(G)$ for any constant c . In fact, the constructions we give, offer (almost) the largest possible gaps between any γ_t^{ID} and any other parameter. Indeed, if a graph has $2^k - 1$ vertices, then there are at least k vertices in any total dominating identifying code in graph G . Hence, the values of $\gamma_E^{\text{ID}}(G)$ or $\gamma_S^{\text{ID}}(G)$ alone tell almost nothing about the value of $\gamma_t^{\text{ID}}(G)$.

Proposition 22. *Let $k \geq 4$ be an even integer. There exists a connected graph G with $\gamma_t^{\text{ID}}(G) = k$ and $\gamma_S^{\text{ID}}(G) = 2^k - 2$.*

Proof. Let $k \geq 4$ be an even integer. We construct graph G in the following way. We start from a complete graph K_k on vertex set $X = \{x_1, \dots, x_k\}$. After that we create $2^k - k - 2$ vertices and join each to a distinct subset $X' \subseteq X$ of vertices of cardinality $1 \leq |X'| \leq k - 2$. Then, we join any vertex u with $N(u) = X'$ to the single vertex v with $N(v) = X \setminus X'$. If $\deg(u) = 1$ and $N(u) = \{x_{2i+1}\}$, then we join it to vertex v with $N(v) = \{x_{2i+2}\}$ where $0 \leq i \leq k/2 - 1$. Finally, we remove a perfect matching $\{x_1x_k, x_2x_3, x_4x_5, \dots, x_{k-2}x_{k-1}\}$ from the vertices within the clique K_k .

Observe that $C = X$ forms an optimal total dominating identifying code. Moreover, since no vertex has its closed neighbourhood completely included in another neighbourhood, set $V(G)$ is a self-identifying code. We claim that it is also optimal. Suppose on the contrary that C is a self-identifying code of smaller cardinality. Assume first that some vertex $x_i \notin C$. There exists a vertex u with $N(u) = \{x_i, v\}$. Now, $I(u) \subseteq \{u, v\} \subseteq I(v)$ and hence, C is not a self-identifying code. Assume then that some vertex $u \notin X$ is a

non-codeword. There is vertex $v \in N(u) \setminus X$. Assume first that $N(u) = \{v, x_i\}$. Let $x_j \in N(v)$. Now $I(u) \subseteq \{x_i, v\} \subseteq I(x_j)$. Moreover, if $N(u) = X' \cup \{v\}$, then there exists a vertex $x_j \in X \setminus X'$ with $X \cup \{v\} \subseteq I(x_j)$, a contradiction. Hence, $V(G)$ is an optimal self-identifying code and the claim follows. \square

In the following proposition, we consider the possible gap between total dominating identifying codes and error-correcting identifying codes.

Proposition 23. *Let $k \geq 4$ be an integer. There exists a connected graph G with $\gamma_t^{ID}(G) = k$ and $\gamma_E^{ID}(G) = 2^k - 1$.*

Proof. Let $k \geq 4$ be an integer. We construct graph G in the following way. We start from a path P_k on vertex set $X = \{x_1, \dots, x_k\}$. After that we create a set Y of $2^k - k - 1$ vertices and join each to a distinct nonempty subset $X' \subseteq X$ of vertices such that $N[x_i] \cap X \neq X'$ for any x_i . After this, we add edges between the vertex w of Y joined to all vertices of X , and each vertex of Y joined to the vertices of some set $X' \subseteq X$ with $|X'| = 1$.

Observe that code $C = X$ is an optimal total dominating identifying code in G . Moreover, we claim that $V(G)$ is an optimal error-correcting identifying code in G . Let C be an optimal error-correcting identifying code in G . Notice that for each i ($1 \leq i \leq k$), $x_i \in C$. Indeed, otherwise some vertex u in Y with $N(u) = \{x_i, x_j\}$ would have $|I(u)| \leq 2$, a contradiction. Moreover, if a vertex u with $|N(u) \cap X| \leq 2$ is a non-codeword, then $|I(u)| \leq 2$, a contradiction. Similarly, if the vertex w of Y with $N(w) = X$ is a non-codeword, then each vertex u of Y with $|N(u) \cap X| = 1$ has $|I(u)| \leq 2$. Finally, suppose by contradiction that some vertex v of Y with $|N(v) \cap X| \geq 3$ is a non-codeword. Then, we can find a vertex x_i of $N(v) \cap X$ such that there exists a vertex v' of Y with $N(v') \cap X = (N(v) \cap X) \setminus \{x_i\}$. Then, $I(v) \Delta I(v') \subseteq \{v', x_i\}$, a contradiction. Thus, $V(G)$ is an optimal error-correcting identifying code. \square

Observe that the construction in Proposition 23 is best possible since any graph on $2^k - 1$ vertices has at least k vertices in any identifying code.

5 Concluding remarks

We have characterized the extremal graphs for total dominating identifying codes (that is, those graphs G of order n for which $\gamma_t^{ID}(G) \in \{n - 1, n\}$), extending the existing characterization for usual identifying codes from [12]. All these graphs either have twins or cycles of lengths 3 and 4; in the absence of these features, we showed that the graph has a relatively small total dominating identifying code, since $\gamma_t^{ID}(G) \leq 3n/4$.

It would be interesting to characterize the graphs for which the $\gamma_t^{ID}(G) \leq 3n/4$ upper bound for twin-free graphs of girth at least 5 of Theorem 13 is tight, extending the characterization obtained for trees (Theorem 16). Is C_8 the only other tight example besides the 3-coronas?

Perhaps it is possible to extend the $3n/4$ bound from girth 5 graphs to some twin-free triangle-free graphs with 4-cycles (we need the triangle-free restriction because of complements of half-graphs, and the twin-free restriction because of stars).

We note that several known bounds for twin-free trees are tight only for coronas, like the $3n/4$ bound for total dominating identifying codes of Corollary 12, the $2n/3$ bound for identifying codes from [15], the $2n/3$ bound for locating-total dominating sets from [13] and $n/2$ bound for dominating sets [10, 34]. An exception is the $n/2$ upper bound for locating-dominating sets, see [14], for which the class of trees reaching the bound is more intricate.

We also introduced multiple tight bounds for γ_t^{ID} based on other domination parameters. However, in the case of locating-dominating sets, we still have a gap in the logarithmic term between the bound in Theorem 20 and the construction in Proposition 21. We have shown that when we do not give any restrictions for the graph structure, then the self-identification number and the error-correcting identification number do not give (almost) any information about the total dominating identification number. However, is it possible to give restrictions for the graph structure so that these values become closer to each other?

Acknowledgements

Florent Foucaud was financed by the French government IDEX-ISITE initiative 16-IDEX-0001 (CAP 20-25) and by the ANR project GRALMECO (ANR-21-CE48-0004). Tuomo Lehtilä's research was supported by the Finnish Cultural Foundation and by the Academy of Finland grant 338797.

References

- [1] C. Balbuena, F. Foucaud, and A. Hansberg. Locating-dominating sets and identifying codes in graphs of girth at least 5. *The Electronic Journal of Combinatorics* 22, #P2.15, 2015.
- [2] B. Bollobás, and A. D. Scott. On separating systems. *European Journal of Combinatorics* 28:1068–1071, 2007.
- [3] J. A. Bondy. Induced subsets. *Journal of Combinatorial Theory, Series B* 12(2):201–202, 1972.
- [4] É. Bonnet, P. Giannopoulos, and M. Lampis. On the parameterized complexity of red-blue points separation. *Journal of Computational Geometry* 10(1):181–206, 2019.
- [5] J. Cáceres, C. Hernando, M. Mora, I. M. Pelayo, and M. L. Puertas. Locating dominating codes: bounds and extremal cardinalities. *Applied Mathematics and Computation* 220:38–45, 2013.
- [6] I. Charon, O. Hudry, and A. Lobstein. Extremal cardinalities for identifying and locating-dominating codes in graphs. *Discrete Mathematics* 307(3-5):356–366, 2007.
- [7] E. Charbit, I. Charon, G. Cohen, O. Hudry, and A. Lobstein. Discriminating codes in bipartite graphs: bounds, extremal cardinalities, complexity. *Advances in Mathematics of Communications* 2(4):403–420, 2008.

- [8] M. Chellali. On locating and differentiating-total domination in trees. *Discussiones Mathematicae Graph Theory* 28:383–392, 2008.
- [9] P. Erdős. Some combinatorial, geometric and set theoretic problems in measure theory. In *Measure Theory Oberwolfach 1983*, pages 321–327. Springer, 1984.
- [10] J. F. Fink, M. S. Jacobson, L. F. Kinch, and J. Roberts. On graphs having domination number half their order. *Periodica Mathematica Hungarica* 16(4):287–293, 1985.
- [11] F. Foucaud, N. Ghareghani, A. Roshany-Tabrizi, and P. Sharifani. Characterizing extremal graphs for open neighbourhood location-domination. *Discrete Applied Mathematics* 302:76–79, 2021.
- [12] F. Foucaud, E. Guerrini, M. Kovše, R. Naserasr, A. Parreau, and P. Valicov. Extremal graphs for the identifying code problem. *European Journal of Combinatorics* 32(4):628–638, 2011.
- [13] F. Foucaud, and M. A. Henning. Locating-total dominating sets in twin-free graphs: a conjecture. *The Electronic Journal of Combinatorics* 23(3):#P3.9, 2016.
- [14] F. Foucaud, M. A. Henning, C. Löwenstein, and T. Sasse. Locating-dominating sets in twin-free graphs. *Discrete Applied Mathematics* 200:52–58, 2016.
- [15] F. Foucaud, and T. Lehtilä. Revisiting and improving upper bounds for identifying codes. *SIAM Journal on Discrete Mathematics* 36(4):2619–2634, 2022.
- [16] F. Foucaud, and G. Perarnau. Bounds on identifying codes in terms of degree parameters. *The Electronic Journal of Combinatorics* 19:#P32, 2012.
- [17] D. Garijo, A. González, and A. Márquez. The difference between the metric dimension and the determining number of a graph. *Applied Mathematics and Computation* 249:487–501, 2014.
- [18] J. Gimbel, B. D. Van Gorden, M. Nicolescu, C. Umstead, and N. Vaiana. Location with dominating sets. *Congressus Numerantium* 129–144, 2001.
- [19] S. Gravier, and J. Moncel. On graphs having a $V \setminus \{x\}$ set as an identifying code. *Discrete Mathematics* 307(3-5):432–434, 2007.
- [20] S. Gravier, R. Klasing, and J. Moncel. Hardness results and approximation algorithms for identifying codes and locating-dominating codes in graphs. *Algorithmic Operations Research* 3(1):43–50, 2008.
- [21] T. W. Haynes, M. A. Henning, and J. Howard. Locating and total dominating sets in trees. *Discrete Applied Mathematics* 154(8):1293–1300, 2006.
- [22] M. A. Henning, and A. Yeo. *Total domination in graphs*, Springer-Verlag, 2013.
- [23] I. Honkala, and T. Laihonen. On a new class of identifying codes in graphs. *Information Processing Letters* 102(2-3):92–98, 2007.
- [24] I. Honkala, T. Laihonen, and S. Ranto. On strongly identifying codes. *Discrete Mathematics* 254(1-3):191–205, 2002.
- [25] D. Jean, and S. Seo. Error-correcting Identifying Codes. [arXiv:2204.11362](https://arxiv.org/abs/2204.11362), 2022.

- [26] V. Junnila, and T. Laihonen. Tolerant location detection in sensor networks. *Advances in Applied Mathematics* 112, 2020.
- [27] M. G. Karpovsky, K. Chakrabarty, and L. B. Levitin. On a new class of codes for identifying vertices in graphs. *IEEE Transactions on Information Theory* 44:599–611, 1998.
- [28] D. Jean, and A. Lobstein. Watching systems, identifying, locating-dominating and discriminating codes in graphs: a bibliography. <https://dragazo.github.io/bibdom/main.pdf>
- [29] B. M. E. Moret, and H. D. Shapiro. On minimizing a set of tests. *SIAM Journal of Scientific and Statistical Computation* 6(4):983–1003, 1985.
- [30] W. Ning, M. Lu, and J. Guo. Bounds on the differentiating-total domination number of a tree. *Discrete Applied Mathematics* 200:153–160, 2016.
- [31] B. N. Omamalin, S. R. Canoy, Jr., and H. M. Rara. Differentiating total dominating sets in the join, corona and composition of graphs. *International Journal of Mathematical Analysis* 8(26):1275–1284, 2014.
- [32] B. N. Omamalin, S. R. Canoy, Jr., and H. M. Rara. Differentiating total domination in graphs: revisited. *International Journal of Mathematical Analysis* 8(56):2789–2798, 2014.
- [33] B. S. Panda, P. Goyal, and D. Pradhan. Differentiating-total domination: Approximation and hardness results. *Theoretical Computer Science* 876:45–58, 2021.
- [34] C. Payan, and N. H. Xuong. Domination-balanced graphs. *Journal of Graph Theory* 6(1):23–32, 1982.
- [35] N. J. Rad, and H. Rahbani. Bounds on the locating-domination number and differentiating-total domination number in trees. *Discussiones Mathematicae Graph Theory* 38:455–462, 2018.
- [36] S. Seo, and P. J. Slater. Generalized set dominating and separating systems. *Journal of Combinatorial Mathematics and Combinatorial Computing* 104:15–29, 2018.
- [37] S. Seo, and P. J. Slater. Open neighborhood locating dominating sets. *Australasian Journal of Combinatorics* 46:109–120, 2010.
- [38] J. L. Sewell. *Vertex-based distinguishing collections*. PhD thesis, University of Alabama in Huntsville, 2017.
- [39] P. J. Slater. Domination and location in acyclic graphs. *Networks* 17(1):55–64, 1987.
- [40] R. Ungrangsi, A. Trachtenberg, and D. Starobinski. An implementation of indoor location detection systems based on identifying codes. Proceedings of the IFIP International Conference on Intelligence in Communication Systems, INTELLI-COMM 2004. *Lecture Notes in Computer Science* 3283:175–189, 2004.