



**HAL**  
open science

## Study of thermo-microfluidic phenomena in microchannels

Jean Kovchar, Abdelhamid Blidia, Magali Barthes, François Lanzetta, Michel  
de Labachellerie

► **To cite this version:**

Jean Kovchar, Abdelhamid Blidia, Magali Barthes, François Lanzetta, Michel de Labachellerie. Study of thermo-microfluidic phenomena in microchannels. 29e congrès annuel de la Société Française de Thermique, Jun 2021, Belfort, France. hal-04172793

**HAL Id: hal-04172793**

**<https://hal.science/hal-04172793>**

Submitted on 28 Jul 2023

**HAL** is a multi-disciplinary open access archive for the deposit and dissemination of scientific research documents, whether they are published or not. The documents may come from teaching and research institutions in France or abroad, or from public or private research centers.

L'archive ouverte pluridisciplinaire **HAL**, est destinée au dépôt et à la diffusion de documents scientifiques de niveau recherche, publiés ou non, émanant des établissements d'enseignement et de recherche français ou étrangers, des laboratoires publics ou privés.

# STUDY OF THERMO-MICROFLUIDIC PHENOMENA IN MICROCHANNELS

J. KOVCHAR, A. BLIDIA, M. BARTHES, F. LANZETTA, M. DE LABACHELERIE



## CONTEXT AND OBJECTIVES OF THE STUDY

### Context of the study

Miniaturization of a Stirling engine for low temperature recovery and energy conversion → Energy losses higher than predicted by the theory

Effect of roughness and 90° angle bends on flow in channel with  $D_h < 1\text{mm}$  ?

### In the literature

- Alternate flow at sub-millimetric scale → Almost nothing
- Permanent flow at sub-millimetric scale → Conflicting results

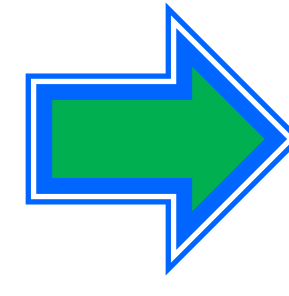

### Objectives:

Influence of geometrical and thermo-fluidic parameters (hydraulic diameter ( $D_h$ ), aspect ratio, compressibility, temperature gradient...)

- Permanent flow
- Alternate flow

→ Investigation for straight channels and channels with bends

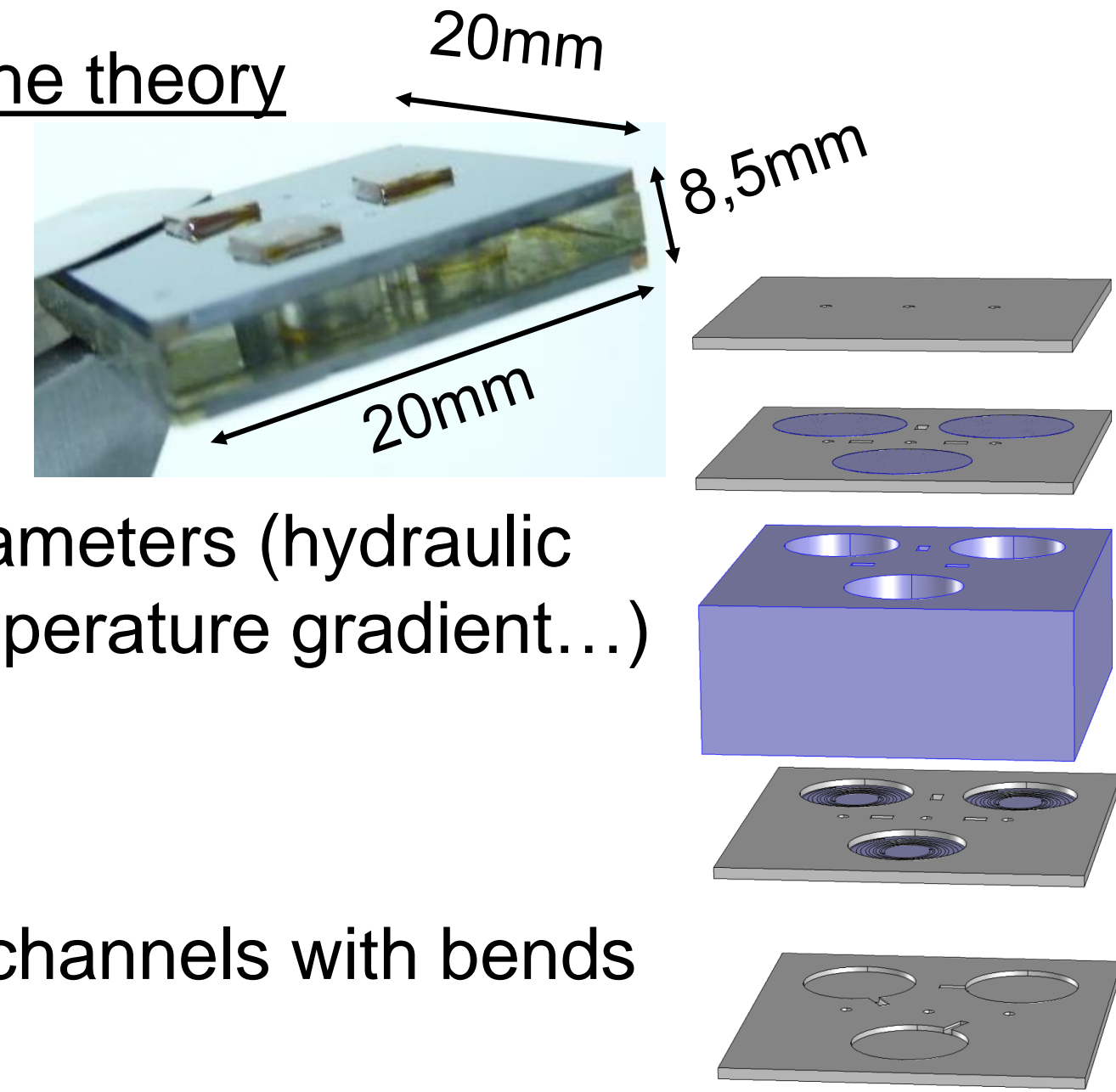

Roughness	Compressibility
Wu <i>et al.</i> 1983, Cryogenics.	Ying-Tao <i>et al.</i> 2002, Chinese Physics.
Turner <i>et al.</i> 2004, Journal of Heat Transfer.	
Yuan <i>et al.</i> 2016, Chinese Journal of Aeronautics.	Morini <i>et al.</i> 2009, Microfluid and Nanofluid.
Shen <i>et al.</i> 2006, Energy conversion and management.	Yang <i>et al.</i> 2012, Experimental Thermal and fluid science.

## EXPERIMENTAL SETUP AND NUMERICAL SIMULATIONS

### Experimental setup and microfabrication of the devices

Design of the samples for the study of major and minor losses:

Straight channels / Channels with bends

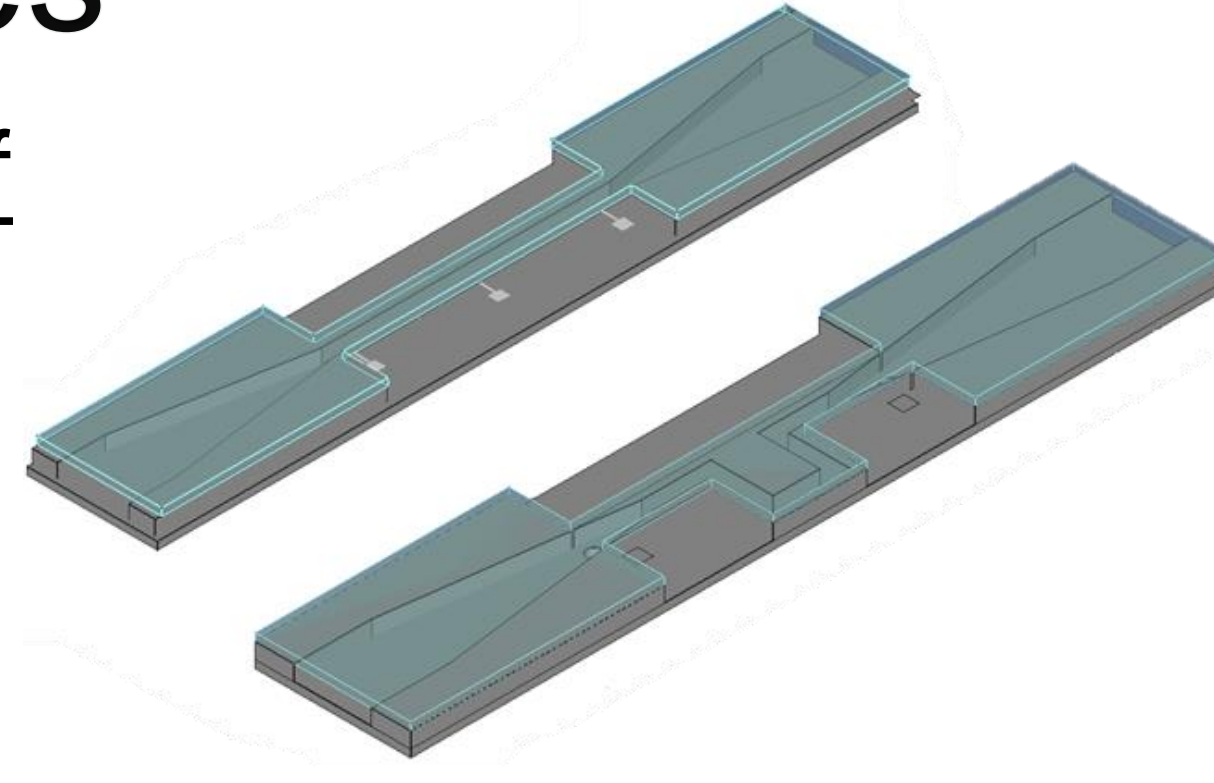

### Measurements:

- Pressure (inlet / outlet / inside the channel)
- Temperature (inlet / outlet / inside the channel)

➢ Mass flow sensor

➢ Velocity

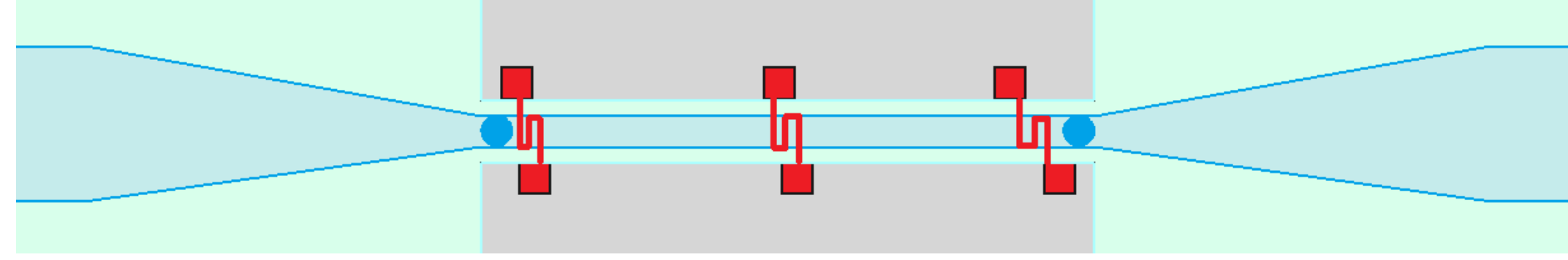

### Adaptation section part ①:

- Devices connected to microchannels
- Adapt square/rectangular cross-section to circular cross-section

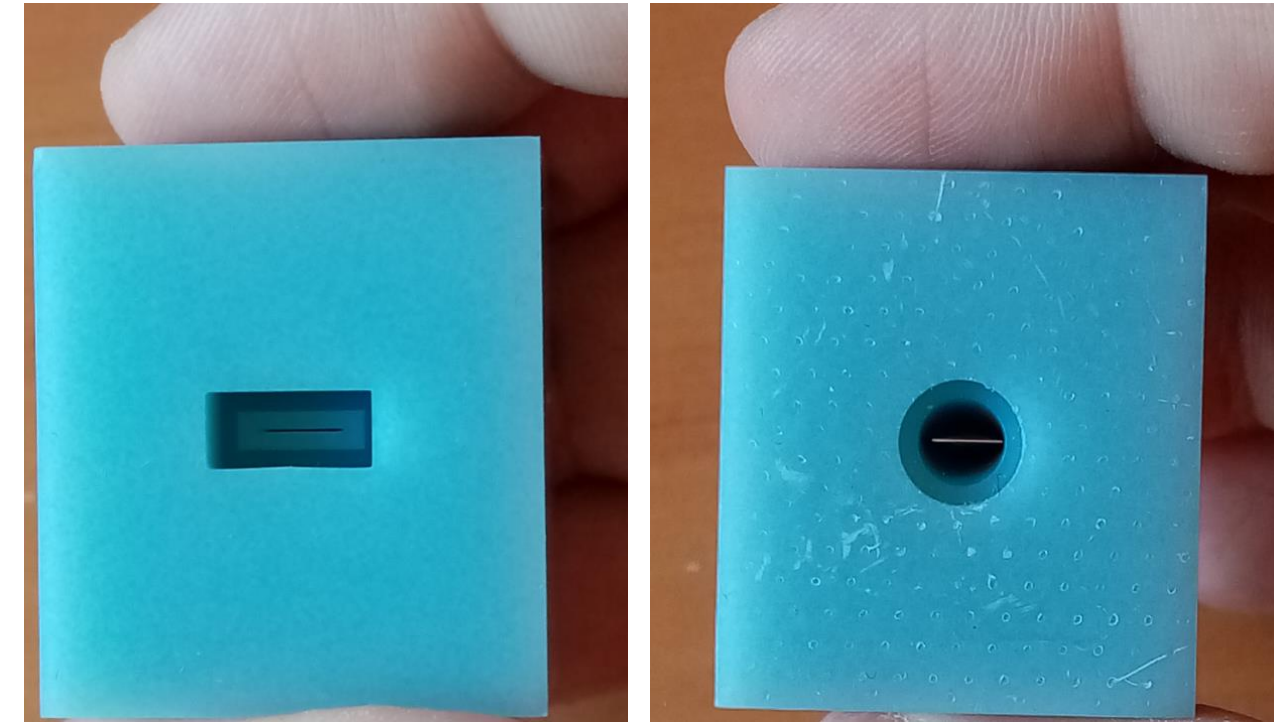

### Microfabrication :

#### Fabrication of the channel

→ Etching on the whole wafer

#### Sensors

- Platinum sensor : Platinum deposition
- Membrane fabrication : Etching and deposition of PDMS
- Etching on back side → optical access

#### Assembly of the device

- Bonding of the Glass and top Silicium wafers
- Bonding of the top Silicium and bottom Silicium wafers

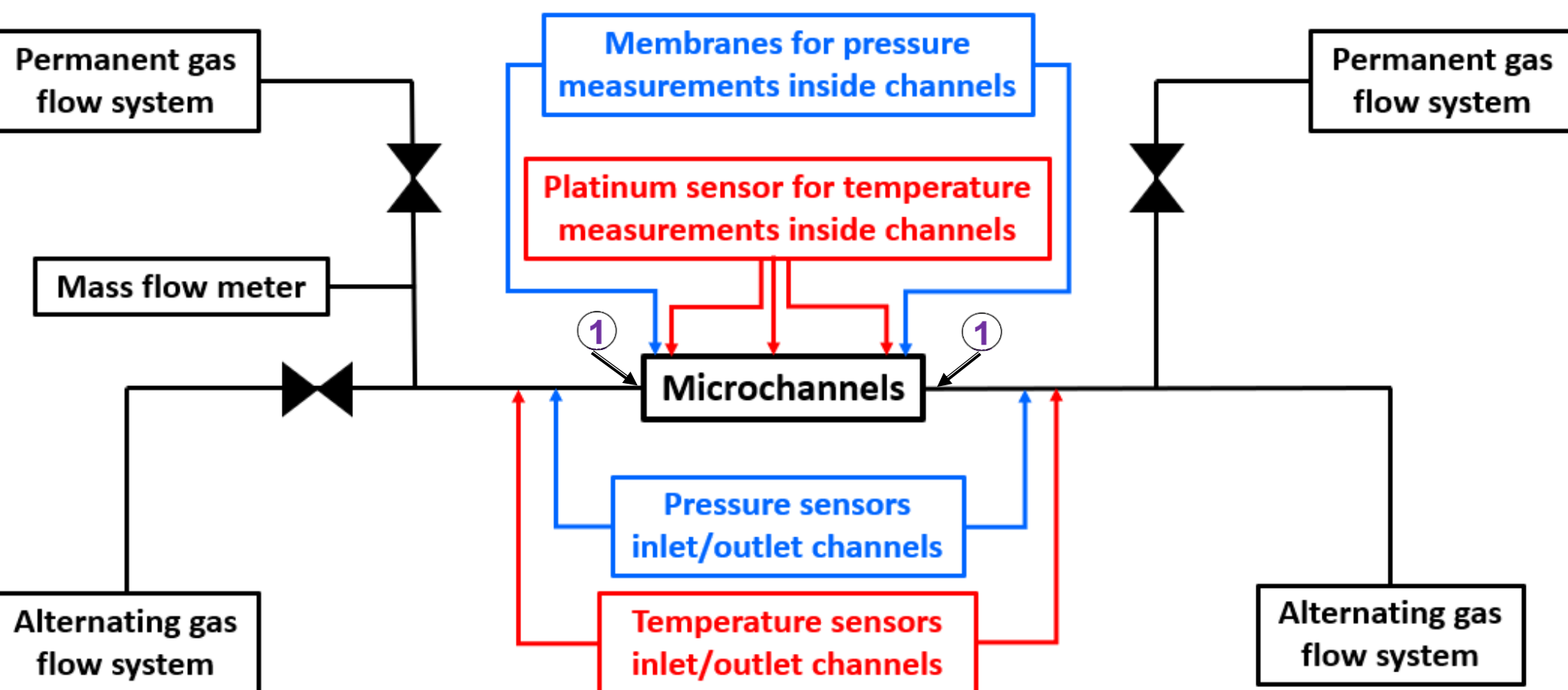
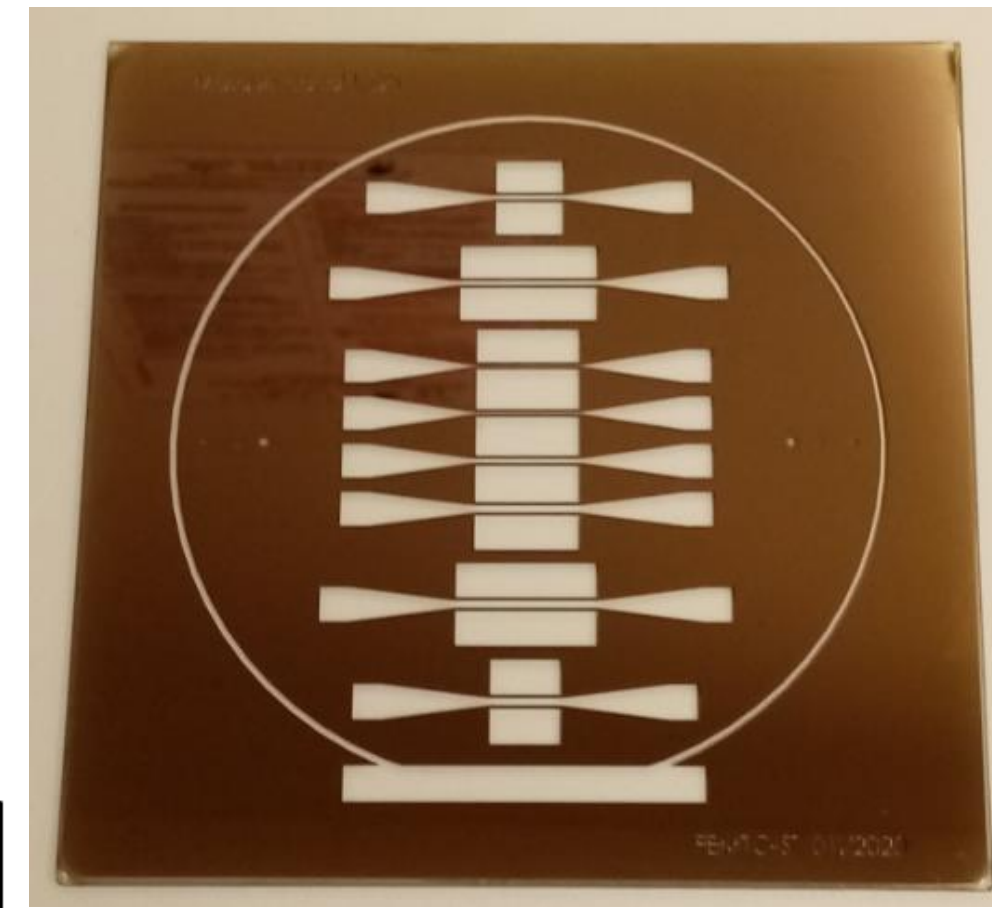
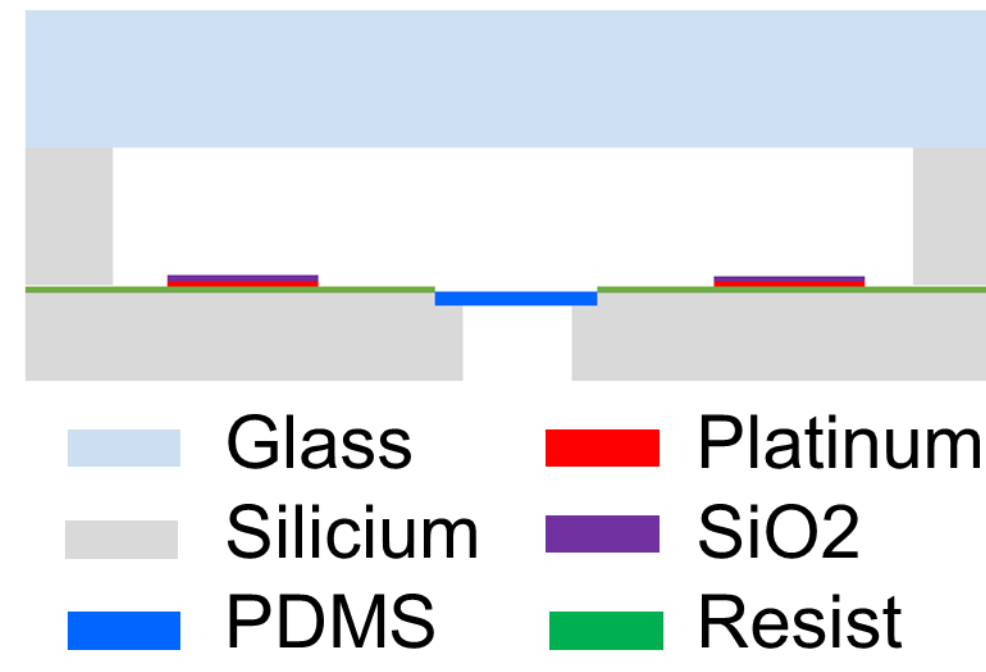

### Geometry and boundary conditions of simulation

Numerical simulation for microchannels and adaptation part with different  $D_h$   
→ With / Without temperature gradient between the channel's inlet and outlet

#### Boundary conditions:

- Inlet velocity and temperature (300K – 450K)
- Outlet pressure ( $P_{atm}$ ) and temperature (300K)
- Adiabatic wall

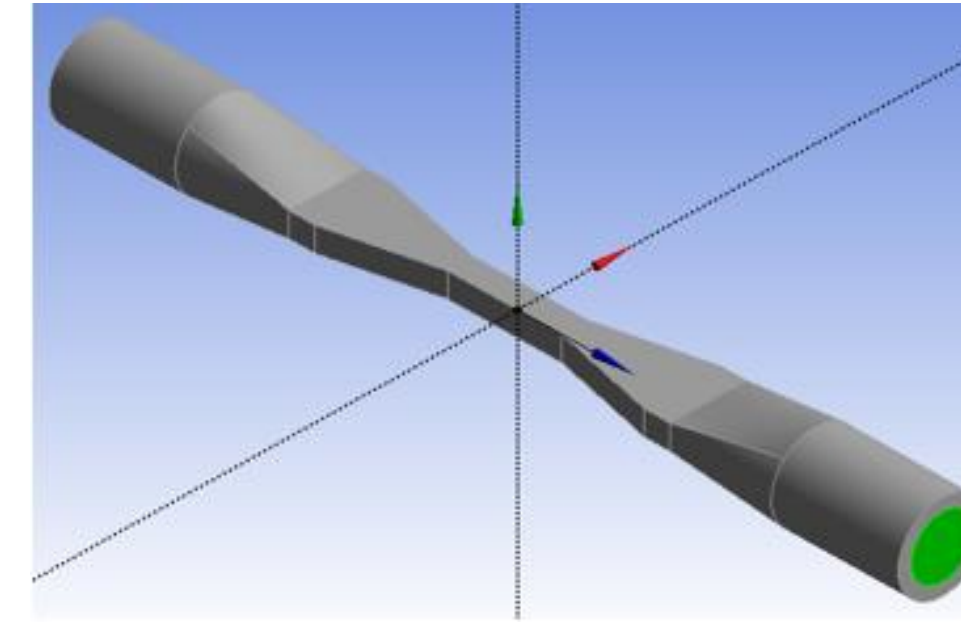

### Numerical results

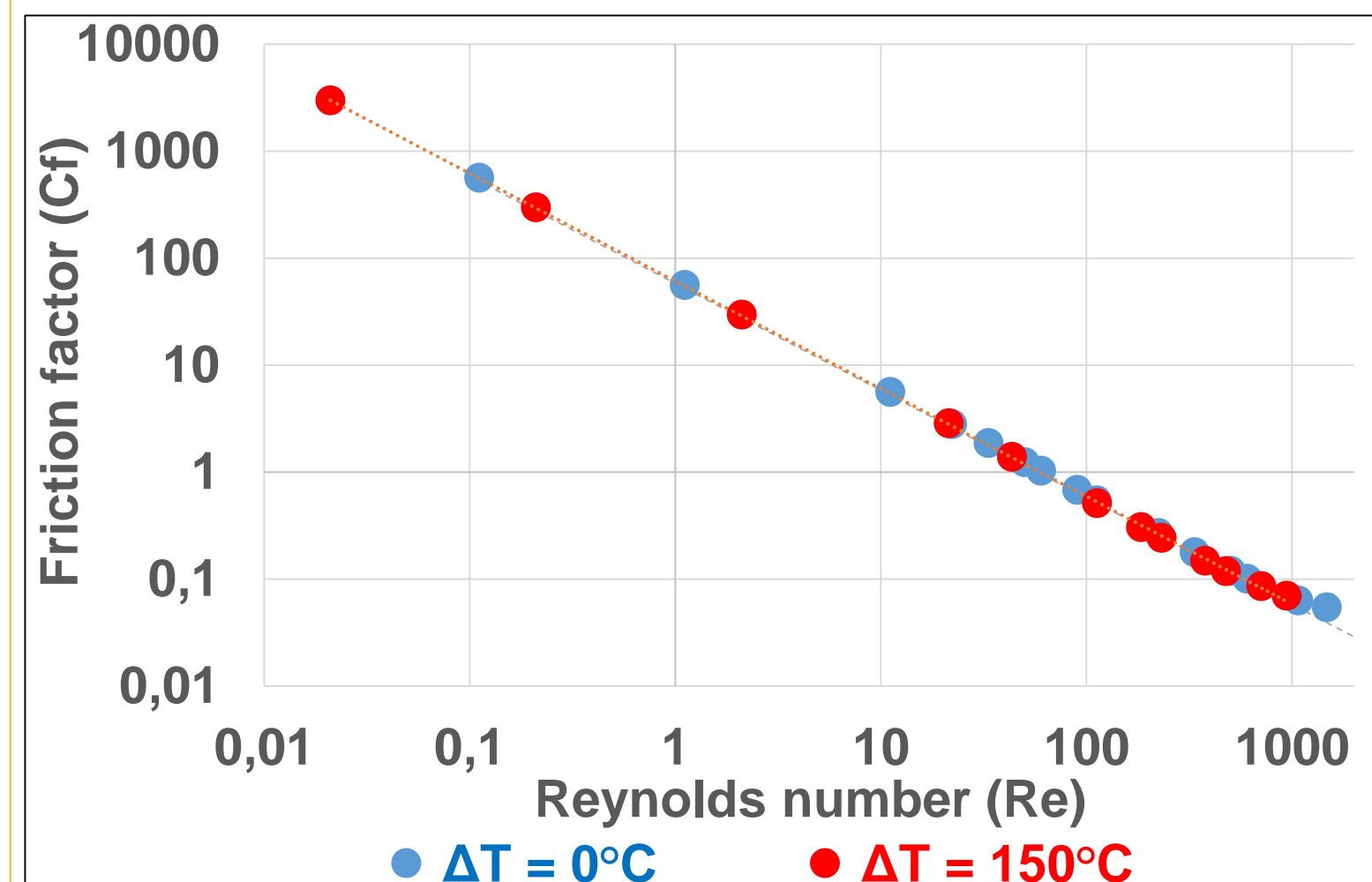
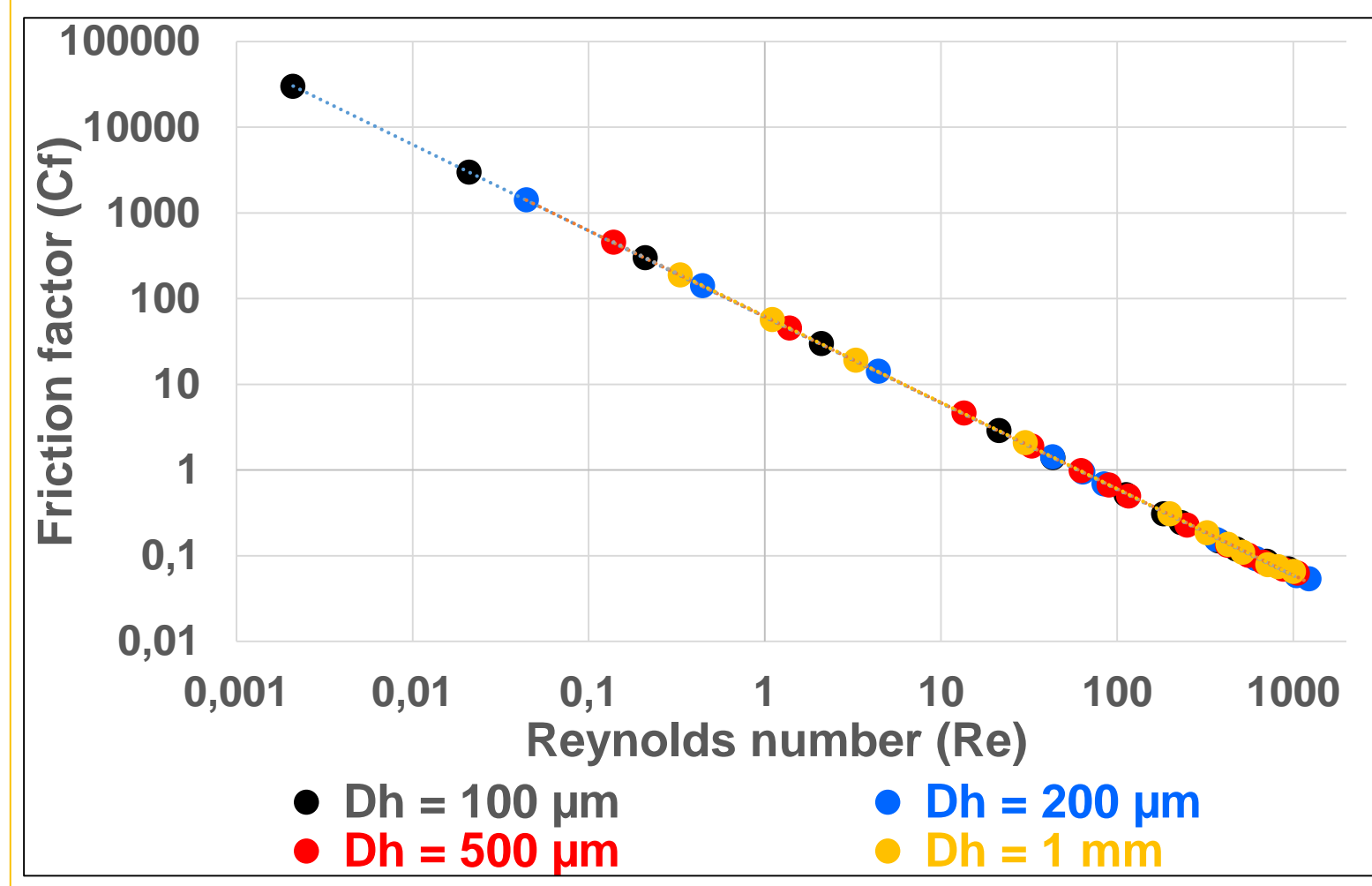
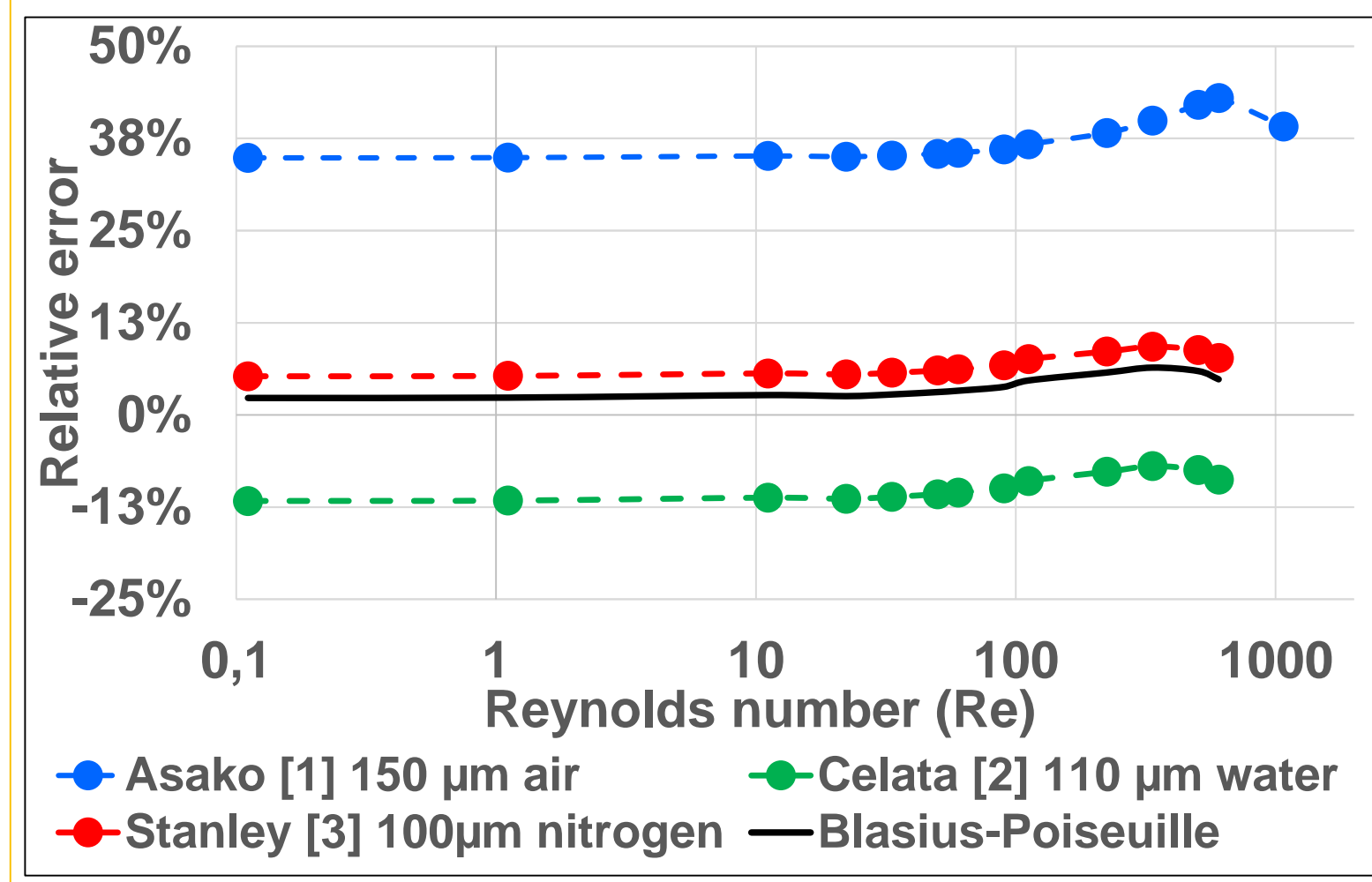

[1] Y. Asako, K. Nakayama, T. Shinozuka, 2005, International Journal of Heat and Mass Transfer.  
 [2] R.S. Stanley, 1997, Two-phase flow in microchannels, PhD, Louisiana Tech University.  
 [3] G.P. Celata, M. Lorenzini, G.L. Morini, G. Zumbo, 2009, International Journal of Heat and Fluid Flow.

## RESUME & PERSPECTIVES

### Resume

- ❑ Numerical results have been compared with experimental results from the literature:
  - Simulations results for different  $D_h$  show no significant influence of  $D_h$  on the friction factor
  - No significant influence of temperature gradient on friction factor
- ❑ Microdevices currently in fabrication

### Perspectives

- ❑ Experimental study of both permanent and alternate flows in microchannels
- ❑ Numerical investigation on the influence of bends on permanent and alternate flows
- ❑ Comparison between numerical and experimental results