



**HAL**  
open science

# Characterization of silicon vacancies and divacancies in hexagonal silicon carbide formed by nitrogen and aluminum ion implantation

Enora Marion Vuillermet, Nicolas Bercu, Florence Etienne, Mihai Lazar,  
Louis Giraudet

## ► To cite this version:

Enora Marion Vuillermet, Nicolas Bercu, Florence Etienne, Mihai Lazar, Louis Giraudet. Characterization of silicon vacancies and divacancies in hexagonal silicon carbide formed by nitrogen and aluminum ion implantation. C’Nano 2023: The Nanoscience meeting, Mar 2023, Poitiers, France. . hal-04171800

**HAL Id: hal-04171800**

**<https://hal.science/hal-04171800>**

Submitted on 26 Jul 2023

**HAL** is a multi-disciplinary open access archive for the deposit and dissemination of scientific research documents, whether they are published or not. The documents may come from teaching and research institutions in France or abroad, or from public or private research centers.

L’archive ouverte pluridisciplinaire **HAL**, est destinée au dépôt et à la diffusion de documents scientifiques de niveau recherche, publiés ou non, émanant des établissements d’enseignement et de recherche français ou étrangers, des laboratoires publics ou privés.



Distributed under a Creative Commons Attribution 4.0 International License

Enora Vuillermet<sup>1</sup>, Nicolas Bercu<sup>2</sup>, Florence Etienne<sup>2</sup>, Mihai Lazar<sup>1</sup>, Louis Giraudet<sup>2</sup>

<sup>1</sup>L2n, CNRS EMR 7004, University of Technology of Troyes, Troyes, France

<sup>2</sup>LRN, U.F.R Sciences exactes et naturelles, University of Reims Champagne-Ardenne, Reims, France

## Context and objectives

4H-SiC wafer and crystallography

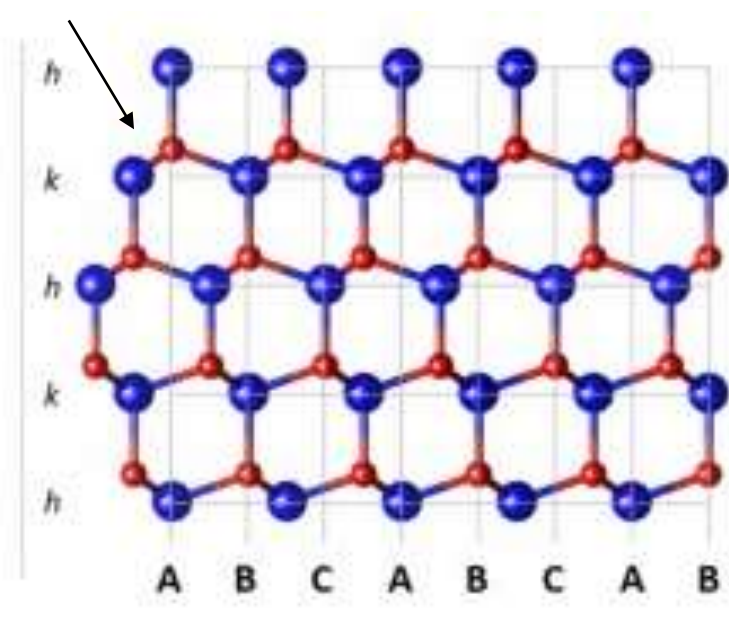

SiC is a **wide bandgap** semiconductor with :

- High thermal conductivity, chemical inertness and high critical electrical field [1]
- High technology maturity → control of defects possible [2]

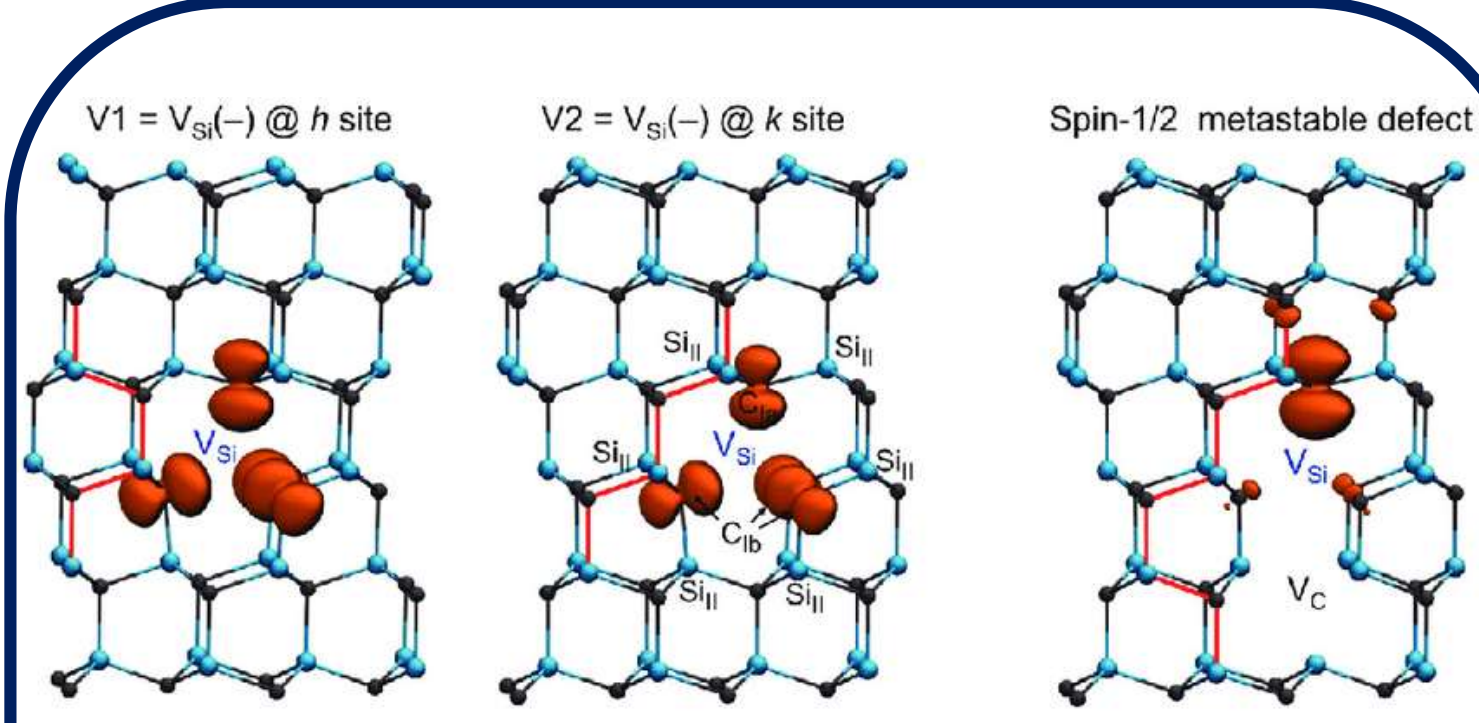

**Controlled generation of point defects** (color centers) in SiC

- Emission of NIR light
- Single quantum emitters : quantum applications [3]

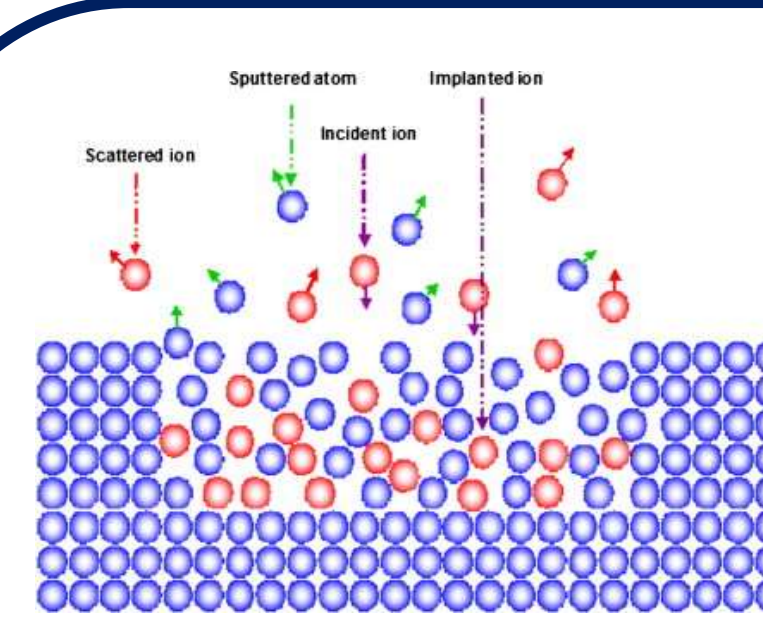

**Objective : Determination of the optimal ion implantation parameters to generate silicon vacancies ( $V_{Si}$ ) and di-vacancies ( $V_C V_{Si}$ ) in 4H-SiC**

Ion implantation allows :

- Simulations close from the experimental results
- A control of the point defects depth in the material
- Limited defects in the SiC matrix with well-controlled parameters
- Generation of color centers in **localized and large areas** [4]

## Materials and methods

### Ion implantation

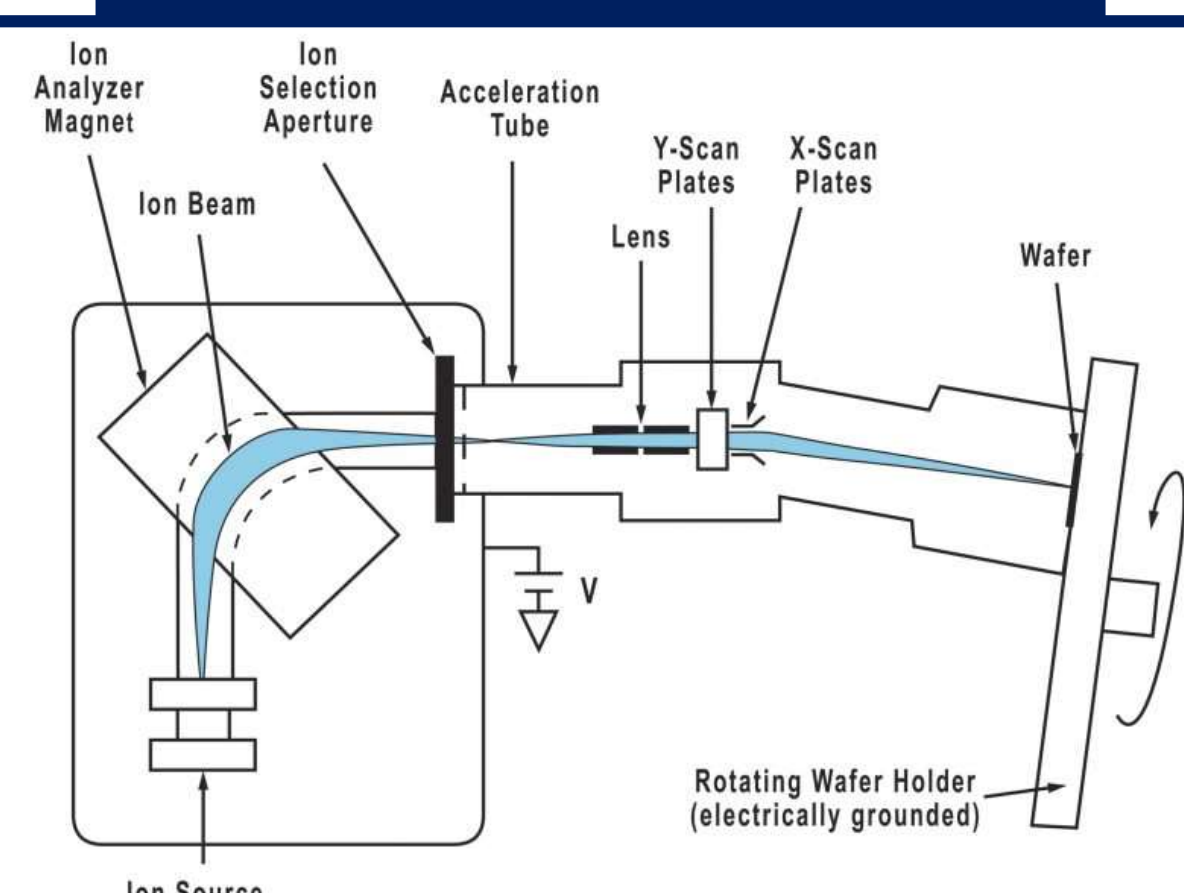

- **N or Al** implantations in 4H-SiC 10 $\mu$ m thick epilayer
- Temperature, dose and energy are changed
- Tilt and twist angles are 7 and 90° respectively

### Ion implantation simulations

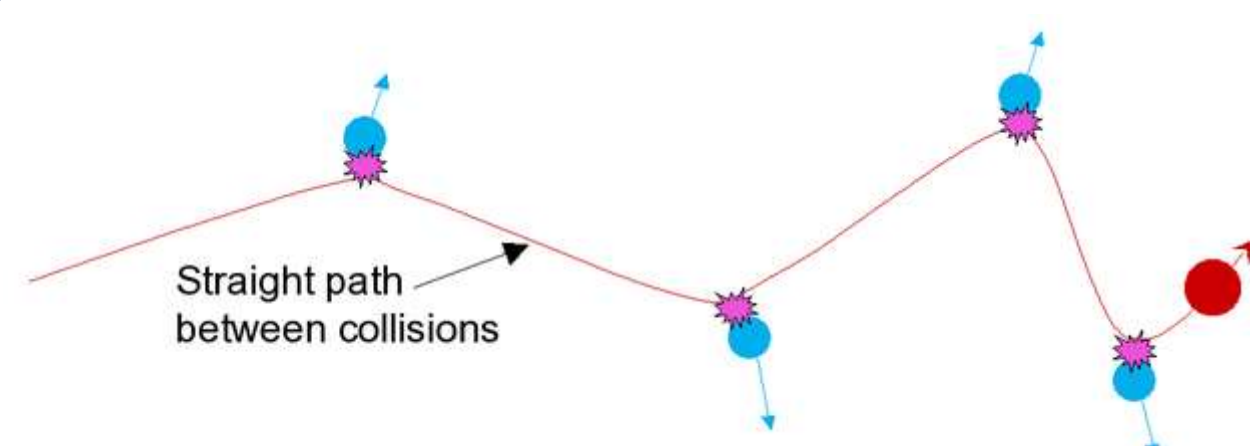

**I2SiC software** based on Montecarlo method and binary collision approximation (BCA) [5]

### Cathodoluminescence with JEOL SEM

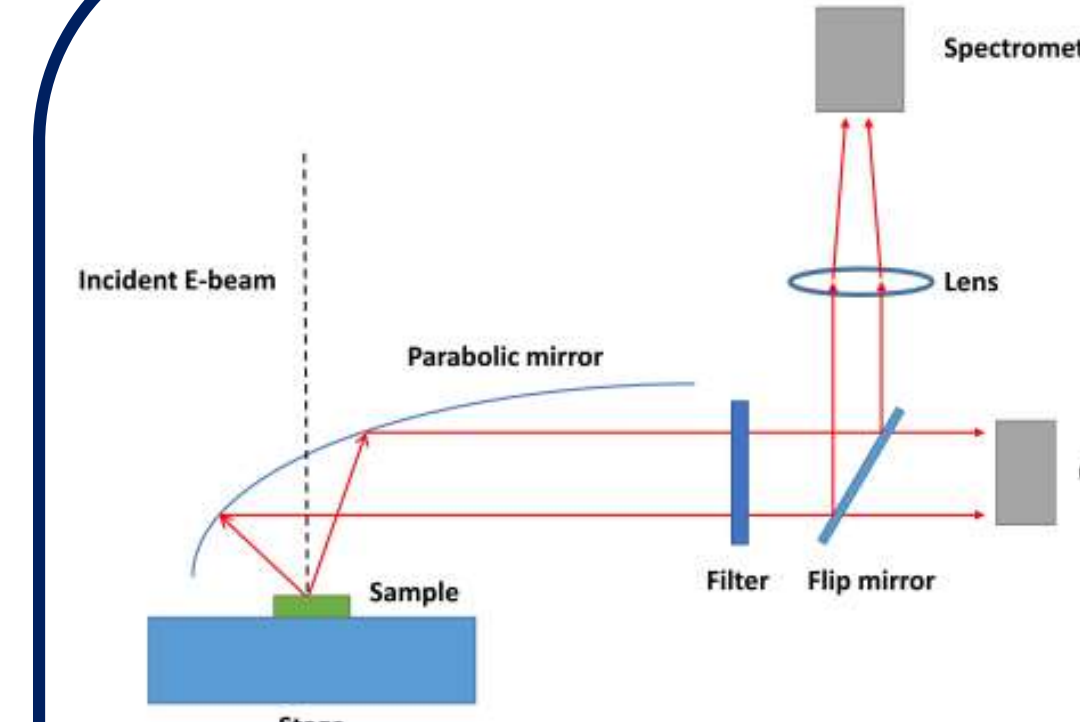

Realized before and after **annealing at 900°C** for 15min (80k, 302 l/mm, 15kV, 1nA)

## Results and Discussion

### I2SiC simulations

#### Implantations parameters

Name	Dopant	Temperature [°C]	Energy [keV]	Dose [cm <sup>-2</sup> ]
A2	N15	RT	400	6.4E14
			270	4.6E14
			170	4E14
			100	3.8E14
Total: 1.88E15				
A6	N	RT	400	3.2E12
			270	2.3E12
			170	2E12
			100	1.9E12
Total: 9.4E12				
A9	Al	RT	300	5.93E12
			190	2.9E12
			115	2.08E12
			60	1.42E12
			25	6.81E11
Total: 1.3E13				
A12	N	RT	190	5.6E12
			135	3.6E12
			90	3.4E12
			50	3.2E12
			40	2.2E12
			30	2.2E12
Total: 1.8E13				
A16	N	300	160	5E14
			110	2.8E14
			70	2.5E14
			40	1.8E14
			30	1.3E14
			20	2.2E12
Total: 1.34E15				
A17	N	400	190	1.5E15
			135	9E14
			90	9E14
			50	8E14
			20	1.3E15
Total: 5.4E15				
A23	NA	NA	NA	NA

#### Simulated $V_{Si}$ depth profiles

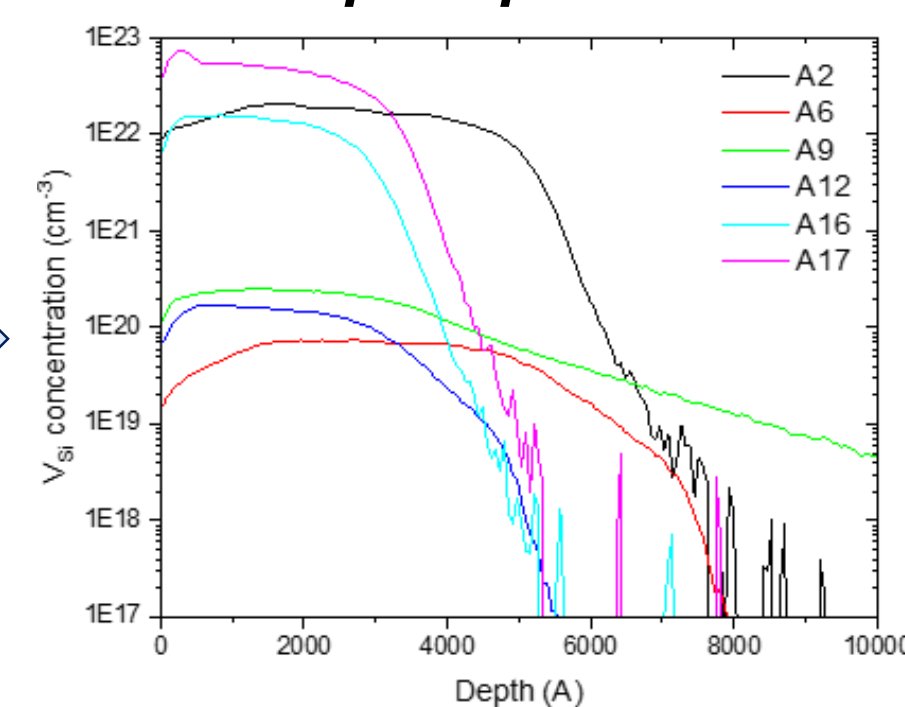

- Higher implantation energy leads to a deeper generation of  $V_{Si}$
- Higher implanted dose leads to a higher concentration of  $V_{Si}$

## Conclusion

- Implantation of 4H-SiC samples realized
- Simulation of implantations realized to see  $V_{Si}$  depth profiles
- Cathodoluminescence measurements are obtained
  - Before annealing :  $V_{Si}$  concentration maximal for high energy, low dose N-implantation at RT
  - After annealing :  $V_{Si}$  concentration maximal for high energy, high dose N-implantation at RT and the concentration of  $V_C V_{Si}$  is proportional to the concentration of  $V_{Si}$

## References

- [1] She, X et al. *IEEE Trans. Ind. Electron.* **2017**, *64*, 8193–8205
- [2] Maximilians, J. *PhD thesis, Universität Würzburg, Germany*, **2015**
- [3] Castelletto, S et al. *J. Phys. Photonics* **2020**, *2*, 022001
- [4] Hallén, A et al. *Surf. Coat. Technol.* **2016**, *306*, 190–193
- [5] Morvan, E. *PhD thesis, Institut National des Sciences Appliquées de Lyon, France*, **1999**
- [6] Castelletto, S et al. *Nanomaterials* **2021**, *11*, 72

### Before Annealing

Normalized CL spectra

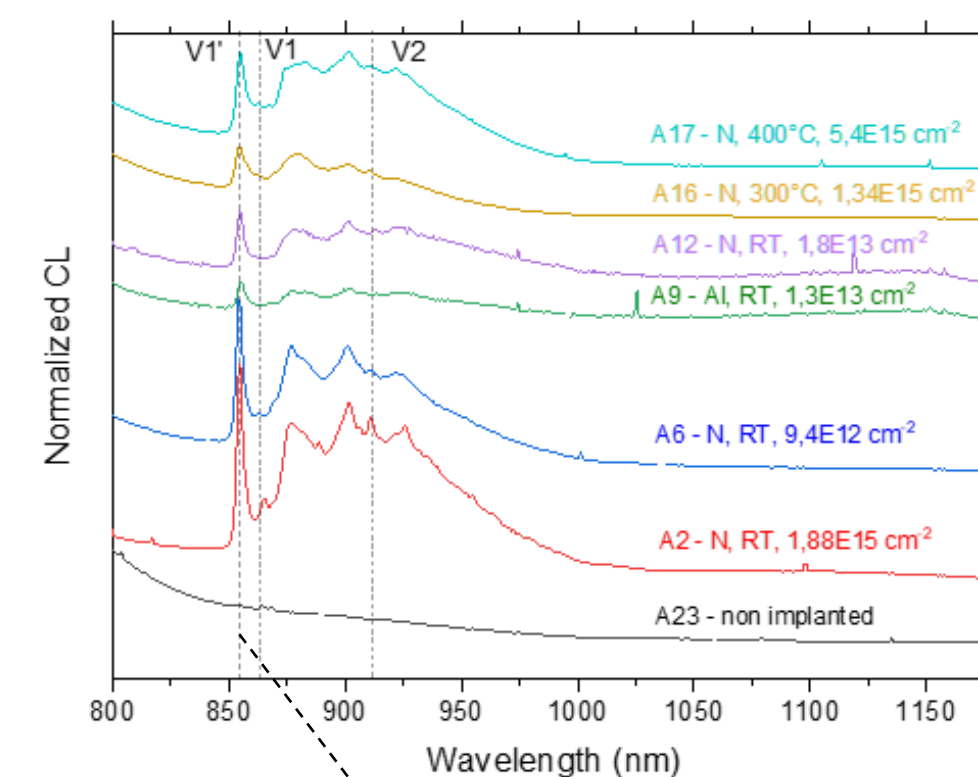

Relative intensity of CL peaks

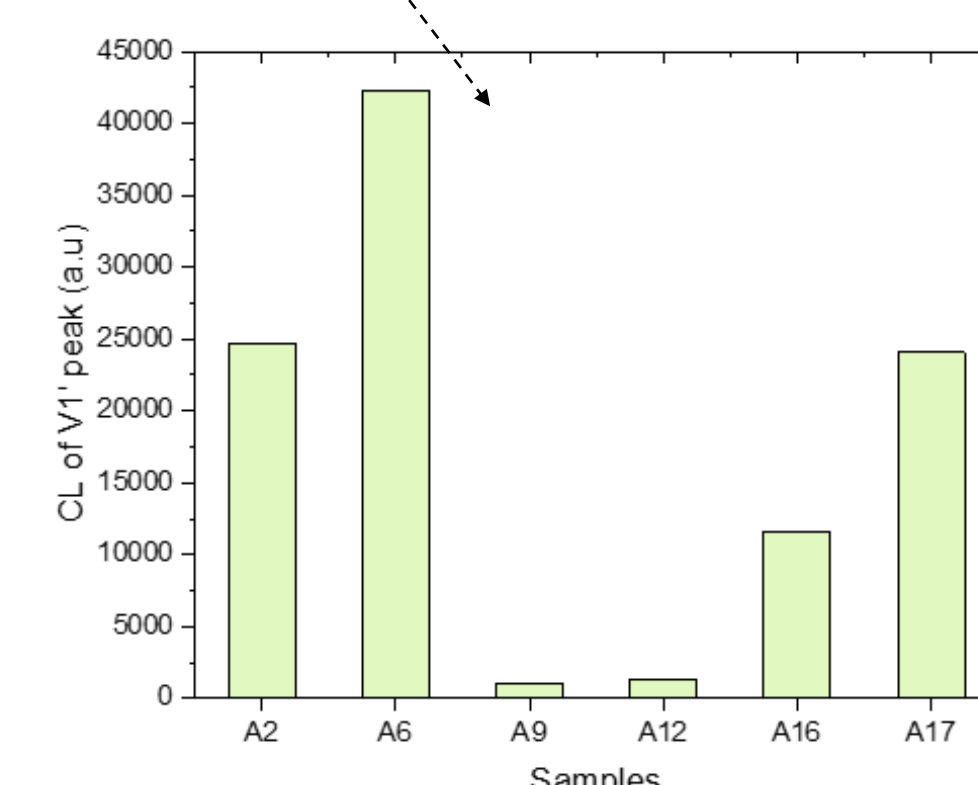

### After annealing at 900°C for 15min

Normalized CL

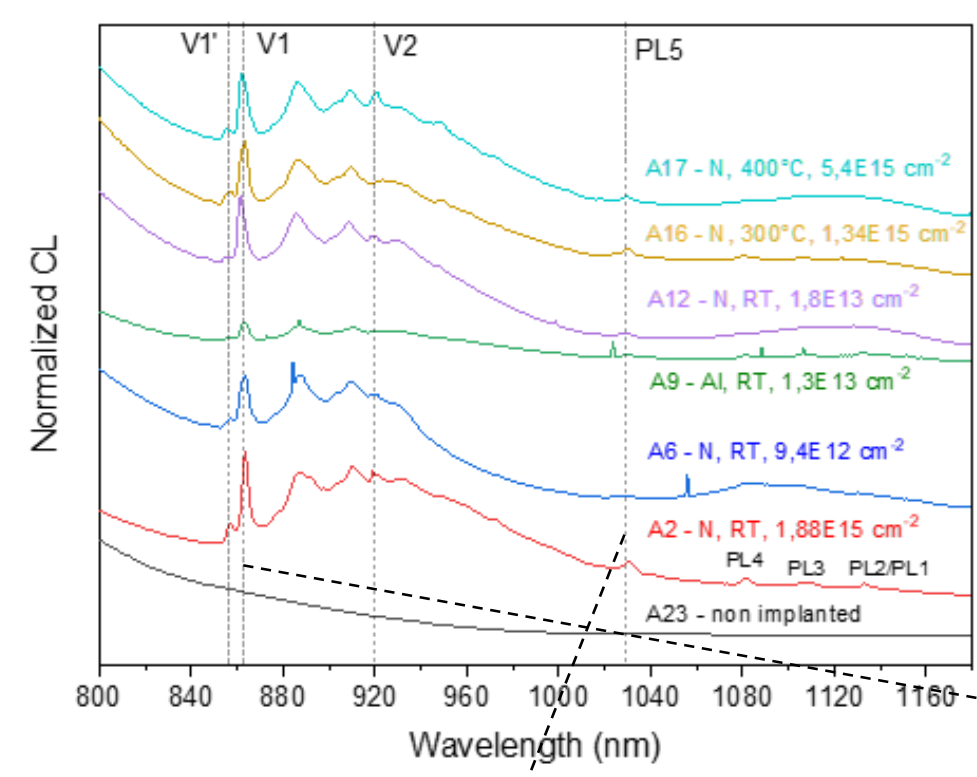

Relative intensity of CL peaks

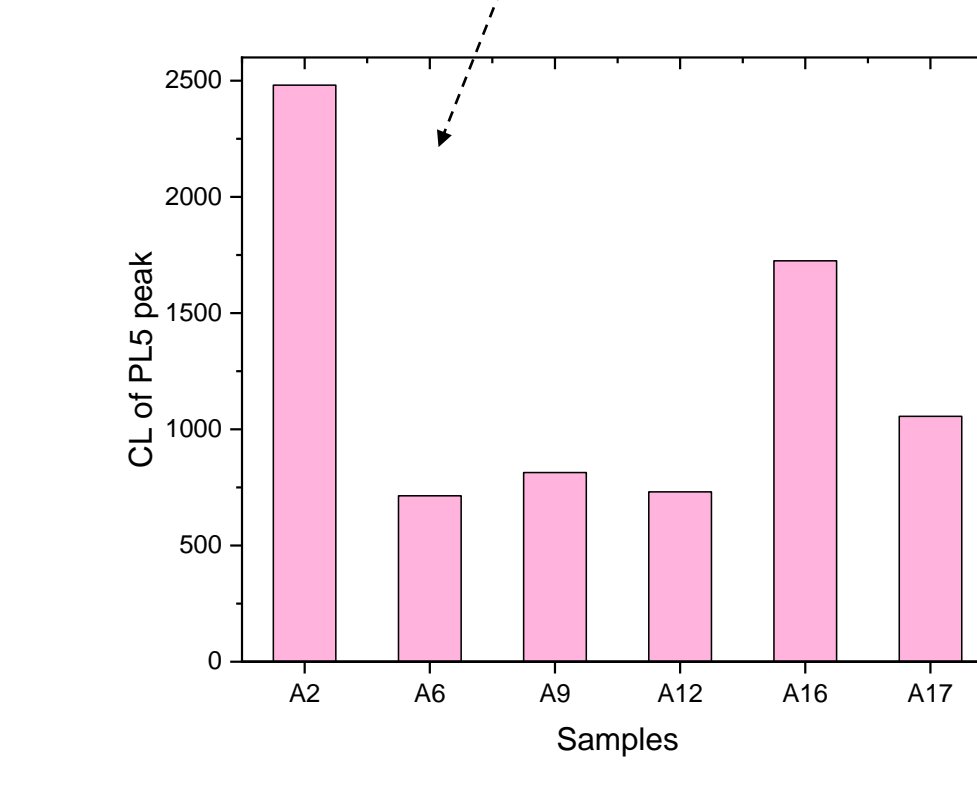

- V1' configuration favored before annealing and V1 configuration favored after annealing at 900°C for 15min.
- Concentration of  $V_C V_{Si}$  proportional to the concentration of  $V_{Si}$  in V1 configuration after annealing.
- Presence of 6H-SiC inclusions in stacking faults produced during ion implantations (PL5 peak) [6]
- Al implantation decreases the  $V_{Si}$  and  $V_C V_{Si}$  concentrations

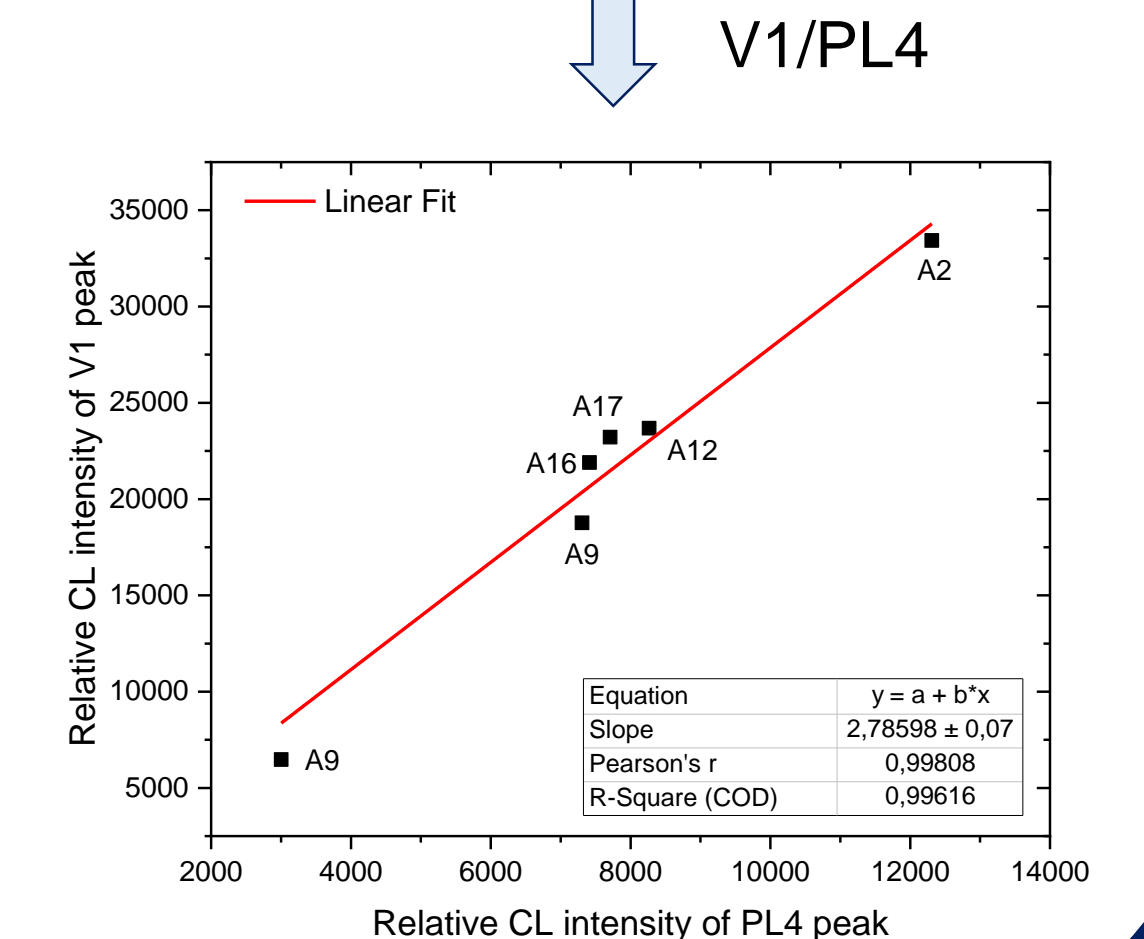

## Acknowledgements

Samples have been ion implanted at Pprime Institut (LMP) Potiers, IJCLab (CSNSM) Orsay and IP2I (IPNL) Lyon.

The authors acknowledge the use of resources from the Nanomat platform which is a part of the Renatech platform and is supported by the Ministère de l'Enseignement Supérieur et de la Recherche, the Région Grand Est, and FEDER funds from the European Community