



HAL
open science

WUBBLE: Energy Efficient BLE Neighborhood Discovery Leveraging Wake-up Radio

Nour El Hoda Djidi, Damien Wohwe Sambo, Matthieu Gautier, Olivier
Berder, Nathalie Mitton

► **To cite this version:**

Nour El Hoda Djidi, Damien Wohwe Sambo, Matthieu Gautier, Olivier Berder, Nathalie Mitton. WUBBLE: Energy Efficient BLE Neighborhood Discovery Leveraging Wake-up Radio. *Algorithmics of Wireless Networks*, 19th International Symposium on Algorithmics of Wireless Networks (ALGOWIN 2023), Sep 2023, Amsterdam, Netherlands. hal-04170115v2

HAL Id: hal-04170115

<https://hal.science/hal-04170115v2>

Submitted on 31 Aug 2023

HAL is a multi-disciplinary open access archive for the deposit and dissemination of scientific research documents, whether they are published or not. The documents may come from teaching and research institutions in France or abroad, or from public or private research centers.

L'archive ouverte pluridisciplinaire **HAL**, est destinée au dépôt et à la diffusion de documents scientifiques de niveau recherche, publiés ou non, émanant des établissements d'enseignement et de recherche français ou étrangers, des laboratoires publics ou privés.



Distributed under a Creative Commons Attribution 4.0 International License

WUBBLE: Energy Efficient BLE Neighborhood Discovery Leveraging Wake-up Radio

Nour El Hoda Djidi¹[0000-0003-2087-1527], Damien Wohwe Sambo²[0000-0003-0599-7535], Matthieu Gautier¹[0000-0003-4008-749X], Olivier Berder¹[0000-0002-3792-400X], and Nathalie Mitton²[0000-0002-8817-6275]

¹ Univ Rennes, CNRS, IRISA, Lannion, France

{nour-el-hoda.djidi, matthieu.gautier, olivier.berder}@irisa.fr

² FUN team, INRIA, Lille, France

{damien.wohwe-sambo, nathalie.mitton}@inria.fr

Abstract. In wireless sensor networks, much energy is wasted during connecting and control processes. This is particularly true for the neighborhood discovery process carried out in Bluetooth Low Energy (BLE) before the communications between devices. However, the fixed duration of this process has a critical energy cost when the number of neighbors is low or when only a few neighbors are required by the application. In order to address this issue, a novel protocol called WUBBLE is proposed to leverage wake-up radio technology to start and end the discovery process. Wake-up radio enables additional communications between devices with an ultra-low energy overhead. WUBBLE is validated by combining analytical analysis and experimental measurements, and results show that half of the energy could be gained to discover 90% of the neighbors.

Keywords: BLE · Wake-up radio · MAC protocols · Wireless Sensor Networks.

1 Introduction

Wireless connected devices are strongly energy-constrained as most use batteries for powering. Recent studies reveal that the Bluetooth Low Energy (BLE) [1, 2] gives a good trade-off between energy efficiency and Quality of Service (QoS) for applications that do not especially need long-range communications [9]. However, before establishing a BLE connection between two devices, an initial contact must be initiated between them. The find-out process between devices is known as Neighbor Discovery Process (NDP) and needs additional energy before the beginning of a transmission. The NDP is the primary operation before any operation (data transmission). Indeed, in a usual way, the BLE communications occur in a master/slave manner. A successful neighbor discovery happens when at least two BLE devices discover each other during the discovery phase. The device which sends data during the NDP is the advertiser, whereas the node that receives the advertisements is the scanner.

Two kinds of advertising are possible. Direct advertising occurs only for already known devices (a successful NDP has already occurred before), whereas

undirected advertising is related to unknown devices which want to discover each other. For the latter, the NDP can either be through a connectable or a non-connectable mode. For a connectable discovery, a master/slave connection is established between the two devices so that the scanner can reply to the advertiser after the reception of an advertisement. However, in a non-connectable discovery, the advertiser does not introduce a connection request during the advertising. Thus, the scanner will only receive advertisements without being able to interact with the advertiser [12, 17]. Meanwhile, using a battery as a power supply involves a limited lifetime for the BLE device. To extend their lifespan, sensor nodes need to use their energy efficiently. Thus, recent techniques that aim to reduce the energy consumption during NDP of the BLE are widely used in the literature [8, 18].

In order to allow synchronization between the advertisers and the scanner, the proposed approach leverages ultra-low power radio receivers called Wake-up Receivers (WuRs) [13]. The use of a secondary WuR allows to let the primary BLE transceiver into sleep mode most of the time as it continuously listens to the wireless channel while consuming a few microwatts. Thanks to our previous works, the wake-up latency can be greatly reduced with negligible energy consumption [3, 4]. The Protocol overhead is then reduced since the main BLE transceiver wakes up only when the WuR receives a specific signal called Wake-Up Beacon (WUB).

This paper proposes a novel approach called WUBBLE to reduce the NDP energy cost by using two different kinds of Wake-Up Beacons (WUB). The proposed approach helps to reduce the energy consumption to the number of neighbors to discover during this process and is suitable for non-connectable undirected advertising. The scanner sends the first WUB to initialize the NDP while the second WUB is sent to stop the transmission of advertisements. Furthermore, to reduce collisions, a random backoff delay is added before the transmission of an advertisement by the advertiser. For evaluating and validating our approach, we propose an energy model based on real measurements, and we extend the results with intensive simulations.

The rest of the paper is organized as follows: related works are discussed in Section 2 while Section 3 gives more details on our proposed discovery solution. The experiments and the validation of the proposal are given in Section 4. The conclusion and future directions are provided in Section 5.

2 Background and related works

Several researchers proposed techniques and solutions that aim to reduce the energy consumed during NDP.

Wei et al. [19] proposed a novel deterministic and one-way NDP. To reduce the discovery delay, the authors assumed that there are only a few active slots in each period, and the remaining time is for the sleep slot. Thus, according to a duty cycle, the proposal can find the best periods to achieve the NDP. In [7], the authors proposed a mathematical analysis of a few NDP parameters to reduce

NDP delay. However, they assumed in their analysis that an advertising event and a scan window have the same length, which cannot be confirmed in real life. In the same way, Shan et al. [17] focused on minimizing the advertisement interval. They show that it should be a multiple of 0.625 ms and be taken from 20 ms to 10.24 s for an advertisement delay taken in [0-10] ms. An advanced study of optimizing the NDP parameters according to IoT application is conducted by Luo et al. [11]. Contrary to previous probabilistic solutions, the proposed solution is based on the Chinese remainder theorem to find the optimal NDP delay and the related average energy consumption. More recent works aim to evaluate and improve the advanced NDP introduced in Bluetooth 5 by finding the trade-off between reducing collisions and minimizing energy consumption [15, 16, 18].

Many works proposed to couple a low-power WuR with BLE to explore its benefits. Giovanelli et al. proposed in [6] to integrate the WuR in the BLE protocol stack. They defined two scenarios, connection-oriented and broadcast oriented. In connection-oriented, the trigger from the WuR is used to change from non-connectable to connectable advertising when nodes need to be connected. With broadcast oriented, the scanner uses WuR to wake up the nodes before sending a broadcast packet. The authors claim their protocol obtains better latency and energy consumption than the regular BLE. However, no experimental evaluation was performed. Sanchez [10] demonstrated that WuR-based BLE outperforms the classic BLE solution for low packet rate. However, they considered only two nodes. Mikhaylov et al. [14] also evaluated that the WuR-based BLE performs better than the traditional BLE solution if the maximum data delivery tolerable by the application does not exceed 21 s. The authors did not consider scalability and collisions between nodes. Furthermore, the advertisement could be repeated many times, and no process to stop advertising was proposed.

Contrary to the previous works and to the best of our knowledge, there are no works that combine WuR and BLE to dynamically adapt the advertising duration, while being energy efficient. Thus, the solution we propose and which is described in Section 3 constitutes a novel contribution.

3 WUBBLE protocol

3.1 Problem statement

Reducing the energy of NDP is very challenging because it has to find the best trade-off between energy consumption and QoS. Knowing that devices must be in sleep mode most of the time to save their energy, the additional WuR allows synchronization before the beginning of the NDP as proposed in [14]. However, the duration of NDP is fixed, and NDP remains active even if all or at least the desired number of nodes have been discovered. In the next part, the WUBBLE approach is introduced. It minimizes the duration of the NDP according to the desired number of nodes to discover.

3.2 Network scenario and protocol concept

The scenario in which a new node arrives in a network of N nodes and wants to discover its neighbors is considered. It may need to discover K nodes ($K \leq N$) in its BLE and WuR communication ranges. Hence, each node embeds a BLE module and a WuR.

Fig. 1 shows the timeline of the proposed protocol. The new node (the scanner) starts by sending a WUB that is called $Wubb$ (WUB begin) that requests neighbors to begin advertising. Upon the reception of the $Wubb$ by the advertisers, the WuR of each advertiser sends an interrupt to wake up the main node in order to start advertising with the BLE. Each node waits for a random backoff between 0 and 30 ms before starting advertising to limit collisions.

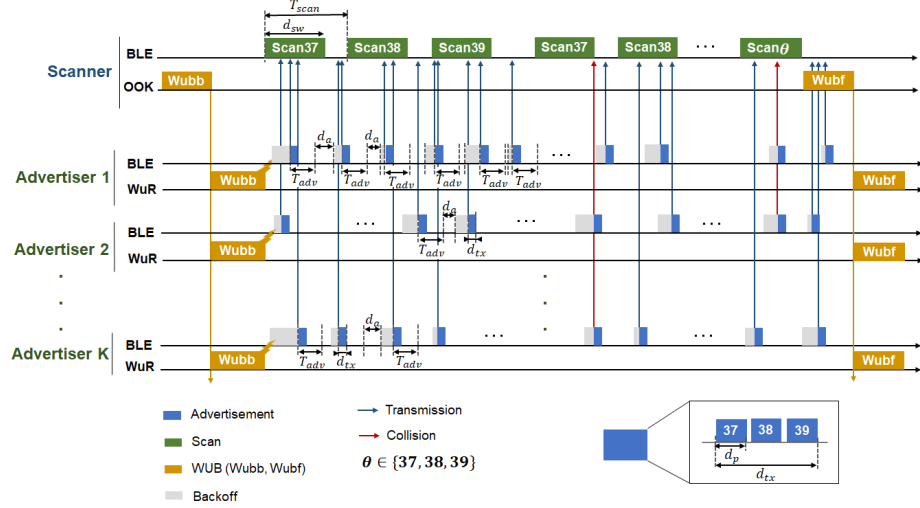

Fig. 1: WUBBLE: Neighborhood discovery protocol based on WUB ($Wubb$ and $Wubf$).

Among the 40 BLE channels (numbered from 0 to 39), only 3 channels (37, 38 and 39) are used for NDP. Each advertiser broadcasts messages repeatedly (every advertisement interval T_{adv} plus random advertisement delay d_a) over these three advertisement channels. As well as in [17], the advertisement interval is set between 20 ms and 10.24 s; the advertisement delay is a random value in the range of 0 to 10 ms. During the discovery process, the scanner node periodically scans each of the three advertisement channels at every scan interval T_{scan} and listens for advertisements during the scan windows d_{sw} .

Traditionally, in connectionless BLE, the advertisers periodically send advertisements many times even if the scanner has discovered the K required nodes because no acknowledgment process that will waste energy is used. To overcome this issue, the WUBBLE protocol is proposed. When the scanner receives the K

required node advertisements, it stops scanning and sends a WUB called *Wubf* (WUB finish) to inform advertisers to stop advertising. The *Wubf* has a different format than *Wubb*; thus, the WuR can make the difference between them. When an advertiser receives *Wubf*, its WuR sends an interruption to the main node to stop advertising. Thus, WUBBLE minimizes the time required for advertising in order to save energy by reducing the discovery delay. Furthermore, WUBBLE does not change the basic parameters of the NDP; thus, it can perfectly work with any existing version of the BLE [1, 2].

3.3 Collisions probability model

Within a network with several advertisers and at least one scanner, some advertisers likely attempt to simultaneously communicate with a scanner in the same channel. In such cases, packet collisions are unavoidable, and the collision probability will follow the Poisson distribution. This probability has been previously approximated in [5] by (1). λ denotes the packet transmission rate.

$$p_c = 1 - e^{-2N\lambda d_p}, \quad \text{with } \lambda = \frac{1}{(T_{adv} + d_a)} \quad (1)$$

3.4 Energy model

To evaluate the energy consumption of both BLE and WUBBLE, we consider the average energy consumed by the advertiser. The energy consumption of the scanner is not considered, as it is about the same when using either BLE or WUBBLE, except for a slight increase of energy to transmit the two WUBs. This additional energy can be neglected because the transmission times of the WUBs are minimal compared to the scan duration. Thus, the average energy consumption is evaluated for N_f time slots, and each advertisement occurs in a one-time slot. In the basic BLE protocol, when the node starts advertising, it will periodically send the advertisements until the end of a fixed number of time slots N_s . The energy consumed by the advertiser node while using BLE is E_{ble} :

$$E_{ble} = \tau_s(T_{adv} + d_a)P_{idl} + \tau_s d_{tx} P_{tx} + (\tau_f - \tau_s)(T_{adv} + d_a)P_s + E_{in}, \quad (2)$$

with P_{idl} , P_{tx} and P_s the idle, transmission, and sleep power consumption, respectively. d_{tx} is the transmission duration and E_{in} gives the energy consumption during BLE initialisation. It corresponds to the energy consumed when the node wakes up from deep sleep and initializes its BLE module.

Using WUBBLE, the node keeps advertising until it receives a *Wubf* from the scanner. Therefore, it will send advertisements for N_s^o time slots ($N_s^o \leq N_s$) that is the minimal number of time slots that meets the requirements of discovering K needed nodes. The energy consumption E_{wubble} of the advertiser node when using WUBBLE is expressed as:

$$E_{wubble} = \tau_s^o(T_{adv} + d_a)P_{idl} + \tau_s^o d_{tx} P_{tx} + 2d_w P_{rx}^{wur} + E_{in} + (\tau_f - \tau_s^o)(T_{adv} + d_a)P_s + [\tau_f(T_{adv} + d_a) - 2d_w]P_{idl}^{wur}, \quad (3)$$

where P_{idl}^{wur} and P_{rx}^{wur} are respectively the power consumed by the WuR while monitoring and processing the signal in a channel. d_w denotes the WUB duration.

4 Evaluation

4.1 Experimental measurements

WUBBLE protocol has been implemented on real platforms in order to measure both the power consumption and the duration of each step of the protocol. The measured parameters are, for a second time, included in the energy models presented in Section 3.2.

Testbed Fig. 2 shows the experimental testbed. Only two nodes are considered, one as a scanner and the other as an advertiser. These two nodes are sufficient since we are interested in feeding the energy model with the experimental power consumption measurements. A Firebeetle from DFRobot is used for the BLE module, which contains the microcontroller ESP32. At the advertiser side, the WuR from [13] is used and is connected to the Firebeetle node to send an interrupt to either wake up the node or ask the node to stop advertising. On the scanner side, the b-L0722 LRWAN1 development board from STMicroelectronics is used to send the WUB with OOK modulation. It is connected to the Firebeetle that sends to it a command to send either *Wubb* or *Wubf*. *Wubb* contains the address 0x52 and *Wubf* contains the address 0x53. Once the WuR receives *Wubb*, it sends an interruption signal to the Firebeetle to wake up from its sleep state and start advertising. When the WuR receives a *Wubf*, it sends a different interrupt to the Firebeetle to stop advertising and return to sleep mode.

Micro-benchmark Fig. 3 presents the microbenchmark of the WUBBLE protocol. A N6705A DC power analyzer measured the current consumption of each node. All the steps of the protocol can be seen. The scanner starts by sending *Wubb* to wake up the advertiser and then starts scanning (BLE-Rx). Before opening the scan windows, there is a step of BLE initialization. At the advertiser side, the node wakes up after receiving the *Wubb* and starts advertising (BLE-Tx). When the scanner receives ten advertisements, it stops scanning and sends *Wubf* to ask the advertiser to stop advertising. The measured parameters are summarized in Table 1.

4.2 Simulation results

Simulation setup An NDP simulator at the medium access level has been implemented for both BLE and WUBBLE. The simulator instantiates N advertising nodes and assigns them the desired parameters, such as advertising interval and duration. Each node has a random initial backoff in the range [0-30] ms, after which it starts broadcasting its advertising packet. Each packet is

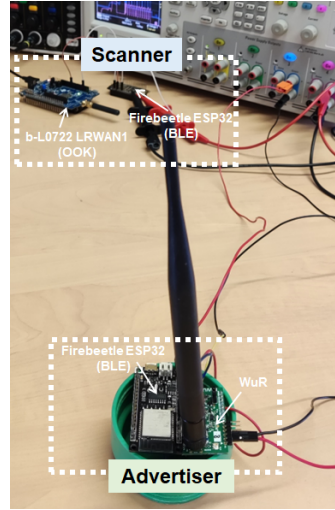

Fig. 2: Experimental testbed.

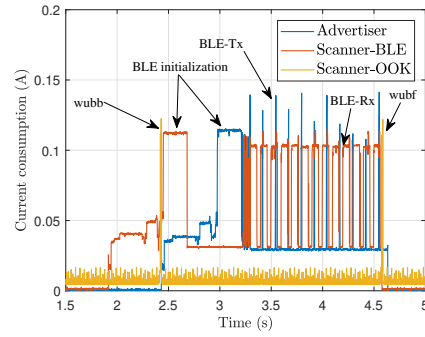

Fig. 3: Micro-benchmark of WUBBLE protocol.

Table 1: Measured power consumption and duration.

Param.	Value	Param.	Value	Param.	Value
d_{sw}	60 ms	P_{rx}^{wur}	284 μ W	P_s	0.39 mW
d_p	376 μ s	d_w	16 ms	τ_f	1000
d_{tx}	5.1 ms	T_{scan}	100 ms	P_{idl}^{wur}	1.83 μ W
P_{tx}	390 mW	T_{adv}	110 ms	E_{in}	145.26 mJ
P_{idl}	90 mW	d_a	[0–10] ms		

sent after $T_{adv} + d_a$. At the beginning of the simulation, the scanner starts the node discovery. A random delay in the range of [0–10] ms is added before each scan window to avoid desynchronization between the scanner and the advertiser.

When the scanner receives a non-colliding packet from the advertiser, it marks that node as discovered. If any advertised packets are overlapped, a collision occurs, and the scanner discards the packet. The simulation lasts for 1000 time slots and is repeated 1000 times. For the first time, to validate the simulator, the collision probability obtained by the simulator is compared with the analytical expression of (1).

Collision probability Fig. 4 summarizes the simulation and analytical results of the collision probability as a function of the number of nodes in the network w.r.t three values of the packet transmission rate. It can be seen that the simulation results fit the theoretical ones, which validates our simulation.

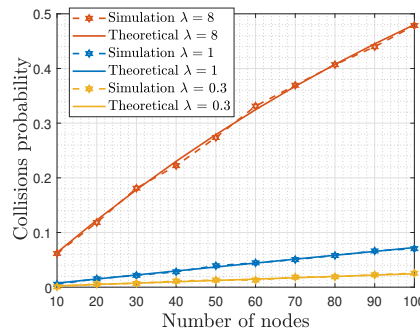

Fig. 4: Collision probability as a function of the number of nodes.

Time slot Fig. 5 shows the average time slot per node as a function of the number of nodes found w.r.t the number of nodes in the network. Three network sizes ($N = 50, 70, 100$) are considered. This average time slot represents the number of advertising per node required to discover K nodes by the scanner (N_s^o in (3)). Obviously, the more the scanner needs to discover nodes, the higher the time slot is. It can be seen that to discover all the nodes available (100%), fewer time slots are needed with a small network of $N=50$ compared to a big network with $N=100$. Furthermore, if $N_s=150$, the scanner is not able to discover all the N nodes available when $N \geq 70$.

Energy consumption Fig. 6 shows the average energy consumption per advertiser as a function of the number of nodes found, w.r.t BLE and WUBBLE protocols. For BLE, the energy consumption is estimated for three values of N_s (i.e. the fixed number of time slots to stop advertising) and, for each N_s , three network sizes ($N = 50, 70, 100$) are considered. With WUBBLE, the exact three network sizes are considered. In our proposed approach, the energy consumption

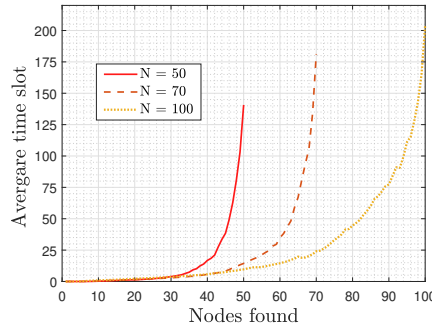

Fig. 5: Average time slots as a function of number of nodes found w.r.t number of nodes in the network.

depends on the number of nodes found. The more the scanner needs to discover nodes, the more the advertiser keeps advertising for many time slots, which consumes more energy. With BLE, the energy consumption does not depend on the number of nodes found but depends only on the N_s value.

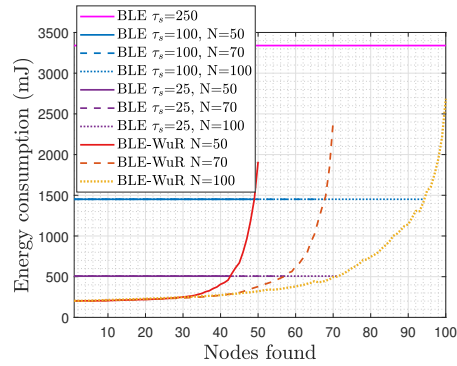

Fig. 6: Energy consumption as a function of number of nodes found w.r.t number of nodes in the network.

We observe that to discover the same maximum number of nodes per time slot, the advertiser could consume the same energy with BLE and WUBBLE. If, for example, N_s is fixed to 25 time slots with BLE, with a network of 50 nodes, the scanner could discover up to 42 nodes. However, 42 nodes are discovered in the average time slot of 20.99, so the advertising is stopped earlier with WUBBLE, which will compensate for the overhead of the continuous listening of the WuR inducing the same energy consumption with BLE and WUBBLE.

It can also be seen that with WUBBLE, the advertiser could consume more energy than when using BLE. However, in this case, fewer nodes are discovered

with BLE than with WUBBLE because N_s is underestimated, and the advertising process finishes earlier. For example, with a network of 50 nodes, if N_s is fixed to 25, WUBBLE could consume up to 45% more energy than BLE while 45 nodes are found against 42 with BLE.

It is shown that, if $N_s = 250$, all nodes are discovered in all the different network scenarios. The advertiser consumes more energy with BLE than with WUBBLE. With a network of 50 nodes, 45% of the energy is saved with WUBBLE to discover all nodes compared to BLE due to the stop mechanism.

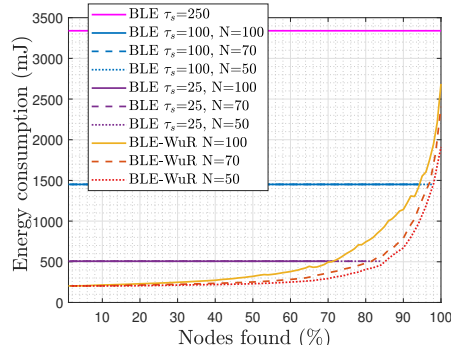

Fig. 7: Energy consumption as a function of the percentage of nodes found from the nodes available in the network.

Fig. 7 presents the average energy consumption as the percentage of nodes found in BLE and WUBBLE protocols. We observe that the energy can be saved compared to BLE to discover a portion number of nodes with WUBBLE. For example, to discover 50% of nodes, more than 40% of energy is saved with WUBBLE compared to BLE when N_s is fixed to 25-time slots. Moreover, we can also see that if N_s is fixed to 25-time slots, only 84% of nodes are discovered within a network of 50 nodes. If the required portion of nodes to be discovered is 90%, BLE could not discover all of them and consumes 30% less energy than WUBBLE, while with our proposal, all the required nodes are discovered. If N_s is fixed to 100-time slots, 54%, 46%, and 21% of energy is saved with WUBBLE to discover 90% of nodes when the number of nodes available is 50, 70, and 100, respectively.

In short, if N_s is underestimated in normal BLE, nodes stop advertising while the scanner has not yet discovered the required number of nodes. In this case, the advertiser consumes less energy than when using WUBBLE, while with WUBBLE, the number of nodes to be discovered is reached. Meanwhile, if N_s is overestimated, the advertiser consumes more energy than when using WUBBLE. Finally, if N_s is fixed and close to the optimum, the advertiser consumes about the same energy as BLE and WUBBLE. It is difficult to fix the optimal time slot to stop advertising with BLE since it could change depending on the network

size and channel conditions not considered in this work. Nevertheless, WUBBLE allows having a good stopping of advertising while being energy efficient.

5 Conclusions

Wireless nodes entering an unknown area must exchange information with present nodes to discover their new neighborhood. In BLE networks, this Neighbor Discovery Protocol (NDP) represents an energy-hungry mechanism, while for many discovering applications, only a specific part of the neighborhood is necessary. Adding a wake-up mechanism to BLE nodes can decrease the energy needed to discover a sufficient number of nodes. In this paper, we proposed WUBBLE, a new NDP for BLE nodes based on two WUBs, one to begin and another one to stop the discovery process. Thanks to experimental measurements and accurate energy models, it was proved that depending on the time horizon of the classical BLE advertising, WUBBLE can dramatically save energy. Even if the time horizon happens to be close to the optimum in the case of the classical NDP, our proposal remains energy efficient. In case of underestimated or overestimated time horizon for BLE, the gain in energy saving can add a unit after 10. The drawback of WuRs is their limited range so WUBBLE will be efficient only for dense environments. Emerging wake-up schemes try to increase this radio range using duty-cycle approaches. Future works on WUBBLE are to explore the capacity of our NDP to adapt to this intermittent approach.

Acknowledgment

This work is part of the project *GoodFlow* funded by the ADEME. The authors would like to thank the anonymous reviewers for their insightful comments.

References

1. Core specification 4.0 – bluetooth® technology website (2010), <https://www.bluetooth.com/specifications/specs/core-specification-4-0/>
2. Core specification 5.0 – bluetooth® technology website (2016), <https://www.bluetooth.com/specifications/specs/core-specification-5-0/>
3. Djidi, N.E.H., Gautier, M., Courtay, A., Berder, O., Magno, M.: How Can Wake-up Radio Reduce LoRa Downlink Latency for Energy Harvesting Sensor Nodes ? *Sensors* **21**(3), 733 (Jan 2021)
4. Djidi, N.E.H., Sampayo, S., Montavont, J., Courtay, A., Gautier, M., Berder, O., Noël, T.: The revenge of asynchronous protocols: Wake-up Radio-based Multi-hop Multi-channel MAC protocol for WSN. In: *IEEE Wireless Communications and Networking Conference (WCNC)*. Austin, United States (Apr 2022)
5. Ghamari, M., Villeneuve, E., Soltanpur, C., Khangosstar, J., Janko, B., Sherratt, R.S., Harwin, W.: Detailed Examination of a Packet Collision Model for Bluetooth Low Energy Advertising Mode. *IEEE Access* **6**, 46066–46073 (2018). <https://doi.org/10.1109/ACCESS.2018.2866323>

6. Giovanelli, D., Milosevic, B., Brunelli, D., Farella, E.: Enhancing Bluetooth Low Energy with wake-up radios for IoT applications. In: International Wireless Communications and Mobile Computing Conference (IWCMC). pp. 1622–1627 (jun 2017). <https://doi.org/10.1109/IWCMC.2017.7986527>
7. Jeon, W.S., Dwijaksara, M.H., Jeong, D.G.: Performance analysis of neighbor discovery process in bluetooth low-energy networks. *IEEE Transactions on Vehicular Technology* **66**, 1865–1871 (2017). <https://doi.org/10.1109/TVT.2016.2558194>
8. Kindt, P.H., Narayanaswamy, S., Saur, M., Chakraborty, S.: Optimizing ble-like neighbor discovery. *IEEE Transactions on Mobile Computing* **21**(5), 1779–1797 (2022). <https://doi.org/10.1109/TMC.2020.3028270>
9. Kindt, P.H., Saur, M., Balszun, M., Chakraborty, S.: Neighbor discovery latency in ble-like protocols. *IEEE Transactions on Mobile Computing* **17**(3), 617–631 (2018). <https://doi.org/10.1109/TMC.2017.2737008>
10. Liendo Sanchez, A.: Study of adaptation mechanisms of the wireless sensor nodes to the context for ultra-low power consumption. Theses, Université Grenoble Alpes (Oct 2018)
11. Luo, B., Xiang, F., Sun, Z., Yao, Y.: Ble neighbor discovery parameter configuration for iot applications. *IEEE Access* **7**, 54097–54105 (2019). <https://doi.org/10.1109/ACCESS.2019.2912493>
12. Luo, B., Yao, Y., Sun, Z.: Performance analysis models of ble neighbor discovery: A survey. *IEEE Internet of Things Journal* **8**, 8734–8746 (2021). <https://doi.org/10.1109/JIOT.2020.3046263>
13. Magno, M., Jelicic, V., Srbinovski, B., Bilas, V., Popovici, E., Benini, L.: Design, Implementation, and Performance Evaluation of a Flexible Low-Latency Nanowatt Wake-Up Radio Receiver. *IEEE Transactions on Industrial Informatics* **12**(2), 633–644 (2016). <https://doi.org/10.1109/TII.2016.2524982>
14. Mikhaylov, K., Karvonen, H.: Wake-up radio enabled BLE wearables: empirical and analytical evaluation of energy efficiency. In: International Symposium on Medical Information Communication Technology (ISMICT). pp. 1–5 (may 2020). <https://doi.org/10.1109/ISMICT48699.2020.9152699>
15. Shan, G., Choi, G., Roh, B.h., Kang, J.: An improved neighbor discovery process in ble 5.0. In: 2019 IEEE 10th Annual Information Technology, Electronics and Mobile Communication Conference (IEMCON). pp. 0809–0812. IEEE (2019). <https://doi.org/10.1109/IEMCON.2019.8936200>
16. Shan, G., hee Roh, B.: Maximized effective transmission rate model for advanced neighbor discovery process in bluetooth low energy 5.0. *IEEE Internet of Things Journal* **4662**, 1–13 (2022). <https://doi.org/10.1109/JIOT.2022.3152513>
17. Shan, G., Roh, B.H.: Advertisement interval to minimize discovery time of whole ble advertisers. *IEEE Access* **6**, 17817–17825 (2018). <https://doi.org/10.1109/ACCESS.2018.2817343>
18. Shan, G., Roh, B.H.: Performance model for advanced neighbor discovery process in bluetooth low energy 5.0-enabled internet of things networks. *IEEE Transactions on Industrial Electronics* **67**, 10965–10974 (2020). <https://doi.org/10.1109/TIE.2019.2962401>
19. Wei, L., Zhou, B., Ma, X., Chen, D., Zhang, J., Peng, J., Luo, Q., Sun, L., Li, D., Chen, L.: Lightning: A high-efficient neighbor discovery protocol for low duty cycle wsns. *IEEE Communications Letters* **20**, 966–969 (2016). <https://doi.org/10.1109/LCOMM.2016.2536018>